



2019 Iron Powder Products Catalog



About Micrometals

For over 65 years, Micrometals Inc. has been an engineering driven company striving to exceed customer requirements for magnetic components. Micrometals customized formulations of powdered metals, and their expertise at forming these materials into complex in shapes for power applications, is trusted by the most respected names in power electronics. Micrometals is a privately held corporation which is headquartered in Anaheim, California. In addition to the U.S. headquarters, Micrometals has global manufacturing sites in China and global distribution partners. Micrometals offers application engineering and technical support from North America and China, as well as stocking warehouses located in the U.S., Europe and Hong Kong.

Performance to the CORE!

Your power products deserve the performance you designed into them. For more than 65 years Micrometals has been trusted to deliver the most reliable core products in the world.

For many customers there is simply no equivalent.

Our experienced team can help you at any phase of your project

Product Design to Prototype to Production

Our on-line Inductor Design Software can quickly provide you with readily available options for your application and our Inductor Analyzer can take that design and allow you to modify design parameters to optimize the solution. Our industry leading design tools, technical support and manufacturing capabilities can help you quickly move from design to production, with a solution that can be trusted to deliver consistent performance for decades!

Catalog Samples to Custom Prototypes

Contact Micrometals today to discuss your application and we'd be glad to provide catalog core samples for you to quickly test in your application. If you need wound components we can connect you with one of our preferred winding suppliers to assure you get high quality components quickly.

Need something a little more custom? Micrometals has extensive customization capabilities and decades of experience to help you develop design options and to find the right solution for every phase of your project.

Custom core shapes and assemblies

Many engineers know of our extensive catalog offering a wide variety of available shapes and sizes but we also provide custom core shapes and assemblies for engineers around the world. Our custom capabilities are unmatched and can help you optimize your design and deliver a very unique solution for your application, which would exceed anything commercially available.

Custom materials formulations

Micrometals has extensive experience in developing unique materials formulations for demanding applications. Whether your objective is performance, cost, efficiency, weight, Micrometals can develop a solution to meet all of your project requirements.

Prototype samples and testing

Have a new shape, concept or idea for a new core? Contact Micrometals today to discuss how we can help turn your idea into a reality, and even get you prototypes quickly. Our engineers will help guide your design idea into a solution that is optimized, manufacturable and economical for your application. We can even provide electrical testing of designs to determine if the performance meets requirements or analyze where additional design optimization could yield a better solution.

Table of Contents

Iron Powder Core Solutions	2
Design Software	4
Material Groups	5
Power Conversion	5
Radio Frequency.....	8
High Temperature 200C.....	10
Micrometals Iron Powder Performance Data	12
Curve fit coefficients Table.....	40
Common Core Shapes.....	43
Toroid	43
E-core	57
Bus Bar	61
Balun	62
Plain Core	63
Micrometals Alloy Powder Core Solutions	66
Micrometals Quality Certifications	68



Micrometals Iron Powder Core Shapes Catalog and Custom

The parts presented in this catalog represent just a portion of the core shapes available from Micrometals. Our full catalog offering can be found on line at www.micrometals.com and includes the shapes below.

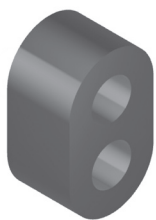

Balun Core

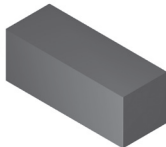

Block Core



Bus Bar

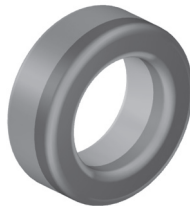

Composite

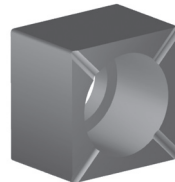

Cup Core

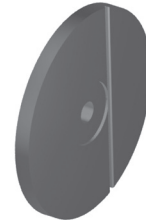

Disc Core-PC



Disc Core-RF



E Core



EH Core



U Core



EM Core



HC Core



HD Core

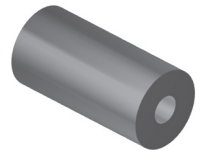

Hollow Core



IC Core



I Core



ID Core

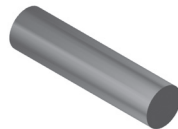

Plain Core

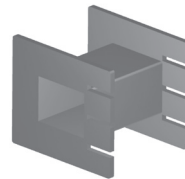

Plastic Bobbins

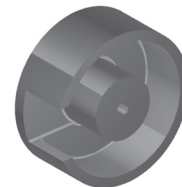

Pot Core

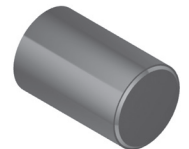

RC Core



Rectangular Toroid

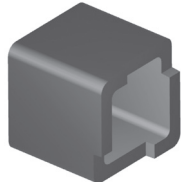

SC Core

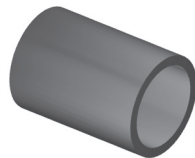

Sleeve Core

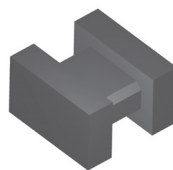

Square Bobbins



Threaded Core



Toroid

Our catalog offering is just the beginning, Micrometals has extensive experience and expertise at designing, prototyping and manufacturing and wide variety of custom shapes to optimize your design and help you create a competitive advantage in your products.

Custom capabilities and prototypes in as little as 2 weeks!

Our engineers can save you development time and money by helping you move quickly through feasibility, design and test phases and deliver prototypes quickly, which can then be moved into production. No other powder core supplier has the design, manufacturing and prototyping experience for custom cores – so start with Micrometals!

Machined catalog cores

- Reduce or remove dimensional features (grinding, turning, milling and polishing)
- Combine/stack/nest cores

Machine new core shapes from powder core blocks

- Catalog variants
- New shapes
- New Shape / Material combinations
- Machined cores and mounting plates

Wound components

We can work directly with your winding provider or connect you with one of our winding partners near you

Special coatings

- Harsh environment coatings
- Ruggedized designs
- Medical Grade coatings
- Tighter tolerance on coating thickness
- Special masking

Micrometals Powder Core Materials – No Equivalent

Micrometals expertise and experience in creating custom core shapes and material formulations is unmatched. We have helped thousands of engineers solve their most difficult power design challenges and delivered prototype and production units with uncompromising quality. With more than 65 years of experience we can quickly assess your design challenges and help optimize your design to meet budgetary and performance requirements.

Our catalog offering of powder core materials are the highest quality in the industry and many of our formulations are the “Gold Standard” and are specified explicitly on thousands of design drawings around the world. For customers who require reliable performance and quality they simply state on their designs – **“Micrometals Only – no equivalent”**.

Our decades of material formulation experience enables Micrometals to develop unique Iron and Alloy powders to address demanding applications where other materials fall short. We can develop new formulations to optimize magnetic attributes, compensate for electrical design issues such as noise or interference, or improve electrical efficiency.

Our experience in custom material formulations include solutions for some of the electrical challenges below.

- Minimize power supply acoustic or electrical noise
- Optimize efficiency for specific application conditions
- Lowest core loss
- High frequency
- High power
- Optimized cost/performance
- Custom permeability
- Custom formulation and sorting to deliver tighter tolerance magnetic properties

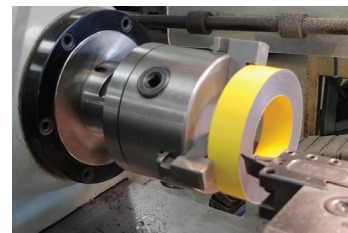
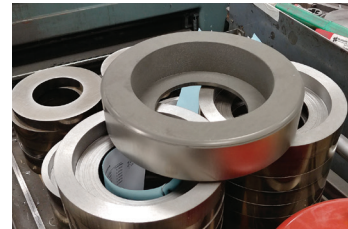

Inductor Design Software

Best in Class Design Software – Free on-Line

Micrometals offers several helpful and powerful digital design tools; Micrometals Inductor Design Software, Inductor Analyzer, and PowerEsim Magnetic Builder. Micrometals Inductor Design Software is a flexible user-friendly engineering tool that is intended to assist in the selection of powder cores. Our Inductor Analyzer allows engineers to quickly modify core winding and design parameters using our standard products to determine the optimal design for their system. PowerEsim is an on-line design resource for designing power supply circuits which includes a magnetic component design features.

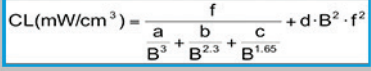

Downloadable Excel File with magnetic characteristic curve fit formulas and coefficients for Permeability vs. DC Magnetizing Force, Core Loss vs Bpk and Frequency, Permeability vs. Bpk, Permeability vs. Frequency and Initial BH Curves.

Curve Fit >>



Inductor Design >>



Power Esim >>

The Micrometals Inductor Design Calculator allows users to log in and select from two different inductor applications:

- Design of DC inductors used in DC/DC converters
- Design of a Power Factor Boost Inductor, commonly referred to as a PFC choke.

Using the DC and PFC topology choices, the software can be used for:

- Class D output inductor - using PFC
- Differential Mode Filter - using PFC or DC/DC
- Inverter Filter - using PFC
- Resonant Converters - using DC/DC

The calculator accepts the following user defined design requirements as inputs:

- Inductor Current
- Required Inductance at full Inductor Current
- Switching Frequency of the Converter
- Inductor Voltages during the “ON” and “OFF” times of the switch (for ripple current calculation of DC Inductors)
- RMS Input and DC Output Voltages (for ripple current calculation of PFC Boost Inductors)
- Core Geometry (Toroid or ECore)
- Core Stacking
- Preferred Toroid Winding technique (Fully Wound or Single Layer)
- Ambient Conditions

This program will automatically calculate and display:

- Part Number
- Approximate unit price
- Required Number of Turns
- Wire Size
- Winding Resistance, including Temperature and Skin Depth Effects
- Bpk - Peak AC Flux Density
- Inductance at Zero Current and Full Current
- Core Loss
- Copper Loss
- Temperature Rise
- Core Dimensions, both bare core and wound core

Materials Group

Power Conversion

General Material Properties

Material Mix No.	Reference Permeability	Typical AL Tolerance (%)	Powder Type	Temp Coef of Perm (+ppm/C°)	Density gm/cm ³	Max Frequency (MHz)	Relative Cost*	Color Code Toroid	Product Group		
									RF	PC	200C
-2	10	±5	Carbonyl Iron	95	5.0	45	2.2	Red/Clear	✓	✓	
-8	35	±10	Carbonyl Iron	255	6.5	5.0	3.1	Yellow/Red	✓	✓	
-14	14	±10	Carbonyl Iron	150	5.2	20	2.8	Black/Red		✓	
-18	55	±10	Iron	385	6.6	1.3	2.7	Green/Red		✓	
-19	55	±10	Iron	650	6.8	1.0	1.2	Red/Green		✓	
-26	75	±10	Iron	825	7.0	0.38	1.0	Yellow/White		✓	
-30	22	±10	Iron	510	6.0	1.8	1.1	Green/Gray		✓	
-34	33	±10	Iron	565	6.2	1.4	1.3	Gray/Blue		✓	
-35	33	±10	Iron	665	6.3	1.1	1.1	Yellow/Gray		✓	
-38	85	±10	Iron	956	7.1	0.27	1.1	Gray/Black		✓	
-40	60	±10	Iron	950	6.9	0.38	1.0	Green/Yellow		✓	
-45	100	±10	Iron	1043	7.2	0.34	2.6	Black/Black		✓	
-52	75	±10	Iron	650	7.0	0.59	1.1	Green/Blue		✓	

*Relative cost as compared to Micrometals -26 or -40 materials for a 25mm toroid.

Material Magnetic Characteristics

Material Mix No.	Bsat (G)	H(Oe) at 80% μ_i	% μ_i at H=50(Oe)	μ effective at H=50(Oe)	Core Loss (mW/cm ³)				
					60Hz/5000 G	10kHz/500 G	100kHz/140 G	1MHz/40 G	10MHz/15 G
-2	14,800	673	99	10	19	32	18	9	27
-8	17,600	101	92	32	45	59	32	22	123
-14	15,200	406	99	14	19	32	18	11	49
-18	17,800	45	77	42	48	70	46	70	715
-19	18,200	48	79	43	31	72	54	99	1138
-26	18,500	25	55	41	32	75	83	327	4294
-30	16,700	120	93	20	37	120	129	248	2537
-34	17,100	78	89	29	29	87	82	157	1756
-35	17,300	76	88	29	33	109	119	241	2531
-38	18,700	23	51	44	31	72	103	532	7216
-40	18,400	33	67	40	29	93	127	530	6999
-45	18,900	18	43	43	26	60	61	212	2716
-52	18,500	30	62	46	30	68	58	134	1571

Material Information

-2 & -14 Materials: The low permeability of these materials will result in lower operating AC flux density than other materials with no additional gap-loss. The -14 Material is similar to -2 Material with a higher permeability.

-8 Material: This material has low core loss and good linearity under high bias conditions. A good high frequency material, also the highest cost iron powder material.

-18 Material: This material has low core loss similar to the -8 Material with higher permeability and a lower cost. Good DC saturation characteristics.

-19 Material: An inexpensive alternate to the -18 Material with the same permeability and somewhat higher core losses.

-26 Material: A very popular material, it is a cost-effective general purpose material that is useful in a wide variety of power conversion and line filter applications.

-30 Material: The good linearity, low cost and relatively low permeability of this material make a popular choice for high power UPS applications.

-34, -35 Materials: An inexpensive alternate to the -8 Material where high frequency core loss is not critical. Both -34 & -35 Materials have good linearity with high bias.

-38 Material: Similar to the -26 Material with higher permeability.

-40 Material: The least expensive iron powder material, characteristics similar to the -26 Material with a lower permeability. Most popular is large sizes.

-45 Material: The highest permeability iron powder material available. Consider as a high perm alternate to the -52 Material with slightly higher core losses.

-52 Material: This material has lower core losses at high frequency and the same permeability as the -26 Material. It is popular for high frequency choke designs and available in a wide variety of geometries.

Initial Permeability (μ_i) vs. DC Magnetizing Force

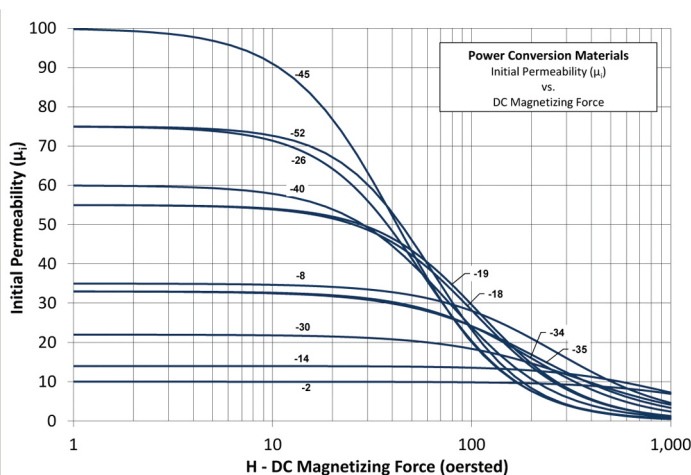

Percent Initial Permeability ($\% \mu_i$) vs. DC Magnetizing Force

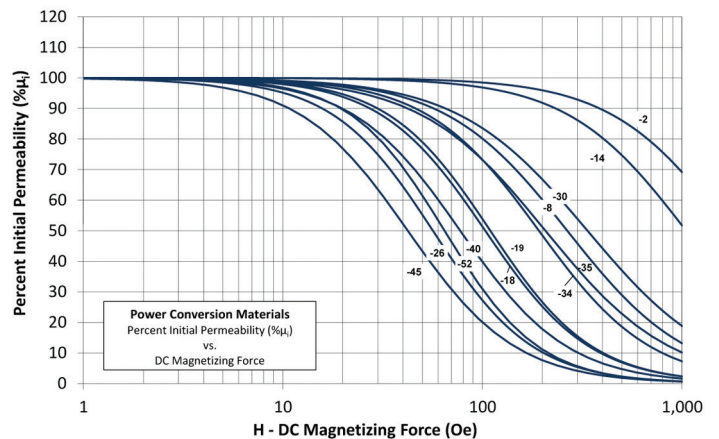

Percent Initial Permeability (% μ_i) vs. Peak AC Flux Frequency

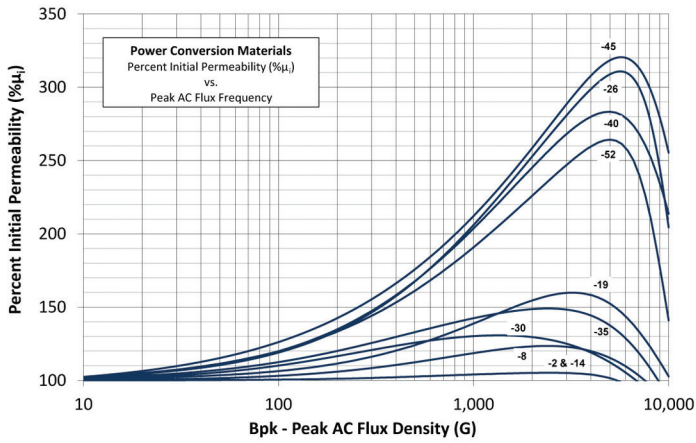

Initial Permeability (μ_i) vs Frequency (Hz)

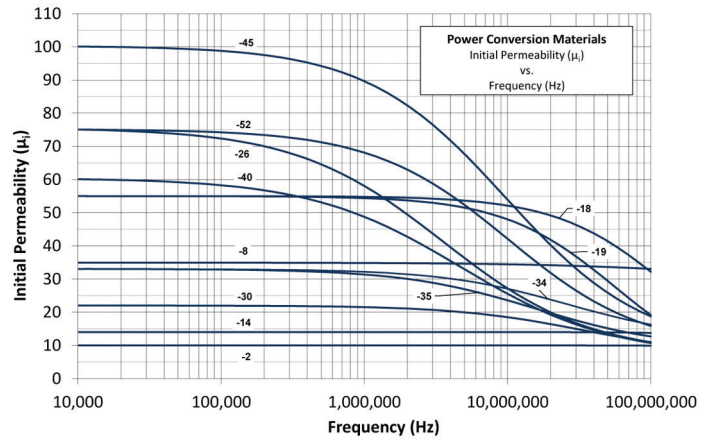

BH Curves

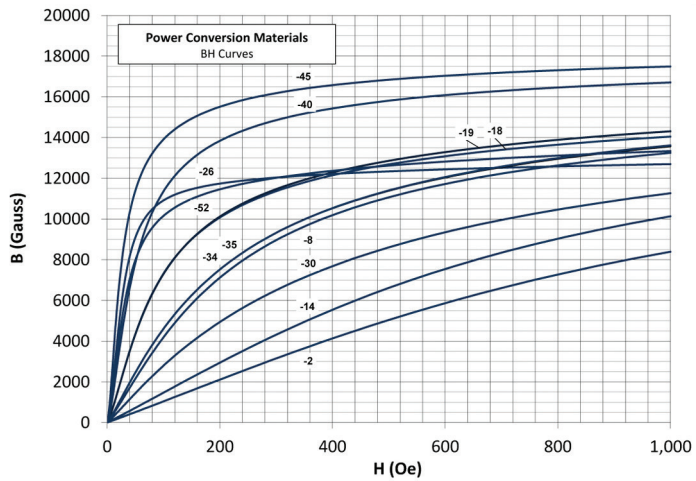

Material Frequency Range

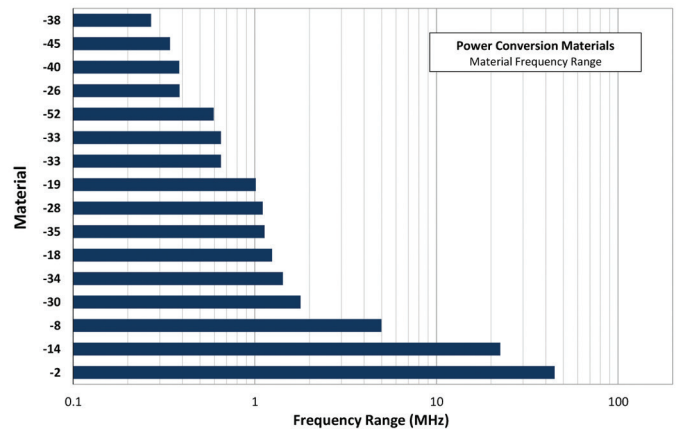

Radio Frequency

General Material Properties

Material Mix No.	Reference Permeability	Typical AL Tolerance (%)	Powder Type	Temp Coef of Perm (+ppm/C°)	Density gm/cm ³	Max Frequency (MHz)	Relative Cost*	Color Code Toroid	Product Group		
									RF	PC	200C
-0	1	N/A	Phenolic	N/A	N/A	N/A	1.3	Tan/Tan	✓		
-1	20	±10	Carbonyl Iron	280	6.4	10	3.8	Blue/Clear	✓		
-2	10	±5	Carbonyl Iron	95	5.0	45	2.2	Red/Clear	✓	✓	
-3	35	±10	Carbonyl Iron	255	6.5	5.0	3.3	Gray/Clear	✓		
-4	9	±5	Carbonyl Iron	280	5.0	17	2.2	Blue/White	✓		
-6	8.5	±5	Carbonyl Iron	35	5.0	55	3.6	Yellow/Clear	✓		
-7	9	±5	Carbonyl Iron	30	5.0	50	3.0	White/Clear	✓		
-8	35	±10	Carbonyl Iron	255	6.5	5.0	3.1	Yellow/Red	✓	✓	
-10	6	±5	Carbonyl Iron	150	4.9	83	5.5	Black/Clear	✓		
-15	25	±10	Carbonyl Iron	190	6.4	7.0	3.4	Red/White	✓		
-17	4	±5	Carbonyl Iron	50	4.8	170	3.5	Blue/Yellow	✓		

*Relative cost as compared to Micrometals -26 or -40 materials for a 25mm toroid.

Material Information

-2, -4, -6 & -7 Materials: These are the most popular carbonyl iron mixes. They will provide High Q up to 40 MHz and the most popular for amateur radio and variety of other communication applications. They are also useful for moderate band transformers in the 200 to 400 MHz frequency range

-1, -3, -8 & -15 Materials: These materials are annealed carbonyl irons providing the highest carbonyl permeability. They are useful for high Q applications below 1 MHz and will provide the broadest band transformers covering a typical range from 50 to 500 MHz.

-10 & -17 Materials: These materials are the highest frequency carbonyl irons. They will provide high Q up to 150 MHz and are a popular material for cable television applications. They will produce moderate band transformers covering 400 to 700 MHz.

-0 Material: This is a non-magnetic material. It provides a solid winding form for winding air coils. It has excellent temperature stability and will provide high Q up to the highest frequencies. It is also useful for moderate band transformer applications covering a typical range from 600 MHz to 1 GHz.

Initial Permeability (μ) vs. DC Magnetizing Force

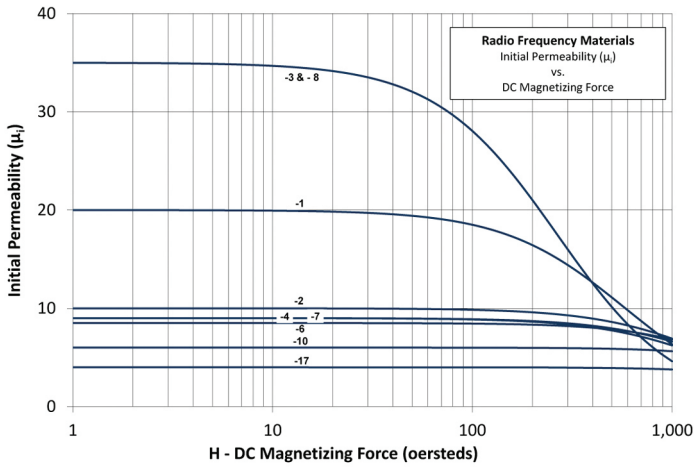

Percent Initial Permeability ($\% \mu$) vs. DC Magnetizing Force

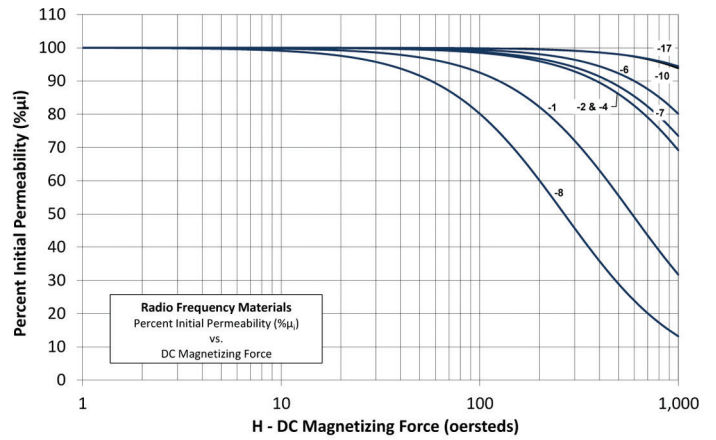

Percent Initial Permeability ($\% \mu$) vs. Peak AC Flux Density

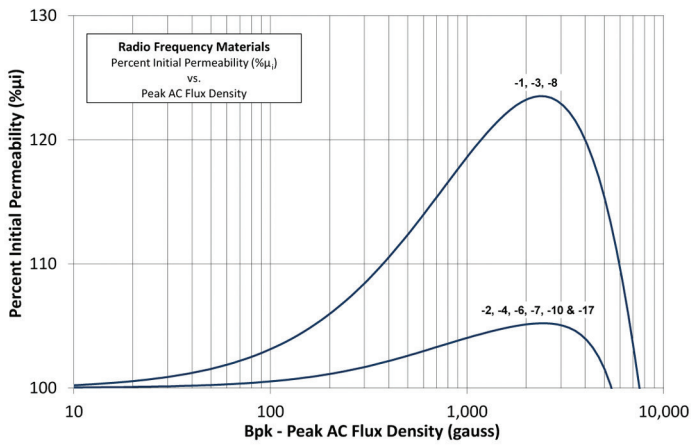

Initial Permeability (μ) vs. Frequency (Hz)

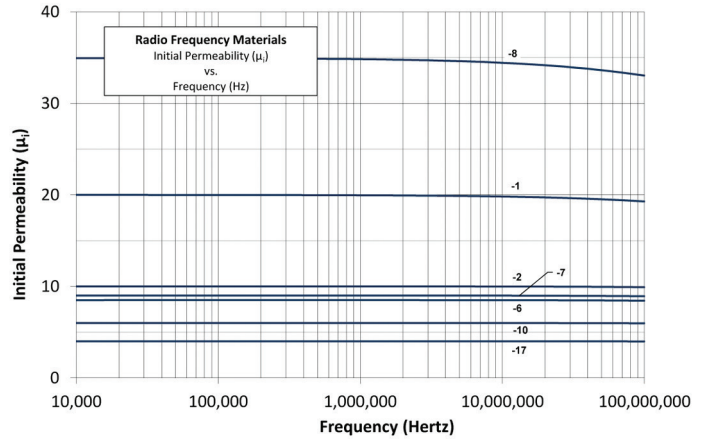

BH Curves

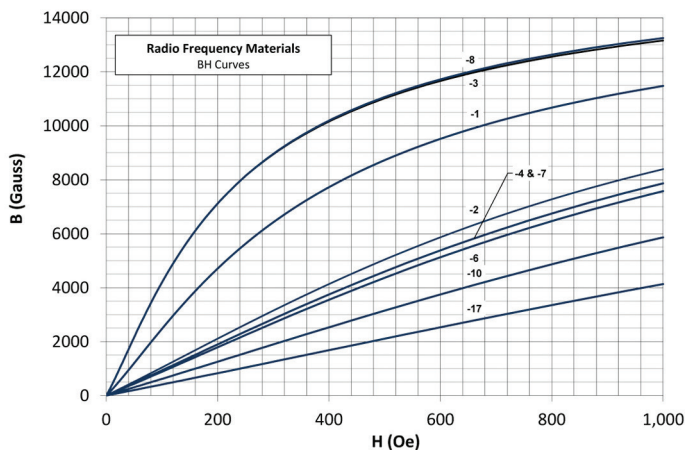

Material Frequency Range

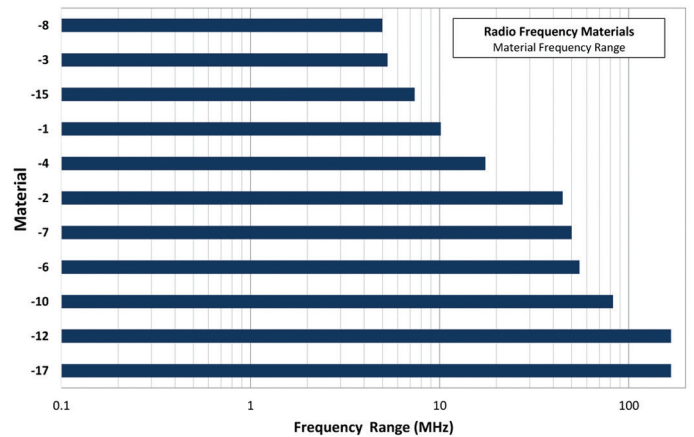

High Temperature

General Material Properties

Material Mix No.	Reference Permeability	Typical AL Tolerance (%)	Powder Type	Temp Coef of Perm (+ppm/C°)	Density gm/cm ³	Max Frequency (MHz)	Relative Cost*	Color Code Toroid	Product Group		
									RF	PC	200C
-60	55	±10	Silicon-Iron	168	6.1	1.3	2.0	Brown/Black			✓
-61	38	±10	Silicon-Iron	-418	6.1	2.0	2.0	Brown/Gray			✓
-63	35	±10	Silicon-Iron	-313	5.9	5.8	3.0	Brown/Beige			✓
-65	42	±10	Silicon-Iron	-80	6.1	2.0	2.0	Brown/Yellow			✓
-66	66	±10	Silicon-Iron	-220	6.2	1.5	2.5	Brown/Brown			✓
-70	100	±10	Nickel-Iron	216	7.4	0.66	9.9	Beige/Black			✓
-M125	125	±10	Molyper-malloy	150	7.7	0.48	12	Lt.Blue/Lt.Blue			✓

*Relative cost as compared to Micrometals -26 or -40 materials for a 25mm toroid.

Material Magnetic Characteristics

Material Mix No.	Bsat (G)	H(Oe) at 80% μ i	% μ i at H=50(Oe)	μ effective at H=50(Oe)	Core Loss (mW/cm ³)				
					60Hz/5000 G	10kHz/500 G	100kHz/140 G	1MHz/40 G	10MHz/15 G
-60	14,400	35	71	39	43	76	52	68	630
-61	14,400	65	85	32	80	113	69	72	569
-63	14,100	69	86	30	74	60	31	20	88
-65	16,000	55	82	35	54	77	33	48	567
-66	16,200	36	71	47	48	48	17	31	392
-70	8,600	20	47	47	6	10	13	69	947
-M125	8,800	24	44	55	5	6	13	86	1193

Material Information

-60 Material: The 60 Series of materials are cost effective magnetic powder alloy materials that are not subject to thermal aging for operating temperatures up to 200°C. The -60 Material has 55 permeability and can be considered as a substitute for -18 Material.

-61 Material, -63 Materials: Both materials have initial permeability of 35. The -63 Material has excellent high frequency properties and be and can operate past 10MHz. -63 Material can be considered for high temperature alternate to -8 Material. Both materials are not subject to thermal aging concerns.

-65 Material: This material has a permeability of 42 and is most popular in Microcube geometries. The -65 has higher core losses at high frequencies compared to -66 Material but better DC saturation. No thermal aging concerns.

-66 Material: This material offers low core losses and is well suited from 100kHz to 500kHz. No thermal aging concerns.

-70 Material: This is a magnetic powder alloy including nickel. The -70 Material has higher permeability than the 60 Series with excellent losses up to 400kHz. This is a relatively expensive material, most competitively priced in smaller sizes. No thermal aging concerns.

-M125 Material: This is a molypermalloy powder material and will have the highest permeability and lowest losses below 200kHz. Similar to the -70 Material is cost, the -M125 Material will be most competitively priced in smaller sizes.

Initial Permeability (μ_i) vs. DC Magnetizing Force

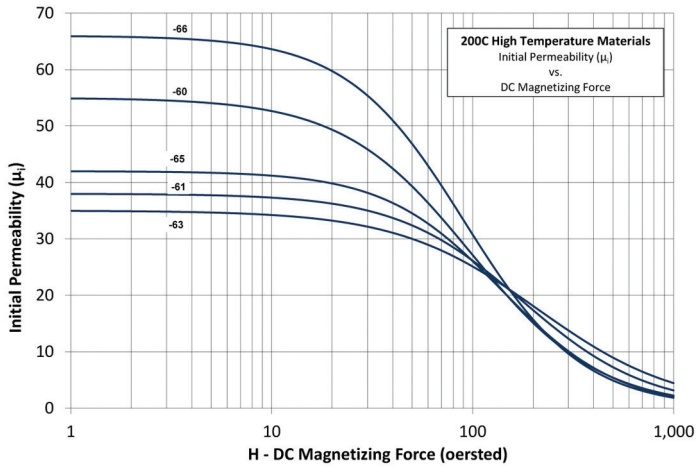

Percent Initial Permeability ($\% \mu_i$) vs. DC Magnetizing Force

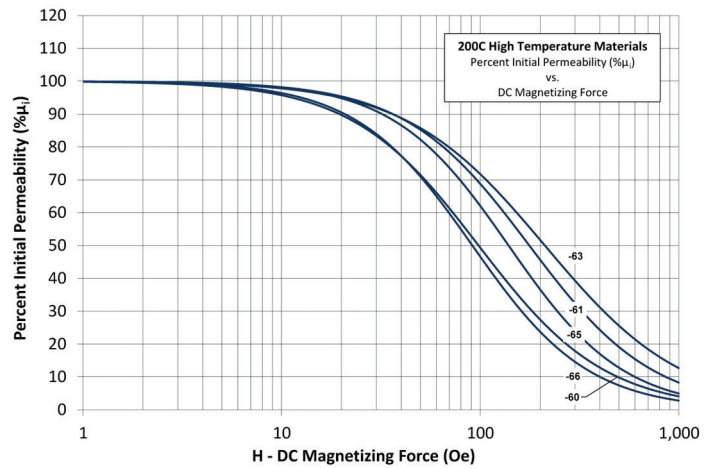

Percent Initial Permeability ($\% \mu_i$) vs. Peak AC Flux Density

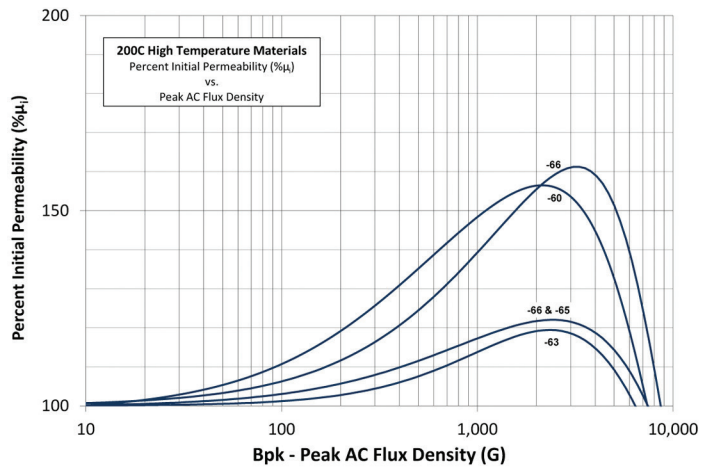

Initial Permeability (μ_i) vs. Frequency (Hz)

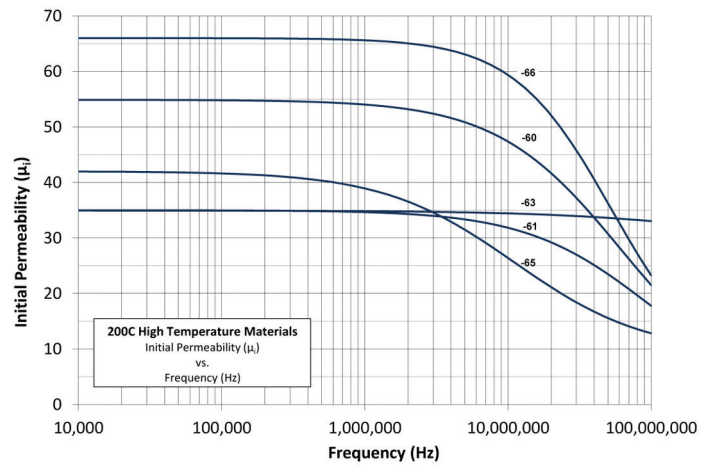

BH Curves

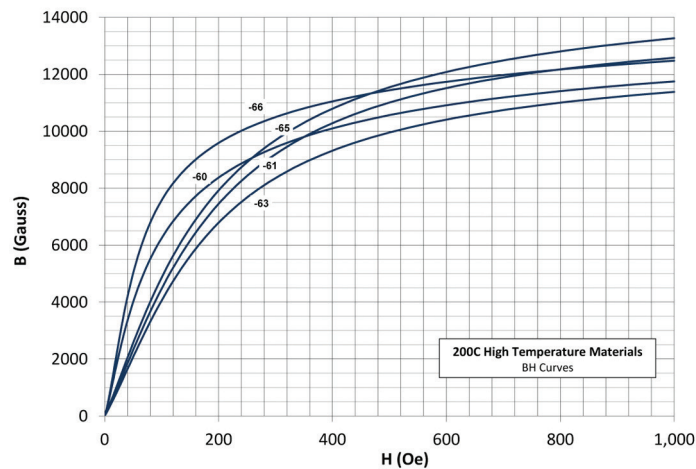

Material Frequency Range

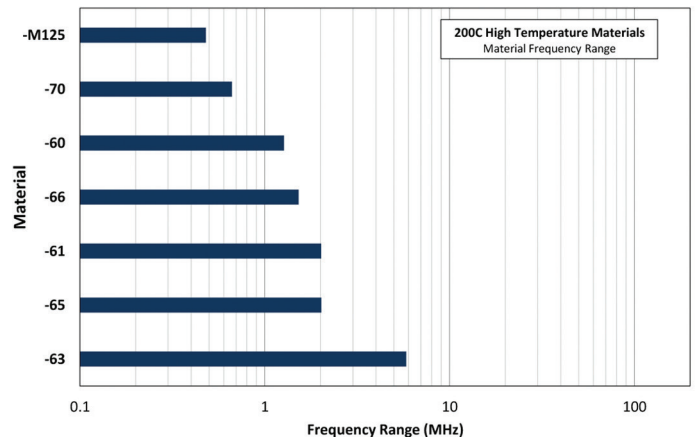

Materials Performance Data

-1 material is an annealed carbonyl iron providing the highest carbonyl permeability. -1 is useful for high Q applications below 1 MHz and will provide the broadest band transformers covering a typical range from 50 to 500 MHz.

Mix:	-1
Revision 20160429 - Generated 2016-May-02	
μ (reference)	20
Color Code	Blue/Clear
Density	6.4 g/cm ³
Bsat	17.5kG
Core Loss (100kHz, 140g)	31 mW/cm ³ (nom)
	36 mW/cm ³ (max)
%Perm at DC Bias (200 Oe)	82.2% (nom)
	78.0% (min)

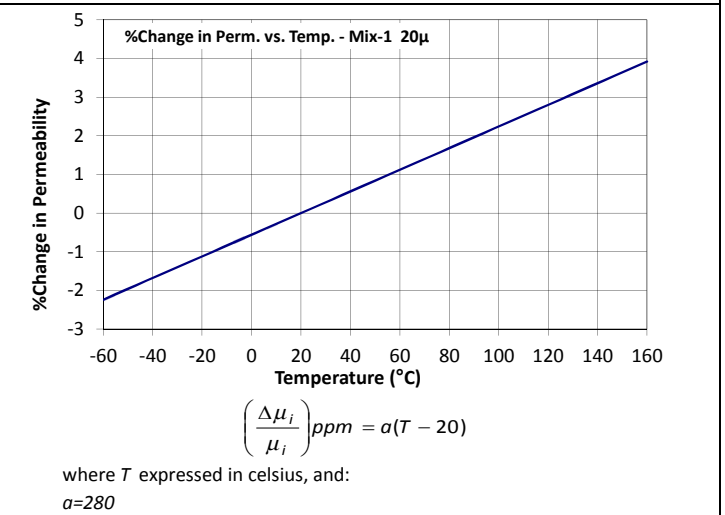
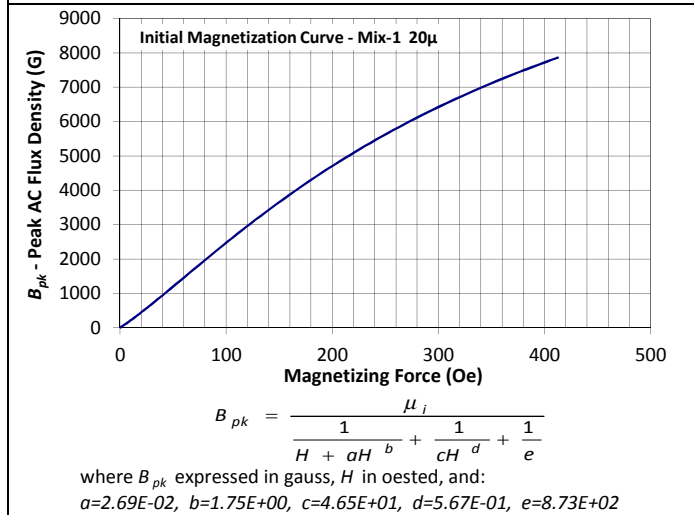
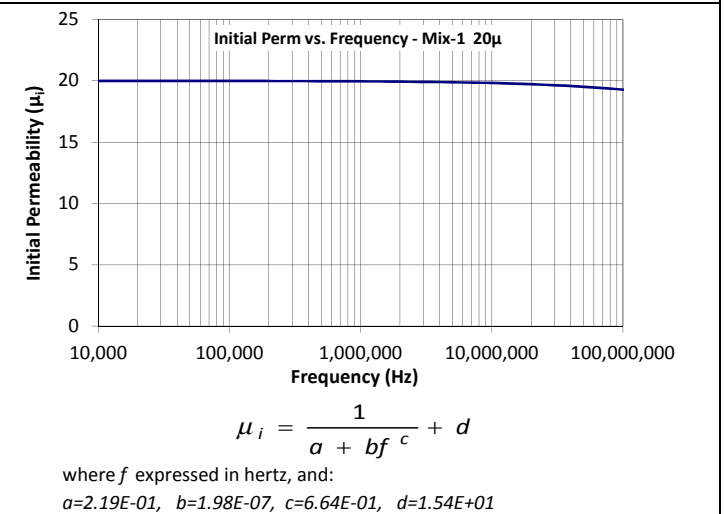
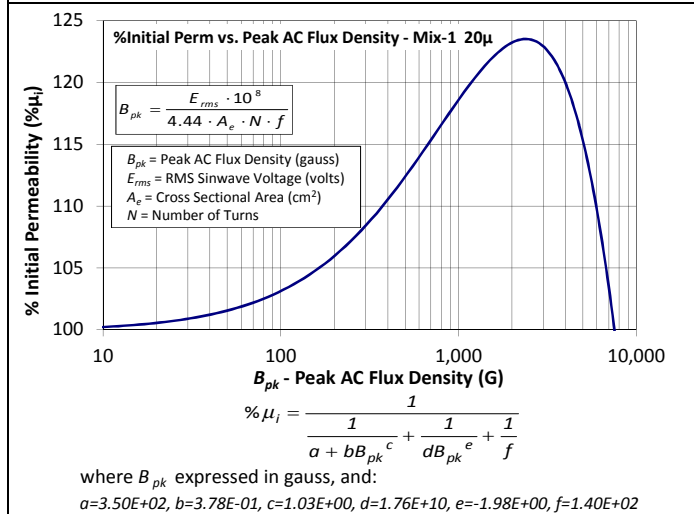
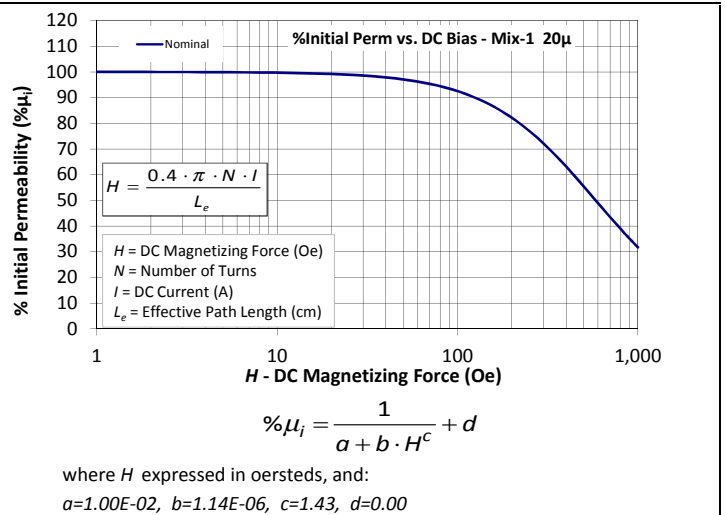
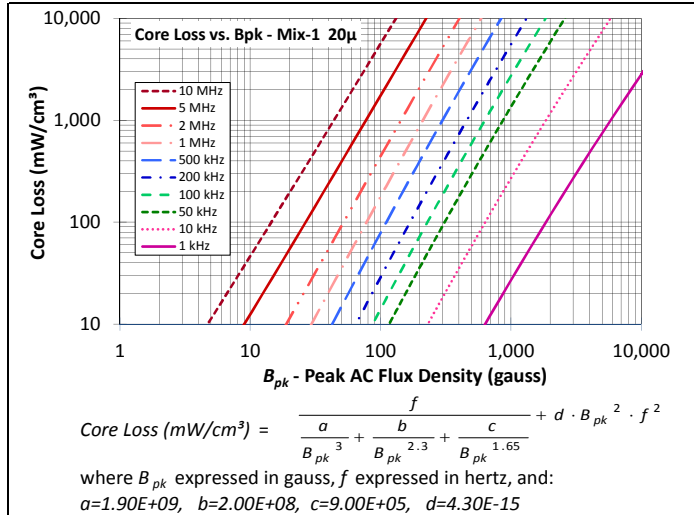

-2 material is a popular carbonyl iron mix that provides High Q up to 40 MHz and is very popular for amateur radio and a variety of other communication applications. -2 is also useful for moderate band transformers in the 200 to 400 MHz frequency range. The low permeability of -2 material will result in lower operating AC flux density than other materials with no additional gap-loss. For a slightly higher permeability consider -14 material.

Mix:	-2
Revision 20160422 - Generated 2016-Apr-26	
μ (reference)	10
Color Code	Red/Clear
Density	5.0 g/cm ³
Bsat	14.8kG
Core Loss (100kHz, 140g)	18 mW/cm ³ (nom)
	20 mW/cm ³ (max)
%Perm at DC Bias (200 Oe)	95.9% (nom)
	94.8% (min)

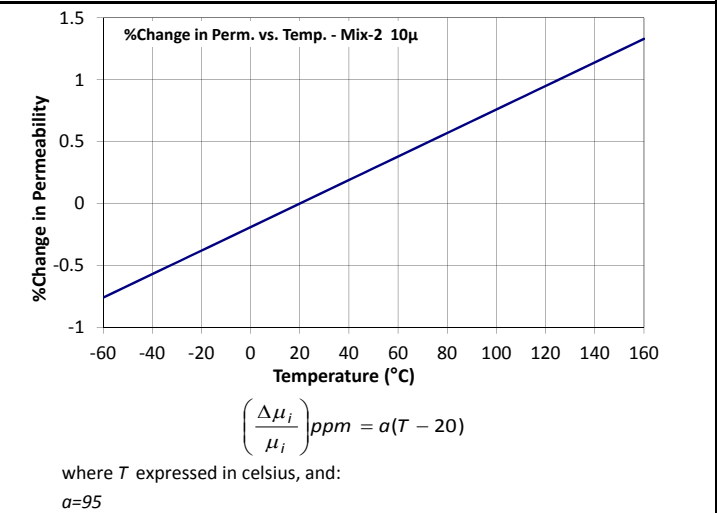
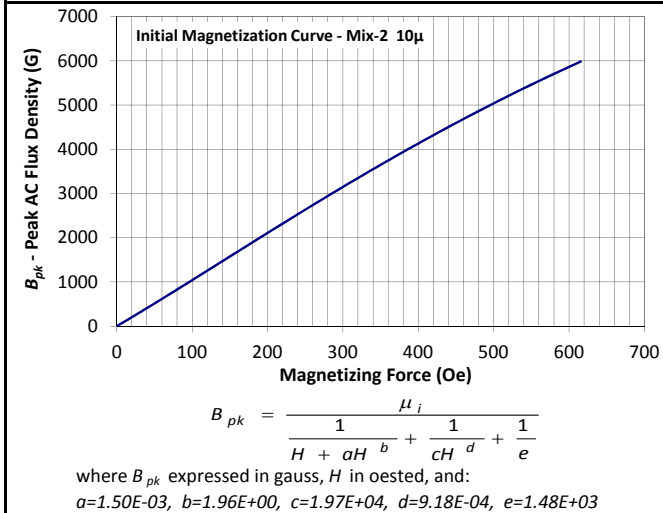
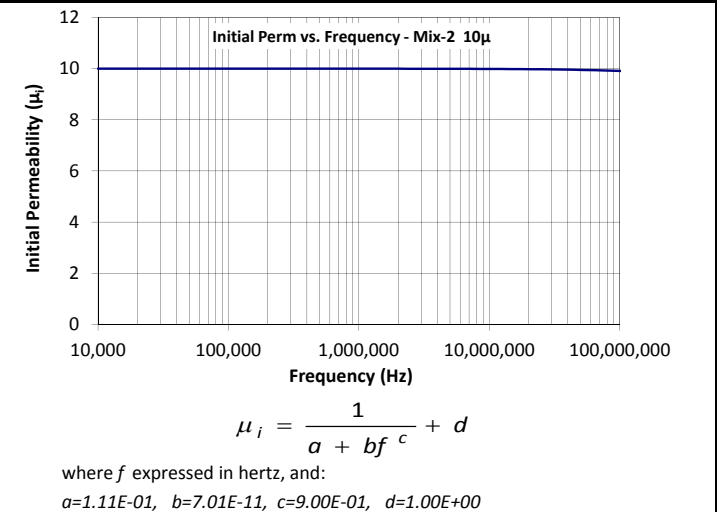
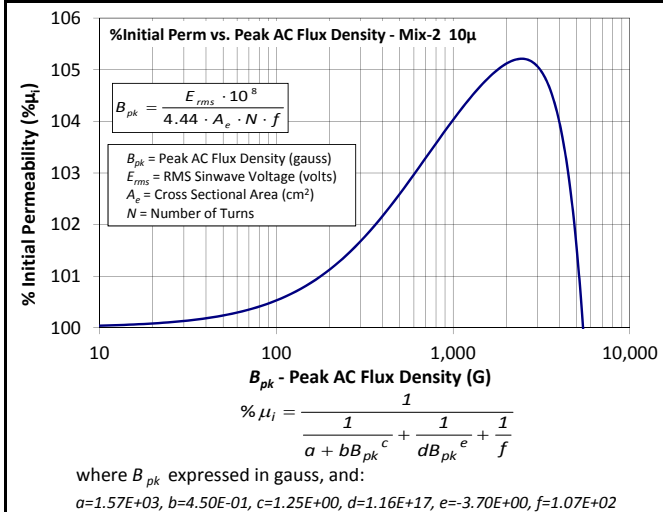
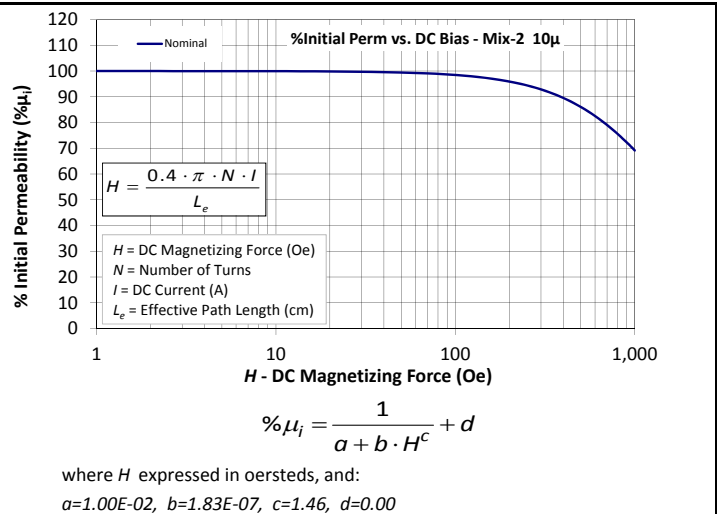
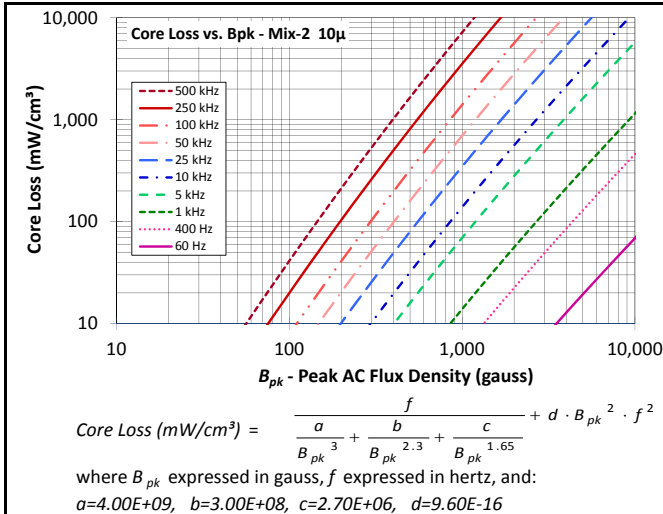

-3 material is an annealed carbonyl iron providing the highest carbonyl permeability. -3 is useful for high Q applications below 1 MHz and will provide the broadest band transformers covering a typical range from 50 to 500 MHz.

Mix:	-3
-------------	-----------

Revision 20170809 - Generated 2017-Aug-18

μ_i (reference)	35
Color Code	Gray/Clear
Density	6.5 g/cm ³
Bsat	17.6kG
Core Loss (100kHz, 140g)	31 mW/cm ³ (nom) 36 mW/cm ³ (max)
%Perm at DC Bias (200 Oe)	60.1% (nom) 53.7% (min)

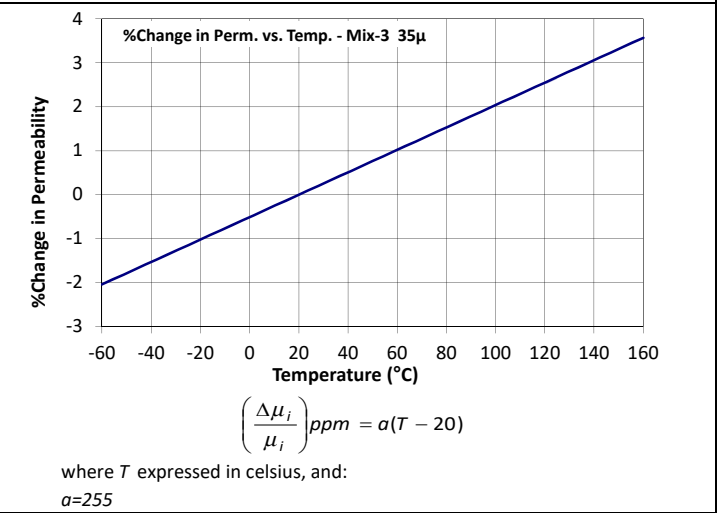
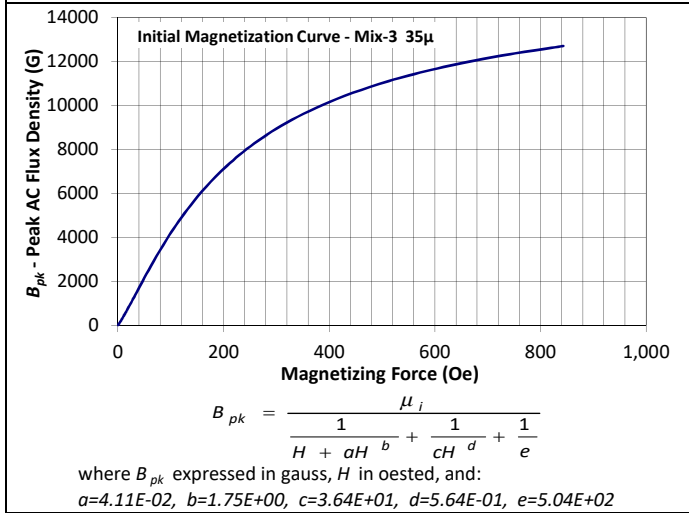
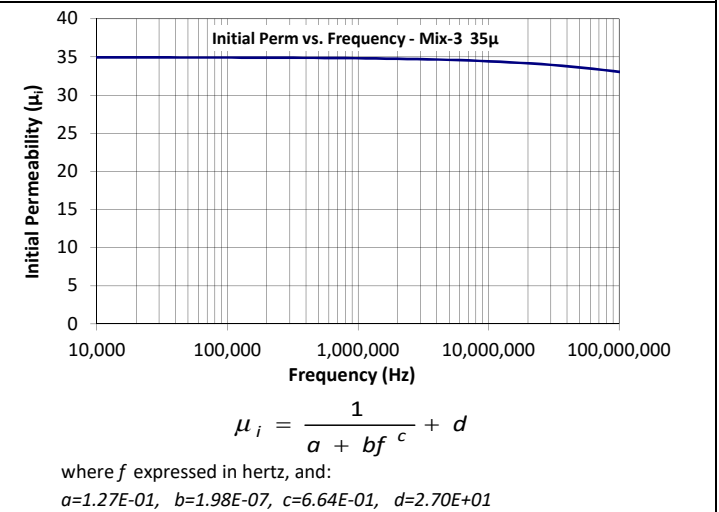
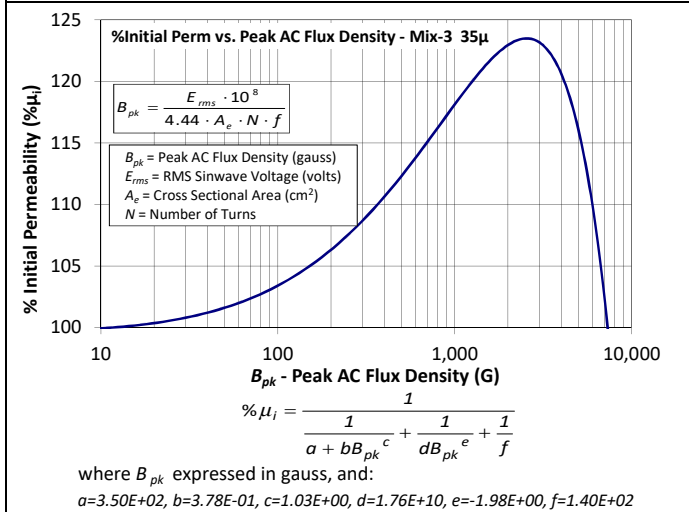
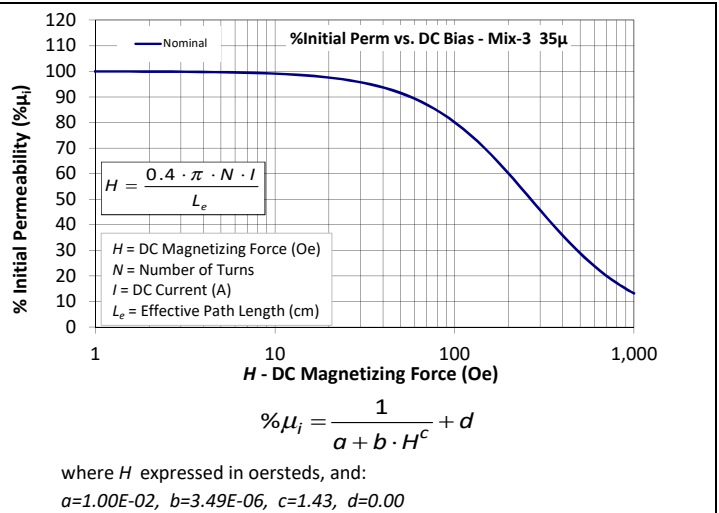
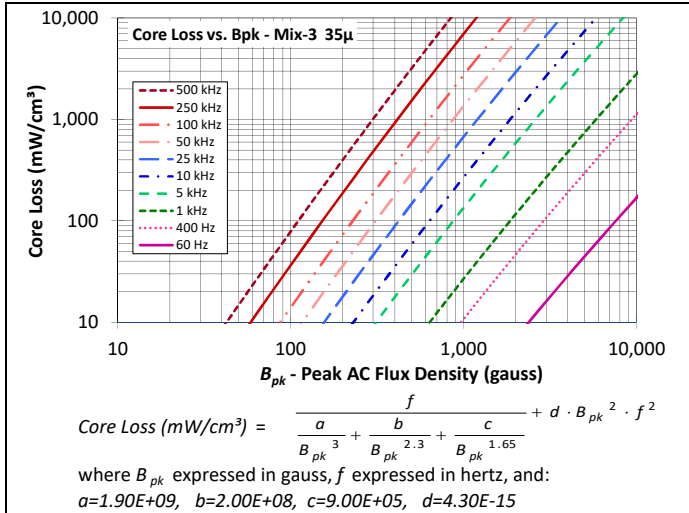

-4 material is a popular carbonyl iron mix that provides High Q up to 40 MHz and is very popular for amateur radio and a variety of other communication applications. -4 is also useful for moderate band transformers in the 200 to 400 MHz frequency range.

Mix:	-4
-------------	-----------

Revision 20171027 - Generated 2017-Nov-08

μ_i (reference)	9
Color Code	Blue/White
Density	5.0 g/cm ³
Bsat	14.8kG
Core Loss (100kHz, 140g)	19 mW/cm ³ (nom)
	22 mW/cm ³ (max)
%Perm at DC Bias (200 Oe)	95.9% (nom)
	94.8% (min)

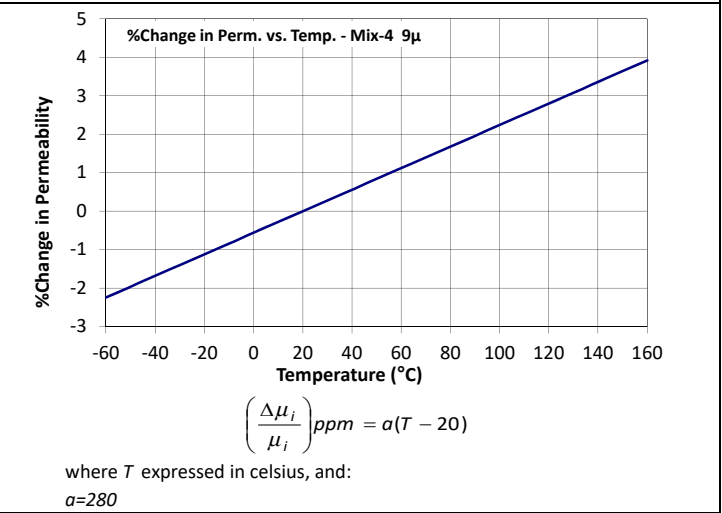
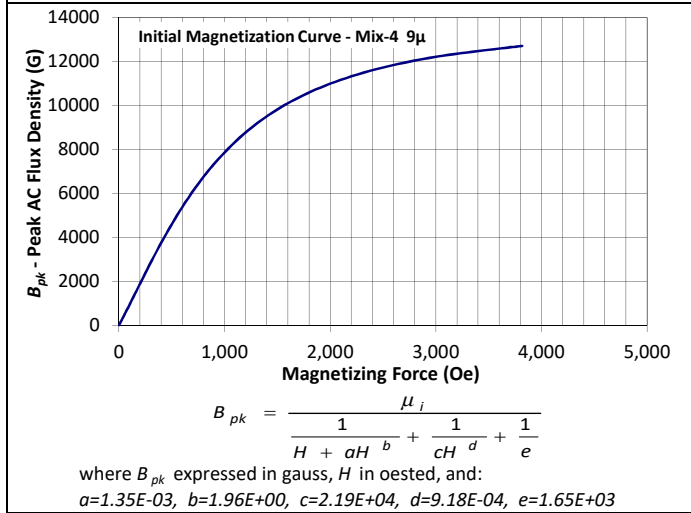
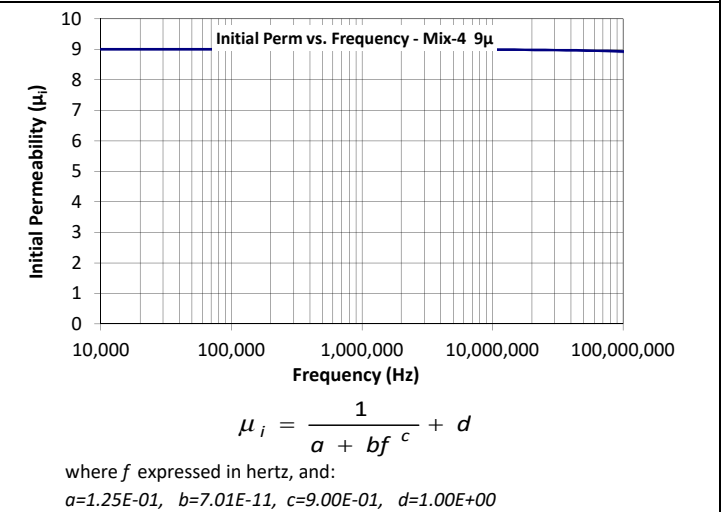
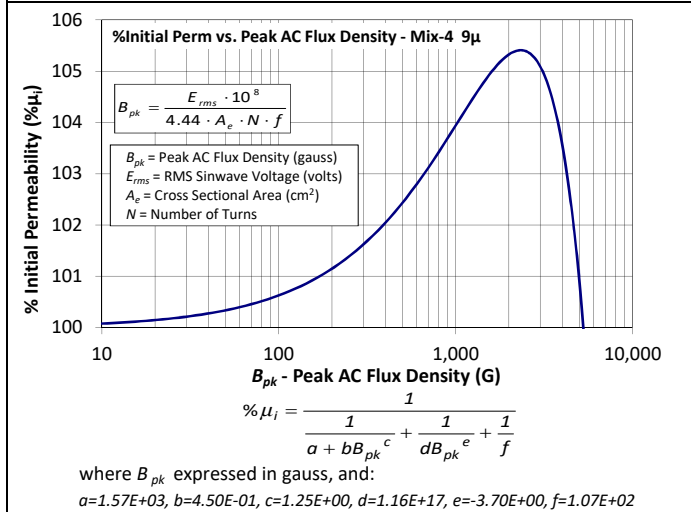
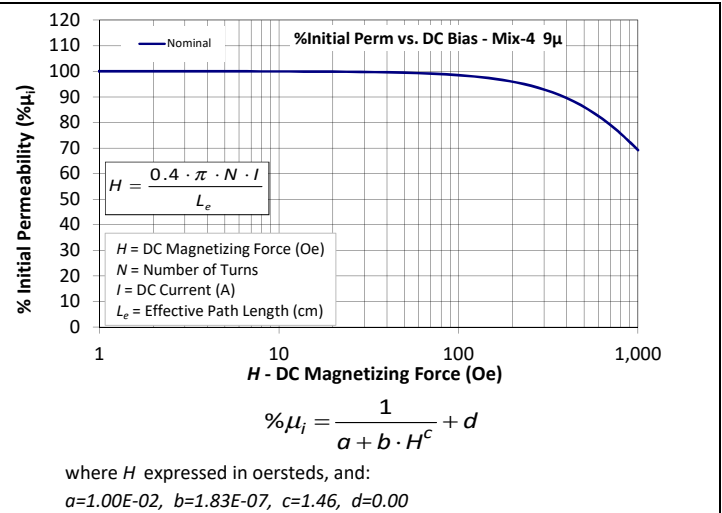
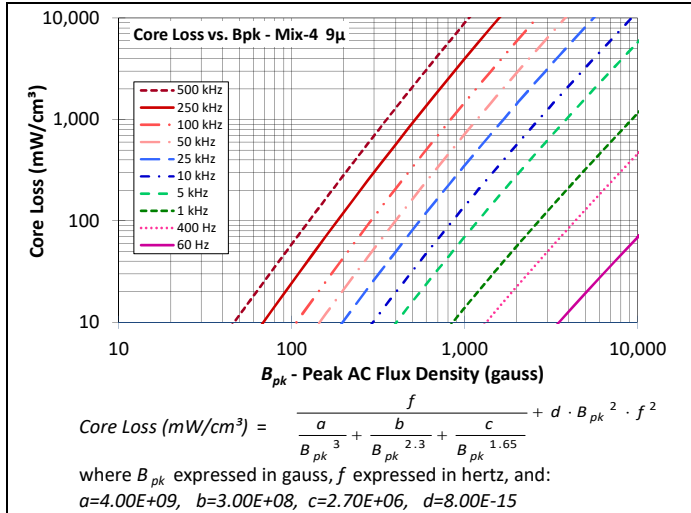

-6 material is a popular carbonyl iron mix that provides High Q up to 40 MHz and is very popular for amateur radio and a variety of other communication applications. -6 is also useful for moderate band transformers in the 200 to 400 MHz frequency range.

Mix:	-6
-------------	-----------

Revision 20160216 - Generated 2016-Feb-25

μ (reference)	8.5
Color Code	Yellow/Clear
Density	5.0 g/cm ³
Bsat	14.8kG
Core Loss (100kHz, 140g)	18 mW/cm ³ (nom) 20 mW/cm ³ (max)
%Perm at DC Bias (200 Oe)	98.1% (nom) 97.4% (min)

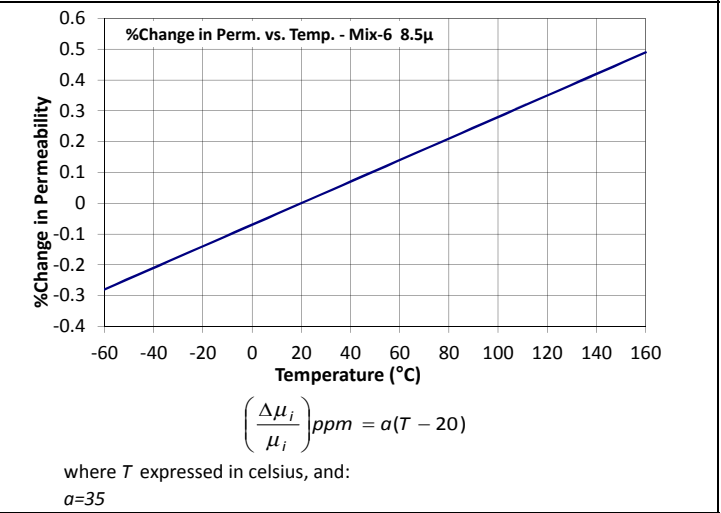
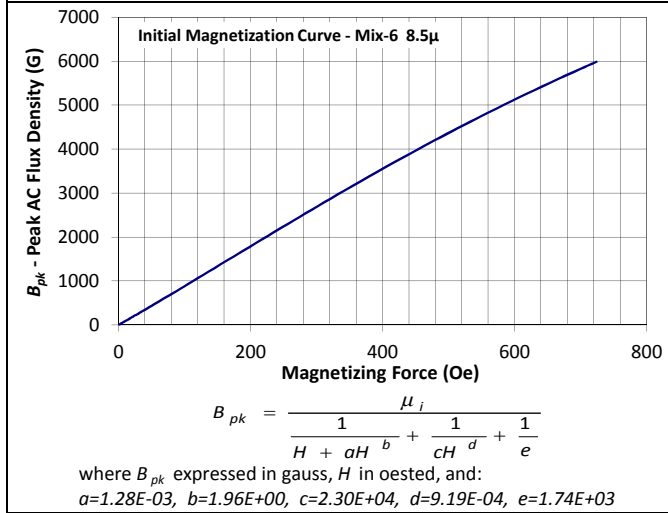
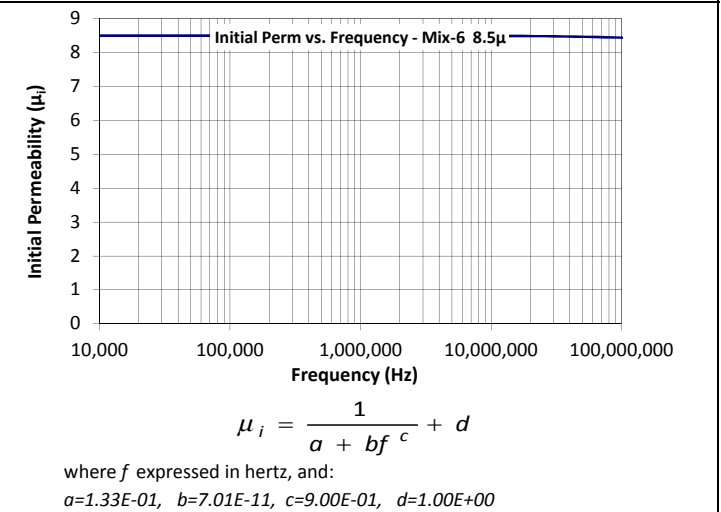
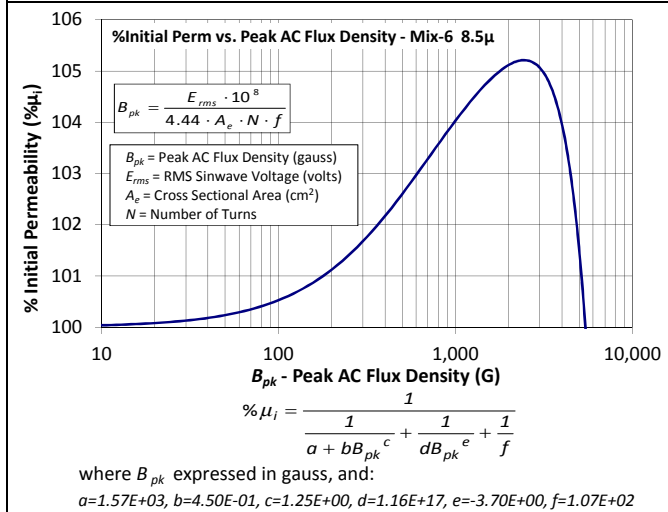
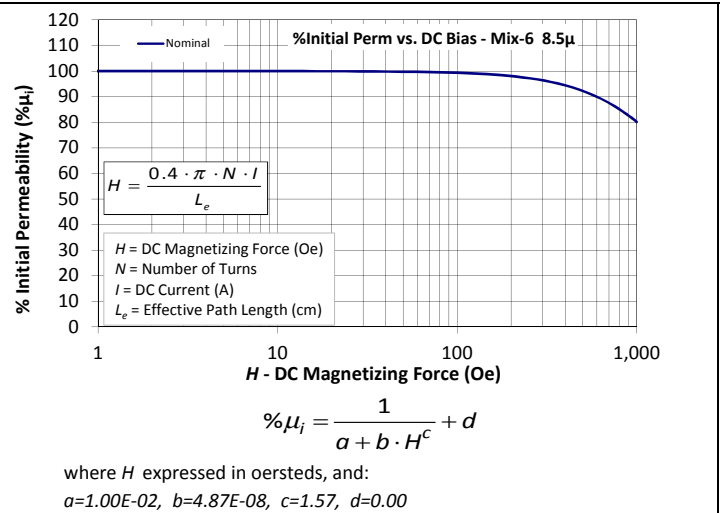
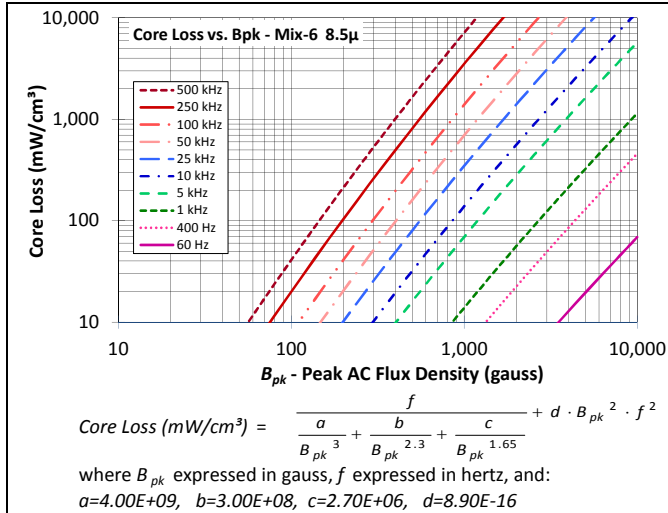

-7 material is a popular carbonyl iron mix that provides High Q up to 40 MHz and is very popular for amateur radio and a variety of other communication applications. -7 is also useful for moderate band transformers in the 200 to 400 MHz frequency range.

Mix:	-7
-------------	-----------

Revision 20160906 - Generated 2016-Sep-13

μ (reference)	9
Color Code	White/Clear
Density	5.0 g/cm ³
Bsat	14.8kG
Core Loss (100kHz, 140g)	18 mW/cm ³ (nom) 20 mW/cm ³ (max)
%Perm at DC Bias (200 Oe)	96.7% (nom) 95.7% (min)

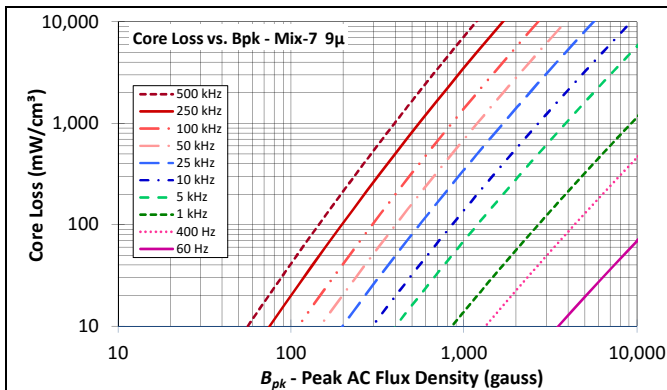

$$\text{Core Loss (mW/cm}^3\text{)} = \frac{a}{B_{pk}^3} + \frac{b}{B_{pk}^{2.3}} + \frac{c}{B_{pk}^{1.65}} + d \cdot B_{pk}^2 \cdot f^2$$

where B_{pk} expressed in gauss, f expressed in hertz, and:
 $a=4.00E+09$, $b=3.00E+08$, $c=2.70E+06$, $d=9.60E-16$

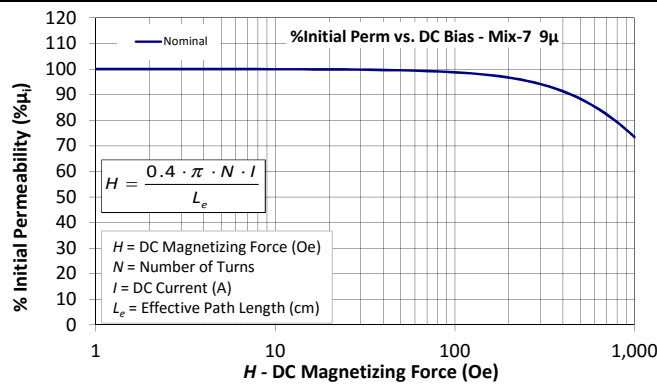

$$\% \mu_i = \frac{1}{a + b \cdot H^c} + d$$

where H expressed in oersteds, and:
 $a=1.00E-02$, $b=1.48E-07$, $c=1.46$, $d=0.00$

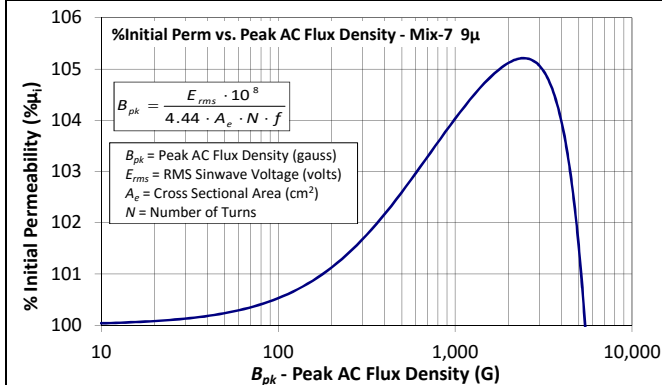

$$\% \mu_i = \frac{1}{a + bB_{pk}^c + \frac{1}{dB_{pk}^e} + \frac{1}{f}}$$

where B_{pk} expressed in gauss, and:
 $a=1.57E+03$, $b=4.50E-01$, $c=1.25E+00$, $d=1.16E+17$, $e=-3.70E+00$, $f=1.07E+02$

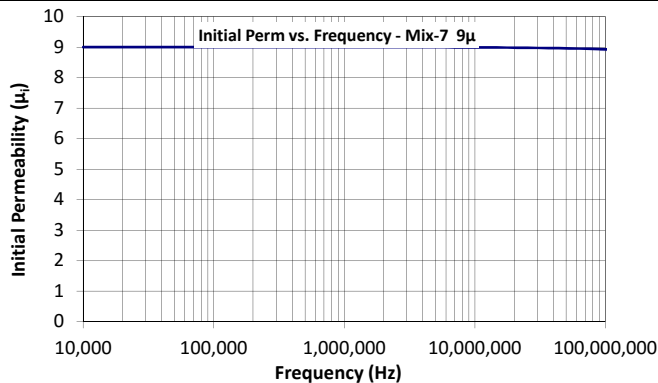

where f expressed in hertz, and:
 $a=1.25E-01$, $b=7.01E-11$, $c=9.00E-01$, $d=1.00E+00$

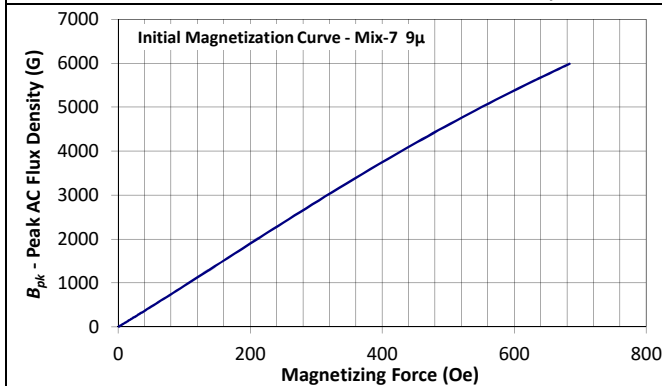

$$B_{pk} = \frac{\mu_i}{\frac{1}{H + aH^b} + \frac{1}{cH^d} + \frac{1}{e}}$$

where B_{pk} expressed in gauss, H in oested, and:
 $a=1.35E-03$, $b=1.96E+00$, $c=2.19E+04$, $d=9.18E-04$, $e=1.65E+03$

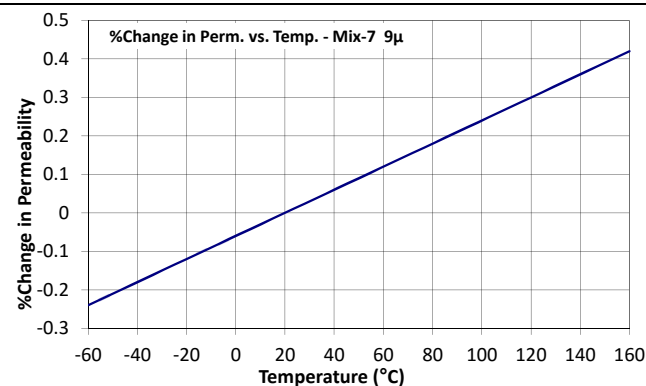

where T expressed in celsius, and:
 $a=30$

-8 material is an annealed carbonyl iron providing the highest carbonyl permeability. -8 is useful for high Q applications below 1 MHz and will provide the broadest band transformers covering a typical range from 50 to 500 MHz. This material has low core loss and good linearity under high bias conditions. A good high frequency material but also the highest cost iron powder material.

Mix:

-8

Revision 20160429 - Generated 2016-May-24

μ_i (reference)	35
Color Code	Yellow/Red
Density	6.5 g/cm ³
Bsat	17.6kG
Core Loss (100kHz, 140g)	32 mW/cm ³ (nom) 36 mW/cm ³ (max)
%Perm at DC Bias (200 Oe)	60.1% (nom) 53.7% (min)

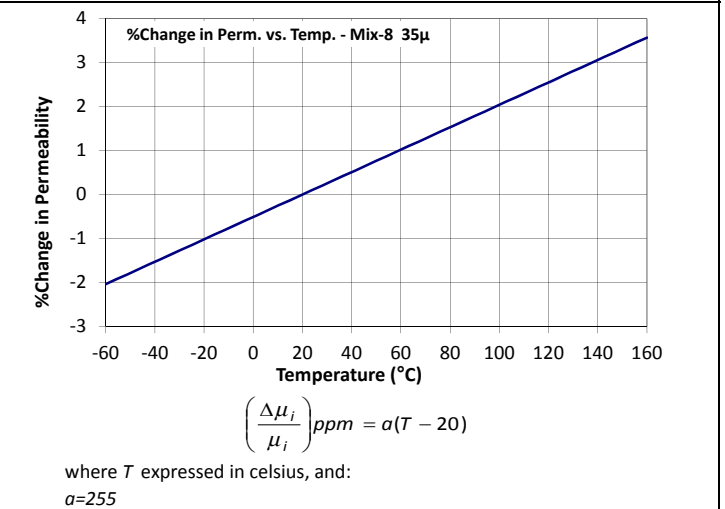
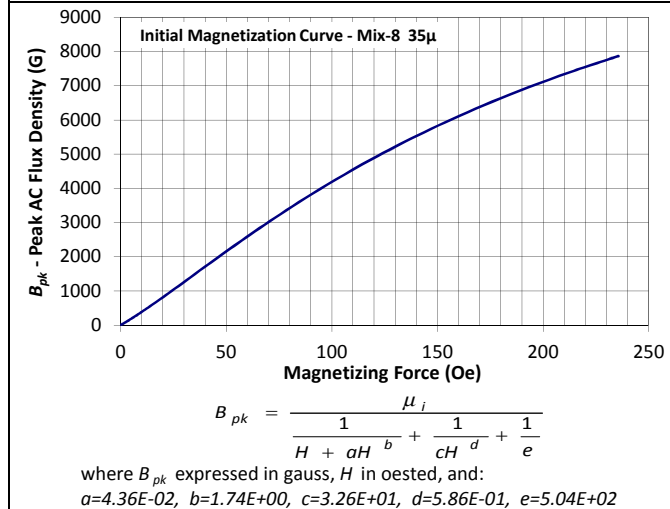
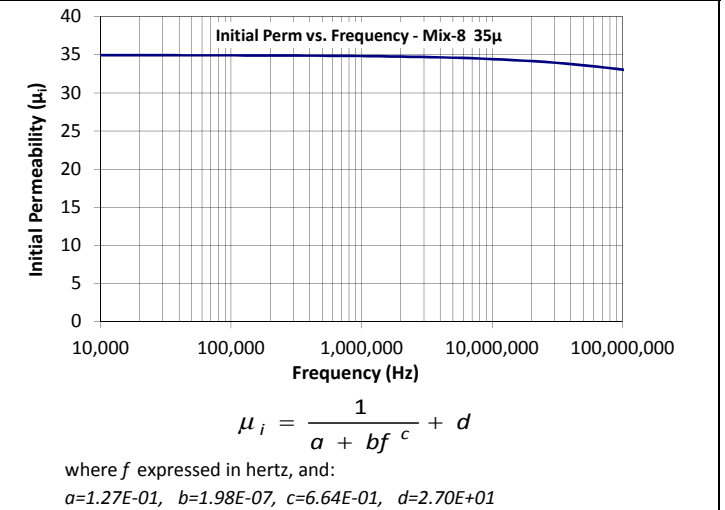
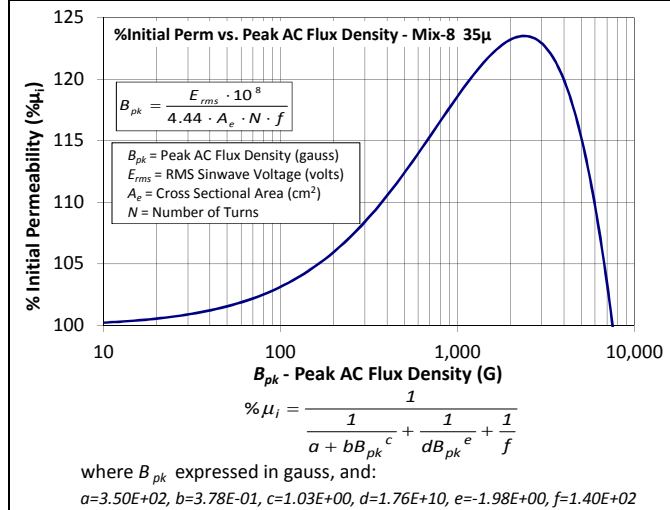
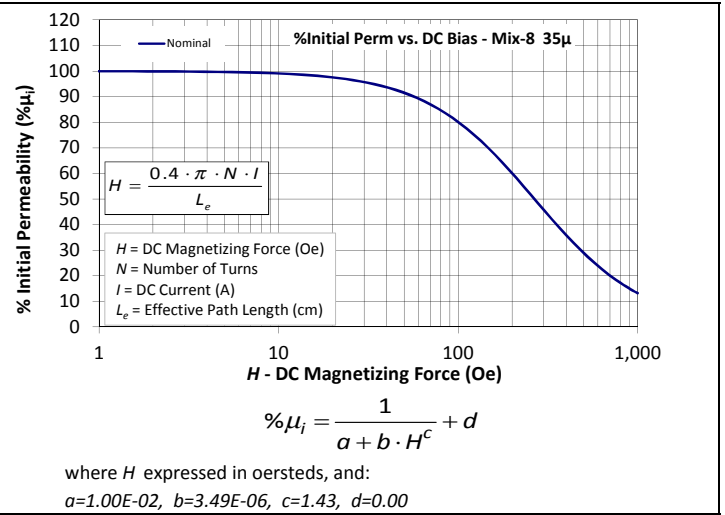
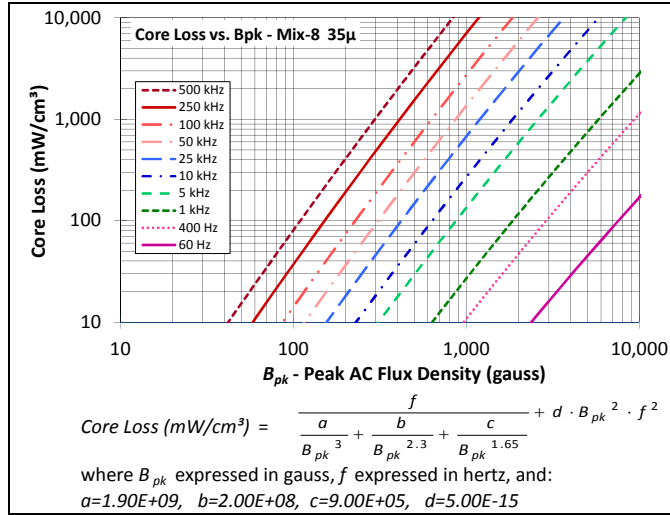

-10 material is a high frequency carbonyl iron. -10 will provide high Q up to 150 MHz and is a popular material for cable television applications. -10 will produce moderate band transformers covering 400 to 700 MHz.

Mix:	-10
Revision 20161006 - Generated 2016-Oct-10	
μ (reference)	6
Color Code	Black/Clear
Density	4.9 g/cm ³
Bsat	14.6kG
Core Loss (100kHz, 140g)	18 mW/cm ³ (nom) 20 mW/cm ³ (max)
%Perm at DC Bias (200 Oe)	99.6% (nom) 99.4% (min)

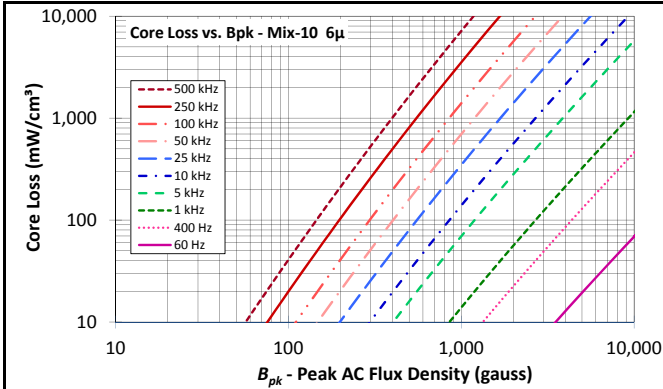

$$\text{Core Loss (mW/cm}^3\text{)} = \frac{a}{B_{pk}^3} + \frac{b}{B_{pk}^{2.3}} + \frac{c}{B_{pk}^{1.65}} + d \cdot B_{pk}^2 \cdot f^2$$

where B_{pk} expressed in gauss, f expressed in hertz, and:
 $a=4.00E+09$, $b=3.00E+08$, $c=2.70E+06$, $d=8.00E-16$

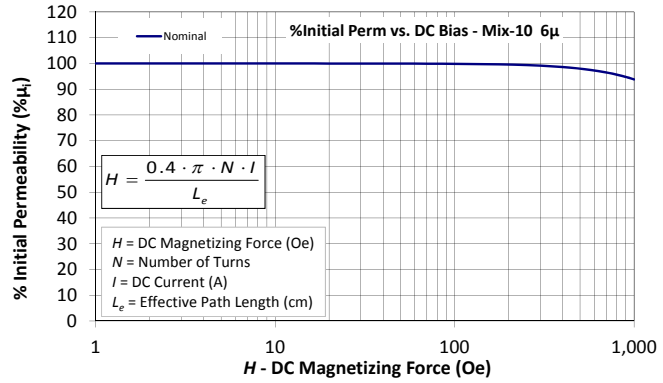

$$\% \mu_i = \frac{1}{a + b \cdot H^c} + d$$

where H expressed in oersteds, and:

$a=1.00E-02$, $b=5.54E-09$, $c=1.69$, $d=0.00$

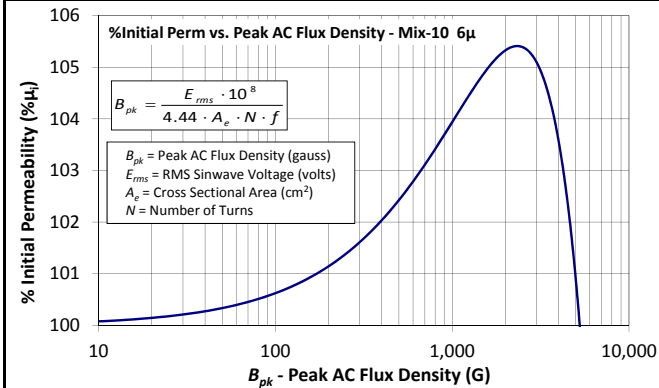

$$\% \mu_i = \frac{1}{\frac{1}{a + bB_{pk}^c} + \frac{1}{dB_{pk}^e} + \frac{1}{f}}$$

where B_{pk} expressed in gauss, and:

$a=1.57E+03$, $b=4.50E-01$, $c=1.25E+00$, $d=1.16E+17$, $e=-3.70E+00$, $f=1.07E+02$

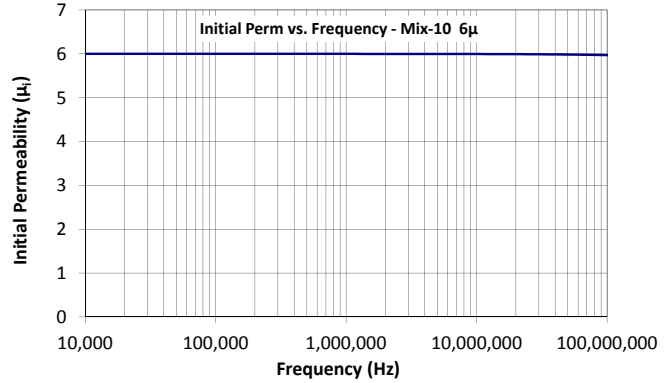

$$\mu_i = \frac{1}{a + bf^c} + d$$

where f expressed in hertz, and:

$a=2.00E-01$, $b=7.01E-11$, $c=9.00E-01$, $d=1.00E+00$

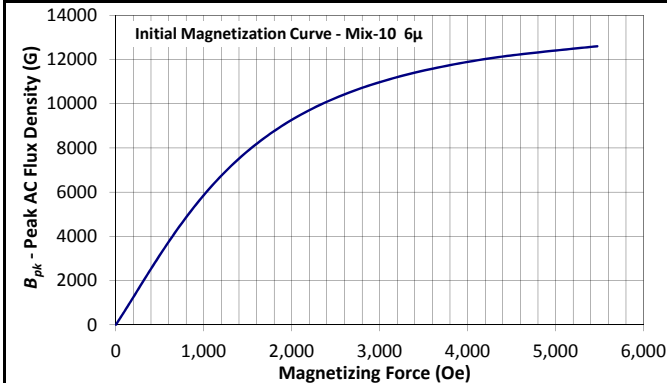

$$B_{pk} = \frac{\mu_i}{\frac{1}{H + aH^b} + \frac{1}{cH^d} + \frac{1}{e}}$$

where B_{pk} expressed in gauss, H in oested, and:

$a=9.13E-04$, $b=1.96E+00$, $c=3.83E+04$, $d=9.23E-04$, $e=2.43E+03$

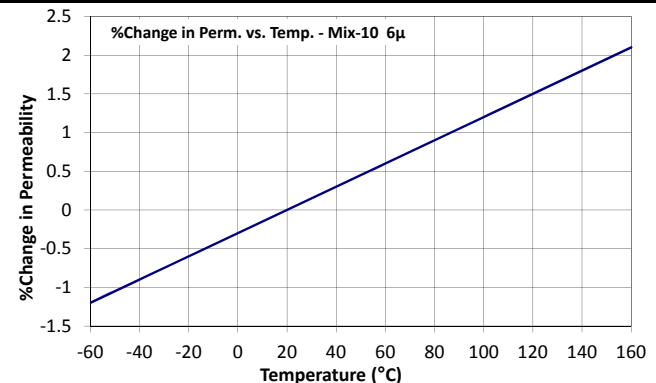

$$\left(\frac{\Delta \mu_i}{\mu_i} \right) ppm = a(T - 20)$$

where T expressed in celsius, and:

$a=150$

-14 material has low permeability resulting in a lower operating AC flux density than other materials with no additional gap-loss. The -14 material is similar to -2 material but with a higher permeability.

Mix:	-14
-------------	------------

Revision 20160707 - Generated 2016-Jul-08

μ_i (reference)	14
Color Code	Black/Red
Density	5.2 g/cm ³
Bsat	15.2kG
Core Loss (100kHz, 140g)	18 mW/cm ³ (nom) 21 mW/cm ³ (max)
%Perm at DC Bias (200 Oe)	91.8% (nom) 89.6% (min)

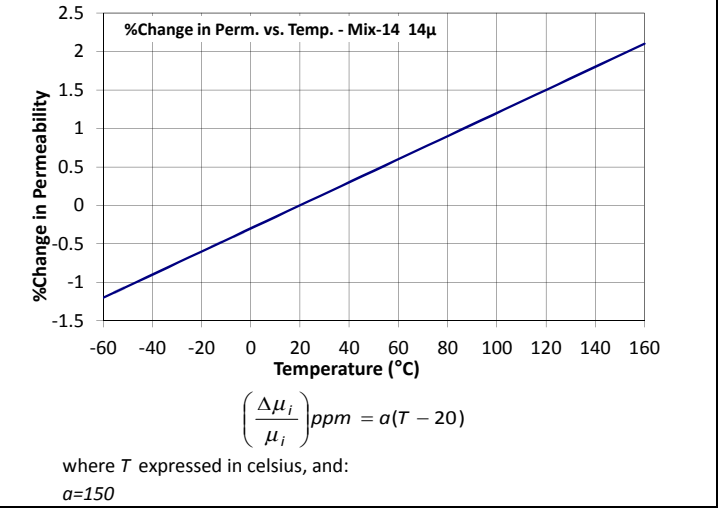
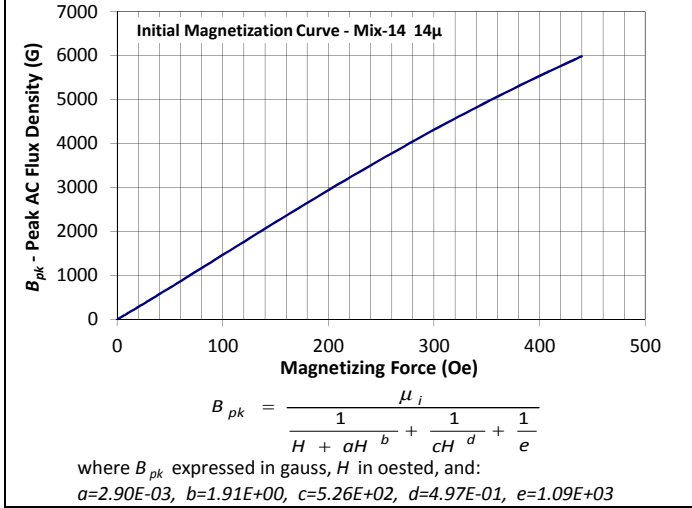
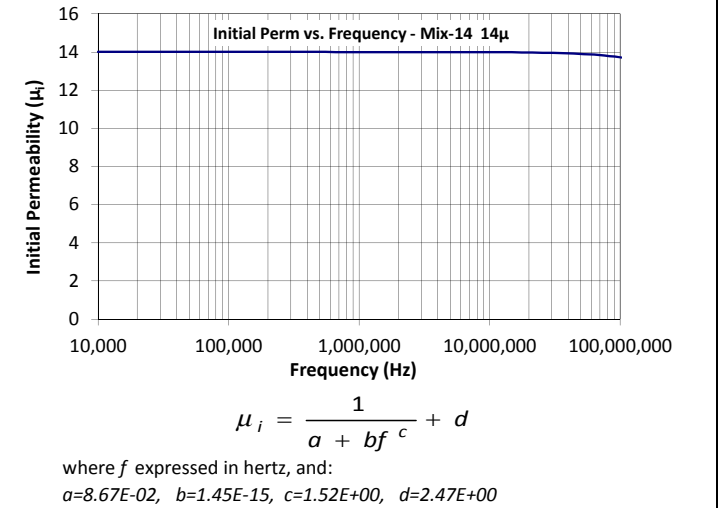
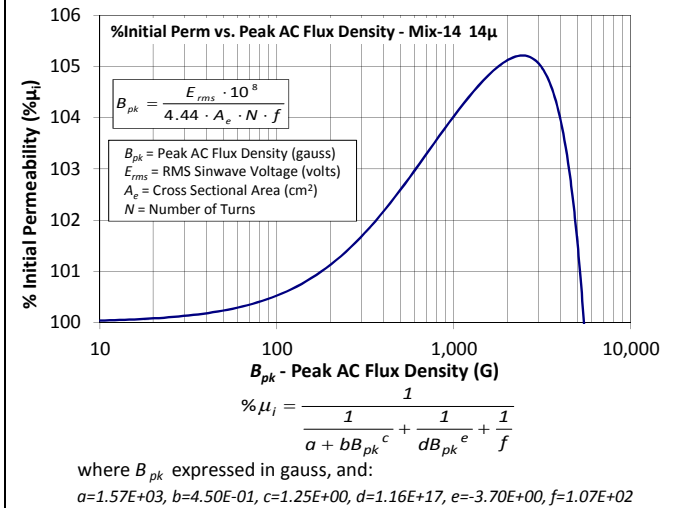
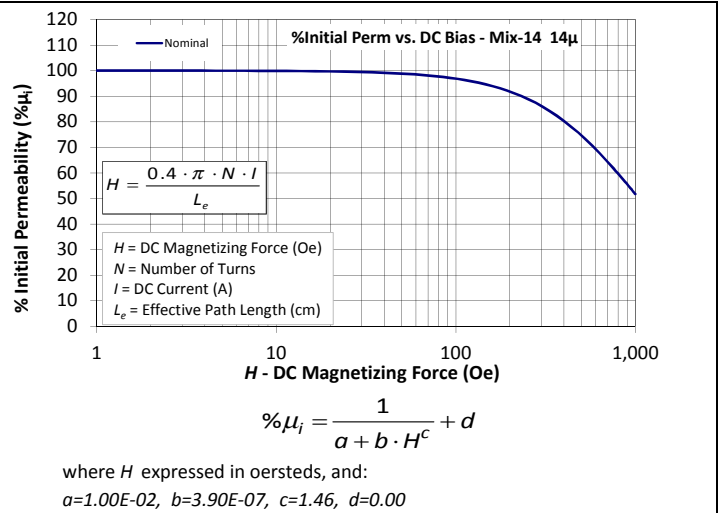
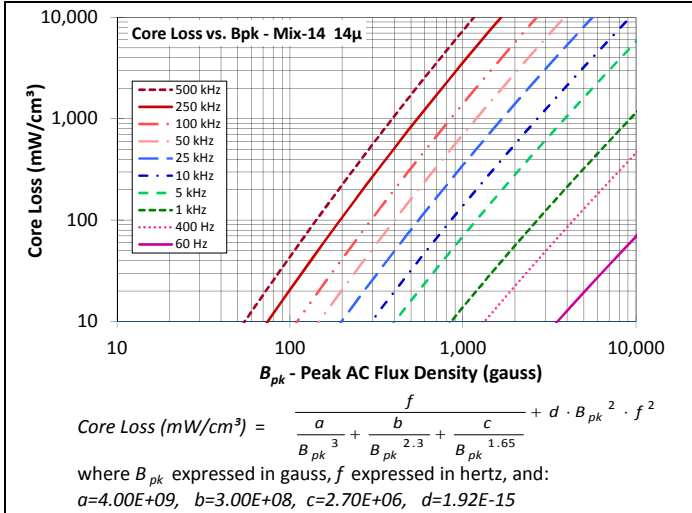

-15 material is an annealed carbonyl iron providing the highest carbonyl permeability. -15 is useful for high Q applications below 1 MHz and will provide the broadest band transformers covering a typical range from 50 to 500 MHz.

Mix:	-15
-------------	------------

Revision 20160615 - Generated 2016-Jun-20

μ (reference)	25
Color Code	Red/White
Density	6.4 g/cm ³
Bsat	17.5kG
Core Loss (100kHz, 140g)	32 mW/cm ³ (nom) 36 mW/cm ³ (max)
%Perm at DC Bias (200 Oe)	74.7% (nom) 69.4% (min)

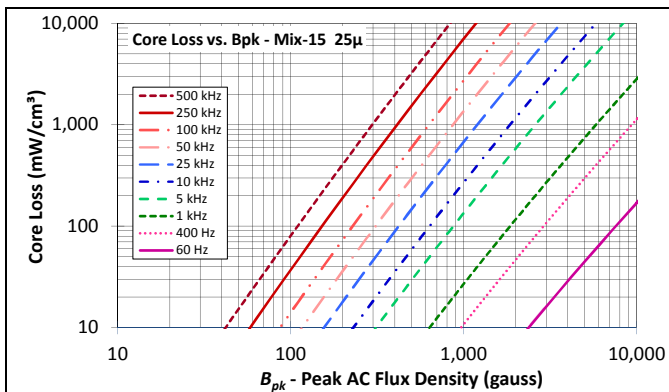

$$\text{Core Loss (mW/cm}^3\text{)} = \frac{a}{B_{pk}^3} + \frac{b}{B_{pk}^{2.3}} + \frac{c}{B_{pk}^{1.65}} + d \cdot B_{pk}^2 \cdot f^2$$

where B_{pk} expressed in gauss, f expressed in hertz, and:
 $a=1.90E+09$, $b=2.00E+08$, $c=9.00E+05$, $d=5.00E-15$

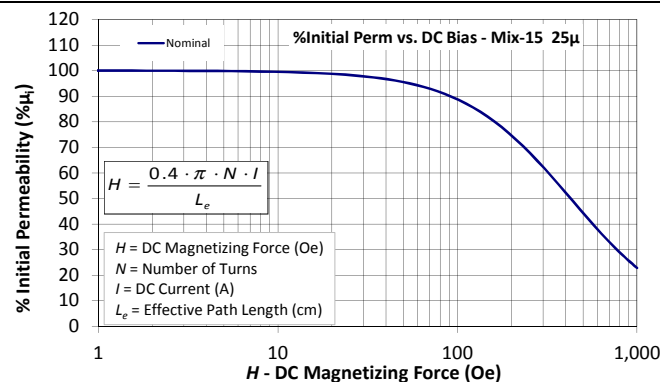

$$\% \mu_i = \frac{1}{a + b \cdot H^c} + d$$

where H expressed in oersteds, and:
 $a=1.00E-02$, $b=1.78E-06$, $c=1.43$, $d=0.00$

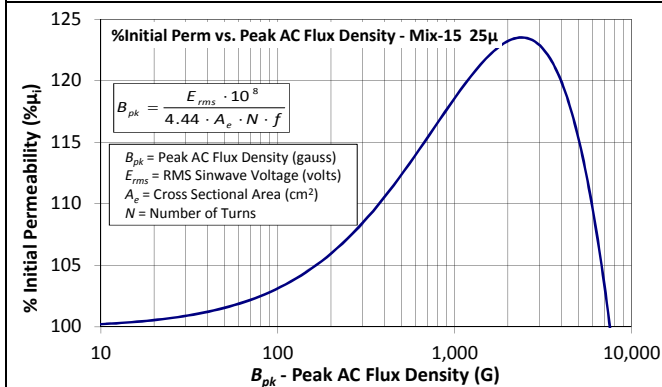

$$\% \mu_i = \frac{1}{a + bB_{pk}^c} + \frac{1}{dB_{pk}^e} + \frac{1}{f}$$

where B_{pk} expressed in gauss, and:
 $a=3.50E+02$, $b=3.78E-01$, $c=1.03E+00$, $d=1.76E+10$, $e=-1.98E+00$, $f=1.40E+02$

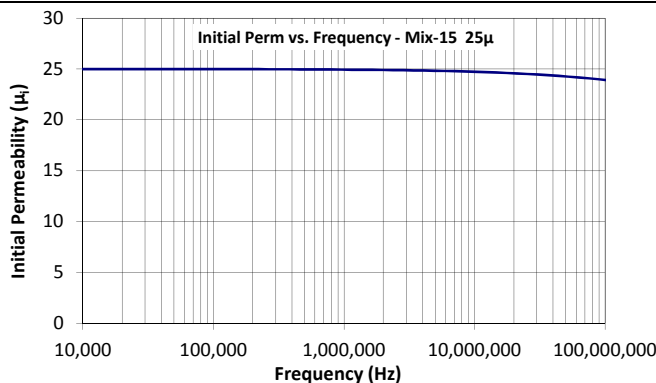

$$\mu_i = \frac{1}{a + bf^c} + d$$

where f expressed in hertz, and:
 $a=1.75E-01$, $b=1.98E-07$, $c=6.64E-01$, $d=1.93E+01$

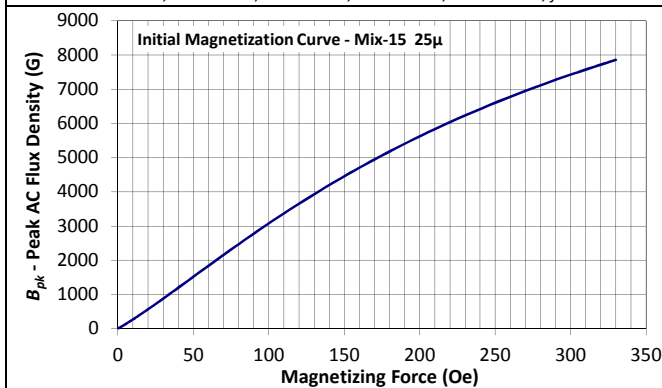

$$B_{pk} = \frac{\mu_i}{H + aH^b} + \frac{1}{cH^d} + \frac{1}{e}$$

where B_{pk} expressed in gauss, H in oested, and:
 $a=3.18E-02$, $b=1.75E+00$, $c=4.23E+01$, $d=5.67E-01$, $e=6.98E+02$

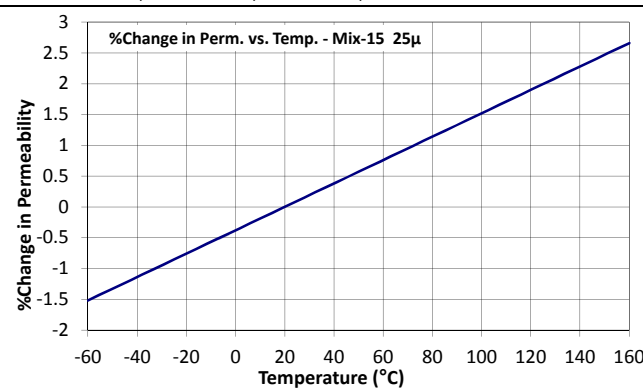

$$\left(\frac{\Delta \mu_i}{\mu_i} \right) ppm = a(T - 20)$$

where T expressed in celsius, and:
 $a=190$

-17 material is one of the highest frequency carbonyl irons. -17 will provide high Q up to 150 MHz and is a popular material for cable television applications. -17 will produce moderate band transformers covering 400 to 700 MHz.

Mix:	-17
-------------	------------

Revision 20160308 - Generated 2016-Mar-23

μ_i (reference)	4
Color Code	Blue/Yellow
Density	4.8 g/cm ³
Bsat	14.4kG
Core Loss (100kHz, 140g)	18 mW/cm ³ (nom) 20 mW/cm ³ (max)
%Perm at DC Bias (200 Oe)	99.5% (nom) 99.4% (min)

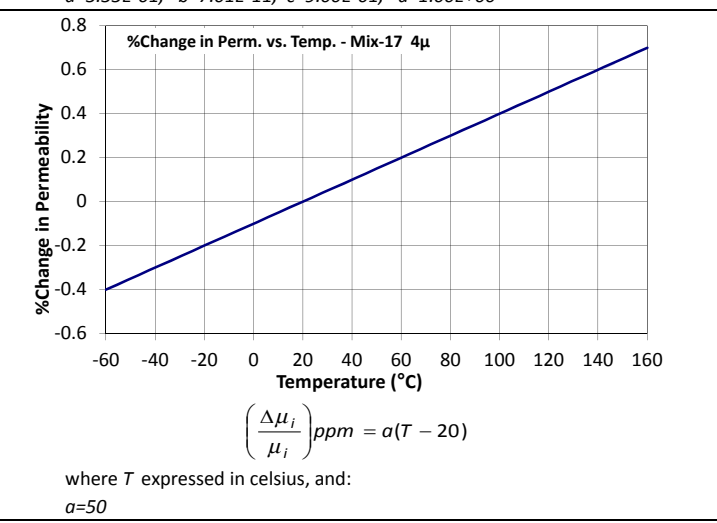
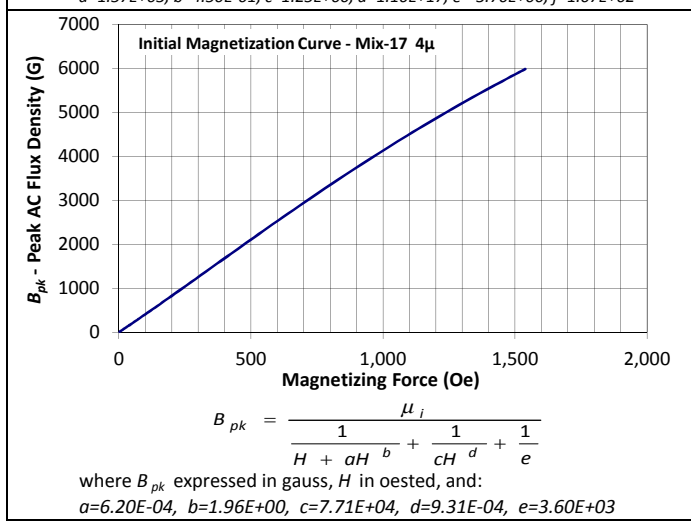
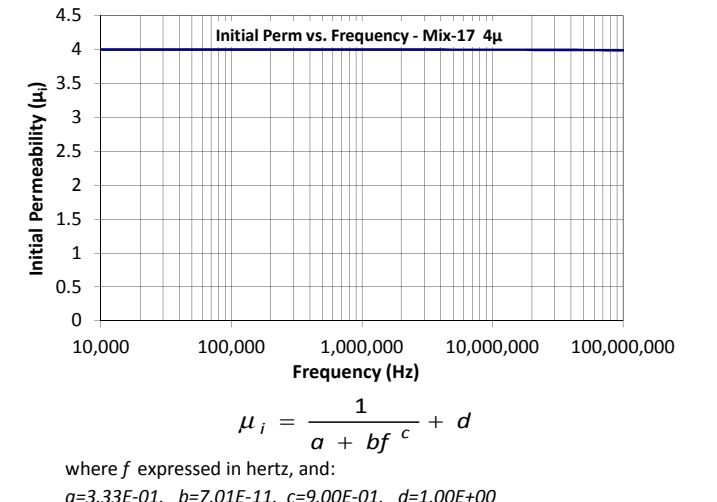
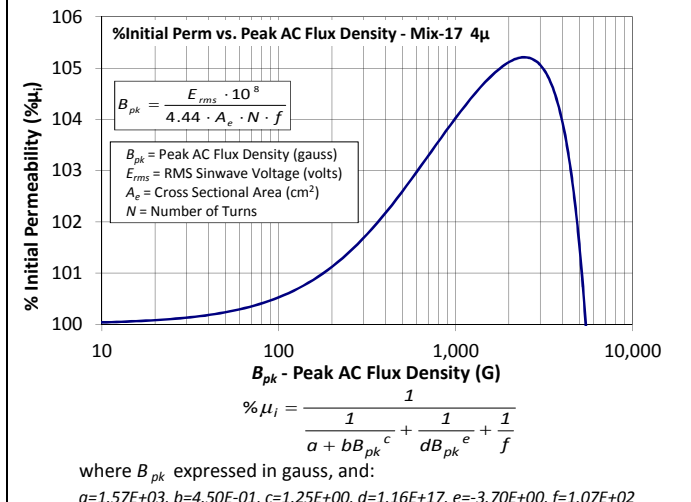
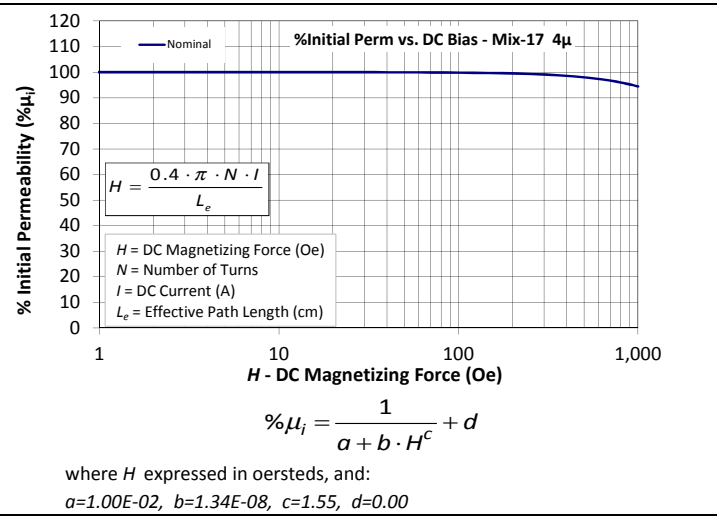
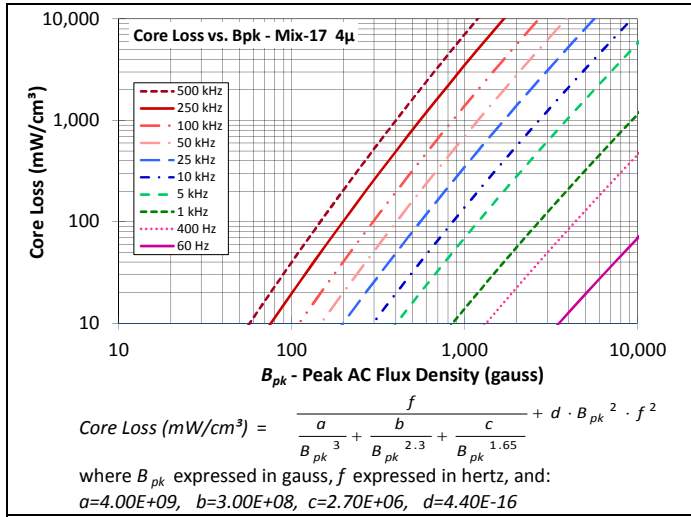

-18 material has low core loss similar to the -8 Material with higher permeability and a lower cost. -18 also has good DC saturation characteristics.

Mix:	-18
-------------	------------

Revision 20160615 - Generated 2016-Jun-20

μ (reference)	55
Color Code	Green/Red
Density	6.6 g/cm ³
Bsat	17.8kG
Core Loss (100kHz, 140g)	46 mW/cm ³ (nom) 53 mW/cm ³ (max)
%Perm at DC Bias (100 Oe)	51.4% (nom) 43.9% (min)

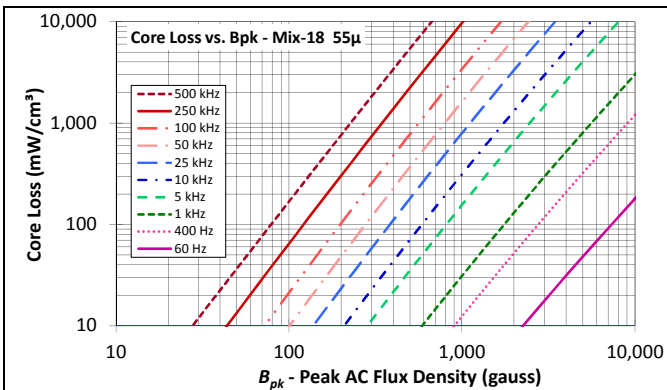

$$\text{Core Loss (mW/cm}^3\text{)} = \frac{a}{B_{pk}^3} + \frac{b}{B_{pk}^{2.3}} + \frac{c}{B_{pk}^{1.65}} + d \cdot B_{pk}^2 \cdot f^2$$

where B_{pk} expressed in gauss, f expressed in hertz, and:
 $a=8.00E+08$, $b=1.70E+08$, $c=9.00E+05$, $d=3.10E-14$

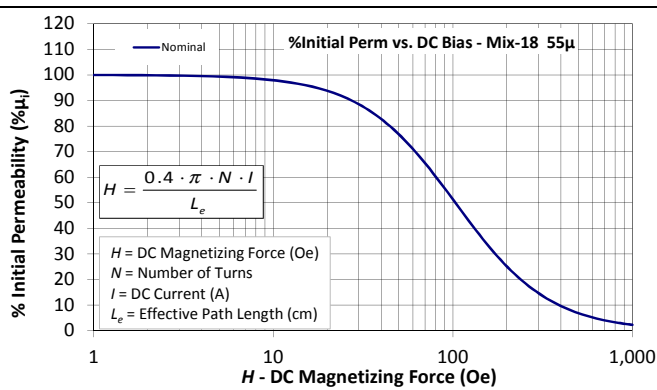

$$H = \frac{0.4 \cdot \pi \cdot N \cdot I}{L_e}$$

H = DC Magnetizing Force (Oe)
 N = Number of Turns
 I = DC Current (A)
 L_e = Effective Path Length (cm)

$$\% \mu_i = \frac{1}{a + b \cdot H^c} + d$$

where H expressed in oersteds, and:
 $a=1.00E-02$, $b=4.72E-06$, $c=1.65$, $d=0.00$

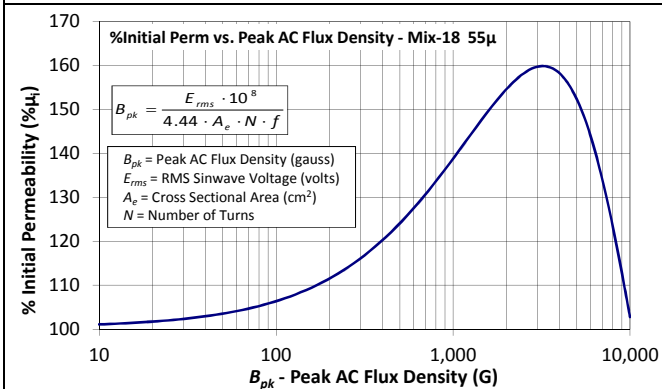

$$B_{pk} = \frac{E_{rms} \cdot 10^8}{4.44 \cdot A_e \cdot N \cdot f}$$

B_{pk} = Peak AC Flux Density (gauss)
 E_{rms} = RMS Sinwave Voltage (volts)
 A_e = Cross Sectional Area (cm²)
 N = Number of Turns

$$\% \mu_i = \frac{1}{a + bB_{pk}^c + \frac{1}{dB_{pk}^e} + \frac{1}{f}}$$

where B_{pk} expressed in gauss, and:
 $a=1.84E+02$, $b=2.45E-01$, $c=9.67E-01$, $d=3.53E+10$, $e=-2.06E+00$, $f=2.21E+02$

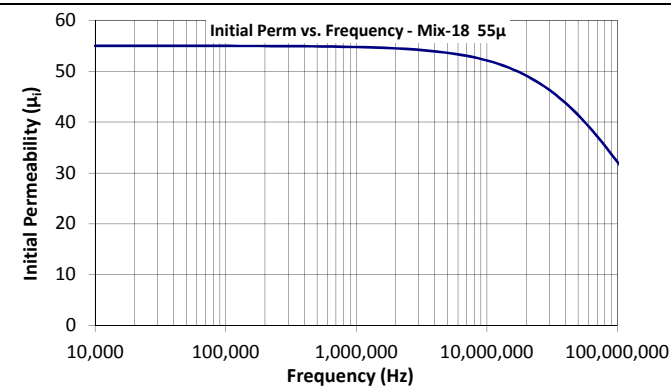

$$\mu_i = \frac{1}{a + bf^c} + d$$

where f expressed in hertz, and:
 $a=1.82E-02$, $b=1.70E-11$, $c=1.11E+00$, $d=0.00E+00$

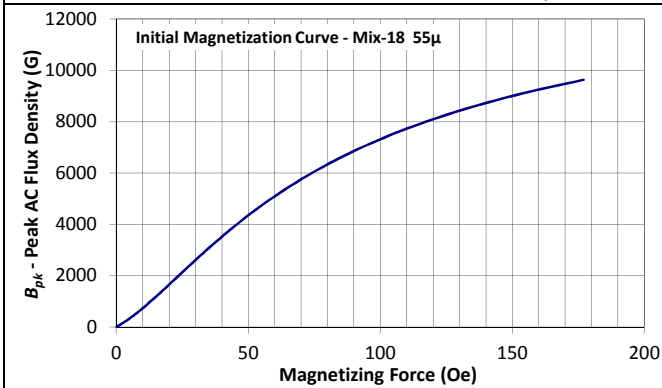

$$B_{pk} = \frac{\mu_i}{H + aH^b + \frac{1}{cH^d} + \frac{1}{e}}$$

where B_{pk} expressed in gauss, H in oested, and:
 $a=6.81E-02$, $b=1.92E+00$, $c=3.25E+01$, $d=5.27E-01$, $e=3.24E+02$

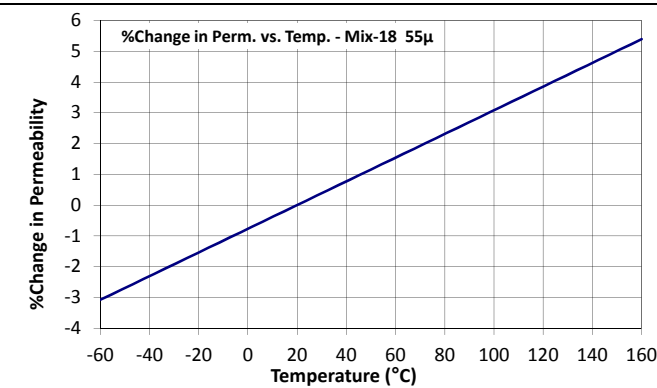

$$\left(\frac{\Delta \mu_i}{\mu_i} \right) ppm = a(T - 20)$$

where T expressed in celsius, and:
 $a=385$

-19 material is an lower cost alternate to the -18 material with the same permeability but with a slightly higher core loss.

Mix:	-19
Revision 20171027 - Generated 2017-Nov-08	
μ (reference)	55
Color Code	Red/Green
Density	6.8 g/cm ³
Bsat	18.2kG
Core Loss (100kHz, 140g)	54 mW/cm ³ (nom) 62 mW/cm ³ (max)
%Perm at DC Bias (100 Oe)	53.8% (nom) 46.2% (min)

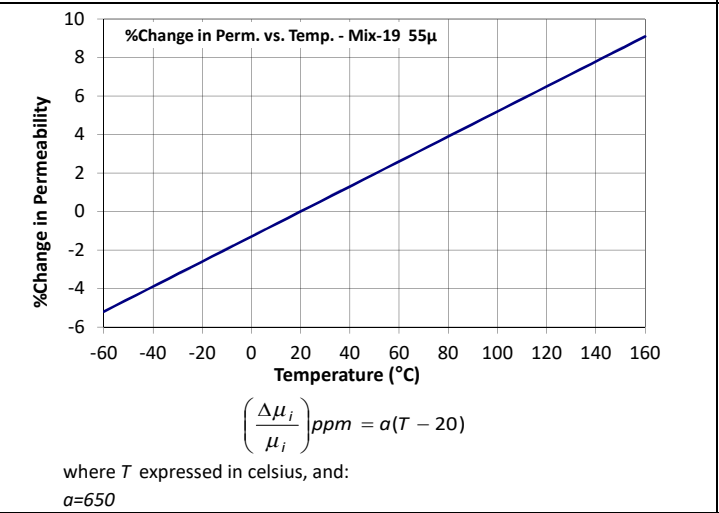
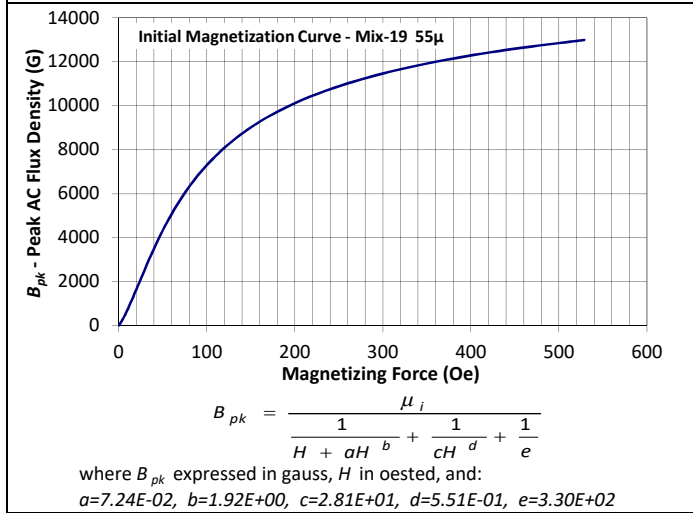
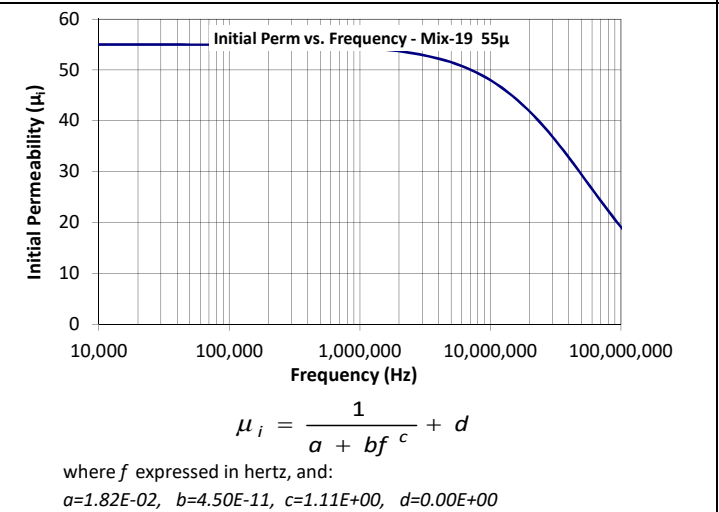
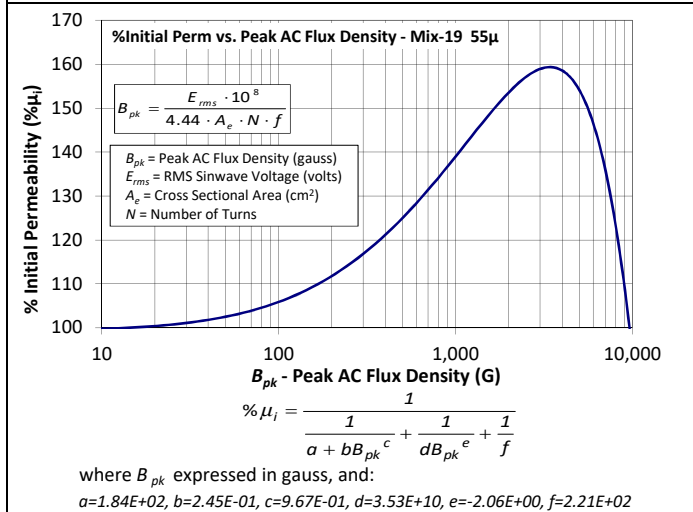
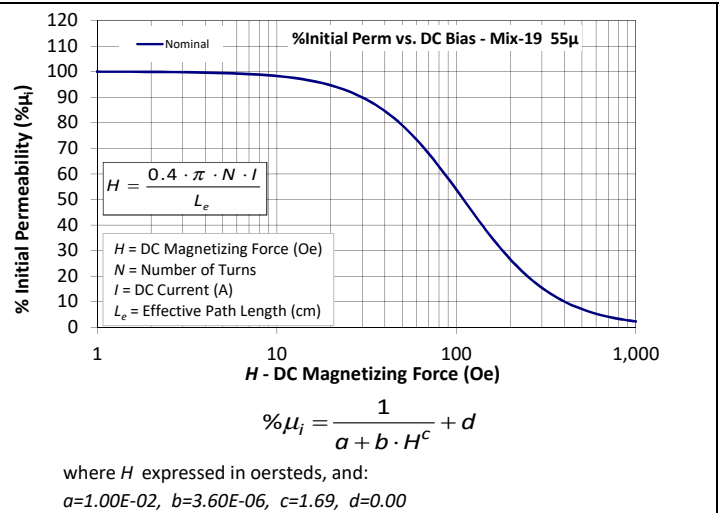
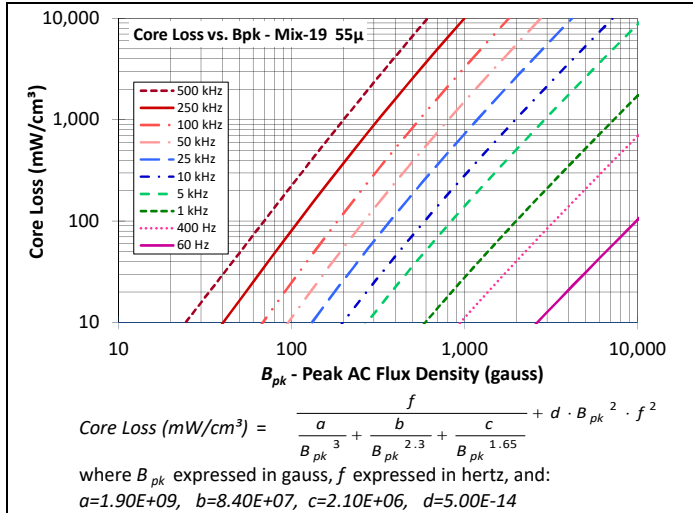

-26 material is a very popular, cost-effective, general purpose material that is useful in a wide variety of power conversion and line filter applications.

Mix:	-26
Revision 20160422 - Generated 2016-Apr-28	
μ (reference)	75
Color Code	Yellow/White
Density	7.0 g/cm ³
Bsat	18.5kG
Core Loss (100kHz, 140g)	83 mW/cm ³ (nom) 95 mW/cm ³ (max)
%Perm at DC Bias (50 Oe)	55.2% (nom) 47.4% (min)

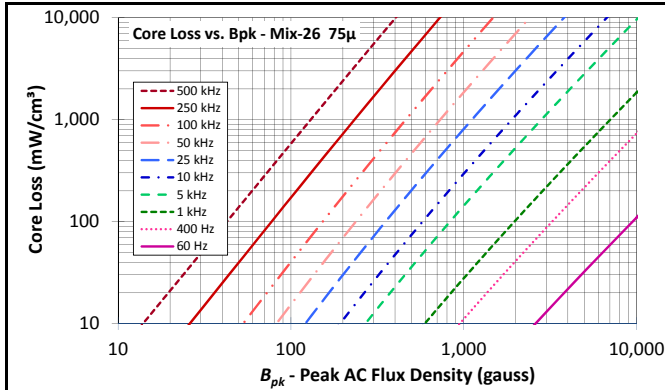

$$\text{Core Loss (mW/cm}^3\text{)} = \frac{a}{B_{pk}^3} + \frac{b}{B_{pk}^{2.3}} + \frac{c}{B_{pk}^{1.65}} + d \cdot B_{pk}^2 \cdot f^2$$

where B_{pk} expressed in gauss, f expressed in hertz, and:
 $a=1.00E+09$, $b=1.10E+08$, $c=1.90E+06$, $d=1.90E-13$

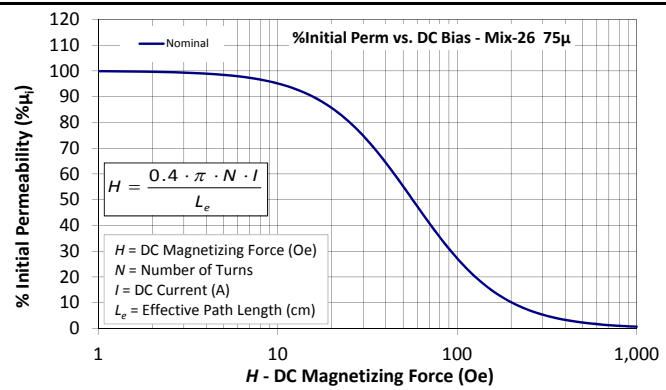

$$\% \mu_i = \frac{1}{a + b \cdot H^c} + d$$

where H expressed in oersteds, and:
 $a=1.00E-02$, $b=9.70E-06$, $c=1.72$, $d=0.00$

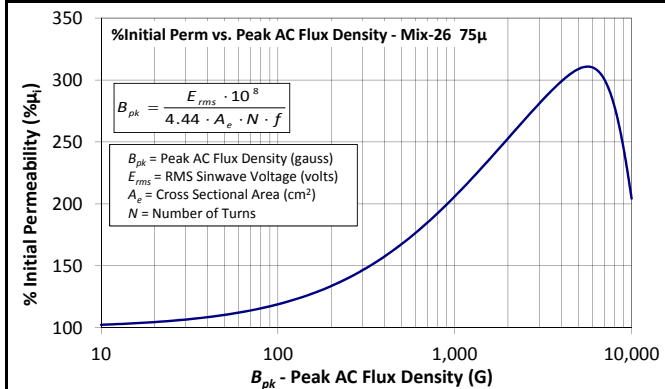

$$\% \mu_i = \frac{1}{a + bB_{pk}^c + \frac{1}{dB_{pk}^e} + \frac{1}{f}}$$

where B_{pk} expressed in gauss, and:
 $a=1.32E+02$, $b=5.71E-01$, $c=8.96E-01$, $d=1.45E+23$, $e=-5.12E+00$, $f=4.14E+02$

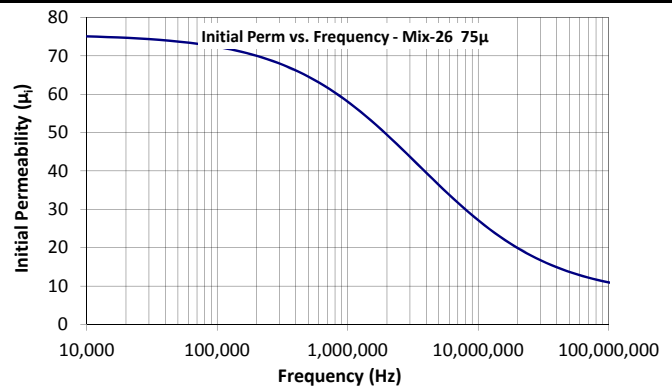

$$\mu_i = \frac{1}{a + bf^c} + d$$

where f expressed in hertz, and:
 $a=1.46E-02$, $b=4.13E-08$, $c=8.47E-01$, $d=7.15E+00$

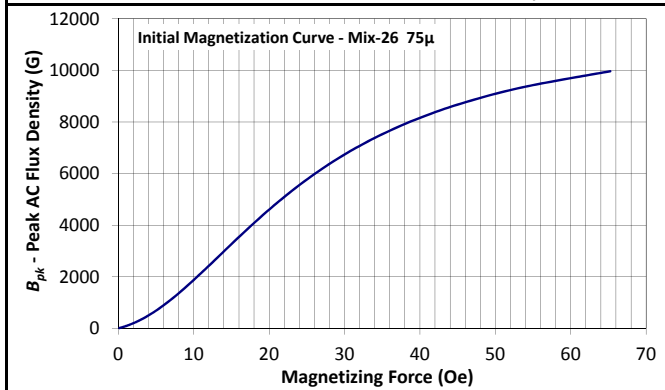

$$B_{pk} = \frac{\mu_i}{\frac{1}{H + aH^b} + \frac{1}{cH^d} + \frac{1}{e}}$$

where B_{pk} expressed in gauss, H in oested, and:
 $a=1.66E-01$, $b=2.09E+00$, $c=2.35E+02$, $d=1.20E-01$, $e=2.47E+02$

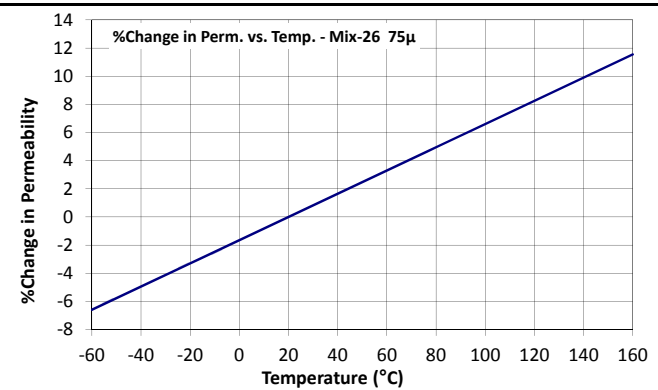

$$\left(\frac{\Delta \mu_i}{\mu_i} \right) ppm = a(T - 20)$$

where T expressed in celsius, and:
 $a=825$

-30 material is an economical materials that provides good linearity and a relatively low permeability making this material a popular choice for high power UPS applications.

Mix:	-30
-------------	------------

Revision 20160713 - Generated 2016-Aug-12

μi(reference)	22
Color Code	Green/Gray
Density	6.0 g/cm ³
Bsat	16.7kG
Core Loss (100kHz, 140g)	129 mW/cm ³ (nom) 149 mW/cm ³ (max)
%Perm at DC Bias (200 Oe)	66.7% (nom) 61.1% (min)

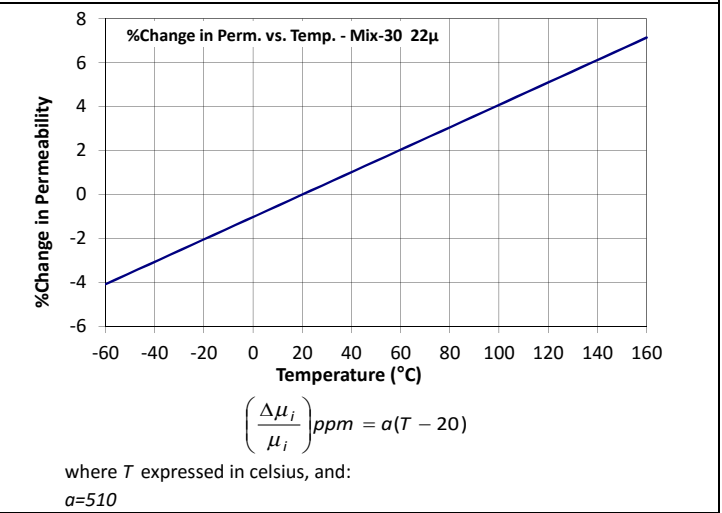
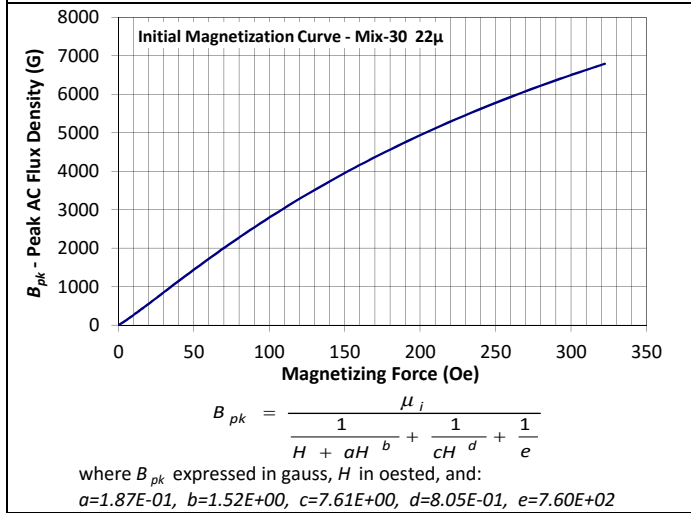
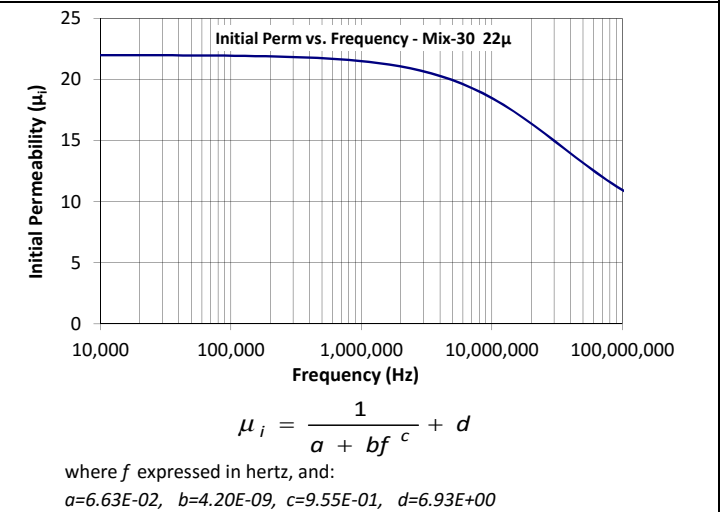
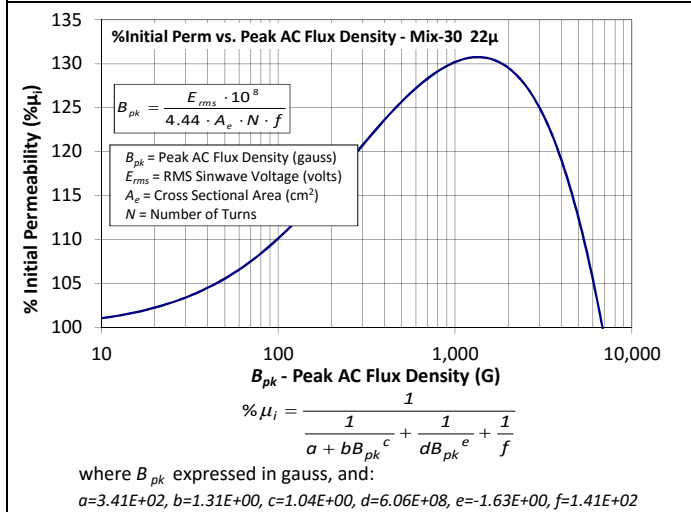
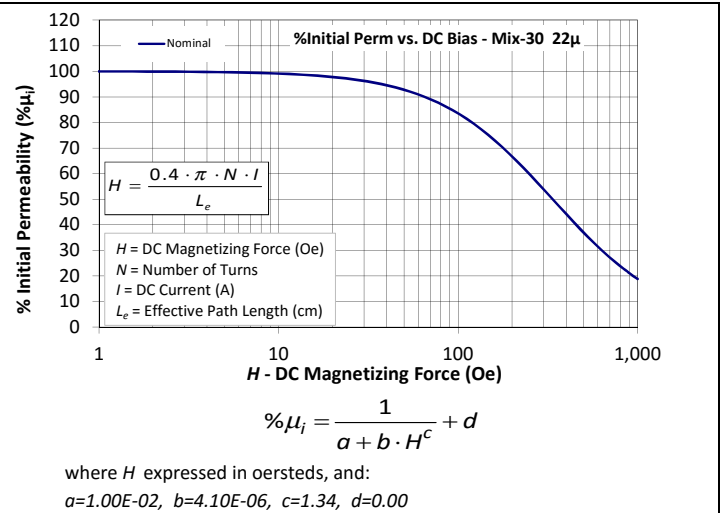
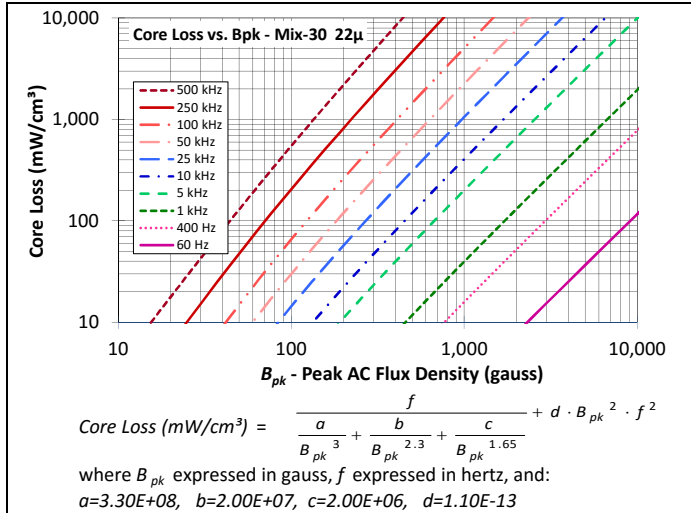

-34 material is an economical alternative to the -8 material where high frequency core loss is not critical.

Both -34 & -35 Materials have good linearity with high bias.

Mix:	-34
-------------	------------

Revision 20160422 - Generated 2016-Apr-29

μ_i (reference)	33
Color Code	Gray/Blue
Density	6.2 g/cm ³
Bsat	17.1kG
Core Loss (100kHz, 140g)	82 mW/cm ³ (nom) 94 mW/cm ³ (max)
%Perm at DC Bias (100 Oe)	73.2% (nom) 67.4% (min)

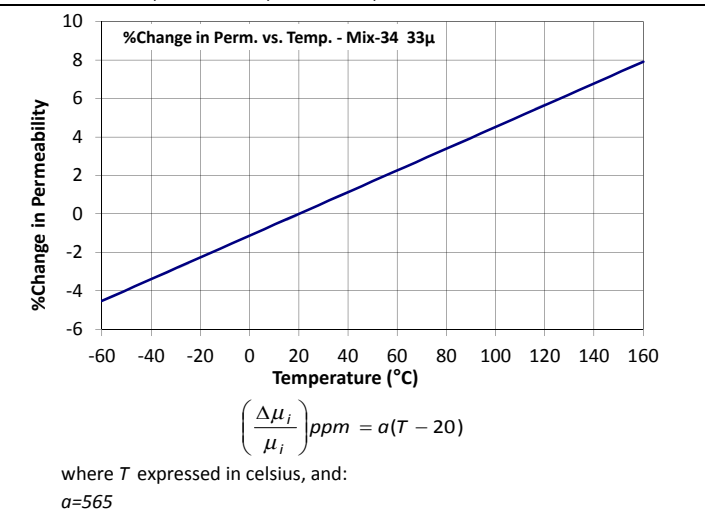
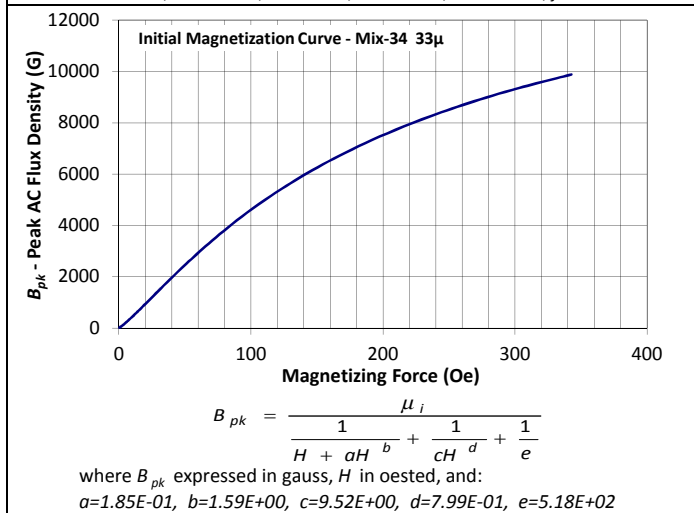
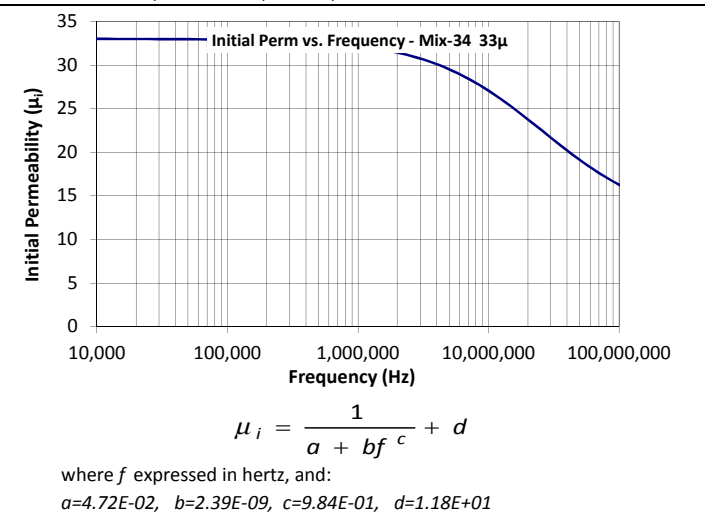
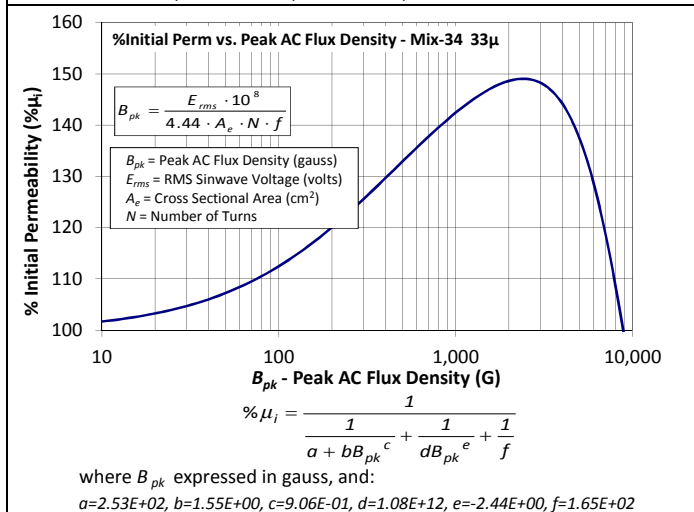
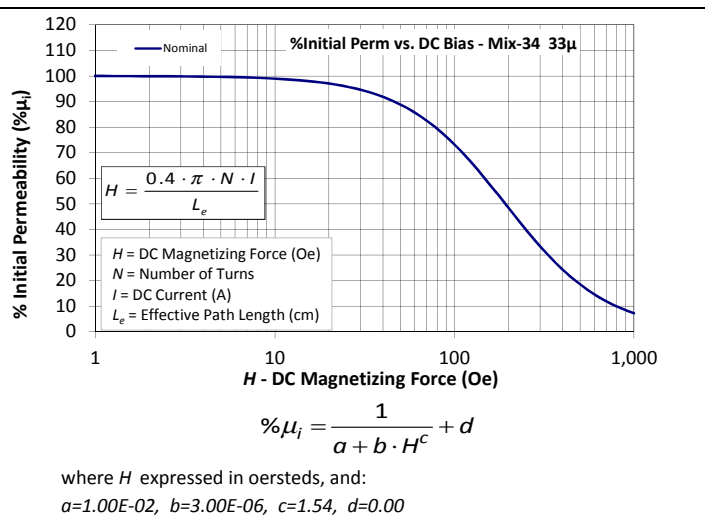
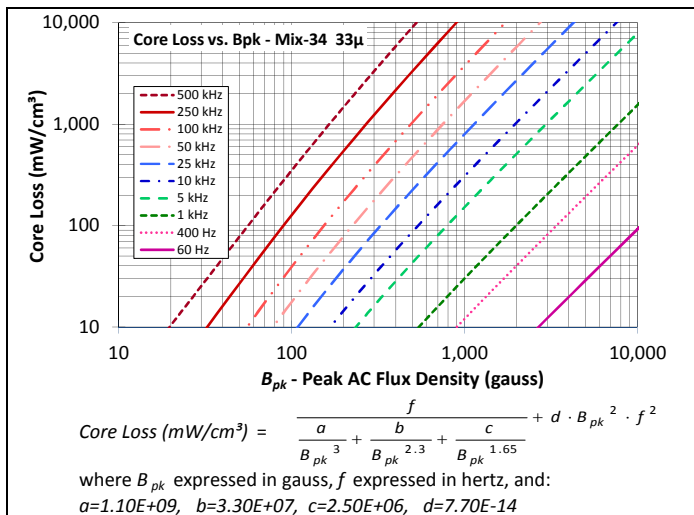

-35 material is an economical alternative to the -8 material where high frequency core loss is not critical. Both -34 & -35 Materials have good linearity with high bias.

Mix:	-35
Revision 20170912 - Generated 2017-Sep-14	
μ (reference)	33
Color Code	Yellow/Gray
Density	6.3 g/cm ³
Bsat	17.3kG
Core Loss (100kHz, 140g)	119 mW/cm ³ (nom)
	137 mW/cm ³ (max)
%Perm at DC Bias (100 Oe)	73.3% (nom)
	68.0% (min)

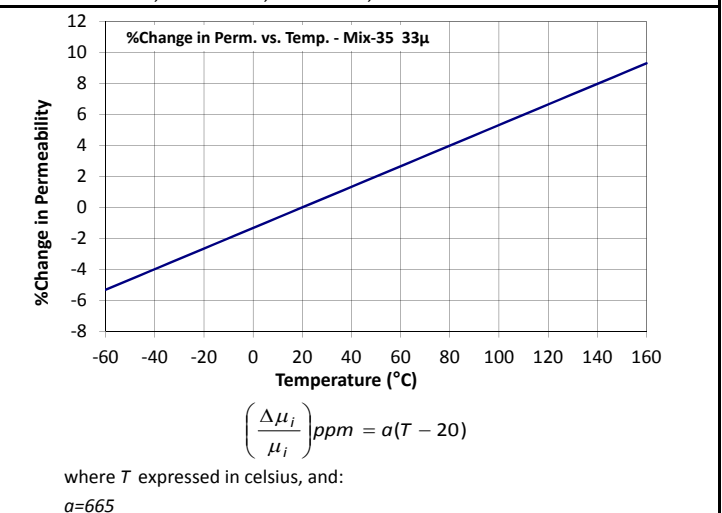
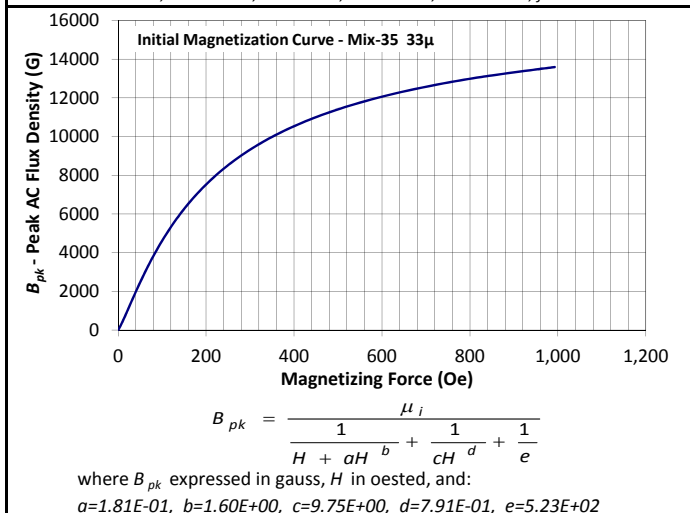
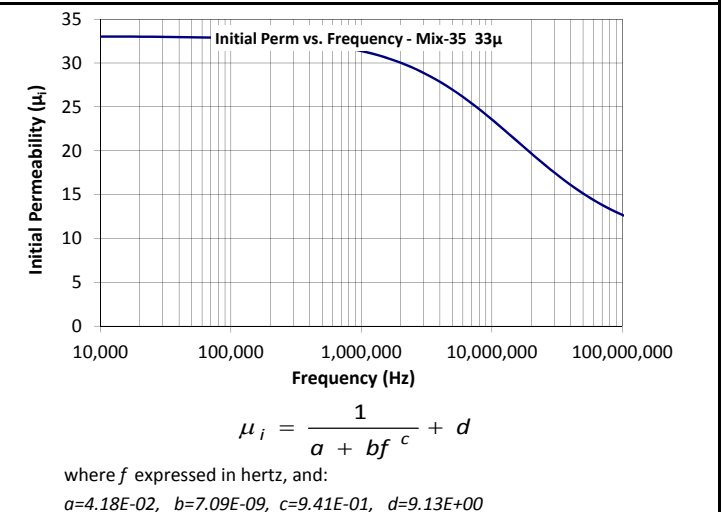
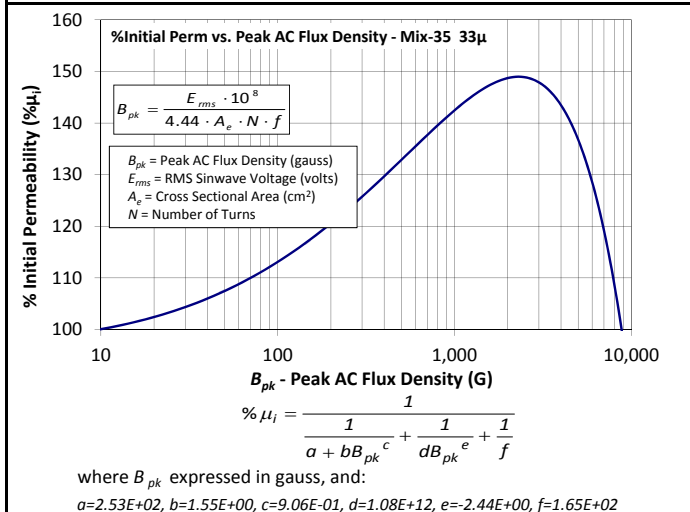
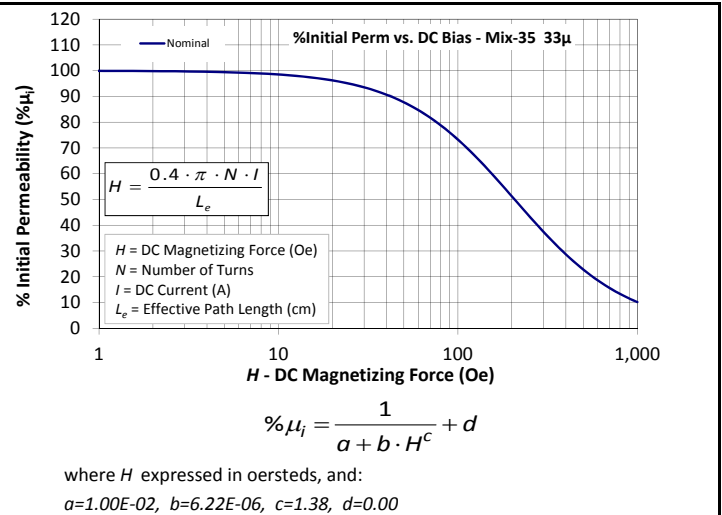
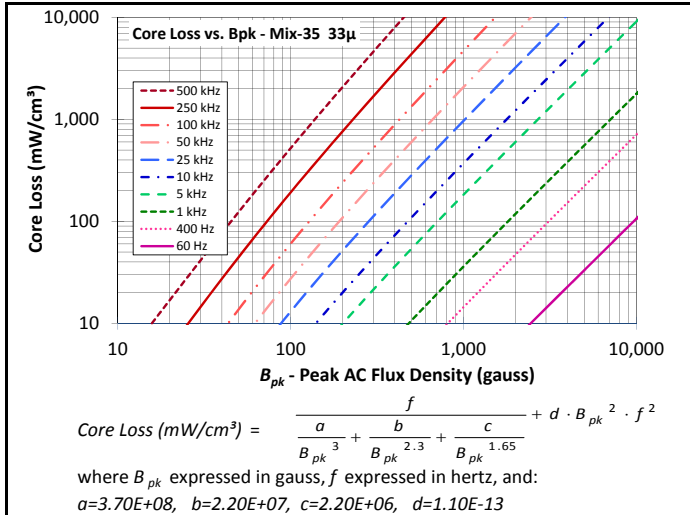

-38 material is a very cost effective, general purpose material that is used in a wide variety of power conversion and line filter applications.

-38 is similar to the -26 material but has a higher permeability.

Mix:	-38
-------------	------------

Revision 20170912 - Generated 2017-Oct-10

μ (reference)	85
Color Code	Gray/Black
Density	7.1 g/cm ³
Bsat	18.7kG
Core Loss (100kHz, 140g)	103 mW/cm ³ (nom) 118 mW/cm ³ (max)
%Perm at DC Bias (50 Oe)	51.4% (nom) 43.5% (min)

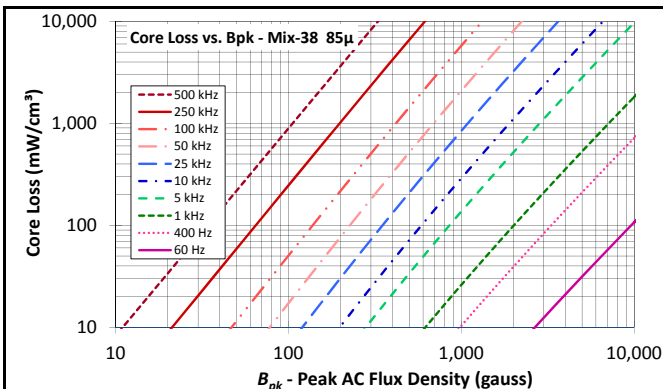

$$\text{Core Loss (mW/cm}^3\text{)} = \frac{a}{B_{pk}^3} + \frac{b}{B_{pk}^{2.3}} + \frac{c}{B_{pk}^{1.65}} + d \cdot B_{pk}^2 \cdot f^2$$

where B_{pk} expressed in gauss, f expressed in hertz, and:

$$a=1.20E+09, b=1.30E+08, c=1.90E+06, d=3.20E-13$$

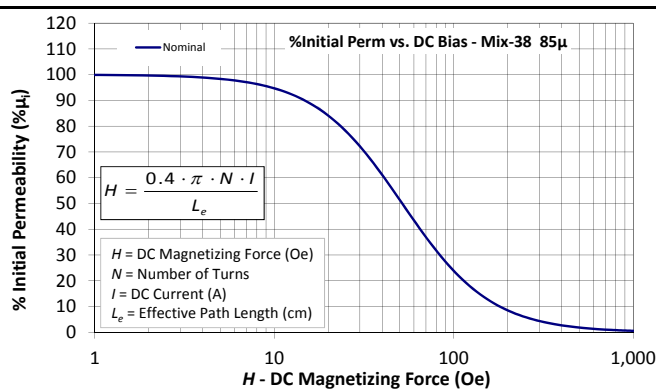

$$H = \frac{0.4 \cdot \pi \cdot N \cdot I}{L_e}$$

H = DC Magnetizing Force (Oe)
 N = Number of Turns
 I = DC Current (A)
 L_e = Effective Path Length (cm)

$$\% \mu_i = \frac{1}{a + b \cdot H^c} + d$$

where H expressed in oersteds, and:

$$a=1.00E-02, b=9.78E-06, c=1.76, d=0.00$$

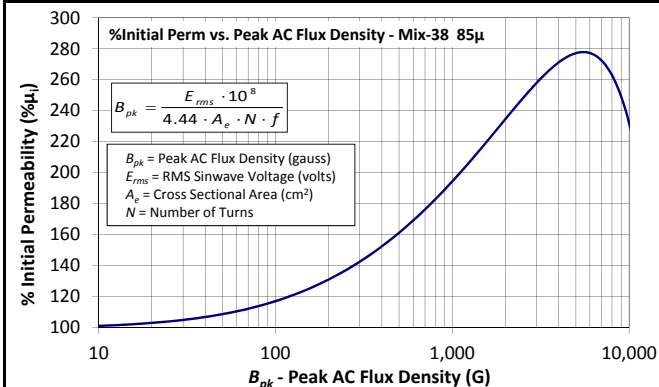

$$B_{pk} = \frac{E_{rms} \cdot 10^8}{4.44 \cdot A_e \cdot N \cdot f}$$

B_{pk} = Peak AC Flux Density (gauss)
 E_{rms} = RMS Sinwave Voltage (volts)
 A_e = Cross Sectional Area (cm²)
 N = Number of Turns

$$\% \mu_i = \frac{1}{a + bB_{pk}^c + dB_{pk}^e + \frac{1}{f}}$$

where B_{pk} expressed in gauss, and:

$$a=1.17E+02, b=1.86E+00, c=6.54E-01, d=4.70E+14, e=-2.96E+00, f=5.78E+02$$

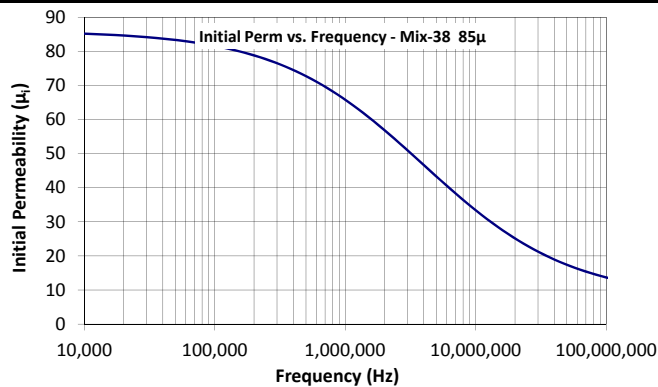

$$\mu_i = \frac{1}{a + bf^c} + d$$

where f expressed in hertz, and:

$$a=1.28E-02, b=1.04E-07, c=7.71E-01, d=7.71E+00$$

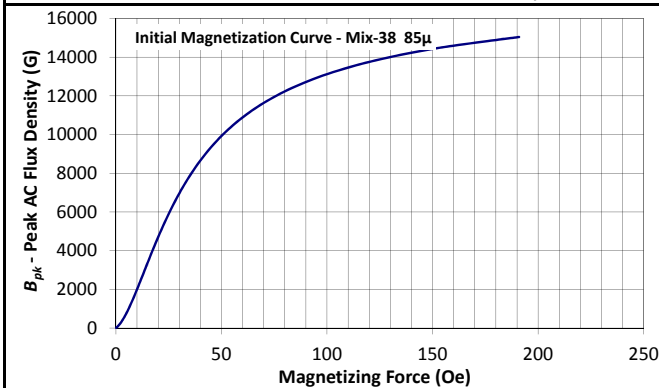

$$B_{pk} = \frac{\mu_i}{H + aH^b + \frac{1}{cH^d} + \frac{1}{e}}$$

where B_{pk} expressed in gauss, H in oested, and:

$$a=2.18E-01, b=2.00E+00, c=3.41E+01, d=6.46E-01, e=2.20E+02$$

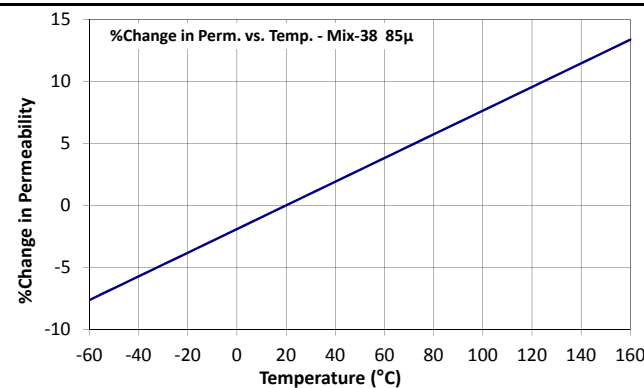

$$\left(\frac{\Delta \mu_i}{\mu_i} \right) ppm = a(T - 20)$$

where T expressed in celsius, and:

$$a=956$$

-40 material is the most economical iron powder material with characteristics similar to the -26 material but with a lower permeability. -40 is the most popular material for large sized cores and for a wide variety of power conversion and line filter applications.

Mix:	-40
Revision 20160129 - Generated 2016-Jan-29	
μ_i (reference)	60
Color Code	Green/Yellow
Density	6.9 g/cm ³
Bsat	18.4kG
Core Loss (100kHz, 140g)	127 mW/cm ³ (nom) 146 mW/cm ³ (max)
%Perm at DC Bias (50 Oe)	67.0% (nom) 60.2% (min)

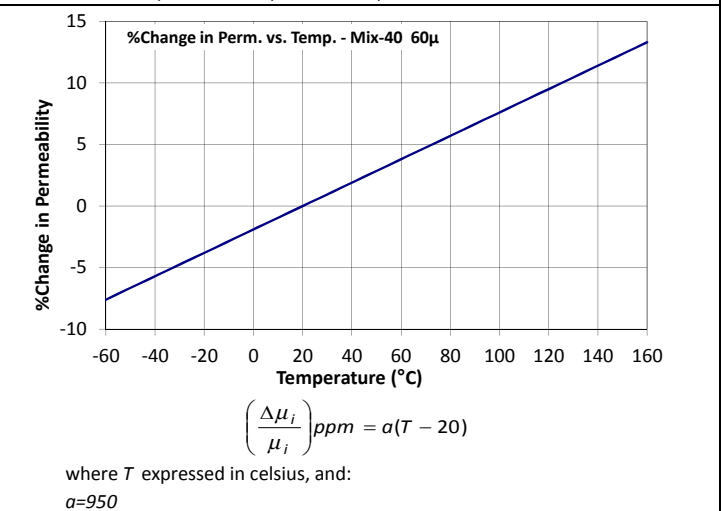
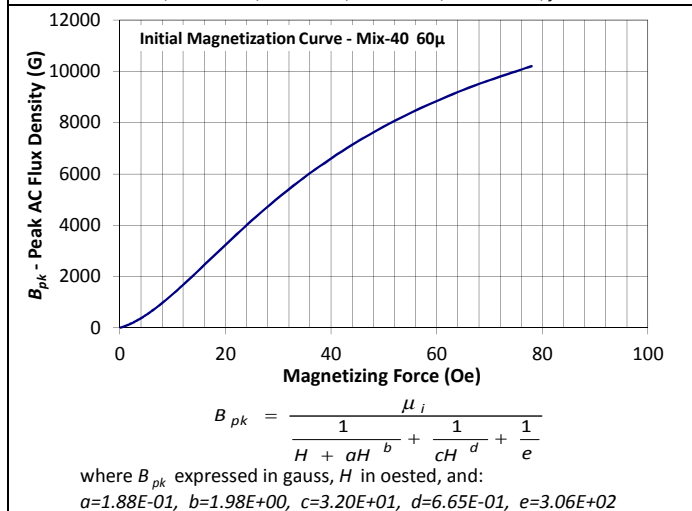
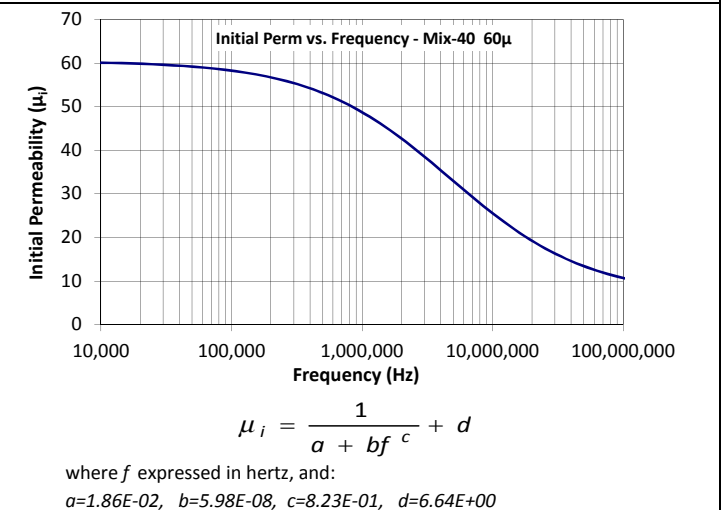
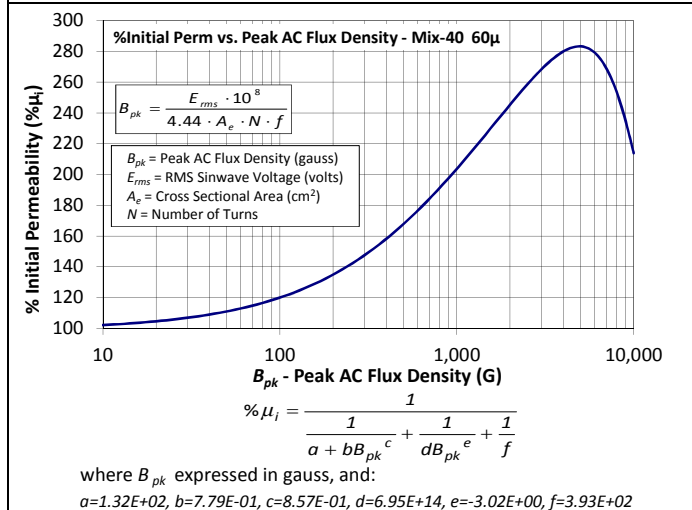
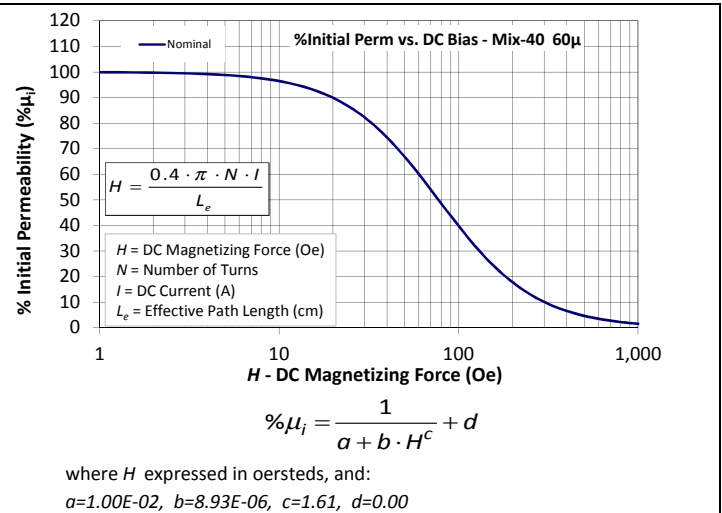
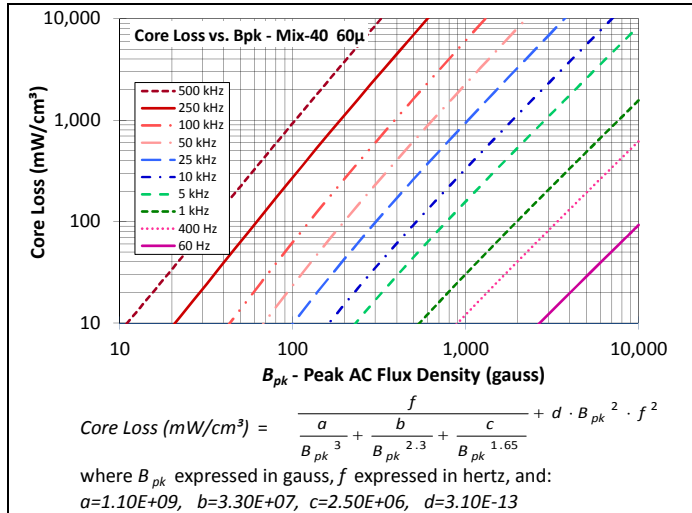

-45 material is the highest permeability iron powder material available. It is a higher perm alternative to the -52 material but with slightly higher core losses.

Mix:	-45
Revision 20160308 - Generated 2016-Mar-21	
μ_i (reference)	100
Color Code	Black/Black
Density	7.2 g/cm ³
Bsat	18.9kG
Core Loss (100kHz, 140g)	61 mW/cm ³ (nom) 71 mW/cm ³ (max)
%Perm at DC Bias (50 Oe)	43.3% (nom) 36.3% (min)

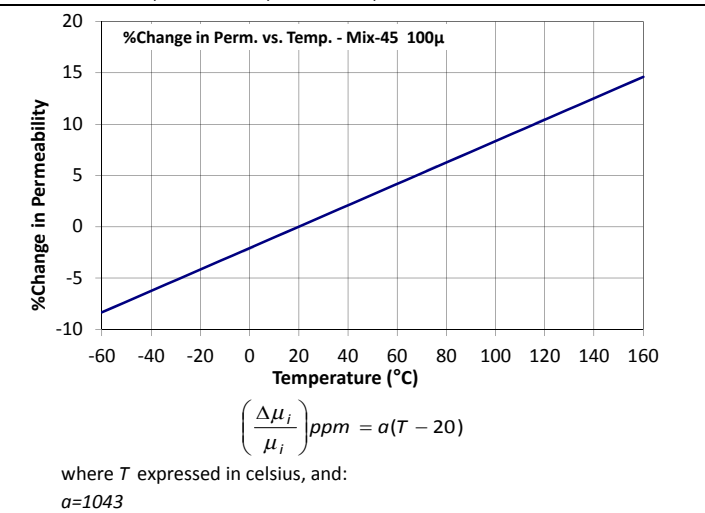
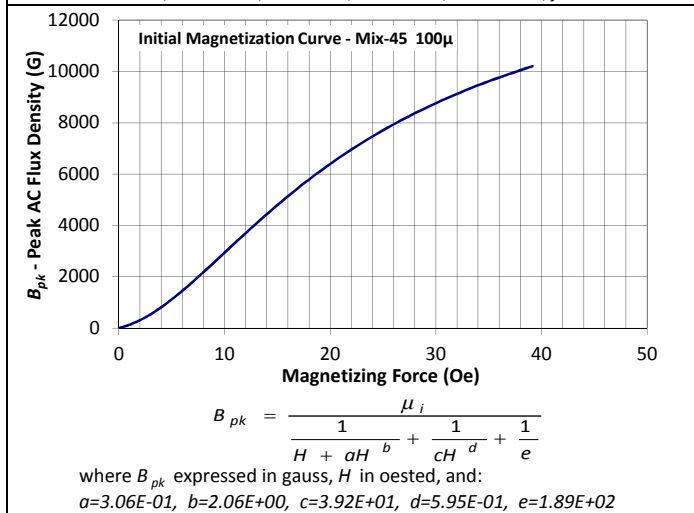
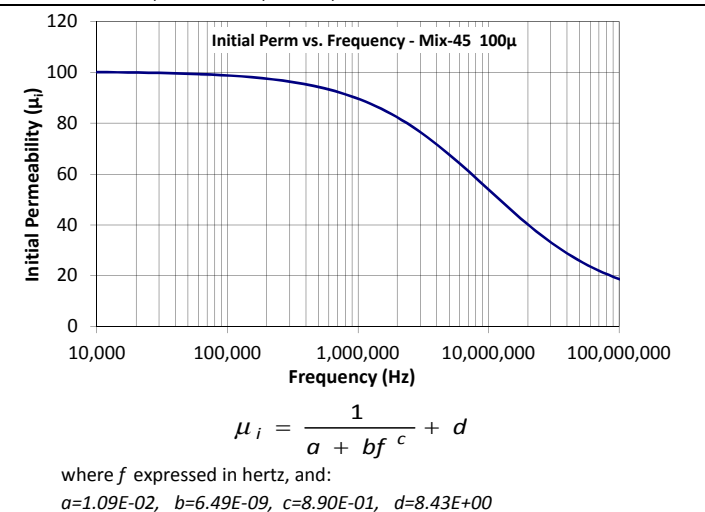
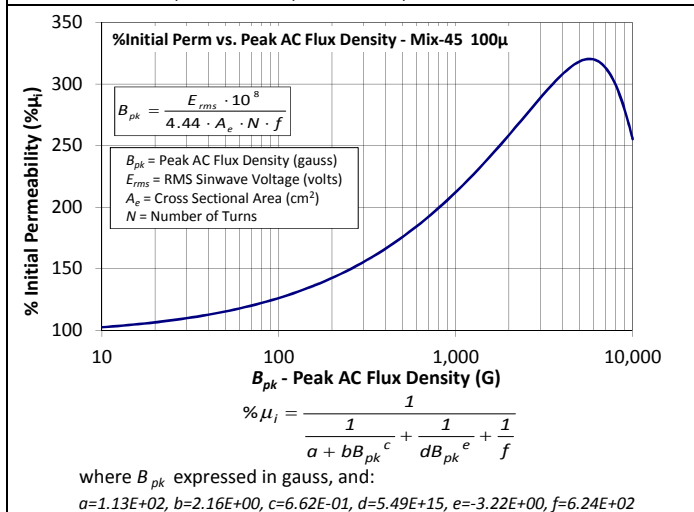
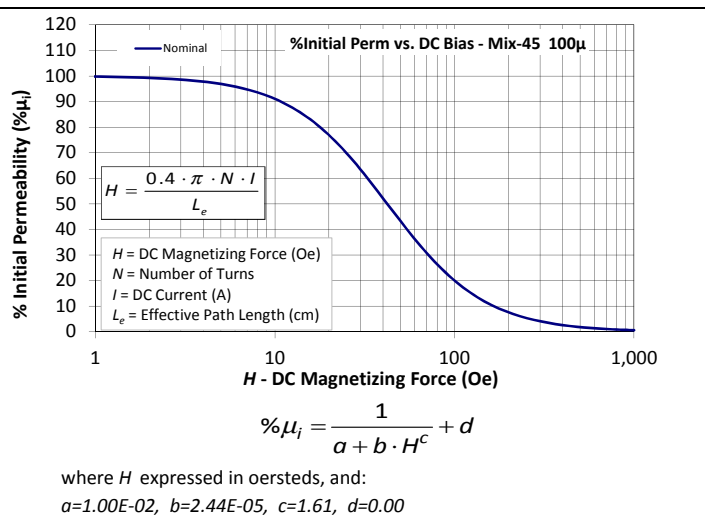
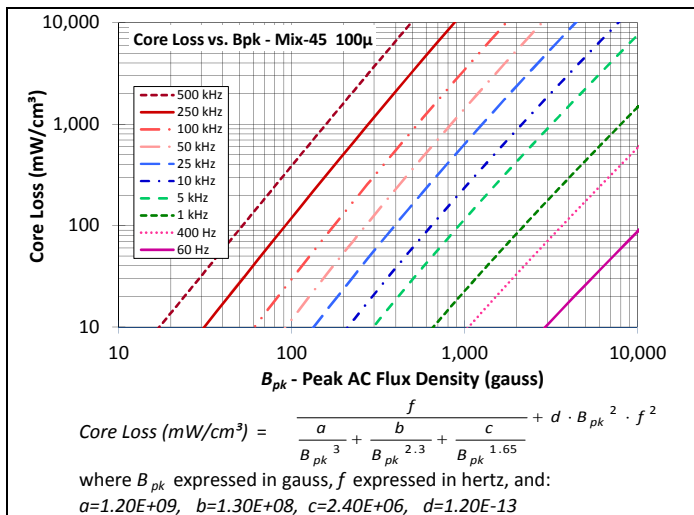

-52 material has the same permeability as the -26 material but has lower core losses at high frequency making it popular for high frequency choke designs. -52 is available in a wide variety of geometries, including highly complex and custom shapes.

Mix:	-52
Revision 20160429 - Generated 2016-May-02	
μ (reference)	75
Color Code	Green/Blue
Density	7.0 g/cm ³
Bsat	18.5kG
Core Loss (100kHz, 140g)	58 mW/cm ³ (nom) 67 mW/cm ³ (max)
%Perm at DC Bias (50 Oe)	61.6% (nom) 53.4% (min)

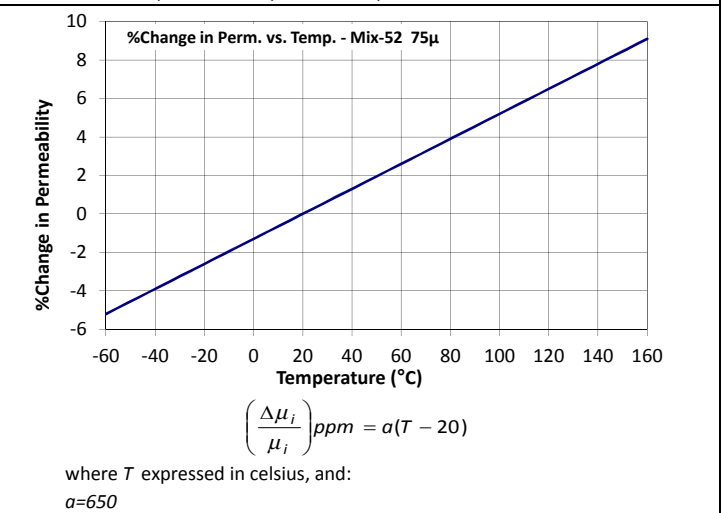
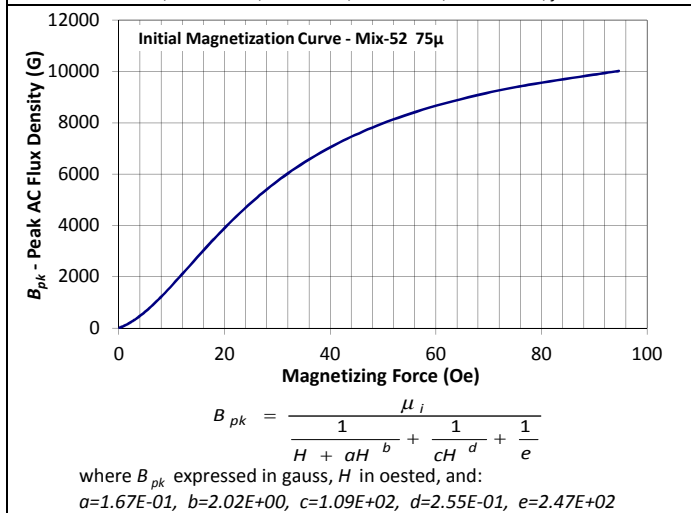
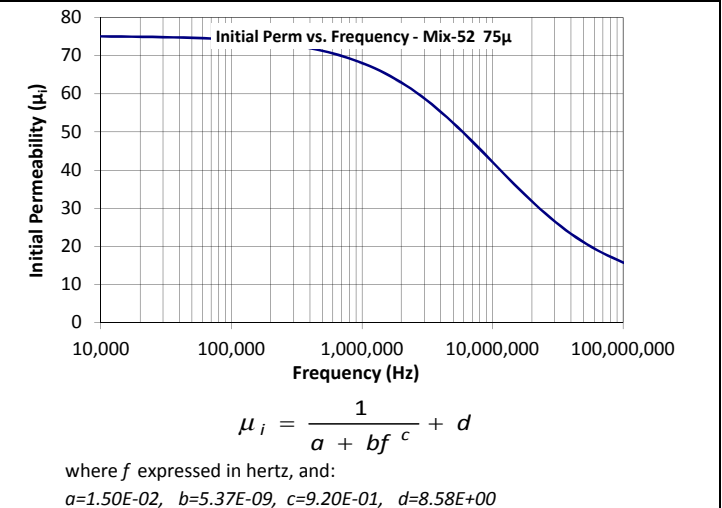
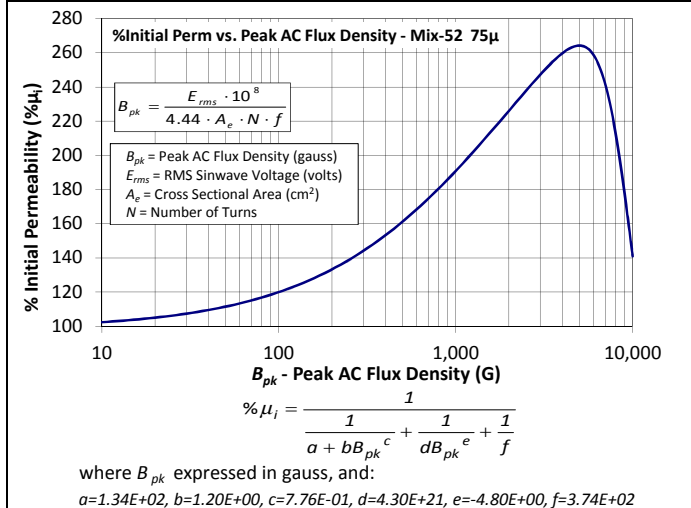
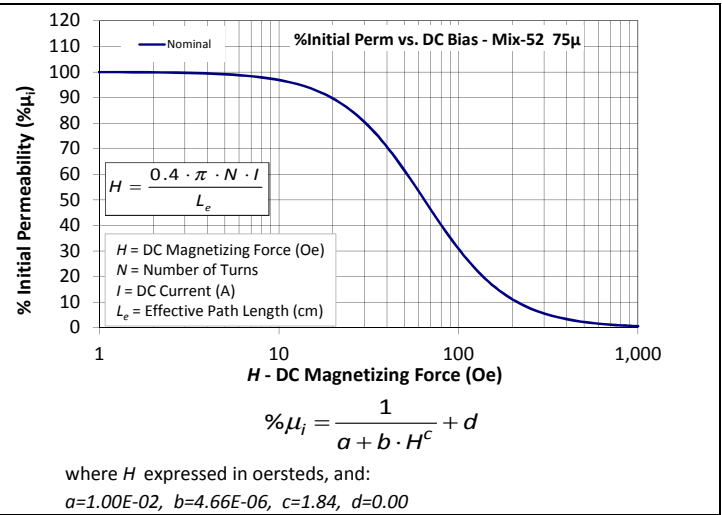
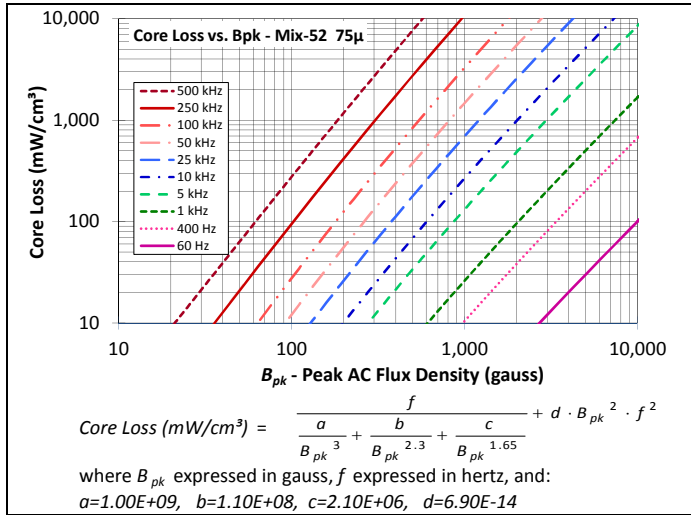

Mix:

-60

Revision 20171219 - Generated 2017-Dec-21

The **-60 Material** has 55 permeability and can be considered as a high temperature substitute for -18 material.

-60 material exhibits low core losses with higher permeability at a lower cost. Good DC saturation characteristics.

μ (reference)	55
Color Code	Brown/Black
Density	6.1 g/cm ³
Bsat	14.4kG
Core Loss (100kHz, 140g)	52 mW/cm ³ (nom) 59 mW/cm ³ (max)
%Perm at DC Bias (100 Oe)	49.3% (nom) 43.2% (min)

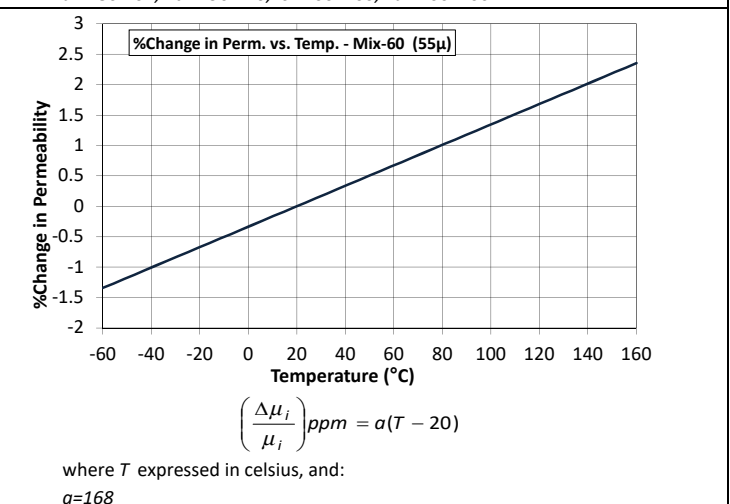
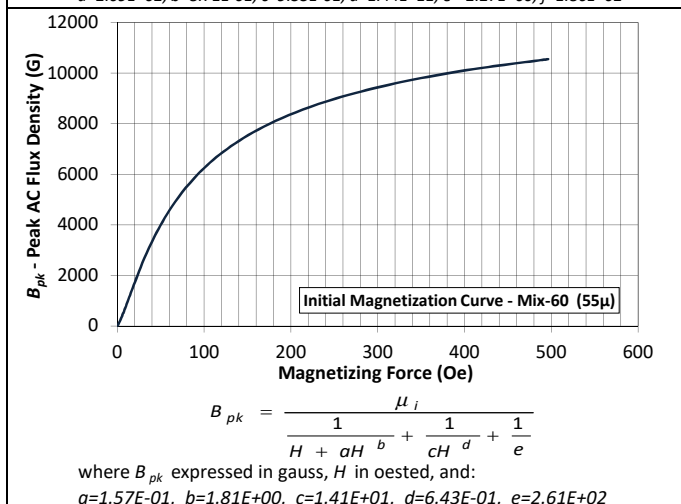
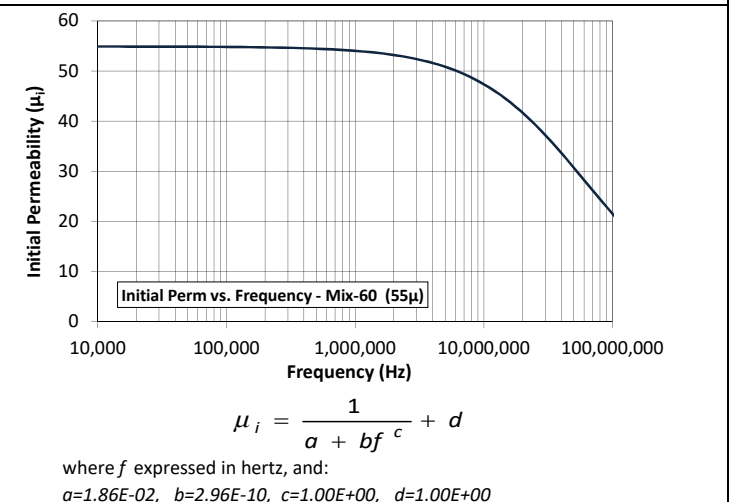
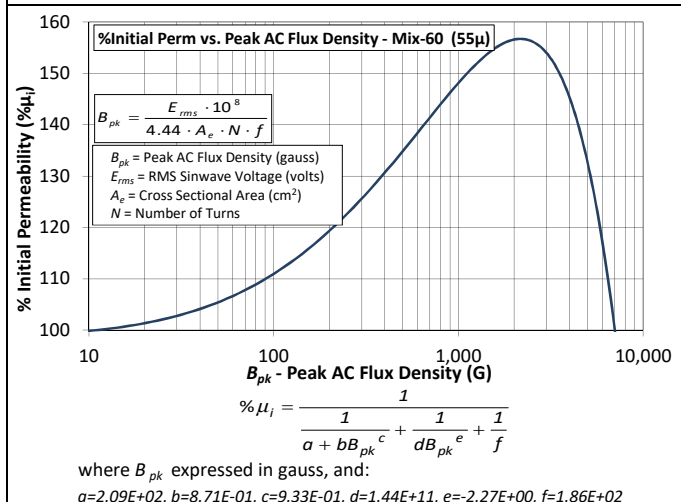
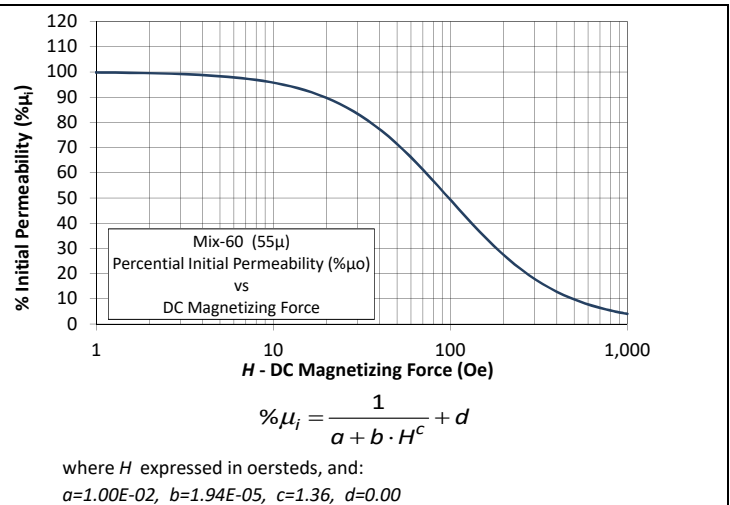
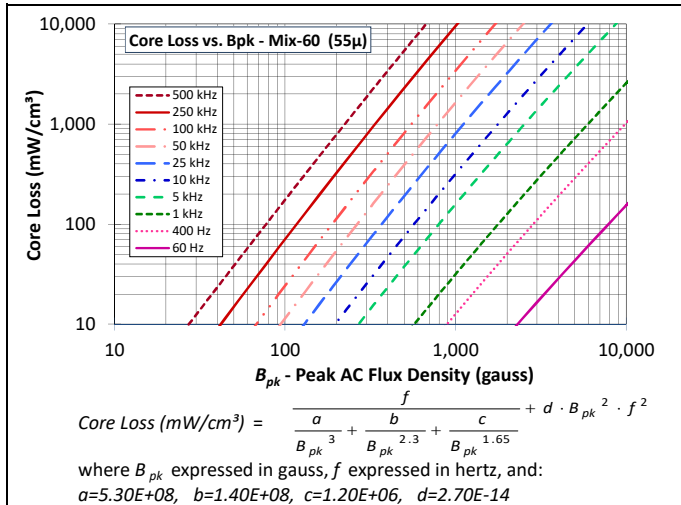

-61 material has an initial permeability of 35, and has excellent high frequency properties allowing operation past 10MHz. -61 material exhibits no thermal aging under 200C.

Mix:	-61
Revision 20171219 - Generated 2017-Dec-21	
μ (reference)	38
Color Code	Brown/Gray
Density	6.1 g/cm ³
Bsat	14.4kG
Core Loss (100kHz, 140g)	69 mW/cm ³ (nom) 79 mW/cm ³ (max)
%Perm at DC Bias (100 Oe)	68.8% (nom) 63.1% (min)

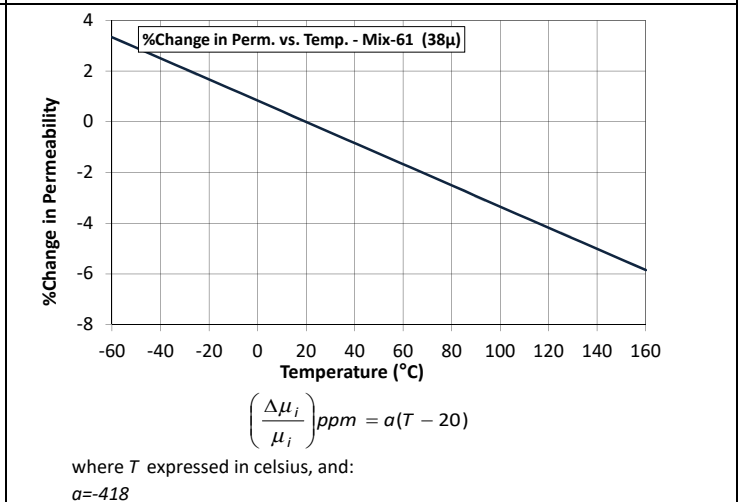
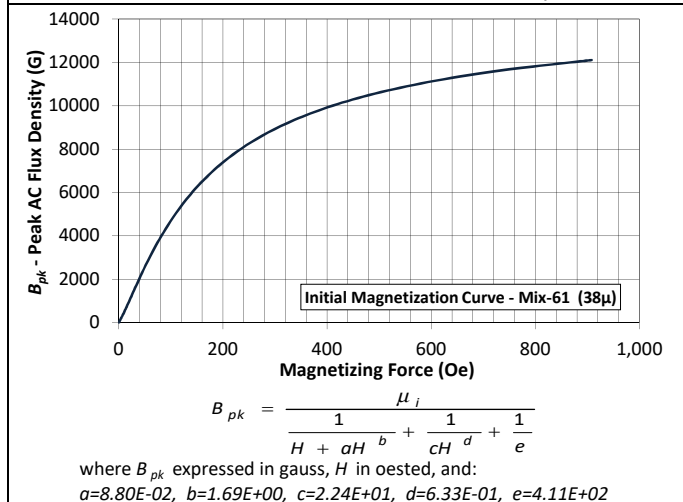
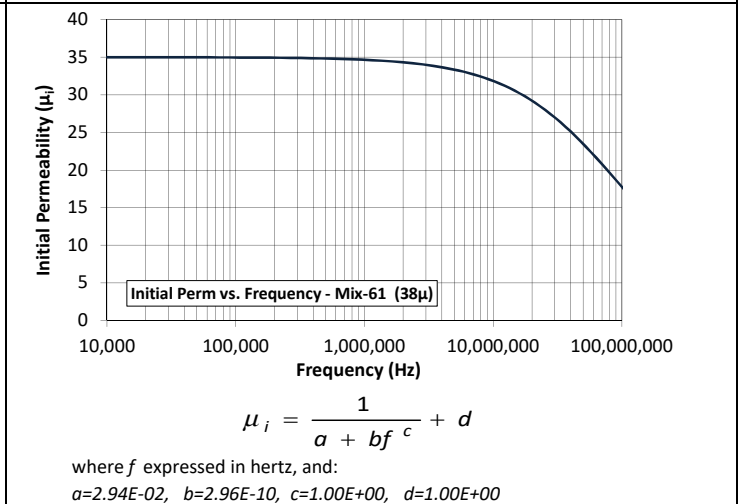
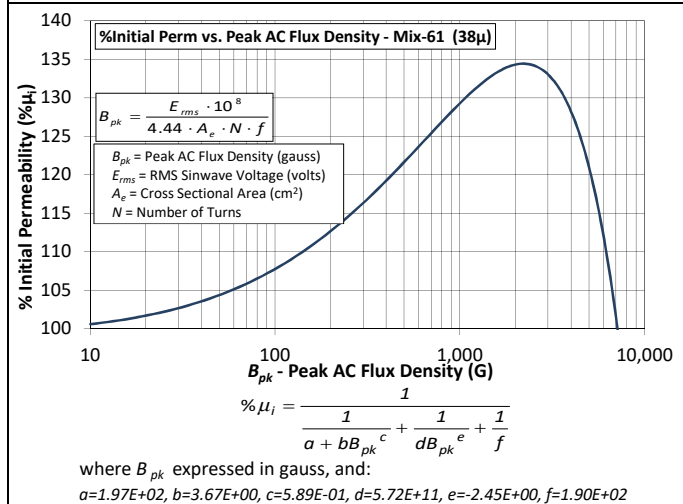
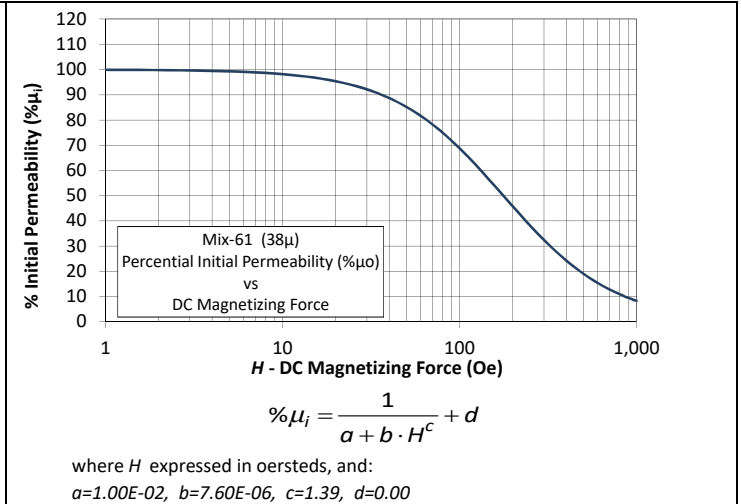
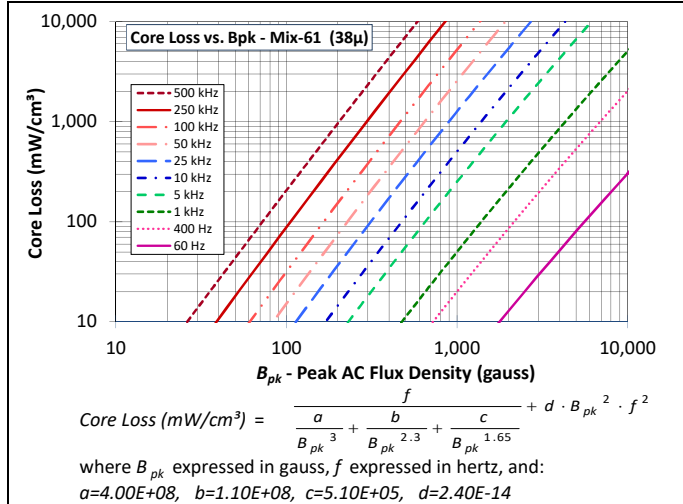

-63 material has an initial permeability of 35, excellent high frequency properties, and can be used in applications past 10MHz. -63 Material can be considered for high temperature alternate to -8 Material. -63 materials experiences no thermal aging under 200C.

Mix:	-63
Revision 20171219 - Generated 2017-Dec-21	
μ (reference)	35
Color Code	Brown/Beige
Density	5.9 g/cm ³
Bsat	14.1kG
Core Loss (100kHz, 140g)	31 mW/cm ³ (nom) 35 mW/cm ³ (max)
%Perm at DC Bias (200 Oe)	51.7% (nom) 46.1% (min)

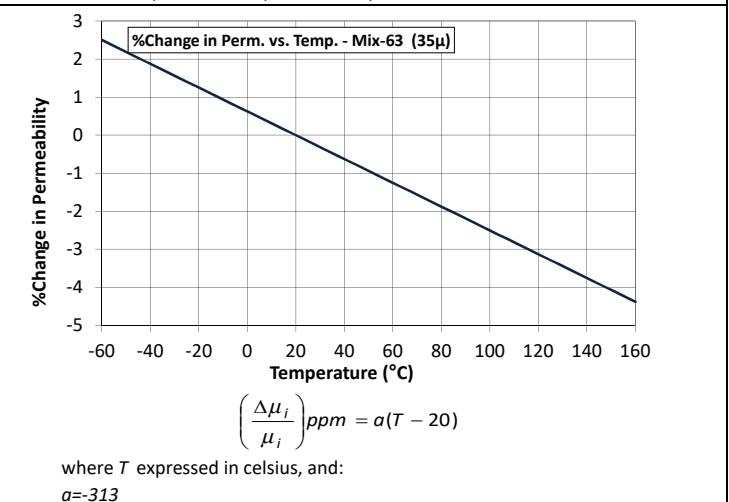
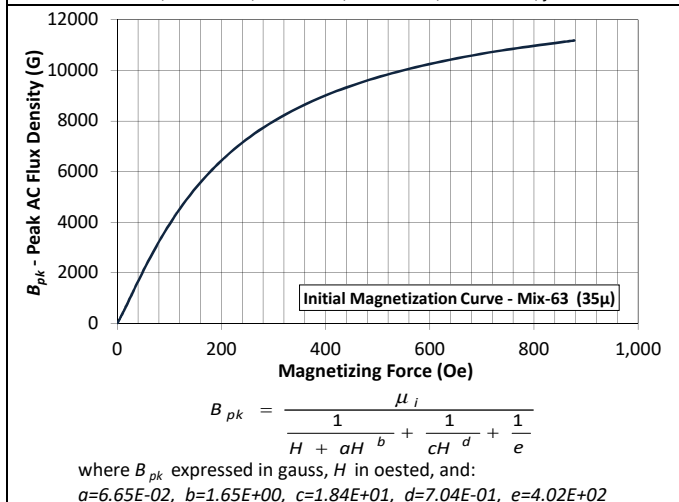
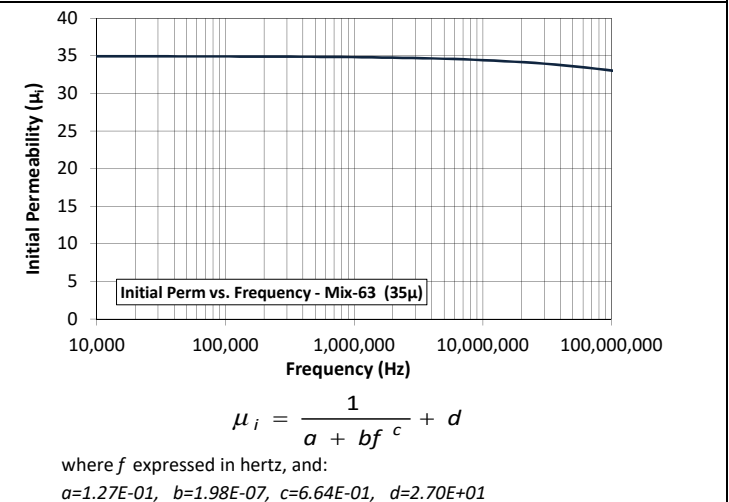
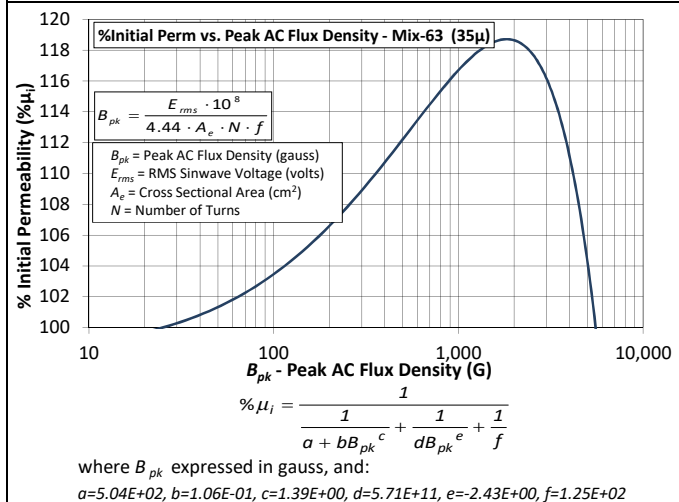
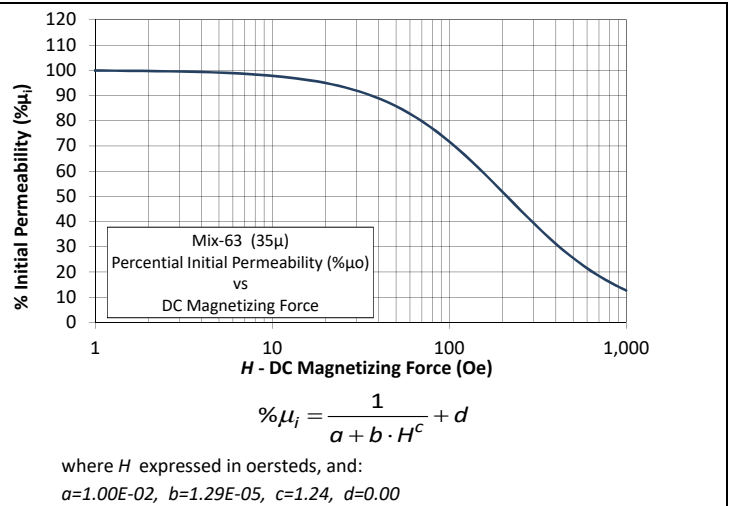
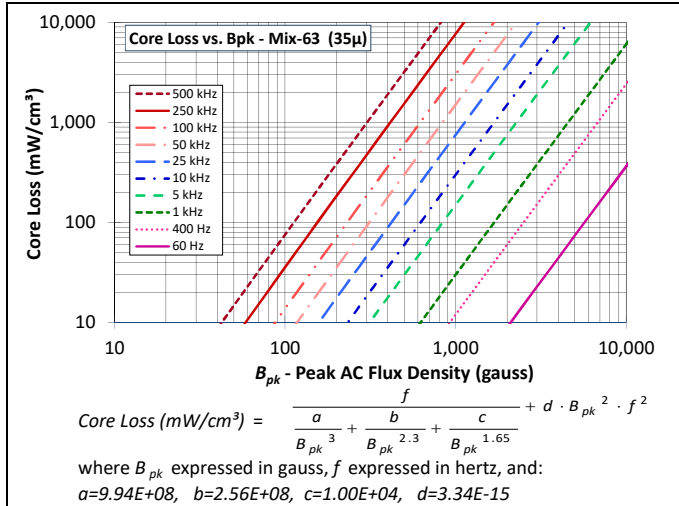

-65 material offers a permeability of 42 and is most popular in Microcube geometries. It offers higher core losses at high frequencies compared to -66 Material but with better DC saturation. No thermal aging concerns.

Mix:	-65
-------------	------------

Revision 20171219 - Generated 2017-Dec-21

μ (reference)	42
Color Code	Brown/Yellow
Density	6.1 g/cm ³
Bsat	16.0kG
Core Loss (100kHz, 140g)	33 mW/cm ³ (nom) 38 mW/cm ³ (max)
%Perm at DC Bias (100 Oe)	62.1% (nom) 55.5% (min)

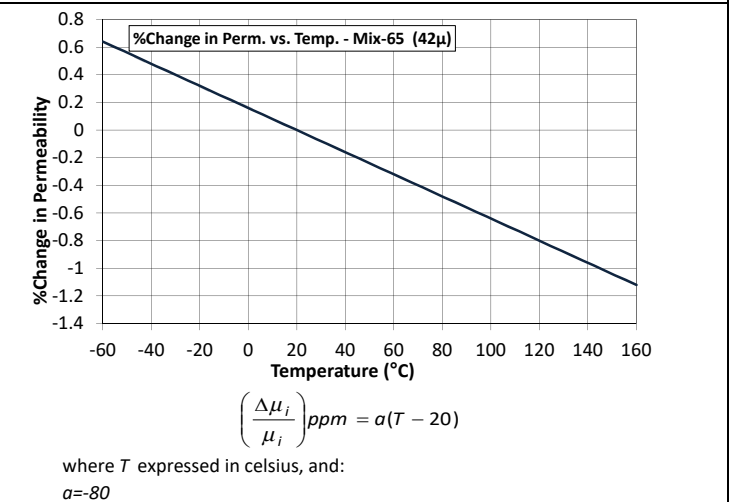
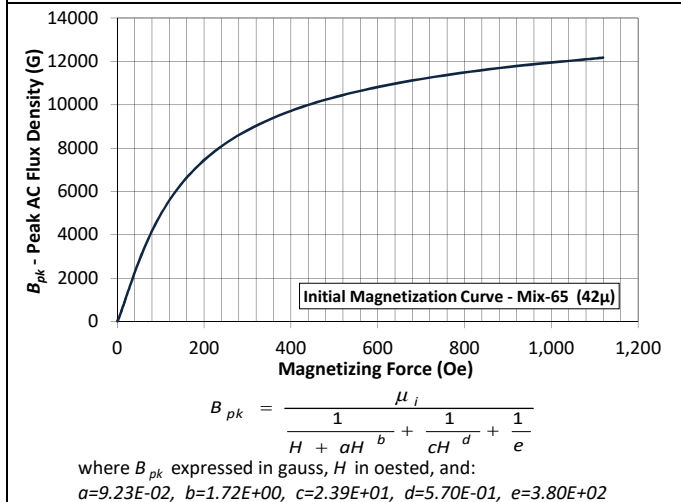
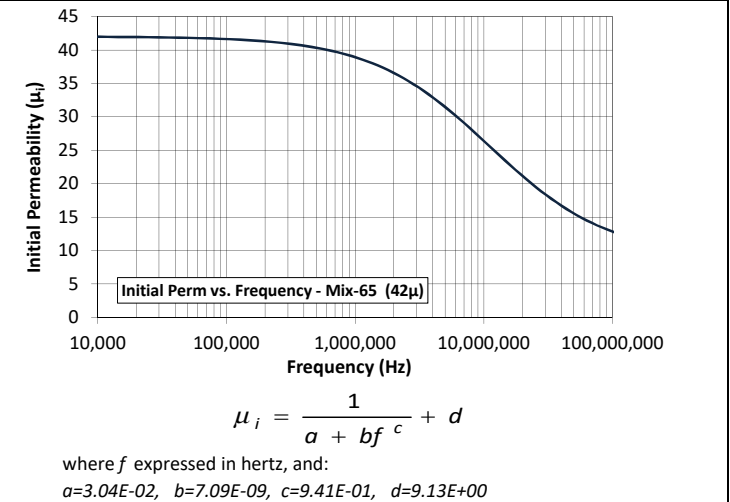
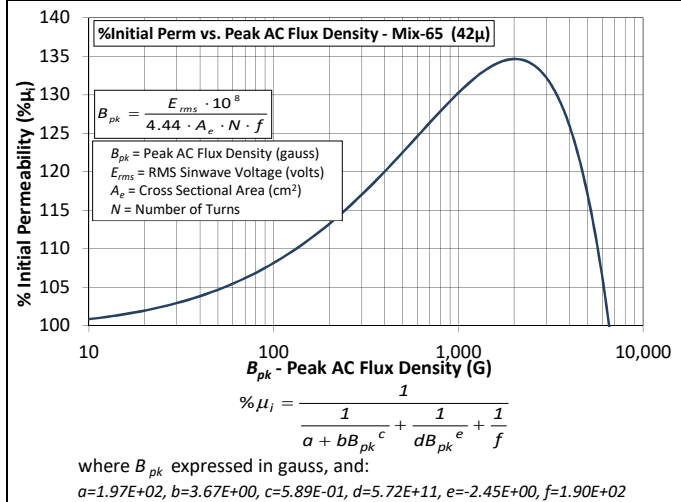
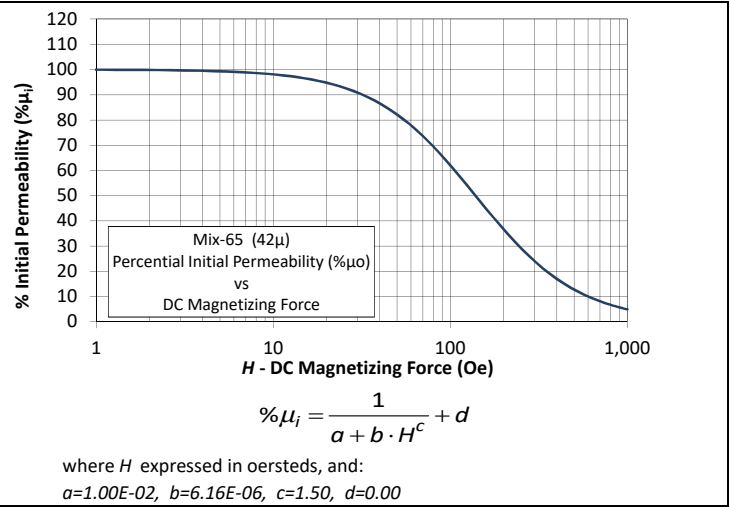
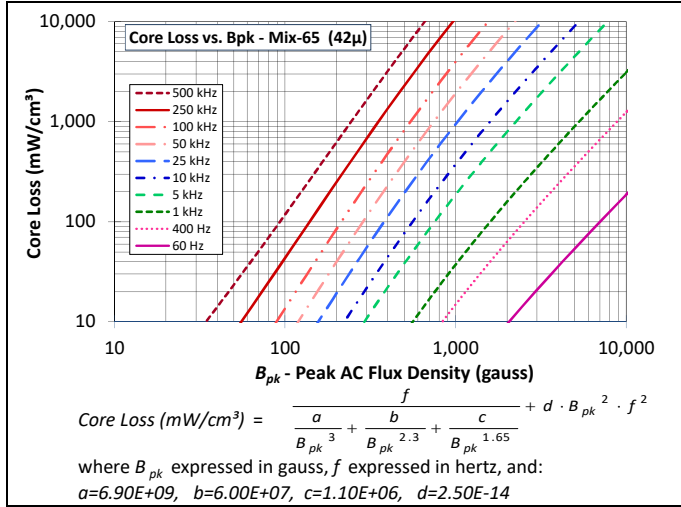

-66 material offers low core losses and is well suited from 100kHz to 500kHz. -66 material experiences no thermal aging under 200C.

Mix:	-66
Revision 20160429 - Generated 2016-Jun-09	
μ_i (reference)	66
Color Code	Brown/Brown
Density	6.2 g/cm ³
Bsat	16.2kG
Core Loss (100kHz, 140g)	17 mW/cm ³ (nom) 20 mW/cm ³ (max)
%Perm at DC Bias (50 Oe)	71.0% (nom) 65.1% (min)

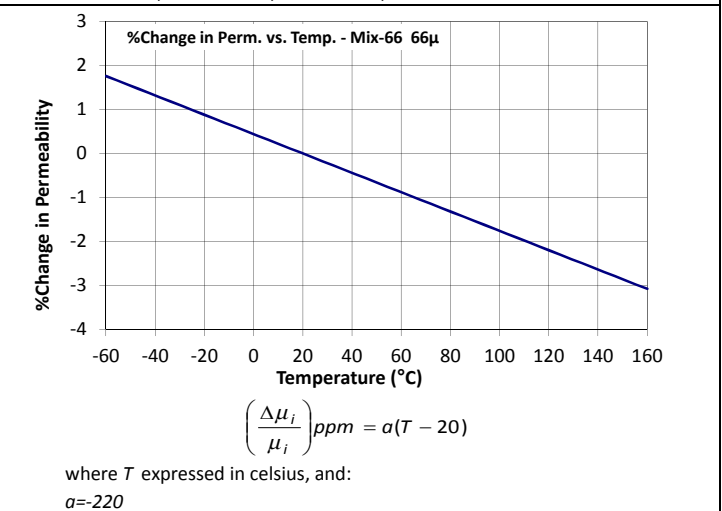
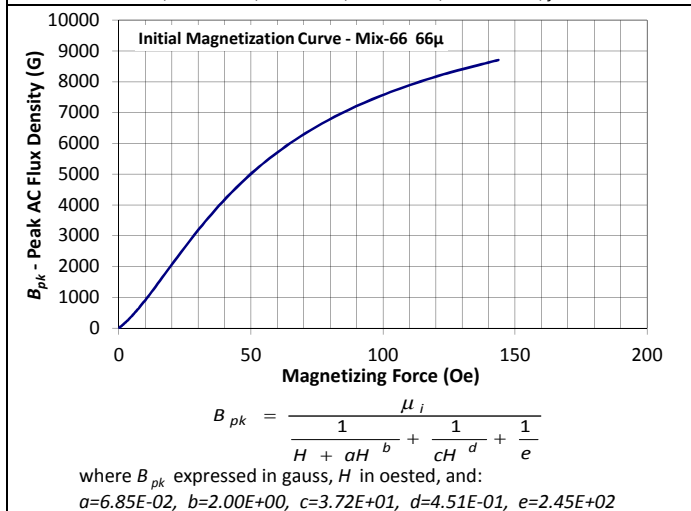
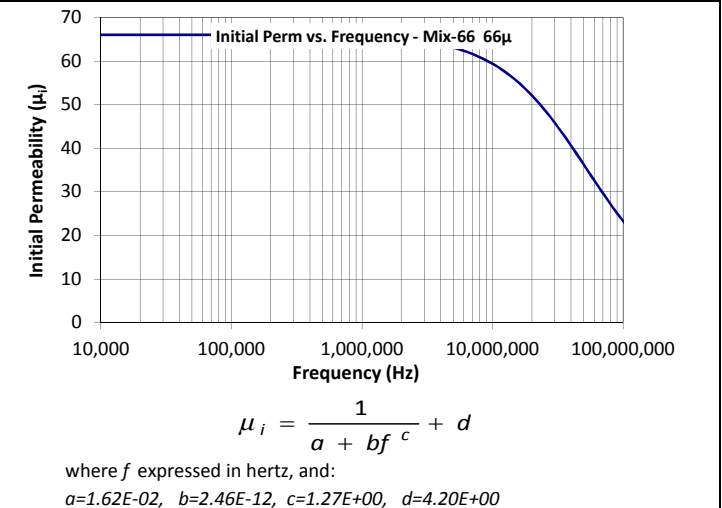
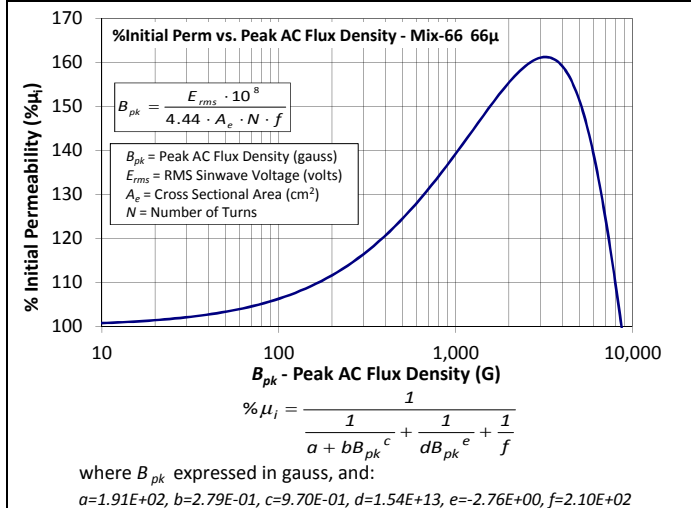
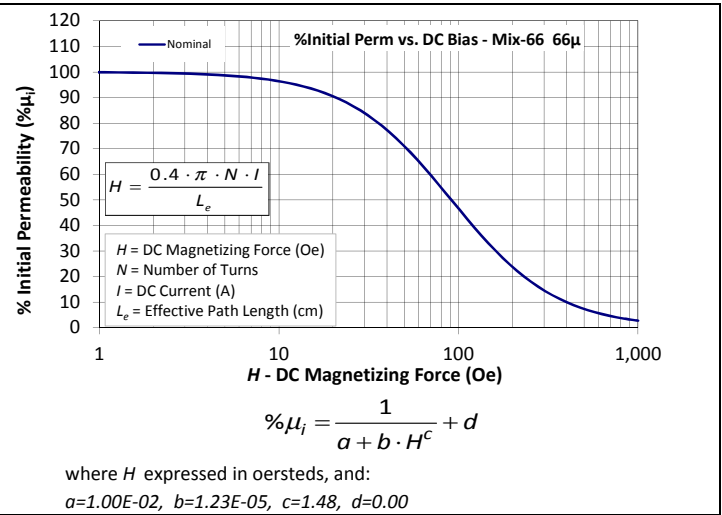
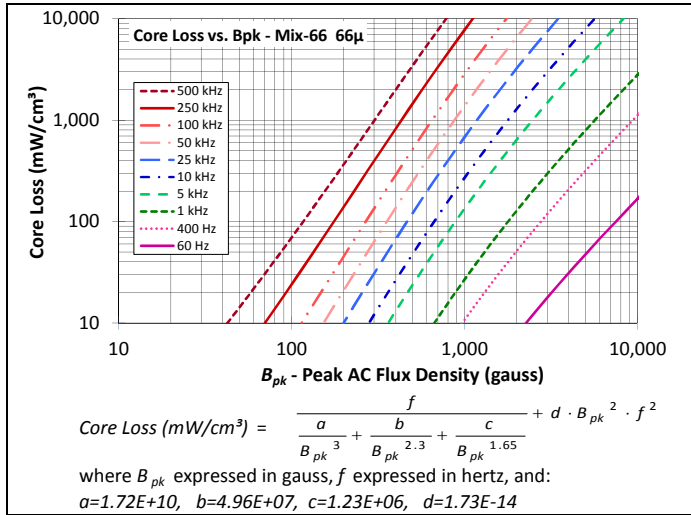

The **-70 material** has higher permeability than the 60 Series with excellent losses up to 400kHz. This is a relatively expensive material, most competitively priced in smaller sizes. No thermal aging concerns.

Mix:	-70
Revision 20160823 - Generated 2016-Aug-29	
μ_i (reference)	100
Color Code	Beige/Black
Density	7.4 g/cm ³
Bsat	8.6kG
Core Loss (100kHz, 140g)	13 mW/cm ³ (nom) 15 mW/cm ³ (max)
%Perm at DC Bias (50 Oe)	46.8% (nom) 39.4% (min)

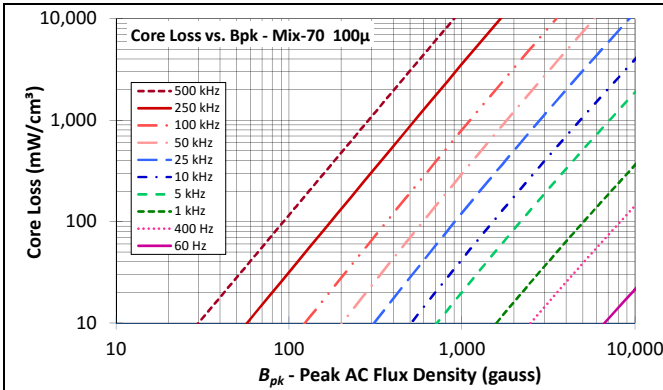

$$\text{Core Loss (mW/cm}^3\text{)} = \frac{f}{\frac{a}{B_{pk}^3} + \frac{b}{B_{pk}^{2.3}} + \frac{c}{B_{pk}^{1.65}}} + d \cdot B_{pk}^2 \cdot f^2$$

where B_{pk} expressed in gauss, f expressed in hertz, and:
 $a=1.00E+10$, $b=1.30E+09$, $c=7.90E+06$, $d=4.20E-14$

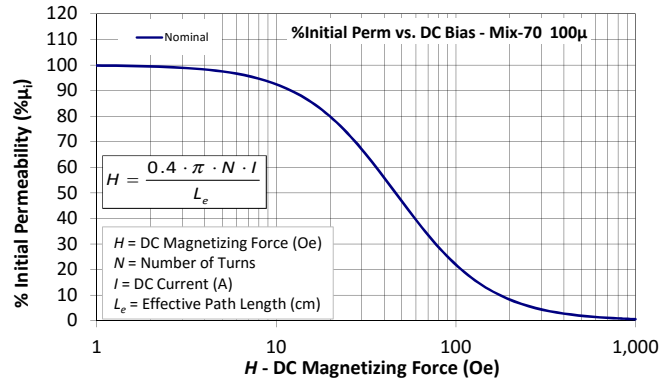

$$\% \mu_i = \frac{1}{a + b \cdot H^c} + d$$

where H expressed in oersteds, and:
 $a=1.00E-02$, $b=1.85E-05$, $c=1.64$, $d=0.00$

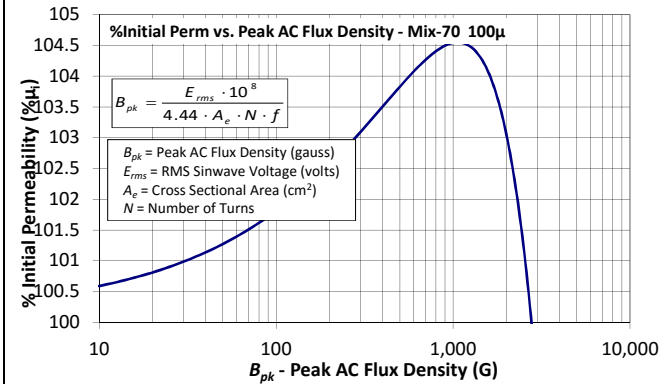

$$\% \mu_i = \frac{1}{\frac{1}{a + bB_{pk}^c} + \frac{1}{dB_{pk}^e} + \frac{1}{f}}$$

where B_{pk} expressed in gauss, and:
 $a=6.29E+02$, $b=4.10E+00$, $c=6.20E-01$, $d=1.76E+10$, $e=-2.07E+00$, $f=1.19E+02$

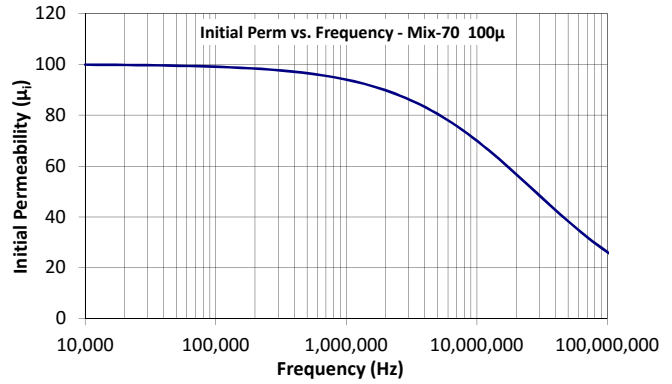

$$\mu_i = \frac{1}{a + bf^c} + d$$

where f expressed in hertz, and:
 $a=1.01E-02$, $b=7.01E-09$, $c=8.28E-01$, $d=1.00E+00$

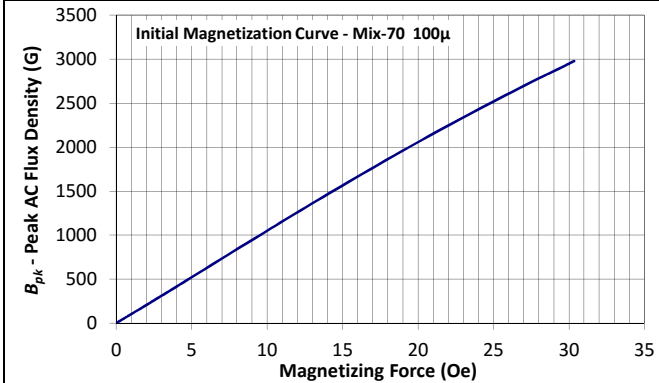

$$B_{pk} = \frac{\mu_i}{\frac{1}{H + aH^b} + \frac{1}{cH^d} + \frac{1}{e}}$$

where B_{pk} expressed in gauss, H in oested, and:
 $a=2.75E-02$, $b=1.85E+00$, $c=1.40E+09$, $d=2.27E-04$, $e=8.59E+01$

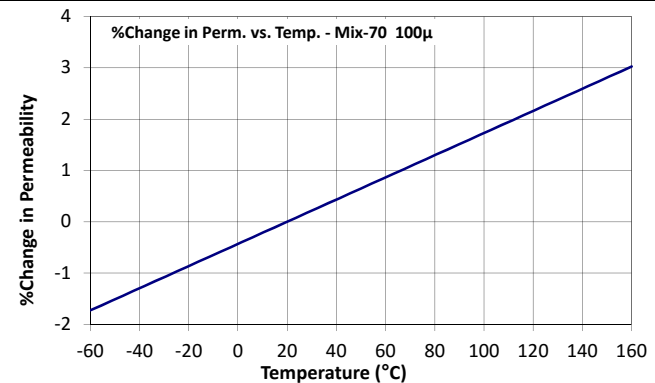

$$\left(\frac{\Delta \mu_i}{\mu_i} \right) ppm = a(T - 20)$$

where T expressed in celsius, and:
 $a=216$

-M125 material this is a molypermalloy powder material and will have the highest permeability and lowest losses below 200kHz. Similar to the -70 Material in cost, the -M125 material will be most competitively priced in smaller sizes.

Mix:	-M125
Revision 20171027 - Generated 2017-Nov-08	
μ_i (reference)	125
Color Code	Lt.Blue/Lt.Blue
Density	7.7 g/cm ³
Bsat	8.8KG
Core Loss (100kHz, 140g)	13 mW/cm ³ (nom)
	15 mW/cm ³ (max)
%Perm at DC Bias (50 Oe)	43.9% (nom)
	34.5% (min)

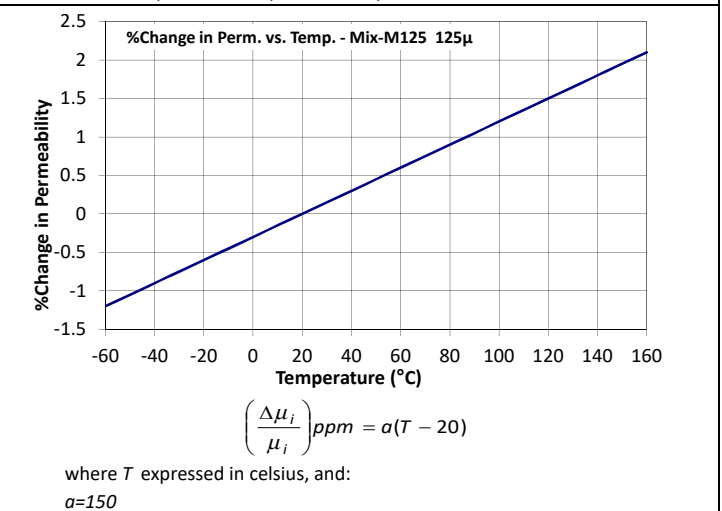
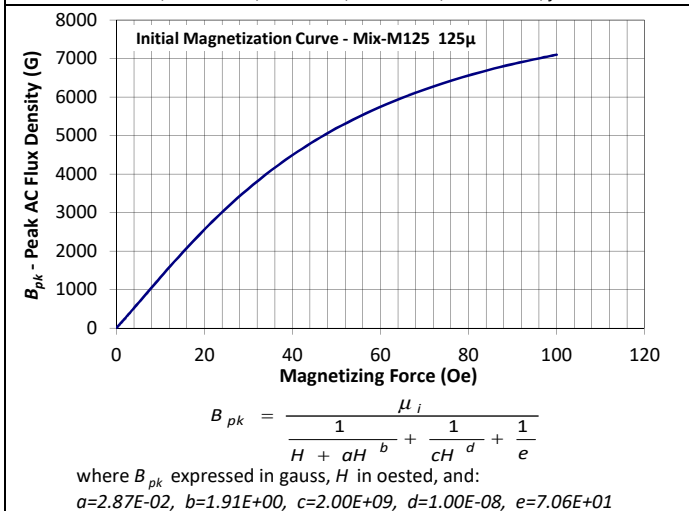
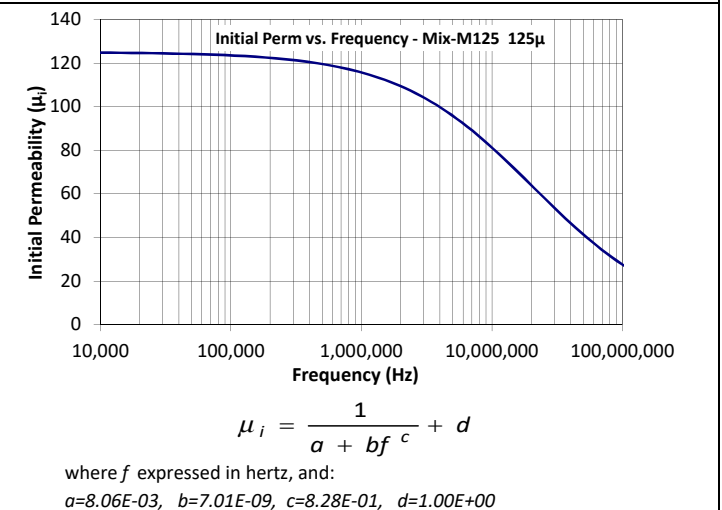
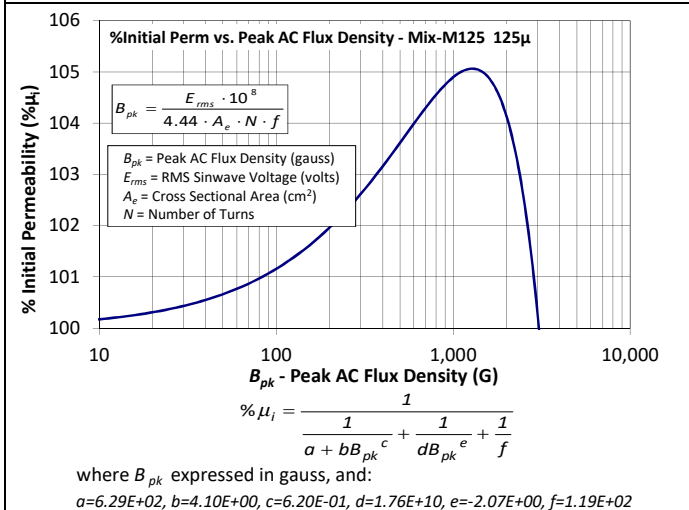
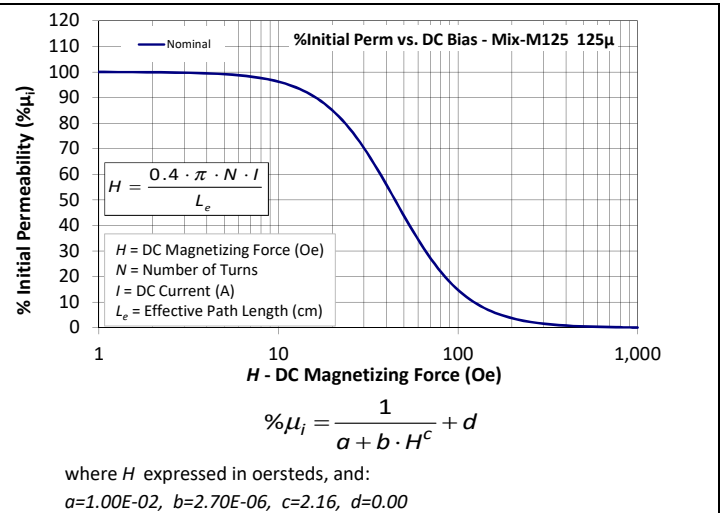
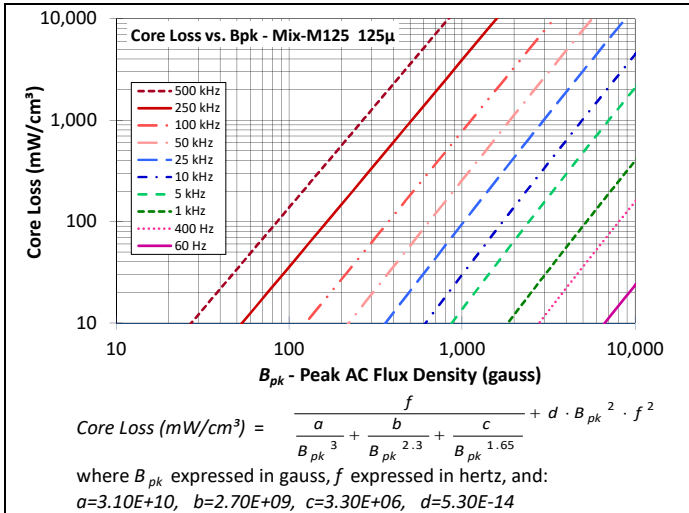

Curve Fit Coefficients Table

Percent Perm vs. H

$$\% \mu = \frac{1}{a + bH^c} + d$$

=1/(a+b*H^2)+d
H expressed in Oe
%Perm vs. DC Sat. Coef.

Core Loss vs. Bpk and Frequency

$$CL(mW/cm^3) = \frac{f}{\frac{a}{B^3} + \frac{b}{B^{2.3}} + \frac{c}{B^{1.65}}} + d \cdot B^2 \cdot f^2$$

=f/(a/B^3+b/B^2.3+c/B^1.65)+d*B^2*f^2
B expressed in G, f expressed in Hz
Core Loss Coefficients

Material	Init. Perm. (μ)	a	b	c	d	a	b	c	d
1	20	1.00E-02	1.14E-06	1.43E+00	0.00E+00	1.90E+09	2.00E+08	9.00E+05	4.30E-15
2	10	1.00E-02	1.83E-07	1.46E+00	0.00E+00	4.00E+09	3.00E+08	2.70E+06	9.60E-16
3	35	1.00E-02	3.49E-06	1.43E+00	0.00E+00	1.90E+09	2.00E+08	9.00E+05	4.30E-15
4	9	1.00E-02	1.83E-07	1.46E+00	0.00E+00	4.00E+09	3.00E+08	2.70E+06	8.00E-15
5	5	1.00E-02	1.34E-08	1.55E+00	0.00E+00	4.00E+09	3.00E+08	2.70E+06	8.00E-15
6	8.5	1.00E-02	4.87E-08	1.57E+00	0.00E+00	4.00E+09	3.00E+08	2.70E+06	8.90E-16
7	9	1.00E-02	1.48E-07	1.46E+00	0.00E+00	4.00E+09	3.00E+08	2.70E+06	9.60E-16
8	35	1.00E-02	3.49E-06	1.43E+00	0.00E+00	1.90E+09	2.00E+08	9.00E+05	5.00E-15
10	6	1.00E-02	5.54E-09	1.69E+00	0.00E+00	4.00E+09	3.00E+08	2.70E+06	8.00E-16
12	4	1.00E-02	1.34E-08	1.55E+00	0.00E+00	4.00E+09	3.00E+08	2.70E+06	4.40E-16
14	14	1.00E-02	3.90E-07	1.46E+00	0.00E+00	4.00E+09	3.00E+08	2.70E+06	1.92E-15
15	25	1.00E-02	1.78E-06	1.43E+00	0.00E+00	1.90E+09	2.00E+08	9.00E+05	5.00E-15
17	4	1.00E-02	1.34E-08	1.55E+00	0.00E+00	4.00E+09	3.00E+08	2.70E+06	4.40E-16
18	55	1.00E-02	4.72E-06	1.65E+00	0.00E+00	8.00E+08	1.70E+08	9.00E+05	3.10E-14
19	55	1.00E-02	3.60E-06	1.69E+00	0.00E+00	1.90E+09	8.40E+07	2.10E+06	5.00E-14
26	75	1.00E-02	9.70E-06	1.72E+00	0.00E+00	1.00E+09	1.10E+08	1.90E+06	1.90E-13
28	22	1.00E-02	4.10E-06	1.34E+00	0.00E+00	3.00E+08	3.20E+07	1.90E+06	3.10E-13
30	22	1.00E-02	4.10E-06	1.34E+00	0.00E+00	3.30E+08	2.00E+07	2.00E+06	1.10E-13
33	33	1.00E-02	3.00E-06	1.54E+00	0.00E+00	3.40E+08	2.00E+07	2.00E+06	3.70E-13
34	33	1.00E-02	3.00E-06	1.54E+00	0.00E+00	1.10E+09	3.30E+07	2.50E+06	7.70E-14
35	33	1.00E-02	6.22E-06	1.38E+00	0.00E+00	3.70E+08	2.20E+07	2.20E+06	1.10E-13
38	85	1.00E-02	9.78E-06	1.76E+00	0.00E+00	1.20E+09	1.30E+08	1.90E+06	3.20E-13
40	60	1.00E-02	8.93E-06	1.61E+00	0.00E+00	1.10E+09	3.30E+07	2.50E+06	3.10E-13
45	100	1.00E-02	2.44E-05	1.61E+00	0.00E+00	1.20E+09	1.30E+08	2.40E+06	1.20E-13
46	75	1.00E-02	1.83E-05	1.43E+00	0.00E+00	1.00E+09	1.10E+08	2.10E+06	9.00E-14
52	75	1.00E-02	4.66E-06	1.84E+00	0.00E+00	1.00E+09	1.10E+08	2.10E+06	6.90E-14
60	55	1.00E-02	1.94E-05	1.36E+00	0.00E+00	5.30E+08	1.40E+08	1.20E+06	2.70E-14
61	38	1.00E-02	7.60E-06	1.39E+00	0.00E+00	4.00E+08	1.10E+08	5.10E+05	2.40E-14
63	35	1.00E-02	1.29E-05	1.24E+00	0.00E+00	9.94E+08	2.56E+08	1.00E+04	3.34E-15
65	42	1.00E-02	6.16E-06	1.50E+00	0.00E+00	6.90E+09	6.00E+07	1.10E+06	2.50E-14
66	66	1.00E-02	1.23E-05	1.48E+00	0.00E+00	1.72E+10	4.96E+07	1.23E+06	1.73E-14
70	100	1.00E-02	1.85E-05	1.64E+00	0.00E+00	1.00E+10	1.30E+09	7.90E+06	4.20E-14

Percent Perm vs. Bpk

Permeability vs. Frequency

$$\% \mu = \left(\frac{a + cB + eB^2}{1 + bB + dB^2} \right)^{1/2}$$

$= ((a+c*B+e*B^2)/(1+b*B+d*B^2))^0.5$
 B expressed in G
 %Perm. vs. AC Flux Density Coefficients

$$\mu = \frac{1}{a + bf^c} + d$$

$= 1/(a+b*f^c)+d$
 f expressed in Hz
 Perm vs. Frequency Coefficients

Material	Init. Perm. (μ)	a	b	c	d	e	a	b	c	d
1	20	1.00E+04	4.44E-04	1.13E+01	9.30E-09	-8.18E-04	2.19E-01	1.98E-07	6.64E-01	1.54E+01
2	10	1.00E+04	4.81E-04	6.19E+00	-7.67E-08	-1.03E-03	1.11E-01	7.01E-11	9.00E-01	1.00E+00
3	35	1.00E+04	4.44E-04	1.13E+01	9.30E-09	-8.18E-04	1.27E-01	1.98E-07	6.64E-01	2.70E+01
4	9	1.00E+04	4.81E-04	6.19E+00	-7.67E-08	-1.03E-03	1.25E-01	7.01E-11	9.00E-01	1.00E+00
5	5	1.00E+04	4.81E-04	6.19E+00	-7.67E-08	-1.03E-03	2.50E-01	7.01E-11	9.00E-01	1.00E+00
6	8.5	1.00E+04	4.81E-04	6.19E+00	-7.67E-08	-1.03E-03	1.33E-01	7.01E-11	9.00E-01	1.00E+00
7	9	1.00E+04	4.81E-04	6.19E+00	-7.67E-08	-1.03E-03	1.25E-01	7.01E-11	9.00E-01	1.00E+00
8	35	1.00E+04	4.44E-04	1.13E+01	9.30E-09	-8.18E-04	1.27E-01	1.98E-07	6.64E-01	2.70E+01
10	6	1.00E+04	4.81E-04	6.19E+00	-7.67E-08	-1.03E-03	2.00E-01	7.01E-11	9.00E-01	1.00E+00
12	4	1.00E+04	4.81E-04	6.19E+00	-7.67E-08	-1.03E-03	3.33E-01	7.01E-11	9.00E-01	1.00E+00
14	14	1.00E+04	4.81E-04	6.19E+00	-7.67E-08	-1.03E-03	8.67E-02	1.45E-15	1.52E+00	2.47E+00
15	25	1.00E+04	4.44E-04	1.13E+01	9.30E-09	-8.18E-04	1.75E-01	1.98E-07	6.64E-01	1.93E+01
17	4	1.00E+04	4.81E-04	6.19E+00	-7.67E-08	-1.03E-03	3.33E-01	7.01E-11	9.00E-01	1.00E+00
18	55	1.00E+04	1.65E-04	1.40E+01	2.12E-08	-1.02E-03	1.82E-02	1.70E-11	1.11E+00	0.00E+00
19	55	1.00E+04	1.65E-04	1.40E+01	2.12E-08	-1.02E-03	1.82E-02	4.50E-11	1.11E+00	0.00E+00
26	75	1.00E+04	9.30E-05	3.98E+01	-9.62E-09	-3.74E-03	1.46E-02	4.13E-08	8.47E-01	7.15E+00
28	22	1.00E+04	1.92E-03	4.48E+01	1.85E-07	-1.76E-03	9.31E-02	5.25E-08	9.13E-01	1.13E+01
30	22	1.00E+04	1.92E-03	4.48E+01	1.85E-07	-1.76E-03	6.63E-02	4.20E-09	9.55E-01	6.93E+00
33	33	1.00E+04	1.58E-03	4.61E+01	-4.74E-08	-3.85E-03	3.99E-02	3.82E-08	8.79E-01	8.04E+00
34	33	1.00E+04	1.58E-03	4.61E+01	-4.74E-08	-3.85E-03	4.72E-02	2.39E-09	9.84E-01	1.18E+01
35	33	1.00E+04	1.58E-03	4.61E+01	-4.74E-08	-3.85E-03	4.18E-02	7.09E-09	9.41E-01	9.13E+00
38	85	1.00E+04	2.12E-04	3.89E+01	-1.32E-08	-2.98E-03	1.28E-02	1.04E-07	7.71E-01	7.71E+00
40	60	1.00E+04	2.84E-04	4.68E+01	-2.76E-08	-4.33E-03	1.86E-02	5.98E-08	8.23E-01	6.64E+00
45	100	1.00E+04	1.57E-04	4.76E+01	-9.57E-09	-3.68E-03	1.09E-02	6.49E-09	8.90E-01	8.43E+00
46	75	1.00E+04	2.24E-04	3.90E+01	-1.95E-08	-3.85E-03	1.50E-02	5.37E-09	9.20E-01	8.58E+00
52	75	1.00E+04	2.24E-04	3.90E+01	-1.95E-08	-3.85E-03	1.50E-02	5.37E-09	9.20E-01	8.58E+00
60	55	1.00E+04	4.47E-04	2.65E+01	8.11E-08	-2.11E-03	1.86E-02	2.96E-10	1.00E+00	1.00E+00
61	38						2.94E-02	2.96E-10	1.00E+00	1.00E+00
63	35						1.27E-01	1.98E-07	6.64E-01	2.70E+01
65	42						3.04E-02	7.09E-09	9.41E-01	9.13E+00
66	66	1.00E+04	4.64E-05	1.21E+01	3.27E-08	-1.01E-03	1.62E-02	2.46E-12	1.27E+00	4.20E+00
70	100	1.00E+04	1.39E-03	1.75E+01	-2.43E-09	-1.29E-03	1.01E-02	7.01E-09	8.28E-01	1.00E+00

Initial BH Curve

$$B = \frac{\mu}{\frac{1}{H + a \cdot H^b} + \frac{1}{c \cdot H^d} + \frac{1}{e}}$$

= $\mu / (1 / (H + a \cdot H^b) + 1 / (c \cdot H^d) + 1 / e)$
 B, Bsat expressed in G, H expressed in Oe
 B vs H Coefficients

Perm vs. Temperature

MS, FS, OP:

$$\% \left(\frac{\Delta\mu}{\mu_i} \right) = \frac{a + cT + eT^2}{1 + bT + dT^2}$$

Others:

$$\% \left(\frac{\Delta\mu}{\mu_i} \right) = a(T - 20) \cdot 0.0001$$

T expressed in Celsius

Material	Init. Perm. (μ)	a	b	c	d	e	Bsat	Hc typ. (oe)	Br typ. (G)	Density (g/cm ³)	a
1	20	2.69E-02	1.75E+00	4.65E+01	5.67E-01	8.73E+02	17454	6.9	138	6.40	280
2	10	1.50E-03	1.96E+00	1.97E+04	9.18E-04	1.48E+03	14806	3.0	30	5.00	95
3	35	4.11E-02	1.75E+00	3.64E+01	5.64E-01	5.04E+02	17636	6.9	242	6.50	255
4	9	1.35E-03	1.96E+00	2.19E+04	9.18E-04	1.65E+03	14806	3.0	27	5.00	280
5	5	7.71E-04	1.96E+00	3.98E+04	9.23E-04	2.96E+03	14806	3.0	15	5.00	95
6	8.5	1.28E-03	1.96E+00	2.30E+04	9.19E-04	1.74E+03	14806	3.0	26	5.00	35
7	9	1.35E-03	1.96E+00	2.19E+04	9.18E-04	1.65E+03	14806	3.0	27	5.00	30
8	35	4.36E-02	1.74E+00	3.26E+01	5.86E-01	5.04E+02	17636	6.9	242	6.50	255
10	6	9.13E-04	1.96E+00	3.83E+04	9.23E-04	2.43E+03	14608	3.0	18	4.90	150
12	4	6.20E-04	1.96E+00	7.71E+04	9.31E-04	3.60E+03	14408	3.0	12	4.80	170
14	14	2.90E-03	1.91E+00	5.26E+02	4.97E-01	1.09E+03	15198	3.0	42	5.20	150
15	25	3.18E-02	1.75E+00	4.23E+01	5.67E-01	6.98E+02	17454	6.9	172	6.40	190
17	4	6.20E-04	1.96E+00	7.71E+04	9.31E-04	3.60E+03	14408	3.0	12	4.80	50
18	55	6.81E-02	1.92E+00	3.25E+01	5.27E-01	3.24E+02	17816	7.4	407	6.60	385
19	55	7.24E-02	1.92E+00	2.81E+01	5.51E-01	3.30E+02	18174	4.8	264	6.80	650
26	75	1.66E-01	2.09E+00	2.35E+02	1.20E-01	2.47E+02	18529	5.0	375	7.00	825
28	22	1.88E-01	1.51E+00	7.56E+00	8.06E-01	7.60E+02	16719	5.8	128	6.00	415
30	22	1.87E-01	1.52E+00	7.61E+00	8.05E-01	7.60E+02	16719	5.6	123	6.00	510
33	33	1.84E-01	1.60E+00	9.56E+00	7.95E-01	5.23E+02	17272	5.6	185	6.30	565
34	33	1.85E-01	1.59E+00	9.52E+00	7.99E-01	5.18E+02	17089	4.4	145	6.20	565
35	33	1.81E-01	1.60E+00	9.75E+00	7.91E-01	5.23E+02	17272	5.1	168	6.30	665
38	85	2.18E-01	2.00E+00	3.41E+01	6.46E-01	2.20E+02	18705	4.8	408	7.10	956
40	60	1.88E-01	1.98E+00	3.20E+01	6.65E-01	3.06E+02	18352	4.4	264	6.90	950
45	100	3.06E-01	2.06E+00	3.92E+01	5.95E-01	1.89E+02	18880	4.0	400	7.20	1043
46	75	1.67E-01	2.02E+00	1.10E+02	2.49E-01	2.52E+02	18880	4.6	345	7.20	650
52	75	1.67E-01	2.02E+00	1.09E+02	2.55E-01	2.47E+02	18529	4.6	345	7.00	650
60	55	1.57E-01	1.81E+00	1.41E+01	6.43E-01	2.61E+02	14377	6.7	368	6.10	168
61	38	8.80E-02	1.69E+00	2.24E+01	6.33E-01	4.11E+02	15609	12.4	471	6.10	-418
63	35	6.65E-02	1.65E+00	1.84E+01	7.04E-01	4.02E+02	14061	11.4	399	5.90	-313
65	42	9.23E-02	1.72E+00	2.39E+01	5.70E-01	3.80E+02	15978	8.3	349	6.10	-80
66	66	6.85E-02	2.00E+00	3.72E+01	4.51E-01	2.45E+02	16152	7.3	482	6.20	-220
70	100	2.75E-02	1.85E+00	1.40E+09	2.27E-04	8.59E+01	8594	0.9	90	7.40	216

Toroid

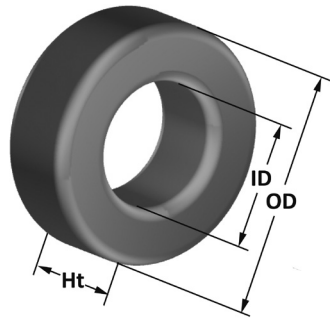

Typical Part Number: **T 106 - 26 B /**

Toroidal Geometry
 OD in 100th inches
 Micrometals Material Mix No.
 Letter Indicates Alternate Height
 Code Area For Other Characteristics

Part Number	Physical Dimensions			Magnetic Dimensions			AL (nH/N ²)	Ref. Perm.	Material	Product Group		
	OD (in/mm)	ID (in/mm)	HT (in/mm)	Ae (cm ²)	le (cm)	Ve (cm ³)				RF	PC	200C
T5-0	0.050 / 1.27	0.025 / 0.64	0.025 / 0.64	0.0019	0.300	0.000600	0.16	1	-0	✓		
T5-17							0.42	4	-17	✓		
T5-10							0.7	6	-10	✓		
T5-6							1	8.5	-6	✓		
T7-0	0.070 / 1.78	0.035 / 0.89	0.030 / 0.76	0.0035	0.420	0.00150	0.3	1	-0	✓		
T7-17							0.6	4	-17	✓		
T7-10							0.9	6	-10	✓		
T7-6							1.3	8.5	-6	✓		
T7-2							1.35	10	-2	✓	✓	
T10-0	0.097 / 2.46	0.044 / 1.12	0.030 / 0.76	0.0045	0.560	0.00250	0.24	1	-0	✓		
T10-17							0.5	4	-17	✓		
T10-10							0.8	6	-10	✓		
T10-6							1.15	8.5	-6	✓		
T10-2							1.35	10	-2	✓	✓	
T10-10B	0.097 / 2.46	0.044 / 1.12	0.050 / 1.27	0.0075	0.560	0.00420	1.25	6	-10	✓		
T10-2B							1.8	10	-2	✓	✓	
T12-10A	0.125 / 3.18	0.062 / 1.57	0.030 / 0.76	0.0057	0.750	0.00430	0.72	6	-10	✓		
T12-6A							1.02	8.5	-6	✓		
T12-10B	0.125 / 3.18	0.062 / 1.57	0.042 / 1.07	0.008	0.750	0.00610	1	6	-10	✓		
T12-6B							1.35	8.5	-6	✓		
T12-2B							1.62	10	-2	✓	✓	
T12-0	0.125 / 3.18	0.062 / 1.57	0.050 / 1.27	0.01	0.750	0.00770	0.24	1	-0	✓		
T12-17							0.75	4	-17	✓		
T12-10							1.2	6	-10	✓		
T12-6							1.7	8.5	-6	✓		
T12-2							2	10	-2	✓	✓	
T12-26							13	75	-26			✓
T12-45							16	100	-45			✓
T14-6	0.135 / 3.43	0.067 / 1.70	0.042 / 1.07	0.0084	0.810	0.00680	1.26	8.5	-6	✓		
T14-52A	0.135 / 3.43	0.067 / 1.70	0.060 / 1.52	0.012	0.810	0.00980	11.5	75	-52			✓
T14-45A							16.5	100	-45			✓
T16-0	0.160 / 4.06	0.078 / 1.98	0.060 / 1.52	0.015	0.930	0.0141	0.3	1	-0	✓		
T16-17							0.8	4	-17	✓		
T16-10							1.3	6	-10	✓		
T16-6							1.9	8.5	-6	✓		
T16-2							2.2	10	-2	✓	✓	
T16-15							5.5	25	-15	✓		
T16-3							6.1	35	-3	✓		
T16-60							9.5	55	-60			✓
T16-18							9.5	55	-18			✓
T16-26							14.5	75	-26			✓
T16-52							13.5	75	-52			✓
T16-45							17	100	-45			✓
T18-6	0.185 / 4.70	0.102 / 2.59	0.040 / 1.02	0.01	1.14	0.0114	0.9	8.5	-6	✓		
T20-0	0.200 / 5.08	0.088 / 2.24	0.070 / 1.78	0.023	1.15	0.0260	0.35	1	-0	✓		
T20-17							1	4	-17	✓		
T20-10							1.6	6	-10	✓		

Toroid

(continued)

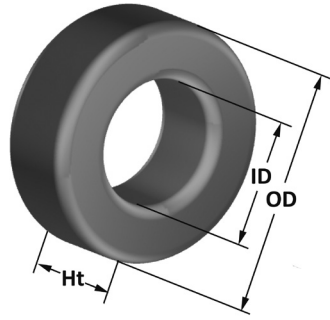

Typical Part Number: **T 106 - 26 B /**

Toroidal Geometry → T
 OD in 100th inches → 106
 Micrometals Material Mix No. → 26
 Letter Indicates Alternate Height → B
 Code Area For Other Characteristics → /

Part Number	Physical Dimensions			Magnetic Dimensions			AL (nH/N ²)	Ref. Perm.	Material	Product Group		
	OD (in/mm)	ID (in/mm)	HT (in/mm)	Ae (cm ²)	le (cm)	Ve (cm ³)				RF	PC	200C
T20-6	0.200 / 5.08	0.088 / 2.24	0.070 / 1.78	0.023	1.15	0.0260	2.2	8.5	-6	✓		
T20-2							2.5	10	-2	✓	✓	
T20-15							6.5	25	-15	✓		
T20-8/90							7.8	35	-8	✓	✓	
T20-63							7.8	35	-63			✓
T20-18							13	55	-18		✓	
T20-40							16	60	-40		✓	
T20-66							15.5	66	-66			✓
T20-26							18.5	75	-26		✓	
T20-52							17.5	75	-52		✓	
T20-70							22.5	100	-70			✓
T20-52E	0.200 / 5.08	0.088 / 2.24	0.210 / 5.33	0.069	1.15	0.0780	52.4	75	-52		✓	
T22-0A	0.223 / 5.66	0.097 / 2.46	0.096 / 2.44	0.037	1.28	0.0470	0.51	1	-0	✓		
T22-10A							2.2	6	-10	✓		
T22-17A							2.2	6	-10	✓		
T22-0	0.223 / 5.66	0.097 / 2.46	0.143 / 3.63	0.052	1.28	0.0670	0.71	1	-0	✓		
T22-17							2	4	-17	✓		
T22-10							3.2	6	-10	✓		
T22-6							4.5	8.5	-6	✓		
T22-52							38.5	75	-52			✓
T22-26							38.5	75	-26			✓
T25-6A	0.255 / 6.48	0.120 / 3.05	0.065 / 1.65	0.027	1.50	0.0400	1.8	8.5	-6	✓		
T25-52A							14.9	75	-52			✓
T25-0	0.255 / 6.48	0.120 / 3.05	0.096 / 2.44	0.037	1.50	0.0550	0.45	1	-0	✓		
T25-17							1.2	4	-17	✓		
T25-10							1.9	6	-10	✓		
T25-6							2.7	8.5	-6	✓		
T25-2							3.4	10	-2	✓	✓	
T25-15							8.5	25	-15	✓		
T25-63							10	35	-63			✓
T25-3							10	35	-3	✓		
T25-18							17	55	-18		✓	
T25-66							20	66	-66			✓
T25-52							23	75	-52		✓	
T25-26							24.5	75	-26		✓	
T25-45							31	100	-45			✓
T26-8/90	0.265 / 6.73	0.105 / 2.67	0.190 / 4.83	0.09	1.47	0.133	24	35	-8	✓	✓	
T26-18							41.5	55	-18		✓	
T26-52							56	75	-52		✓	
T26-26							57	75	-26		✓	
T26-45							77	100	-45			✓
T27-0	0.280 / 7.11	0.151 / 3.84	0.128 / 3.25	0.047	1.71	0.0800	0.45	1	-0	✓		
T27-17							1.3	4	-17	✓		
T27-10							2.2	6	-10	✓		
T27-6							2.7	8.5	-6	✓		
T27-2							3.3	10	-2	✓	✓	

Toroid

(continued)

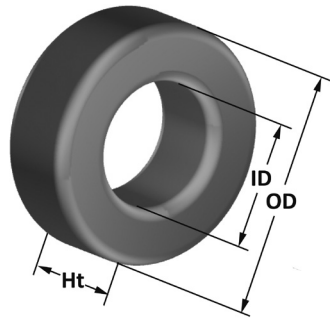

Typical Part Number: **T 106 - 26 B /**

Toroidal Geometry
 OD in 100th inches
 Micrometals Material Mix No.
 Letter Indicates Alternate Height
 Code Area For Other Characteristics

Part Number	Physical Dimensions			Magnetic Dimensions			AL (nH/N ²)	Ref. Perm.	Material	Product Group		
	OD (in/mm)	ID (in/mm)	HT (in/mm)	Ae (cm ²)	le (cm)	Ve (cm ³)				RF	PC	200C
T27-8/90	0.280 / 7.11	0.151 / 3.84	0.128 / 3.25	0.047	1.71	0.0800	11.5	35	-8	✓	✓	
T27-18							18.5	55	-18			✓
T27-52							25.5	75	-52			✓
T27-26							27.5	75	-26			✓
T30-52A	0.307 / 7.80	0.151 / 3.84	0.070 / 1.78	0.033	1.83	0.0610	16.5	75	-52			✓
T30-6B	0.307 / 7.80	0.151 / 3.84	0.080 / 2.03	0.038	1.83	0.0700	2.3	8.5	-6	✓		
T30-0	0.307 / 7.80	0.151 / 3.84	0.128 / 3.25	0.06	1.84	0.110	0.6	1	-0	✓		
T30-17							1.6	4	-17	✓		
T30-10							2.5	6	-10	✓		
T30-6							3.6	8.5	-6	✓		
T30-7							3.7	9	-7	✓		
T30-2							4.3	10	-2	✓	✓	
T30-8/90							14	35	-8	✓	✓	
T30-63							14	35	-63			✓
T30-18							22	55	-18			✓
T30-66							26.5	66	-66			✓
T30-52							30.5	75	-52			✓
T30-26							33.5	75	-26			✓
T32-52	0.327 / 8.31	0.169 / 4.29	0.158 / 4.01	0.073	1.96	0.144	35	75	-52			✓
T37-52C	0.375 / 9.53	0.205 / 5.21	0.096 / 2.44	0.05	2.31	0.116	18	75	-52			✓
T37-0	0.375 / 9.53	0.205 / 5.21	0.128 / 3.25	0.064	2.31	0.147	0.49	1	-0	✓		
T37-17							1.5	4	-17	✓		
T37-10							2.5	6	-10	✓		
T37-6							3	8.5	-6	✓		
T37-7							3.2	9	-7	✓		
T37-2							4	10	-2	✓	✓	
T37-1							8	20	-1	✓		
T37-15							9	25	-15	✓		
T37-8/90							12	35	-8	✓	✓	
T37-63							12	35	-63			✓
T37-3							12	35	-3	✓		
T37-18							19	55	-18			✓
T37-66							22.5	66	-66			✓
T37-52							26	75	-52			✓
T37-26							28.5	75	-26			✓
T37-45							34	100	-45			✓
T38-2	0.375 / 9.53	0.175 / 4.45	0.190 / 4.83	0.114	2.18	0.248	7.4	10	-2	✓	✓	
T38-63							22.5	35	-63			✓
T38-8/90							20	35	-8	✓	✓	
T38-18							36	55	-18			✓
T38-66							43	66	-66			✓
T38-26							49	75	-26			✓
T38-52							49	75	-52			✓
T38-45							65	100	-45			✓
T40-66	0.400 / 10.16	0.205 / 5.21	0.163 / 4.14	0.093	2.41	0.223	31.5	66	-66			✓
T40-52							36	75	-52			✓
T40-26							36	75	-26			✓

Toroid

(continued)

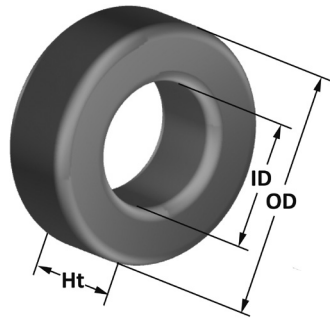

Typical Part Number: **T 106 - 26 B /**

Toroidal Geometry
 OD in 100th inches
 Micrometals Material Mix No.
 Letter Indicates Alternate Height
 Code Area For Other Characteristics

Part Number	Physical Dimensions			Magnetic Dimensions			AL (nH/N ²)	Ref. Perm.	Material	Product Group		
	OD (in/mm)	ID (in/mm)	HT (in/mm)	Ae (cm ²)	le (cm)	Ve (cm ³)				RF	PC	200C
T45-40	0.440 / 11.18	0.245 / 6.22	0.128 / 3.25	0.0765	2.73	0.209	22	60	-40			✓
T44-2A	0.440 / 11.18	0.229 / 5.82	0.128 / 3.25	0.08	2.68	0.215	3.6	10	-2	✓		✓
T44-0	0.440 / 11.18	0.229 / 5.82	0.159 / 4.04	0.099	2.68	0.266	0.65	1	-0	✓		
T44-17							1.85	4	-17	✓		
T44-10							3.3	6	-10	✓		
T44-6							4.2	8.5	-6	✓		
T44-7							4.6	9	-7	✓		
T44-2							5.2	10	-2	✓	✓	
T44-14							6.2	14	-14			✓
T44-15							16	25	-15	✓		
T44-8/90							18	35	-8	✓	✓	
T44-63							18	35	-63			✓
T44-18							25.5	55	-18		✓	
T44-66							30.5	66	-66			✓
T44-52							35	75	-52		✓	
T44-26							37	75	-26		✓	
T44-45							46.5	100	-45		✓	
T44-70							46.5	100	-70			✓
T44-52B	0.440 / 11.18	0.229 / 5.82	0.196 / 4.98	0.1225	2.68	0.328	43	75	-52		✓	
T44-52C	0.440 / 11.18	0.229 / 5.82	0.250 / 6.35	0.157	2.68	0.419	55	75	-52		✓	
T44-52D	0.440 / 11.18	0.229 / 5.82	0.338 / 8.59	0.212	2.68	0.567	70	75	-52		✓	
T50-0	0.500 / 12.70	0.303 / 7.70	0.190 / 4.83	0.112	3.19	0.358	0.64	1	-0	✓		
T50-17							1.8	4	-17	✓		
T50-10							3.1	6	-10	✓		
T50-6							4	8.5	-6	✓		
T50-7							4.3	9	-7	✓		
T50-2							4.9	10	-2	✓	✓	
T50-14							5.9	14	-14		✓	
T50-1							10	20	-1	✓		
T50-3							17.5	35	-3	✓		
T50-63							15.5	35	-63			✓
T50-8/90							17.5	35	-8	✓	✓	
T50-18							24	55	-18		✓	
T50-66							29	66	-66			✓
T50-26							33	75	-26		✓	
T50-52							33	75	-52		✓	
T50-70							44	100	-70			✓
T50-45							44	100	-45		✓	
T50-2B	0.500 / 12.70	0.303 / 7.70	0.250 / 6.35	0.148	3.19	0.471	6.1	10	-2	✓	✓	
T50-63B							20	35	-63			✓
T50-8B/90							23	35	-8	✓	✓	
T50-18B							32	55	-18		✓	
T50-66B							38	66	-66			✓
T50-52B							43.5	75	-52		✓	
T50-26B							43.5	75	-26		✓	
T50-45B							58	100	-45		✓	
T51-8C/90	0.500 / 12.70	0.200 / 5.08	0.250 / 6.35	0.233	2.79	0.622	37	35	-8	✓	✓	

Toroid

(continued)

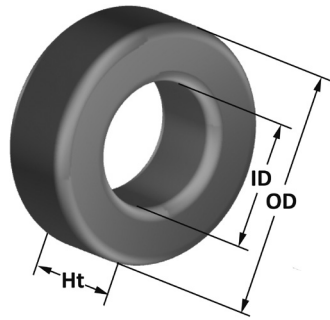

Typical Part Number: **T 106 - 26 B /**

Toroidal Geometry → T
 OD in 100th inches → 106
 Micrometals Material Mix No. → 26
 Letter Indicates Alternate Height → B
 Code Area For Other Characteristics → /

Part Number	Physical Dimensions			Magnetic Dimensions			AL (nH/N ²)	Ref. Perm.	Material	Product Group		
	OD (in/mm)	ID (in/mm)	HT (in/mm)	Ae (cm ²)	le (cm)	Ve (cm ³)				RF	PC	200C
T51-18C	0.500 / 12.70	0.200 / 5.08	0.250 / 6.35	0.233	2.79	0.622	55	55	-18			✓
T51-26C							83	75	-26			✓
T51-52C							75	75	-52			✓
T51-6B	0.500 / 12.70	0.200 / 5.08	0.312 / 7.92	0.282	2.79	0.786	10.2	8.5	-6	✓		
T51-2B							13.8	10	-2	✓		✓
T50-18C	0.500 / 12.70	0.303 / 7.70	0.335 / 8.51	0.2	3.19	0.637	43	55	-18			✓
T50-26C							61	75	-26			✓
T50-18D	0.500 / 12.70	0.303 / 7.70	0.375 / 9.53	0.223	3.19	0.711	48	55	-18			✓
T50-26D							72	75	-26			✓
T50-52D							66	75	-52			✓
T51-2A	0.500 / 12.70	0.200 / 5.08	0.375 / 9.53	0.345	2.79	0.963	16.6	10	-2	✓		✓
T51-0	0.500 / 12.70	0.200 / 5.08	0.500 / 12.70	0.46	2.79	1.28	2.6	1	-0	✓		
T51-6							16.4	8.5	-6	✓		
T57-52	0.573 / 14.55	0.273 / 6.93	0.196 / 4.98	0.178	3.38	0.601	49.5	75	-52			✓
T57-45							67	100	-45			✓
T57-52A	0.573 / 14.55	0.273 / 6.93	0.263 / 6.68	0.239	3.38	0.805	66	75	-52			✓
T57-45A							88	100	-45			✓
T60-0	0.600 / 15.24	0.336 / 8.53	0.234 / 5.94	0.187	3.74	0.699	0.88	1	-0	✓		
T60-17							2.6	4	-17	✓		
T60-10							4	6	-10	✓		
T60-6							5.5	8.5	-6	✓		
T60-2							6.5	10	-2	✓		✓
T60-14							8.3	14	-14			✓
T60-63							21.5	35	-63			✓
T60-8/90							19	35	-8	✓		✓
T60-60							34.5	55	-60			✓
T60-18							34.5	55	-18			✓
T60-66							41	66	-66			✓
T60-52							47	75	-52			✓
T60-26							50	75	-26			✓
T60-45							62	100	-45			✓
T60-8D/90	0.600 / 15.24	0.336 / 8.53	0.470 / 11.94	0.374	3.74	1.40	38	35	-8	✓		✓
T60-52D							94	75	-52			✓
T60-26D							97	75	-26			✓
T68-0	0.690 / 17.53	0.370 / 9.40	0.190 / 4.83	0.179	4.23	0.759	0.75	1	-0	✓		
T68-17							2.1	4	-17	✓		
T68-10							3.2	6	-10	✓		
T68-6							4.7	8.5	-6	✓		
T68-7							5.2	9	-7	✓		
T68-2							5.7	10	-2	✓		✓
T68-14							7	14	-14			✓
T68-1							11.5	20	-1	✓		
T68-8/90							19.5	35	-8	✓		✓
T68-63							18.5	35	-63			✓
T68-3							19.5	35	-3	✓		
T68-60							29	55	-60			✓
T68-18							29	55	-18			✓

Toroid

(continued)

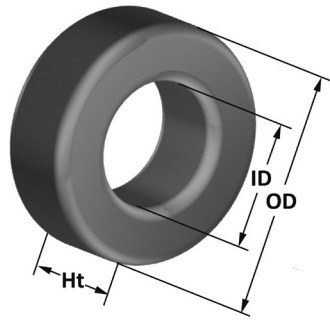

Typical Part Number: **T 106 - 26 B /**

Toroidal Geometry → T
 OD in 100th inches → 106
 Micrometals Material Mix No. → 26
 Letter Indicates Alternate Height → B
 Code Area For Other Characteristics → /

Part Number	Physical Dimensions			Magnetic Dimensions			AL (nH/N ²)	Ref. Perm.	Material	Product Group		
	OD (in/mm)	ID (in/mm)	HT (in/mm)	Ae (cm ²)	le (cm)	Ve (cm ³)				RF	PC	200C
T68-40	0.690 / 17.53	0.370 / 9.40	0.190 / 4.83	0.179	4.23	0.759	35	60	-40			✓
T68-66							35	66	-66			✓
T68-26							43.5	75	-26		✓	
T68-52							40	75	-52		✓	
T68-45							53	100	-45		✓	
T68-17A	0.690 / 17.53	0.370 / 9.40	0.250 / 6.35	0.242	4.23	1.03	2.8	4	-17	✓		
T68-6A							6.2	8.5	-6	✓		
T68-2A							7	10	-2	✓	✓	
T68-14A							9.5	14	-14		✓	
T68-8A/90							26	35	-8	✓	✓	
T68-63A							25	35	-63			✓
T68-3A							26	35	-3	✓		
T68-18A							39.5	55	-18		✓	
T68-60A							39.5	55	-60			✓
T68-40A							47	60	-40		✓	
T68-66A							47	66	-66			✓
T68-26A							58	75	-26		✓	
T68-52A							54	75	-52		✓	
T68-45A							71	100	-45		✓	
T69-45	0.690 / 17.53	0.336 / 8.53	0.367 / 9.32	0.394	4.09	1.61	120	100	-45			✓
T68-17D	0.690 / 17.53	0.370 / 9.40	0.375 / 9.53	0.358	4.23	1.52	4.2	4	-17	✓		
T68-6D							9.4	8.5	-6	✓		
T68-2D							11.4	10	-2	✓	✓	
T68-14D							14.2	14	-14		✓	
T68-8D/90							39	35	-8	✓	✓	
T68-18D							58	55	-18		✓	
T68-26D							87	75	-26		✓	
T68-52D							80	75	-52		✓	
T68-17E	0.690 / 17.53	0.370 / 9.40	0.500 / 12.70	0.49	4.23	2.07	5.7	4	-17	✓		
T72-0	0.720 / 18.29	0.280 / 7.11	0.260 / 6.60	0.349	4.01	1.40	1.5	1	-0	✓		
T72-17							4.5	4	-17	✓		
T72-6							9	8.5	-6	✓		
T72-7							9.5	9	-7	✓		
T72-2							12.8	10	-2	✓	✓	
T72-8/90							36	35	-8	✓	✓	
T72-18							60	55	-18		✓	
T72-40							71	60	-40		✓	
T72-26							90	75	-26		✓	
T72-52							82	75	-52		✓	
T73-26	0.720 / 18.29	0.389 / 9.88	0.330 / 8.38	0.333	4.01	1.51	70	75	-26		✓	
T80-0	0.795 / 20.19	0.495 / 12.57	0.250 / 6.35	0.231	5.14	1.19	0.85	1	-0	✓		
T80-17							2.2	4	-17	✓		
T80-10							3.2	6	-10	✓		
T80-6							4.5	8.5	-6	✓		

Toroid

(continued)

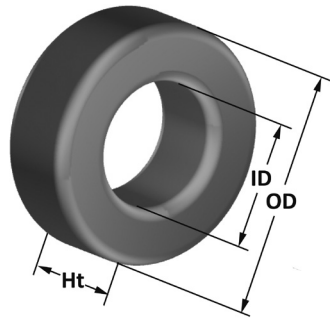

Typical Part Number: **T 106 - 26 B /**

Toroidal Geometry → T
 OD in 100th inches → 106
 Micrometals Material Mix No. → 26
 Letter Indicates Alternate Height → B
 Code Area For Other Characteristics → /

Part Number	Physical Dimensions			Magnetic Dimensions			AL (nH/N ²)	Ref. Perm.	Material	Product Group		
	OD (in/mm)	ID (in/mm)	HT (in/mm)	Ae (cm ²)	le (cm)	Ve (cm ³)				RF	PC	200C
T80-7	0.795 / 20.19	0.495 / 12.57	0.250 / 6.35	0.231	5.14	1.19	5	9	-7	✓		
T80-2							5.5	10	-2	✓	✓	
T80-14							7.4	14	-14			✓
T80-1							11.5	20	-1	✓		
T80-8/90							18	35	-8	✓	✓	
T80-63							19.5	35	-63			✓
T80-60							31	55	-60			✓
T80-18							31	55	-18		✓	
T80-40							39.5	60	-40		✓	
T80-66							37	66	-66			✓
T80-52							42	75	-52		✓	
T80-26							46	75	-26		✓	
T80-6B	0.795 / 20.19	0.495 / 12.57	0.375 / 9.53	0.347	5.14	1.78	6.8	8.5	-6	✓		
T80-7B							8.4	9	-7	✓		
T80-2B							9.5	10	-2	✓	✓	
T80-14B							11	14	-14		✓	
T80-8B/90							29.5	35	-8	✓	✓	
T80-63B							29.5	35	-63			✓
T80-60B							46.5	55	-60			✓
T80-18B							46.5	55	-18		✓	
T80-40B							59	60	-40		✓	
T80-66B							55	66	-66			✓
T80-52B							63	75	-52		✓	
T80-26B							71	75	-26		✓	
T80-45B							84	100	-45		✓	
T80-17D	0.795 / 20.19	0.495 / 12.57	0.500 / 12.70	0.453	5.14	2.33	4.4	4	-17	✓		
T80-6D							9	8.5	-6	✓		
T80-2D							11	10	-2	✓	✓	
T80-14D							13.3	14	-14		✓	
T80-8D/90							36	35	-8	✓	✓	
T80-40D							79	60	-40		✓	
T80-26D							92	75	-26		✓	
T80-52D							83	75	-52		✓	
T90-8/90	0.900 / 22.86	0.550 / 13.97	0.375 / 9.53	0.395	5.78	2.28	30	35	-8	✓	✓	
T90-18							47	55	-18		✓	
T90-60							47	55	-60			✓
T90-66							56	66	-66			✓
T90-26							70	75	-26		✓	
T90-52							64	75	-52		✓	
T94-0	0.942 / 23.93	0.560 / 14.22	0.312 / 7.92	0.362	5.97	2.16	1.06	1	-0	✓		
T94-17							2.9	4	-17	✓		
T94-10							5.8	6	-10	✓		
T94-6							7	8.5	-6	✓		
T94-2							8.4	10	-2	✓	✓	

Toroid

(continued)

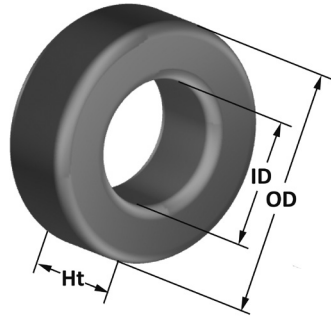

Typical Part Number: **T 106 - 26 B /**

Toroidal Geometry → T
 OD in 100th inches → 106
 Micrometals Material Mix No. → 26
 Letter Indicates Alternate Height → B
 Code Area For Other Characteristics → /

Part Number	Physical Dimensions			Magnetic Dimensions			AL (nH/N ²)	Ref. Perm.	Material	Product Group		
	OD (in/mm)	ID (in/mm)	HT (in/mm)	Ae (cm ²)	le (cm)	Ve (cm ³)				RF	PC	200C
T94-14	0.942 / 23.93	0.560 / 14.22	0.312 / 7.92	0.362	5.97	2.16	10	14	-14			✓
T94-15							20	25	-15	✓		
T94-8/90							25	35	-8	✓	✓	
T94-63							26	35	-63			✓
T94-60							42	55	-60			✓
T94-18							42	55	-18		✓	
T94-40							49	60	-40		✓	
T94-66							50	66	-66			✓
T94-52							57	75	-52		✓	
T94-26							60	75	-26		✓	
T95-26B	0.942 / 23.93	0.495 / 12.57	0.375 / 9.53	0.51	5.72	2.91	84	75	-26		✓	
T95-52B							84	75	-52		✓	
T94-26D	0.942 / 23.93	0.560 / 14.22	0.625 / 15.88	0.724	5.97	4.32	115	75	-26		✓	
T106-18A	1.060 / 26.92	0.570 / 14.48	0.312 / 7.92	0.461	6.49	3.00	49	55	-18		✓	
T106-40A							58	60	-40		✓	
T106-66A							59	66	-66			✓
T106-52A							67	75	-52		✓	
T106-26A							67	75	-26		✓	
T106-0	1.060 / 26.92	0.570 / 14.48	0.437 / 11.10	0.659	6.49	4.28	1.9	1	-0	✓		
T106-17							5.1	4	-17	✓		
T106-10							8.5	6	-10	✓		
T106-6							11.6	8.5	-6	✓		
T106-7							13.3	9	-7	✓		
T106-2							13.5	10	-2	✓	✓	
T106-14							17	14	-14		✓	
T106-1							28	20	-1	✓		
T106-30							30	22	-30		✓	
T106-34							40	33	-34		✓	
T106-35							40	33	-35		✓	
T106-63							44.5	35	-63			✓
T106-8/90							45	35	-8	✓	✓	
T106-3							45	35	-3	✓		
T106-60							70	55	-60			✓
T106-18							70	55	-18		✓	
T106-40							81	60	-40		✓	
T106-66							84	66	-66			✓
T106-26							93	75	-26		✓	
T106-52							95	75	-52		✓	
T106-45							125	100	-45		✓	
T106-17B	1.060 / 26.92	0.570 / 14.48	0.575 / 14.61	0.858	6.49	5.57	6.6	4	-17	✓		
T106-10B							11.1	6	-10	✓		
T106-6B							15.2	8.5	-6	✓		
T106-2B							17.6	10	-2	✓	✓	
T106-34B							55	33	-34		✓	

Toroid

(continued)

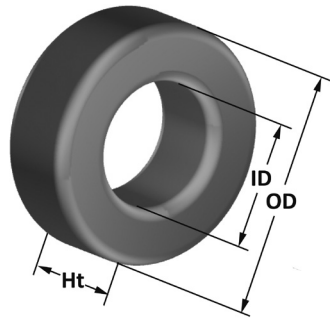

Typical Part Number: **T 106 - 26 B /**

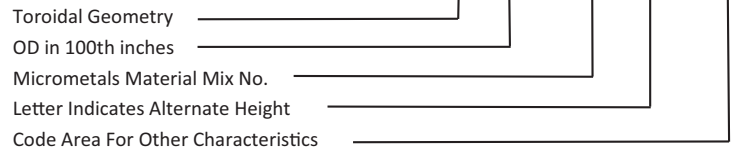

Part Number	Physical Dimensions			Magnetic Dimensions			AL (nH/N ²)	Ref. Perm.	Material	Product Group		
	OD (in/mm)	ID (in/mm)	HT (in/mm)	Ae (cm ²)	le (cm)	Ve (cm ³)				RF	PC	200C
T106-63B	1.060 / 26.92	0.570 / 14.48	0.575 / 14.61	0.858	6.49	5.57	57	35	-63			✓
T106-60B							91	55	-60			✓
T106-18B							91	55	-18		✓	
T106-40B							106	60	-40		✓	
T106-66B							109	66	-66			✓
T106-52B							124	75	-52		✓	
T106-26B							124	75	-26		✓	
T124-26	1.245 / 31.62	0.710 / 18.03	0.280 / 7.11	0.459	7.75	3.55	58	75	-26		✓	
T130-40A	1.300 / 33.02	0.780 / 19.81	0.225 / 5.72	0.361	8.28	2.99	34	60	-40		✓	
T130-52A							41	75	-52		✓	
T130-26A							41	75	-26		✓	
T130-0	1.300 / 33.02	0.780 / 19.81	0.437 / 11.10	0.698	8.28	5.78	1.5	1	-0	✓		
T130-17							4	4	-17	✓		
T130-10							6.83	6	-10	✓		
T130-6							9.6	8.5	-6	✓		
T130-7							10.3	9	-7	✓		
T130-2							11	10	-2	✓	✓	
T130-14							14	14	-14		✓	
T130-30							25	22	-30		✓	
T130-15							25	25	-15	✓		
T130-34							33.5	33	-34		✓	
T130-8/90							35	35	-8	✓	✓	
T130-63							36	35	-63			✓
T130-3							35	35	-3	✓		
T130-18							58	55	-18		✓	
T130-60							58	55	-60			✓
T130-66							69	66	-66			✓
T130-26							81	75	-26		✓	
T130-52							79	75	-52		✓	
T130-45							105	100	-45		✓	
T132-26	1.300 / 33.02	0.700 / 17.78	0.437 / 11.10	0.805	7.96	6.41	103	75	-26		✓	
T132-52							95	75	-52		✓	
T131-6	1.300 / 33.02	0.640 / 16.26	0.437 / 11.10	0.885	7.72	6.84	13.2	8.5	-6	✓		
T131-35							46.5	33	-35		✓	
T131-34							46.5	33	-34		✓	
T131-63							52.5	35	-63			✓
T131-8/90							52.5	35	-8	✓	✓	
T131-18							79	55	-18		✓	
T131-40							93	60	-40		✓	
T131-26							116	75	-26		✓	
T131-52							108	75	-52		✓	
T141-8/90	1.415 / 35.94	0.880 / 22.35	0.412 / 10.46	0.674	9.14	6.16	32	35	-8	✓	✓	
T141-26							75	75	-26		✓	
T141-52							69	75	-52		✓	

Toroid

(continued)

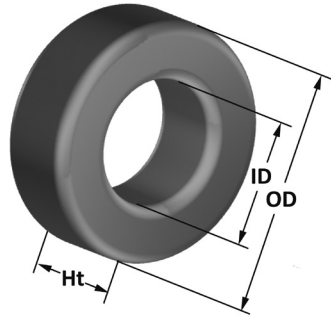

Typical Part Number: **T 106 - 26 B /**

Toroidal Geometry
 OD in 100th inches
 Micrometals Material Mix No.
 Letter Indicates Alternate Height
 Code Area For Other Characteristics

Part Number	Physical Dimensions			Magnetic Dimensions			AL (nH/N ²)	Ref. Perm.	Material	Product Group		
	OD (in/mm)	ID (in/mm)	HT (in/mm)	Ae (cm ²)	le (cm)	Ve (cm ³)				RF	PC	200C
T150-26A	1.510 / 38.35	0.845 / 21.46	0.325 / 8.26	0.657	9.38	6.16	66	75	-26		✓	
T150-6	1.510 / 38.35	0.845 / 21.46	0.437 / 11.10	0.887	9.38	8.31	10	8.5	-6	✓		
T150-2							11.5	10	-2	✓	✓	
T150-30							26	22	-30		✓	
T150-63							41	35	-63			✓
T150-18							65	55	-18		✓	
T150-60							65	55	-60			✓
T150-66							78	66	-66			✓
T150-52							89	75	-52		✓	
T150-26							96	75	-26			✓
T157-0	1.570 / 39.88	0.950 / 24.13	0.570 / 14.48	1.06	10.1	10.7	1.8	1	-0	✓		
T157-17							5.3	4	-17	✓		
T157-10							8.2	6	-10	✓		
T157-6							11.5	8.5	-6	✓		
T157-7							12	9	-7	✓		
T157-2							14	10	-2	✓	✓	
T157-14							17.5	14	-14			✓
T157-1							32	20	-1	✓		
T157-30							31.5	22	-30			✓
T157-15							36	25	-15	✓		
T157-35							43.5	33	-35			✓
T157-34							43.5	33	-34			✓
T157-8/90							42	35	-8	✓	✓	
T157-63							45	35	-63			✓
T157-18							73	55	-18		✓	
T157-60							73	55	-60			✓
T157-40							86	60	-40		✓	
T157-66							87	66	-66			✓
T157-52							99	75	-52		✓	
T157-26							100	75	-26			✓
T157-26B	1.570 / 39.88	0.950 / 24.13	0.710 / 18.03	1.32	10.1	13.3	122	75	-26			✓
T175-6	1.750 / 44.45	1.070 / 27.18	0.650 / 16.51	1.34	11.2	15.0	12.5	8.5	-6	✓		
T175-2							15	10	-2	✓	✓	
T175-8/90							48	35	-8	✓	✓	
T175-60							82	55	-60			✓
T175-66							82	55	-60			✓
T175-18							82	55	-18		✓	
T175-26							105	75	-26			✓
T175-52							105	75	-52			✓
T184-0	1.840 / 46.74	0.950 / 24.13	0.710 / 18.03	1.88	11.2	21.0	3	1	-0	✓		
T184-17							8.7	4	-17	✓		
T184-10							13.8	6	-10	✓		
T184-6							19.5	8.5	-6	✓		
T184-2							24	10	-2	✓	✓	

Toroid

(continued)

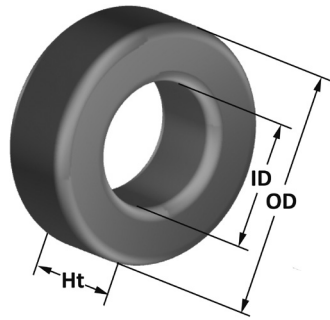

Typical Part Number: **T 106 - 26 B /**

Toroidal Geometry
 OD in 100th inches
 Micrometals Material Mix No.
 Letter Indicates Alternate Height
 Code Area For Other Characteristics

Part Number	Physical Dimensions			Magnetic Dimensions			AL (nH/N ²)	Ref. Perm.	Material	Product Group		
	OD (in/mm)	ID (in/mm)	HT (in/mm)	Ae (cm ²)	le (cm)	Ve (cm ³)				RF	PC	200C
T184-14	1.840 / 46.74	0.950 / 24.13	0.710 / 18.03	1.88	11.2	21.0	28	14	-14		✓	
T184-30							51	22	-30			✓
T184-15							55	25	-15	✓		
T184-35							70	33	-35			✓
T184-34							70	33	-34			✓
T184-8/90							72	35	-8	✓	✓	
T184-3							72	35	-3	✓		
T184-63							72	35	-63			✓
T184-18							116	55	-18		✓	
T184-60							116	55	-60			✓
T184-40							143	60	-40		✓	
T184-66							139	66	-66			✓
T184-26							169	75	-26		✓	
T184-52							159	75	-52		✓	
T200-6	2.000 / 50.80	1.250 / 31.75	0.550 / 13.97	1.27	13.0	16.4	10.4	8.5	-6	✓		
T200-7							10.5	9	-7	✓		
T200-2							12	10	-2	✓	✓	
T200-34							37	33	-34		✓	
T200-8/90							42.5	35	-8	✓	✓	
T200-60							67	55	-60			✓
T200-18							67	55	-18		✓	
T200-66							80	66	-66			✓
T200-26							92	75	-26		✓	
T200-52							92	75	-52		✓	
T200-26C	2.000 / 50.80	1.250 / 31.75	0.750 / 19.05	1.73	13.0	22.4	122	75	-26		✓	
T201-8/90	2.000 / 50.80	0.950 / 24.13	0.875 / 22.23	2.81	11.8	33.2	104	35	-8	✓	✓	
T201-18							164	55	-18		✓	
T201-40							194	60	-40		✓	
T201-52							224	75	-52		✓	
T201-26							224	75	-26		✓	
T200-2B	2.000 / 50.80	1.250 / 31.75	1.000 / 25.40	2.31	13.0	29.8	21.8	10	-2	✓	✓	
T200-35B							74	33	-35		✓	
T200-8B/90							78.5	35	-8	✓	✓	
T200-60B							120	55	-60			✓
T200-18B							120	55	-18		✓	
T200-40B							142	60	-40		✓	
T200-66B							145	66	-66			✓
T200-26B							160	75	-26		✓	
T200-52B							155	75	-52		✓	
T225-6	2.250 / 57.15	1.405 / 35.69	0.550 / 13.97	1.42	14.6	20.7	10.4	8.5	-6	✓		
T225-2	2.250 / 57.15	1.405 / 35.69	0.550 / 13.97	1.42	14.6	20.7	12	10	-2	✓	✓	
T225-30							28	22	-30			✓
T225-34							37	33	-34			✓

Toroid

(continued)

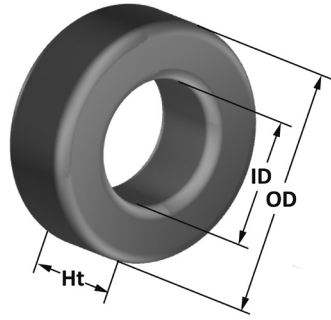

Typical Part Number: **T 106 - 26 B /**

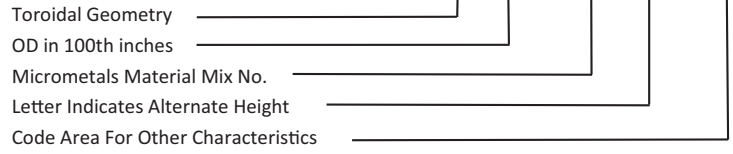

Part Number	Physical Dimensions			Magnetic Dimensions			AL (nH/N ²)	Ref. Perm.	Material	Product Group		
	OD (in/mm)	ID (in/mm)	HT (in/mm)	Ae (cm ²)	le (cm)	Ve (cm ³)				RF	PC	200C
T225-35	2.250 / 57.15	1.405 / 35.69	0.550 / 13.97	1.42	14.6	20.7	37	33	-35		✓	
T225-8/90							42.5	35	-8	✓	✓	
T225-63							42.5	35	-63			✓
T225-60							67	55	-60			✓
T225-18							67	55	-18		✓	
T225-40							78	60	-40		✓	
T225-66							80	66	-66			✓
T225-52							92	75	-52		✓	
T225-26							98	75	-26		✓	
T224-52C	2.250 / 57.15	1.250 / 31.75	0.750 / 19.05	2.31	14.0	32.2	155	75	-52		✓	
T224-26C							155	75	-26		✓	
T225-6B	2.250 / 57.15	1.405 / 35.69	1.000 / 25.40	2.59	14.6	37.8	18.5	8.5	-6	✓		
T225-2B							21.5	10	-2	✓	✓	
T225-14B							28	14	-14		✓	
T225-34B							67	33	-34		✓	
T225-60B							120	55	-60			✓
T225-66B							145	66	-66			✓
T225-26B							160	75	-26		✓	
T225-52B							155	75	-52		✓	
T250-8A/90	2.500 / 63.50	1.250 / 31.75	0.500 / 12.70	1.92	15.0	28.7		35	-8	✓	✓	
T250-61A							56	38	-61			✓
T250-52A							121	75	-52		✓	
T249-34	2.500 / 63.50	1.405 / 35.69	1.000 / 25.40	3.36	15.6	52.3	89	33	-34		✓	
T249-52							203	75	-52		✓	
T249-26							203	75	-26		✓	
T250-2	2.500 / 63.50	1.250 / 31.75	1.000 / 25.40	3.84	15.0	57.4	31	10	-2	✓	✓	
T250-14							43	14	-14		✓	
T250-15							82.5	25	-15	✓		
T250-34							106	33	-34		✓	
T250-63							113	35	-63			✓
T250-8/90							113	35	-8	✓	✓	
T250-61							113	38	-61			✓
T250-60							177	55	-60			✓
T250-18							177	55	-18		✓	
T250-66							210	66	-66			✓
T250-52							242	75	-52		✓	
T250-26							242	75	-26		✓	
T270-40D	2.695 / 68.45	1.590 / 40.39	1.055 / 26.80	3.57	17.1	61.0	187	60	-40		✓	
T282-26	2.810 / 71.37	1.850 / 46.99	1.000 / 25.40	2.94	18.6	54.7	149	75	-26		✓	
T281-40A	2.820 / 71.63	1.500 / 38.10	0.650 / 16.51	2.63	17.2	45.2	130	60	-40		✓	
T300-0	3.040 / 77.22	1.930 / 49.02	0.500 / 12.70	1.68	19.8	33.4	1.5	1	-0	✓		
T300-6							9.5	8.5	-6	✓		
T300-2							11.4	10	-2	✓	✓	

Toroid

(continued)

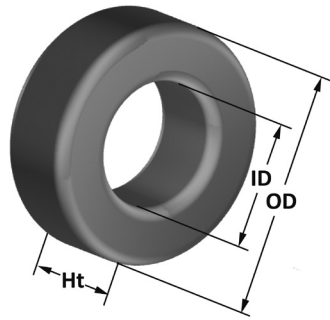

Typical Part Number: **T 106 - 26 B /**

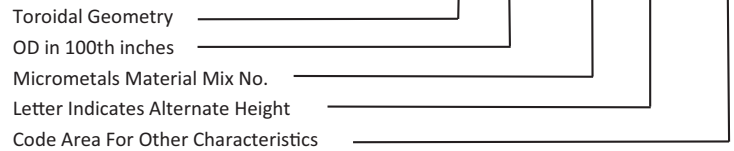

Part Number	Physical Dimensions			Magnetic Dimensions			AL (nH/N ²)	Ref. Perm.	Material	Product Group		
	OD (in/mm)	ID (in/mm)	HT (in/mm)	Ae (cm ²)	le (cm)	Ve (cm ³)				RF	PC	200C
T300-30	3.040 / 77.22	1.930 / 49.02	0.500 / 12.70	1.68	19.8	33.4	23	22	-30			✓
T300-34							34.5	33	-34			✓
T300-35							34.5	33	-35			✓
T300-8/90							37	35	-8	✓	✓	
T300-61							37	38	-61			✓
T300-18							58	55	-18			✓
T300-60							58	55	-60			✓
T300-66							70	66	-66			✓
T300-52							80	75	-52			✓
T300-26							80	75	-26			✓
T300-26C	3.040 / 77.22	1.930 / 49.02	0.750 / 19.05	2.55	19.8	50.6	120	75	-26			✓
T300-2D	3.040 / 77.22	1.930 / 49.02	1.000 / 25.40	3.38	19.8	67.0	22.8	10	-2	✓	✓	
T300-14D							28	14	-14			✓
T300-30D							46	22	-30			✓
T300-35D							69	33	-35			✓
T300-34D							69	33	-34			✓
T300-63D							74	35	-63			✓
T300-8D/90							74	35	-8	✓	✓	
T300-60D							116	55	-60			✓
T300-18D							116	55	-18			✓
T300-40D							142	60	-40			✓
T300-26D							160	75	-26			✓
T300-52D							160	75	-52			✓
T353-40B	3.530 / 89.66	2.125 / 53.98	1.000 / 25.40	4.31	22.6	97.4	161.5	60	-40			✓
T355-26A	3.550 / 90.17	2.250 / 57.15	0.910 / 23.11	3.63	23.1	83.9	140	75	-26			✓
T355-26	3.550 / 90.17	2.250 / 57.15	0.975 / 24.77	3.88	23.1	89.9	150	75	-26			✓
T355-26D	3.550 / 90.17	2.250 / 57.15	1.300 / 33.02	5.18	23.1	120	200	75	-26			✓
T400-0	4.000 / 101.60	2.250 / 57.15	0.650 / 16.51	3.46	25.0	86.4	2.4	1	-0	✓		
T400-6							15	8.5	-6	✓		
T400-2							18	10	-2	✓	✓	
T400-14							22.75	14	-14			✓
T400-30							40.5	22	-30			✓
T400-34							55	33	-34			✓
T400-35							55	33	-35			✓
T400-8/90							60	35	-8	✓	✓	
T400-18							96	55	-18			✓
T400-60							96	55	-60			✓
T400-40							115	60	-40			✓
T400-66							114	66	-66			✓
T400-26							131	75	-26			✓
T400-52	4.000 / 101.60	2.250 / 57.15	0.650 / 16.51	3.46	25.0	86.4	131	75	-52			✓
T400-35B	4.000 / 101.60	2.250 / 57.15	1.000 / 25.40	5.35	25.0	133	89	33	-35			✓
T400-26B							205	75	-26			✓

Toroid

(continued)

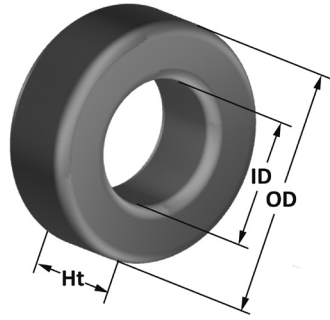

Typical Part Number: **T 106 - 26 B /**

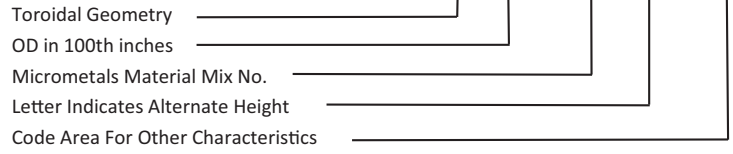

Part Number	Physical Dimensions			Magnetic Dimensions			AL (nH/N ²)	Ref. Perm.	Material	Product Group		
	OD (in/mm)	ID (in/mm)	HT (in/mm)	Ae (cm ²)	le (cm)	Ve (cm ³)				RF	PC	200C
T400-0D	4.000 / 101.60	2.250 / 57.15	1.300 / 33.02	6.85	25.0	171	4.8	1	-0	✓		
T400-17D							14.4	4	-17	✓		
T400-6D							30.5	8.5	-6	✓		
T400-2D							36	10	-2	✓	✓	
T400-14D							45.5	14	-14		✓	
T400-30D							81	22	-30		✓	
T400-34D							110	33	-34		✓	
T400-63D							120	35	-63			✓
T400-60D							192	55	-60			✓
T400-40D							230	60	-40		✓	
T400-66D							228	66	-66			✓
T400-52D							262	75	-52		✓	
T400-26D							262	75	-26		✓	
T520-2	5.200 / 132.08	3.080 / 78.23	0.800 / 20.32	5.24	33.1	173	20	10	-2	✓	✓	
T520-30							45	22	-30		✓	
T520-35							65	33	-35		✓	
T520-63							68	35	-63			✓
T520-40							119	60	-40		✓	
T520-66							130	66	-66			✓
T520-52							137	75	-52		✓	
T520-26							149	75	-26		✓	
T520-30D	5.200 / 132.08	3.080 / 78.23	1.600 / 40.64	10.5	33.1	347	90	22	-30		✓	
T520-34D							130	33	-34		✓	
T520-35D							130	33	-35		✓	
T520-40D							240	60	-40		✓	
T650-2	6.500 / 165.10	3.500 / 88.90	2.000 / 50.80	18.4	39.9	734	58	10	-2	✓	✓	
T650-14							75	14	-14		✓	
T650-30							127	22	-30		✓	
T650-35							191	33	-35		✓	
T650-34							191	33	-34		✓	
T650-63							200	35	-63			✓
T650-8/90							200	35	-8	✓	✓	
T650-66							380	66	-66			✓
T650-26							434	75	-26		✓	
T650-52							405	75	-52		✓	

E-Core

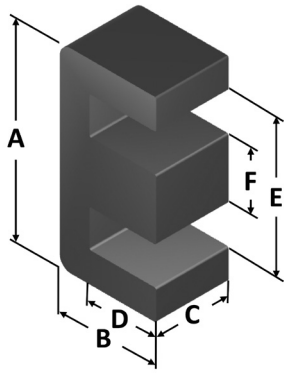

Typical Part Number: **E 168 - 26 A / G015**

E Core Geometry
 "A" Dimension in 100th inches
 Micrometals Material Mix No.
 Letter Indicates Alternate "C" Dimension
 Indicates Center-Leg Gap per Half in .001 inches

Part Number	Ind Size	Bobbin	Physical Dimensions						Magnetic Dimensions			AL (nH/N ²)	Ref. Perm.	Material	Product Group		
			Dim A (in/mm)	Dim B (in/mm)	Dim C (in/mm)	Dim D (in/mm)	Dim F (in/mm)	Dim E (in/mm)	Ae (cm ²)	le (cm)	Ve (cm ³)				RF	PC	200C
E49-2	EE-28/29	PB49	0.500 / 12.70	0.219 / 5.56	0.125 / 3.18	0.156 / 3.96	0.125 / 3.18	0.375 / 9.52	0.101	2.86	0.288	10.7	10	-2	✓	✓	
E49-8	EE-28/29	PB49										20.5	35	-8	✓	✓	
E49-18	EE-28/29	PB49										29	55	-18		✓	
E49-66	EE-28/29	PB49										32	66	-66		✓	
E49-26	EE-28/29	PB49										38	75	-26		✓	
E49-52	EE-28/29	PB49										38	75	-52		✓	
E49-70	EE-28/29	PB49										45	100	-70		✓	
E50-26	DIN 13/4		0.505 / 12.83	0.252 / 6.40	0.148 / 3.76	0.177 / 4.50	0.149 / 3.78	0.354 / 8.99	0.143	3.08	0.441	48	75	-26		✓	
E50-52	DIN 13/4											47	75	-52		✓	
E65-8	DIN 16/5		0.645 / 16.38	0.320 / 8.13	0.182 / 4.62	0.236 / 5.98	0.182 / 4.62	0.445 / 11.30	0.224	3.98	0.861	30.5	35	-8	✓	✓	
E65-66	DIN 16/5											48	66	-66		✓	
E65-26	DIN 16/5											58	75	-26		✓	
E65-52	DIN 16/5											56	75	-52		✓	
E75-2	EI-187	PB75	0.750 / 19.05	0.318 / 8.08	0.187 / 4.75	0.228 / 5.78	0.187 / 4.75	0.562 / 14.27	0.226	4.20	0.936	14.5	10	-2	✓	✓	
E75-8	EI-187	PB75										33.5	35	-8	✓	✓	
E75-18	EI-187	PB75										45.5	55	-18		✓	
E75-40	EI-187	PB75										55	60	-40		✓	
E75-26	EI-187	PB75										64	75	-26		✓	
E75-52	EI-187	PB75										59	75	-52		✓	
E80-8	DIN 20/6	PB80	0.795 / 20.19	0.391 / 9.93	0.230 / 5.84	0.280 / 7.11	0.230 / 5.84	0.575 / 14.60	0.333	4.84	1.63	38	35	-8	✓	✓	
E80-26	DIN 20/6	PB80										73	75	-26		✓	
E80-52	DIN 20/6	PB80										73	75	-52		✓	
E80-45	DIN 20/6	PB80										95	100	-45		✓	
E99-2	DIN 25/7	PB99	1.000 / 25.40	0.500 / 12.70	0.287 / 7.29	0.345 / 8.76	0.287 / 7.29	0.695 / 17.65	0.548	6.08	3.38	24	10	-2	✓	✓	
E99-8	DIN 25/7	PB99										51	35	-8	✓	✓	
E99-52	DIN 25/7	PB99										96	75	-52		✓	
E99-26	DIN 25/7	PB99										96	75	-26		✓	
E99-45	DIN 25/7	PB99										120	100	-45		✓	
E100-2	EE-24/25	PB100E	1.000 / 25.40	0.375 / 9.53	0.250 / 6.35	0.250 / 6.35	0.250 / 6.35	0.750 / 19.05	0.403	5.08	2.05	21	10	-2	✓	✓	
E100-8	EE-24/25	PB100E										48	35	-8	✓	✓	
E100-18	EE-24/25	PB100E										65	55	-18		✓	
E100-60	EE-24/25	PB100E										65	55	-60		✓	
E100-52	EE-24/25	PB100E										85	75	-52		✓	
E100-26	EE-24/25	PB100E										92	75	-26		✓	
E100-70	EE-24/25	PB100E										110	100	-70		✓	

E-Core

(continued)

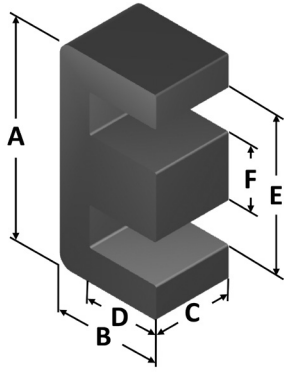

Typical Part Number: **E 168 - 26 A / G015**

E Core Geometry
 "A" Dimension in 100th inches
 Micrometals Material Mix No.
 Letter Indicates Alternate "C" Dimension
 Indicates Center-Leg Gap per Half in .001 inches

Part Number	Ind Size	Bobbin	Physical Dimensions						Magnetic Dimensions			AL (nH/N ²)	Ref. Perm.	Material	Product Group		
			Dim A (in/mm)	Dim B (in/mm)	Dim C (in/mm)	Dim D (in/mm)	Dim F (in/mm)	Dim E (in/mm)	Ae (cm ²)	le (cm)	Ve (cm ³)				RF	PC	200C
E137-2	EI-375	PB137	1.375 / 34.93	0.572 / 14.53	0.375 / 9.53	0.385 / 9.78	0.375 / 9.52	1.000 / 25.40	0.907	7.40	6.72	32	10	-2	✓	✓	
E137-8	EI-375	PB137										67	35	-8	✓	✓	
E137-60	EI-375	PB137										100	55	-60		✓	
E137-18	EI-375	PB137										100	55	-18		✓	
E137-66	EI-375	PB137										113	66	-66		✓	
E137-52	EI-375	PB137										131	75	-52		✓	
E137-26	EI-375	PB137										134	75	-26		✓	
E162-8	EI-21	PB162	1.625 / 41.28	0.671 / 17.04	0.500 / 12.70	0.421 / 10.69	0.500 / 12.70	1.125 / 28.58	1.61	8.41	13.6	105	35	-8	✓	✓	
E162-18	EI-21	PB162										149	55	-18		✓	
E162-60	EI-21	PB162										149	55	-60		✓	
E162-66	EI-21	PB162										168	66	-66		✓	
E162-52	EI-21	PB162										199	75	-52		✓	
E162-26	EI-21	PB162										210	75	-26		✓	
E168-2	DIN 42/15	PB168	1.685 / 42.80	0.830 / 21.08	0.590 / 14.99	0.605 / 15.37	0.475 / 12.07	1.210 / 30.73	1.81	10.4	18.5	43.5	10	-2	✓	✓	
E168-8	DIN 42/15	PB168										97	35	-8	✓	✓	
E168-60	DIN 42/15	PB168										135	55	-60		✓	
E168-18	DIN 42/15	PB168										135	55	-18		✓	
E168-66	DIN 42/15	PB168										155	66	-66		✓	
E168-52	DIN 42/15	PB168										179	75	-52		✓	
E168-26	DIN 42/15	PB168										195	75	-26		✓	
E168-2A	DIN 42/20	PB168A	1.685 / 42.80	0.830 / 21.08	0.787 / 19.99	0.605 / 15.37	0.475 / 12.07	1.210 / 30.73	2.41	10.4	24.6	55	10	-2	✓	✓	
E168-8A	DIN 42/20	PB168A										116	35	-8	✓	✓	
E168-18A	DIN 42/20	PB168A										170	55	-18		✓	
E168-60A	DIN 42/20	PB168A										170	55	-60		✓	
E168-66A	DIN 42/20	PB168A										190	66	-66		✓	
E168-26A	DIN 42/20	PB168A										232	75	-26		✓	
E168-52A	DIN 42/20	PB168A										230	75	-52		✓	
E187-8	EI-625	PB187	1.865 / 47.37	0.776 / 19.71	0.620 / 15.75	0.476 / 12.09	0.620 / 15.75	1.250 / 31.75	2.48	9.53	23.3	144	35	-8	✓	✓	
E187-18	EI-625	PB187										213	55	-18		✓	
E187-52	EI-625	PB187										265	75	-52		✓	
E187-26	EI-625	PB187										265	75	-26		✓	
E220-2	DIN 55/21	PB220	2.210 / 56.13	1.090 / 27.69	0.820 / 20.83	0.755 / 19.18	0.680 / 17.27	1.520 / 38.61	3.60	13.2	47.7	69	10	-2	✓	✓	
E220-34	DIN 55/21	PB220										136	33	-34		✓	
E220-8	DIN 55/21	PB220										143	35	-8	✓	✓	
E220-18	DIN 55/21	PB220										196	55	-18		✓	
E220-60	DIN 55/21	PB220										196	55	-60		✓	

E-Core

(continued)

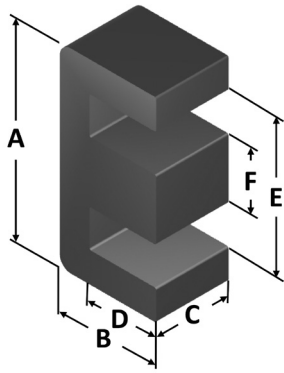

Typical Part Number: **E 168 - 26 A / G015**

E Core Geometry
 "A" Dimension in 100th inches
 Micrometals Material Mix No.
 Letter Indicates Alternate "C" Dimension
 Indicates Center-Leg Gap per Half in .001 inches

Part Number	Ind Size	Bobbin	Physical Dimensions						Magnetic Dimensions			AL (nH/N ²)	Ref. Perm.	Material	Product Group		
			Dim A (in/mm)	Dim B (in/mm)	Dim C (in/mm)	Dim D (in/mm)	Dim F (in/mm)	Dim E (in/mm)	Ae (cm ²)	le (cm)	Ve (cm ³)				RF	PC	200C
E220-40	DIN 55/21	PB220	2.210 / 56.13	1.090 / 27.69	0.820 / 20.83	0.755 / 19.18	0.680 / 17.27	1.520 / 38.61	3.60	13.2	47.7	240	60	-40	✓		
E220-66	DIN 55/21	PB220										220	66	-66			✓
E220-52	DIN 55/21	PB220										262	75	-52			✓
E220-26	DIN 55/21	PB220										275	75	-26			✓
E220-52/G020	DIN 55/21	PB220										183	75	-52			✓
E220-26/G020	DIN 55/21	PB220										183	75	-26			✓
E225-2	EI-75	PB225	2.240 / 56.90	0.938 / 23.83	0.745 / 18.92	0.570 / 14.48	0.745 / 18.92	1.500 / 38.10	3.58	11.5	40.8	76	10	-2	✓	✓	
E225-8	EI-75	PB225										173	35	-8	✓	✓	
E225-18	EI-75	PB225										240	55	-18			✓
E225-52	EI-75	PB225										325	75	-52			✓
E225-26	EI-75	PB225										325	75	-26			✓
E305-2		PB305, PB305/V0	3.051 / 77.50	1.526 / 38.76	0.933 / 23.70	1.059 / 26.90	0.933 / 23.70	2.118 / 53.80	5.62	18.5	104	75	10	-2	✓	✓	
E305-30		PB305, PB305/V0										124	22	-30			✓
E305-34		PB305, PB305/V0										150	33	-34			✓
E305-8		PB305, PB305/V0										156	35	-8	✓	✓	
E305-18		PB305, PB305/V0										222	55	-18			✓
E305-60		PB305, PB305/V0										222	55	-60			✓
E305-66		PB305, PB305/V0										250	66	-66			✓
E305-52		PB305, PB305/V0										287	75	-52			✓
E305-26/G050		PB305, PB305/V0										165	75	-26			✓
E305-52/G050		PB305, PB305/V0										165	75	-52			✓
E305-26		PB305, PB305/V0										287	75	-26			✓
E305-2A		PB305A	3.051 / 77.50	1.526 / 38.76	1.244 / 31.60	1.059 / 26.90	0.933 / 23.70	2.118 / 53.80	7.49	18.5	139	100	10	-2	✓	✓	
E305-60A		PB305A										280	55	-60			✓
E305-40A		PB305A										339	60	-40			✓
E305-66A		PB305A										315	66	-66			✓
E305-52A/G050		PB305A										219	75	-52			✓
E305-26A		PB305A										382	75	-26			✓
E305-52A		PB305A										382	75	-52			✓
E305-26A/G050		PB305A										219	75	-26			✓

E-Core

(continued)

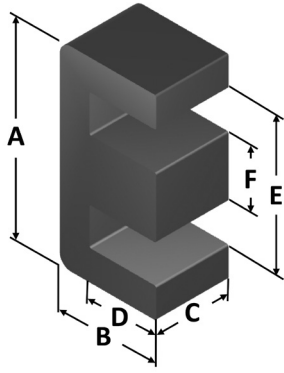

Typical Part Number: **E 168 - 26 A / G015**

E Core Geometry
 "A" Dimension in 100th inches
 Micrometals Material Mix No.
 Letter Indicates Alternate "C" Dimension
 Indicates Center-Leg Gap per Half in .001 inches

Part Number	Ind Size	Bobbin	Physical Dimensions						Magnetic Dimensions			AL (nH/N ²)	Ref. Perm.	Material	Product Group		
			Dim A (in/mm)	Dim B (in/mm)	Dim C (in/mm)	Dim D (in/mm)	Dim F (in/mm)	Dim E (in/mm)	Ae (cm ²)	le (cm)	Ve (cm ³)				RF	PC	200C
E315-66	DIN 80/20		3.150 / 80.01	1.500 / 38.10	0.780 / 19.81	1.111 / 28.21	0.780 / 19.81	2.370 / 60.20	3.92	19.3	75.6	170	66	-66		✓	
E315-52	DIN 80/20											190	75	-52		✓	
E315-66A	DIN 80/25		3.150 / 80.01	1.500 / 38.10	0.974 / 24.74	1.111 / 28.21	0.780 / 19.81	2.370 / 60.20	4.90	19.3	94.5	213	66	-66		✓	
E315-52A	DIN 80/25											238	75	-52		✓	
E315-52B	DIN 80/30		3.150 / 80.01	1.500 / 38.10	1.169 / 29.69	1.111 / 28.21	0.780 / 19.81	2.370 / 60.20	5.88	19.3	113	285	75	-52		✓	
E315-52D	DIN 80/40		3.150 / 80.01	1.500 / 38.10	1.559 / 39.60	1.111 / 28.21	0.780 / 19.81	2.370 / 60.20	7.84	19.3	151	370	75	-52		✓	
E450-2	EI-30	PB450/V0	4.500 / 114.30	1.818 / 46.18	1.375 / 34.93	1.125 / 28.58	1.375 / 34.93	3.120 / 79.25	12.2	22.9	280	132	10	-2	✓	✓	
E450-30	EI-30	PB450/V0										235	22	-30		✓	
E450-34	EI-30	PB450/V0										300	33	-34		✓	
E450-60	EI-30	PB450/V0										400	55	-60		✓	
E450-40	EI-30	PB450/V0										480	60	-40		✓	
E450-66	EI-30	PB450/V0										460	66	-66		✓	
E450-52	EI-30	PB450/V0										500	75	-52		✓	
E450-26	EI-30	PB450/V0										540	75	-26		✓	
E610-2			6.102 / 154.99	3.051 / 77.50	1.866 / 47.40	2.118 / 53.80	1.866 / 47.40	4.236 / 107.59	22.5	37.0	832	163	10	-2	✓	✓	
E610-34												314	33	-34		✓	
E610-63												314	35	-63		✓	
E610-66												500	66	-66		✓	
E610-26												588	75	-26		✓	
E827-2			8.268 / 210.01	4.922 / 125.01	2.520 / 64.01	3.662 / 93.00	2.520 / 64.01	5.748 / 146.00	41.0	58.2	2,384	175	10	-2	✓	✓	
E827-30												280	22	-30		✓	
E827-35												378	33	-35	0	-1	0
E827-63												320	35	-63	0	0	-1
E827-60												474	55	-60	0	0	-1
E827-26												620	75	-26	0	-1	0

Bus Bar

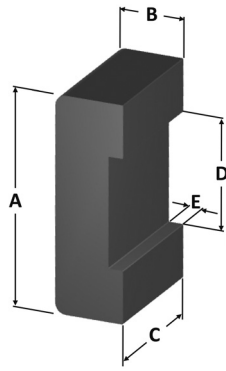

Typical Part Number: **HS 300 - 26 A**

Bus Bar Core Geometry
 Code to Indicate Max. Current
 Micrometals Material Mix No.
 Letter Indicates Alternate Length
 Code Area for Other Characteristics

PartNumber	Physical Dimensions					Magnetic Dimensions			AL	Ref. Perm.	Material	Product Group		
	Dim A (in/mm)	Dim B (in/mm)	Dim C (in/mm)	Dim D (in/mm)	Dim E (in/mm)	Ae (cm ²)	le (cm)	Ve (cm ³)				RF	PC	200C
HS135-26	0.720 / 18.29	0.150 / 3.81	0.400 / 10.16	0.520 / 13.21	0.055 / 1.40	0.245	4.19	0.984	56.08	75	-26		✓	
HS300-8	1.020 / 25.91	0.325 / 8.26	0.500 / 12.70	0.520 / 13.21	0.070 / 1.78	0.806	5.92	4.61	68	35	-8	✓	✓	
HS300-26									147	75	-26			✓
HS300-52									147	75	-52			✓
HS300-8A	1.020 / 25.91	0.325 / 8.26	0.625 / 15.88	0.520 / 13.21	0.070 / 1.78	1.01	5.92	5.77	83	35	-8	✓	✓	
HS300-26A									179	75	-26			✓
HS300-52A									179	75	-52			✓
HS300-8B	1.020 / 25.91	0.325 / 8.26	0.750 / 19.05	0.520 / 13.21	0.070 / 1.78	1.21	5.92	6.92	95	35	-8	✓	✓	
HS300-26B									208	75	-26			✓
HS300-52B									208	75	-52			✓
HS300-8C	1.020 / 25.91	0.325 / 8.26	0.875 / 22.23	0.520 / 13.21	0.070 / 1.78	1.41	5.92	8.06	107	35	-8	✓	✓	
HS300-66C									204	66	-66			✓
HS300-26C									232	75	-26			✓
HS300-52C									232	75	-52			✓
HS400-26	1.500 / 38.10	0.480 / 12.19	0.750 / 19.05	0.765 / 19.43	0.103 / 2.60	1.78	8.71	15.1	221	75	-26			✓
HS400-26A	1.500 / 38.10	0.480 / 12.19	1.000 / 25.40	0.765 / 19.43	0.103 / 2.60	2.37	8.71	20.1	286	75	-26			✓
HS400-26B	1.500 / 38.10	0.480 / 12.19	1.250 / 31.75	0.765 / 19.43	0.103 / 2.60	2.96	8.71	25.2	335	75	-26			✓
HS400-26C	1.500 / 38.10	0.480 / 12.19	1.500 / 38.10	0.765 / 19.43	0.103 / 2.60	3.56	8.71	30.2	371	75	-26			✓
HS400-52C									371	75	-52			✓
HS670-26/10	2.007 / 50.98	0.640 / 16.26	0.505 / 12.83	1.025 / 26.03	0.138 / 3.51	1.6	11.7	18.1	168	75	-26			✓
HS465-26	2.039 / 51.79	0.315 / 8.00	0.866 / 22.00	1.528 / 38.81	0.059 / 1.50	1.43	11	14.9	152	75	-26			✓

Balun Core

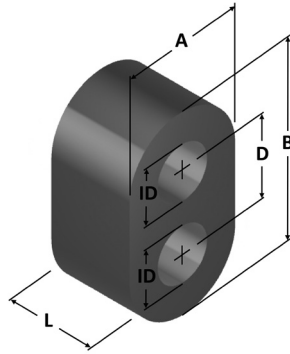

Typical Part Number: **BLN 1728 - 10 A / 94**

Balun Core Geometry _____
 Part Size Indication _____
 Micrometals Material Mix No. _____
 Letter Indicates Alternate Length _____
 Indicates Parylene Coating _____

Part Number	Physical Dimensions					AL (nH/N ²)	Ref. Perm.	Material	Product Group		
	Dim A (in/mm)	Dim B (in/mm)	L (in/mm)	ID (in/mm)	Dim D (in/mm)				RF	PC	200C
BLN814-0B/94	0.081 / 2.06	0.138 / 3.51	0.053 / 1.35	0.031 / 0.79	0.057 / 1.45	N/A	1	-0	✓		
BLN814-10B/94A						3.5	6	-10	✓		
BLN814-10A/94	0.081 / 2.06	0.138 / 3.51	0.070 / 1.78	0.031 / 0.79	0.057 / 1.45	4.4	6	-10	✓		
BLN814-0A/94	0.082 / 2.08	0.140 / 3.56	0.070 / 1.78	0.033 / 0.84	0.058 / 1.47	1.9	1	-0	✓		
BLN814-8A/94						10.5	35	-8	✓	✓	
BLN814-0/94	0.082 / 2.08	0.140 / 3.56	0.093 / 2.36	0.033 / 0.84	0.058 / 1.47	2.5	1	-0	✓		
BLN814-17/94						4.1	4	-17	✓		
BLN814-10/94						5.6	6	-10	✓		
BLN814-6/94						7.3	8.5	-6	✓		
BLN814-2/94						8.1	10	-2	✓	✓	
BLN814-8/94						14.4	35	-8	✓	✓	
BLN1728-10A/94	0.169 / 4.29	0.282 / 7.16	0.125 / 3.18	0.077 / 1.96	0.114 / 2.90	7.9	6	-10	✓		
BLN1728-6A/94						9	8.5	-6	✓		
BLN1728-2A/94						11	10	-2	✓	✓	
BLN1728-0/94	0.169 / 4.29	0.282 / 7.16	0.250 / 6.35	0.077 / 1.96	0.114 / 2.90	N/A	1	-0	✓		
BLN1728-10/94						15.8	6	-10	✓		
BLN1728-6/94						18	8.5	-6	✓		
BLN1728-2/94						22	10	-2	✓	✓	
BLN1728-8/94						55	35	-8	✓	✓	
BLN1728-8A/94						55	35	-8	✓	✓	

Plain Core

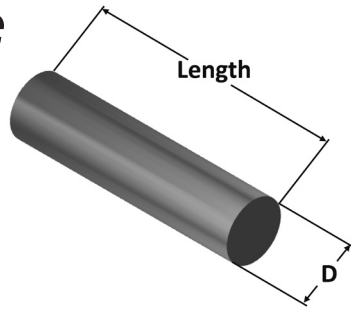

Typical Part Number: **P 16 32 - 1 40**

Plain (Rod) Core Geometry → P
 Diameter in 64th Inches → 16
 Length in 32nd Inches → 32
 Code Area for Other Characteristics → - 1
 Micrometals Material Mix No. → 40

Part Number	Physical Dimensions		Ref. Perm.	Material	Product Group		
	D (in/mm) max	L (in/mm) nom			RF	PC	200C
P22-117	0.033 / 0.80	0.050 / 1.27	4	-17	✓		
P22-106			8.5	-6	✓		
P23-100	0.033 / 0.80	0.075 / 1.90	1	-0	✓		
P23-117			4	-17	✓		
P23-200	0.033 / 0.80	0.086 / 2.18	1	-0	✓		
P24-100	0.033 / 0.80	0.100 / 2.54	1	-0	✓		
P24-117			4	-17	✓		
P24-106			8.5	-6	✓		
P24-107			9	-7	✓		
P25-100	0.033 / 0.80	0.155 / 3.94	1	-0	✓		
P25-117			4	-17	✓		
P25-110			6	-10	✓		
P25-106			8.5	-6	✓		
P25-102			10	-2	✓		✓
P25-101			20	-1	✓		
P25-108			35	-8	✓		✓
P33-100	0.044 / 1.08	0.100 / 2.54	1	-0	✓		
P33-117			4	-17	✓		
P33-110			6	-10	✓		
P33-106			8.5	-6	✓		
P33-102			10	-2	✓		✓
P33-108			35	-8	✓		✓
P48-100	0.064 / 1.56	0.250 / 6.35	1	-0	✓		
P48-117			4	-17	✓		
P48-110			6	-10	✓		
P48-106			8.5	-6	✓		
P48-103			35	-3	✓		
P68-100	0.098 / 2.43	0.250 / 6.35	1	-0	✓		
P68-117			4	-17	✓		
P68-110			6	-10	✓		
P68-106			8.5	-6	✓		
P68-108			35	-8	✓		✓
P810-210	0.125 / 3.11	0.312 / 7.92	6	-10	✓		
P816-340	0.136 / 3.39	0.500 / 12.70	60	-40			✓
P825-117	0.136 / 3.39	0.775 / 19.69	4	-17	✓		
P825-110			6	-10	✓		
P825-108			35	-8	✓		✓
P825-142			40	-42	✓		
P825-140			60	-40			✓
P912-102	0.147 / 3.67	0.375 / 9.52	10	-2	✓		✓
P1012-102	0.157 / 3.93	0.375 / 9.52	10	-2	✓		✓
P1216-140	0.190 / 4.77	0.500 / 12.70	60	-40			✓

Plain Core

(continued)

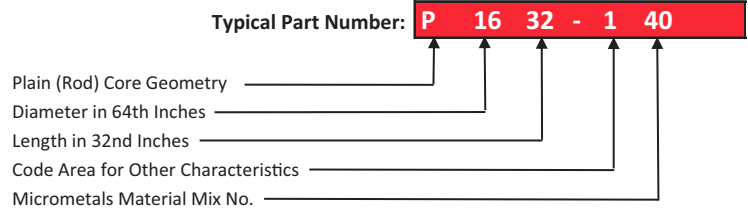
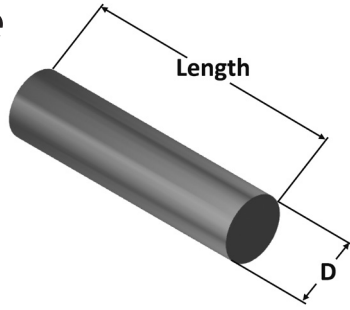

Part Number	Physical Dimensions		Ref. Perm.	Material	Product Group		
	D (in/mm) max	L (in/mm) nom			RF	PC	200C
P1224-100	0.190 / 4.77	0.750 / 19.05	1	-0	✓		
P1224-117			4	-17	✓		
P1224-102			10	-2	✓		✓
P1224-101			20	-1	✓		
P1224-103			35	-3	✓		
P1224-108			35	-8	✓		✓
P1224-140			60	-40			✓
P1224-340/9			60	-40			✓
P1224-152			75	-52			✓
P1234-110	0.190 / 4.77	1.063 / 27.00	6	-10	✓		
P1338-240	0.200 / 5.02	1.200 / 30.48	60	-40			✓
P1621-140	0.250 / 6.29	0.669 / 16.99	60	-40			✓
P1624-102	0.250 / 6.29	0.750 / 19.05	10	-2	✓		✓
P1624-140			60	-40			✓
P1632-102	0.250 / 6.29	1.000 / 25.40	10	-2	✓		✓
P1632-140			60	-40			✓
P1624-240	0.255 / 6.42	0.750 / 19.05	60	-40			✓
P1624-340/9			60	-40			✓
P1628-340/9	0.255 / 6.42	0.875 / 22.22	60	-40			✓
P1632-340/9	0.255 / 6.42	1.000 / 25.40	60	-40			✓
P1632-240			60	-40			✓
P1640-206	0.255 / 6.42	1.250 / 31.75	8.5	-6	✓		
P1640-201			20	-1	✓		
P1640-240			60	-40			✓
P1648-210	0.255 / 6.42	1.500 / 38.10	6	-10	✓		
P1648-202			10	-2	✓		✓
P1648-240			60	-40			✓
P2028-102	0.309 / 7.79	0.875 / 22.22	10	-2	✓		✓
P2024-240	0.313 / 7.89	0.750 / 19.05	60	-40			✓
P2032-240	0.313 / 7.89	1.000 / 25.40	60	-40			✓
P2040-240	0.313 / 7.89	1.250 / 31.75	60	-40			✓
P2060-240	0.313 / 7.89	1.875 / 47.63	60	-40			✓
P2440-106	0.370 / 9.34	1.250 / 31.75	8.5	-6	✓		
P2432-202	0.375 / 9.46	1.000 / 25.40	10	-2	✓		✓
P2432-240			60	-40			✓
P2440-202	0.375 / 9.46	1.250 / 31.75	10	-2	✓		✓
P2440-201			20	-1	✓		
P2440-218			55	-18			✓
P2440-240			60	-40			✓
P2448-202	0.375 / 9.46	1.500 / 38.10	10	-2	✓		✓
P2448-240			60	-40			✓
P2448-238			85	-38			✓

Plain Core

(continued)

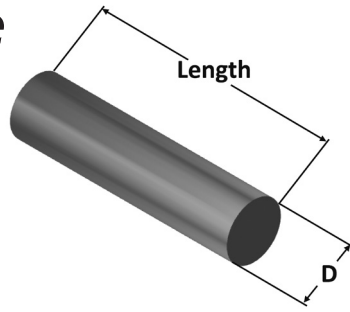

Typical Part Number: **P 16 32 - 1 40**

Plain (Rod) Core Geometry → P
 Diameter in 64th Inches → 16
 Length in 32nd Inches → 32
 Code Area for Other Characteristics → - 1
 Micrometals Material Mix No. → 40

Part Number	Physical Dimensions		Ref. Perm.	Material	Product Group		
	D (in/mm) max	L (in/mm) nom			RF	PC	200C
P2456-240	0.375 / 9.46	1.750 / 44.45	60	-40		✓	
P3232-106	0.500 / 12.64	1.000 / 25.40	8.5	-6	✓		
P3240-117	0.500 / 12.64	1.250 / 31.75	4	-17	✓		
P3240-102			10	-2	✓		✓
P3240-108			35	-8	✓		✓
P3240-140			60	-40			✓
P3248-140	0.500 / 12.64	1.500 / 38.10	60	-40			✓
P3252-140	0.500 / 12.64	1.625 / 41.28	60	-40			✓
P3256-102	0.500 / 12.64	1.750 / 44.45	10	-2	✓		✓
P3256-140	0.500 / 12.64	1.750 / 44.45	60	-40			✓
P3264-107	0.500 / 12.64	2.000 / 50.80	9	-7	✓		
P3264-102			10	-2	✓		✓
P3264-140			60	-40			✓
P4040-102	0.625 / 15.81	1.250 / 31.75	10	-2	✓		✓
P4040-140			60	-40			✓
P4040-126			75	-26			✓
P4048-140	0.625 / 15.81	1.500 / 38.10	60	-40			✓
P4054-140	0.625 / 15.81	1.700 / 43.18	60	-40			✓
P4840-102	0.750 / 18.99	1.250 / 31.75	10	-2	✓		✓
P4848-102	0.750 / 18.99	1.500 / 38.10	10	-2	✓		✓
P4848-140			60	-40			✓
P4868-140	0.750 / 18.99	2.125 / 53.97	60	-40			✓
P4876-140	0.750 / 18.99	2.375 / 60.32	60	-40			✓
P4876-126			75	-26			✓
P6432-140	1.000 / 25.34	1.000 / 25.40	60	-40			✓
P6448-102	1.000 / 25.34	1.500 / 38.10	10	-2	✓		✓
P6464-140	1.000 / 25.34	2.000 / 50.80	60	-40			✓
P6464-126			75	-26			✓
P10032-118	1.575 / 39.88	1.000 / 25.40	55	-18			✓
P14432-102	2.270 / 57.41	1.000 / 25.40	10	-2	✓		✓
P19236-126	3.060 / 77.24	1.150 / 29.21	75	-26			✓
P19248-102	3.060 / 77.24	1.500 / 38.10	10	-2	✓		✓

Micrometals Alloy Powder Cores

Micrometals also offers a full line of Alloy Powder Cores – visit www.micrometalsAPC.com for more information. Our Alloy Powder Cores are available in several industrial standard shapes including Toroid, E, EQ, PQ and blocks.

Additionally, Micrometals can provide prototypes, custom shapes and material formulations for Alloy powder products to meet demanding application needs.

Our Newest Alloy Offerings

Micrometals continues to lead the industry in new products and material formulations to help support advances in technology and emerging applications in 48V-12VDC electric vehicle systems, high frequency power supplies, and 5G telecommunication network equipment. Our newest offerings include new shapes and materials specifically designed to deliver exceptional performance and value.

These new materials, and all iron and alloy materials and shapes, are represented in our inductor design software to allow total solution optimization for your design challenges.

New Alloy Material Shapes

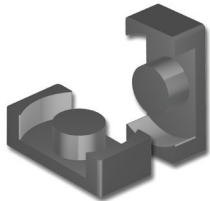

EQ Cores

The rectangular geometry of **EQ cores** are ideally suited for surface mount applications while their round center post readily accepts helical flat wire coils, or bobbins with round wire. Micrometals offers EQ cores in six industry standard geometries from 20mm to 50mm, and three material formulations of Sendust (MS), Hi-Flux™ (HF) and FluxSan™ (FS - Iron Silicon) with 26, 40 or 60 permeability values. Custom or modified EQ cores can also be designed for your specific application.

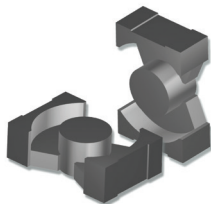

PQ Cores

Micrometals Alloy **PQ cores** are ideal for transformers in switch-mode power supplies and can be used in both standard wire-wound transformers in AC-DC and DC-DC converters and for planar transformers.

The main advantage of Micrometals PQ cores is the round center leg combined with larger outer surfaces which requires less windings for the same resulting inductance as compared to EQ cores.

The larger perimeter provides better heat dissipation and the same performance as an E core but with smaller dimensions and less weight. Custom or modified PQ cores can also be designed for your specific application.

New Alloy Materials

Optilloy™ Optimized Alloys

Optilloy materials are unique Micrometals hybrid formulations of iron, silicon, aluminum and nickel that deliver the highest level of performance for specific design traits without increasing cost/performance in areas that are not critical to the application. They are available in toroid shapes up to 154mm.

- OD Material – Provides optimized DC Bias while keeping cost and core loss at reasonable levels. OD material DC bias is similar to Hi-Flux materials but at a lower cost and lower loss.
- OC Material – Provides optimized Core Loss while keeping costs and DC bias at reasonable levels. OC material has core losses similar to Sendust but with improved DC bias.
- OE Material – Optimized for Low Cost while keeping core loss and DC bias at reasonable levels. OE material delivers cost that is similar to Sendust but with improved DC bias.



At Micrometals, quality is paramount. Micrometals' Quality Assurance team works closely with Engineering to ensure products meet or exceed all customer requirements. Our QA Team continually tests products in every stage, from design to prototype, and from set-up to final inspection, to assure the highest quality of products. All Micrometals factories are certified to the ISO9001:2015 quality management standard.



Micrometals Anaheim

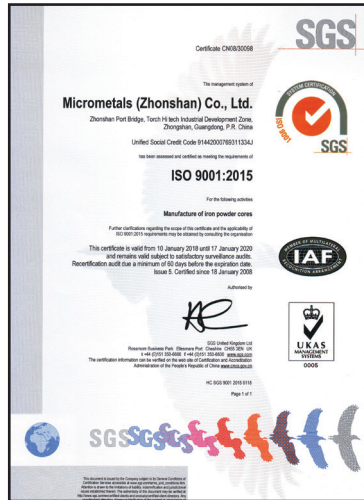

Micrometals Zhonshan



Micrometals Alloy Powder Cores

Micrometals' Engineering and Quality teams will work with you to provide required certifications and documentation.

To better serve our automotive-related customers, Micrometals Alloy Powder Cores is certified to the IATF 16949:2016 Automotive Quality Management Standard.

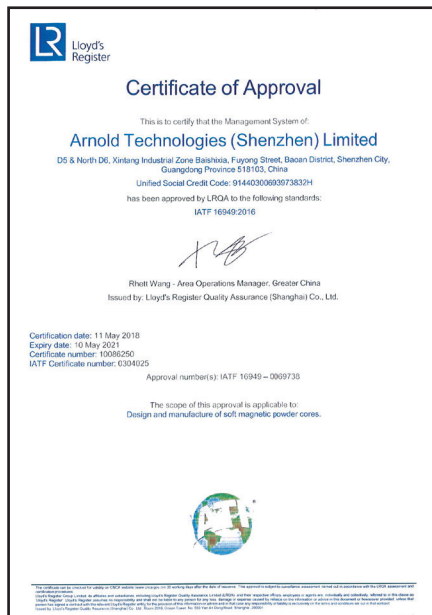

Micrometals Alloy Powder Cores IATF 16949:2016 Certification

Visit www.micrometals.com to review our global distribution network to locate your regional representative

LIMITED AND EXCLUSIVE WARRANTY AND REMEDY

Micrometals Inc. warrants that any services and products furnished conform to reasonable industry standards and that the products will be free from defects in material and workmanship. THIS WARRANTY IS IN LIEU OF ANY OTHER OBLIGATION AND ALL OTHER WARRANTIES FROM MICROMETALS INC., INCLUDING ANY WARRANTY OF MERCHANTABILITY OR FITNESS FOR A PARTICULAR PURPOSE. Notice of nonconformance must be made within 30 days after delivery.

Micrometals Inc. will, at its option, (i) re-perform the services, (ii) repair or replace free of charge (excluding all shipping and handling costs) any products which in its sole determination were not manufactured in compliance with the above warranty and were not subject to misuse, abuse, or unauthorized modification, or (iii) refund the amounts paid for such services or products.

THE FOREGOING REMEDY IS THE EXCLUSIVE REMEDY FOR ANY BREACH OF WARRANTY OR ANY CLAIM ARISING IN ANY WAY OUT OF THIS QUOTE AND ANY PRODUCTS AND SERVICES FURNISHED. Except for the limited remedy, in no event shall Micrometals Inc. be liable for consequential, incidental, or any other damages of any nature whatsoever arising in any way out of the manufacture, sale or use of these products and services. No other person is authorized by Micrometals Inc. to give any other warranty, written or oral, pertaining to products or the performance of services.

Before using these products, buyer agrees to determine suitability of the product for their intended use or application. Micrometals Inc., shall not be liable for any other loss or damage, including but not limited to incidental or consequential damages. Micrometals and the

Micrometals logo, name and imagery are trademarks of Micrometals Inc.

Micrometals, Inc.
5615 E. La Palma Ave.
Anaheim CA 92807 USA
Phone: +1-714-970-9400
www.micrometals.com
sales@micrometals.com

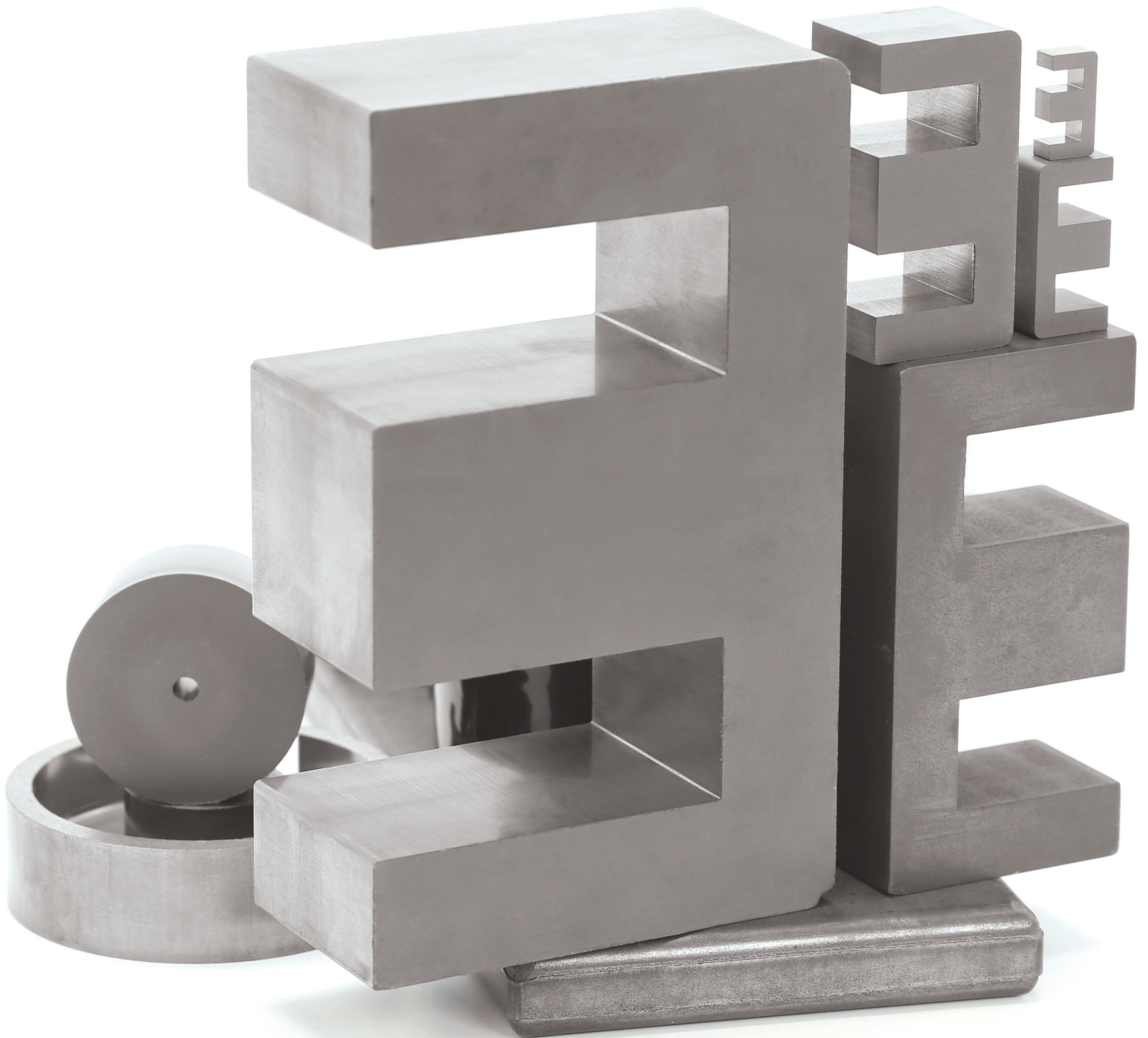

Micrometals, Inc.

5615 E. La Palma Ave. | Anaheim CA 92807 USA | Phone: +1-714-970-9400

www.micrometals.com | sales@micrometals.com