



# 2N7002DW

## 60V N-Channel Enhancement Mode MOSFET

### FEATURES

- $R_{DS(ON)}$ ,  $V_{GS}@10V, I_{DS}@500mA=5\Omega$
- $R_{DS(ON)}$ ,  $V_{GS}@4.5V, I_{DS}@75mA=7.5\Omega$
- Advanced Trench Process Technology
- High Density Cell Design For Ultra Low On-Resistance
- Specially Designed for Battery Operated Systems, Solid-State Relays Drivers : Relays, Displays, Lamps, Solenoids, Memories, etc.

### MECHANICAL DATA

- Case : SOT-363 Package
- Terminals : Solderable per MIL-STD-750, Method 2026
- Apporx. Weight : 0.0002 ounces , 0.006grams
- Marking : 702

### SOT-363

Unit : inch(mm)

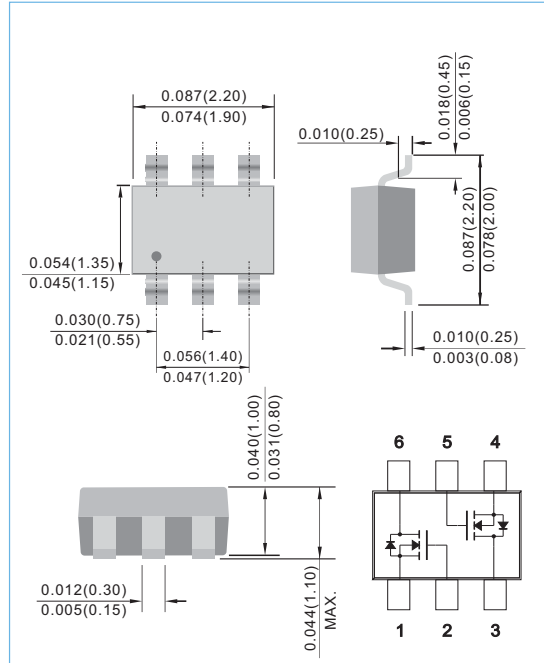

### Maximum RATINGS and Thermal Characteristics ( $T_A=25^\circ\text{C}$ unless otherwise noted )

PARAMETER	Symbol	Limit	Units
Drain-Source Voltage	$V_{DS}$	60	V
Gate-Source Voltage	$V_{GS}$	$\pm 20$	V
Continuous Drain Current	$I_D$	115	mA
Pulsed Drain Current <sup>1)</sup>	$I_{DM}$	800	mA
Maximum Power Dissipation	$P_D$	200 120	mW
Operating Junction and Storage Temperature Range	$T_J, T_{STG}$	-55 to + 150	$^\circ\text{C}$
Junction-to Ambient Thermal Resistance(PCB mounted) <sup>2</sup>	$R_{\theta JA}$	625	$^\circ\text{C/W}$

- Note: 1. Maximum DC current limited by the package  
2. Surface mounted on FR4 board,  $t < 10$  sec

**PAN JIT RESERVES THE RIGHT TO IMPROVE PRODUCT DESIGN,FUNCTIONS AND RELIABILITY WITHOUT NOTICE**



# 2N7002DW

## ELECTRICAL CHARACTERISTICS

Parameter	Symbol	Test Condition	Min.	Typ.	Max.	Units
<b>Static</b>						
Drain-Source Breakdown Voltage	$BV_{DSS}$	$V_{GS}=0V, I_D=10\mu A$	60	-	-	V
Gate Threshold Voltage	$V_{GS(th)}$	$V_{DS}=V_{GS}, I_D=250\mu A$	1	-	2.5	V
Drain-Source On-State Resistance	$R_{DS(on)}$	$V_{GS}=4.5V, I_D=75mA$	-	-	7.5	$\Omega$
Drain-Source On-State Resistance	$R_{DS(on)}$	$V_{GS}=10V, I_D=500mA$	-	-	5	
Zero Gate Voltage Drain Current	$I_{DSS}$	$V_{DS}=60V, V_{GS}=0V$	-	-	1	$\mu A$
Gate Body Leakage	$I_{GSS}$	$V_{GS}=\pm 20V, V_{DS}=0V$	-	-	$\pm 100$	nA
Forward Transconductance	$g_{fs}$	$V_{DS}=15V, I_D=250mA$	200	-	-	mS
<b>Dynamic</b>						
Total Gate Charge	$Q_g$	$V_{DS}=15V, I_D=500mA$ $V_{GS}=5V$	-	0.6	0.7	nC
Gate-Source Charge	$Q_{gs}$		-	0.1	-	
Gate-Drain Charge	$Q_{gd}$		-	0.08	-	
Turn-On Delay Time	$t_{on}$	$V_{DD}=10V, R_L=20\Omega$ $I_D=500mA, V_{GEN}=10V$ $R_G=10\Omega$	-	9	15	ns
Turn-Off Delay Time	$t_{off}$		-	21	26	
Input Capacitance	$C_{iss}$	$V_{DS}=25V, V_{GS}=0V$ $f=1.0MHz$	-	-	50	pF
Output Capacitance	$C_{oss}$		-	-	25	
Reverse Transfer Capacitance	$C_{rss}$		-	-	5	
<b>Source-Drain Diode</b>						
Max. Diode Forward Current	$I_s$	-	-	-	250	mA
Diode Forward Voltage	$V_{SD}$	$I_s=250mA, V_{GS}=0V$	-	0.93	1.2	V

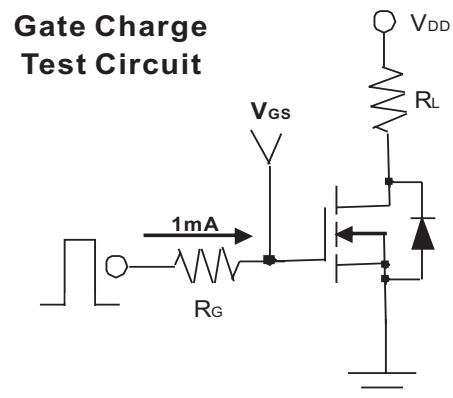
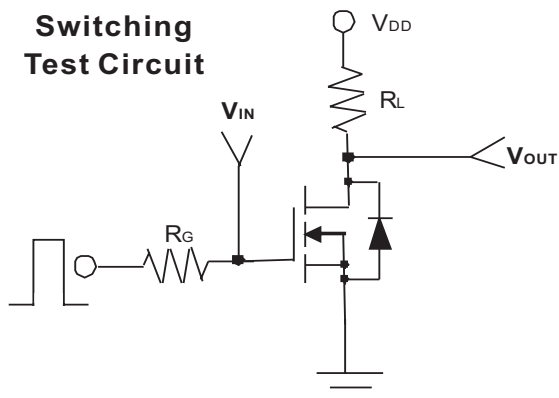



# 2N7002DW

Typical Characteristics Curves ( $T_J=25^\circ\text{C}$ , unless otherwise noted)

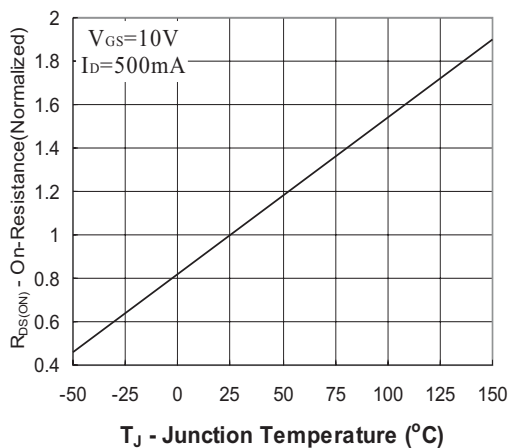
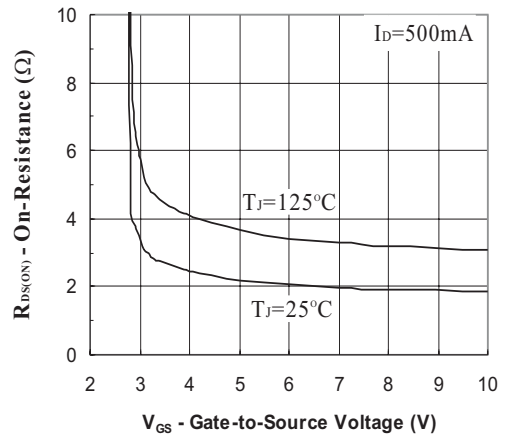
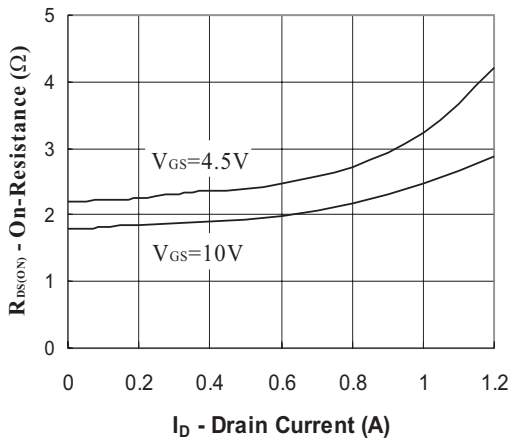
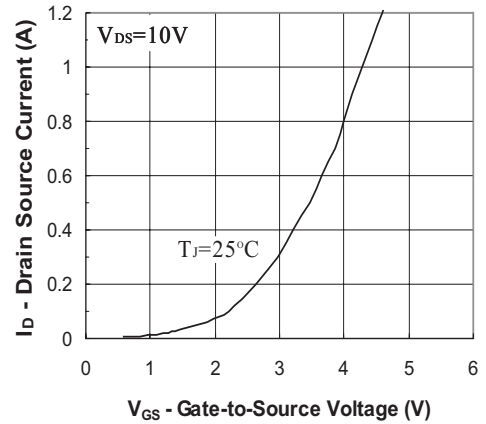
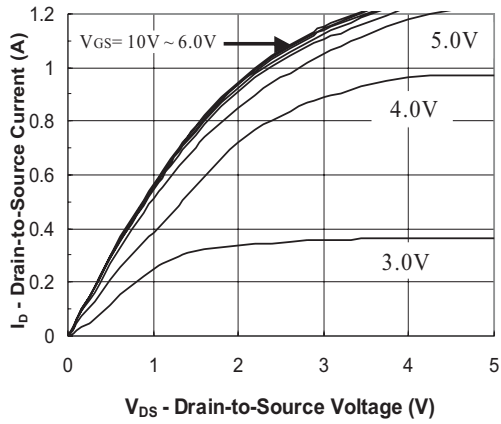



# 2N7002DW

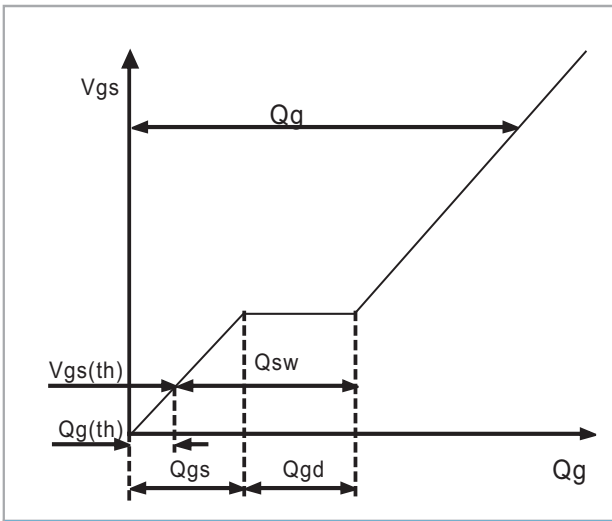

Fig.6 - Gate Charge Waveform

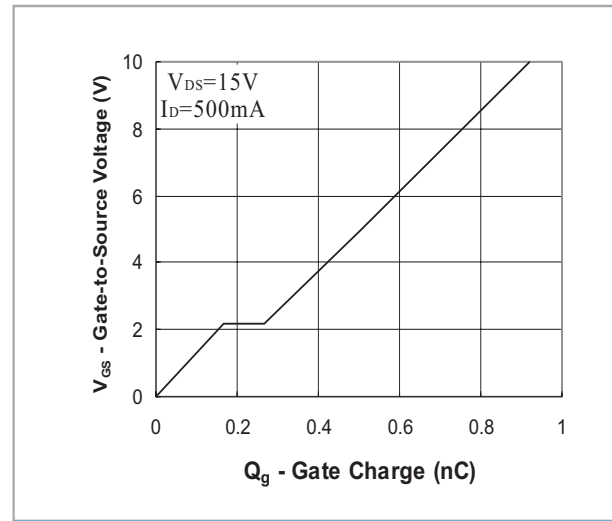

Fig.7 - Gate Charge

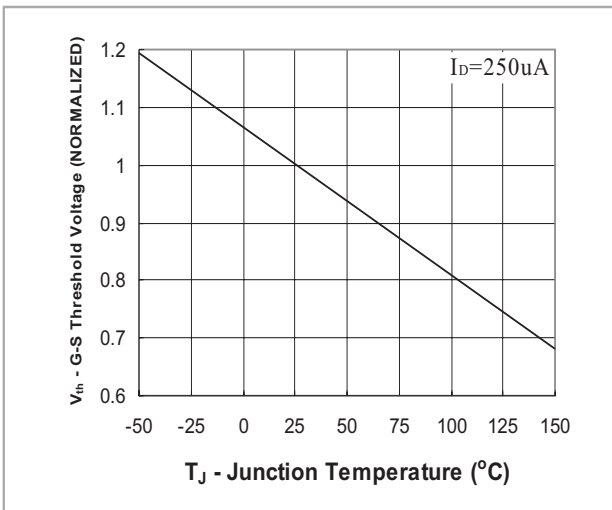

Fig.8 - Threshold Voltage vs Temperature

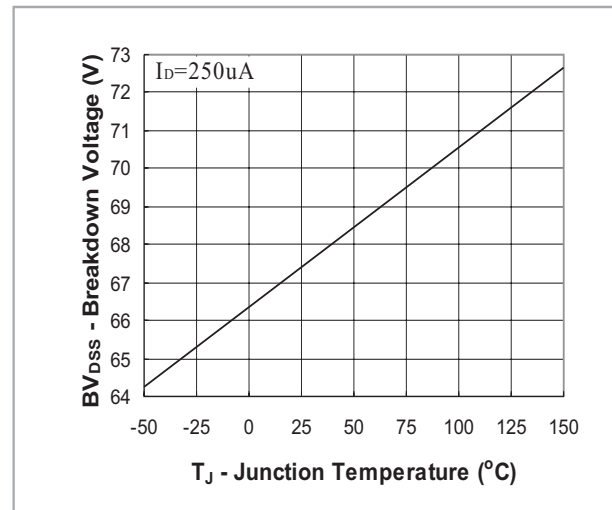

Fig.9 - Breakdown Voltage vs Junction Temperature

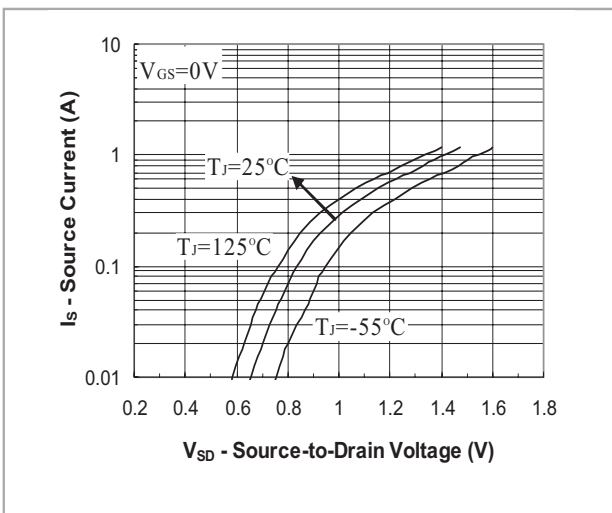
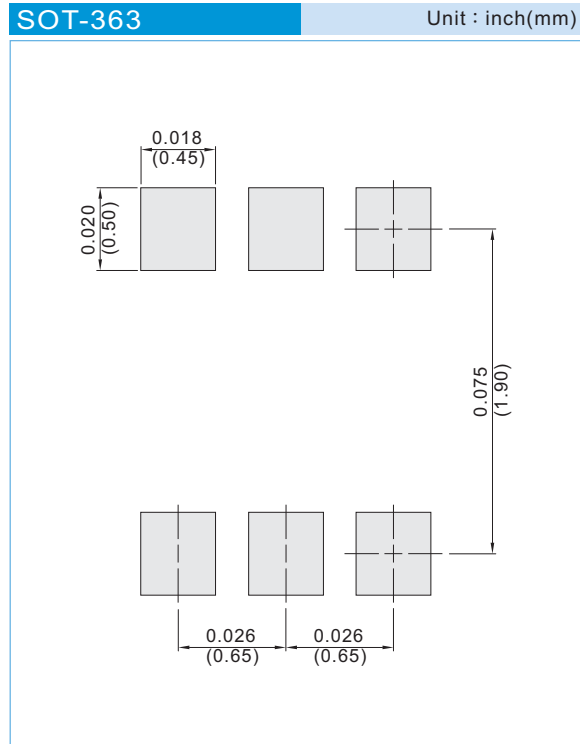

Fig.10 - Source-Drain Diode Forward Voltage



# 2N7002DW

## MOUNTING PAD LAYOUT



## ORDER INFORMATION

- Packing information  
T/R - 10K per 13" plastic Reel  
T/R - 3K per 7" plastic Reel

## LEGAL STATEMENT

### Copyright PanJit International, Inc 2012

The information presented in this document is believed to be accurate and reliable. The specifications and information herein are subject to change without notice. Pan Jit makes no warranty, representation or guarantee regarding the suitability of its products for any particular purpose. Pan Jit products are not authorized for use in life support devices or systems. Pan Jit does not convey any license under its patent rights or rights of others.