

ESB00163 16A

ESB00323 32A

Inrush Current Limiter, Inrush Protector, 3-phase 200/400/500Vac
For inductive & capacitive loads, 16A/32A -40°C...+70°C

Short Specification:

- Peak- / RMS Value Limiter
- Integrated Phase Control Circuit
- 200/400/500Vac 3PH 16A/32A nominal Voltage
- DIN TS35mm Rail
- Federzugklemmen 0,5...16mm²
- Integrated Bypass-Relay
- Capacitive Load 2.000uF
- Built-In Temperature Control Circuit
- IP20 Housing

The ESB is a budget-priced inrush peak current limiter for high loads in LED-applications, complex automation systems and in the machine building. The ESB offers high recommended and interference free operation with both, the inductive and the capacitive load. It is simple to integrate into existing equipment. The ESB is self-powering and does not require an external power supply.

Integrated Phase Controller

No simple NTC-Version!
A Camtec-ESB allows effective reduction of cabling cross sections. It allows using quicker circuit breakers. The ESB prevents from tripping the circuit breakers by high inrush.



In accordance with IEC60950-1

Technical Data Table

| Model | ESB00163A.T | ESB00163B.T | ESB00323A.T | ESB00323B.T |
|--|--|--------------------------|--|--------------------------|
| Article Number | 3041099011 | 3041099001 | 3041099012 | 3041099002 |
| AC Input Range | 170-230/340-460/425-575Vac | 170-230/340-460Vac | 170-230/340-460/425-575Vac | 170-230/340-460Vac |
| AC Nominal Voltage | 200/400Vac/500Vac | 200/400Vac | 200/400/500Vac | 200/400Vac |
| Ambient Temperature | -40°C...+55°C continuous | -40°C...+70°C continuous | -40°C...+55°C continuous | -40°C...+70°C continuous |
| Derating | +45°C 2,5%/°C | +60°C 2,5%/°C | +45°C 2,5%/°C | +60°C 2,5%/°C |
| Peak Current Limiting ±6% | 22,6A | | 68,6A | |
| R.M.S Current Limiting ±6% | 16A | | 48A | |
| Allowed Capacitive Load (max.) | 1.500µF | | 2.000µF | |
| Limiting Time (T _{on} Power On) | 70-240ms adjustable (150ms Factory Setting) Tolerance ±10ms | | 70-240ms adjustable (150ms Factory Setting) Tolerance ±10ms | |
| Release Time (T _{off} Low Voltage) | 65-170 adjustable (100ms Factory Setting) Tolerance ±10ms | | 65-170 adjustable (100ms Factory Setting) Tolerance ±10ms | |
| Limiting Interval [T _{interval} for AC _{cont.}] | ≥ 1000ms | | ≥ 1000ms | |
| Smallest advisable Circuit Breaker at 30°C | A8A B6A Z8A | | A22A B16A Z22A | |
| Line Frequency | 50/60Hz | | 50/60Hz | |
| AC Continuous Current | 16A continuous | | 32A continuous | |
| Power Supply | self-powered | | | |
| Power Consumption | typ. 7W (constant @ nominal operation) | | | |
| Limiting Cycles | 1 cycle/minute with maximum capacitive load | | | |
| Internal Protection | temperature protection and burn proof fuse in each AC-line | | | |
| Cooling | Natural convection | | | |
| Operation Temp. | nominal ambient temperature -40°C...+70°C | | | |
| Storage Temp. | -40°C...+85°C 2 years | | | |
| EMI | EN55022 Klasse B | | | |
| EMS | EN61000-6-2,3 | | | |
| Safety Norms | IEC/EN60950-1 in accordance to cUL60950, EN60204-1 | | | |
| Safety Class II | VDE0805, VDE0100/ÖVE8001 | | | |
| MTBF Calculation | 377.000h (IEC/EN61709, Siemens SN29500) | | | |
| MTTF Calculation | 396.000h (+30°C) (IEC/EN61709, Siemens SN29500) | | | |
| Humidity | 95% (+25°C) non condensing | | | |
| Pollution Degree | 2 (IEC/EN50178) | | | |
| Environmental | climatic 3K3, mechanics 3M4 (IEC/EN60721) | | | |
| Altitude max. | 3000m (9842 ft.) above sea level | | | |
| Dimension (BxHxT) | 95x155x122mm | | | |
| Housing Parameters | aluminum-metal housing | | | |
| DIN-Rail | DIN rail TS35mm DIN/EN60715 (TS35/7,5 und TS35/15) | | | |
| Weight | 1100g netto | | | |
| Connections | spring-type terminal with cable protection 0,5...16mm ² 22...8AWG according with IEC/EN60664-1, IEC/EN61984 | | | |

General Description:

The CAMTEC ESB-series are the 2nd generation and cost effective inrush current limiters. The limiters are made for 200/400/500Vac 16A networks (input selectable via input switch). The line frequency is 50/60Hz. The ESB-Limiter shall be located between the line-switcher/contactator and the load. The ESB-models are designed for inductive and capacitive loads. In the moment of switching-on the system the inrush current of the installed load will be limited for the defined time T_{on}. Independent from the previous inrush level; the current limiting is always strict. After T_{on} elapses the current limiting circuit of the ESB will be bypassed. Then the load is directly connected to the AC. The electrical network can be stressed with current loads as normal (e.g. motors, pumps). If an AC dump overshoots the defined time T_{off}, it will be detected by the ESB. As soon as the AC recovers the inrush will be limited, again. The ESB-models provide an internal temperature control. In case of a failure the device shuts down to safely prevent from overheating or burning.

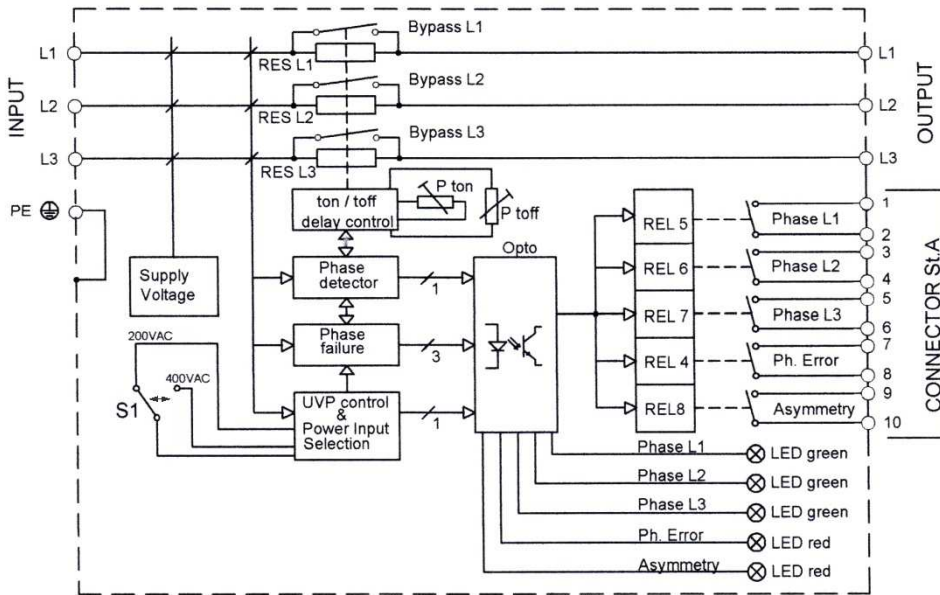

Field Applications:

The ESB limiter allows connecting much more loads (e.g. LED-power supply / LED-driver) to a pre-installed circuit breaker CB. The ESB definitely avoids that the CB can be tripped. This occurs independently from the objective initial current. The result is that the number of A.C. branch lines and the pre-installed CB can be reduced dramatically. Installation cost exhibit a sustained decline.

Alternatively the cross section of the branch lines can be reduced when using smaller and faster responding circuit breakers. The cost saving from copper is essential. Sensitive AC networks can be fused safer (e.g. Traffic Control Systems, Street-Lighting, Parking Lots and Tunnels)

When the ESB is installed correctly, the neutral wire (N) is looped through (Fig.1). The inrush protection circuit always acts to the line conductor. The load is connected with the AC in such a way that a circuit breaker or an earth-leakage-trip works within the limits of the legal rules. This fact is also applied while the limiting circuit acts.

Integrated Phase Control:

The 3-phase ESBs have an integrated phase control circuit with basic functions. Each phase is controlled separately. Each phase is limited separately. The error signals are given for each phase an independent. This provides a connected SPC access to display complex and interlinked failures in a major control room. The different signaled failures will be described on page 4 of this manual.

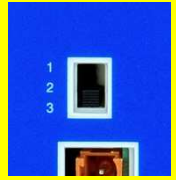
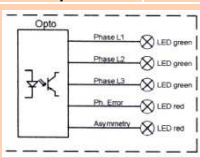
| Signal Output Table | | | | | | AC Input Selector Settings | | | |
|--|---------------|--|-------------|---|--|----------------------------|--|--|--|
| PIN CTRL | O.K. | LED | FAILURE | LED | | | | | |
| 1,2 L1 | Relais closed | ON | Relais open | OFF | ESB00163A.T / ESB00323A.T | ESB00163B.T / ESB00323B.T | | | |
| 3,4 L2 | Relais closed | ON | Relais open | OFF | 1 = 200Vac | 1 = 200Vac | | | |
| 5,6 L3 | Relais closed | ON | Relais open | OFF | 2 = 400Vac | 2 = not selectable | | | |
| 7,8 Phase Error | Relais closed | OFF | Relais open | ON | 3 = 500Vac | 3 = 400Vac | | | |
| 9,10 Asymmetry | Relais closed | OFF | Relais open | ON | <p>The input selector enables to set the AC Input voltage auf the models. It is located above the phase error Connection. Please make sure that the input is set to the correct AC voltage before taking the device into operation. A wrong setting may cause serious damages to the device!</p>  | | | | |
| Line Inputs | | Line Outputs | |  | | | | | |
| PE = GND L1 = Phase 1 L2 = Phase 2 L3 = Phase 3 | | L1 = Phase 1 L2 = Phase 2 L3 = Phase 3 | | | | | | | |

Operation with SPC to safeguard AC-failures:

The signals "Phase-Error" and "Asymmetry-Error" can be used to trigger an external contactor. The installed load will be disconnected if an error occurs. As soon as the error recovers the installed load will be reconnected to the AC.
(find attached pictures „Phase-Loss &-sequence“ and „Asymmetry, Over-/Low Voltage“. The contactor is always named K2.)

Phase Loss & Sequence

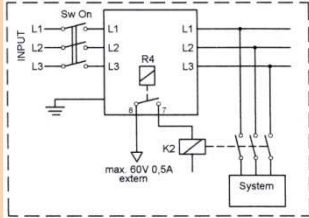

In case of phase loss relay 4 opens after a delay time of 30ms. Synchronistic the relay of the appropriate phase opens, too and its green LED extinguishes. When the phase sequence is incorrect, relay 4 opens after a delay time of 30ms. The Phase Error LED lights red. When the phase sequence is correct the LED is off and the relay 4 is closed.

Asymmetry, Over-/Low Voltage

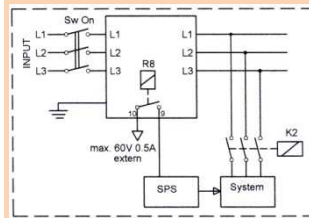

The asymmetry monitoring detects a voltage difference of the three phases to each other. This kind of measuring enables work without the N line (four wire system). If the voltage of the measured AC line drops or exceeds 15% of its nominal selected input relay 8 opens 8-10s delayed and the Asymmetry LED lights red. Measuring tolerances are $\pm 2\%$.

Phase Loss Message Block

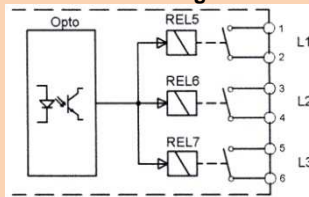

Relay 5 to 7 are galvanic insulated via opto couplers. If L1 to L3 are operating the relays are closed. If one phase drops its relay opens and the message can be used with an active signal (60V/500mA maximum load each relay).

Monitoring L1

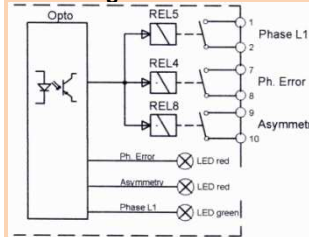

Phase Monitoring L1 O.K.:
REL4,5 closed, LED green on
Phase Error LED red off

Phase Monitoring L1 Loss:
REL4,5 open, LED green off
Phase Error LED red on
Asymmetry REL8 remain closed,
LED off

Phase Sequence Monitoring

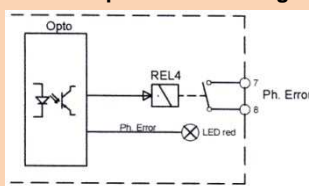

Sequence o.k.:
L1,L2,L3 o.k. REL4 closed
Phase Error LED red off

Phase Reversal:
L1 failure
L2 o.k.
L3 failure (sum failure)
REL4 open
Phase Error LED red on

Monitoring L2

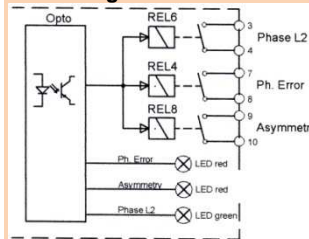

Phase Monitoring L2 O.K.:
REL4,6 closed, LED green on
Phase Error LED red off

Phase Monitoring L2 Loss:
REL4,6 open, LED green off
Phase Error LED red on
Asymmetry REL8 remain closed,
LED off

Asymmetry, Over-/Low Voltage

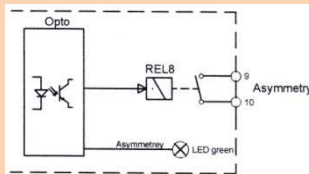

Low Voltage o.k.:
L1,L2,L3 sum o.k.
Asymmetry REL8 closed, LED off

Low Voltage failure (-15% drop):
L1 failure
L2 o.k.
L3 o.k. (but sum failure)
Asymmetry REL8 open, LED on

Overvoltage failure (+15% drop):
L1 failure
L2 o.k.
L3 o.k. (but sum failure)
Asymmetry REL8 open, LED on

Monitoring L3

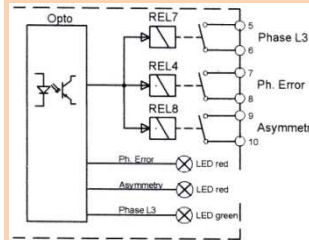

Phase Monitoring L3 O.K.:
REL4,7 closed, LED green on
Phase Error LED red off

Phase Monitoring L3 Loss:
REL4,7 open, LED green off
Phase Error LED red on
Asymmetry REL8 remain closed,
LED off

Line Diagram of Phase Monitoring

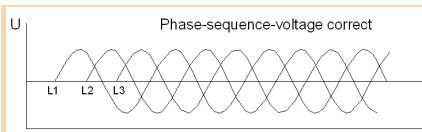

Sequence, Voltage and Asymmetry are o.k.:

No Failure:

All LEDs of L1, L2, L3 light green, all relays are closed and all red Error LED are off

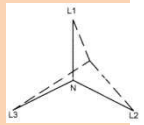

Asymmetry in AC line 4 Wire Systems (no N wire): Dissimilar phase load exists, when one phase is overloaded in comparison to the other phases of the 4 Wire System.

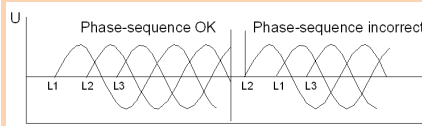

Sequence Monitoring:

Failure

Relay4 (Phase Error) opens after 30ms delay time and its error LED lights red

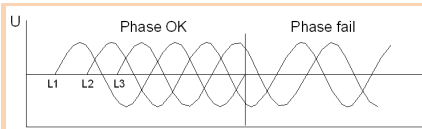

Phase Loss:

Failure

Relay4 (Phase Error) opens after 30ms delay time and its error LED lights red, belonging phase LEDs are off and its relays are open

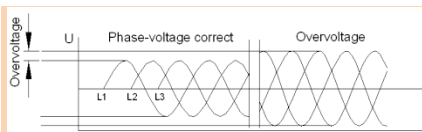

Low Voltage, Overvoltage and Asymmetry:

Failure

If voltage under-runs or exceeds $\pm 15\%$ of the selected rated voltage, Relay8 (Asymmetry) opens after 8-10s delay time and its error LED lights red

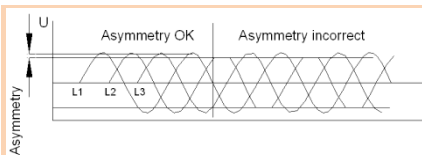

Rated Voltage

200Vac

400Vac

Low Voltage Operating Point

170Vac

340Vac

Over Voltage Operating point

230Vac

460Vac

Design-in of the ESB into AC-Networks

The ESB models are the precise inrush current limiter with an overall tolerance of $\pm 6\%$ of the face value. For the dimension of an upstream connected circuit breaker the R.M.S is the key value of the inrush current, not the peak current. The thermal trigger point will not be met, even while using an extreme fast CB. All-dominant is the magnetic trigger current. By using the empirical formula $I_{(peak)} \times 0,707_{(factor)} = I_{(r.m.s.)}$ the tripping current can be defined fairly exact. Bear in mind that all the higher the inrush current is, all the faster the input capacitor of a number of connected switch mode power supplies will be loaded. The technical table on page 2 shows the R.M.S value of all the ESB 3PH types and models.

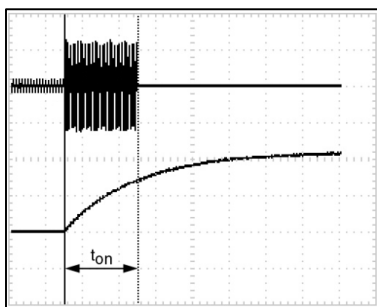

(Fig.5 limiting time T_{on})

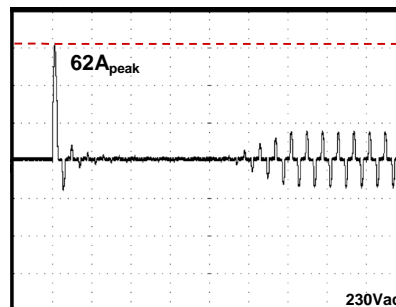

(Fig.7 inrush without an ESB)

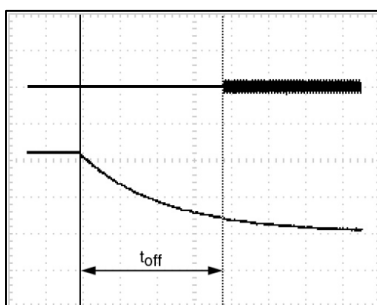

(Fig.6 AC dump detection T_{off})

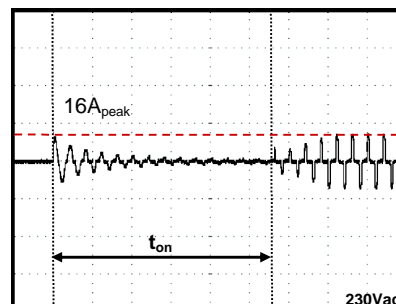

(Fig.8 inrush with an ESB)

Fig.7 and Fig.8

Fig.7 and Fig.8 show the typical start behaviour of a NTC protected switch mode power supply. The used test item is a CAMTEC HSE10001.24T with an output of 24V/42A (1008W) on DIN-Rail.

The peak current recordings show the precise limiting of the inrush from formerly $62A_{peak}$ to $16A_{peak}$. The corresponding R.M.S level, that is responsible for the magnetic tripping of the CB, is mark down by factor 0,707. After the time T_{on} elapsed it is identified that the power supply starts neatly into the continuous operation mode. Now the current is absorbed pulse-shaped from the AC. In detail the full load R.M.S. current consumption level of the HSE10001.

Adjusting the Ton and Toff – time value:

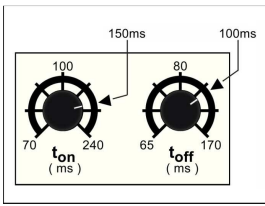

The Ton-time (limiting period) and the Toff-time (response time to arm the circuit after a phase lost or voltage drop) can be adjusted by the owner. The factory settings are Ton=150ms and Toff=100ms. Note: the adjusting range is non-linear.

Mechanics:

IP20 IEC standardized ventilation slots. Safe fit on DIN-Rail TS35mm DIN/EN60715.

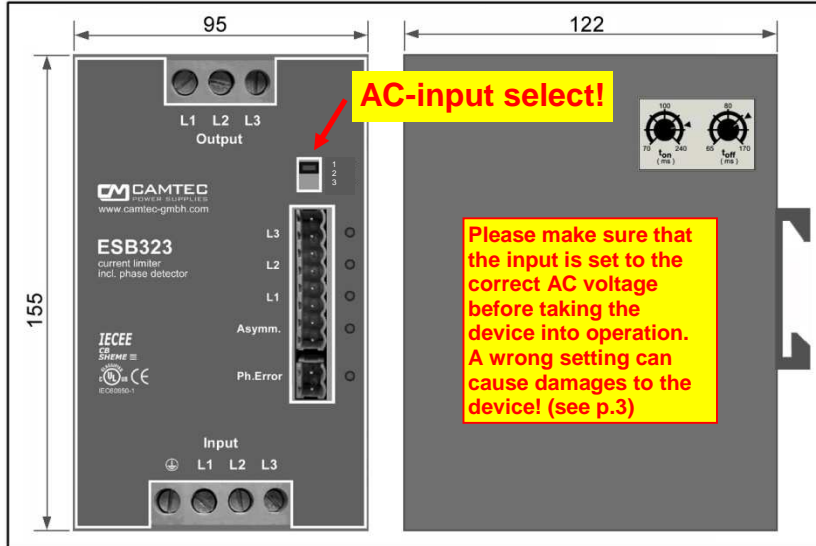

(picture 9 mechanical dimensions)

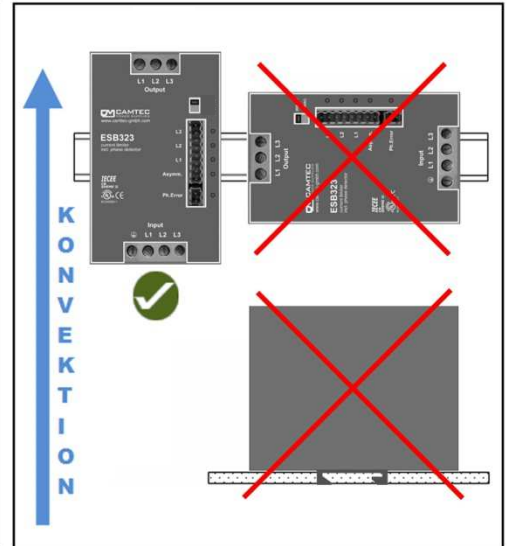

(picture 10 mounting direction)

Safety Tests (factory & owner)

| Test | Time | A | B | C |
|--------------|------|---------|---------|--------|
| Type Test | 60s | 2500Vac | 3000Vac | 500Vac |
| Factory Test | 5s | 2000Vac | 2000Vac | 500Vac |
| Field Test | 2s | 2000Vac | 2000Vac | 500Vac |

Type and Factory Tests are executed by the manufacturer. Do not repeat the tests in the field. To arrange the field test remain to the following rules:

- Use appropriate test equipment which apply the voltage with a slow ramp
- For every Test L1, L2, L3 at the input and at the output must be connected, Earth must be connected
- Use testing voltage with 50/60Hz frequency only. Note that the 3 Phase output is floating (exists no ohmic reference to Earth)

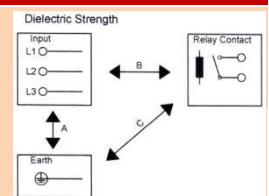

Safety Instructions:

Please read all warnings and advices carefully before installing or operating the ESB. Retain this operation manual always ready to hand. The ESB must be installed by specialist staff only.

Installation:

- Before connecting the ESB to the AC wire system make all wires free of voltage and assure accidentally switch on
- Before installing the ESB switch S1 to the appropriate AC input voltage (200/400Vac 50Hz).
- Connect the ESB inputs and Outputs to the AC line system. Assure that the phase sequence is correct. It is not allowed to operate the ESB without the Protected Earth wired!
- Switch the AC line system on and start running the ESB: the control LEDs of L1, L2, L3 should light green, the red LEDs of the Phase Error and the Asymmetry should be off. All relay contacts of the monitoring outputs are closed.
- In case of any control LEDs do not light like described in step 4, switch off the AC wire system and check your cabling

Warnings:

Disregard these warnings can cause fire, electric shock, serious accident and death.

- Never operate the ESB without Protective Earth
- Before connecting the ESB to the AC make all wires free of voltage and assure accidentally switch on
- Allow neat and professional cabling
- Never open nor try to repair the ESB by yourself. Inside are dangerous voltages that can cause electric shock
- Avoid metal pieces or any material to fall into the ESB
- Do not operate the ESB und damp or wet conditions
- The ESB must not be operated under Ex conditions or in Ex-Area

