



Catalog 2013

# HUBBELL

WIRING DEVICE-KELLEMS



# HUBBELL When reliability and performance matter



## HUBBELL

## SAFETY

## INSTALLATION EFFICIENCY

For more than a century, Hubbell Wiring Device-Kellems has offered distributors, end-user customers and specifiers the electrical and electronic wiring devices, wire management systems, and specialized wiring products and solutions needed for industrial, institutional, commercial, and residential markets.

Not only do Hubbell products and solutions make it easy to save time and money while ensuring consistency during installation – but they're also designed with safety and energy efficiency as top priorities.

Ensuring the safety of people and equipment while still effectively delivering power and technology is priority number one, which is why Hubbell products provide essential protection against injury and the dangers of electricity.



- Twist-Lock Devices
- Motor Disconnects
- Tamper-Resistant Receptacles
- Watertight Devices
- GFCI and Isolated Ground Receptacles
- Pin and Sleeve Devices

The labor-saving enhancements of Hubbell products keep renovation, modernization, and new construction projects on schedule and allow contractors to complete more jobs in a smaller amount of time.

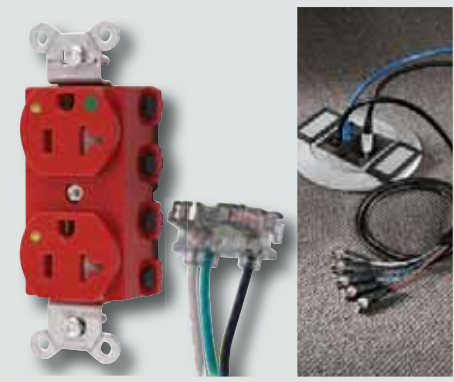

- Hubbell SNAPConnect® Receptacles
- Hubbell SystemOne Floor Boxes and Fire-Rated Poke-Throughs
- Pre-Wired Raceway
- Pre-Wired Work Box
- Wireless Sensor



## ENERGY EFFICIENCY



## DELIVERY



## DATACOM

Hubbell products are innovatively designed to maximize energy efficiency, reduce costs, and ultimately lead to a lower total cost of ownership.

Delivery systems from Hubbell offer safe and effective routing, management, delivery, and protection of a wide range of power, data, and AV solutions.

Hubbell's datacom solutions make up the most comprehensive product line available for commercial, institutional, and government applications, combining safety, efficiency, and cost savings.



- H-MOSS® Ceiling and Wall Sensors
- Wireless Sensors
- Hi-Bay Sensors
- USB Receptacle

- Floor Boxes
- Fire-Rated Poke-Throughs
- Surface Raceway
- Wall Duct
- FPTV Box
- Pre-Wired Work Box
- Table Top box

- Modular Jacks
- Audio/Video Keystone Connectors
- HDMI Connectors
- Hubbell iSTATION Modules and Plates
- Network Enclosures
- Network Modules

# Table of Contents – Sections Overview

## A Straight Blade Devices



- Heavy Duty Industrial Receptacles
- SNAP *Connect*® Receptacles
- Hubbell-PRO HD Specification Grade
- USB Receptacles
- Insulgrip® Plugs and Connectors

## B Twist-Lock® and Hubbelock® Devices



- Midget Twist-Lock® Devices
- Twist-Lock® Devices
- Mechanical Interlock Switched Safety Enclosures
- 50A Twist-Lock® Devices
- Hubbelock® Devices

## C Watertight Devices



- 15A and 20A, Straight Blade Devices
- 15A, 20A and 30A, Twist-Lock® Devices
- Portable Outlet Boxes and Covers
- Heavy Duty Portable Outlet Boxes & Plates

## D Switches



- SNAP *Connect*® Switches
- Heavy Duty Industrial Grade Switches
- Hubbell-PRO Heavy Duty Industrial Series
- Specification Grade Commercial Series
- Style Line® Decorator Series Specification Grade

## E H-MOSS® Controls



- Wireless Sensors and Controls
- Wall Switches
- Ceiling Sensors
- OPTIMYZER® High Bay Controls
- H-MOSS®|MAXX™ Occupancy Sensors

## F Switched Disconnects and Enclosures



- Circuit-Lock® Unfused Disconnects
- MotorQuick® Products
- Circuit-Lock® Fused Disconnects
- Hazardous Locations Devices
- AC Manual Toggle Controllers/Disconnects

## G Pin and Sleeve Devices/Mechanical Interlocks



- IEC Pin and Sleeve Watertight Devices
- Low Profile Pin and Sleeve Devices
- Mechanical Interlocks
- Insulgrip® Pin and Sleeve Devices
- Hazardous Locations Devices

## H Single Pole Devices and Temporary Power



- 150A, Series 15 Single Pole Devices
- 300 & 400A, Series 16 Single Pole Devices
- Spider® II Temporary Power Boxes
- Portable Outlet Boxes and Plates
- Pre-Wired Portable Boxes

## I Industrial Connectivity and Control Products



- LINKOSITY® Power Distribution System
- Mini-, Micro- & Nano-Quick Control Connectors
- CableTrak® Hose and Cable Carrier System
- PANEL-SAFE® Power & Data Access Ports
- HI-Impact Industrial Ethernet

## J Cable, Cord and Hose Reels



- Weatherproof Cable Reels
- Industrial Power Cord Reels
- Lighted Cord Reels
- Commercial Cord Reels
- Air/Water Hose and Static Discharge Reels

## K Ground Fault Products



- Industrial Tamper-Resistant Series
- Commercial LED Series
- Pre-Wired/Leaded LED Series
- SNAP *Connect*® GFCI Series
- GFCI Sensing Module
- GFCI Portable Products

## L Hospital Products



- Heavy Duty Hospital Grade Receptacles
- Hospital Grade Plugs and Connectors
- USB Receptacles
- Hospital Grade GFCIs
- Hubbelock® Devices

## M SpikeShield® Power Quality Products



- Service/Branch Panel Protection
- Surge Protection Plug Strips
- Surge Protection Receptacles
- Surge Protection Strips & Receptacles
- Isolated Ground Devices

## N Wallplates and Covers



- Nylon and Metal Wallplates
- Pre-Marked Wallplates
- Security Wallplates
- Weatherproof Plates
- Heavy Duty Weatherproof Covers

## O Floor Boxes



- Hubbell SystemOne Floor Boxes
- Flush Round and Rectangular Floor Boxes
- Convention Center Utility Box
- CONNEXION Zone Distribution System
- Furniture Connectivity Boxes

## P Fire-Rated Poke-Through (FRPT) Devices



- Hubbell SystemOne Recessed Systems
- Hubbell SystemOne FRPT
- 2X2 Flush FRPT
- Flush Duplex FRPT
- Flush Furniture Feed FRPT
- Painted or Brushed Aluminum Pedestal FRPT

## Q Aluminum Service Poles



- Aluminum Series Offering
- Specifications and Dimensional Information
- Custom Pole Configurations

## R Metal and Non-Metallic Raceway

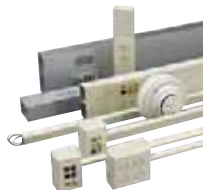

- Metal Raceway and PlugTrak®
- Aluminum Raceway and PlugTrak®
- Non-Metallic Raceway and PlugTrak®
- Pre-Wired Raceway

## S Trench and Wall Duct Products



- Key Features and Benefits
- HBL Trench Duct Series
- Hubbell Wall Duct Series
- Hubbell Duct Ordering Process

## T Wire Basket Tray



- Key Features and Benefits
- Pre-Galvanized Wire Basket Trays
- Supports and Brackets
- Accessories
- Create a Bill of Material

## U Hose and Cable Protection Systems

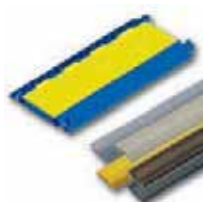

- AccessTrak® System
- TrukTrak® System
- TredTrak® System
- FloorTrak® System

## V Wire Management Products



- Pulling Grips and Support Grips
- Fiber Optic Cable Grips
- Strain Relief for Flexible Cords
- Cord Connectors
- Non-Metallic Liquidtight Conduit and Tubing

## W Network Wiring and netSELECT® Products



- Jacks and Connectors
- Hubbell iSTATION Products
- In-Wall AV Delivery
- HDMI Connectors
- Molded-In Voice/Data/Video

## X tradeSELECT® Products



- Decorator Products
- Switches and Receptacles
- USB Receptacles
- Lighting Controls
- Power Delivery

## Y Marine Products



- ELCI Interface Solutions
- 30A and 50A Cable Sets
- 100A and 200A Cable Sets
- Internationally Rated Devices
- Telephone and Cable TV Devices
- Ground Fault Devices

## Z Other Wiring Products



- Adapters and Fluorescent Starters
- Lockout Devices and Circuit Tester
- Lampholders
- Lampholder Accessories
- Taps, Adapters, Plugs and Connectors

## General Technical Data



- Industry Standards
- Certification Agencies and Markings
- Codes and Standards Organizations
- NEMA and IEC Classifications
- Circuit Wiring Diagrams

## Hubbell Configuration Charts (page VI-VII)

## Catalog Number Index

# NEMA Straight Blade Devices

Rating		15 Ampere		20 Ampere		30 Ampere		50 Ampere		60 Ampere		
		Receptacle / Conn. Body	Plug / Inlet	Receptacle / Conn. Body	Plug / Inlet	Receptacle	Plug	Receptacle	Plug	Receptacle	Plug	
2 Pole / 2 Wire	125V	1	A-34  1-15R	A-34  1-15P								
	250V	2			A-34  2-20R	A-34  2-20P						
2 Pole / 3 Wire Grounding	125V	5	A-3 to A-23 A-9 to A-15 A-12 to A-20 A-13 to A-23 A-29 to A-30 A-44 to A-45 C-6 Y-35  5-15R	A-9 to A-37 A-28 to A-30 A-37 A-44 Y-35  5-15P	A-3 to A-23 A-9 to A-15 A-12 to A-20 A-13 to A-23 A-29 to A-30 A-44 to A-45 C-6 Y-37  5-20R	A-6 to A-37 A-28 to A-30 A-37 C-6 Y-37  5-20P	A-39  5-30R	A-39  5-30P	A-41  5-50R	A-41  5-50P		
	250V	6	A-10 to A-33 C-6  6-15R	A-10 to A-32 C-6  6-15P	A-7 to A-33 C-6  6-20R	A-7 to A-32 C-6  6-20P	A-39  6-30R	A-39  6-30P	A-41  6-50R	A-41  6-50P		
	277V AC	7	A-34  7-15R	A-34  7-15P			A-39  7-30R	A-39  7-30P	A-41  7-50R	A-41  7-50P		
3 Pole / 3 Wire	125/250V AC	10			A-35  10-20R	A-35  10-20P	A-39  10-30R	A-39  10-30P	A-41  10-50R	A-41  10-50P		
3 Pole / 4 Wire Grounding	125/250V AC	14			A-35  14-20R	A-35  14-20P	A-40  14-30R	A-40  14-30P	A-42  14-50R	A-42  14-50P	A-43  14-60R	A-43  14-60P
	3Ø 250V AC	15			A-35  15-20R	A-35  15-20P	A-40  15-30R	A-40  15-30P	A-42  15-50R	A-42  15-50P	A-43  15-60R	A-43  15-60P
4P / 4W	3ØY 120/208V AC	18			A-35  18-20R	A-35  18-20P	A-40  18-30R	A-40  18-30P	A-42  18-50R	A-42  18-50P	A-43  18-60R	A-43  18-60P

## HOW TO USE THIS CHART:

For quick reference, this chart shows the configuration, primary catalog section and page number where the devices are shown.

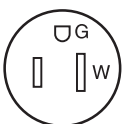

Open Slots indicates Receptacle / Connector Body configurations (female).



Closed Slots indicates Plug / Inlet configurations (male).

## NEMA Configuration

Catalog Section and Page Number

A-3  
A-7  
A-16  
C-6  
Y-35

5-15R

### IMPORTANT NOTICE:

The catalog pages referenced in **BLUE** are Insulgrip®, Valise®, Safety-Shroud® and Watertight Safety-Shroud® devices, in **RED** are Watertight devices, and in **ORANGE** are Marine corrosion resistant devices

# NEMA Twist-Lock® Devices

Rating Color Coded by Voltage	15 Ampere	20 Ampere		30 Ampere			
		Receptacle / Conn. Body	Plug / Inlet	Receptacle / Conn. Body	Plug / Inlet	Receptacle / Conn. Body	Plug / Inlet
2 Pole / 2 Wire	125V L1	B-9  L1-15R	B-9  L1-15P				
	250V L2			B-17  L2-20R	B-17  L2-20P		
2 Pole / 3 Wire Grounding	125V L5	B-11 C-7 Y-34  L5-15R	B-10 C-7 Y-34  L5-15P	B-19 C-7 Y-36  L5-20R	B-18 C-7 Y-36  L5-20P	B-27 C-8  L5-30R	B-26 C-8  L5-30P
	250V L6	B-11 C-7  L6-15R	B-10 C-7  L6-15P	B-19 C-7  L6-20R	B-18 C-7  L6-20P	B-27 C-8  L6-30R	B-26 C-8  L6-30P
	277V AC L7	B-11 C-7  L7-15R	B-10 C-7  L7-15P	B-19 C-7  L7-20R	B-18 C-7  L7-20P	B-27 C-8  L7-30R	B-26 C-8  L7-30P
	480V AC L8			B-22  L8-20R	B-22  L8-20P	B-35  L8-30R	B-35  L8-30P
	600V AC L9			B-22  L9-20R	B-22  L9-20P	B-35  L9-30R	B-35  L9-30P
3 Pole / 3 Wire	125/250V AC L10			B-22  L10-20R	B-22  L10-20P	B-29  L10-30R	B-28  L10-30P
	125/250V AC L14			B-21 C-8  L14-20R	B-20 C-8  L14-20P	B-29 C-9  L14-30R	B-28 C-9  L14-30P
3 Pole / 4 Wire Grounding	3Ø 250V AC L15			B-21 C-8  L15-20R	B-20 C-8  L15-20P	B-29 C-9  L15-30R	B-28 C-9  L15-30P
	3Ø 480V AC L16			B-21 C-8  L16-20R	B-20 C-8  L16-20P	B-31 C-9  L16-30R	B-30 C-9  L16-30P
	3Ø 600V AC L17					B-31 C-9  L17-30R	B-30 C-9  L17-30P
4 Pole / 4 Wire	3ØY 120/208V AC L18			B-23  L18-20R	B-23  L18-20P	B-34 C-9  L18-30R	B-34 C-9  L18-30P
	3ØY 277/480V AC L19			B-23  L19-20R	B-23  L19-20P	B-34  L19-30R	B-34  L19-30P
	3ØY 347/600V AC L20			B-23  L20-20R	B-23  L20-20P	B-34  L20-30R	B-34  L20-30P
4 Pole / 5 Wire Grounding	3ØY 120/208V AC L21			B-25  L21-20R	B-24  L21-20P	B-33  L21-30R	B-32  L21-30P
	3ØY 277/480V AC L22			B-25  L22-20R	B-24  L22-20P	B-33  L22-30R	B-32  L22-30P
2 Pole / 3 Wire	3ØY 347/600V AC L23			B-25  L23-20R	B-24  L23-20P	B-33  L23-30R	B-32  L23-30P
	347V AC L24			B-22  L24-20R	B-22  L24-20P		

MIDGET TWIST-LOCK® DEVICES		
Rating	Receptacle	Plug
2P / 2W 15A 125V	B-5  ML-1R	B-4  ML-1P
2P / 3W Gr 15A 125V	B-5  ML-2R	B-4  ML-2P
3P / 3W 15A 125/250V AC	B-5  ML-3R	B-4  ML-3P

50A TWIST-LOCK® DEVICES			
Rating	Receptacle	Plug	
2 Pole / 3 Wire Grounding	50A 125V Corrosion Resistant ANSI C73-110 / NEMA 591-50 Marine Products	Y-12 Y-13  Y-13 	Y-12 Y-13  Y-13 
	50A 125V	B-56 	B-56 
	50A 250V	B-56 	B-56 
3 Pole / 4 Wire Grounding	50A 480V AC	B-56 	B-56 
	50A 125/250V Corrosion Resistant ANSI C73-111 / NEMA 592-50 Marine Products	Y-14 Y-15  Y-15 	Y-14 Y-15  Y-15 
	50A 125/250V AC	B-57 	B-57 
	50A 3Ø 250V AC	B-57 	B-57 
	50A 3Ø 480V AC	B-57 	B-57 

NON-NEMA TWIST-LOCK® DEVICES			
Rating	Receptacle	Plug	
3 Pole / 3 Wire	20A 125/250V	B-43 C-8  C-8 	B-42 C-8  C-8 
	30A 125/250V	B-45 C-9  C-9 	B-44 C-9  C-9 
4 Pole / 4 Wire	20A 3ØY 120/208V AC	B-43 	B-42 
	30A 3ØY 120/208V AC	B-45 C-9  C-9 	B-44 C-9  C-9 
4P/5W Gr	20A 250V 10A 600V AC	B-46 	B-46 

# Hubbell Wiring Device-Kellems

## General Information

*Industrial and Commercial Wiring Devices and Systems*

*Kellems Wire Management Products*

*Residential Products*

*Marine Products*



*National Electrical  
Manufacturers Association*

NEMA promotes the competitiveness of its member companies by providing a forum for the development of technical standards that are in the best interests of the industry and the users of its products.



*National Association of  
Electrical Distributors*

Since 1908, NAED has served as the trade association for the electrical distribution industry.

To be an NAED associate member, your company must be a manufacturer or value-added reseller.



*Restriction of  
Hazardous Substances*

The RoHS Directive stands for "the restriction of the use of certain hazardous substances in electrical and electronic equipment".



*U.S. Green Building  
Council Member*

Hubbell is a US Green Building Council (USGBC) member dedicated to advancing buildings that are environmentally responsible in the way they are designed, built and operated.



ISO 9001

*International Organization  
for Standardization*

ISO (International Organization for Standardization) is the world's largest developer and publisher of International Standards.

Precautions have been taken to assure accuracy of the information in this catalog. Typographical or pictorial errors which are brought to our attention will be corrected in subsequent issues.

Product dimensions in this catalog are nominal and are provided for the convenience of our customers. Hubbell reserves the right to make product changes from time to time, without prior notification, which may change the dimensions shown. We, therefore, recommend they be checked before using for customer projects or product development and specification.

The designs and dimensions of the products listed in this catalog, were correct at the date of publication and are subject to change without notice.

All configuration diagrams shown in the various sections of the catalog are female devices (receptacles, connector bodies, etc.) unless otherwise indicated.

No material will be accepted for return unless permission is granted in writing by this Company. All orders received for special items and engraved plates are accepted as firm orders and are non-cancelable by the customer.

Claims for freight charges or allowances of any kind will not be considered after 30 days from receipt of goods and our responsibility ceases when we have delivered such shipments to the carriers and hold their receipts.

**The following trademarks of Hubbell Incorporated, are your assurance of the highest quality wiring devices and wiring management products in the Industry.**

- |                 |                         |                |                     |                |
|-----------------|-------------------------|----------------|---------------------|----------------|
| • 4-PLEX®       | • HBL®                  | • Micro-Quick® | • PremiseTrak®      | • SWITCHOUT®   |
| • AccessTrak®   | • H-MOSS®               | • Mini-Quick®  | • PresSwitch®       | • SwivelLok®   |
| • ADD-A-SHROUD® | • H-MOSS®IMAXX™         | • MotorQuick®  | • RACO®             | • tradeSELECT® |
| • AUTOGUARD®    | • Handi-Screw®          | • Nano-Quick®  | • Safety-Shroud®    | • TredTrak®    |
| • BaseTrak®     | • Hubbell®              | • netSELECT®   | • ScrubShield®      | • TrukTrak®    |
| • CableTrak®    | • Hubbell Juniors®      | • NEXTSPEED®   | • Seal-Tite®        | • Twist-Lock®  |
| • CircuitGuard® | • Hubbelllock®          | • OPTIMYZER®   | • Signal-Quick®     | • Valise®      |
| • Circuit-Lock® | • Hubbellnet®           | • OPTISOK®     | • SNAPConnect®      | • Variload®    |
| • CircuitPro®   | • Insulgrip®            | • PANEL-SAFE®  | • SPEEDGAIN®        | • VARI-SIZE®   |
| • Dua-Pull®     | • Insulgrip Twist-Lock® | • PLUG-CHECK®  | • Spider®           | • WallTrak®    |
| • Elastogrip®   | • JLOAD®                | • PLUGOUT®     | • SpikeShield®      |                |
| • FloorTrak®    | • Kellems®              | • PLUGOUT®     | • Style Line®       |                |
| • Gotcha®       | • LANTrak®              | • PlugTrak®    | • Super BaseTrak®   |                |
| • Gripulator®   | • LINKOSITY®            | • PolyTrak®    | • Super Twist-Lock® |                |
|                 |                         | • PolyTuff®    |                     |                |

UPC Vendor Code No. 783585 - Hubbell Wiring Device-Kellems

CAGE No. 74545

© 2013 Hubbell Incorporated



# Section A Straight Blade Devices

## Index

Product	Page
<b>HBL® Extra Heavy Duty Hospital Grade Duplex Receptacles</b>	
Duplex and Style Line® Decorator . . . . .	A-3
SNAPConnect® Receptacles . . . . .	A-4
Hubbell-PRO Receptacles . . . . .	A-6
USB Charger, Single and 4-PLEX Receptacles . . . . .	A-8
Plugs, Receptacles and Connector Bodies . . . . .	A-9
<b>HBL® Extra Heavy Duty Industrial Series . . . . .</b>	<b>A-11</b>
Extra Heavy Duty SNAPConnect® Receptacles . . . . .	A-14
Hubbell-PRO Heavy Duty Specification Grade Receptacles . . . . .	A-17
USB Charger Receptacle Tamper-Resistant Duplex . . . . .	A-18
<b>Commercial Specification Grade Receptacles</b>	
4-PLEX® Receptacles and Accessories . . . . .	A-23
Pre-Fabricated Building Wiring System . . . . .	A-24
<b>Plugs and Connectors</b>	
Insulgrip®, Elastogrip® and Valise® Plugs and Connector Bodies . . . . .	A-28
Insulgrip® Flanged Inlets and Receptacles . . . . .	A-30
<b>HBL® Extra Heavy Duty, Specification Grade Receptacles . . . . .</b>	<b>A-31</b>
Insulgrip® and Valise® Plugs and Flanged Inlets . . . . .	A-32
Insulgrip® and Valise® Connector Bodies and Flanged Receptacles . . . . .	A-33
<b>15 and 20A Plugs, Connector Bodies and Receptacles</b>	
16A, 250V AC International . . . . .	A-36
<b>Hazardous Location Receptacles, Plugs and Boxes . . . . .</b>	<b>A-37</b>
<b>30, 50 and 60A Heavy Duty Insulgrip® Plugs and Receptacles</b>	
DIN Rail Utility Box . . . . .	A-44
Miscellaneous and Combination Receptacles . . . . .	A-45
Accessories . . . . .	A-46
Technical Information . . . . .	A-50

### HBL® Extra Heavy Duty Industrial Series



### SNAPConnect® Receptacles



### Commercial Specification Grade



### Insulgrip® Plugs and Connectors



## Straight Blade Devices

# HBL® Extra Heavy Duty Hospital Grade Duplex Receptacles

### Features and Benefits

One-piece nickel-plated brass integral ground strap for greater corrosion resistance

Patented ground contact provides redundant grounding

Unique bypass contact design results in greater contact force and reduced heat buildup

Square head, 10-thread bronze center rivet won't rotate, reduces stripping and resists corrosion

I.D. marking surface provides quick, sure circuit identification

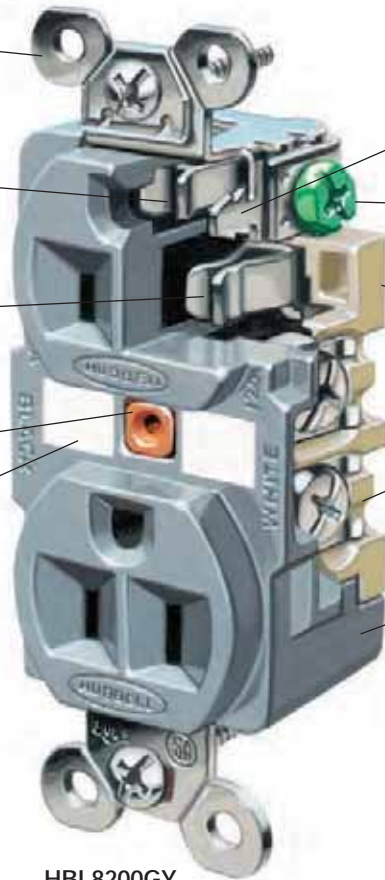

HBL8200GY

Barbed assembly arms reduce possibility of face/base separation

Back wired ground terminal allows faster, easier installation

RTP base offers greater heat resistance, plus contact stability

External bundling terminals contain wire strands and are designed for quick inspection

Deep body design increases impact and chemical resistance

## Hubbell "Hospital Grade" Devices

To qualify for the "Hospital Grade" designation and use of the associated green dot symbol, UL requires that the manufacturer design its devices to perform to specific levels. These levels form an established baseline below which no manufacturer can fall and still carry a green dot.

Hubbell sets their standards high. Each product is built to withstand the severe conditions of abuse that are unique to the hospital environment. Hubbell receptacles have exclusive design features that set them apart from the competition.

- Exclusive nickel-plated bypass contact design increases contact pressure, lowering the operating temperature.
- Four point grounding system provides redundant grounding for low resistance ground continuity in high abuse areas.
- High tech reinforced thermoplastic polyester (RTP) back is tough and heat resistant.

Because of these features and others, the benefit is performance, reliability, and value for any health care facility.



One piece, nickel plated brass mounting strap with integral ground contacts, along with secondary ground contact, provides superior grounding for low resistance flow of fault currents as well as corrosion resistance. Barbed locking arms keep the face locked in place to diminish potential for face/base separation. Back wired ground screw reduces installation time.



Exclusive bypass contacts are made of nickel-plated brass alloy. This design increases blade retention forces, insuring a reliable uninterrupted flow of power.



Reinforced thermoplastic back provides superior thermal, electrical and mechanical properties. By providing contact stability, this high performance material will reduce heat buildup giving you long lasting performance.



External wiring clamps allow for visual inspection of the terminals. A unique strand containment feature on the terminal "bundles" the wire, ensuring 100% clamping of wire strands and reducing heat from the termination.

Straight Blade Devices  
**15 and 20 Ampere, 125 Volts**  
 2 Pole, 3 Wire Grounding



**IP20**  
 SUITABILITY



**15A 125V**  
 NEMA 5-15R  
 UL CSA  
 0.5 HP



**20A 125V**  
 NEMA 5-20R  
 UL CSA  
 1 HP

**HBL® Extra Heavy Duty Hospital Grade Receptacles**

**Duplex**

Description	Color	Catalog Number	
Flush, thermoplastic polyester face, back and side wired.	Black	<b>HBL8200BK</b>	-
	Blue	-	<b>HBL8300BL</b>
	Brown	<b>HBL8200</b>	<b>HBL8300</b>
	Gray	<b>HBL8200GY</b>	<b>HBL8300GY</b>
	Ivory	<b>HBL8200I</b>	<b>HBL8300I</b>
	Light Almond	<b>HBL8200LA</b>	<b>HBL8300LA</b>
	Red	<b>HBL8200RED</b>	<b>HBL8300RED</b>
	White	<b>HBL8200W</b>	<b>HBL8300W</b>
Flush, LED illuminated face, back and side wired.	Gray	<b>HBL8200ILGY</b>	<b>HBL8300ILGY</b>
	Ivory	<b>HBL8200ILI</b>	<b>HBL8300ILI</b>
	Red	<b>HBL8200ILR</b>	<b>HBL8300ILR</b>
	White	<b>HBL8200ILW</b>	<b>HBL8300ILW</b>
Tamper-Resistant receptacle with wire leads. Complies with requirements of NEC® article 517-18(c).	Brown	<b>HBL8200SGA</b>	<b>HBL8300SGA</b>
	Gray	<b>HBL8200SGGYA</b>	<b>HBL8300SGGYA</b>
	Ivory	<b>HBL8200SGIA</b>	<b>HBL8300SGIA</b>
	Light Almond	<b>HBL8200SGLA</b>	<b>HBL8300SGLA</b>
	Red	<b>HBL8200SGRA</b>	<b>HBL8300SGRA</b>
	White	<b>HBL8200SGWA</b>	<b>HBL8300SGWA</b>
Isolated ground <sup>A</sup> .	Orange	<b>IG8200</b>	<b>IG8300</b>
	Red	<b>IG8200R</b>	<b>IG8300R</b>

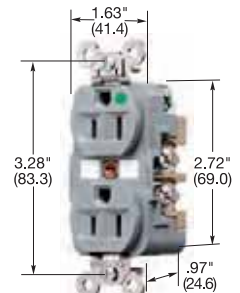

**HBL8200GY**

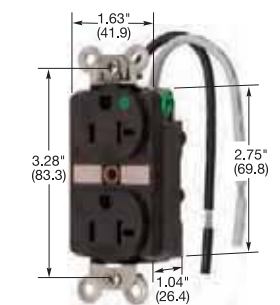

**HBL8300SGA**

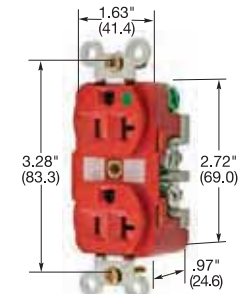

**HBL8300RMRI**

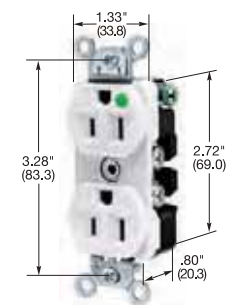

**HBL8200ILW**

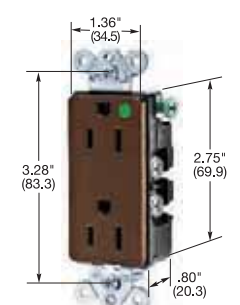

**HBL2172**

Dimensions in Inches (mm)

**MRI Receptacle, Duplex**

Description	Color	Catalog Number	
MRI receptacle, flush, thermoplastic polyester face, back and side wired.	Ivory	<b>HBL8200IMRI</b>	<b>HBL8300IMRI</b>
	Light Almond	<b>HBL8200LAMRI</b>	<b>HBL8300LAMRI</b>
	Red	<b>HBL8200RMRI</b>	<b>HBL8300RMRI</b>
	White	<b>HBL8200WMRI</b>	<b>HBL8300WMRI</b>

**Slender/Compact, Duplex**

Description	Color	Catalog Number	
Flush, thermoplastic polyester face, back, and side wired, Fed. Spec. verified.	Brown	<b>HBL8200H</b>	<b>HBL8300H</b>
	Gray	<b>HBL8200HG</b>	<b>HBL8300HG</b>
	Green	-	<b>HBL8300HGN</b>
	Ivory	<b>HBL8200HI</b>	<b>HBL8300HI</b>
	Light Almond	<b>HBL8200HLA</b>	<b>HBL8300HLA</b>
	Red	<b>HBL8200HRED</b>	<b>HBL8300HRED</b>
	White	<b>HBL8200HW</b>	<b>HBL8300HW</b>

**Style Line® Decorator\***

Description	Color	Catalog Number	
Flush, nylon face, back and side wired.	Brown	<b>HBL2172</b>	<b>HBL2182</b>
	Gray	<b>HBL2172GY</b>	<b>HBL2182GY</b>
	Ivory	<b>HBL2172I</b>	<b>HBL2182I</b>
	Office White	-	<b>HBL2182OW</b>
	Red	<b>HBL2172R</b>	<b>HBL2182R</b>
	White	<b>HBL2172WA</b>	<b>HBL2182WA</b>
Isolated ground <sup>A</sup> .	Ivory	-	<b>IG2182I</b>
	Orange	-	<b>IG2182</b>
	White	-	<b>IG2182WA</b>

Note: <sup>A</sup>See section M for additional information on isolated ground devices.  
 \*Not Fed. Spec. Listed.  
 See page A-46 and A-47 for accessories.  
 See page A-50 for technical information.  
 See page Tech-10 for Tamper-Resistant description.  
 See section L for additional information on Hospital Grade products.  
 See section N for wallplates.

NEC® is a registered trademark of the National Fire Protection Association (NFPA).

**IP20**  
 SUITABILITY



**15A 125V**  
 NEMA 5-15R  
 UL CSA  
 0.5 HP



**20A 125V**  
 NEMA 5-20R  
 UL CSA  
 1 HP

## Extra Heavy Duty Hospital Grade ● SNAPConnect®

### Duplex

Description	Color	Catalog Number	
Hospital grade, finder groove, nylon face, modular receptacle which requires pigtailed connector below. Assembled in USA*.	Black	SNAP8200BKA*	SNAP8300BKA*
	Brown	SNAP8200A*	SNAP8300A*
	Gray	SNAP8200GYA*	SNAP8300GYA*
	Ivory	SNAP8200IA*	SNAP8300IA*
	Light Almond	SNAP8200LAA*	SNAP8300LAA*
	Red	SNAP8200RA*	SNAP8300RA*
	White	SNAP8200WA*	SNAP8300WA*
Hospital grade, Tamper-Resistant, smooth nylon face, modular receptacle which requires pigtailed connector below. Assembled in USA.	Black	SNAP8200BKTR	SNAP8300BKTR
	Brown	SNAP8200TR	SNAP8300TR
	Gray	SNAP8200GYTR	SNAP8300GYTR
	Ivory	SNAP8200ITR	SNAP8300ITR
	Light Almond	SNAP8200LATR	SNAP8300LATR
	Red	SNAP8200RTR	SNAP8300RTR
	White	SNAP8200WTR	SNAP8300WTR
Isolated ground <sup>A</sup> , Hospital grade, Tamper-Resistant.	Orange	SNAP8200IGTR	SNAP8300IGTR
	Red	SNAP8200RIGTR	SNAP8300RIGTR
Hospital grade, with Power Indicating LED, smooth nylon face, modular receptacle which requires pigtailed connector below. Assembled in USA.	Black	SNAP8200BKL	SNAP8300BKL
	Brown	SNAP8200L	SNAP8300L
	Gray	SNAP8200GYL	SNAP8300GYL
	Ivory	SNAP8200IL	SNAP8300IL
	Light Almond	SNAP8200LAL	SNAP8300LAL
	Red	SNAP8200RL	SNAP8300RL
	White	SNAP8200WL	SNAP8300WL
Isolated ground <sup>A</sup> , Hospital grade, with Power Indicating LED.	Orange	SNAP8200IGL	SNAP8300IGL
	Red	SNAP8200RIGL	SNAP8300RIGL
Hospital grade, Tamper-Resistant, with Power Indicating LED, smooth nylon face, modular receptacle which requires pigtailed connector below. Assembled in USA.	Black	SNAP8200BKLTR	SNAP8300BKLTR
	Brown	SNAP8200LTR	SNAP8300LTR
	Gray	SNAP8200GYLTR	SNAP8300GYLTR
	Ivory	SNAP8200ILTR	SNAP8300ILTR
	Light Almond	SNAP8200LALTR	SNAP8300LALTR
	Red	SNAP8200RLTR	SNAP8300RLTR
	White	SNAP8200WLTR	SNAP8300WLTR
Isolated ground <sup>A</sup> , Hospital grade, TR with Power Indicating LED.	Orange	SNAP8200IGLTR	SNAP8300IGLTR
	Red	SNAP8200RIGLTR	SNAP8300RIGLTR

Note: <sup>A</sup> See section M additional information on isolated ground devices.  
 See page A-14 for additional information on SNAPConnect® features.  
 See page Tech-10 for Tamper-Resistant and LED Power Indicators description.  
 See pages A-46 and A-47 for accessories.  
 See page A-54 for technical information.  
 See section N for wallplates.  
 Consult factory for available Split-Circuit capable SNAPConnect® devices.

### SNAPConnect® Right Angle Pigtailed Connector

Description	Wire Type	General Use Catalog Number	Assembled in USA Catalog Number
Clear right angle terminal with 6 inch leads #12 AWG THHN/THWN-2; Polycarbonate housing material	Solid	SNAP1RA	SNAP1RNA
	Stranded	SNAP2RA	SNAP2RNA

Note: For Assembled in USA products, must order connector with NA suffix.  
 See page A-54 for technical information.

**Many of these products are Assembled in USA, as indicated, and many are Buy American Compliant. Please contact Hubbell with any certification requirements.**

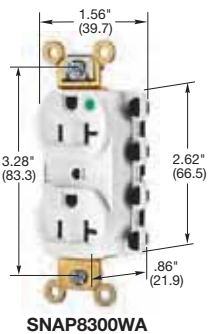

SNAP8300WA

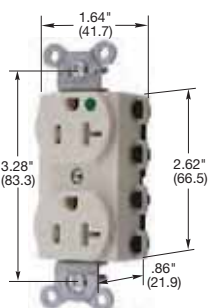

SNAP8300LATR

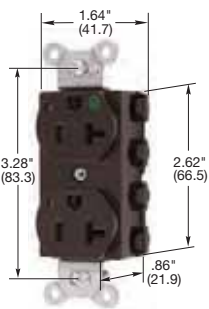

SNAP8300L

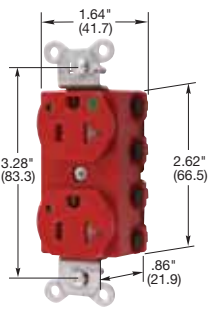

SNAP8300RLTR

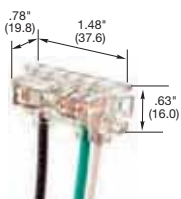

SNAP1RA

Dimensions in Inches (mm)

Straight Blade Devices  
**15 and 20 Ampere, 125 Volts**  
 2 Pole, 3 Wire Grounding



**IP20**  
SUITABILITY

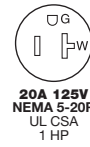
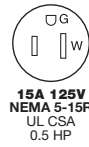

**Extra Heavy Duty**  
**Hospital Grade ● SNAPConnect®**  
**Style Line® Decorator**

Description	Color	Catalog Number	Catalog Number
Hospital grade, Style Line® decorator, flush, nylon face, modular receptacle which requires pigtailed connector below. Assembled in USA*.	Black	SNAP2172BKA*	SNAP2182BKA*
	Brown	SNAP2172A*	SNAP2182A*
	Gray	SNAP2172GYA*	SNAP2182GYA*
	Ivory	SNAP2172IA*	SNAP2182IA*
	Light Almond	SNAP2172LAA*	SNAP2182LAA*
	Red	SNAP2172RA*	SNAP2182RA*
	White	SNAP2172WA*	SNAP2182WA*
Hospital grade, Tamper-Resistant, Style Line® decorator, flush, nylon face, modular receptacle which requires pigtailed connector below. Assembled in USA.	Black	SNAP2172BKTR	SNAP2182BKTR
	Brown	SNAP2172TR	SNAP2182TR
	Gray	SNAP2172GYTR	SNAP2182GYTR
	Ivory	SNAP2172ITR	SNAP2182ITR
	Light Almond	SNAP2172LATR	SNAP2182LATR
	Red	SNAP2172RTR	SNAP2182RTR
	White	SNAP2172WTR	SNAP2182WTR
Isolated ground <sup>A</sup> , Hospital grade, Tamper-Resistant.	Orange	SNAP2172IGTR	SNAP2182IGTR
	Red	SNAP2172RIGTR	SNAP2182RIGTR
Hospital grade, with Power Indicating LED, Style Line® decorator, flush, nylon face, modular receptacle which requires pigtailed connector below. Assembled in USA.	Black	SNAP2172BKL	SNAP2182BKL
	Brown	SNAP2172L	SNAP2182L
	Gray	SNAP2172GYL	SNAP2182GYL
	Ivory	SNAP2172IL	SNAP2182IL
	Light Almond	SNAP2172LAL	SNAP2182LAL
	Red	SNAP2172RL	SNAP2182RL
	White	SNAP2172WL	SNAP2182WL
Isolated ground <sup>A</sup> , Hospital grade, with Power Indicating LED.	Orange	SNAP2172IGL	SNAP2182IGL
	Red	SNAP2172RIGL	SNAP2182RIGL
Hospital grade, Tamper-Resistant, with Power Indicating LED, Style Line® decorator, flush, nylon face, modular receptacle which requires pigtailed connector below. Assembled in USA.	Black	SNAP2172BKLTR	SNAP2182BKLTR
	Brown	SNAP2172LTR	SNAP2182LTR
	Gray	SNAP2172GYLTR	SNAP2182GYLTR
	Ivory	SNAP2172ILTR	SNAP2182ILTR
	Light Almond	SNAP2172LALTR	SNAP2182LALTR
	Red	SNAP2172RLTR	SNAP2182RLTR
	White	SNAP2172WLTR	SNAP2182WLTR
Isolated ground <sup>A</sup> , Hospital grade, TR with Power Indicating LED.	Orange	SNAP2172IGLTR	SNAP2182IGLTR
	Red	SNAP2172RIGLTR	SNAP2182RIGLTR

Note: <sup>A</sup> See section M additional information on isolated ground devices.  
 See page A-14 for additional information on SNAPConnect® features.  
 See page Tech-10 for additional information on Tamper-Resistant and LED Power Indicators description.  
 See pages A-46 and A-47 for accessories.  
 See page A-54 for technical information.  
 See section N for wallplates.  
 Consult factory for available Split-Circuit capable SNAPConnect® devices.

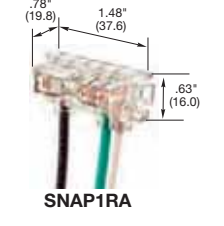
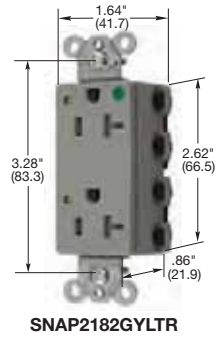
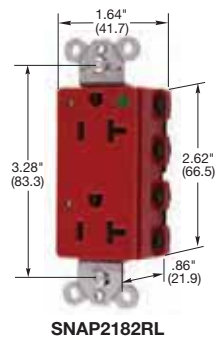
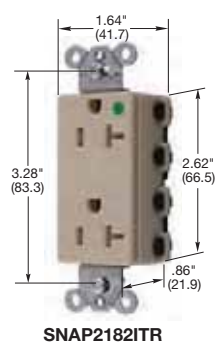
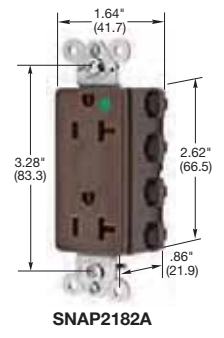

**SNAPConnect® Right Angle Pigtailed Connector**

Description	Wire Type	General Use Catalog Number	Assembled in USA Catalog Number
Clear right angle terminal with 6 inch leads #12 AWG THHN/THWN-2; Polycarbonate housing material	Solid	SNAP1RA	SNAP1RNA
	Stranded	SNAP2RA	SNAP2RNA

Note: For Assembled in USA products, must order connector with NA suffix.  
 See page A-54 for technical information.

**Many of these products are Assembled in USA, as indicated, and many are Buy American Compliant. Please contact Hubbell with any certification requirements.**

Dimensions in Inches (mm)

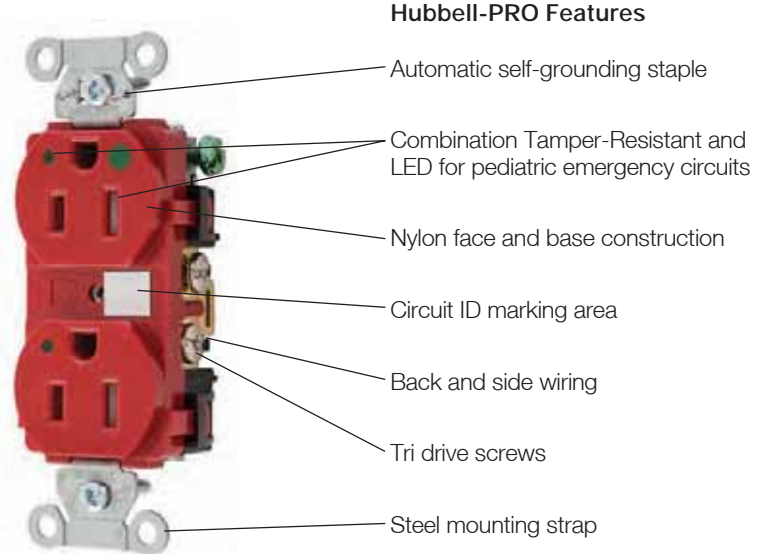

**Hubbell-PRO Features**

- Automatic self-grounding staple
- Combination Tamper-Resistant and LED for pediatric emergency circuits
- Nylon face and base construction
- Circuit ID marking area
- Back and side wiring
- Tri drive screws
- Steel mounting strap

**8200REDLTR**

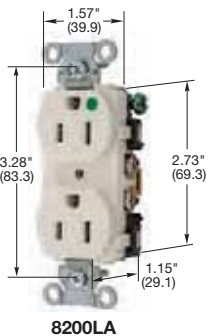

**8200LA**

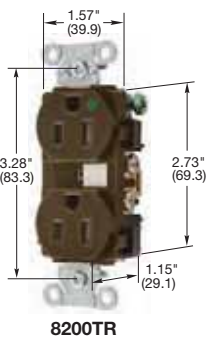

**8200TR**

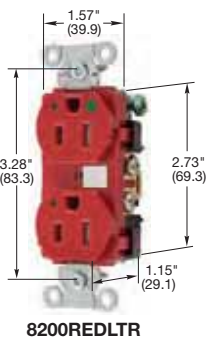

**8200REDLTR**

Dimensions in Inches (mm)

**Hubbell-PRO Heavy Duty Hospital Grade ● Receptacles**

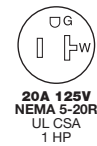

**Duplex**

Description	Color	Catalog Number	
Hospital grade, smooth nylon face, back and side wired. Assembled in USA.	Black	<b>8200BK</b>	<b>8300BK</b>
	Brown	<b>8200</b>	<b>8300</b>
	Gray	<b>8200GY</b>	<b>8300GY</b>
	Ivory	<b>8200IV</b>	<b>8300IV</b>
	Light Almond	<b>8200LA</b>	<b>8300LA</b>
	Red	<b>8200RED</b>	<b>8300RED</b>
	White	<b>8200WHI</b>	<b>8300WHI</b>
Hospital grade, Tamper-Resistant, smooth nylon face, back and side wired. Assembled in USA.	Black	<b>8200BKTR</b>	<b>8300BKTR</b>
	Brown	<b>8200TR</b>	<b>8300TR</b>
	Gray	<b>8200GYTR</b>	<b>8300GYTR</b>
	Ivory	<b>8200IVTR</b>	<b>8300IVTR</b>
	Light Almond	<b>8200LATR</b>	<b>8300LATR</b>
	Red	<b>8200REDTR</b>	<b>8300REDTR</b>
	White	<b>8200WTR</b>	<b>8300WTR</b>
Hospital grade, with Power Indicating LED, smooth nylon face, back and side wired. Assembled in USA.	Black	<b>8200BKL</b>	<b>8300BKL</b>
	Brown	<b>8200L</b>	<b>8300L</b>
	Gray	<b>8200GYL</b>	<b>8300GYL</b>
	Ivory	<b>8200IVL</b>	<b>8300IVL</b>
	Light Almond	<b>8200LAL</b>	<b>8300LALM</b>
	Red	<b>8200REDL</b>	<b>8300REDL</b>
	White	<b>8200WL</b>	<b>8300WL</b>
 Hospital grade, Tamper-Resistant, with Power Indicating LED, smooth nylon face, back and side wired. Assembled in USA.	Black	<b>8200BKLTR</b>	<b>8300BKLTR</b>
	Brown	<b>8200LTR</b>	<b>8300LTR</b>
	Gray	<b>8200GYLTR</b>	<b>8300GYLTR</b>
	Ivory	<b>8200IVLTR</b>	<b>8300IVLTR</b>
	Light Almond	<b>8200LALTR</b>	<b>8300LALTR</b>
	Red	<b>8200REDLTR</b>	<b>8300REDLTR</b>
	White	<b>8200WLTR</b>	<b>8300WLTR</b>

*Note: See pages A-46 and A-47 for accessories.  
 See page A-55 for technical information.  
 See page Tech-10 for Tamper-Resistant and LED Power Indicators description.  
 See section N for wallplates.*

**The products listed on this page are Assembled in USA, and many are Buy American Compliant. Please contact Hubbell with any certification requirements.**

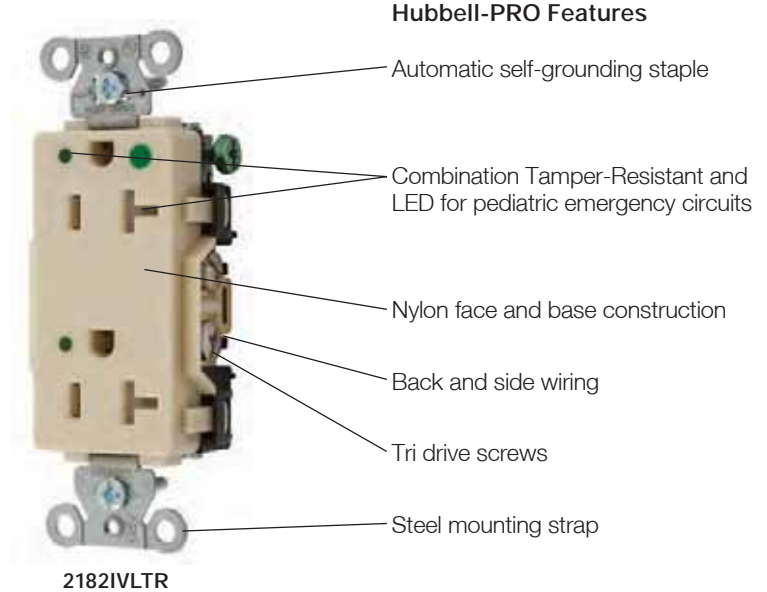

## Hubbell-PRO Heavy Duty Hospital Grade Receptacles

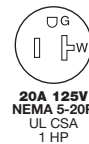
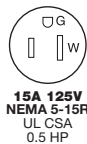

### Style Line® Decorator

Description	Color	Catalog Number	
Hospital grade, Style Line® decorator, flush, nylon face, back and side wired. Assembled in USA.	Black	2172BK	2182BK
	Brown	2172	2182
	Gray	2172GY	2182GY
	Ivory	2172IV	2182IV
	Light Almond	2172LA	2182LA
	Red	2172RED	2182RED
	White	2172W	2182W
Hospital grade, Tamper-Resistant, Style Line® decorator, flush, nylon face, back and side wired. Assembled in USA.	Black	2172BKTR	2182BKTR
	Brown	2172TR	2182TR
	Gray	2172GYTR	2182GYTR
	Ivory	2172IVTR	2182IVTR
	Light Almond	2172LATR	2182LATR
	Red	2172REDTR	2182REDTR
	White	2172WTR	2182WTR
Hospital grade, with Power Indicating LED, Style Line® decorator, flush, nylon face, back and side wired. Assembled in USA.	Black	2172BKL	2182BKL
	Brown	2172L	2182L
	Gray	2172GYL	2182GYL
	Ivory	2172IVL	2182IVL
	Light Almond	2172LAL	2182LAL
	Red	2172REDL	2182REDL
	White	2172WL	2182WL
Hospital grade, Tamper-Resistant, with Power Indicating LED, Style Line® decorator, flush, nylon face, back and side wired. Assembled in USA.	Black	2172BKLTR	2182BKLTR
	Brown	2172LTR	2182LTR
	Gray	2172GYLTR	2182GYLTR
	Ivory	2172IVLTR	2182IVLTR
	Light Almond	2172LALTR	2182LALTR
	Red	2172REDLTR	2182REDLTR
	White	2172WLTR	2182WLTR

Note: See pages A-46 and A-47 for accessories.  
 See page A-55 for technical information.  
 See page Tech-10 for Tamper-Resistant and LED Power Indicators description.  
 See section N for wallplates.

**The products listed on this page are Assembled in USA, and many are Buy American Compliant. Please contact Hubbell with any certification requirements.**

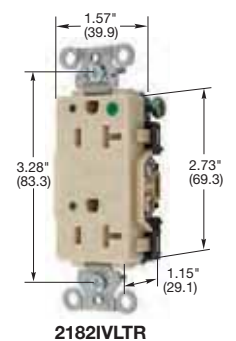
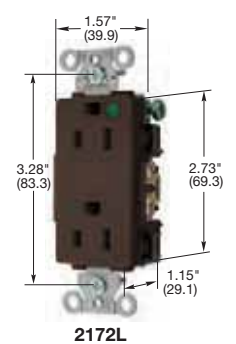
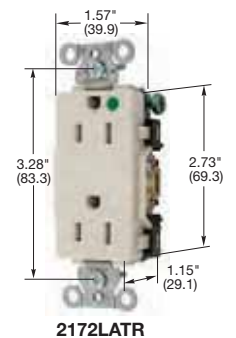

Dimensions in Inches (mm)

Straight Blade Devices  
**15 and 20 Ampere, 125 Volts**  
 2 Pole, 3 Wire Grounding

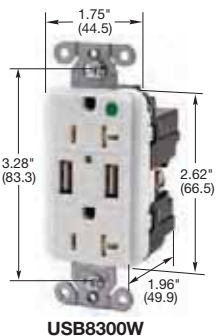

**USB Charger Tamper-Resistant Hospital Grade Receptacles**

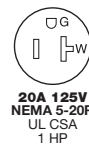
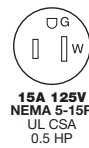

Description	Color	15A 125V AC	20A 125V AC
USB Charger Tamper-Resistant receptacle, Two USB Type 2.0 ports 3 Amp, 5 Volt DC, 15 or 20 Amp, 125 Volt AC decorator duplex	Black	<b>USB8200BK</b>	<b>USB8300BK</b>
	Brown	<b>USB8200</b>	<b>USB8300</b>
	Gray	<b>USB8200GY</b>	<b>USB8300GY</b>
	Ivory	<b>USB8200I</b>	<b>USB8300I</b>
	Light Almond	<b>USB8200LA</b>	<b>USB8300LA</b>
	Red	<b>USB8200R</b>	<b>USB8300R</b>
	White	<b>USB8200W</b>	<b>USB8300W</b>

Note: See page A-18 for additional information on standard USB charger.  
 See page A-56 for technical information.  
 See page Tech-10 for Tamper-Resistant description.

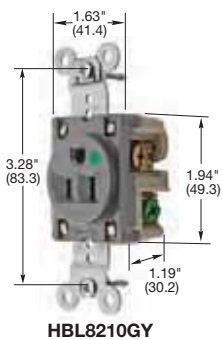

**HBL® Extra Heavy Duty Hospital Grade Single Receptacles**

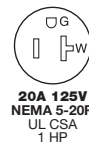
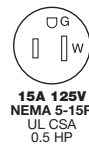

Description	Color	Catalog Number	
Flush, nylon face, back and side wired, Fed. Spec. verified.	Almond	-	<b>HBL8310AL</b>
	Brown	<b>HBL8210</b>	<b>HBL8310</b>
	Gray	<b>HBL8210GY</b>	<b>HBL8310GY</b>
	Ivory	<b>HBL8210I</b>	<b>HBL8310I</b>
	Red	<b>HBL8210R</b>	<b>HBL8310R</b>
	White	<b>HBL8210W</b>	<b>HBL8310W</b>
Panel mount on 1.94 in. (49.2) centers.	Brown	<b>HBL8284</b>	-
	Ivory	<b>HBL8284I</b>	<b>HBL8384I</b>
Isolated ground <sup>A</sup> .	Orange	<b>IG8210</b>	<b>IG8310</b>

Note: <sup>A</sup> See section M for additional information on isolated ground devices.

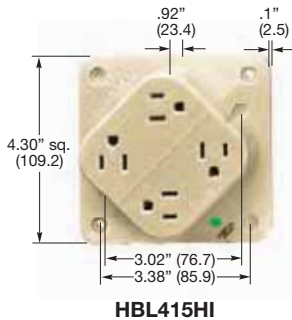

**4-PLEX® Hospital Grade Receptacles**

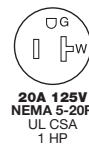
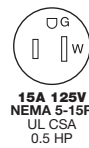

Description	Color	Catalog Number	
4 outlet high impact resistant Polycarbonate construction. Mount to 4 in. square box.	Brown	<b>HBL415H</b>	<b>HBL420H</b>
	Gray	-	<b>HBL420HG</b>
	Ivory	<b>HBL415HI</b>	<b>HBL420HI</b>
	Red	<b>HBL415HR</b>	<b>HBL420HR</b>
	White	<b>HBL415HW</b>	<b>HBL420HW</b>
4-PLEX adapter plates for 1- and 2-gang, device boxes.	Brown	<b>HBL4AP</b>	<b>HBL4AP</b>
	Gray	<b>HBL4APGY</b>	<b>HBL4APGY</b>
	Ivory	<b>HBL4API</b>	<b>HBL4API</b>
	Red	<b>HBL4APR</b>	<b>HBL4APR</b>
	White	<b>HBL4APW</b>	<b>HBL4APW</b>

Note: See page A-23 for additional information on 4-PLEX devices.  
 See page A-60 for technical information.  
 4-PLEX devices are not Fed. Spec. Listed.

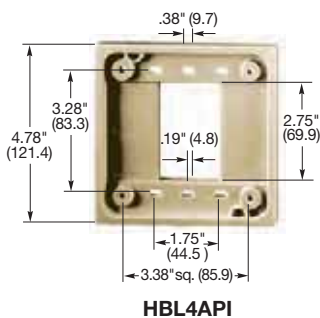

Dimensions in Inches (mm)



**IP20**  
SUITABILITY



## Hospital Grade ● Plugs

### Insulgrip®

Description	Cord Diameter	Catalog Number	
Black and white nylon.	.230"-.720" (5.8-18.3)	<b>HBL8215C</b>	<b>HBL8315C</b>
Transparent housing.	.230"-.720" (5.8-18.3)	<b>HBL8215CT</b>	<b>HBL8315CT</b>
8 position angle plug, transparent housing.	.250"-.655" (6.4-16.6)	<b>HBL8215CAT*</b>	<b>HBL8315CAT*</b>



### Valise®

Description	Cord Diameter	Catalog Number	
White nylon.	.300"-.660" (7.6-16.8)	<b>HBL8115V</b>	<b>HBL8364V</b>
Insulation displacement, white nylon.	.300"-.360" (7.6-9.1)	<b>HBL8013V*</b>	–

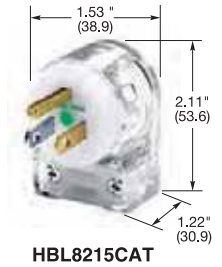

Note: \*Not Fed. Spec. Listed.  
 See page A-47 for accessories.

**IP20**  
SUITABILITY



## Hospital Grade ● Connector Bodies

### Insulgrip®

Description	Cord Diameter	Catalog Number	
Black and white nylon.	.230"-.720" (5.8-18.3)	<b>HBL8219C</b>	<b>HBL8319C</b>
Transparent housing.	.230"-.720" (5.8-18.3)	<b>HBL8219CT</b>	<b>HBL8319CT</b>



### Valise®

Description	Cord Diameter	Catalog Number	
White nylon.	.300"-.660" (7.6-16.8)	<b>HBL8119V</b>	–



Note: See page A-47 for accessories.

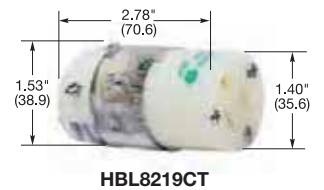

Dimensions in Inches (mm)



**HBL8666V**

**IP20**  
SUITABILITY



**15A 250V**  
NEMA 6-15P  
UL CSA  
1.5 HP



**20A 250V**  
NEMA 6-20P  
UL CSA  
2 HP

## Hospital Grade ● Plugs

Valise®

Description	Cord Diameter	Catalog Number	
Valise plug, white nylon.	.300"-.660" (7.6-16.8)	<b>HBL8666V</b>	<b>HBL8464V</b>

*Note: HP ratings listed above are based on 208 to 240V AC only.*

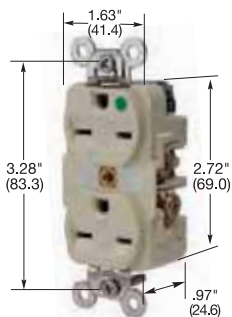

**HBL8600I**



**15A 250V**  
NEMA 6-15R  
UL CSA  
1.5 HP



**20A 250V**  
NEMA 6-20R  
UL CSA  
2 HP

## Hospital Grade ● Receptacles

HBL® Extra Heavy Duty, Duplex

Description	Color	Catalog Number	
Flush, thermoplastic polyester face, back and side wired.	Brown Ivory	<b>HBL8600</b> <b>HBL8600I</b>	<b>HBL8400</b> <b>HBL8400I</b>

*Note: See page A-46 for accessories.  
 See section N for wallplates.*



**HBL8469V**



**20A 250V**  
NEMA 6-20R  
UL CSA  
2 HP

## Hospital Grade ● Connector Bodies

Valise®

Description	Cord Diameter	Catalog Number
White nylon.	.300"-.660" (7.6-16.8)	<b>HBL8469V</b>

*Dimensions in Inches (mm)*

# Straight Blade Devices

## HBL® Extra Heavy Duty Industrial Series

*Features and Benefits*

One-piece brass integral ground strap for low resistance of fault currents

Ground retention clips for longer, more consistent contact pressure

Exclusive bypass contact design results in greater contact force and reduced heat buildup

Square head, 10-thread brass center rivet won't rotate, reduces stripping and resists corrosion

I.D. marking surface provides quick, sure circuit identification

Barbed assembly arms reduce possibility of face/base separation

Back wired ground terminal allows faster, easier installation

RTP base offers greater heat resistance, plus contact stability

External bundling terminals contain wire strands and are designed for quick inspection

Deep nylon body design delivers increased impact resistance

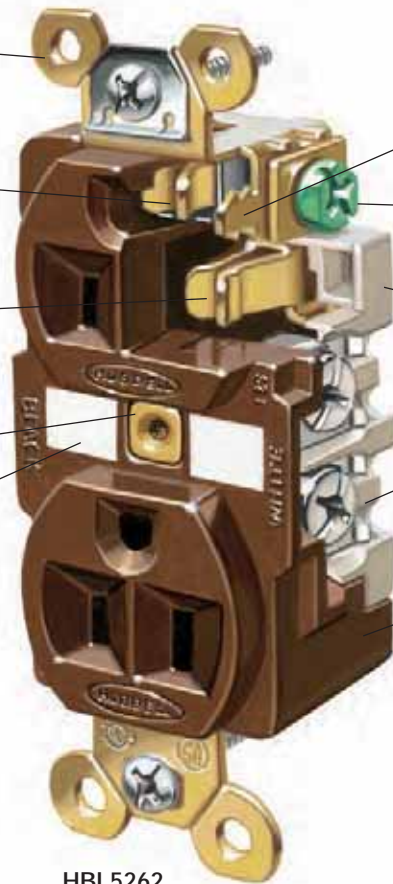

HBL5262

### Quality in Design

Hubbell's commitment to quality continually reinforces a philosophy of unrivaled performance. No Hubbell device exemplifies this philosophy more than the HBL5262. While all Hubbell receptacles are designed and manufactured to withstand even the harshest environments, none match the total performance of the HBL5262.

Whether in a factory, office building, school, hotel or shopping center, the Hubbell HBL5262 is the receptacle of choice when people are depending on the safety and reliability of a receptacle.



One piece, all brass, mounting strap with integral ground contacts. The safest, most reliable design for a low resistance flow of fault currents. Oversized "bell" shaped ground contacts, along with nickel plated steel retaining shields, help minimize damage to the grounding system during abrupt pullout. Barbed brass locking arms keep the face locked in place to diminish potential for face/base separation. Back wired ground terminal reduces installation time and increases convenience.



The patented "bypass" contact design incorporates high-conductivity materials with superior spring characteristics for increased contact force and secure connections. Improved contact performance reduces heat buildup and ensures a reliable, uninterrupted flow of power.



Reinforced thermoplastic base provides superior thermal, electrical and mechanical properties. By providing contact stability, this high tech material will reduce heat buildup, giving you long lasting performance.



External wiring clamps feature large head brass screws (#10) for superior torque values. Visible brass terminal screws and clamps, with a unique strand containment feature, ensure 100% clamping of wire strands, reducing heat build up.



**15A 125V**  
 NEMA 5-15R  
 UL CSA  
 0.5 HP



**20A 125V**  
 NEMA 5-20R  
 UL CSA  
 1 HP

## HBL® Extra Heavy Duty, Specification Grade, Receptacles

### Duplex

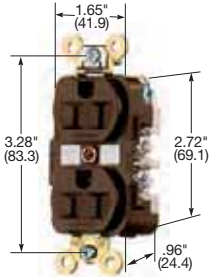

**HBL5262**

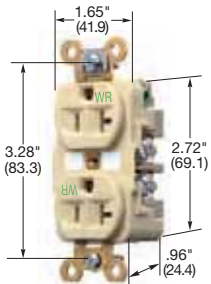

**HBL5362IWR**

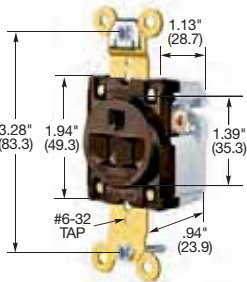

**HBL5261**

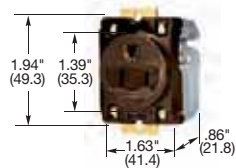

**HBL5284**

Description	Color	Catalog Number	
Flush, nylon face, back and side wired.	Black	<b>HBL5262BK</b>	<b>HBL5362BK</b>
	Blue	-	<b>HBL5362BL</b>
	Brown	<b>HBL5262</b>	<b>HBL5362</b>
	Gray	<b>HBL5262GY</b>	<b>HBL5362GY</b>
	Ivory	<b>HBL5262I</b>	<b>HBL5362I</b>
	Red	<b>HBL5262R</b>	<b>HBL5362R</b>
	White	<b>HBL5262W</b>	<b>HBL5362W</b>
Isolated ground <sup>A</sup> .	Gray	<b>IG5262GY</b>	<b>IG5362GY</b>
	Ivory	<b>IG5262I</b>	<b>IG5362I</b>
	Orange	<b>IG5262</b>	<b>IG5362</b>
	Red	<b>IG5262R</b>	<b>IG5362R</b>
	White	-	<b>IG5362W</b>
Non-isolated ground, bulk pack of 100.	Orange	-	<b>HBL5362M4</b>
Weather Resistant, flush, nylon face, back and side wired.	Black	<b>HBL5262BKWR</b>	<b>HBL5362BKWR</b>
	Brown	<b>HBL5262WR</b>	<b>HBL5362WR</b>
	Gray	<b>HBL5262GYWR</b>	<b>HBL5362GYWR</b>
	Ivory	<b>HBL5262IWR</b>	<b>HBL5362IWR</b>
	Red	<b>HBL5262RWR</b>	<b>HBL5362RWR</b>
	White	<b>HBL5262WWR</b>	<b>HBL5362WWR</b>
Corrosion resistant.	Ivory	<b>HBL52CM62I</b>	-
	Yellow	<b>HBL52CM62</b>	<b>HBL53CM62</b>
Weather Resistant, Isolated ground <sup>A</sup> .	Gray	<b>IG5262GYWR</b>	<b>IG5362GYWR</b>
	Ivory	<b>IG5262IWR</b>	<b>IG5362IWR</b>
	Orange	<b>IG5262WR</b>	<b>IG5362WR</b>
	Red	<b>IG5262RWR</b>	<b>IG5362RWR</b>
	White	-	<b>IG5362WWR</b>
On 4 in. (101.6) round cover.	Brown	<b>HBL5282</b>	-

### Single

Description	Color	Catalog Number	
Flush, nylon face, back and side wired.	Black	<b>HBL5261BK</b>	<b>HBL5361BK</b>
	Brown	<b>HBL5261</b>	<b>HBL5361</b>
	Gray	-	<b>HBL5361GRY</b>
	Ivory	<b>HBL5261I</b>	<b>HBL5361I</b>
	White	-	<b>HBL5361W</b>
Isolated ground <sup>A</sup> .	Orange	<b>IG5261</b>	<b>IG5361</b>
Weather Resistant, Isolated ground <sup>A</sup> .	Orange	<b>IG5261WR</b>	<b>IG5361WR</b>
Ring terminal connection.	Brown	<b>HBL5261RT</b>	<b>HBL5361RT</b>
	White	<b>HBL5261WRT</b>	-
	Yellow	<b>HBL5261YRT</b>	-
Weather Resistant, flush, nylon face, back and side wired.	Brown	<b>HBL5261WR</b>	<b>HBL5361WR</b>
	Gray	<b>HBL5261GRYWR</b>	<b>HBL5361GRYWR</b>
	Ivory	<b>HBL5261IWR</b>	<b>HBL5361IWR</b>
Corrosion resistant.	Yellow	<b>HBL52CM61</b>	<b>HBL53CM61</b>
Panel mount on 1.94 in. (49.3) centers.	Brown	<b>HBL5284</b>	<b>HBL5357</b>

Note: <sup>A</sup>See section M for additional information on isolated ground devices.  
 See pages A-46 and A-47 for accessories.  
 See page Tech-10 for Weather Resistant descriptions.  
 See section N for wallplates.

Dimensions in Inches (mm)

Straight Blade Devices  
**15 and 20 Ampere, 125 Volts**  
 2 Pole, 3 Wire Grounding



**15A 125V**  
 NEMA 5-15R  
 UL CSA  
 0.5 HP



**20A 125V**  
 NEMA 5-20R  
 UL CSA  
 1 HP

**HBL® Extra Heavy Duty Compact Receptacles**

**Duplex**

Description	Color	Catalog Number	
Flush, nylon face, back and side wired.	Black	HBL5252BK	HBL5352BK
	Blue	-	HBL5352BL
	Brown	HBL5252	HBL5352
	Gray	HBL5252GY	HBL5352GY
	Ivory	HBL5252I	HBL5352I
	Red	HBL5252R	HBL5352R
	White	HBL5252W	HBL5352W
On a 4 in. (101.6) round cover.	Brown	HBL5253	-

**Duplex**

Description	Color	Catalog Number	
Flush, nylon face, side wired only.	Brown	HBL5242	HBL5342
	Gray	HBL5242GY	HBL5342GY
	Ivory	HBL5242I	HBL5342I
	White	HBL5242W	HBL5342W
Ring terminal connection.	Brown	HBL5242RT	HBL5342RT

**Single**

Description	Color	Catalog Number	
Flush, side wired only.	Brown	HBL5251	-
	Ivory	HBL5251I	-
Panel mount 1.75 in. (44.5) centers.	Brown	HBL5258	HBL5358
	Ivory	HBL5258I	-

**Style Line® Decorator\***

Description	Color	Catalog Number	
Flush, nylon face, back and side wired.	Almond	HBL2152AL	HBL2162AL
	Black	HBL2152BK	HBL2162BK
	Brown	HBL2152	HBL2162
	Gray	HBL2152GY	HBL2162GY
	Ivory	HBL2152I	HBL2162I
	Office White	HBL2152OW	HBL2162OW
	White	HBL2152WA	HBL2162WA
Isolated ground <sup>A</sup> .	Gray	-	IG2162GY
	Orange	IG2152	IG2162

Note: <sup>A</sup> See section M for additional information on isolated ground devices.  
 \*Style Line Duplex devices are not Fed. Spec. Listed.  
 See page A-46 for accessories.  
 See section N for wallplates.

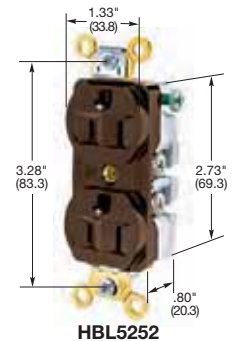

**HBL5252**

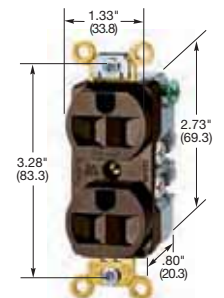

**HBL5242**

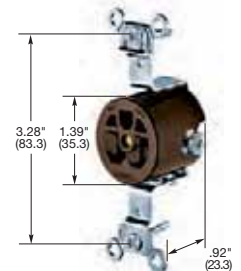

**HBL5251**

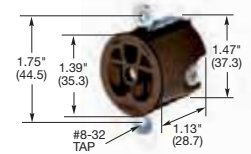

**HBL5258**

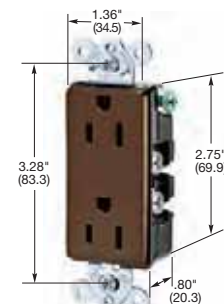

**HBL2152**

Dimensions in Inches (mm)

Straight Blade Devices  
**Extra Heavy Duty SNAPConnect® Receptacles**  
*Features and Benefits*

**No Special Tester Required**

.085 inch keyhole accepts the probe points found on the most common voltage testers and digital multi-meters



Installation ease  
 • Self-grounding clip

Requires minimal box space  
 • Compact size  
 • Clean finished look

Audible SNAP, indicates solid connection  
 • Secure, easy grip latch

Inspection of power contacts  
 • Clear terminal housing  
 • No exposed metal

SNAP1RA

SNAP5362IA

*Many of these products are Assembled in USA, as indicated, and many are Buy American Compliant. Please contact Hubbell with any certification requirements.*

**Labor Savings Feature!**



**Save one Minute!**  
 Rough-in the SNAPConnect® terminal instead of pigtails.



**Save Over Three Minutes!**  
 Remove protective packaging and SNAPConnect® device to the circuit.



**Complete Trim-Out in Less Than One Minute!**  
 Secure mounting screws, attach wallplate, job complete.

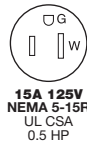

## Extra Heavy Duty SNAPConnect® Receptacles

### Duplex

Description	Color	Catalog Number	Catalog Number
Specification grade, finder groove, nylon face, modular receptacle which requires pigtailed connector below. Assembled in USA*.	Black	SNAP5262BKA*	SNAP5362BKA*
	Brown	SNAP5262A*	SNAP5362A*
	Gray	SNAP5262GYA*	SNAP5362GYA*
	Ivory	SNAP5262IA*	SNAP5362IA*
	Light Almond	SNAP5262LAA*	SNAP5362LAA*
	Red	SNAP5262RA*	SNAP5362RA*
	White	SNAP5262WA*	SNAP5362WA*
Specification grade, Tamper-Resistant, smooth nylon face, modular receptacle which requires pigtailed connector below. Assembled in USA.	Black	SNAP5262BKTR	SNAP5362BKTR
	Blue	SNAP5262BLTR	SNAP5362BLTR
	Brown	SNAP5262TR	SNAP5362TR
	Gray	SNAP5262GYTR	SNAP5362GYTR
	Ivory	SNAP5262ITR	SNAP5362ITR
	Light Almond	SNAP5262LATR	SNAP5362LATR
	Red	SNAP5262RTR	SNAP5362RTR
White	SNAP5262WTR	SNAP5362WTR	
Isolated ground <sup>A</sup> , Specification grade, Tamper-Resistant.	Orange	SNAP5262IGTR	SNAP5362IGTR
Specification grade, with Power Indicating LED, smooth nylon face, modular receptacle which requires pigtailed connector below. Assembled in USA.	Black	SNAP5262BKL	SNAP5362BKL
	Blue	SNAP5262BLL	SNAP5362BLL
	Brown	SNAP5262L	SNAP5362L
	Gray	SNAP5262GYL	SNAP5362GYL
	Ivory	SNAP5262IL	SNAP5362IL
	Light Almond	SNAP5262LAL	SNAP5362LAL
	Red	SNAP5262RL	SNAP5362RL
White	SNAP5262WL	SNAP5362WL	
Isolated ground <sup>A</sup> , Specification grade, with Power Indicating LED.	Orange	SNAP5262IGL	SNAP5362IGL
Specification grade, Tamper-Resistant, with Power Indicating LED, smooth nylon face, modular receptacle which requires pigtailed connector below. Assembled in USA.	Black	SNAP5262BKLTR	SNAP5362BKLTR
	Blue	SNAP5262BLLTR	SNAP5362BLLTR
	Brown	SNAP5262LTR	SNAP5362LTR
	Gray	SNAP5262GYLTR	SNAP5362GYLTR
	Ivory	SNAP5262ILTR	SNAP5362ILTR
	Light Almond	SNAP5262LALTR	SNAP5362LALTR
	Red	SNAP5262RLTR	SNAP5362RLTR
White	SNAP5262WLTR	SNAP5362WLTR	
Isolated ground <sup>A</sup> , Specification grade, TR with Power Indicating LED.	Orange	SNAP5262IGLTR	SNAP5362IGLTR

Note: <sup>A</sup> See section M additional information on isolated ground devices.  
 See page Tech-10 for Tamper-Resistant and LED Power Indicators description.  
 See pages A-46 and A-47 for accessories.  
 See page A-54 for technical information.  
 See section N for wallplates.  
 Consult factory for available Split-Circuit capable SNAPConnect® devices.

### SNAPConnect® Right Angle Pigtailed Connector

Description	Wire Type	General Use Catalog Number	Assembled in USA Catalog Number
Clear right angle terminal with 6 inch leads #12 AWG THHN/THWN-2; Polycarbonate housing material	Solid	SNAP1RA	SNAP1RNA
	Stranded	SNAP2RA	SNAP2RNA

Note: For Assembled in USA products, must order connector with NA suffix.  
 See page A-54 for technical information.

**Many of these products are Assembled in USA, as indicated, and many are Buy American Compliant. Please contact Hubbell with any certification requirements.**

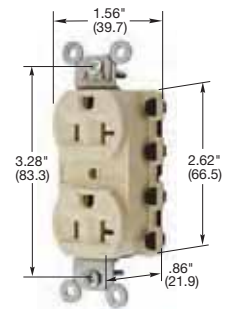

SNAP5362IA

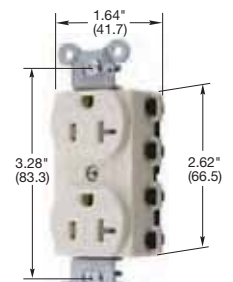

SNAP5362LATR

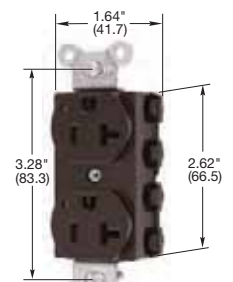

SNAP5362L

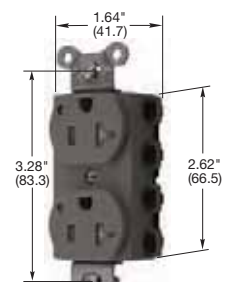

SNAP5362GYLTR

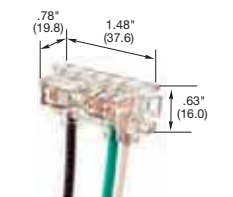

SNAP1RA

Dimensions in Inches (mm)

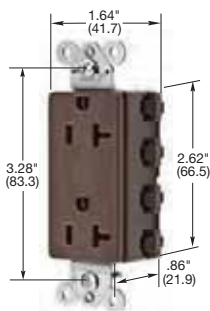

SNAP2162A

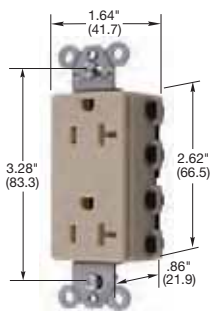

SNAP2162ITR

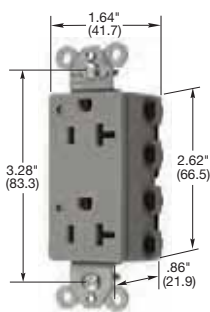

SNAP2162GYL

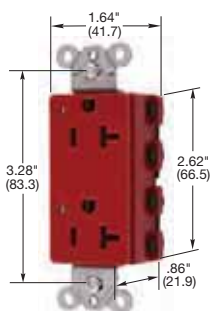

SNAP2162RLTR

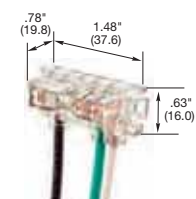





SNAP1RA

Dimensions in Inches (mm)

## Extra Heavy Duty SNAPConnect® Receptacles

### Style Line® Decorator



Description	Color	Catalog Number	
Specification grade, Style Line® decorator, flush, nylon face, modular receptacle which requires pigtailed connector below. Assembled in USA*.	Black Brown Gray Ivory Light Almond Red White	SNAP2152BKA* SNAP2152A* SNAP2152GYA* SNAP2152IA* SNAP2152LAA* SNAP2152RA* SNAP2152WA*	SNAP2162BKA* SNAP2162A* SNAP2162GYA* SNAP2162IA* SNAP2162LAA* SNAP2162RA* SNAP2162WA*
 Specification grade, Tamper-Resistant, Style Line® decorator, flush, nylon face, modular receptacle which requires pigtailed connector below. Assembled in USA.	Black Blue Brown Gray Ivory Light Almond Red White	SNAP2152BKTR SNAP2152BLTR SNAP2152TR SNAP2152GYTR SNAP2152ITR SNAP2152LATR SNAP2152RTR SNAP2152WTR	SNAP2162BKTR SNAP2162BLTR SNAP2162TR SNAP2162GYTR SNAP2162ITR SNAP2162LATR SNAP2162RTR SNAP2162WTR
Isolated ground <sup>A</sup> , Specification grade, Tamper-Resistant.	Orange	SNAP2152IGTR	SNAP2162IGTR
 Specification grade, with Power Indicating LED, Style Line® decorator, flush, nylon face, modular receptacle which requires pigtailed connector below. Assembled in USA.	Black Blue Brown Gray Ivory Light Almond Red White	SNAP2152BKLL SNAP2152BLLL SNAP2152L SNAP2152GYL SNAP2152IL SNAP2152LAL SNAP2152RL SNAP2152WL	SNAP2162BKLL SNAP2162BLLL SNAP2162L SNAP2162GYL SNAP2162IL SNAP2162LAL SNAP2162RL SNAP2162WL
Isolated ground <sup>A</sup> , Specification grade, with Power Indicating LED.	Orange	SNAP2152IGL	SNAP2162IGL
  Specification grade, Tamper-Resistant, with Power Indicating LED, Style Line® decorator, flush, nylon face, modular receptacle which requires pigtailed connector below. Assembled in USA.	Black Blue Brown Gray Ivory Light Almond Red White	SNAP2152BKLLTR SNAP2152BLLLTR SNAP2152LTR SNAP2152GYLTR SNAP2152ILTR SNAP2152LALTR SNAP2152RLTR SNAP2152WLTR	SNAP2162BKLLTR SNAP2162BLLLTR SNAP2162LTR SNAP2162GYLTR SNAP2162ILTR SNAP2162LALTR SNAP2162RLTR SNAP2162WLTR
Isolated ground <sup>A</sup> , Specification grade, TR with Power Indicating LED.	Orange	SNAP2152IGLTR	SNAP2162IGLTR

Note: <sup>A</sup> See section M additional information on isolated ground devices.  
 See page Tech-10 for Tamper-Resistant and LED Power Indicators description.  
 See pages A-46 and A-47 for accessories.  
 See page A-54 for technical information.  
 See section N for wallplates.  
 Consult factory for available Split-Circuit capable SNAPConnect® devices.

### SNAPConnect® Right Angle Pigtailed Connector

Description	Wire Type	General Use Catalog Number	Assembled in USA Catalog Number
Clear right angle terminal with 6 inch leads	Solid	SNAP1RA	SNAP1RNA
#12 AWG THHN/THWN-2; Polycarbonate housing material	Stranded	SNAP2RA	SNAP2RNA

Note: For Assembled in USA products, must order connector with NA suffix.  
 See page A-54 for technical information.

**Many of these products are Assembled in USA, as indicated, and many are Buy American Compliant. Please contact Hubbell with any certification requirements.**



Straight Blade Devices  
**15 and 20 Ampere, 125 Volts**  
 2 Pole, 3 Wire Grounding



## Hubbell-PRO Heavy Duty Specification Grade Receptacles

### Duplex

Description	Color	15A 125V NEMA 5-15R UL CSA 0.5 HP	20A 125V NEMA 5-20R UL CSA 1 HP
Smooth nylon face, duplex, back and side wired.	Almond	5252AAL	5352AAL
	Black	5252ABLK	5352ABLK
	Brown	5252AB	5352AB
	Gray	5252AG	5352AG
	Ivory	5252AI	5352AI
	Light Almond	5252ALA	5352ALA
	Office White	5252AOW	5352AOW
	Red	5252AR	5352AR
	White	5252AW	5352AW
Isolated ground <sup>A</sup> , smooth face, duplex, back and side wired.	Almond	IG5252AL	IG5352AL
	Gray	IG5252GY	IG5352GY
	Ivory	IG5252I	IG5352I
	Light Almond	IG5252LA	IG5352LA
	White	IG5252W	IG5352W
Isolated ground <sup>A</sup> , Tamper-Resistant, smooth face, duplex, back and side wired.	Ivory	IG5252ITR	IG5352ITR
	Orange	IG5252TR	IG5352TR
	White	IG5252WTR	IG5352WTR
Finder groove nylon face, duplex, back and side wired.	Almond	5262AL	5362AL
	Black	5262BLK	5362BLK
	Blue	-	5362BL
	Brown	5262B	5362B
	Gray	5262G	5362G
	Ivory	5262I	5362I
	Light Almond	5262LA	5362LA
	Office White	5262OW	5362OW
	White	5262W	5362W
Weather Resistant, finder groove nylon face, duplex, back and side wired.	Black	5262BKWR	5362BKWR
	Brown	5262WR	5362WR
	Gray	5262GYWR	5362GYWR
	Ivory	5262IWR	5362IWR
	White	5262WWR	5362WWR
Isolated ground <sup>A</sup> , finder groove face, duplex, back and side wired.	Black	CR5252IGBK	CR5352IGBK
	Blue	-	CR5352IGBL
	Gray	CR5252IGGY	CR5352IGGY
	Ivory	CR5252IGI	CR5352IGI
	Orange	CR5252IG	CR5352IG
	Office White	CR5252IGOW	CR5352IGOW
White	CR5252IGW	CR5352IGW	

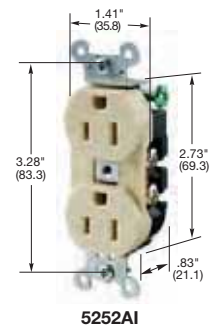

5252AI

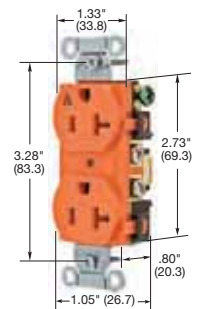

IG5352

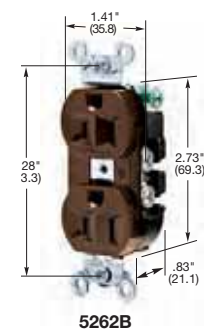

5262B

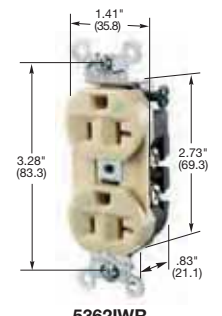

5362IWR

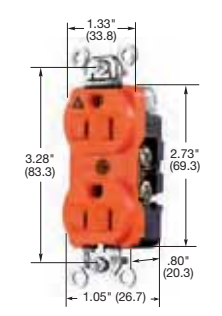

CR5252IG

Dimensions in Inches (mm)

Note: <sup>A</sup> See section M for additional information on isolated ground devices.  
 See page A-46 for accessories.  
 See page A-57 for technical information.  
 See page Tech-10 for Tamper and Weather Resistant descriptions.  
 Horsepower ratings listed above are AC only.  
 See section N for wallplates.

## USB Charger Receptacle Tamper-Resistant Duplex

Hubbell's USB Charger Receptacle provides both USB and AC electrical power in a standard single gang electrical opening. Designed to provide more charging options for personal electronics.

### Typical Applications

Ideal for use in renovation, new construction and to add capacity for USB charging. Especially suited for use in hotels, hospitals, schools, offices, homes and more.



Hotels



Healthcare



Schools



Offices



Residential

Capability to charge wide range of devices including:

- Tablets
- Smartphones
- MP3 players
- Apple® iPad®
- Apple® iPod®
- Apple® iPhone®

- Complies with battery charging specification USB BC1.2
- Compatible with USB 1.1/2.0/3.0 devices, including Apple® products
- Complies with Part 15 of the FCC rules
- cULus listed to UL498 and UL1310

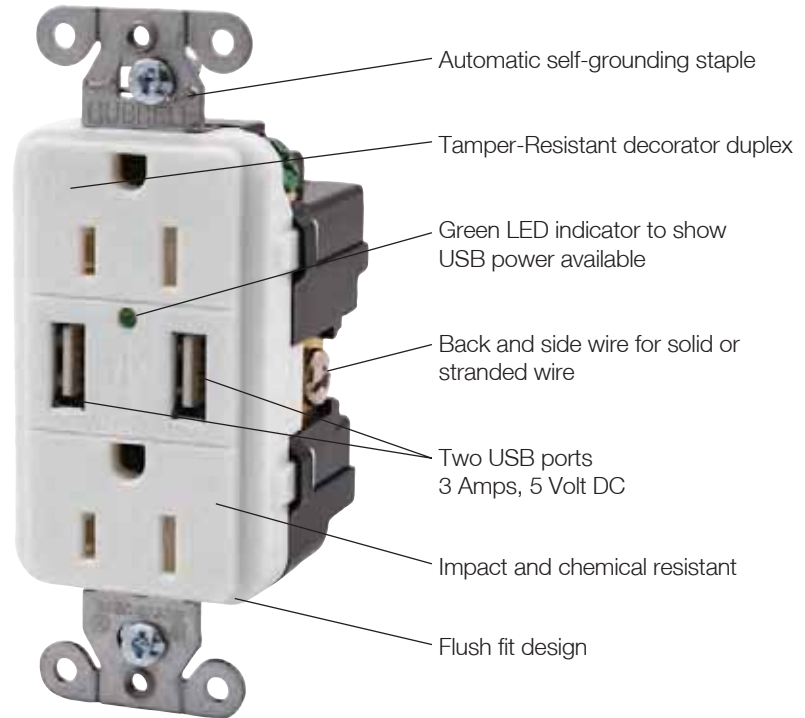

USB15X2W



**15A 125V**  
 NEMA 5-15R  
 UL CSA  
 0.5 HP



**20A 125V**  
 NEMA 5-20R  
 UL CSA  
 1 HP

## USB Charger Receptacles



Description	Color	15A 125V AC	20A 125V AC
USB Charger Tamper-Resistant receptacle, Two USB Type 2.0 ports 3 Amp, 5 Volt DC, 15 or 20 Amp, 125 Volt AC decorator duplex.	Black	<b>USB15X2BK</b>	<b>USB20X2BK</b>
	Brown	<b>USB15X2</b>	<b>USB20X2</b>
	Gray	<b>USB15X2GY</b>	<b>USB20X2GY</b>
	Ivory	<b>USB15X2I</b>	<b>USB20X2I</b>
	Light Almond	<b>USB15X2LA</b>	<b>USB20X2LA</b>
	White	<b>USB15X2W</b>	<b>USB20X2W</b>

Note: See page Tech-10 for Tamper-Resistant descriptions.  
 See page A-8 for Hospital Grade version.  
 See page A-56 for technical information.

Apple, iPad, iPod and iPhone are registered trademarks of Apple, inc.

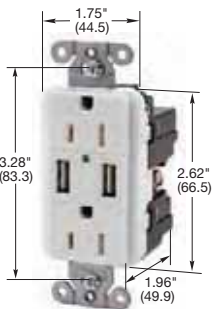

USB15X2W

Dimensions in Inches (mm)

Straight Blade Devices  
**Commercial Specification Grade Receptacles**  
*Features and Benefits*



**BR15I**

- Installation ease
  - Single tab breakoff ears
  - Self-grounding staple
- Durable construction
  - Nylon face and base
- Installation ease
  - Easy access split circuit tab
  - Fork terminal capable
  - Oversized terminal screws
- Sturdy construction
  - Wrap-around galvanized steel straps



**Tamper-Resistant**



**BR15TR**



**DR20I**

- Installation ease
  - Self-grounding staple
- Durable construction
  - Nylon face and base
- Installation ease
  - Easy access split circuit tab
  - Fork terminal capable
- Modern architectural appearance
  - Style Line® decorator face
- Sturdy construction
  - Wrap-around galvanized steel straps



**Tamper-Resistant**



**DR20GRYTR**

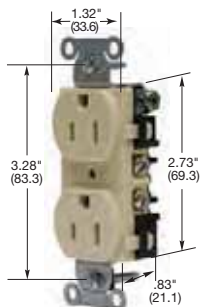

**BR15I**

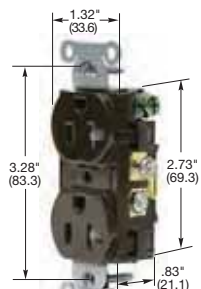

**BR20TR**

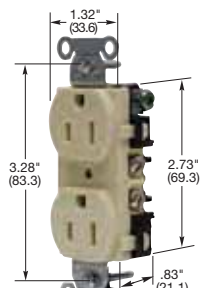

**BR15IWR**

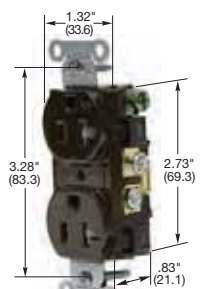

**BR20WRTR**

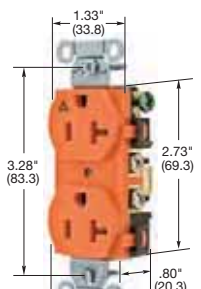

**IG20CR**

Dimensions in Inches (mm)

## Commercial Specification Grade Receptacles



### Duplex



**15A 125V**  
 NEMA 5-15R  
 UL CSA  
 0.5 HP



**20A 125V**  
 NEMA 5-20R  
 UL CSA  
 1 HP

Description	Color	Catalog Number		
Smooth nylon face, duplex, back and side wired.	Almond	<b>BR15AL</b>	<b>BR20AL</b>	
	Black	<b>BR15BLK</b>	<b>BR20BLK</b>	
	Blue	<b>BR15BL</b>	<b>BR20BL</b>	
	Brown	<b>BR15</b>	<b>BR20</b>	
	Gray	<b>BR15GRY</b>	<b>BR20GRY</b>	
	Ivory	<b>BR15I</b>	<b>BR20I</b>	
	Light Almond	<b>BR15LA</b>	<b>BR20LA</b>	
	Office White	<b>BR15OW</b>	<b>BR20OW</b>	
	Red	<b>BR15R</b>	<b>BR20R</b>	
	White	<b>BR15WHI</b>	<b>BR20WHI</b>	
	 Tamper-Resistant*, smooth nylon face, duplex, back and side wired.	Almond	<b>BR15ALTR</b>	<b>BR20ALTR</b>
Black		<b>BR15BLKTR</b>	<b>BR20BLKTR</b>	
Blue		<b>BR15BLTR</b>	<b>BR20BLTR</b>	
Brown		<b>BR15TR</b>	<b>BR20TR</b>	
Gray		<b>BR15GRYTR</b>	<b>BR20GRYTR</b>	
Ivory		<b>BR15ITR</b>	<b>BR20ITR</b>	
Light Almond		<b>BR15LATR</b>	<b>BR20LATR</b>	
Red		<b>BR15RTR</b>	<b>BR20RTR</b>	
White		<b>BR15WHITR</b>	<b>BR20WHITR</b>	
 Weather Resistant, smooth nylon face, duplex, back and side wired.		Black	<b>BR15BLKW</b>	<b>BR20BLKW</b>
		Brown	<b>BR15WR</b>	<b>BR20WR</b>
	Gray	<b>BR15GRYW</b>	<b>BR20GRYW</b>	
	Ivory	<b>BR15IWR</b>	<b>BR20IWR</b>	
	Light Almond	<b>BR15LAW</b>	<b>BR20LAW</b>	
 Weather and Tamper-Resistant*, smooth nylon face, duplex, back and side wired.	Black	<b>BR15BLKWTR</b>	<b>BR20BLKWTR</b>	
	Brown	<b>BR15WRTR</b>	<b>BR20WRTR</b>	
	Gray	<b>BR15GRYWTR</b>	<b>BR20GRYWTR</b>	
	Ivory	<b>BR15IWRTR</b>	<b>BR20IWRTR</b>	
	Light Almond	<b>BR15LAWTR</b>	<b>BR20LAWTR</b>	
Isolated ground <sup>A</sup> , smooth nylon face, duplex, side wired only.	Almond	<b>IG15CRAL</b>	<b>IG20CRAL</b>	
	Gray	<b>IG15CRGRY</b>	<b>IG20CRGRY</b>	
	Ivory	<b>IG15CRI</b>	<b>IG20CRI</b>	
	Light Almond	<b>IG15CRLA</b>	<b>IG20CRLA</b>	
	Orange	<b>IG15CR</b>	<b>IG20CR</b>	
Isolated ground <sup>A</sup> , Style Line <sup>®</sup> decorator*, smooth nylon face, duplex, back and side wired.	Almond	<b>IG15DRAL</b>	<b>IG20DRAL</b>	
	Gray	<b>IG15DRGRY</b>	<b>IG20DRGRY</b>	
	Ivory	<b>IG15DRI</b>	<b>IG20DRI</b>	
	Light Almond	<b>IG15DRLA</b>	<b>IG20DRLA</b>	
	Orange	<b>IG15DR</b>	<b>IG20DR</b>	
White	<b>IG15DRWHI</b>	<b>IG20DRWHI</b>		

Note: <sup>A</sup> See section M for additional information on isolated ground devices.  
 \*Tamper-resistant and IG decorator devices are not Fed. Spec. Listed.  
 See page A-46 for accessories.  
 See page A-59 for technical information.  
 See page Tech-10 for Tamper and Weather Resistant descriptions.  
 See section N for wallplates.



**15A 125V**  
 NEMA 5-15R  
 UL CSA  
 0.5 HP



**20A 125V**  
 NEMA 5-20R  
 UL CSA  
 1 HP

## Commercial Specification Grade Receptacles

### Style Line® Decorator

Description	Color	Catalog Number	
Smooth nylon face, Style Line® decorator, back and side wired.	Almond	DR15AL	DR20AL
	Black	DR15BLK	DR20BLK
	Brown	DR15	DR20
	Gray	DR15GRY	DR20GRY
	Ivory	DR15I	DR20I
	Light Almond	DR15LA	DR20LA
	Red	DR15R	DR20R
White	DR15WHI	DR20WHI	
Tamper-Resistant*, Style Line® decorator, smooth nylon face, back and side wired.	Almond	DR15ALTR	DR20ALTR
	Black	DR15BLKTR	DR20BLKTR
	Brown	DR15TR	DR20TR
	Gray	DR15GRYTR	DR20GRYTR
	Ivory	DR15ITR	DR20ITR
	Light Almond	DR15LATR	DR20LATR
	White	DR15WHITR	DR20WHITR
Weather and Tamper-Resistant*, Style Line® decorator, smooth nylon face, back and side wired.	Black	DR15BLKWRTR	DR20BLKWRTR
	Brown	DR15WRTR	DR20WRTR
	Gray	DR15GRYWRTR	DR20GRYWRTR
	Ivory	DR15IWRTR	DR20IWRTR
	Light Almond	DR15LAWRTR	DR20LAWRTR
	White	DR15WHIWRTR	DR20WHIWRTR
Pre-wired receptacles, Style Line® decorator, smooth nylon face, back and side wired, self-grounding, 8" solid wire leads.	Black	DR15BLKP1	DR20BLKP1
	Brown	DR15P1	DR20P1
	Gray	DR15GRYP1	DR20GRYP1
	Ivory	DR15IP1	DR20IP1
	Light Almond	DR15LAP1	DR20LAP1
	White	DR15WHIP1	DR20WHIP1
Pre-wired receptacles, Style Line® decorator, smooth nylon face, back and side wired, self-grounding, 8" stranded wire leads.	Black	DR15BLKP2	DR20BLKP2
	Brown	DR15P2	DR20P2
	Gray	DR15GRYP2	DR20GRYP2
	Ivory	DR15IP2	DR20IP2
	Light Almond	DR15LAP2	DR20LAP2
	White	DR15WHIP2	DR20WHIP2
Pre-wired receptacles, Tamper-Resistant*, Style Line® decorator, smooth nylon face, back and side wired, self-grounding, 8" solid wire leads.	Black	DR15BLKTRP1	DR20BLKTRP1
	Brown	DR15TRP1	DR20TRP1
	Gray	DR15GRYTRP1	DR20GRYTRP1
	Ivory	DR15ITRP1	DR20ITRP1
	Light Almond	DR15LATRP1	DR20LATRP1
	White	DR15WHITRP1	DR20WHITRP1
Pre-wired receptacles, Tamper-Resistant*, Style Line® decorator, smooth nylon face, back and side wired, self-grounding, 8" stranded wire leads.	Black	DR15BLKTRP2	DR20BLKTRP2
	Brown	DR15TRP2	DR20TRP2
	Gray	DR15GRYTRP2	DR20GRYTRP2
	Ivory	DR15ITRP2	DR20ITRP2
	Light Almond	DR15LATRP2	DR20LATRP2
	White	DR15WHITRP2	DR20WHITRP2

Note: \*Tamper-resistant devices are not Fed. Spec. Listed.  
 See page A-46 for accessories.  
 See pages A-58 and A-59 for technical information.  
 See page Tech-10 for Tamper and Weather Resistant descriptions.  
 See section N for wallplates.

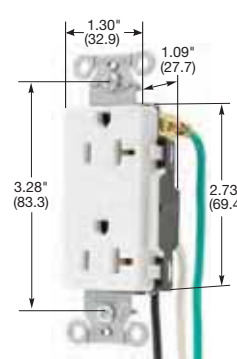
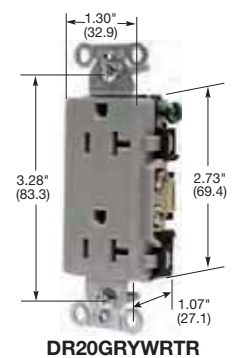
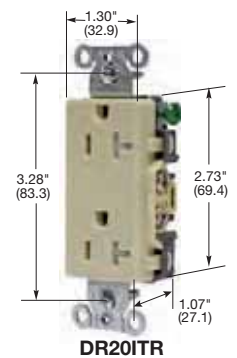
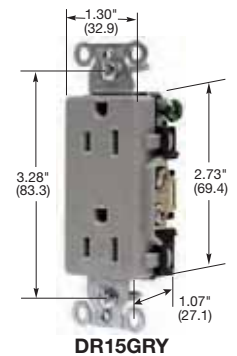

Dimensions in Inches (mm)



## Commercial Specification Grade Receptacles

### Duplex

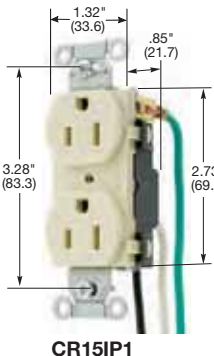
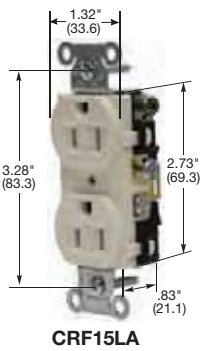
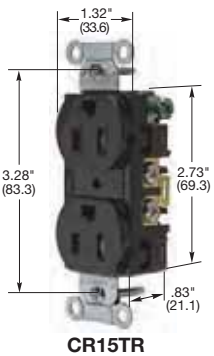
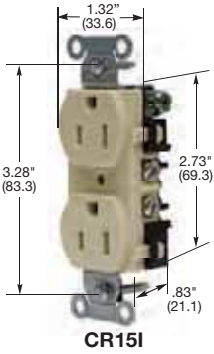

Tamper-Resistant\*, smooth nylon face, duplex, side wired only.

Finder groove, nylon face, duplex, side wired only.

Pre-wired receptacles, smooth nylon face, duplex, side wired only, self-grounding, 8" solid wire leads.

Pre-wired receptacles, smooth nylon face, duplex, side wired only, self-grounding, 8" stranded wire leads.



Tamper-Resistant\*, smooth nylon face, duplex, side wired only, self-grounding, 8" solid wire leads.



Tamper-Resistant\*, smooth nylon face, duplex, side wired only, self-grounding, 8" stranded wire leads.

Description	Color	Catalog Number		
Smooth nylon face, duplex, side wired only.	Almond	CR15AL	CR20AL	
	Black	CR15BLK	CR20BLK	
	Brown	CR15	CR20	
	Gray	CR15GRY	CR20GRY	
	Ivory	CR15I	CR20I	
	Light Almond	CR15LA	CR20LA	
	Office White	CR15OW	CR20OW	
	White	CR15WHI	CR20WHI	
	Tamper-Resistant*, smooth nylon face, duplex, side wired only.	Almond	CR15ALTR	CR20ALTR
		Black	CR15BLKTR	CR20BLKTR
Brown		CR15TR	CR20TR	
Gray		CR15GRYTR	CR20GRYTR	
Ivory		CR15ITR	CR20ITR	
Light Almond		CR15LATR	CR20LATR	
Office White		CR15OWTR	CR20OWTR	
White		CR15WHITR	CR20WHITR	
Finder groove, nylon face, duplex, side wired only.		Almond	CRF15AL	CRF20AL
		Black	CRF15BLK	CRF20BLK
	Brown	CRF15	CRF20	
	Gray	CRF15GRY	CRF20GRY	
	Ivory	CRF15I	CRF20I	
	Light Almond	CRF15LA	CRF20LA	
	Office White	CRF15OW	CRF20OW	
	White	CRF15WHI	CRF20WHI	
	Pre-wired receptacles, smooth nylon face, duplex, side wired only, self-grounding, 8" solid wire leads.	Black	CR15BLKP1	CR20BLKP1
		Brown	CR15P1	CR20P1
Gray		CR15GRYP1	CR20GRYP1	
Ivory		CR15IP1	CR20IP1	
Light Almond		CR15LAP1	CR20LAP1	
White		CR15WHIP1	CR20WHIP1	
Pre-wired receptacles, smooth nylon face, duplex, side wired only, self-grounding, 8" stranded wire leads.		Black	CR15BLKP2	CR20BLKP2
		Brown	CR15P2	CR20P2
		Gray	CR15GRYP2	CR20GRYP2
		Ivory	CR15IP2	CR20IP2
	Light Almond	CR15LAP2	CR20LAP2	
	White	CR15WHIP2	CR20WHIP2	
	Pre-wired receptacles, Tamper-Resistant*, smooth nylon face, duplex, side wired only, self-grounding, 8" solid wire leads.	Black	CR15BLKTRP1	CR20BLKTRP1
		Brown	CR15TRP1	CR20TRP1
		Gray	CR15GRYTRP1	CR20GRYTRP1
		Ivory	CR15ITRP1	CR20ITRP1
Light Almond		CR15LATRP1	CR20LATRP1	
White		CR15WHITRP1	CR20WHITRP1	
Pre-wired receptacles, Tamper-Resistant*, smooth nylon face, duplex, side wired only, self-grounding, 8" stranded wire leads.		Black	CR15BLKTRP2	CR20BLKTRP2
		Brown	CR15TRP2	CR20TRP2
		Gray	CR15GRYTRP2	CR20GRYTRP2
		Ivory	CR15ITRP2	CR20ITRP2
	Light Almond	CR15LATRP2	CR20LATRP2	
	White	CR15WHITRP2	CR20WHITRP2	

Note: \*Tamper-resistant devices are not Fed. Spec. Listed.  
 See page A-46 for accessories.  
 See pages A-58 and A-59 for technical information.  
 See page Tech-10 for Tamper-Resistant descriptions.  
 See section N for wallplates.

Dimensions in Inches (mm)

### Four-in-One Receptacle

4-PLEX is a perfect solution for outlet scarce locations. This receptacle can be mounted on a single or 2-gang flush outlet box or on a non-metallic portable box for temporary power applications. If mounted on a 4-inch square box, this product complies with NEC® Article 406.4 (B). Available in industrial grade, hospital grade, isolated ground and surge protected versions. Accessories include mounting plates and portable outlet boxes.

- Mounts directly to 4-inch square box
- Unique face design accepts up to four straight, angle or molded plugs
- Heavy duty, impact resistant housing
- Heavy duty, triple wipe, brass power and ground contacts
- Removable knockouts for mounting to octagon concrete ring or box

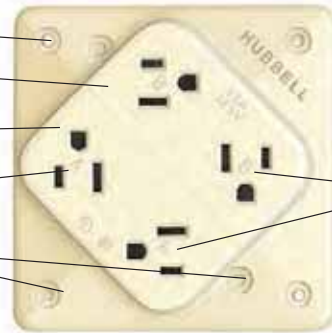

**HBL415I**

"A" and "B" circuit identification molded into face



- Snub hole for fast, easy terminations
- Easily accessible break-off tabs for split circuit wiring
- Three conductors energize all four outlets
- Large #8 combination Robertson head terminal screws for ease of wiring

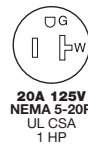
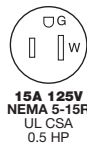

### 4-PLEX® Receptacles

#### Over Size Robertson/Slotted Head Terminal Screws

Description	Color	Catalog Number	
Specification grade.	Black	<b>HBL415BK</b>	<b>HBL420BK</b>
	Brown	<b>HBL415</b>	<b>HBL420</b>
	Gray	<b>HBL415GY</b>	<b>HBL420GY</b>
	Ivory	<b>HBL415I</b>	<b>HBL420I</b>
	White	<b>HBL415W</b>	<b>HBL420W</b>
Isolated ground <sup>A</sup> .	Orange	<b>IG415</b>	<b>IG420</b>
Surge suppression.	Blue	<b>HBL415S</b>	<b>HBL420S</b>
	Ivory	<b>HBL415IS</b>	<b>HBL420IS</b>

Note: <sup>A</sup> See section M for additional information on isolated ground devices.  
 Horsepower ratings are AC only.  
 See page A-60 for technical information.  
 4-PLEX Receptacles are of a non-metallic design. Product is supplied with isolated ground symbol stickers.  
 Apply if needed. Mounts to 4-inch square box.

### Accessories

Description	Color	Catalog Number
4-PLEX Adapter Plates for 1- and 2-gang.	Blue	<b>HBL4APBL</b>
	Brown	<b>HBL4AP</b>
	Gray	<b>HBL4APGY</b>
	Ivory	<b>HBL4API</b>
	Orange	<b>HBL4APO</b>
	Red	<b>HBL4APR</b>
4-PLEX Portable Box, 4 in. (101.6) square box with cord grip. Accepts up to .66 in. (16.8) diameter cord.	Black	<b>HBL4PBBK</b>
	Brown	<b>HBL4PB</b>
	Ivory	<b>HBL4PBI</b>

Note: 4-PLEX Box is not UL listed or CSA Certified. UL listing does not apply when 4-PLEX Receptacle is used with 4-PLEX Box in extension cord application. Supplied with one cord clamp.

NEC® is a registered trademark of the National Fire Protection Association (NFPA).

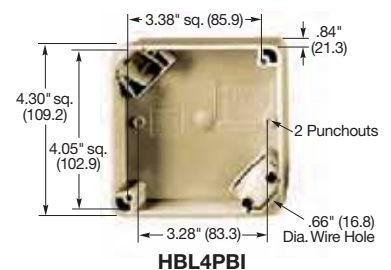
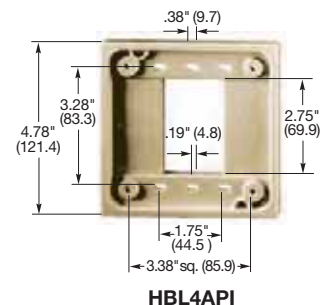
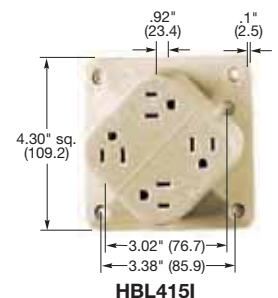

Dimensions in Inches (mm)

# Straight Blade Devices

## Pre-Fabricated Building Wiring System

Features and Benefits

### *Pre-Fab Systems Allow You To Save Time and Money, Completing the Job Quicker and Exceed Schedule*

- Provide Reduced Construction Schedules
- Ensure Consistent Quality
- Compliance with Code Requirements
- Speeds Installation

#### A Variety of Pre-Fab Solutions are Available:

1. Complete Turn key Pre-Fab System
2. Pre-Assembled Boxes and Brackets
3. Specialized Mounting Brackets and Hangers

#### Complete Pre-Fab System Steps:

1. Mail or E-mail Drawings
2. Complete Take Offs and Quotation Prepared
3. Proposal with Comparison to Traditional Methods is Submitted
4. Detail Documentation and Technical Support Provided

Note: For more information please contact Technical Services (475) 882-4820.



### *When Product Arrives*

- ✓ **Clearly Marked Skids**
  - By floor or area to customer specifications.



- ✓ **Boxes Labeled**
  - With job name, building number, room number.



- ✓ **Numbered Assemblies**
  - Labeled to match installation drawings.



- ✓ **Installation Drawings**
  - Detailed layout with specified locations.

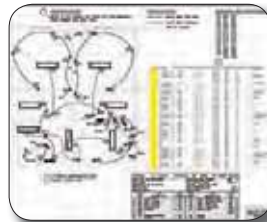

- ✓ **Field Installation Support**



- ✓ **Qualified Savings**
  - Demonstrate high light savings
  - Cost comparison to traditional wiring



Straight Blade Devices  
**Pre-Fabricated Building Wiring System**  
*Components*

**Box Assembly - With Universal Mounting Bracket Features**

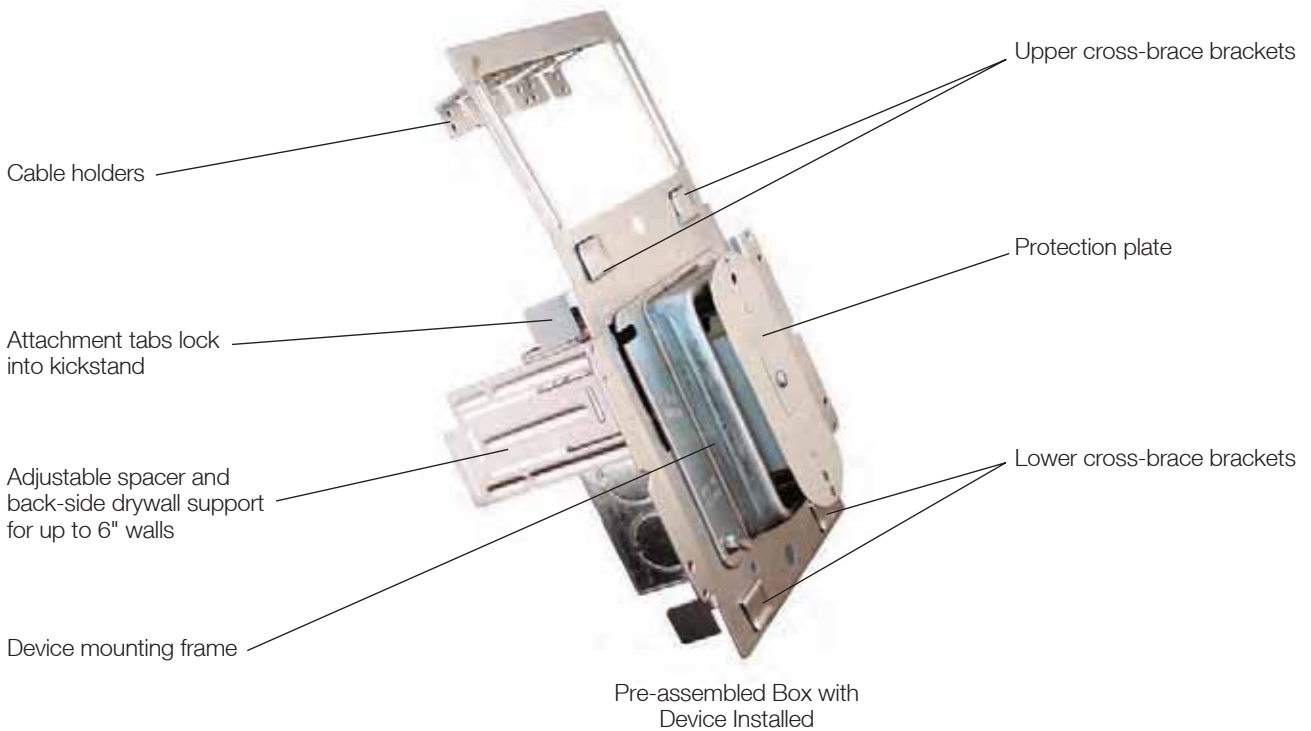

**Mounting Frames**

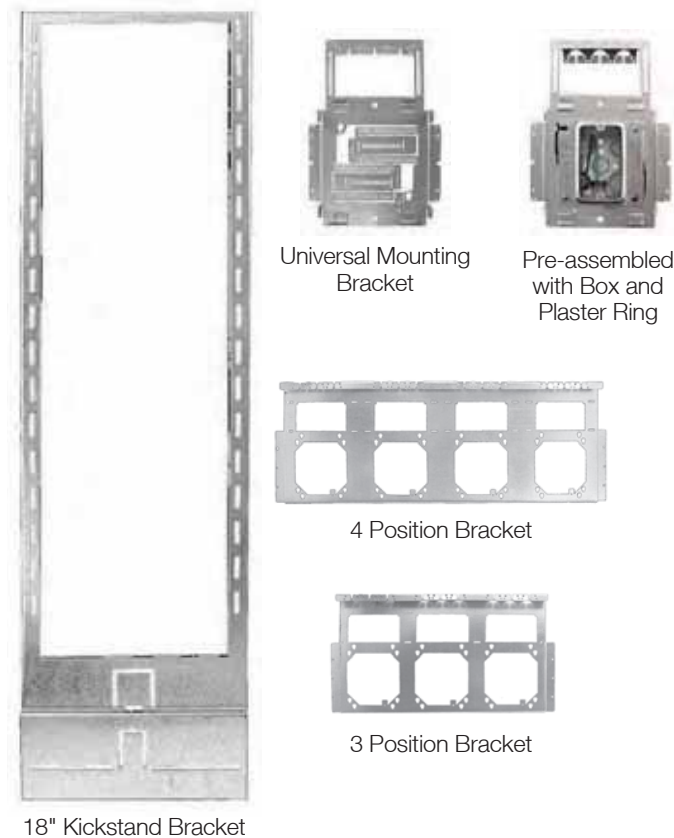

**Support Brackets and Hangers**

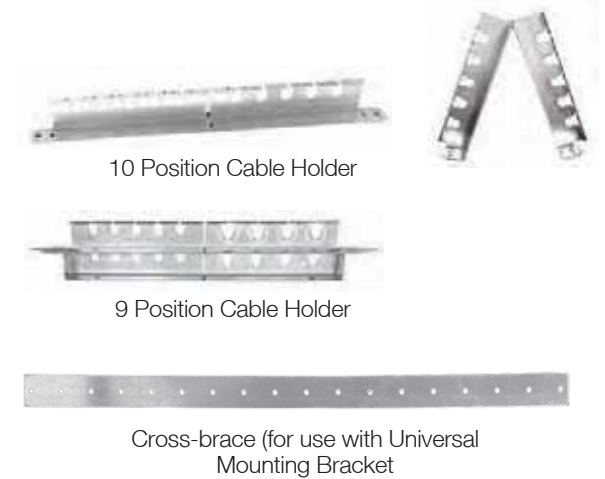

**Deck Hangers**



# Straight Blade Devices Insulgrip® and Valise® 15 and 20 Ampere Plugs and Connectors

Features and Benefits

Individually molded face for each blade configuration keeps debris out of plug interior

Roomy wiring chamber provides ample space for wiring

Individual wiring terminals completely enclosed in their own separate chambers

Powerful, offsetting cord grips clamp on individual conductors and outer cord jacket to prevent strain on terminals

Ribbed nylon housing is impact and chemical resistant

Beveled housing prevents snagging when dragged across uneven surfaces



HBL5266C



Integral VARI-SIZE® insert adjusts to a wide range of cord sizes: .23 to .72 inch (5.8 to 18.3).



VARI-SIZE® pointer set to "smaller than gauge" position. Cord diameter range is .23 to .36 inch (5.8 to 9.0). Accepts slotted and Phillips head drivers.



Multiple drive screws provide screwdriver versatility. Pocketed recess for cord grip screws deter slippage of the screwdriver..



Powerful offsetting cord grips clamp on individual conductors and outer cord jacket to prevent strain on terminations.



Catalog number is visible on the device while in use for easy identification.



Transparent angled wiring entrance holes permit "straight in" conductor insertion

## Valise® Plug

Eight specially designed load bearing locking lugs insure a positive fit as the blade holder and sides are closed

Powerful cord grips prevent conductor slippage and strain on wiring terminals

Removable cord inserts. Device accommodates a wide range of cord sizes, .220" -.660" (5.6-16.8)

Unique patented clamp type terminals provide a superior electrical connection by "bundling" the conductor strands when clamps are tightened

Nylon webs are provided to make wiring quick and easy by joining the three sections together during assembly

Totally insulated impact and crush resistant nylon body

Two captive multiple drive assembly screws



HBL5969VY

Straight Blade Devices  
**Elastogrip® High Visibility Yellow Plugs and Connectors**  
*Features and Benefits*

**Watertight Plug**

Multiple drive "U-Drive" fast lead body assembly screws

Neoprene bushing keeps water and dust out

Color coded Kellems GOTCHA® rings provide increased cord retention

Thermoplastic elastomer housing resists weathering caused by ultraviolet rays and ozone better than rubber; Also oil and chemical resistant



**HBL14W47**

Three separate transparent wiring chambers allow for visual inspection

**Watertight Connector Body**

Closure plug seals connector body when disconnected from plug

Integral weatherproofing shroud seals connection between plug and connector

Pretensioned "bypass" design female contacts for abuse resistance and reliability



**HBL15W47**

Nylon compression nut keeps water and dust from getting into the body around the cord

**Dust Tight Plug**

Thermoplastic elastomer housing

Powerful nylon cord grip prevents strain on terminals

Dust and moisture seal keeps out liquids, metal filings and other foreign materials



**HBL1447**

Multiple drive "U-Drive" fast lead body assembly screws

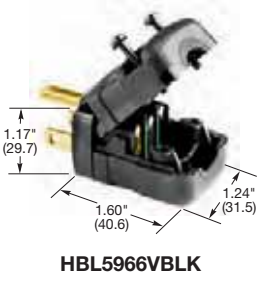

## Plugs

### Insulgrip®

Description	Cord Diameter	Catalog Number	
Black and white nylon.	.230"-.720" (5.8-18.3)	<b>HBL5266C</b>	<b>HBL5366C</b>
Blue and white nylon.	.230"-.720" (5.8-18.3)	<b>HBL5266CBL</b>	-
Black nylon extra large cord clamp.	.360"-.720" (9.1-18.3)	<b>HBL5266EBK</b>	<b>HBL5366EBK</b>
Corrosion resistant yellow nylon.	.230"-.720" (5.8-18.3)	<b>HBL52CM66C</b>	<b>HBL53CM66C</b>
8-position angle plug, black and white nylon.	.325"-.655" (8.3-16.6)	<b>HBL5266CA</b>	<b>HBL5366CA</b>
8-position angle plug, transparent enclosure.	.325"-.655" (8.3-16.6)	<b>HBL5266CAT</b>	-
Anchor lock, black and white nylon.	.230"-.720" (5.8-18.3)	<b>HBL5280C*</b>	-
Anchor lock, corrosion resistant yellow nylon.	.230"-.720" (5.8-18.3)	<b>HBL52CM80C*</b>	-
Finger grip, black neoprene, combination screws. CSA only.	.312"-.468" (7.9-11.9)	<b>HBL5921</b>	-
Fusible, black vinyl housing, slotted screws. CSA only.	.296"-.625" (7.5-15.9)	<b>HBL5299</b>	-

## IP20 and IP55

SUITABILITY

### Elastogrip®

Description	Cord Diameter	Catalog Number	
Yellow elastomer, dust tight.	.300"-.655" (7.6-16.6)	<b>HBL1447</b>	<b>HBL1433</b>
Yellow elastomer, watertight.	.300"-.655" (7.6-16.6)	<b>HBL14W47**</b>	<b>HBL14W33**</b>

## IP20

SUITABILITY

### Valise®

Description	Cord Diameter	Catalog Number	
Yellow nylon.	.220"-.660" (5.6-16.8)	<b>HBL5965VY</b>	<b>HBL5364VY</b>
Black nylon.	.220"-.660" (5.6-16.8)	<b>HBL5965VBLK</b>	<b>HBL5364VBLK</b>
Gray nylon.	.220"-.660" (5.6-16.8)	<b>HBL5965VGY</b>	-
Orange nylon, sold in bulk pack of 50.	.220"-.660" (5.6-16.8)	<b>HBL515PVO</b>	-
Insulation displacement terminals, black nylon.	.230"-.360" (5.8-9.1)	<b>HBL5966VBLK</b>	-
Insulation displacement terminals, yellow nylon.	.230"-.360" (5.8-9.1)	<b>HBL5966VY</b>	-

Note: \*UL Component Listed only. Not for general use applications.

\*\*Watertight plugs IP55 suitability when installed and used properly with mating Elastogrip watertight connector bodies.

Horsepower ratings listed are AC only.

See page A-47 for accessories.

Dimensions in Inches (mm)



**15A 125V**  
 NEMA 5-15R  
 UL CSA



**20A 125V**  
 NEMA 5-20R  
 UL CSA

**IP20**  
 SUITABILITY

**Connector Bodies**

**Insulgrip®**

Description	Cord Diameter	Catalog Number	
Black and white nylon.	.230"-.720" (5.8-18.3)	<b>HBL5269C</b>	<b>HBL5369C</b>
Blue and white nylon.	.230"-.720" (5.8-18.3)	<b>HBL5269CBL</b>	-
Black nylon extra large cord clamp.	.360"-.720" (9.1-18.3)	<b>HBL5269EBK</b>	<b>HBL5369EBK</b>
Corrosion resistant yellow nylon.	.230"-.720" (5.8-18.3)	<b>HBL52CM69C</b>	<b>HBL53CM69C</b>

Note: See page A-47 for accessories.



**HBL5269C**

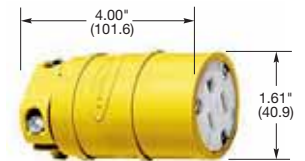

**HBL1547**

**IP20 and IP55**  
 SUITABILITY

**Elastogrip®**

Description	Cord Diameter	Catalog Number	
Yellow elastomer, dust tight.	.300"-.655" (7.6-16.6)	<b>HBL1547</b>	<b>HBL1533</b>
Yellow elastomer, watertight.	.300"-.655" (7.6-16.6)	<b>HBL15W47*</b>	<b>HBL15W33*</b>

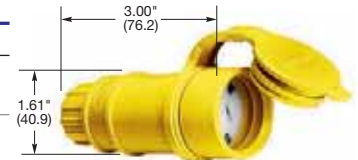

**HBL15W47**

**IP20**  
 SUITABILITY

**Valise®**

Description	Cord Diameter	Catalog Number	
Yellow nylon.	.220"-.660" (5.6-16.8)	<b>HBL5969VY</b>	<b>HBL5369VY</b>
Black nylon.	.220"-.660" (5.6-16.8)	<b>HBL5969VBLK</b>	<b>HBL5369VBK</b>
Gray nylon.	.220"-.660" (5.6-16.8)	<b>HBL5969VGY</b>	-
Orange nylon, sold in bulk pack of 50.	.220"-.660" (5.6-16.8)	<b>HBL515CVO</b>	-
Insulation displacement terminals, black nylon.	.230"-.360" (5.8-9.1)	<b>HBL5963VBK</b>	-
Insulation displacement terminals, yellow nylon.	.230"-.360" (5.8-9.1)	<b>HBL5963VY</b>	-

Note: \*Watertight connectors IP55 suitability when closure plug inserted or when installed and used properly with mating Elastogrip watertight plug. Connector bodies are not HP rated. See page A-47 for accessories.



**HBL5969VY**



**HBL5963VY**

For quick visual identification of circuits or configurations.

**Colored Cord Clamps\***

Description	Color	Catalog Number
For use with 15A and 20A, 2 pole/3 wire, insulgrip plugs and connectors with cord diameter range of .230"-.720" (5.8-18.3) only.	Blue	<b>HBLCORDCLAMPBL</b>
	Green	<b>HBLCORDCLAMPGN</b>
	Orange	<b>HBLCORDCLAMPOR</b>
	Purple	<b>HBLCORDCLAMPP</b>
	Red	<b>HBLCORDCLAMP R</b>
	Yellow	<b>HBLCORDCLAMPY</b>

Note: \*Clamp only. Contains no screws. Order in increments of 10. Not UL Listed or CSA Certified.



Dimensions in Inches (mm)



## Flanged Inlets

Description	Catalog Number	
Nylon casing, back wired.	<b>HBL5278C</b>	<b>HBL5378C</b>
Weatherproof, gray, with lift cover and multiple drive screws.	<b>HBL61CM64</b>	-
Weatherproof, black, with lift cover and boot, multiple drive screws.	<b>HBL61CM64BK</b>	-
Stainless steel flange, phenolic body, miniature style, for molded on connectors only, multiple drive screws.	<b>HBL5240*</b>	-

*Note: \*Specially designed to accept "molded-on" connector bodies. Catalog number HBL5240 will not accept re-wireable size connector bodies listed in this catalog or molded connectors having a "rejection obstruction" as required by Underwriters Laboratories Inc. standard #817 cord sets and power supply cords" effective 7/1/81. See pages A-46 and A-47 for accessories.*

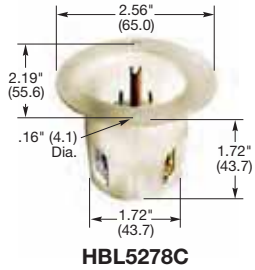

**HBL5278C**

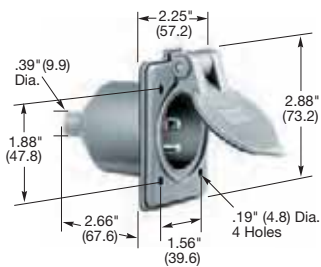

**HBL61CM64**

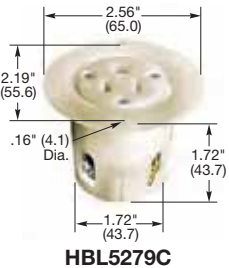

**HBL5279C**

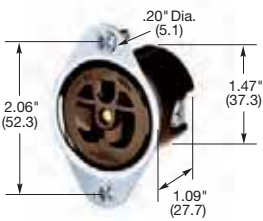

**HBL5256**

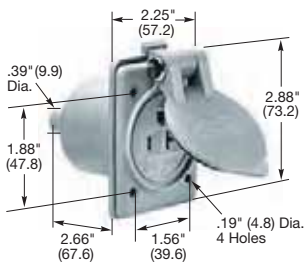

**HBL61CM65**

*Dimensions in Inches (mm)*



## Flanged Receptacles

Description	Catalog Number	
Nylon casing, back wired.	<b>HBL5279C</b>	<b>HBL5379C</b>
Stainless steel flange, phenolic body, covered terminals, multiple drive screws.	<b>HBL5279</b>	-
Stainless steel flange, brown phenolic (mounting screws packed separately).	<b>HBL5256</b>	-
Weatherproof, gray nylon, with lift cover and boot, multiple drive screws.	-	<b>HBL61CM65**</b>

*Note: \*\*Not CSA Certified. See pages A-46 and A-47 for accessories.*



**15A 250V**  
**NEMA 6-15R**  
 UL CSA  
 1.5 HP



**20A 250V**  
**NEMA 6-20R**  
 UL CSA  
 2 HP

## Receptacles

### HBL® Extra Heavy Duty, Specification Grade, Duplex

Description	Color	Catalog Number	
Flush, nylon face, back and side wired, multiple drive screws.	Black	-	HBL5462BK
	Brown	HBL5662	HBL5462
	Gray	-	HBL5462GY
	Ivory	HBL5662I	HBL5462I
	Red	-	HBL5462R
Isolated ground <sup>A</sup> .	Orange	IG5662	IG5462

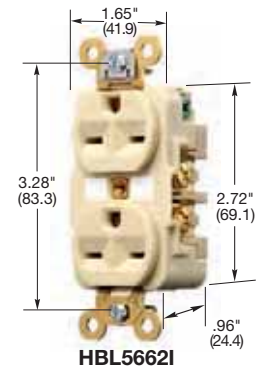

### HBL® Extra Heavy Duty, Specification Grade, Single

Description	Color	Catalog Number	
Flush, nylon face, back and side wired.	Brown	HBL5661	HBL5461
	Gray	-	HBL5461GY
	Ivory	HBL5661I	HBL5461I
	Red	-	HBL5461R
	White	-	HBL5461W
Isolated ground <sup>A</sup> .	Orange	IG5661	IG5461
Panel mount 1.94 in. (49.3) centers.	Brown	HBL5684	-
Ring terminal connection.	Brown	HBL5661RT	-

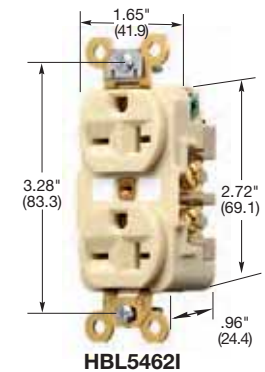

### HBL® Extra Heavy Duty, Specification Grade Duplex and Single Panel Mount

Description	Color	Catalog Number	
Flush, nylon duplex face, side wired only.	Brown	HBL5652	-
	Ivory	HBL5652I	-
Panel mount 1.75 in. (44.5) centers.	Brown	HBL5658	-

*Note: <sup>A</sup>See section M for additional information on isolated ground devices.  
 HP ratings are AC only.  
 See page A-46 for accessories.*

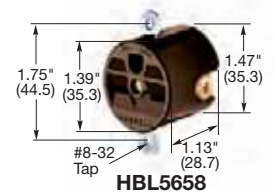
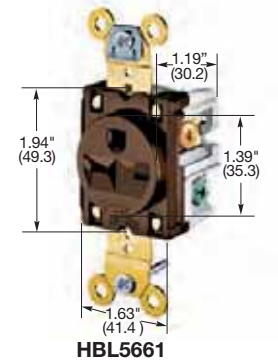

*Dimensions in Inches (mm)*

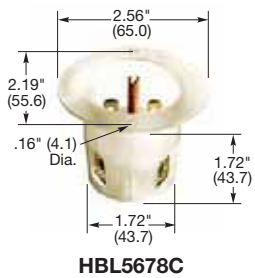

Dimensions in Inches (mm)

## Plugs

Description	Cord Diameter	Catalog Number	
Insulgrip® Plug, black and white nylon.	.230"-.720" (5.8-18.3)	<b>HBL5666C</b>	<b>HBL5466C</b>
Insulgrip® Plug, corrosion resistant, yellow nylon.	.230"-.720" (5.8-18.3)	<b>HBL56CM66C</b>	<b>HBL54CM66C</b>
8-Position Insulgrip® Angle Plug, black and white nylon.	.325"-.655" (8.3-16.6)	<b>HBL5666CA</b>	<b>HBL5466CA</b>
Valise® Plug, yellow nylon.	.220"-.660" (5.6-16.8)	<b>HBL5666VY</b>	<b>HBL5464VY</b>

Note: See page A-47 for accessories.



## Insulgrip® Flanged Inlets

Description	Catalog Number	
Nylon casing, back wired.	<b>HBL5678C</b>	<b>HBL5478C</b>

Note: Flanged inlets are not HP rated.  
 See page A-47 for accessories.



For quick visual identification of circuits or configurations.

## Colored Cord Clamps\*

Description	Color	Catalog Number
For use with 15A and 20A, 2 pole/3 wire, insulgrip plugs and connectors with cord diameter range of .230"-.720" (5.8-18.3) only.	Blue	<b>HBLCORDCLAMPBL</b>
	Green	<b>HBLCORDCLAMPGN</b>
	Orange	<b>HBLCORDCLAMPOR</b>
	Purple	<b>HBLCORDCLAMPP</b>
	Red	<b>HBLCORDCLAMPR</b>
	Yellow	<b>HBLCORDCLAMPY</b>

Note: \*Clamp only. Contains no screws. Order in increments of 10. Not UL Listed or CSA Certified.





**15A 250V**  
 NEMA 6-15R  
 UL CSA



**20A 250V**  
 NEMA 6-20R  
 UL Listed

## Connector Bodies

Description	Cord Diameter	Catalog Number	
Insulgrip® Connector Body, black and white nylon, multiple drive screws.	.230"-.720" (5.8-18.3)	<b>HBL5669C</b>	<b>HBL5469C</b>
Valise® Connector Body, yellow nylon.	.220"-.660" (5.6-16.8)	<b>HBL5669VY</b>	<b>HBL5469VY</b>

Note: See page A-47 for accessories.

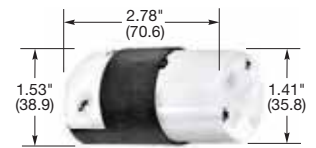

**HBL5669C**

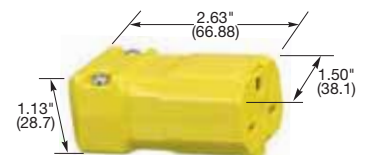

**HBL5669VY**

## Flanged Receptacles

Description	Catalog Number	
Nylon casing, multiple drive screws.	<b>HBL5679C</b>	<b>HBL5479C</b>
Stainless steel flange, brown phenolic housing (mounting screws packaged separately).	<b>HBL5656</b>	-

Note: Connector bodies are not HP rated.  
 See pages A-46 and A-47 for accessories.



**15A 250V**  
 NEMA 6-15R  
 UL CSA



**20A 250V**  
 NEMA 6-20R  
 UL Listed

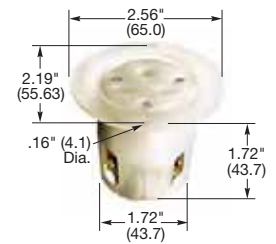

**HBL5679C**

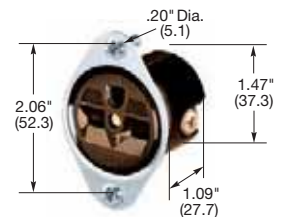

**HBL5656**

For quick visual identification of circuits or configurations.

## Colored Cord Clamps\*

Description	Color	Catalog Number
For use with 15A and 20A, 2 pole/3 wire, insulgrrip plugs and connectors with cord diameter range of .230"-.720" (5.8-18.3) only.	Blue	<b>HBLCORDCLAMPBL</b>
	Green	<b>HBLCORDCLAMPGN</b>
	Orange	<b>HBLCORDCLAMPOR</b>
	Purple	<b>HBLCORDCLAMPP</b>
	Red	<b>HBLCORDCLAMPR</b>
	Yellow	<b>HBLCORDCLAMPY</b>

Note: \*Clamp only. Contains no screws. Order in increments of 10. Not UL Listed or CSA Certified.



Dimensions in Inches (mm)

# Straight Blade Devices

## 15 and 20 Ampere, 125, 250 Volts and 277 Volts AC

2 Pole, 2 Wire Non-Grounding and 2 Pole, 3 Wire Grounding



### 15A, 125V, 2 Pole, 2 Wire Non-Grounding, Valise® Plugs

**IP20**  
SUITABILITY



**15A 125V**  
NEMA 1-15R  
UL CSA  
0.5 HP



**15A 125V**  
NEMA 1-15P  
UL CSA  
0.5 HP

Description	Cord Diameter	Catalog Number	
Yellow nylon, non-polarized.	.218"-.385" (5.5-9.8)	-	HBL5865VY
Yellow nylon, polarized.	.218"-.385" (5.5-9.8)	-	HBL5866VY
Black nylon, polarized.	Type 17/2 "SVT" cord	-	HBL5867VBK

### Valise® Connector Bodies

Description	Cord Diameter	Catalog Number	
Yellow nylon.	.218"-.385" (5.5-9.8)	HBL5869VY	-



HBL5865VY

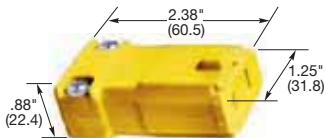

HBL5869VY

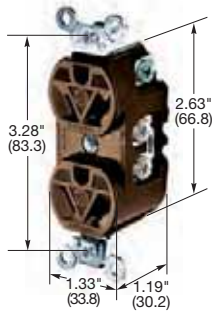

HBL5302

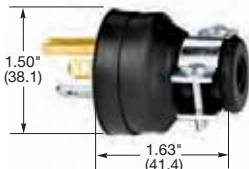

HBL5929



HBL9758VY

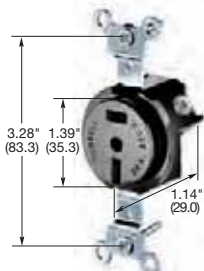

HBL5552B

Dimensions in Inches (mm)



### 15A, 277V AC, 2 Pole, 3 Wire Grounding, Plugs



**15A 277V AC**  
NEMA 7-15R  
UL CSA  
2 HP



**15A 277V AC**  
NEMA 7-15P  
2 HP

Description	Cord Diameter	Catalog Number	
Finger grip, black elastomer.	.312"-.468" (7.9-11.9)	-	HBL5929*

### Receptacles and Connector Bodies

Description	Cord Diameter	Catalog Number	
Receptacle, flush duplex, brown, back and side wired.	-	HBL5302	-
Connector Body, phenolic and steel body.	.296"-.625" (7.5-15.9)	HBL5324	-

Note: \*Not UL Listed.  
Horsepower ratings are AC only.  
See pages A-46 and A-47 for accessories.



### 20A, 250V, 2 Pole, 2 Wire Non-Grounding, Valise® Plugs

**IP20**  
SUITABILITY



**20A 250V**  
NEMA 2-20R  
UL Listed  
2 HP



**20A 250V**  
NEMA 2-20P  
UL Listed  
2 HP

Description	Cord Diameter	Catalog Number	
Yellow nylon.	.220"-.660" (5.6-16.8)	-	HBL9758VY

### Receptacle, Single

Description	Catalog Number	
Black phenolic.	HBL5552B	-

Note: Horsepower ratings are AC only and apply to plugs and receptacles only.  
See pages A-46 and A-47 for accessories.

# Straight Blade Devices

## 20 Ampere, 125/250 Volts, 3Ø 250 Volts AC and 3ØY 120/208V AC

3 Pole, 3 Wire Non-Grounding; 3 Pole, 4 Wire Grounding; 4 Pole 4 Wire Non-Grounding



### 20A, 125/250V, 3 Pole, 3 Wire Non-Grounding, Receptacles and Plugs

**IP20**  
SUITABILITY



**20A 125V/250V**  
NEMA 10-20R  
UL Listed  
2(1) HP



**20A 125V/250V**  
NEMA 10-20P  
UL Listed  
2(1) HP

Description	Cord Diameter	Catalog Number
Receptacle, black phenolic.	-	<b>HBL6810</b>
Plug, Insulgrip®, nylon.	.385"-.780" (9.8-19.8)	<b>HBL9977C</b>

Note: Horsepower ratings listed above are AC only.  
Horsepower ratings not in parentheses are phase to phase (208 to 240V AC).  
Those in parentheses are phase to neutral (120V AC).  
See pages A-46 and A-47 for accessories.

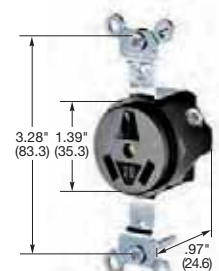

**HBL6810**



### 20A, 125/250V, 3 Pole, 4 Wire Grounding, Receptacles and Plugs

**IP20**  
SUITABILITY



**20A 125V/250V**  
NEMA 14-20R  
UL CSA  
2(1) HP



**20A 125V/250V**  
NEMA 14-20P  
UL CSA  
2(1) HP

Description	Cord Diameter	Catalog Number
Receptacle, black nylon body, back and side wired.	-	<b>HBL8410</b>
Plug, nylon, angle 4-position.	.390"-.775" (9.9-19.7)	<b>HBL8411C</b>

Note: See pages A-46 and A-47 for accessories.



**HBL9977C**

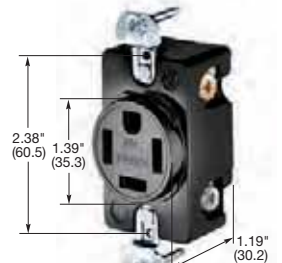

**HBL8410**



### 20A, 3Ø 250V AC, 3 Pole, 4 Wire Grounding, Receptacles and Plugs

**IP20**  
SUITABILITY



**20A 3Ø 250V AC**  
NEMA 15-20R  
UL CSA  
3 HP



**20A 3Ø 250V AC**  
NEMA 15-20P  
UL CSA  
3 HP

Description	Cord Diameter	Catalog Number
Receptacle, black nylon body, back and side wired.	-	<b>HBL8420</b>
Plug, nylon, angle 4-position.	.390"-.775" (9.9-19.7)	<b>HBL8421C</b>

Note: Horsepower ratings listed above are AC only.  
Horsepower ratings not in parentheses are phase to phase (208 to 240V AC).  
Horsepower ratings in parentheses are phase to neutral (120V AC).  
See pages A-46 and A-47 for accessories.



**HBL8411C**

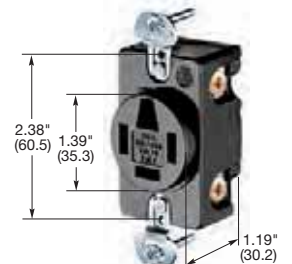

**HBL7250**



### 20A, 3ØY 120/208V AC, 4 Pole, 4 Wire Non-Grounding, Receptacles and Plugs

**IP20**  
SUITABILITY



**20A 3ØY 120/208V AC**  
NEMA 18-20R  
UL Listed  
2 HP



**20A 3ØY 120/208V AC**  
NEMA 18-20P  
UL Listed  
2 HP

Description	Cord Diameter	Catalog Number
Receptacle, black nylon body.	-	<b>HBL7250</b>
Plug, nylon, angle, 4-position.	.390"-.775" (9.9-19.7)	<b>HBL7251C</b>

Note: Horsepower ratings are phase to phase (208 to 240V AC).  
Weatherproof boots for plugs not available.  
See pages A-46 and A-47 for accessories.



**HBL7251C**

Dimensions in Inches (mm)

Straight Blade Devices  
**16 Ampere, 250 Volts AC International**  
*2 Pole, 3 Wire Grounding*

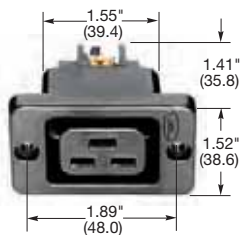

**H320R**



**Receptacle IEC 320 Compatible**

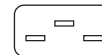

Description	Catalog Number
20/16A 250V AC IEC straight blade. For Ring Terminal connection.	<b>H320R</b> <b>H320RRT*</b>

Note: \*Not UL Listed.

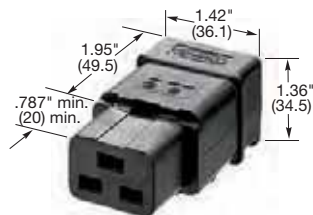

**H320C**



**IP20**  
SUITABILITY

**Connector**

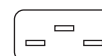

Description	Catalog Number
20/16A 250V AC IEC straight blade.	<b>H320C</b>



**H320P**



**IP20**  
SUITABILITY

**Plug IEC 320 Compatible**



Description	Catalog Number
20/16A 250V AC IEC straight blade.	<b>H320P</b>

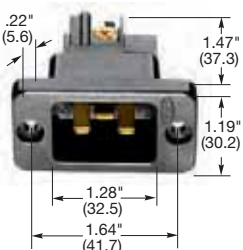

**H320B**



**Inlets**



Description	Catalog Number
20/16A 250V AC IEC straight blade.	<b>H320B</b>
20/16A 250V AC IEC straight blade with retention clamp.	<b>H320BL</b>

Note: See page A-63 for technical information.

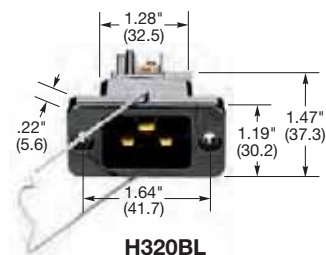

**H320BL**

Dimensions in Inches (mm)

# Straight Blade Devices

## 15 and 20 Ampere, 125 Volts

2 Pole, 3 Wire Grounding



### Acceptor® Hazardous Location Receptacles



**20A 125V**  
**NEMA 5-20R**  
UL CSA  
1 HP

Description	Catalog Number
Explosion and dust ignition proof.	<b>UGRO20231</b>
Class I, Div. 1 & 2, Groups C, D	<b>UGRA20231*</b>
Class II, Div. 1 & 2, Groups F, G	
Class III	
NEMA® 3, 7 B C D, 9 F G	

Note: \*UGRA version includes an adapter plate for mounting to Crouse-Hinds® EDS series and Appleton® EFD series back boxes.  
UL Listed for Class 1, Div. 2, Groups B, C, D.



**UGRO20231**



### Acceptor® Hazardous Location Plugs



**15A 125V**  
**NEMA 5-15P**  
UL CSA



**20A 125V**  
**NEMA 5-20P**  
UL CSA

Description	Catalog Number	Catalog Number
Explosion and dust ignition proof.	<b>UGP15231</b>	<b>UGP20231</b>
Class I, Div. 1 & 2, Groups B, C, D		
Class II, Div. 1 & 2, Groups E, F, G		
Class III		
NEMA® 3, 7 B C D, 9 F G		

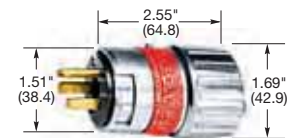

**UGP15231**

### SWB Series Boxes

Hub Size	1-Gang Dead End	1-Gang Feed Thru
½ in. NPT	<b>SWB1</b>	<b>SWB4</b>
¾ in. NPT	<b>SWB2</b>	<b>SWB5</b>
Class I, Div. 1 & 2, Groups C, D		
Class II, Div. 1 & 2, Groups E, F, G		
Class III		
NEMA® 7 C D, 9 E F G		

Note: SWB series boxes will only accommodate Acceptor Series receptacles, not standard weatherproof covers.

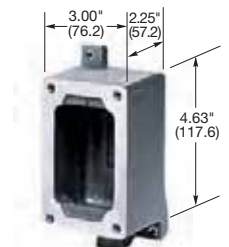

**SWB1**



**SWB5**

NEMA® is a registered trademark of the National Electrical Manufacturers Association.

Dimensions in Inches (mm)

# Straight Blade Devices

## Heavy Duty Insulgrip® Plugs and Receptacles

30, 50, 60 Amp

Heavy duty cable grips handle a wide range of cable sizes to prevent conductor movement that can cause strain on the terminals

Neoprene dust shields fit a variety of cable diameters to provide a reliable seal to keep dust out

Reinforced thermoplastic polyester provides high impact and heat resistance

Supertough nylon housing provides high impact resistance

Gripping ribs provide secure gripping area

**HBL9431C**

Captive Allen head terminal screws are user-ready

Catalog number, NEMA number, ratings and certifications molded in face

One piece design power and ground contacts provide low operating temperatures

Plated steel mounting plate provides corrosion resistance; Unit mounts in a 2-gang box

Four-wire receptacles: Floating "V" bottom contact lugs bundle strands to provide high contact pressure and low operating temperatures

Sequenced contacts assure protection for people and equipment

**HBL9430A**

Catalog number, NEMA number, ratings and certifications molded in face

Captive Allen head terminal screws permit high torque and clamping pressure required for larger size conductors; User-ready

# Straight Blade Devices

## 30 Ampere, 125, 250 Volts, 277 Volts AC and 125/250 Volts

2 Pole, 3 Wire Grounding and 3 Pole, 3 Wire Non-Grounding



### 30A, 125V, 2 Pole, 3 Wire Grounding, Receptacles and Plugs

**IP20**  
SUITABILITY



**30A 125V**  
NEMA 5-30R  
UL CSA  
2 HP



**30A 125V**  
NEMA 5-30P  
UL CSA  
2 HP

Description	Cord Diameter	Catalog Number
Receptacle, black RTP.	-	<b>HBL9308</b>
Receptacle, orange, isolated ground <sup>A</sup> .	-	<b>IG9308</b>
Plug, nylon, angle, 4-position.	.625"-1.187" (15.9-30.1)	<b>HBL9309*</b>

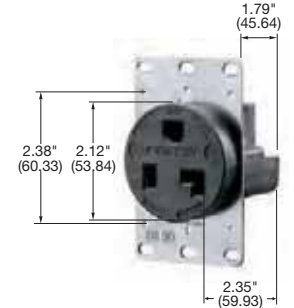

**HBL9308**

### 30A, 250V, 2 Pole, 3 Wire Grounding, Receptacles and Plugs

**IP20**  
SUITABILITY



**30A 250V**  
NEMA 6-30R  
UL CSA  
2 HP



**30A 250V**  
NEMA 6-30P  
UL CSA  
2 HP

Description	Cord Diameter	Catalog Number
Receptacle, black RTP.	-	<b>HBL9330</b>
Receptacle, orange, isolated ground <sup>A</sup> .	-	<b>IG9330</b>
Plug, nylon, angle, 4-position	.625"-1.187" (15.9-30.1)	<b>HBL9331*</b>

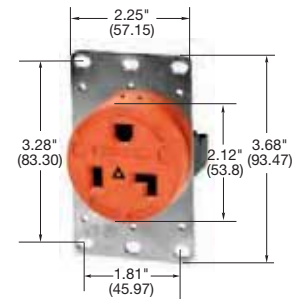

**IG9308**

### 30A, 277V AC, 2 Pole, 3 Wire Grounding, Receptacles and Plugs

**IP20**  
SUITABILITY



**30A 277V AC**  
NEMA 7-30R  
UL CSA  
3 HP



**30A 277V AC**  
NEMA 7-30P  
UL CSA  
3 HP

Description	Cord Diameter	Catalog Number
Receptacle, black RTP.	-	<b>HBL9315</b>
Plug, nylon, angle, 4-position.	.625"-1.187" (15.9-30.1)	<b>HBL9319*</b>

### 30A, 125/250V, 3 Pole, 3 Wire Non-Grounding, Receptacles and Plugs



**IP20**  
SUITABILITY



**30A 125/250V**  
NEMA 10-30R  
UL Listed  
2(2) HP



**30A 125/250V**  
NEMA 10-30P  
UL Listed  
2(2) HP

Description	Cord Diameter	Catalog Number
Receptacle, black phenolic.	-	<b>HBL9350</b>
Receptacle, surface mount aluminum housing.	-	<b>HBL9395</b>
Plug, Insulgrip®, nylon.	.625"-1.00" (15.9-25.4)	<b>HBL9337C</b>
Plug, nylon, angle, 4-position.	.625"-1.187" (15.9-30.1)	<b>HBL9333</b>



**HBL9331**

Note: RTP is an abbreviation for reinforced thermoplastic polyester.  
<sup>A</sup>See section M for additional information on isolated ground devices.  
<sup>\*</sup>Not Fed. Spec. Listed.  
 See page A-48 for accessories.

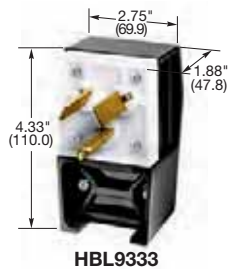

**HBL9333**



**HBL9350**

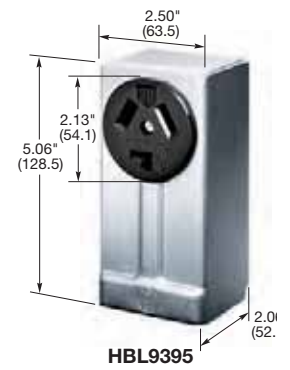

**HBL9395**

Dimensions in Inches (mm)

**Straight Blade Devices**  
**30 Ampere, 125/250 Volts, 3Ø 250 and 3ØY 120/208 Volts AC**  
*3 Pole, 4 Wire Grounding and 4 Pole, 4 Wire Non-Grounding*

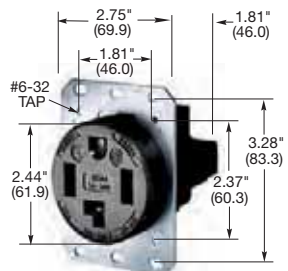

**HBL9430A**

**30A, 125/250V,  
 3 Pole, 4 Wire Grounding,  
 Receptacles and Plugs**

**IP20**  
 SUITABILITY

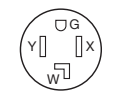

**30A 125/250V  
 NEMA 14-30R  
 2(2) HP**



**30A 125/250V  
 NEMA 14-30P  
 2(2) HP**

Description	Cord Diameter	Catalog Number
Receptacle, black RTP.	-	<b>HBL9430A</b>
Plug, nylon.	.625"-1.310" (15.9-33.3)	- <b>HBL9431C</b>
Plug, nylon, angle, 4-position.	.625"-1.310" (15.9-33.3)	- <b>HBL9432C</b>



**HBL9431C**

**30A, 3Ø 250V AC,  
 3 Pole, 4 Wire Grounding,  
 Receptacles and Plugs**

**IP20**  
 SUITABILITY



**30A 3Ø 250V AC  
 NEMA 15-30R  
 3 HP**

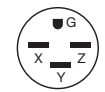

**30A 3Ø 250V AC  
 NEMA 15-30P  
 3 HP**

Description	Cord Diameter	Catalog Number
Receptacle, black RTP.	-	<b>HBL8430A</b>
Plug, nylon.	.625"-1.310" (15.9-33.3)	- <b>HBL8431C</b>
Plug, nylon, angle, 4-position	.625"-1.310" (15.9-33.3)	- <b>HBL8432C</b>



**HBL9432C**

**30A, 3ØY 120/208V AC,  
 4 Pole, 4 Wire Non-Grounding,  
 Receptacles and Plugs**

**IP20**  
 SUITABILITY

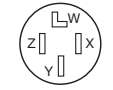

**30A 3ØY  
 120/208V AC  
 NEMA 18-30R  
 UL Listed  
 3 HP**

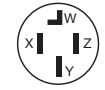

**30A 3ØY  
 120/208V AC  
 NEMA 18-30P  
 UL Listed  
 3 HP**

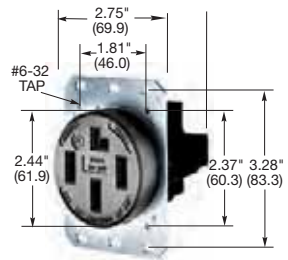

**HBL8330A**

Description	Cord Diameter	Catalog Number
Receptacle, black RTP.	-	<b>HBL8330A</b>
Plug, nylon.	.625"-1.310" (15.9-33.3)	- <b>HBL8331C</b>

*Note: RTP is an abbreviation for reinforced thermoplastic polyester.  
 See page A-64 for technical information.  
 See page A-49 for accessories.*



**HBL8331C**

*Dimensions in Inches (mm)*



Straight Blade Devices  
**50 Ampere, 125, 250 Volts, 277 Volts AC and 125/250 Volts**  
 2 Pole, 3 Wire Grounding and 3 Pole, 3 Wire Non-Grounding



**50A, 125V,  
 2 Pole, 3 Wire Grounding,  
 Receptacles and Plugs**

**IP20**  
 SUITABILITY



**50A 125V  
 NEMA 5-50R  
 UL CSA  
 2 HP**



**50A 125V  
 NEMA 5-50P  
 UL CSA  
 2 HP**

Description	Cord Diameter	Catalog Number
Receptacle, black RTP.	-	<b>HBL9360</b>
Plug, nylon, angle, 4-position.	.625"-1.187" (15.9-30.2)	- <b>HBL9361</b>



**HBL9361**

**50A, 250V,  
 2 Pole, 3 Wire Grounding,  
 Receptacles and Plugs**

**IP20**  
 SUITABILITY



**50A 250V  
 NEMA 6-50R  
 UL CSA  
 3 HP**



**50A 250V  
 NEMA 6-50P  
 UL CSA  
 3 HP**

Description	Cord Diameter	Catalog Number
Receptacle, black RTP.	-	<b>HBL9367</b>
Plug, nylon, angle, 4-position.	.625"-1.187" (15.9-30.2)	- <b>HBL9368</b>

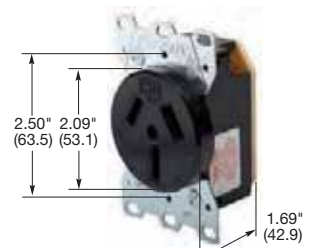

**HBL7962**

**50A, 277V AC,  
 2 Pole, 3 Wire Grounding,  
 Receptacles and Plugs**

**IP20**  
 SUITABILITY



**50A 277V AC  
 NEMA 7-50R  
 UL CSA  
 5 HP**



**50A 277V AC  
 NEMA 7-50P  
 UL CSA  
 5 HP**

Description	Cord Diameter	Catalog Number
Receptacle, black RTP.	-	<b>HBL9365</b>
Plug, nylon, angle, 4-position.	.625"-1.187" (15.9-30.2)	- <b>HBL9379</b>

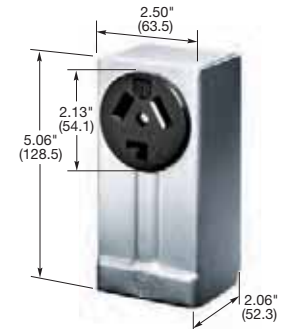

Representative of surface mount receptacle

 **50A, 125/250V,  
 3 Pole, 3 Wire Non-Grounding,  
 Receptacles, Connector Body and Plugs**

**IP20**  
 SUITABILITY



**50A 125/250V  
 NEMA 10-50R  
 UL Listed  
 3(2) HP**



**50A 125/250V  
 NEMA 10-50P  
 UL Listed  
 3(2) HP**

Description	Cord Diameter	Catalog Number
Receptacle, black phenolic.	-	<b>HBL7962</b>
Receptacle, surface mount aluminum housing.	-	<b>HBL7940</b>
Connector body, Insulgrip, nylon.	.625"-1.218" (15.9-30.9)	<b>HBL7515C</b>
Plug, Insulgrip, nylon.	.625"-1.218" (15.9-30.9)	- <b>HBL7513C</b>
Plug, nylon, angle, 4-position.	.625"-1.187" (15.9-30.2)	- <b>HBL7977</b>

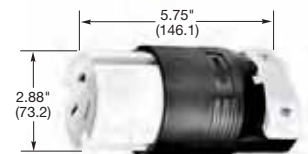

**HBL7515C**

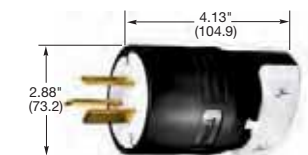

**HBL7513C**

Note: RTP is an abbreviation for reinforced thermoplastic polyester.  
 See page A-48 for accessories.

Dimensions in Inches (mm)

# Straight Blade Devices

## 50 Ampere, 125/250 Volts, 3Ø 250 and 120/208 Volts AC

3 Pole, 4 Wire Grounding and 4 Pole, 4 Wire Non-Grounding

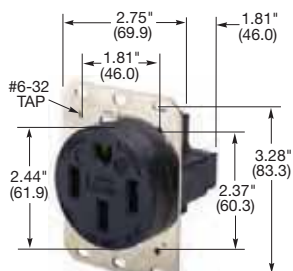

**HBL9450A**

### 50A, 125/250V, 3 Pole, 4 Wire Grounding, Receptacles and Plugs

**IP20**  
SUITABILITY



**50A 125/250V  
NEMA 14-50R  
UL CSA  
3(2) HP**



**50A 125/250V  
NEMA 14-50P  
UL CSA  
3(2) HP**

Description	Cord Diameter	Catalog Number
Receptacle, black RTP.	-	<b>HBL9450A</b>
Plug, nylon.	.625"-1.310" (15.9-33.3)	- <b>HBL9451C</b>
Plug, nylon, angle, 4-position.	.625"-1.310" (15.9-33.3)	- <b>HBL9452C</b>



**HBL9451C**

### 50A, 3Ø 250V AC, 3 Pole, 4 Wire Grounding, Receptacles and Plugs

**IP20**  
SUITABILITY



**50A 3Ø 250V AC  
NEMA 15-50R  
UL CSA  
7.5 HP**



**50A 3Ø 250V AC  
NEMA 15-50P  
UL CSA  
7.5 HP**

Description	Cord Diameter	Catalog Number
Receptacle, black RTP.	-	<b>HBL8450A</b>
Plug, nylon.	.625"-1.310" (15.9-33.3)	- <b>HBL8451C</b>
Plug, nylon, angle, 4-position.	.625"-1.310" (15.9-33.3)	- <b>HBL8452C</b>



**HBL9452C**



### 50A, 3ØY 120/208V AC, 4 Pole, 4 Wire Non-Grounding, Receptacles and Plugs

**IP20**  
SUITABILITY



**50A 3ØY  
120/208V AC  
NEMA 18-50R  
UL Listed  
7.5 HP**



**50A 3ØY  
120/208V AC  
NEMA 18-50P  
UL Listed  
7.5 HP**

Description	Cord Diameter	Catalog Number
Receptacle, black RTP.	-	<b>HBL8350A</b>
Plug, nylon, angle, 4-position.	.625"-1.310" (15.9-33.3)	- <b>HBL8352C</b>

*Note: RTP is an abbreviation for reinforced thermoplastic polyester.  
See page A-49 for accessories.*

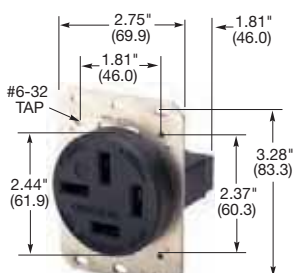

**HBL8350A**

Dimensions in Inches (mm)

Straight Blade Devices  
**60 Ampere, 125/250 Volts, 3Ø 250 and 120/208 Volts AC**  
 3 Pole, 4 Wire Grounding and 4 Pole, 4 Wire Non-Grounding



**60A, 125/250V,  
 3 Pole, 4 Wire Grounding,  
 Receptacles and Plugs**

**IP20**  
 SUITABILITY



**60A 125/250V  
 NEMA 14-60R  
 UL CSA  
 3(2) HP**



**60A 125/250V  
 NEMA 14-60P  
 UL CSA  
 3(2) HP**

Description	Cord Diameter	Catalog Number
Receptacle, black RTP.	-	<b>HBL9460A</b>
Plug, nylon.	.625"-1.310" (15.9-33.3)	- <b>HBL9461C</b>
Plug, nylon, angle, 4-position.	.625"-1.310" (15.9-33.3)	- <b>HBL9462C</b>

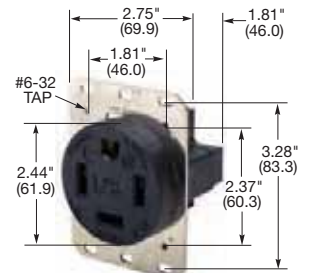

**HBL9460A**

**60A, 3Ø 250V AC,  
 3 Pole, 4 Wire Grounding,  
 Receptacles and Plugs**

**IP20**  
 SUITABILITY



**60A 3Ø 250V AC  
 NEMA 15-60R  
 UL CSA  
 10 HP**



**60A 3Ø 250V AC  
 NEMA 15-60P  
 UL CSA  
 10 HP**

Description	Cord Diameter	Catalog Number
Receptacle, black RTP.	-	<b>HBL8460A</b>
Plug, nylon.	.625"-1.310" (15.9-33.3)	- <b>HBL8461C</b>
Plug, nylon, angle, 4-position.	.625"-1.310" (15.9-33.3)	- <b>HBL8462C</b>



**HBL8461C**



**HBL8462C**

**60A, 3ØY 120/208V AC,  
 4 Pole, 4 Wire Non-Grounding,  
 Receptacles and Plugs**

**IP20**  
 SUITABILITY



**60A 3ØY  
 120/208V AC  
 NEMA 18-60R  
 UL Listed  
 7.5 HP**



**60A 3ØY  
 120/208V AC  
 NEMA 18-60P  
 UL Listed  
 7.5 HP**

Description	Cord Diameter	Catalog Number
Receptacle, black RTP.	-	<b>HBL7301A</b>
Plug, nylon.	.625"-1.310" (15.9-33.3)	- <b>HBL7303C</b>
Plug, nylon, angle, 4-position.	.625"-1.310" (15.9-33.3)	- <b>HBL7302C</b>

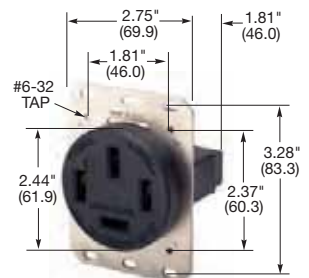

**HBL7301A**

Note: RTP is an abbreviation for reinforced thermoplastic polyester.  
 See page A-49 for accessories.

Dimensions in Inches (mm)

# Straight Blade Devices DIN Rail Utility Box Complete Units and Component Parts



Hubbell's DIN Rail Utility Box offers a labor saving way to provide utility power to any control cabinet. Installing the DIN Rail Utility Box is as easy as snapping the box onto a 35mm DIN Rail and connecting the line, neutral and ground wires to the terminal block. Utility power for fans, lights, laptop computers, testers or any other power requirement. If load limiting is a concern, Hubbell's "CB" version comes with a 5 Amp circuit breaker that provides over-current protection to make sure that large loads are not drawn from the DIN Rail Utility Box. All Hubbell DIN Rail Utility Boxes may be mounted either vertically or horizontally on the DIN Rail; the "H" version comes with the terminal block mounted for easy wiring when the DIN Rail Utility Box is mounted horizontally.

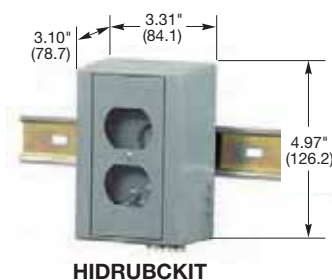
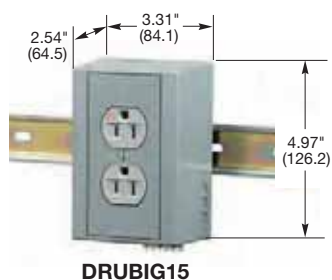
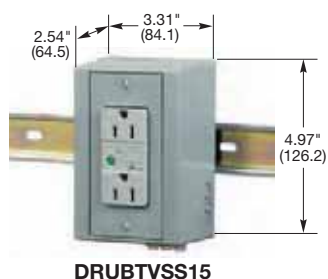
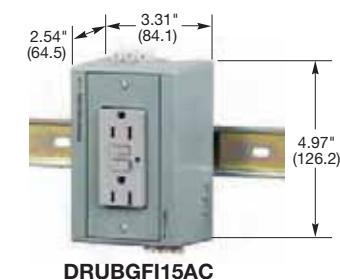
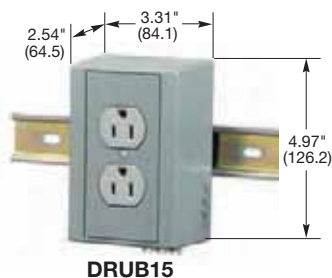

Dimensions in Inches (mm)



## Duplex Receptacles

Description	Color	Catalog Number
Complete unit.	Gray	<b>DRUB15</b> <b>DRUB20</b>
Complete unit, horizontal mount.	Gray	<b>DRUB15H</b> -
Complete unit with 5A circuit breaker.	Gray	<b>DRUB15CB5</b> -
Complete unit with 5A circuit breaker, horizontal.	Gray	<b>DRUB15HCB5</b> -
Complete unit with aux.	Gray	- <b>DRUB20AC</b>
Complete unit with aux and 5A circuit breaker.	Gray	- <b>DRUB20ACCB5</b>
Complete unit with NEMA® 6-20R duplex (250V).	Gray	- <b>DRUB5462*</b>

## GFCI Duplex Receptacles

Description	Color	Catalog Number
Complete unit.	Gray	<b>DRUBGF115</b> <b>DRUBGF120</b>
Complete unit, horizontal.	Gray	<b>DRUBGF115H</b> -
Complete unit with 5A circuit breaker.	Gray	<b>DRUBGF115CB5</b> -
Complete unit with 5A circuit breaker, horizontal.	Gray	<b>DRUBGF115HCB5</b> -
Complete unit with aux GFCI contacts.	Gray	<b>DRUBGF115AC</b> <b>DRUBGF120AC</b>
Complete unit, faceless with aux GFCI contacts.	Gray	- <b>DRUBGF120BFAC</b>

## TVSS Duplex Receptacles

Description	Color	Catalog Number
Complete unit.	Gray	<b>DRUBTVSS15</b> -

## Isolated Ground<sup>A</sup> Duplex Receptacles

Description	Color	Catalog Number
Complete unit.	Gray	<b>DRUBIG15</b> -

## Toggle Switch Unit

Description	Color	Catalog Number
Complete unit with HBL1221.	Gray	<b>DRUB1221AC</b>
Complete unit with 15A 125V SW/REC.	Gray	<b>DRUB6404</b>

## DIN Rail Utility Box Components

Description	Color	Catalog Number
Pre-wired kit without circuit breaker.	Gray	<b>DRUBKIT</b>
Pre-wired kit with circuit breaker.	Gray	<b>DRUBKITCB5</b>
Pre-wired kit with aux.	Gray	<b>DRUBKITAC</b>
Pre-wired kit with circuit breaker and aux.	Gray	<b>DRUBKITACCB5</b>
Communications kit (unloaded).	Gray	<b>HIDRUBCKIT</b>
(For use with Network Wiring frames in section W).		
Switch plate only.	Gray	<b>KP1GY**</b>
Rectangular opening plate only.	Gray	<b>KP26GY**</b>
1.60 in. opening plate only.	Gray	<b>KP720GY**</b>
1.40 in. opening plate only.	Gray	<b>KP7GY**</b>
Duplex receptacle plate only.	Gray	<b>KP8GY**</b>

Note: <sup>A</sup>See section M for additional information on isolated ground devices.

\*DRUB5462 configuration not pictured.

\*\*UL Listed, CSA Certified.

NEMA® is a registered trademark of the National Electrical Manufacturers Association.

# Straight Blade Devices Miscellaneous and Combination Receptacles

2 Pole, 3 Wire Grounding

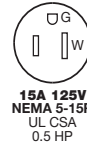

## Miscellaneous Receptacles

Description	Catalog Number
Receptacle, display type, brown phenolic with .060 in. brass plate and blank flush plug.	<b>HBL5236</b>
Replacement receptacle for HBL5236.	<b>HBL5236M2</b>
Replacement threaded plug for HBL5236.	<b>HBL5236PLUG*</b>
Receptacle, wooden floors, brown phenolic with .060 in. brass plate, blank flush plug and box.	<b>HBL6236</b>
Receptacle, clock hanger, brown with stainless steel plate.	<b>HBL5235</b>
Four outlet cluster, brown phenolic, steel cover, swivel hook. Cord grip range .296–.562 in. (7.5–14.3) cord not supplied.	<b>HBL9259*</b>

Note: \*Not UL Listed or CSA certified.













**HBL5236**



**HBL5235**

## Special Combination Duplex Receptacles

Description	Catalog Number
15A, 125V  Brown RTP, 1 feed, 1 return, back/side wired	<b>HBL4792</b>
 Brown RTP, 2 feeds, 1 return, side wired	<b>HBL4794</b>
15A, 125V  Brown RTP, 2 feeds, 2 returns, side wired	<b>HBL4795</b>
15A, 250V  Brown nylon face, 2 circuit, back and side wired	<b>HBL5292</b>
15A, 125V  Ivory nylon face, 2 circuit, back and side wired	<b>HBL5292I</b>
20A, 250V  Brown nylon face, 2 circuit, back and side wired	<b>HBL5492</b>
 Ivory nylon face, 2 circuit, back and side wired	<b>HBL5492I</b>
20A, 125V  Brown RTP, 2 feeds, 1 return, common ground	<b>HBL7371</b>
10A, 250V  15A, 125V  Brown nylon, side and back wired	<b>HBL5392</b>
20A, 125V  <i>Note: This device will only accept 20A grounding plugs.</i>	

Note: RTP is an abbreviation for reinforced thermoplastic polyester.

\*Not UL Listed or CSA certified.

See page A-46 for accessories.

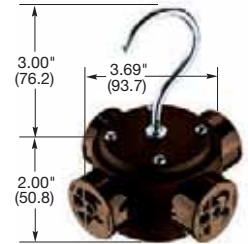

**HBL9259**

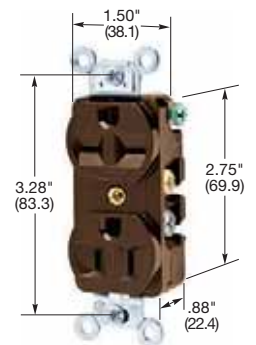

**HBL5292**

Dimensions in Inches (mm)

# Straight Blade Devices Accessories

For 15 and 20 Ampere, 125 and 250 Volts and 277 Volts AC Devices



NP8



## Wallplates, 1-Gang

Description	Color	Duplex Receptacles Catalog Number	Style Line® Receptacles Catalog Number	Single Receptacle Plate 1.40 in. (35.6) Dia. Catalog Number	
Nylon, smooth.	Almond	NP8AL	NP26AL	NP7AL	
	Black	NP8BK	NP26BK	NP7BK	
	Brown	NP8	NP26	NP7	
	Gray	NP8GY	NP26GY	NP7GY	
	Ivory	NP8I	NP26I	NP7I	
	Light Almond	NP8LA	NP26LA	NP7LA	
	Office White	NP8OW	NP26OW	NP7OW	
	Orange	NP8OR	-	-	
	Red	NP8R	NP26R	NP7R	
	White	NP8W	NP26W	NP7W	
	Stainless steel 302/304, .035 in. (0.9) horizontal brushed finish.		SS8	SS26	SS7
			SB8	SB26	SB7
Brass .04 in. (1.0), horizontal brushed finish.		SA8	-	SA7	
Aluminum .05 in. (1.3), horizontal brushed finish.					



NP26I



SS7



HBL52CM22

## Weatherproof Covers

Description	Duplex Receptacles Catalog Number	Single Receptacle Plate 1.40 in. (35.6) Dia. Catalog Number
RTP, gray, for FS/FD box mounting.	HBL5221	HBL7423WO
RTP, yellow, for FS/FD box mounting.	HBL52CM21	HBL74CM23WO
RTP, gray, for device mounting.	HBL5222	-
RTP, yellow, for device mounting.	HBL52CM22	-
Cast aluminum for FS/FD box mounting.	HBL5206WO	HBL7420
Cast aluminum for device mounting.	HBL5205WO	-

Note: All weatherproof plates are UL Listed for Wet Locations.

Those with suffix WO are listed for use with cover open, all others with cover closed.

RTP is an abbreviation for reinforced thermoplastic polyester.

See section N for additional information on cover plates.



HBL5206WO



HBL7423WO

# Straight Blade Devices Accessories

For 15 and 20 Ampere, 125 and 250 Volts and 277 Volts AC Devices



**IP44**  
SUITABILITY

## Weatherproof Covers For Nylon Flanged Inlets and Flanged Receptacles

Description	Catalog Number
RTP, gray, for FS/FD box mounting.	WP1

Note: RTP is an abbreviation for reinforced thermoplastic polyester.  
See page N-23 for additional information on weatherproof covers.



WP1

**IP55\***  
SUITABILITY

## Weatherproof Boots

Description	Catalog Number
Seal-Tite® triple seal, black elastomer cover for Insulgrip® plugs (HBL5266C style), when used in a cord set, and connector bodies (HBL5269C style), when used with flanged inlets.	HBL6017
Same as above except yellow.	HBL60CM17
Seal-Tite® triple seal black elastomer cover for Insulgrip® connector bodies when used in a cord set.	HBL6018
Same as above except yellow.	HBL60CM18
Closure plug, black.	HBL6019
Closure plug, yellow.	HBL60CM19

Note: \*IP55 when installed and used properly with mating components.  
Boots are not UL Listed or CSA Certified.



HBL6017



HBL6018



HBL60CM19  
Shown with HBL6018

## PLUGOUT® Device

Description	Catalog Number
Electrical plug lockout devices for 15 and 20A straight blade plugs.	HLDMP**
PLUGOUT® Lockout device for 20 and 30A Hubbell plugs and others.	HLD**

Note: \*\*Not UL Listed or CSA Certified.  
See section Z for additional information on lockout devices.



HLDMP

## Inserts

Description	Catalog Number
Replacement cord grip inserts for Valise® device, (bag of 40).	HBLVCGBK**

Note: \*\*Not UL Listed or CSA Certified.



HLD

Dimensions in Inches (mm)

## Straight Blade Devices Accessories

For 3 Wire 30 and 50 Ampere, 125 and 250 Volts and 277 Volts AC



SS723



SS703



HBL9420



HLD2



### Wallplates

Description	Color	Single Receptacle Plate 2.16 in. (54.9) Dia. Catalog Number
Nylon, smooth, 1-gang.	Black	<b>NP724BK</b>
Nylon, smooth, 2-gang.	Black	<b>NP703BK</b>
Aluminum, .05 in. (1.3), 1-gang, smooth horizontal brushed finish.		<b>SA723</b>
Stainless steel 302/304, .035 in. (0.9), 1-gang, smooth horizontal brushed finish.		<b>SS723</b>
Stainless steel 302/304, .035 in. (0.9), 2-gang, smooth horizontal brushed finish.		<b>SS703</b>

**IP44**  
SUITABILITY



### Weatherproof Lift Covers

Description	Catalog Number
Cast aluminum for FS/FD box mounting for 30A.	<b>HBL9420</b>
Cast aluminum for FS/FD box mounting for 50A.	<b>HBL9425</b>

### PLUGOUT® Device

Description	Catalog Number
Electrical plug lockout device for 30, 50 and 60A devices.	<b>HLD2</b>

*Note: See section Z for additional information on lockout devices.*

Dimensions in Inches (mm)



# Straight Blade Devices Accessories

For 4 Wire 30, 50 and 60 Ampere, 125/250 Volts, 3Ø 250 and 3ØY 120/208 Volts AC



## Wallplates, 2-Gang

Description	Catalog Number
Single Receptacle Plate 2.48 in. (63.0) Dia. Catalog Number	
Brass .04 in. (1.0), brushed, smooth.	<b>SB701</b>
Stainless steel 302/304, .035 in. (0.9), smooth horizontal brushed finish.	<b>SS701</b>



**SS701**



**IP44**  
SUITABILITY

## Weatherproof Lift Covers

Description	Catalog Number
RTP, gray, lift cover plate. Will fit FS/FD boxes having plate mounting hole 3.25 in. x 3.75 in. (82.5 x 95.2), centers. Only for use with receptacles on pages A-40 to A-43 with "A" suffix.	<b>HBL7777A</b>
Same as above except yellow.	<b>HBL77CM77A</b>

*Note: RTP is an abbreviation for reinforced thermoplastic polyester.*



**HBL7777A**

## PLUGOUT® Device

Description	Catalog Number
Electrical plug lockout device for 30, 50 and 60A devices.	<b>HLD2</b>

*Note: See section Z for additional information on lockout devices.*



**HLD2**

*Dimensions in Inches (mm)*

## HBL® Extra Heavy Duty, Straight Blade Hospital Grade Duplex Receptacles



HBL8200GY

### Specifications

Receptacles	Part	Description
Typical Specification – Catalog No. HBL8200	Receptacle	15A
Manufacturer's Identification – Hubbell HBL8200	Top	PBT*
Description – Hospital Grade, Straight Blade Duplex Receptacle	Base	RTP**
Type – 2 Pole, 3 Wire, Grounding	By-Pass Power Contacts	.037 in. (.9) Brass – Nickel Finish
Rating – 15A, 125V	Clamping Plate	.031 in. (.8) Brass – Nickel Finish
Certification: UL Listed to UL 498 File E2186, Fed. Spec. WC596,	Mounting Strap	.050 in. (1.3) Brass – Nickel Finish
Hospital Grade, NEMA® WD-6 Compliant	Line Terminal Screws	#10-32 Silicon Bronze, Multiple Drive
Certified to CSA, C22.2, No. 42 File 285	Hex Head Grounding Screw	#10-32 (Green) Silicon Bronze, Multiple Drive
	Center Assembly Rivet	Silicon Bronze
	Automatic Self-Grounding Clip	Stainless Steel
	Flat Head Mounting Screws	Stainless Steel

### Performance

Electrical	
Dielectric Voltage	Withstands 2,000V minimum.
Max. Working Voltage	125V or 250V as rated.
Current Interrupting	Certified for current interrupting at full rated current.
Temperature Rise	Max 30°C temperature rise at full rated current after 50 cycles of overload at 150% of rated current at a power factor of 75%.
Mechanical	
Terminal Identification	Terminals identified in accordance with UL 498 and CSA (Brass, White, Green).
Terminal Accommodation	#14-10 AWG stranded or solid copper conductor only.
Product Identification	Ratings are a permanent part of the device.
Environmental – Material	
Flammability	UL 94V-0 and UL 94-5 VA.
Operating Temperature	Maximum continuous 75°C; minimum -40°C (w/o impact).

Note: \*Polybutylene Terephthalate.

\*\*Reinforced Thermoplastic Polyester.



HBL5262

## HBL® Extra Heavy Duty, Straight Blade Specification Grade Duplex Receptacles

### Specifications

Receptacles	Part	Description
Typical Specification – Catalog No. HBL5262	Receptacle	15A
Manufacturer's Identification – Hubbell HBL5262	Top	Nylon
Description – Heavy Duty Straight Blade Duplex Receptacle	Base	RTP*
Type – 2 Pole, 3 Wire, Grounding	By-Pass Power Contacts	.037 in. (.9) Brass
Rating – 15A, 125V	Wire Clamps	.031 in. (.8) Brass
Certification: UL Listed to UL498 File E2186, Guide RTRT	Mounting Strap	.050 in. (1.3) Brass
Fed. Spec. WC596, Meets NEMA® WD-6 Compliant	Line Terminal Screws	#10-32 Brass, Multiple Drive
Certified to CSA, C22.2, No. 42 File 285	Ground Screw	#10-32 Brass, Multiple Drive (Green)
	Center Assembly Rivet	Brass
	Automatic Self-Grounding Clip	Stainless Steel
	Flat Head Mounting Screws	Steel-Zinc Plated
	Ground Tension Clips	Steel-Nickel Finish

### Performance

Electrical	
Dielectric Voltage	Withstands 2,000V minimum.
Max. Working Voltage	125V or 250V as rated.
Current Interrupting	Certified for current interrupting at full rated current.
Temperature Rise	Max 30°C temperature rise at full rated current after 50 cycles of overload at 150% of rated current at a power factor of 75%.
Mechanical	
Terminal Identification	Terminals identified in accordance with UL 498 and CSA (Brass, White, Green).
Terminal Accommodation	#14-10 AWG stranded or solid copper conductor only.
Product Identification	Ratings are a permanent part of the device.
Environmental – Material	
Flammability	Top: UL 94V-2. Base: UL 94V-0 and UL 94-5 VA.
Operating Temperature	Maximum continuous 75°C; minimum -40°C (w/o impact).

Note: \*Reinforced Thermoplastic Polyester.

NEMA® is a registered trademark of the National Electrical Manufacturers Association.

## HBL® Compact Extra Heavy Duty, Specification Grade Receptacles



HBL5252

### Specifications

Receptacles	Part	Description
Typical Specification – Catalog No. HBL5252	Receptacle	15A
Manufacturer's Identification – Hubbell HBL5252	Top	Nylon
Description – Straight Blade Duplex Receptacle	Base	RTP*
Type – 2 Pole, 3 Wire, Grounding	Triple Wipe Power Contacts	.032 in. (.8) Brass
Rating – 15A, 125V	Wire Clamps	.062 in. (1.8) Steel
Certification – UL Listed to UL 498 File E2186,	Mounting Strap	.050 in. (1.3) Brass
Fed. Spec. WC596, Certified to CSA 22.2, No. 42 File 285	Line Terminal Screws	#8-32 Brass, Multiple Drive
	Ground Screw	#8-32 Brass, Multiple Drive (Green)
	Center Assembly Rivet	Brass
	Automatic Self-Grounding Clip	Stainless Steel
	Flat Head Mounting Screws	Steel-Zinc Plated

### Performance

Electrical	
Dielectric Voltage	Withstands 2,000V minimum.
Max. Working Voltage	125V or 250V as rated.
Current Interrupting	Certified for current interrupting at full rated current.
Temperature Rise	Max 30°C temperature rise at full rated current after 50 cycles of overload at 150% of rated current at a power factor of 75%.
Mechanical	
Terminal Identification	Terminals identified in accordance with UL 498 (Brass, White, Green).
Terminal Accommodation	#14-10 AWG stranded or solid copper conductor only.
Product Identification	Ratings are a permanent part of the device.
Environmental – Material	
Flammability	UL 94V-2.
Operating Temperature	Maximum continuous 75°C; minimum -40°C (w/o impact).

Note: \*Reinforced Thermoplastic Polyester.

Please consult the factory for product dimensions and specifications of other products listed in this catalog.

# Straight Blade Devices Technical Information



## HBL® Compact Heavy Duty Style Line®, Specification Grade and Hospital Grade Straight Blade Duplex Receptacles

### Specifications

Receptacle	Part	Description
Typical Specification – Catalog No. HBL2152	Receptacle	15A
Manufacturer's Identification – Hubbell HBL2152 Receptacle	Top	Nylon
Description – Straight Blade Duplex Receptacle	Base	Nylon
Type – 2 Pole, 3 Wire Grounding	Triple Wipe Power Contacts	.031 in. (.8) Brass
Rating – 15A, 125V	Wire Clamp	.062 in. (1.8) Steel-Nickel Finish
Certification – UL File No. E2186	Mounting Strap	.040 in. (1) Steel (Galvanized)
Certified to CSA File No. 285	Ground Contact	.031 in. (.8) Brass
	Line Terminal Screws	#8-32 Brass, Multiple Drive
	Ground Screw	#8-32 Brass, Multiple Drive
	Center Assembly Staple	.040 in. (1) Steel (Galvanized)
	Automatic Self-Grounding Staple	Stainless Steel
	Mounting Screws	Zinc Plated Steel
Receptacle	Part	Description
Typical Specification – Catalog No. HBL2172	Receptacle	15A
Manufacturer's Identification – Hubbell HBL2182 Receptacle	Top	Nylon
Description – Straight Blade Duplex Receptacle	Base	RTP*
Type – 2 Pole, 3 Wire Grounding	Triple Wipe Power Contacts	.031 in. (.8) Brass
Rating – 15A, 125V	Wire Clamp	.062 in. (1.8) Steel-Nickel Finish
Certification – UL listed to UL498 File E2186,	Mounting Strap	.040 in. (1) Steel (Galvanized)
Fed. Spec. WC596, Certified to CSA File No. 285	Ground Contact	.031 in. (.8) Brass
	Line Terminal Screws	#8-32 Brass, Multiple Drive
	Ground Screw	#8-32 Brass, Multiple Drive
	Center Assembly Staple	.040 in. (1) Steel (Galvanized)
	Automatic Self-Grounding Staple	Stainless Steel
	Mounting Screws	Zinc Plated Steel

### Performance

Electrical	
Dielectric Voltage	Withstands 2,000V minimum.
Max. Working Voltage	125V.
Current Interrupting	Certified for current interrupting at full rated current.
Temperature Rise	Max 30°C temperature rise at full rated current after 50 cycles of overload at 150% of rated current at a power factor of 75%.
Mechanical	
Terminal Identification	Terminals identified in accordance with UL 498 and CSA (Brass, White, Green).
Terminal Accommodation	#14-10 AWG stranded or solid copper conductor only.
Product Identification	Ratings are a permanent part of the device.
Environmental – Material	
Flammability	UL 94V-2.
Operating Temperature	Maximum continuous 75°C; minimum -40°C (w/o impact).

Note: \*Reinforced Thermoplastic Polyester.

Please consult the factory for product dimensions and specifications of other products listed in this catalog.

# Straight Blade Devices Technical Information



## SNAPConnect® Straight Blade Duplex Receptacles Specification Grade and Hospital Grade

### Specifications

Receptacle	Part	Description
Typical Specification – Catalog No. SNAP8200	Receptacle	15A
Manufacturer's Identification – Hubbell SNAP8200	Top	Nylon
Description – Straight Blade Duplex Receptacle	Base	Nylon
Type – 2 Pole, 3 Wire, Grounding	Triple Wipe Power Contacts	Brass
Rating – 15A, 125V	Mounting Strap	Galvanized Steel; Brass (HG)
Certification – UL Listed to UL 498	Automatic Self-Grounding Clip	Stainless Steel
Fed. Spec. WC596, Certified to CSA 22.2, No. 42	Flat Head Mounting Screws	Steel-Zinc Plated/Self Tapping

Connector	Contact	Connector Body	Wire
SNAP1RA	Brass	Clear Polycarbonate	6" Solid copper #12 AWG THHN/THWN-2 600V, T90 Nylon FT-1, PVC 90°C (min).
SNAP2RA	Brass	Clear Polycarbonate	6" Stranded copper #12 AWG THHN/THWN-2 600V, T90 Nylon FT-1, PVC 90°C (min).

### Performance

Electrical	
Dielectric Voltage	Withstands 2,000V minimum.
Max. Working Voltage	125V as rated.
Current Interrupting	Receptacle certified for current interrupting at full rated current with equivalently rated NEMA® plug.
Temperature Rise	Max 30°C temperature rise at full rated current after 50 cycles of overload at 150% of rated DC current.

  

Mechanical	
Terminal Wire Leads Identification	Terminal wire leads identified in accordance with UL 498 (Black, White, Green).
Product Identification	Ratings are a permanent part of the device.

Environmental – Material	
Flammability	UL 94V-2.
Operating Temperature	Maximum continuous 75°C; minimum -40°C (without impact).

### Dimensions

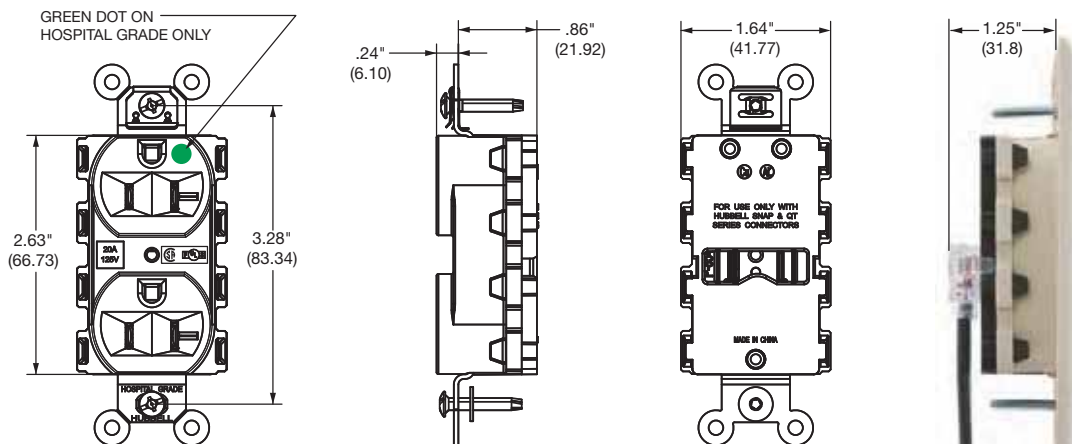

NEMA® is a registered trademark of the National Electrical Manufacturers Association.

# Straight Blade Devices Technical Information



8200REDLTR



2182IVLTR

## Hubbell-PRO Heavy Duty, Straight Blade Hospital Grade Duplex Receptacles

### Specifications

Receptacle	Part	Description
Typical Specification - Catalog No. 8200	Receptacle	15A
Manufacturer's Identification - Hubbell-Pro 8200	Top	Nylon
Description - Straight Blade Hospital Grade Duplex Receptacle	Base	Nylon
Type - 2 Pole, 3 Wire, Grounding	Triple Wipe Power Contacts	.0295" Brass
Rating - 15A, 125V	Clamping Plate	Plated Steel
Certification - UL listed to UL 498, Fed Spec WC596	Mounting Strap	.040" Galvanized Steel
Hospital Grade, NEMA® WD-6 Compliant	Terminal Screws	Plated Steel
Certified to CSA	Hex Head Grounding Screw	Plated Steel
	Automatic Self-Grounding Staple	Stainless Steel
	Mounting Screws	Zinc Plated Steel

### Performance

Electrical	
Dielectric Voltage	Withstands 2,000V minimum.
Max. Working Voltage	125V.
Current Interrupting	Certified for current interrupting at full rated current.
Temperature Rise	Max 30°C temperature rise at full rated current after 50 cycles of overload at 150% of rated current at a power factor of 75%.
Mechanical	
Terminal Identification	Terminals identified in accordance with UL 498 and CSA (Brass, White, Green)
Terminal Accommodation	#14-10 AWG stranded or solid copper conductor only.
Product Identification	Ratings are a permanent part of the device.
Environmental - Material	
Flammability	UL 94V-2.
Operating Temperature	Maximum continuous 75°C; minimum -40°C (w/o impact).

NEMA® is a registered trademark of the National Electrical Manufacturers Association.

## USB Charger Tamper-Resistant, Straight Blade Hospital Grade and Specification Grade Duplex Receptacles



USB8300R



USB15X2W

### Specifications

USB Charger Receptacle	Part	Description
Typical Specification - Catalog No. USB8300	Charger Receptacle	USB 3 Amp 5VDC, Electrical 15A or 20A 125V
Manufacturer's Identification - Hubbell USB8300		
USB Charger	Ports	Type A, 2.0
	LED	Green Indicator
Receptacle	Top	Nylon
Description - Hospital Grade, Straight Blade Duplex Receptacle	Base	Nylon
Type - 2 Pole, 3 Wire, Grounding	Triple Wipe Power Contacts	.030" Cooper Alloy
Rating - 15A, 125V	Clamping Plate	Plated Steel
	Mounting Strap	.040" Galvanized Steel
Certification - cULus listed to UL498 and UL1310	Terminal Screws	Plated Steel
Hospital Grade, NEMA® WD-6 Compliant (USB8200 and 8300 series only)	Hex Head Grounding Screw	Plated Steel
Complies with battery charging specification USB BC 1.2	Automatic Self-Grounding Staple	Stainless Steel
Complies with Part 15 of the FCC rules	Mounting Screws	Zinc Plated Steel
Compatible with SUB 1.1/2.0/3.0 devices, including Apple products		

### Performance

Electrical	
Dielectric Voltage	Withstands 2,000V minimum.
Max. Working Voltage	125V.
Current Interrupting	Certified for current interrupting at full rated current.
Temperature Rise	Max 30°C temperature rise at full rated current after 50 cycles of overload at 150% of rated current at a power factor of 75%.
Mechanical	
USB Port	Stainless Steel Rated for 10,000 plug insertions and removal
Terminal Identification	Terminals identified in accordance with UL 498 and CSA (Brass, White, Green)
Terminal Accommodation	#14-10 AWG stranded or solid copper conductor only.
Product Identification	Ratings are a permanent part of the device.
Circuit Feed-Through	20 Amp 125 Volt
Environmental - Material	
Flammability	UL 94V-2.
Operating Temperature	Maximum continuous 75°C; minimum -40°C (w/o impact).

NEMA® is a registered trademark of the National Electrical Manufacturers Association.



## Hubbell-PRO Heavy Duty, Straight Blade Specification Grade Duplex Receptacles



### Specifications

Receptacle, Smooth Nylon Face	Part	Description
Typical Specification – Catalog No. 5252A	Receptacle	15A
Manufacturer's Identification – Hubbell 5252A Receptacle	Top	Nylon
Description – Straight Blade Duplex Receptacle	Base	RTP*
Type – 2 Pole, 3 Wire Grounding	Triple Wipe Power Contacts	.031 in. (.8) Brass
Rating – 15A, 125V	Wire Clamp	.062 in. (1.8) Steel-Nickel Finish
Certification – UL File No. E2186	Mounting Strap	.040 in. (1) Steel (Galvanized)
Certified to CSA File No. 285	Ground Contact	.031 in. (.8) Brass
	Line Terminal Screws	#8-32 Brass, Multiple Drive
	Ground Screw	#8-32 Brass, Multiple Drive
	Center Assembly Staple	.040 in. (1) Steel (Galvanized)
	Automatic Self-Grounding Staple	Stainless Steel
	Mounting Screws	Zinc Plated Steel
Receptacle, Finder Groove Face	Part	Description
Typical Specification – Catalog No. 5262	Receptacle	15A
Manufacturer's Identification – Hubbell 5262 Receptacle	Top	Nylon
Description – Straight Blade Duplex Receptacle	Base	RTP*
Type – 2 Pole, 3 Wire Grounding	Triple Wipe Power Contacts	.031 in. (.8) Brass
Rating – 15A, 125V	Wire Clamp	.062 in. (1.8) Steel-Nickel Finish
Certification – UL listed to UL498 File E2186,	Mounting Strap	.040 in. (1) Steel (Galvanized)
Fed. Spec. WC596, Certified to CSA C22.2, No. 42	Ground Contact	.031 in. (.8) Brass
	Line Terminal Screws	#8-32 Brass, Multiple Drive
	Ground Screw	#8-32 Brass, Multiple Drive
	Center Assembly Staple	.040 in. (1) Steel (Galvanized)
	Automatic Self-Grounding Staple	Stainless Steel
	Mounting Screws	Zinc Plated Steel

### Performance

Electrical	
Dielectric Voltage	Withstands 2,000V minimum.
Max. Working Voltage	125V.
Current Interrupting	Certified for current interrupting at full rated current.
Temperature Rise	Max 30°C temperature rise at full rated current after 50 cycles of overload at 150% of rated current at a power factor of 75%.
Mechanical	
Terminal Identification	Terminals identified in accordance with UL 498 and CSA (Brass, White, Green)
Terminal Accommodation	#14-10 AWG stranded or solid copper conductor only.
Product Identification	Ratings are a permanent part of the device.
Environmental – Material	
Flammability	UL 94V-2.
Operating Temperature	Maximum continuous 75°C; minimum -40°C (w/o impact).

Note: \*Reinforced Thermoplastic Polyester.

Please consult the factory for product dimensions and specifications of other products listed in this catalog.



CR15ALP1



DR15GRYP1

## Commercial Specification Grade Receptacles with Wire Leads

### Specifications

Part	
Top	Nylon
Base	Nylon
Double Wipe Power Contacts	.030 in. (.8) Brass
Finish	
Mounting Strap	.040 in. (1) Steel (Galvanized)
Ground Contact	.031 in. (.8) Brass
Line Terminal Screws	-
Ground Screw	-
Wire Leads	8" Solid or Stranded copper #12 AWG THHN/THWN-2 600V, T90 nylon FT-1, PVC 90°C (min)
Automatic Self-Grounding Staple	Stainless Steel
Mounting Screws	Zinc Plated Steel
Certification	
UL Listed	UL498
Fed. Spec.	WC596*
Certified to CSA	C22.2, No. 42

### Performance

Electrical	
Dielectric Voltage	Withstands 2,000V minimum.
Max. Working Voltage	125V.
Current Interrupting	Certified for current interrupting at full rated current.
Temperature Rise	Max 30°C temperature rise at full rated current after 100 cycles of overload at 150% of rated current.
Mechanical	
Terminal Identification	-
Terminal Accommodation	-
Product Identification	Ratings are a permanent part of the device.
Environmental – Material	
Flammability	UL 94V-2.
Operating Temperature	Maximum continuous 75°C; minimum -40°C (w/o impact).

Note: \*Decorator and Commercial Tamper-Resistant devices are not Fed. Spec. Listed.

# Straight Blade Devices Technical Information



## Commercial Specification Grade Receptacles

### Specifications

Part	Standard	Weather Resistant
Top	Nylon	Nylon (UV Rated)
Base	Nylon	Nylon
Double Wipe Power Contacts	.030 in. (.8) Brass	.030 in. (.8) Brass
Wire Clamp	.062 in. (1.6) Steel-Nickel Plated	.062 in. (1.6) Steel-Nickel Plated
<b>Finish</b>		
Mounting Strap	.040 in. (1) Steel (Galvanized)	.040 in. (1) Steel (Galvanized)
Ground Contact	.031 in. (.8) Brass	.031 in. (.8) Brass
Line Terminal Screws	#8-32 Plated Steel, Multiple Drive	#8-32 Stainless Steel, Multiple Drive
Ground Screw	#8-32 Plated Steel, Multiple Drive	#8-32 Stainless Steel, Multiple Drive
Automatic Self-Grounding Staple	Stainless Steel	Stainless Steel
Mounting Screws	Zinc Plated Steel	Stainless Steel
<b>Certification</b>		
UL Listed	UL498	UL498
Fed. Spec.	WC596*	WC596*
Certified to CSA	C22.2, No. 42	C22.2, No. 42

### Performance

<b>Electrical</b>		
Dielectric Voltage	Withstands 2,000V minimum.	Withstands 2,000V minimum.
Max. Working Voltage	125V.	125V.
Current Interrupting	Certified for current interrupting at full rated current.	Certified for current interrupting at full rated current.
Temperature Rise	Max 30°C temperature rise at full rated current after 100 cycles of overload at 150% of rated current.	Max 30°C temperature rise at full rated current after 100 cycles of overload at 150% of rated current.
<b>Mechanical</b>		
Terminal Identification	Terminals identified in accordance with UL 498 and CSA (Brass, White, Green).	Terminals identified in accordance with UL 498 and CSA (Brass, White, Green).
Terminal Accommodation	#14-10 AWG stranded or solid copper conductor only.	#14-10 AWG stranded or solid copper conductor only.
Product Identification	Ratings are a permanent part of the device.	Ratings are a permanent part of the device.
<b>Environmental – Material</b>		
Flammability	UL 94V-2.	UL 94V-2.
Operating Temperature	Maximum continuous 75°C; minimum -40°C (w/o impact).	Maximum continuous 75°C; minimum -40°C (w/o impact).

Note: \*Decorator and Commercial Tamper-Resistant devices are not Fed. Spec. Listed.



**HBL415I**

**4-PLEX® Receptacles**

**Specifications**

Receptacle	Part	Description
Typical Specification – Catalog No. HBL415	Receptacle	15 or 20A
Manufacturer’s Identification – Hubbell 4-PLEX HBL415	Top	Polycarbonate
Description – Straight Blade, Multiple Outlet Receptacle	Base	Polycarbonate
Type – 2 Pole, 3 Wire, Grounding	Power Contacts	.032 in. (.8) Brass
Rating 15A, 125V	Ground Contacts	.031 in. (.8) Brass
Certification – Listed to UL Standard 498 File E2186	Ground Plate	.032 in. (.8) Plated Steel
Certified to CSA 22.2, No. 42 File 285	(Hospital Grade)	.050 in. (1.3) Plated Steel
	Line and Neutral Terminal Plate	.031 in. (.8) Brass
	Line Terminal Screw	#8-32 Brass
	Ground Screw	#8-32 Brass (Green)

**Performance**

Electrical	
Dielectric Voltage	Withstands 2,000V minimum.
Max. Working Voltage	125V.
Current Interrupting	Capable of withstanding a fault level of 1000A, per UL498.
Temperature Rise	Max 30°C temperature rise at full rated current after 50 cycles of overload current at 150% of rated current at a power factor of 75%.
Mechanical	
Terminal Identification	Terminals identified in accordance with UL498 and CSA (Brass, White, Green).
Terminal Accommodation	#14-12 AWG stranded or solid copper conductor only.
Product Identification	Ratings are a permanent part of the device.
Environmental	
Flammability	UL 94V-2.
Operating Temperature	Maximum continuous 75°C; minimum -40°C (w/o impact).

# Straight Blade Devices Technical Information



HBL5266C



HBL5269C

## Insulgrip® Plugs and Connector Bodies

### Specifications

Plugs	Part	Description
Typical Specification – Catalog No. HBL5266C		Plug
Manufacturer's Identification – Hubbell HBL5266C		Housing
Description – Straight Body Plug		Blade Holder
Type – 2 Pole, 3 Wire, Grounding		Retainer
Rating – 15A, 125V		Cord Clamp
Verified to Federal Spec WC596		Contact Blades
Certification – UL Listed to UL498 File E1706, CSA Certified to C22.2 No. 42 File 280		Ground Contact Blade
IP Suitability – IP20		Line Terminal Screws
		Ground Screw
		Wire Clamps
Connector Bodies	Part	Description
Typical Specification – Catalog No. HBL5269C		Connector Body
Manufacturer's Identification – Hubbell HBL5269C		Housing
Description – Straight Body Connector		Contact Holder
Type – 2 Pole, 3 Wire, Grounding		Retainer
Rating – 15A, 125V		Cord Clamp
Verified to Federal Spec WC596		Power Contacts
Certification – UL Listed to UL498 File E1706, CSA Certified to C22.2 No. 42 File 280		Line Terminal Screws
IP Suitability – IP20		Ground Screw
		Wire Clamps

### Performance

Electrical	
Dielectric Voltage	Withstands 2,000V minimum.
Max. Working Voltage	125V or 250V as rated.
Current Interrupting	Certified for current interrupting at full rated current.
Temperature Rise	Max 30°C temperature rise at full rated current after 50 cycles of overload at 150% of rated current at a power factor of 75%.
Mechanical	
Terminal Identification	Terminals identified in accordance with UL498 and CSA (Brass, White, Green).
Terminal Accommodation	#18-10 AWG copper conductors only.
Product Identification	Ratings are a permanent part of the device.
Torque Range	12 in./lb. terminal screws, 7 in./lb. assembly screws.
Cord Diameter Range	.230–.720 in. (5.8–18.3) integral cord grip.
Environmental – Material	
Flammability	UL 94HB or better.
Operating Temperature	Maximum continuous 75°C; minimum – 40°C (w/o impact).

# Straight Blade Devices Technical Information



HBL5965VY



HBL5969VY

## Valise® Plugs and Connectors

### Specifications

Plugs	Part	Description
Typical Specification – Catalog No. HBL5965VY	Plug	15A
Manufacturer's Identification – Hubbell HBL5965VY	Housing	Nylon
Description – Straight Body Plug	Contact Blades	Brass
Type – 2 Pole, 3 Wire, Grounding	Ground Blade	Brass
Rating – 15A, 125V	Line Terminal Screws	Steel-Copper, Multiple Drive
Verified to Federal Spec WC596	Ground Screw	Steel (Green), Multiple Drive
Certification – UL Listed to UL 498 File E1706, CSA Certified to C22.2 No. 42 File 280C	Cable Inserts	Poly Phenylene Oxide
IP Suitability – IP20	Wire Clamps	Steel
	Body Holding Screws	Steel, Multiple Drive

Connector Bodies	Part	Connector
Typical Specification – Catalog No. HBL5969VY	Connector Body	15A
Manufacturer's Identification – Hubbell HBL5969VY	Housing	Nylon
Description – Straight Body Connector	Contact and Ground Springs	Brass
Type – 2 Pole, 3 Wire, Grounding	Line Terminal Screws	Steel-Copper, Multiple Drive
Rating – 15A, 125V	Ground Screw	Steel (Green), Multiple Drive
Verified to Federal Spec WC596	Cable Inserts	Poly Phenylene Oxide
Certification – UL Listed to UL 498 File E1706, CSA Certified to C22.2 No. 42 File 280C	Wire Clamps	Steel
IP Suitability – IP20	Body Holding Screws	Steel, Multiple Drive

### Performance

Electrical	
Dielectric Voltage	Withstands 2,000V minimum.
Max. Working Voltage	125V or 250V as rated.
Current interrupting	Certified for current interrupting at full rated current.
Temperature Rise	Max 30°C temperature rise at full rated current after 50 cycles of overload at 150% of rated current at a power factor of 75%.

Mechanical	
Terminal Identification	Terminals identified in accordance with UL 498 and CSA (Brass, White, Green).
Terminal Accommodation	Copper conductors only. 2 Wire 15A Only #18-14 AWG, 2 Wire 20A & 3 Wire #18-12 AWG, Hospital Grade #16-12 AWG, I.D. Valise #18-16 AWG.
Product Identification	Molded Rating on Device Face.
Torque	12 in./lb. terminal screws, 7 in./lb. assembly screws.
Cord Diameter Range	2-Wire 15A Only .218–.385 in. (5.5–9.8), 2-Wire 20A & 3 Wire .220–.660 in. (5.6–16.8), Hospital Grade .300–.660 in. (7.6–16.8), I.D. Valise .230–.360 in. (5.8–9.1).

Environmental – Material	
Flammability	UL 94V-2.
Operating Temperature	Maximum continuous 75°C; minimum -40°C (w/o impact).

Standards	
NEMA® WD1	
NEMA® Configurations	
Listed to UL Standard UL498	
Certified to CSA Standard C22.2 No. 42	
Verified to Federal Spec WC596	

NEMA® is a registered trademark of the National Electrical Manufacturers Association.

# Straight Blade Devices Technical Information



## IEC 320 Devices

### Specifications

<b>Receptacle</b>	
Catalog Number	H320R
Description	IEC Configuration compatible straight blade panel mount receptacle.
Type	2 Pole + earth.
Rating	16A 250V AC for European service; 20A 250V AC for North American service.
Certification	UL listed 20A 250V AC – File No. E2186; CSA certified 20A 250V AC – File No 17337.
Terminal Accommodation	North American – #16-12 AWG stranded or solid copper conductor only. International – 1.55mm <sup>2</sup> –2.5mm <sup>2</sup> .
<b>Connector</b>	
Catalog Number	H320C
Description	IEC Detachable straight blade connector.
Type	2 Pole + earth.
Rating	16A 250V AC for European service; 20A 250V AC for North American service.
Configuration	IEC 60320-1 Style appliance coupler, C19.
Certification	UL listed 20A 250V AC – File No. E1706; CSA Certified 20A 250V AC – File No. 17337; UL classified to IEC 320, 16A 250V AC – File No. E111246;
Cord Accommodation	North American – 16/3SJ-12/3SJ (.325–.475 in. dia.); International – (HAR cord) 3x1.5mm <sup>2</sup> –3x2.5mm <sup>2</sup> (8mm–12mm dia.).
IP Suitability	IP20.
<b>Plug</b>	
Catalog Number	H320P
Description	IEC Configuration compatible straight blade Valise® plug.
Type	2 Pole + earth.
Rating	16A 250V AC for European service; 20A 250V AC for North American service.
Certification	UL listed 20A 250V AC – File No. E1706; CSA Certified 20A 250V AC – File No. 17337.
Cord Accommodation	North American – 16/3 SJ-12/3SJ (.325–.475 in. dia.); International – (HAR cord) 3x1.5mm <sup>2</sup> 3x2.5mm <sup>2</sup> (8–12mm dia.).
IP Suitability	IP20.
<b>Inlet</b>	
Catalog Number	H320B and H320BL
Description	IEC Straight blade panel mount power inlet.
Type	2 Pole + earth.
Rating	16A 250V AC for European service; 20A 250V AC for North American service.
Configuration	IEC 60320-1 Style appliance coupler, C20.
Certification	UL listed 20A 250V AC – File No. E1706; CSA certified 20A 250V AC – File No. 17337; UL classified to IEC 320, 16A 250V AC – File No. E111246;
Terminal Accommodation	VDE certified at 16A 250V AC – File No. 12469 1550 1002. North American – #16-12 AWG stranded or solid copper conductor only. International – 1.5mm <sup>2</sup> –2.5mm <sup>2</sup> .



HBL9431C



HBL9430A

## Heavy Duty Insulgrip® Plugs and Receptacles

### Specifications

Plug	Part	Description
Typical Specification - Catalog No. HBL9431C	Plug	30A
Manufacturer's identification - Hubbell HBL9431C	Housing	Supertough Nylon
Description - Straight Body Plug	Blade Holder & Retainer	Reinforced Thermoplastic Polyester
Type - 3 Pole, 4 Wire, Grounding	Blades	Brass
Rating - 30A, 125/250V	Terminal Screws	3/8 in. Allen Head, Plated Steel
Certification - UL Listed File E1706, CSA Certified*	Box Terminals	Copper Alloy
IP Suitability - IP20	Cord Clamps	Reinforced Thermoplastic Polyester
	Mounting and Clamp Screws	Stainless Steel
	Cord Grip Range	.625–1.310 in. (15.9–33.3)
Receptacle	Part	Description
Typical Specification - Catalog No. HBL9430A	Receptacle	30A
Manufacturer's Identification - Hubbell HBL9430A	Housing Construction	Reinforced Thermoplastic Polyester
Description - Single Receptacle	Mounting Plate	.062 in. (1.5) Pre-Plated Steel
Type - 3 Pole, 4 Wire, Grounding	Contacts	Brass
Rating - 30A, 125/250V	Ground Shunt	Brass
Certification - UL Listed File E2186, CSA Certified	Terminal Screws	3/8 in. Allen Head, Plated Steel
	Box Terminals	Copper

### Performance

Electrical	
Dielectric Voltage	Withstands 2,000V minimum.
Max. Working Voltage	125V or 250V as rated.
Current Interruption	Certified for current interrupting at full rated current.
Temperature Rise	Max 30°C temperature rise at full rated current after 50 cycles of overload at 150% of rated current at a power factor of 75%.
Mechanical	
Terminal Identification	Terminals identified in accordance with UL 498 (Brass, White, Green).
Terminal Accommodation	#12 AWG through #4 AWG copper wire only.
Production Identification	Ratings are a permanent part of the device.
Environmental	
Flammability	Receptacle: UL 94 VO. Plug: UL 94 HB (Housing), UL 94 VO (Blade Holder and Retainer).
Operating Temperature	Maximum continuous 60°C, minimum -40°C (w/o impact).

Note: \*Listed to UL Standard 498 (Attachment Plugs and Receptacles), Certified to CSA Standard 42M (General Use Receptacles, Attachments, Plugs and Singular Wiring Devices) where applicable.



# Section B Twist-Lock® and Hubbellock® Devices

## Index

Product	Page
Summary . . . . .	B-2
15A Midget Twist-Lock® Devices . . . . .	B-3
15A Twist-Lock® Devices - Features and Benefits . . . . .	B-7
<b>Features and Benefits</b>	
20 and 30A Plugs and Connector Bodies . . . . .	B-12
The Standard for Locking Receptacles . . . . .	B-13
Watertight Safety-Shroud® Twist-Lock® System . . . . .	B-14
Safety-Shroud® Twist-Lock® System . . . . .	B-15
Compatibility and Environmental Protection Chart . . . . .	B-16
20A Twist-Lock® Devices . . . . .	B-17
30A Twist-Lock® Devices . . . . .	B-26
Switched Safety Enclosures . . . . .	B-36
Mechanical Interlock Switched Safety Enclosures . . . . .	B-38
Add-A-Shroud® . . . . .	B-40
10, 20 and 30A Non-NEMA Twist-Lock® Devices . . . . .	B-41
15, 20 and 30A Accessories . . . . .	B-48
50A Twist-Lock® Devices . . . . .	B-55
Hubbellock® Devices . . . . .	B-61
<b>Technical Information</b>	
15, 20 and 30A Twist-Lock® and Safety-Shroud Devices . . . . .	B-69
Watertight Safety-Shroud Twist-Lock® Devices . . . . .	B-70
50A Twist-Lock® Devices . . . . .	B-71
Switched Twist-Lock® and Hubbellock® Enclosures . . . . .	B-72
Mechanical Interlock Switched Safety Enclosures . . . . .	B-73
Valise® Twist-Lock® Devices . . . . .	B-74

### Midget Twist-Lock® Devices



### Twist-Lock® Devices



### Watertight Safety-Shroud® and Circuit-Lock®



### 50 Amp Devices and Hubbellock®





**Insulgrip® Plugs, Connectors, Receptacles and Inlets**

The widest range of singularly rated NEMA devices available. Designed to last from engineered thermoplastic materials and high performing alloys.



**Safety-Shroud® Twist-Lock®**

The ultimate in Twist-Lock safety. A full offering of plugs and connectors that lead the field in personnel safety. Also included are receptacles in three styles, angled, surface mount and semi-flush to satisfy every installation need.



**Watertight Safety-Shroud® Twist-Lock®**

A complete family of plugs, connectors, receptacles and inlets featuring UL Type 4X enclosure ratings and Safety-Shroud design.

**There's Only One Manufacturer of Twist-Lock® ...Hubbell.**

There's no company more synonymous with a tradition of excellence in the electrical industry than Hubbell. Having introduced the Twist-Lock device in the early 20th century Hubbell has been the market leader ever since.

Hubbell Insulgrip® Twist-Lock's rugged construction features highly engineered materials, roomy wiring chambers, superior strain relief and powerful cord grip designs. Insulgrip Twist-Lock products are the foundation of the broadest breadth of line available. Hubbell offers Twist-Lock for minimum space applications (Midget), and all other applications from 15 Amp to 50 Amp. Hubbell's design expertise assures the best performing products available.

**Hubbell Re-Defines Excellence**

The Insulgrip Twist-Lock product line features a complete offering of 20A and 30A Safety Shroud Twist-Lock devices. Current carrying blades are protected by a fixed shroud, shielding them from deformation. Even more importantly, the shroud virtually eliminates user contact with a partially engaged, energized plug. For wet environments, Hubbell offers the Watertight Safety-Shroud Twist-Lock series. These products incorporate the shrouding technology with a UL Type 4X enclosure rating.



**Watertight Mechanical Interlock for Safety-Shroud® Twist-Lock®**

Hubbell's Circuit-Lock enclosure products virtually eliminate making or breaking the circuit under load.



**50 Amp Insulgrip Twist-Lock®**

An exclusive Hubbell design delivering Insulgrip features, insulated housing and superior strain relief. They are tough and rugged enough for the most demanding construction or industrial applications.



**Midget Twist-Lock®**

These 2 wire and 3 wire products offer the same quality as their larger counterparts, but are sized to go where they can't. The optional Valise® design makes for fast, simple wiring.



**Hubbelock® Devices**

Hubbelock devices are the proven choice to reduce problems resulting from arcing, lazy connections, loosening terminals, moisture, corrosion and rough use.

Twist-Lock® Devices  
**Midget Twist-Lock®**  
*Features and Benefits*

Hubbell's Valise® insulation displacement terminal for Midget Twist-Lock® Plugs and Connector Bodies are the right choice for economy, wiring speed and long life.

Assembly screws have multiple drive heads for screwdriver versatility. Only two assembly screws are needed to close this device, make the wire terminations and retain the cord

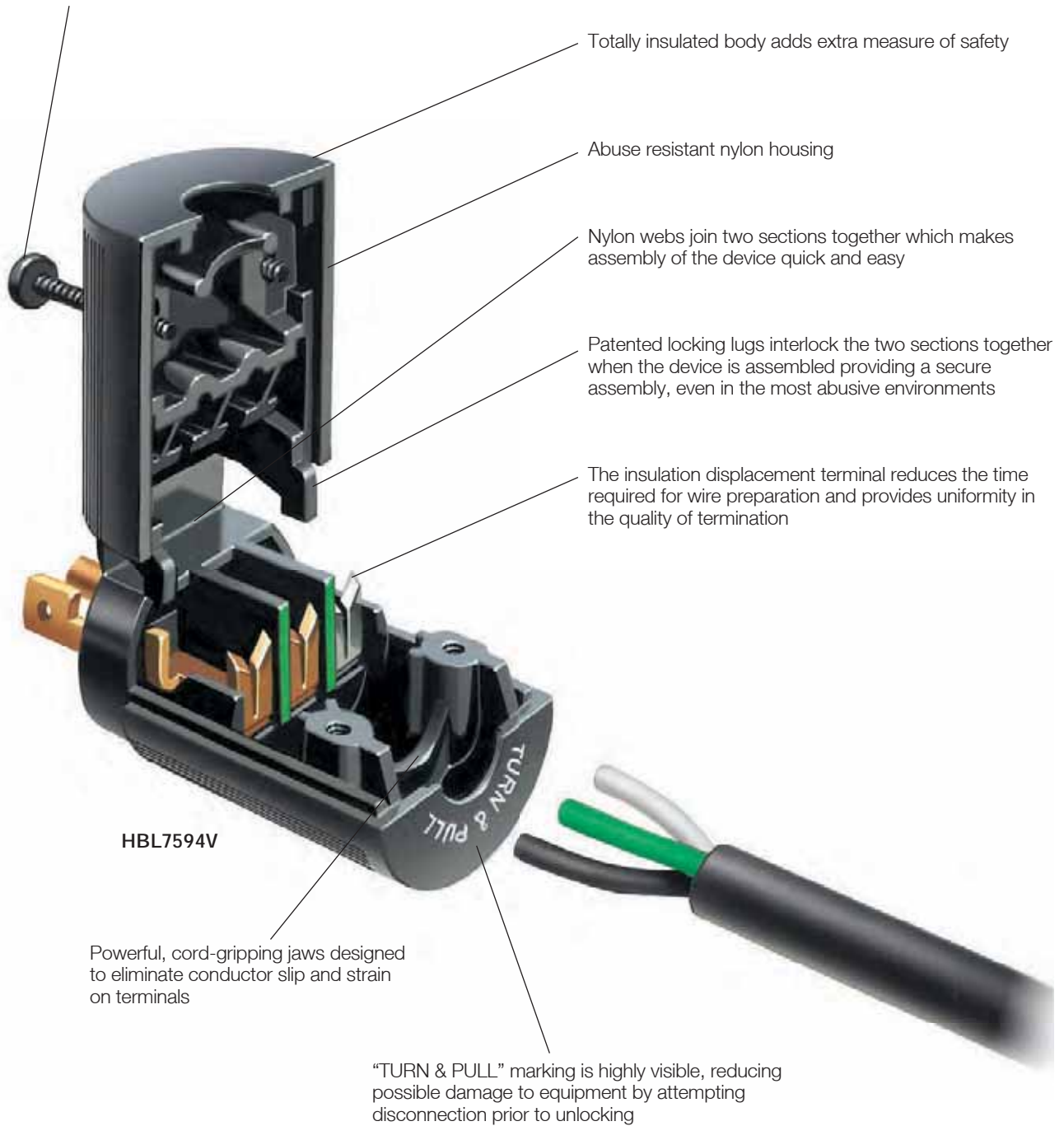

Twist-Lock® Devices  
 15 Ampere, 125 and 125/250 Volts  
 Midget Twist-Lock® Plugs and Flanged Inlets



**IP20**  
 SUITABILITY

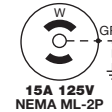

**Plugs**

Description	Cord Dia.	Catalog Number		
Valise® plug, black nylon.	.220"-.385" (5.6-9.8)	<b>HBL7465V*</b>	-	-
Valise® plug, black nylon, insulation displacement terminals.	.300"-.430" (7.6-10.9)	-	<b>HBL7594V</b>	-
Black nylon cover, phenolic body, multiple drive screw terminals.	.281"-.421" (7.1-10.7)	-	<b>HBL7594</b>	-
Angle plug, black nylon cover, phenolic body, multiple drive screw terminals.	.335"-.421" (8.5-10.7)	-	<b>HBL7570</b>	-
Valise® plug, black nylon, with insulation displacement terminals, multiple drive screws.	.300"-.430" (7.6-10.9)	-	-	<b>HBL7485V*</b>
Black nylon body, phenolic base, multiple drive screw terminals, cord grip.	.281"-.421" (7.1-10.7)	-	-	<b>HBL7485*</b>
Same as above, except angle cord grip.	.335"-.421" (8.5-10.7)	-	-	<b>HBL7432*</b>

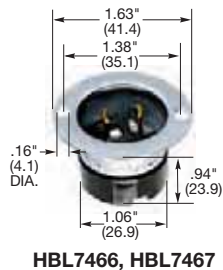
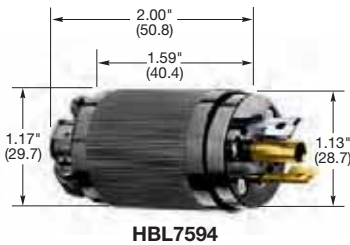
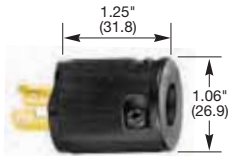

**Flanged Inlets**

Description	Catalog Number		
Stainless steel flange, polarized, exposed terminals.	<b>HBL7467*</b>	-	-
Stainless steel flange, not polarized, exposed terminals.	<b>HBL7466*</b>	-	-
Exposed terminals, black nylon flange.	-	<b>HBL7595N</b>	-
Exposed terminals, stainless steel flange.	-	<b>HBL7595</b>	-
Covered terminals, stainless steel flange, accepts cord .500" (12.7) dia.	-	<b>HBL7551</b>	-
Exposed terminals, black nylon flange.	-	-	<b>HBL7486N*</b>
Exposed terminals, stainless steel flange.	-	-	<b>HBL7486*</b>

Note: See page B-6 for accessories.

\*UL Listed only.

Male ML-2P devices have hollow center ground sleeves.

Male ML-3P devices have solid center neutral pins.

Dimensions in Inches (mm)

Twist-Lock® Devices  
 15 Ampere, 125 and 125/250 Volts  
 Midget Twist-Lock® Connector Bodies and Flanged Receptacles



**IP20**  
SUITABILITY



15A 125V  
NEMA ML-1R



15A 125V  
NEMA ML-2R



15A 125/250V  
NEMA ML-3R

**Connector Bodies**

Description	Cord Dia.	Catalog Number		
Valise® connector body, black nylon, polarized.	.220"-.385" (5.6-9.8)	<b>HBL7464V*</b>	-	-
Valise® connector body, black nylon, insulation displacement terminals.	.300"-.430" (7.6-10.9)	-	<b>HBL7593V</b>	-
Black nylon cover, phenolic body, screw terminals.	.281"-.421" (7.1-10.7)	-	<b>HBL7593</b>	-
Angle connector body, black nylon cover, phenolic body, screw terminals.	.335"-.421" (8.5-10.7)	-	<b>HBL7571</b>	-
Valise® type, black nylon, with insulation displacement terminals, multiple drive screws.	.300"-.430" (7.6-10.9)	-	-	<b>HBL7484V*</b>
Black nylon body, phenolic base, multiple drive screws, cord grip.	.281"-.421" (7.1-10.7)	-	-	<b>HBL7484*</b>
Same as above, except for angle cord grip.	.335"-.421" (8.5-10.7)	-	-	<b>HBL7433*</b>



**HBL7464V**

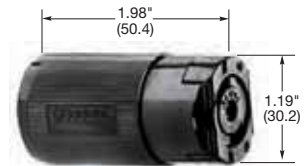

**HBL7593V**



**HBL7593**



**HBL7571**

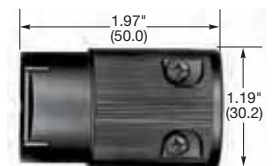

**HBL7484V**



**HBL7484**

**Flanged Receptacles**

Description	Catalog Number		
Stainless steel flange, exposed terminals.	<b>HBL7468*</b>	-	-
Exposed terminals, black nylon flange.	-	<b>HBL7596N</b>	-
Exposed terminals, stainless steel flange.	-	<b>HBL7596</b>	-
Covered terminals, stainless steel flange, accepts cord .500" (12.7) in dia.	-	<b>HBL7598</b>	-
Exposed terminals, black nylon flange.	-	-	<b>HBL7487N*</b>
Exposed terminals, stainless steel flange.	-	-	<b>HBL7487*</b>
Covered terminals, stainless steel flange, accepts cord .500" (12.7) in diameter.	-	-	<b>HBL7489*</b>

Note: See page B-6 for accessories.

\*UL Listed only.

Female ML-2R devices have solid center ground pins.

Female ML-3R devices have hollow center neutral sleeves.

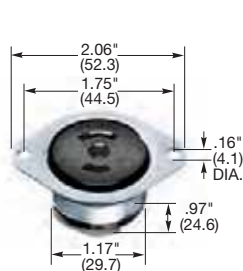

**HBL7596**



**HBL7598**

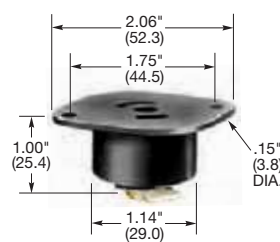

**HBL7596N**

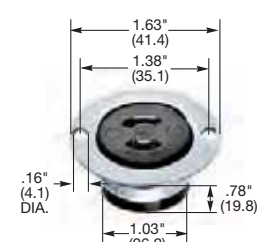

**HBL7468**

Dimensions in Inches (mm)



HBL7490V

### Weatherproof Accessories

Description	Catalog Number
Seal-tite® cover, black elastomer, for use with a HBL7465V plug when used with a HBL7464V connector body or a HBL7464V connector when used with a flanged inlet.	HBL7490V*
Seal-tite® cover, black elastomer, for use with a HBL7464V connector body and combination of HBL7465V plug and HBL7490V cover.	HBL7459V*
Closure cover for use with HBL7466 or HBL7467. Bead chain is nickel-plated.	HBL4890



HBL7459V

### Weatherproof Accessories

Description	Catalog Number
Seal-Tite® cover, black elastomer, for use with a HBL7594V plug when used with a HBL7593V connector body or a HBL7593V connector body when used with a flanged inlet.	HBL7495V*
Seal-Tite® cover, black elastomer, for use with a HBL7593V connector body and a combination of HBL7594V plug and HBL7495V cover.	HBL7440V*
Closure cover for use with HBL7595 or HBL7595N.	HBL4889



HBL4890

### Weatherproof Accessories

Description	Catalog Number
Seal-Tite® cover, black elastomer, for use with a HBL7485V or HBL7485 plug when used with a HBL7484V or HBL7484 connector body when used with a flanged inlet.	HBL7495V*
Seal-Tite® cover, black elastomer, for use with a HBL7484V or HBL7484 connector body and a combination of HBL7485V or HBL7485 plug and HBL7495V cover.	HBL7440V*
Closure cover for use with HBL7486 or HBL7486N.	HBL4889

*Note: \*IP55 suitability when installed and used properly with plug and connector body combinations.*



HBL7495V



HBL7440V



HBL4889

Dimensions in Inches (mm)

Twist-Lock® Devices  
**Insulgrip® 15 Ampere Plugs and Connector Bodies**  
 Featuring Integral VARI-SIZE® Cord Grip

Individually molded face for each blade configuration keeps debris out of plug interior

Roomy wiring chamber provides ample space for wiring

Powerful, cord grips clamp on individual conductors and outer cord jacket to prevent strain on terminals

Individual wiring terminals are completely enclosed in their own separate chambers

Ribbed nylon housing provides a secure grip that's impact and chemical resistant

Beveled housing prevents snagging when dragged across uneven surfaces

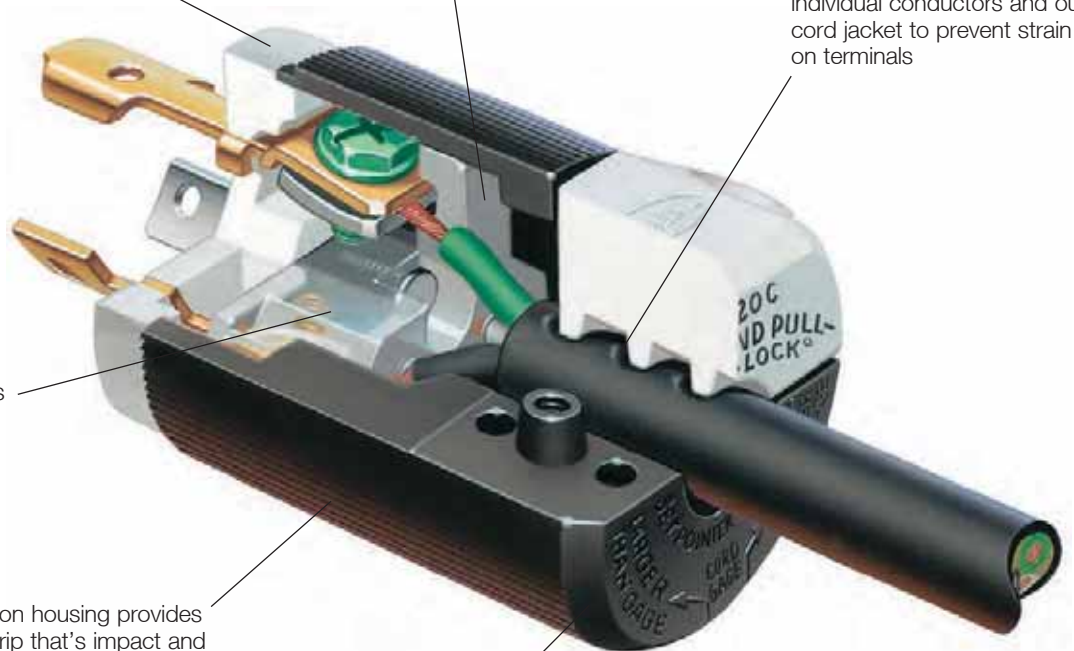

**HBL4770C**



Integral VARI-SIZE® insert adjusts to a wide range of cord sizes: .230"-.720" (5.8-18.3).



Multiple drive screw heads provide screwdriver versatility. Pocketed recess for cord grip screws deters slippage of the screwdriver.



VARI-SIZE® pointer set to "smaller than gauge" position. Cord diameter range is .230"-.360" (5.8-9.0). Accepts slotted and Phillips head drivers.



Transparent angled wiring entrance holes permit "straight in" conductor insertion and quick visual verification for terminations.



Catalog number is visible on the device while in use for easy identification.



Powerful cord grips clamp on individual conductors and outer cord jacket to prevent strain on terminations.

Twist-Lock® Devices  
**15 Ampere Duplex Twist-Lock® Receptacles**  
*Including Isolated Ground and Corrosion Resistant Devices*

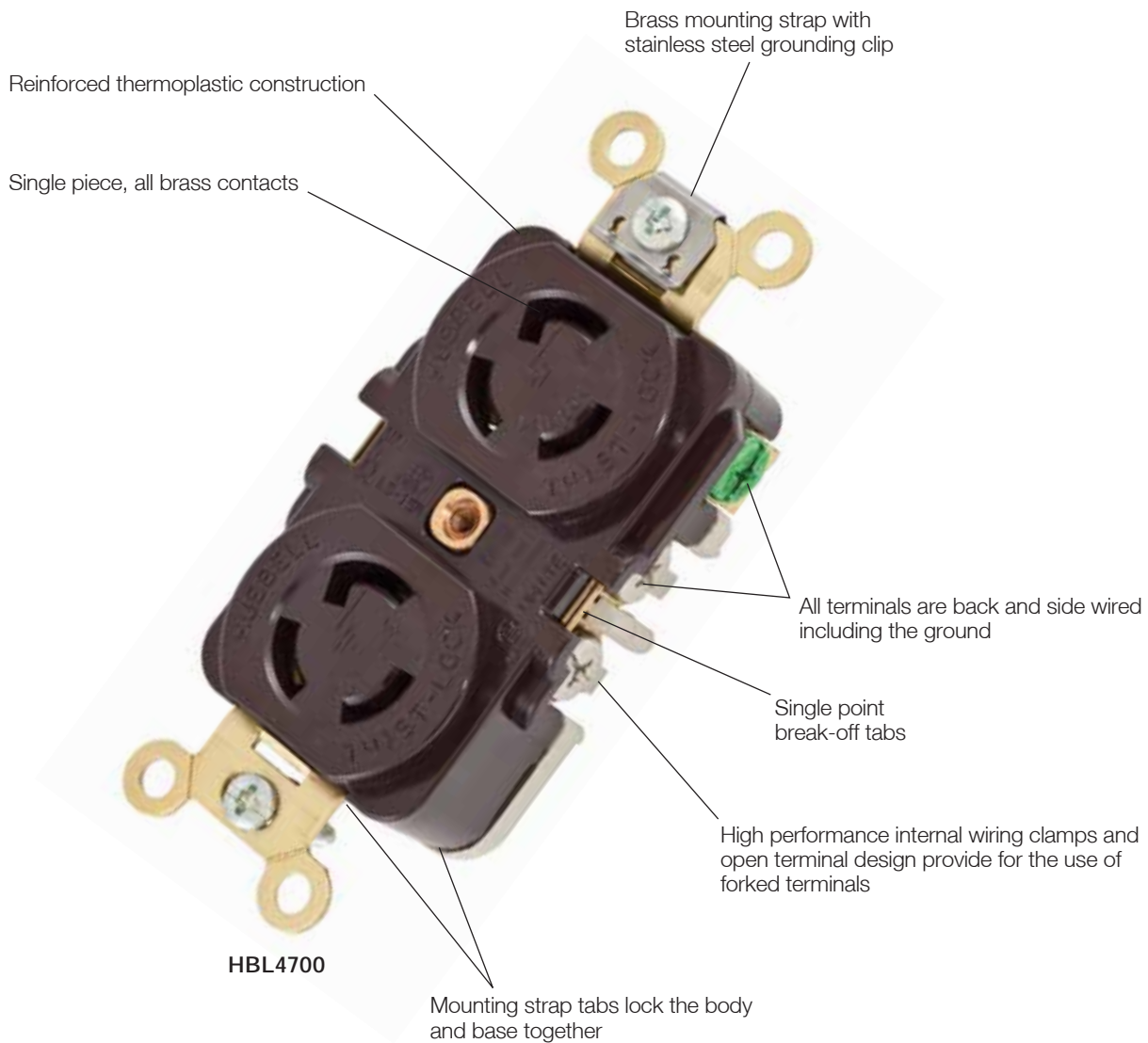

Hubbell Wiring Device-Kellems line of duplex Twist-Lock® receptacles are designed to deliver premium service and longer life. This rugged product design establishes a new standard for 15 amp locking receptacles. A reinforced thermoplastic top and base encapsulates the brass alloy contacts that are locked together for unequalled assembly strength. Wiring and installation is simplified with back and side wire terminations, integral wire restraints, and combination head screws. The integral split circuit capability offers flexibility. Available in 2 pole, 3 wire configurations including isolated ground and corrosion resistant versions.

#### Benefits

- High impact and heat resistance provides maximum safety and longer life.
- Superior spring characteristics for increased contact force, secure connections and longer life.
- High-conductivity, corrosion resistant material for reliable, low resistance to fault currents.
- Easy and reliable installation for stranded and solid wire.
- Features split circuit capability in the field.
- The assembly locks together to make the most abuse resistant receptacle ever.



**IP20**  
 SUITABILITY



**15A 125V**  
**NEMA L1-15P**  
 UL Listed  
 0.5 HP

## Plugs

Description	Cord Dia.	Catalog Number
Black and white nylon, polarized. Multiple drive screws.	.230"-.720" (5.8-18.3)	<b>HBL7545C</b>

Note: See page B-49 for accessories.



**HBL7545C**

## Flanged Inlets

Description	Catalog Number
Nylon casing, polarized, backwired, Multiple drive screws.	<b>HBL7524C</b>

Note: See page B-48 for accessories.



**15A 125V**  
**NEMA L1-15R**  
 UL Listed  
 0.5 HP

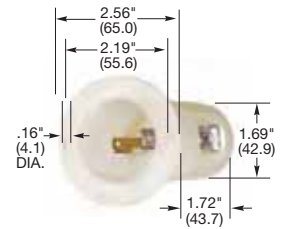

**HBL7524C**

## Connector Bodies

Description	Cord Dia.	Catalog Number
Black and white nylon. Multiple drive screws.	.230"-.720" (5.8-18.3)	<b>HBL7506C</b>

Note: See page B-49 for accessories.



**HBL7506C**

## Receptacles

Description	Catalog Number
Duplex, flush, black phenolic.	<b>HBL7540</b>
Single, flush, black phenolic.	<b>HBL7535</b>
Single, panel mount, 1 5/16" (49.2) centers, black phenolic.	<b>HBL7498</b>

Note: See pages B-48 and B-49 for accessories.

## Flanged Receptacles

Description	Catalog Number
Insulgrip nylon casing, backwired. Multiple drive screws.	<b>HBL7526C</b>
Metal flange, stainless steel casing, black phenolic, exposed terminals.	<b>HBL7526</b>

Note: See pages B-48 and B-49 for accessories.  
 Only receptacles and plugs are HP rated.  
 HP ratings are AC only.

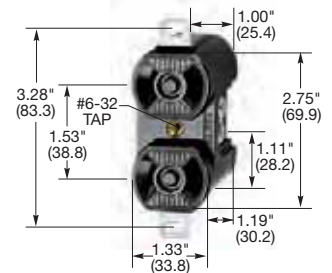

**HBL7540**

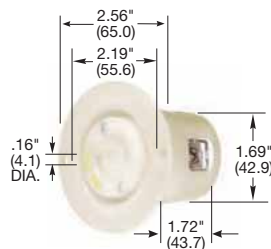

**HBL7526C**

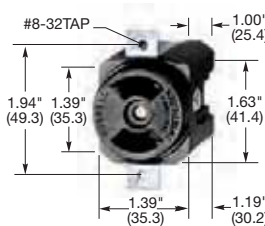

**HBL7498**

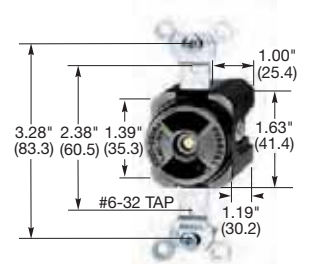

**HBL7535**

Dimensions in Inches (mm)



**HBL4720C**



**HBL4720CA**

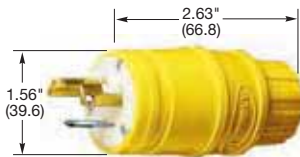

**HBL24W47**

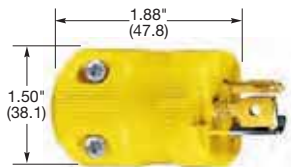

**HBL4723VY**

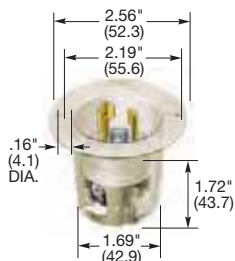

**HBL4716C**

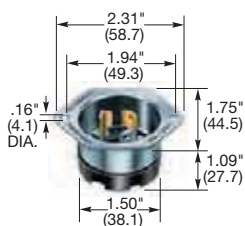

**HBL4716**

Dimensions in Inches (mm)

**IP20**  
 SUITABILITY



**15A 125V**  
 NEMA L5-15P  
 UL/CSA  
 0.5 HP



**15A 250V**  
 NEMA L6-15P  
 UL/CSA  
 1.5 HP



**15A 277V AC**  
 NEMA L7-15P  
 UL/CSA  
 2 HP

**Plugs**

Description	Cord Dia.	Catalog Number		
Insulgrip plug, black and white nylon. Multiple drive screws. Fed Spec WC596	.230"-.720" (5.8-18.3)	<b>HBL4720C</b>	<b>HBL4570C</b>	<b>HBL4770C</b>
All black nylon.	.230"-.720" (5.8-18.3)	<b>HBL4720CBK</b>	-	-
Insulgrip angle plug, 8 position angle, black and white nylon. Multiple drive screws.	.325"-.655" (8.3-16.6)	<b>HBL4720CA</b>	<b>HBL4570CA</b>	<b>HBL4770CA</b>
Insulgrip plug, corrosion resistant, yellow and white nylon. Multiple drive screws. Fed Spec WC596	.230"-.720" (5.8-18.3)	<b>HBL47CM20C</b>	<b>HBL45CM70C</b>	<b>HBL47CM70C</b>
Elastogrip® plug, yellow elastomer, dust tight.	300"-.655" (7.6-16.6)	<b>HBL2447</b>	-	-
Elastogrip plug, yellow elastomer, water/dust tight.	300"-.655" (7.6-16.6)	<b>HBL24W47</b>	-	-
Valise® plug, yellow nylon.	.220"-.660" (5.6-16.8)	<b>HBL4723VY</b>	<b>HBL4573VY</b>	<b>HBL4773VY</b>
Valise® plug, black nylon.	.220"-.660" (5.6-16.8)	<b>HBL4723VBK</b>	<b>HBL4573VBK</b>	<b>HBL4773VBK</b>

Note: See page B-49 for accessories.

**Flanged Inlets**

Description	Catalog Number		
Insulgrip flanged inlet, nylon casing, back wired.	<b>HBL4716C</b>	<b>HBL4586C</b>	<b>HBL4786C</b>
Stainless steel casing, brown phenolic.	<b>HBL4716*</b>	<b>HBL4586*</b>	<b>HBL4786*</b>
Corrosion resistant, stainless steel casing, yellow melamine.	<b>HBL47CM16*</b>	-	-

Note: See page B-48 for accessories.

HP ratings are AC only.

Only plugs are HP rated.

See page B-69 for technical information on Insulgrip devices.

\*These flanged inlets will not accept Valise® connector bodies.

Twist-Lock® Devices  
 15 Ampere, 125, 250 Volts and 277 Volts AC  
 2 Pole, 3 Wire Grounding



**IP20**  
 SUITABILITY



**15A 125V**  
 NEMA L5-15R  
 UL/CSA



**15A 250V**  
 NEMA L6-15R  
 UL/CSA



**15A 277V AC**  
 NEMA L7-15R  
 UL/CSA

## Connector Bodies

Description	Cord Dia.	Catalog Number		
Insulgrip connector body, black and white nylon. Multiple drive screws.	.230"-.720" (5.8-18.3)	<b>HBL4729C</b>	<b>HBL4579C</b>	<b>HBL4779C</b>
All black nylon.	.230"-.720" (5.8-18.3)	<b>HBL4729CBK</b>	-	-
Insulgrip connector body, 8 position angle, black and white nylon. Multiple drive screws.	.325"-.655" (8.3-16.6)	<b>HBL4729CA</b>	-	-
Insulgrip connector body, corrosion resistant, yellow and white nylon. Multiple drive screws.	.230"-.720" (5.8-18.3)	<b>HBL47CM29C</b>	<b>HBL45CM79C</b>	<b>HBL47CM79C</b>
Elastogrip connector body, yellow elastomer, dust tight.	.300"-.655" (7.6-16.6)	<b>HBL2547</b>	-	-
Elastogrip® connector body, yellow elastomer, water/dust tight.	.300"-.655" (7.6-16.6)	<b>HBL25W47**</b>	-	-
Valise® connector body, yellow nylon.	.220"-.660" (5.6-16.8)	<b>HBL4729VY</b>	<b>HBL4579VY</b>	<b>HBL4779VY</b>
Valise® connector body, black nylon.	.220"-.660" (5.6-16.8)	<b>HBL4729VBK</b>	<b>HBL4579VBK</b>	<b>HBL4779VBK</b>

Note: See page B-49 for accessories.

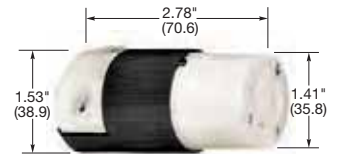

**HBL4729C**



**HBL25W47**



**HBL4729VY**

## Receptacles

Description	Catalog Number		
Duplex, flush, brown RTP face, back and side wired.	<b>HBL4700*</b>	<b>HBL4550*</b>	<b>HBL4750*</b>
Duplex, flush, ivory RTP face, back and side wired.	<b>HBL4700I*</b>	-	-
Duplex, ring terminal connection.	<b>HBL4700RT*</b>	<b>HBL4550RT*</b>	-
Duplex, isolated ground, flush, orange RTP face, back and side wired.	<b>IG4700A*</b>	<b>IG4550A*</b>	-
Duplex, corrosion resistant, yellow RTP face, back and side wired.	<b>HBL47CM00*</b>	-	-
Single, flush, black nylon face, back and side wired.	<b>HBL4710</b>	<b>HBL4560</b>	<b>HBL4760</b>
Same as HBL4760 without mounting screws, ears. Terminal screws backed out, back and side wired.	-	-	<b>HBL4760C</b>
Single, ring terminal connection.	<b>HBL4710RT</b>	<b>HBL4560RT</b>	-
Single, isolated ground, flush, orange nylon face, back and side wired.	<b>IG4710</b>	<b>IG4560</b>	-
Single, black nylon face mounted on a 4" (101.6) round box cover, back and side wired.	<b>HBL4711</b>	-	<b>HBL4761</b>
Single, panel mount, black nylon face, side wired only, 1.75" or 1.937" (44.5 or 49.2) mounting centers.	<b>HBL4713</b>	<b>HBL4563</b>	<b>HBL4763</b>

Note: See pages B-48 and B-49 for accessories.

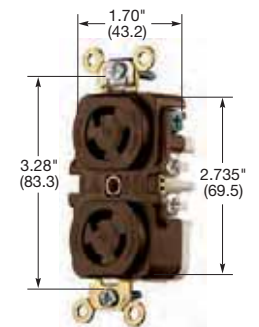

**HBL4700**

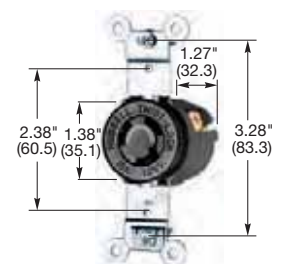

**HBL4710**

## Flanged Receptacles

Description	Catalog Number		
Insulgrip flanged receptacle, nylon casing, back wired.	<b>HBL4715C</b>	<b>HBL4585C</b>	<b>HBL4785C</b>
Stainless steel casing, brown phenolic.	<b>HBL4715</b>	<b>HBL4585</b>	<b>HBL4785</b>
Corrosion resistant, stainless steel casing, yellow melamine.	<b>HBL47CM15</b>	-	-

Note: See pages B-48 and B-49 for accessories.

HP ratings are AC only.

RTP is an abbreviation for reinforced thermoplastic polyester.

See section M for additional information on isolated ground devices.

\*Supplied with break-off tabs for split circuit wiring.

\*\*Watertight connector body IP55 suitability when closure plug is inserted or when installed and used properly with watertight plug.



**HBL4715C**

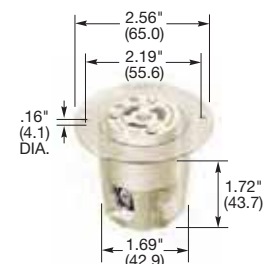

**HBL4715**

Dimensions in Inches (mm)

# Twist-Lock® Devices 20 and 30 Ampere Plugs and Connector Bodies

Features and Benefits

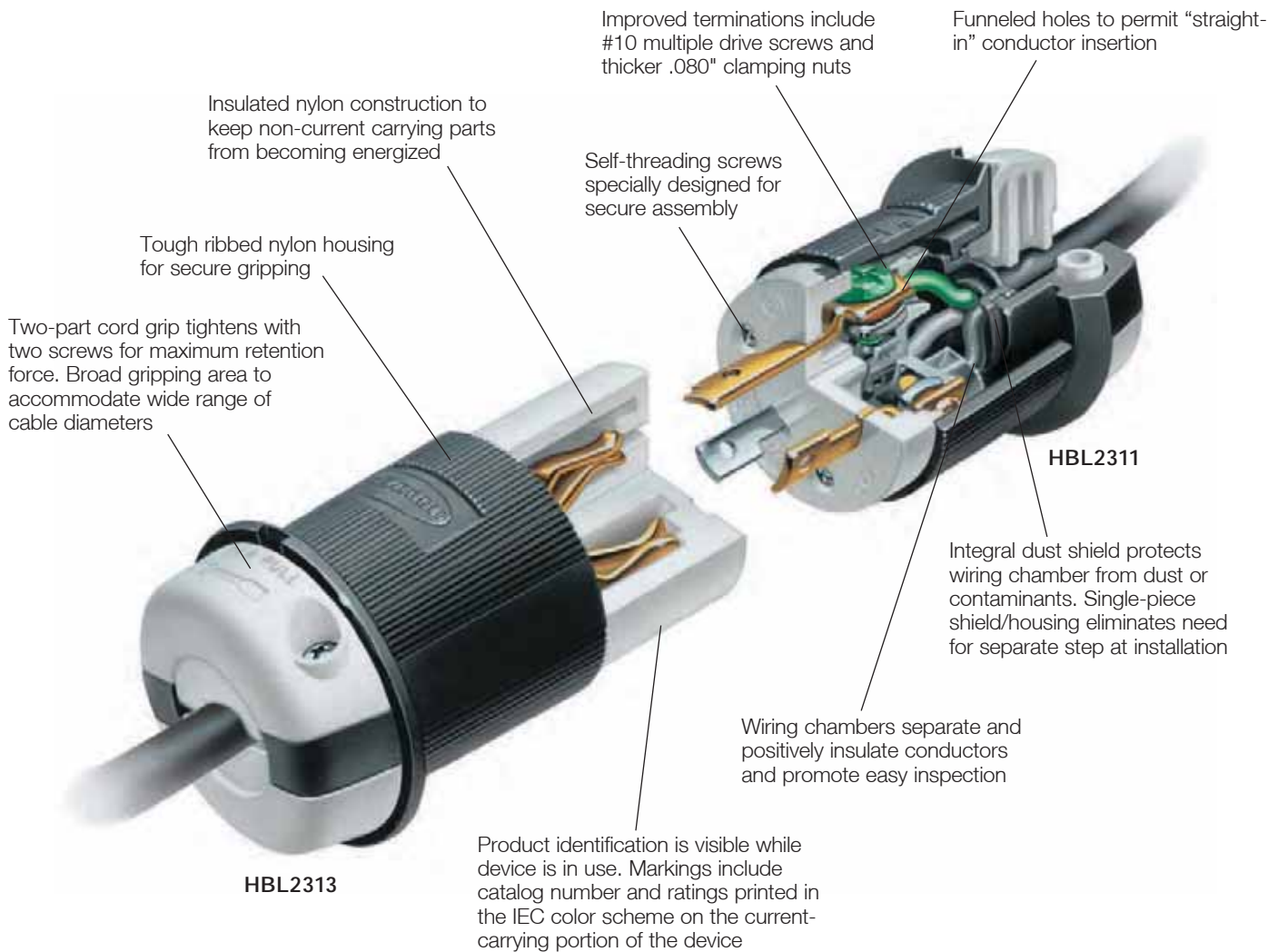

Our 20 and 30 amp Insulgrip® plugs and connectors maintain Hubbell's classic integrity, solid construction and safety features that make these devices the 'industry standard'.

Insulgrip's cord gripping design clamps the conductors, not just the cable jacket, making it the industry's most powerful cord grip. The restyled cord grips provide a clean, one-piece look, and actually make it stronger.

Insulgrip's design guards against contamination. The nylon body and housing of the plugs and connectors are resistant to industrial chemicals, solvents and hydrocarbons. The face of each plug is molded specific

to the blade configuration, eliminating holes that attract debris. And finally, our dust shield provides additional protection from contamination.

Additional features that make Insulgrip the industry standard are our improved contacts that provide better terminations, an exclusive double rivet design for the female contacts and an easy to read identification system.

The Hubbell Twist-Lock® line of plugs and connectors remain the broadest in the industry. Hubbell has you covered – proven performance, innovation and selection.

# Twist-Lock® Devices The Standard for Locking Receptacles

Features and Benefits

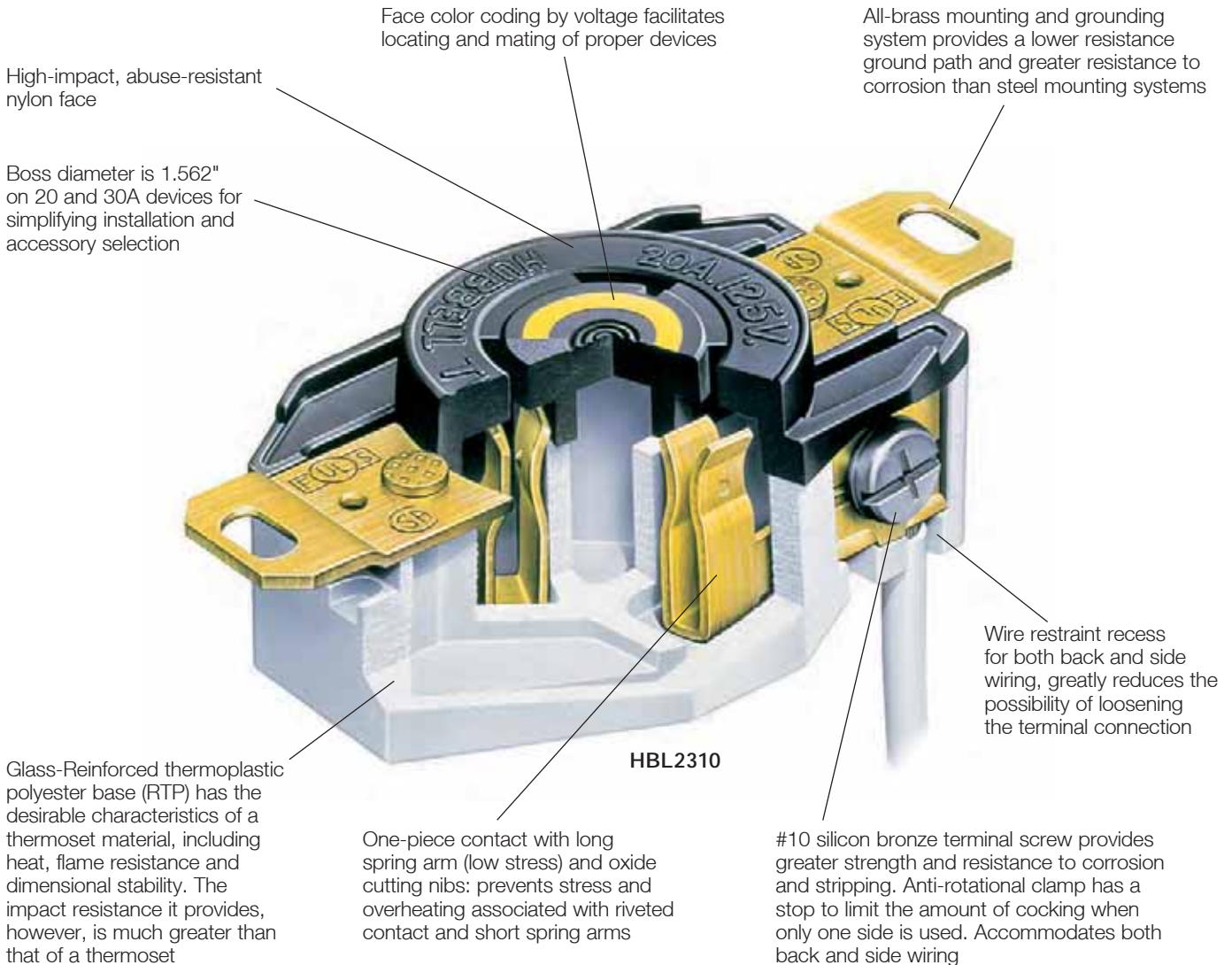

Twist-Lock® receptacles combine functional design features, unparalleled quality to deliver pace-setting performance.

The high-impact nylon face of each Hubbell Twist-Lock receptacle has a colored ring. Keyed to an internationally recognized color coding scheme, this ring enables mating devices to be matched quickly. It's just one more example of user-oriented thinking at Hubbell.

The terminals in each Hubbell Twist-Lock receptacle are mechanically and electrically the finest available. These terminals incorporate unique design features to contain and hold conductors, including an external back wiring "wraparound" clamp, a wire restraint recess and more.

The materials used in every receptacle are of the highest quality. The all brass mounting system provides a safer, lower resistance ground path than those made of steel. The thick wall base is constructed of an engineered thermoplastic to offer the benefits of a thermoset, yet with much greater impact resistance.

Hubbell Twist-Lock Receptacles: Voltage color coding on the outside. Proven designs and quality materials on the inside. Any way you look at them, they are the standard of the industry.



# Twist-Lock® Devices Watertight Safety-Shroud® Twist-Lock® System

Features and Benefits



Note: Works with Mechanical Interlocks, see page B-39 for additional information.



### TPE Gland Seal

Assorted glands accommodate a wide range of cord sizes from #16-3 Type SJ to #8-5 Type S, SO



### Panel or Box Mount Receptacles and Inlets

- High impact, thermoplastic housing for heavy-duty industrial environments.
- Catalog number and color-coded voltage rating are easily visible when in use.
- Stainless Steel 302/304, #10 multiple drive head mounting screws provide corrosion resistance.
- Mounting screw recesses minimize screwdriver slippage.
- Lockout/tagout hole on inlets allow compliance to OSHA regulation 29 CFR 1910.147.
- TPE closure cap provided with inlets for environmental seal when not in use.
- Accepts all mating NEMA locking plugs and most connector bodies, allowing interchangeability with existing devices.



### Spring-Loaded Cover

One-step push-to-close spring-loaded cover with latch allows for fast opening and closing of lift cover. Result: environmental sealing is assured



### Safety-Shroud

- Virtually eliminates bent and broken plug blades, leading to longer equipment life.
- Extends life of mating receptacles by eliminating damage caused by insertion of bent blades.
- Extra protection for personnel by significantly reducing chance of inadvertent contact with blades when connecting or disconnecting energized receptacles and connector bodies.
- Reduces exposure to arcing when connecting or disconnecting plugs under load.
- Compliance with California Code of Regulations, Title 8, Article 51, subsection 2510.7(b), which requires shrouding for devices exceeding 300 volts.
- Lockout/tagout hole allows compliance with OSHA regulation 29 CFR 1910.147.
- Sealing gland and thermoplastic guard assure sealing when fully connected.



# Twist-Lock® Devices Safety-Shroud® Twist-Lock® System

Features and Benefits



Note: All screws are #10 multiple drive head.



## Safety-Shroud® Plug Features and Benefits

- Mates with most NEMA locking connector bodies.
- Virtually eliminates bent and broken plug blades.
- Provides protection for personnel by reducing chance of inadvertent contact with blades when connecting or disconnecting energized devices.
- Reduces exposure to arcing when connecting or disconnecting under load.
- Extends life of mating receptacles by eliminating damage caused by insertion of bent blades.
- Complies with California Code of Regulation, which requires shrouding for devices exceeding 300 volts.
- Lockout/tagout hole allows compliance to OSHA regulation 29 CFR 1910.147.
- Allows engagement with Mechanical Interlock Enclosure which virtually prevents make and break under load.

## Safety-Shroud® Twist-Lock® Receptacles (Recommended Installations)

The Safety-Shroud Twist-Lock single gang receptacles were designed to mount in virtually all standard and FS/FD type boxes, allowing easy conversion of existing NEMA locking receptacles to Safety-Shroud Twist-Lock Receptacles.

The semi-flush receptacles install in (RACO type 242/255) boxes, with 1/2 raised 2-gang device mount covers (RACO type 778/841) and a 2-gang FD type box. Standard 4" and 4 1/16" square boxes 2 1/8" deep.



# Twist-Lock® Devices Compatibility and Environmental Protection Chart



Watertight Safety-Shroud®, Safety-Shroud® and NEMA Devices

## Twist-Lock® Receptacles



## Twist-Lock® Connector Bodies



## Twist-Lock® Plugs

 Watertight Safety-Shroud	YES Type 4X, Type 12	YES Type 4X, Type 12K	YES Type 1	NO	NO	YES Type 4X, Type 12	YES Type 1
 Safety-Shroud	YES Type 1	YES Type 1	YES Type 1	NO	NO	YES Type 1	YES Type 1
 Insulgrip	YES Type 1	NO	YES Type 1	YES Type 3R	YES Type 1	YES Type 1	YES Type 1

## Twist-Lock® Inlets

 NEMA	NA	NA	NA	NA	NA	NO	YES Type 1
 Watertight Safety-Shroud	NA	NA	NA	NA	NA	YES Type 4X, Type 12	YES Type 1

- Type 1    Indoor
- Type 3R    Raintight
- Type 4X    Hose-directed water and corrosion resistant
- Type 12    Dust tight, drip-proof without knockouts
- Type 12K    Dust tight, drip-proof with knockouts
- YES    Interchangeable
- NO    Does not interchange
- NA    Not Applicable

Note: See Technical section for full description of enclosure types.



Twist-Lock® Devices  
**20 Ampere, 250 Volts**  
*2 Pole, 2 Wire, Non-Grounding*



**20A 250V**  
**NEMA L2-20P**  
 UL Listed  
 2 HP

### Plugs

Description	Cord Dia.	Catalog Number
Black and white nylon, polarized. Multiple drive screws.	.220"-.720" (5.6-18.3)	<b>HBL7102C</b>

*Note: See page B-49 for accessories.*



**HBL7102C**

### Flanged Inlets

Description	Catalog Number
Nylon casing, back wired, polarized. Multiple drive screws.	<b>HBL8815C</b>

*Note: See page B-48 for accessories.*

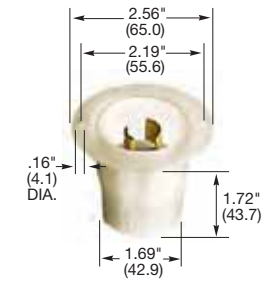

**HBL8815C**



**20A 250V**  
**NEMA L2-20R**  
 UL Listed  
 2 HP

### Connector Bodies

Description	Cord Dia.	Catalog Number
Black and white nylon. Multiple drive screws.	.220"-.720" (5.6-18.3)	<b>HBL7101C</b>

*Note: See page B-49 for accessories.*



**HBL7101C**

### Receptacles

Description	Catalog Number
Single, black phenolic.	<b>HBL7210B</b>
Single, mounted on 4" (101.6) round box cover, black phenolic.	<b>HBL7217B</b>

*Note: See pages B-48 and B-49 for accessories.*

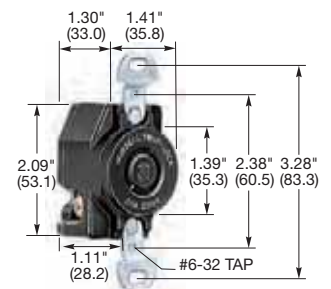

**HBL7210B**

### Flanged Receptacles

Description	Catalog Number
Insulgrip nylon casing, back wired. Multiple drive screws.	<b>HBL8809C</b>
Metal flange, stainless steel casing, black phenolic, exposed terminals.	<b>HBL3226</b>

*Note: See pages B-48 and B-49 for accessories.*  
 Only receptacles and plugs are HP rated.  
 HP ratings are AC only.

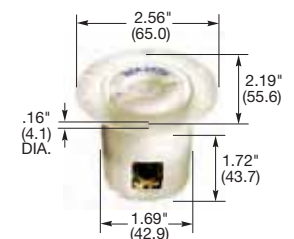

**HBL8809C**



**HBL3226**

*Dimensions in Inches (mm)*

# Twist-Lock® Devices

## 20 Ampere, 125, 250 Volts and 277 Volts AC

2 Pole, 3 Wire Grounding

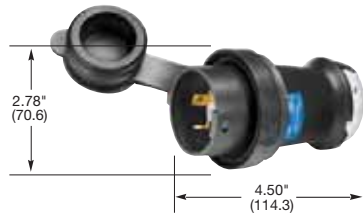

**HBL2321SW**



**HBL2321S**



**HBL2311**

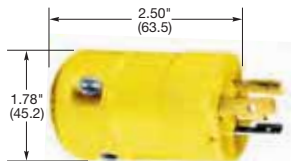

**HBL2311VY**



**HBL2325SW**

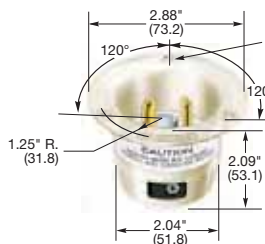

**HBL2315**

Dimensions in Inches (mm)

### Plugs

#### Watertight Safety-Shroud®

IP66 SUITABILITY    UL Type 4x, 12

Description	Cord Dia.	Catalog Number		
Black Valox® housing, white Valox® clamps.	.360"-.930" (9-24)	<b>HBL2311SW</b>	<b>HBL2321SW</b>	<b>HBL2331SW</b>

#### Safety-Shroud®

IP20 SUITABILITY

Description	Cord Dia.	Catalog Number		
Black and white nylon body, white Valox® shroud. Can be used with the Insulgrip Connector Bodies.	.360"-.930" (9-24)	<b>HBL2311S</b>	<b>HBL2321S</b>	<b>HBL2331S</b>

Note: See page B-40 for accessories.

#### Insulgrip®

IP20 SUITABILITY

Description	Cord Dia.	Catalog Number		
Black and white nylon.	.360"-.930" (9-24)	<b>HBL2311</b>	<b>HBL2321</b>	<b>HBL2331</b>
Corrosion resistant, yellow nylon.	.360"-.930" (9-24)	<b>HBL23CM11</b>	<b>HBL23CM21</b>	-
All black nylon.	.360"-.930" (9-24)	<b>HBL2311BK</b>	<b>HBL2321BK</b>	-
Cord clamps with removable inserts. All black nylon.	.360"-.930" (9-24)	<b>HBL2311EBK</b>	<b>HBL2321EBK</b>	-

Note: See page B-51 for accessories.

#### Valise®

IP20 SUITABILITY



Description	Cord Dia.	Catalog Number		
Yellow nylon.	.325"-.720" (8.26-18.3)	<b>HBL2311VY</b>	<b>HBL2321VY</b>	<b>HBL2331VY</b>
Corrosion resistant, yellow nylon.	.325"-.720" (8.26-18.3)	<b>HBL23CM11V</b>	-	-
Black nylon.	.325"-.720" (8.26-18.3)	<b>HBL2311VBK</b>	<b>HBL2321VBK</b>	<b>HBL2331VBK</b>

Note: See page B-51 for accessories.

### Flanged Inlets

#### Watertight Safety-Shroud®

IP66 SUITABILITY    UL Type 4x, 12

Description	Catalog Number		
Gray Valox® housing and flange.	<b>HBL2315SW</b>	<b>HBL2325SW</b>	<b>HBL2335SW</b>
Gray Valox® housing and flange, reverse service (Not shown).	-	<b>HBL2325SWR</b>	-

Note: See page B-54 for accessories.

#### Insulgrip®

IP20 SUITABILITY

Description	Catalog Number		
Nylon casing, back wired.	<b>HBL2315</b>	<b>HBL2325</b>	<b>HBL2335</b>

Note: See page B-50 for accessories.

See pages B-69 and B-70 for technical information on Twist-Lock and Watertight Safety-Shroud devices.

See page B-74 for technical information on Valise® plugs and connectors.

HBLMITL - For use with Watertight Safety-Shroud receptacles, see page B-39.



Valox® is a trademark of SABIC Innovative Plastics, acquired from General Electric Company.

Twist-Lock® Devices  
20 Ampere, 125, 250 Volts and 277 Volts AC  
2 Pole, 3 Wire Grounding



## Connector Bodies

Watertight Safety-Shroud®		IP66 SUITABILITY		UL Type 4x, 12
Description	Cord Dia.	Catalog Number		
Black Valox® housing, white Valox® clamps.	.360"-.930" (9-24)	HBL2313SW	HBL2323SW	HBL2333SW

Insulgrip®		IP20 SUITABILITY		
Description	Cord Dia.	Catalog Number		
Black and white nylon.	.360"-.930" (9-24)	HBL2313	HBL2323	HBL2333
Corrosion resistant, yellow nylon.	.360"-.930" (9-24)	HBL23CM13	HBL23CM23	-
All black nylon.	.360"-.930" (9-24)	HBL2313BK	HBL2323BK	-
Cord clamps with removable inserts. All black nylon.	.360"-.930" (9-24)	HBL2313EBK	HBL2323EBK	-

Note: See page B-51 for accessories.

Valise®		IP20 SUITABILITY		
Description	Cord Dia.	Catalog Number		
Yellow nylon.	.325"-.720" (8.26-18.3)	HBL2313VY	HBL2323VY	-
Black nylon.	.325"-.720" (8.26-18.3)	HBL2313VBK	HBL2323VBK	HBL2333VBK

Note: See page B-51 for accessories.

## Receptacles

Watertight Safety-Shroud®		IP66 SUITABILITY		UL Type 4x, 12
Description	Catalog Number			
Gray Valox® housing and flange, back wired.	HBL2310SW HBL2320SW HBL2330SW			

Note: See page B-54 for accessories.

Safety-Shroud® Twist-Lock®		IP20 SUITABILITY		
Description	Catalog Number			
Gray Valox® angle housing, one gang, back wired.	HBL2310AR HBL2320AR HBL2330AR			
Gray Valox® surface mounting, one gang, back wired.	HBL2310SR HBL2320SR HBL2330SR			
Gray Valox® semi-flush, two gang, back wired.	HBL2310SR2 HBL2320SR2 HBL2330SR2			

Note: See page B-54 for accessories.

Single Flush Receptacles		IP20 SUITABILITY		
Description	Catalog Number			
Black nylon face, back and side wired.	HBL2310 HBL2320 HBL2330			
Blue nylon face, back and side wired.	HBL2310M7 HBL2320M4 -			
Isolated ground, orange nylon face, back and side wired.	IG2310 IG2320 -			
Corrosion resistant, yellow nylon face, back and side wired.	HBL23CM10 - -			
Ring terminal connection.	HBL2310RT HBL2320RT -			

Note: See page B-50 for accessories.

Insulgrip® Flanged Receptacles				
Description	Catalog Number			
Nylon casing, back wired.	HBL2316 HBL2326 HBL2336			

Note: See page B-50 for accessories.

Valox® is a trademark of SABIC Innovative Plastics, acquired from General Electric Company.



HBL2323SW



HBL2313

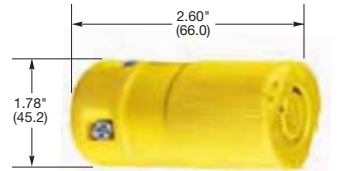

HBL2313VY

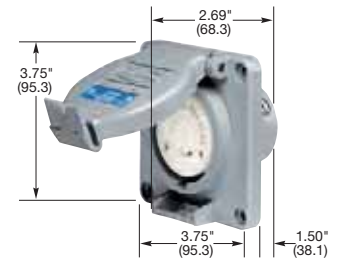

HBL2320SW



HBL2320AR

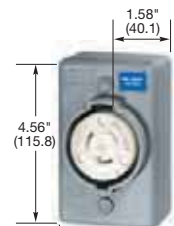

HBL2320SR

Dimensions in Inches (mm)

Twist-Lock® Devices  
 20 Ampere, 125/250, 3Ø 250 and 3Ø 480 Volts AC  
 3 Pole, 4 Wire Grounding

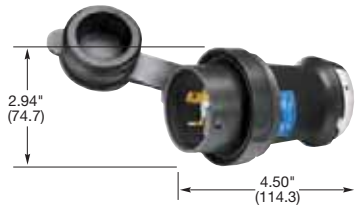

HBL2421SW



HBL2421S



HBL2411

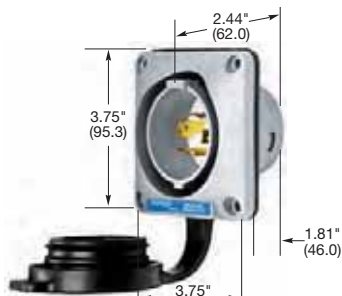

HBL2425SW

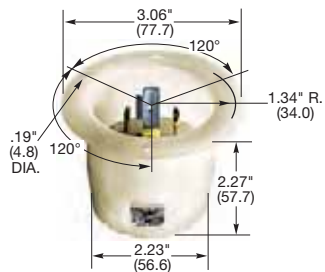

HBL2415

Dimensions in Inches (mm)

Plugs

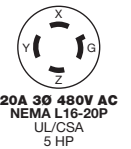

Watertight Safety-Shroud®

IP66 SUITABILITY UL Type 4x, 12

Description	Cord Dia.	Catalog Number		
Black Valox® housing, white Valox® clamps.	.350"-1.150" (9-29)	HBL2411SW	HBL2421SW	HBL2431SW

Safety-Shroud®

IP20 SUITABILITY

Description	Cord Dia.	Catalog Number		
Black and white nylon body, white Valox® shroud. Can be used with the Insulgrip Connector Bodies.	.350"-1.150" (9-29)	HBL2411S	HBL2421S	HBL2431S

Note: See page B-40 for accessories.

Insulgrip®

IP20 SUITABILITY

Description	Cord Dia.	Catalog Number		
Black and white nylon.	.350"-1.150" (9-29)	HBL2411	HBL2421	HBL2431
Corrosion resistant, yellow nylon.	.350"-1.150" (9-29)	HBL24CM11	HBL24CM21	HBL24CM31
All black nylon.	.350"-1.150" (9-29)	HBL2411BK	-	-

Note: See page B-53 for accessories.

Flanged Inlets

Watertight Safety-Shroud®

IP66 SUITABILITY UL Type 4x, 12

Description	Catalog Number		
Gray Valox® housing and flange.	HBL2415SW	HBL2425SW	HBL2435SW

Note: See page B-54 for accessories.

Insulgrip®

IP20 SUITABILITY

Description	Catalog Number		
Nylon casing, back wired.	HBL2415	HBL2425	HBL2435

Note: See page B-52 for accessories.

See pages B-69 and B-70 for technical information on Twist-Lock and Watertight Safety-Shroud devices.



HBLMITL - For use with Watertight Safety-Shroud receptacles, see page B-39.

Valox® is a trademark of SABIC Innovative Plastics, acquired from General Electric Company.

Twist-Lock® Devices  
 20 Ampere, 125/250, 3Ø 250 and 3Ø 480 Volts AC  
 3 Pole, 4 Wire Grounding

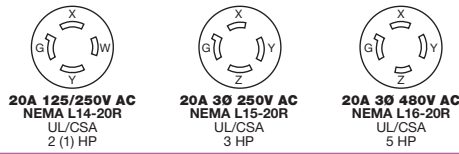

**Connector Bodies**

**Watertight Safety-Shroud®**

IP66 SUITABILITY    UL Type 4x, 12

Description	Cord Dia.	Catalog Number		
Black Valox® housing, white Valox® clamps.	.350"-1.150" (9-29)	HBL2413SW	HBL2423SW	HBL2433SW

**Insulgrip®**

IP20 SUITABILITY

Description	Cord Dia.	Catalog Number		
Black and white nylon.	.350"-1.150" (9-29)	HBL2413	HBL2423	HBL2433
Corrosion resistant, yellow nylon.	.350"-1.150" (9-29)	HBL24CM13	HBL24CM23	HBL24CM33
All black nylon.	.350"-1.150" (9-29)	HBL2413BK	-	-

Note: See page B-53 for accessories.



HBL2423SW



HBL2413

**Receptacles**

**Watertight Safety-Shroud®**

IP66 SUITABILITY    UL Type 4x, 12

Description	Catalog Number		
Gray Valox® housing and flange, back wired.	HBL2410SW	HBL2420SW	HBL2430SW

Note: See page B-54 for accessories.

**Safety-Shroud® Twist-Lock®**

IP20 SUITABILITY

Description	Catalog Number		
Gray Valox® angle housing, one gang, back wired.	HBL2410AR	HBL2420AR	HBL2430AR
Gray Valox® surface mounting, one gang, back wired.	HBL2410SR	HBL2420SR	HBL2430SR
Gray Valox® semi-flush, two gang, back wired.	HBL2410SR2	HBL2420SR2	HBL2430SR2

Note: See page B-54 for accessories.



HBL2420SW

**Single Flush Receptacles**

IP20 SUITABILITY

Description	Catalog Number		
Black nylon face, back and side wired.	HBL2410	HBL2420	HBL2430
Isolated ground, orange nylon face, back and side wired.	IG2410	IG2420	-
Ring terminal connection.	HBL2410RT	HBL2420RT	-

Note: See page B-52 for accessories.



HBL2420AR

**Insulgrip® Flanged Receptacles**

Description	Catalog Number		
Nylon casing, back wired.	HBL2416	HBL2426	HBL2436

Note: See page B-52 for accessories.



HBL2416

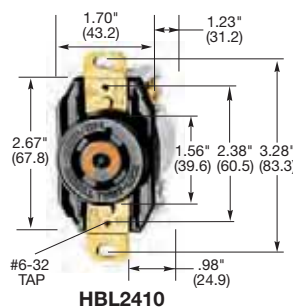

HBL2410

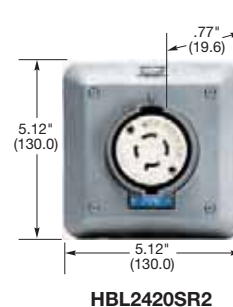

HBL2420SR2



HBL2420SR

Valox® is a trademark of SABIC Innovative Plastics, acquired from General Electric Company.

Dimensions in Inches (mm)

Twist-Lock® Devices  
**20 Ampere, 347, 480, 600 and 125/250 Volts AC**  
 2 Pole, 3 Wire Grounding and 3 Pole, 3 Wire Non-Grounding



**HBL2341**

**Plugs**

Description	Cord Dia.	Catalog Number			
Black and white nylon.	.360"-.930" (9-24)	<b>HBL3721</b>	<b>HBL2341</b>	<b>HBL2351</b>	-
Black and white nylon (Not shown).	.300"-1.050" (7.6-26.7)	-	-	-	<b>HBL2361</b>

Note: See page B-51 for accessories.

**IP20**  
SUITABILITY



**20A 347V AC**  
NEMA L24-20P  
UL/CSA



**20A 480V AC**  
NEMA L8-20P  
UL/CSA  
3 HP



**20A 600V AC**  
NEMA L9-20P  
UL/CSA



**20A 125/250V AC**  
NEMA L10-20P  
UL/CSA  
2 (1) HP

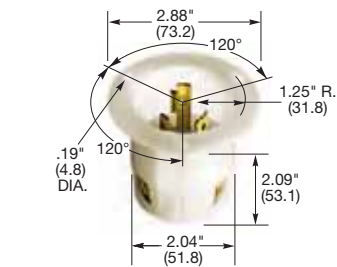

**HBL2345**

**Flanged Inlets**

Description	Catalog Number			
Nylon casing, back wired.	<b>HBL3725</b>	<b>HBL2345</b>	<b>HBL2355</b>	<b>HBL2365</b>

Note: See page B-50 for accessories.

**IP20**  
SUITABILITY



**20A 347V AC**  
NEMA L24-20R  
UL/CSA



**20A 480V AC**  
NEMA L8-20R  
UL/CSA  
3 HP



**20A 600V AC**  
NEMA L9-20R  
UL/CSA



**20A 125/250V AC**  
NEMA L10-20R  
UL/CSA  
2 (1) HP

**Connector Bodies**

Description	Cord Dia.	Catalog Number			
Black and white nylon.	.360"-.930" (9-24)	<b>HBL3723</b>	<b>HBL2343</b>	<b>HBL2353</b>	-
Black and white nylon (Not shown).	.300"-1.050" (7.6-26.7)	-	-	-	<b>HBL2363</b>

Note: See page B-51 for accessories.



**HBL2343**

**Single Flush Receptacles**

Description	Catalog Number			
Black nylon face, back and side wired.	<b>HBL3720</b>	<b>HBL2340</b>	<b>HBL2350</b>	<b>HBL2360</b>
Watertight Safety-Shroud®, gray Valox® housing and flange, back and side wired, (Not shown).	-	<b>HBL2340SW</b>	-	-
Isolated ground, orange nylon face, back and side wired.	-	<b>IG2340</b>	-	-

Note: See page B-50 for accessories.

**Flanged Receptacles**

Description	Catalog Number			
Nylon casing, back wired.	<b>HBL3726</b>	<b>HBL2346</b>	<b>HBL2356</b>	<b>HBL2366</b>

Note: See page B-50 for accessories.

See page B-69 for technical information.

See page B-37 for switched enclosure.

See page B-40 for Add-A-Shroud® kit. For use with connector bodies.

Only receptacles and plugs up to 480V AC are HP rated.

HP ratings are AC only.

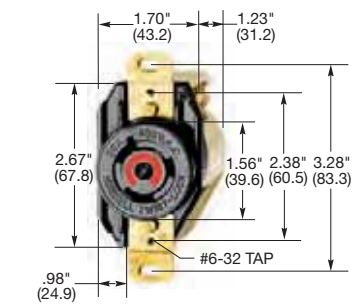

**HBL2340**

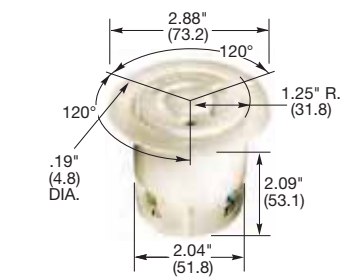

**HBL2346**

Dimensions in Inches (mm)

Valox® is a trademark of SABIC Innovative Plastics, acquired from General Electric Company.

Twist-Lock® Devices  
 20 Ampere, 3ØY 120/208, 277/480 and 347/600 Volts AC  
 4 Pole, 4 Wire Non-Grounding



**IP20**  
SUITABILITY



**20A 3ØY  
120/208V AC**  
NEMA L18-20P  
UL Listed  
2 HP



**20A 3ØY  
277/480V AC**  
NEMA L19-20P  
UL Listed  
5 HP



**20A 3ØY  
347/600V AC**  
NEMA L20-20P  
UL Listed

## Plugs

Description	Cord Dia.	Catalog Number		
Black and white nylon.	.350"-1.150" (9-29)	<b>HBL2441</b>	<b>HBL2451</b>	<b>HBL2461</b>

Note: See page B-53 for accessories.



**HBL2441**

## Flanged Inlets

Description	Catalog Number		
Nylon casing, back wired.	<b>HBL2445</b>	<b>HBL2455</b>	<b>HBL2465</b>

Note: See page B-52 for accessories.

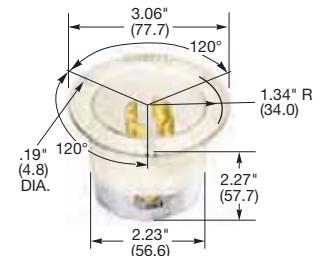

**HBL2445**

**IP20**  
SUITABILITY



**20A 3ØY  
120/208V AC**  
NEMA L18-20R  
UL Listed  
2 HP



**20A 3ØY  
277/480V AC**  
NEMA L19-20R  
UL Listed  
5 HP



**20A 3ØY  
347/600V AC**  
NEMA L20-20R  
UL Listed

## Connector Bodies

Description	Cord Dia.	Catalog Number		
Black and white nylon.	.350"-1.150" (9-29)	<b>HBL2443</b>	<b>HBL2453</b>	<b>HBL2463</b>

Note: See page B-53 for accessories.



**HBL2443**

## Single Flush Receptacles

Description	Catalog Number		
Black nylon face, back and side wired.	<b>HBL2440</b>	<b>HBL2450</b>	<b>HBL2460</b>

Note: See page B-52 for accessories.

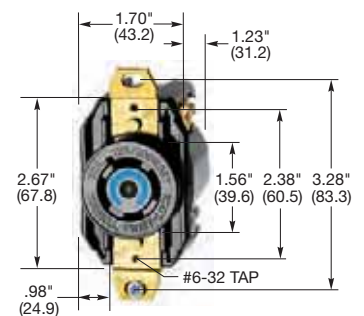

**HBL2440**

## Flanged Receptacles

Description	Catalog Number		
Nylon casing, back wired.	<b>HBL2446</b>	<b>HBL2456</b>	<b>HBL2466</b>

Note: See page B-52 for accessories.

See page B-69 for technical information.

See page B-37 for switched enclosure.

See page B-40 for Add-A-Shroud® kit. For use with connector bodies.

Only receptacles and plugs up to 480V AC are HP rated.

HP ratings are AC only.

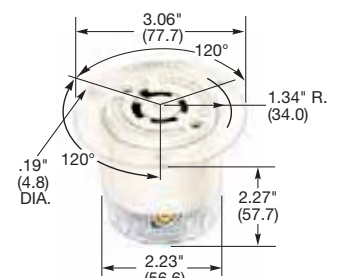

**HBL2446**

Dimensions in Inches (mm)



HBL2511SW



HBL2511S

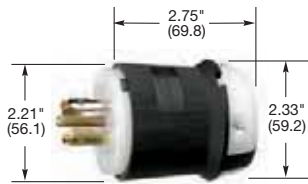

HBL2511



HBL2515SW

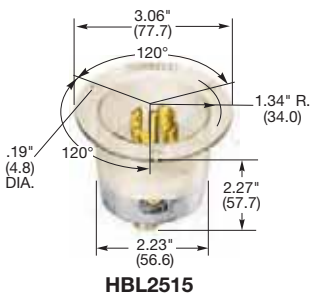

HBL2515

Dimensions in Inches (mm)

## Plugs



### Watertight Safety-Shroud®

Description	Cord Dia.	Catalog Number	IP66 SUITABILITY	UL Type 4x, 12
Black Valox® housing, white Valox® clamps.	.350"-1.150" (9-29)	HBL2511SW	-	-

### Safety-Shroud®

Description	Cord Dia.	Catalog Number	IP20 SUITABILITY
Black and white nylon body, white Valox® shroud. Can be used with the Insulgrip Connector Bodies.	.350"-1.150" (9-29)	HBL2511S	-

Note: See page B-40 for accessories.

### Insulgrip®

Description	Cord Dia.	Catalog Number	IP20 SUITABILITY
Black and white nylon.	.350"-1.150" (9-29)	HBL2511 HBL2521 HBL2531	-
All black nylon.	.350"-1.150" (9-29)	HBL2511BK	-
Corrosion resistant, yellow nylon.	.350"-1.150" (9-29)	HBL25CM11	-
Black and white for flat cable.	.350"-1.150" (9-29)	HBL2511FC	-

Note: See page B-53 for accessories.

## Flanged Inlets

### Watertight Safety-Shroud®

Description	Catalog Number	IP66 SUITABILITY	UL Type 4x, 12
Gray Valox® housing and flange.	HBL2515SW	-	-

Note: See page B-52 for accessories.

### Insulgrip®

Description	Catalog Number	IP20 SUITABILITY
Nylon casing, back wired.	HBL2515 HBL2525 HBL2535	-

Note: See page B-52 for accessories.

See pages B-69 and B-70 for technical information on Twist-Lock and Watertight Safety-Shroud devices.

HBLMITL - For use with Watertight Safety-Shroud receptacles, see page B-39.



Valox® is a trademark of SABIC Innovative Plastics, acquired from General Electric Company.



Twist-Lock® Devices  
 20 Ampere, 3ØY 120/208, 277/480 and 347/600 Volts AC  
 4 Pole, 5 Wire Grounding



**Connector Bodies**

**Watertight Safety-Shroud®** IP66 SUITABILITY UL Type 4x, 12

Description	Cord Dia.	Catalog Number		
Black Valox® housing, white Valox® clamps.	.350"-1.150" (9-29)	<b>HBL2513SW</b>	-	-



**HBL2513SW**

**Insulgrip®** IP20 SUITABILITY

Description	Cord Dia.	Catalog Number			
Black and white nylon.	.350"-1.150" (9-29)	<b>HBL2513</b>	<b>HBL2523</b>	<b>HBL2533</b>	
All black nylon.	.350"-1.150" (9-29)	<b>HBL2513BK</b>	-	-	
Corrosion resistant, yellow nylon.	.350"-1.150" (9-29)	<b>HBL25CM13</b>	-	-	
Black and white for flat cable.	.350"-1.150" (9-29)	<b>HBL2513FC</b>	-	-	



**HBL2513**

Note: See page B-53 for accessories.

**Receptacles**

**Watertight Safety-Shroud®** IP66 SUITABILITY UL Type 4x, 12

Description	Catalog Number		
Gray Valox® housing and flange, back wired.	<b>HBL2510SW</b>	-	-

Note: See page B-54 for accessories.



**HBL2510SW**

**Safety-Shroud® Twist-Lock®** IP20 SUITABILITY

Description	Catalog Number		
Gray Valox® angle housing, one gang, back wired.	<b>HBL2510AR</b>	-	-
Gray Valox® surface mounting, one gang, back wired.	<b>HBL2510SR</b>	-	-
Gray Valox® semi-flush, two gang, back wired.	<b>HBL2510SR2</b>	-	-

Note: See page B-54 for accessories.

**Single Flush Receptacles** IP20 SUITABILITY

Description	Catalog Number			
Black nylon face, back and side wired.	<b>HBL2510</b>	<b>HBL2520*</b>	<b>HBL2530*</b>	
Isolated ground, orange nylon face, back and side wired.	<b>IG2510</b>	-	-	

Note: \*Not Fed Spec.  
 See page B-52 for accessories.



**HBL2510AR**

**Insulgrip® Flanged Receptacles**

Description	Catalog Number			
Nylon casing, back wired.	<b>HBL2516</b>	<b>HBL2526</b>	<b>HBL2536</b>	

Note: See page B-52 for accessories.

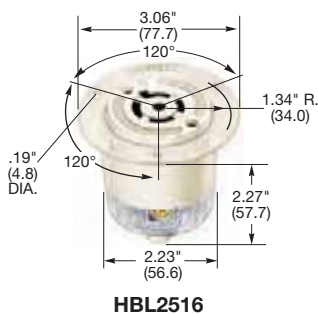

**HBL2516**

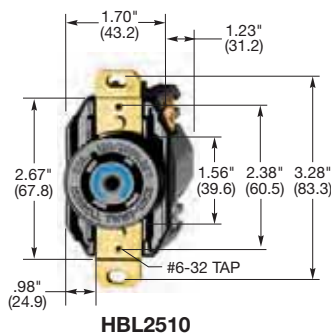

**HBL2510**

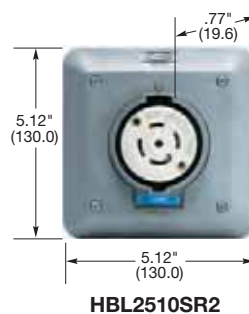

**HBL2510SR2**



**HBL2510SR**

Valox® is a trademark of SABIC Innovative Plastics, acquired from General Electric Company.

Dimensions in Inches (mm)

# Twist-Lock® Devices

## 30 Ampere, 125, 250 Volts and 277 Volts AC

2 Pole, 3 Wire Grounding



### Plugs



#### Watertight Safety-Shroud®

IP66 SUITABILITY    UL Type 4x, 12

Description	Cord Dia.	Catalog Number		
Black Valox® housing, white Valox® clamps.	.325"-.930" (9-24)	HBL2611SW	HBL2621SW	-

#### Safety-Shroud®

IP20 SUITABILITY

Description	Cord Dia.	Catalog Number		
Black and white nylon body, white Valox® shroud. Can be used with the Insulgrip Connector Bodies.	.360"-.930" (9-24)	HBL2611S	HBL2621S	-

Note: See page B-40 for accessories.

#### Insulgrip®

IP20 SUITABILITY

Description	Cord Dia.	Catalog Number		
Black and white nylon.	.360"-.930" (9-24)	HBL2611	HBL2621	HBL2631
Heat stabilized, gray nylon, 220° F (104° C).	.360"-.930" (9-24)	HBL2611F	HBL2621F	-
Corrosion resistant, yellow nylon.	.360"-.930" (9-24)	HBL26CM11	HBL26CM21	-
All black nylon.	.360"-.930" (9-24)	HBL2611BK	HBL2621BK	-

Note: See page B-51 for accessories.

#### Valise®

IP20 SUITABILITY

Description	Cord Dia.	Catalog Number		
Yellow nylon.	.590"-.930" (15.0-23.6)	HBL2611VY	HBL2621VY	-
Corrosion resistant, yellow nylon.	.590"-.930" (15.0-23.6)	HBL26CM11V	-	-
Black nylon.	.590"-.930" (15.0-23.6)	HBL2611VBK	HBL2621VBK	-

Note: See page B-51 for accessories.

### Flanged Inlets

#### Watertight Safety-Shroud®

IP66 SUITABILITY    UL Type 4x, 12

Description	Catalog Number		
Gray Valox® housing and flange.	HBL2615SW	HBL2625SW	-
Reverse service, gray Valox® housing and flange (use with HBL2613SR), (Not shown).	HBL2615SWR	-	-

Note: See page B-54 for accessories.

#### Insulgrip®

IP20 SUITABILITY

Description	Catalog Number		
Nylon casing, back wired.	HBL2615	HBL2625	HBL2635
Heat stabilized, gray nylon, 220° F (104° C).	HBL2615F	HBL2625F	-
Nylon casing, weather protective, die cast aluminum, back wired, self closing lift cover.	HBL2615M3	-	-

Note: See page B-50 for accessories.

See pages B-69 and B-70 for technical information on Twist-Lock and Watertight Safety-Shroud devices.  
See page B-74 for technical information on Valise plugs and connectors.

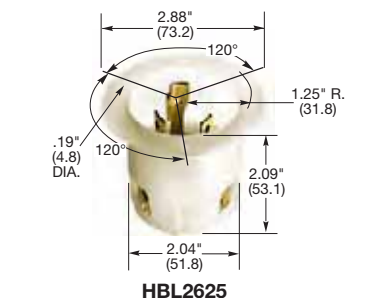

Dimensions in Inches (mm)

Valox® is a trademark of SABIC Innovative Plastics, acquired from General Electric Company.

Twist-Lock® Devices  
**30 Ampere, 125, 250 Volts and 277 Volts AC**  
 2 Pole, 3 Wire Grounding



**30A 125V**  
 NEMA L5-30R  
 UL/CSA  
 2 HP



**30A 250V**  
 NEMA L6-30R  
 UL/CSA  
 2 HP



**30A 277V AC**  
 NEMA L7-30R  
 UL/CSA  
 3 HP

**Connector Bodies**

**Watertight Safety-Shroud®**

IP66 SUITABILITY    UL Type 4x, 12

Description	Cord Dia.	Catalog Number		
Black Valox® housing, white Valox® clamps.	.360"-.930" (9-24)	<b>HBL2613SW</b>	<b>HBL2623SW</b>	-
Reverse service, black Valox® housing, white Valox® clamps (use with HBL2615SWR), (Not shown).	.360"-.930" (9-24)	<b>HBL2613SR</b>	-	-



**HBL2613SW**

**Insulgrip®**

IP20 SUITABILITY

Description	Cord Dia.	Catalog Number		
Black and white nylon.	.360"-.930" (9-24)	<b>HBL2613</b>	<b>HBL2623</b>	<b>HBL2633</b>
Heat stabilized, gray nylon, 220° F (104° C).	.360"-.930" (9-24)	<b>HBL2613F</b>	<b>HBL2623F</b>	-
Corrosion resistant, yellow nylon.	.360"-.930" (9-24)	<b>HBL26CM13</b>	<b>HBL26CM23</b>	-
All black nylon.	.360"-.930" (9-24)	<b>HBL2613BK</b>	<b>HBL2623BK</b>	-



**HBL2623**

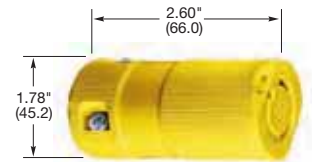

**HBL2613VY**

Note: See page B-51 for accessories.

**Valise®**

IP20 SUITABILITY

Description	Cord Dia.	Catalog Number		
Yellow nylon.	.590"-.930" (15.0-23.6)	<b>HBL2613VY</b>	<b>HBL2623VY</b>	-
Corrosion resistant, yellow nylon.	.590"-.930" (15.0-23.6)	<b>HBL26CM13V</b>	-	-
Black nylon.	.590"-.930" (15.0-23.6)	<b>HBL2613VBK</b>	<b>HBL2623VBK</b>	-



**HBL2610SW**

Note: See page B-51 for accessories.

**Receptacles**

**Watertight Safety-Shroud®**

IP66 SUITABILITY    UL Type 4x, 12

Description	Catalog Number		
Gray Valox® housing and flange, back wired.	<b>HBL2610SW</b>	<b>HBL2620SW</b>	-

Note: See page B-54 for accessories.

**Safety-Shroud® Twist-Lock®**

IP20 SUITABILITY

Description	Catalog Number		
Gray Valox® angle housing, one gang, back wired.	<b>HBL2610AR</b>	<b>HBL2620AR</b>	-
Gray Valox® surface mounting, one gang, back wired.	<b>HBL2610SR</b>	<b>HBL2620SR</b>	-
Gray Valox® semi-flush, two gang, back wired.	<b>HBL2610SR2</b>	<b>HBL2620SR2</b>	-

Note: See page B-54 for accessories.

**Single Flush Receptacles**

IP20 SUITABILITY

Description	Catalog Number		
Black nylon face, back and side wired.	<b>HBL2610</b>	<b>HBL2620</b>	<b>HBL2630</b>
Blue nylon face, back and side wired.	<b>HBL2610M6</b>	<b>HBL2620M6</b>	-
Isolated ground, orange nylon face, back and side wired.	<b>IG2610</b>	<b>IG2620</b>	-
Corrosion resistant, yellow nylon face, back and side wired.	<b>HBL26CM10</b>	<b>HBL26CM20</b>	-
Ring terminal connection.	<b>HBL2610RT</b>	<b>HBL2620RT</b>	-

Note: See page B-50 for accessories.

**Insulgrip® Flanged Receptacles**

Description	Catalog Number		
Nylon casing, back wired.	<b>HBL2616</b>	<b>HBL2626</b>	<b>HBL2636</b>
Heat stabilized, gray nylon, 220° F (104° C).	<b>HBL2616F</b>	<b>HBL2626F</b>	-

Note: See page B-50 for accessories.



**HBL2620AR**



**HBL2620SR**

Dimensions in Inches (mm)



HBL2711SW



HBL2711S



HBL2711



HBL2715SW

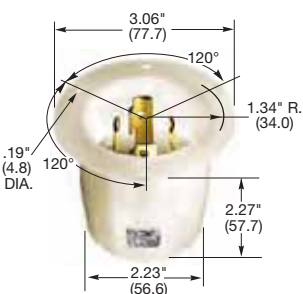

HBL2715

Dimensions in Inches (mm)

## Plugs

### Watertight Safety-Shroud®

Description	Cord Dia.	Catalog Number	IP66 SUITABILITY	UL Type 4x, 12
Black Valox® housing, white Valox® clamps.	.350"-1.150" (9-29)	-	HBL2711SW	HBL2721SW

### Safety-Shroud®

Description	Cord Dia.	Catalog Number	IP20 SUITABILITY
Black and white nylon body, white Valox® shroud. Can be used with the Insulgrip Connector Bodies.	.350"-1.150" (9-29)	-	HBL2711S HBL2721S

Note: See page B-40 for accessories.

### Insulgrip®

Description	Cord Dia.	Catalog Number	IP20 SUITABILITY
Black and white nylon.	.350"-1.150" (9-29)	-	HBL2711 HBL2721
Black and white nylon, (Not shown).	.300"- .950" (7.6-24.1)	HBL2661	-
Corrosion resistant, yellow nylon.	.350"-1.150" (9-29)	-	HBL27CM11 HBL27CM21
All black nylon.	.350"-1.150" (9-29)	-	HBL2711BK -

Note: See page B-53 for accessories.

## Flanged Inlets

### Watertight Safety-Shroud®

Description	Catalog Number	IP66 SUITABILITY	UL Type 4x, 12
Gray Valox® housing and flange.	-	HBL2715SW	HBL2725SW
Reverse service, gray Valox® housing and flange (use with HBL2713SR), (Not shown).	-	HBL2715SWR	-

Note: See page B-54 for accessories.

### Insulgrip®

Description	Catalog Number	IP20 SUITABILITY
Nylon casing, back wired.	-	HBL2715 HBL2725
Nylon casing, back wired, (Not shown).	HBL2665	-
Nylon casing, weather protective, die cast aluminum, back wired, self closing lift cover.	-	HBL2715M3 -

Note: See page B-52 for accessories.

See pages B-69 and B-70 for technical information on Twist-Lock and Watertight Safety-Shroud devices.

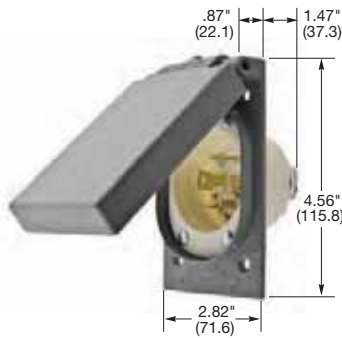

HBL2715M3

HBLMITL - For use with Watertight Safety-Shroud receptacles and reverse service inlet, see page B-39.



Valox® is a trademark of SABIC Innovative Plastics, acquired from General Electric Company.

Twist-Lock® Devices  
**30 Ampere, 125/250 and 3Ø 250 Volts AC**  
 3 Pole, 4 Wire Grounding

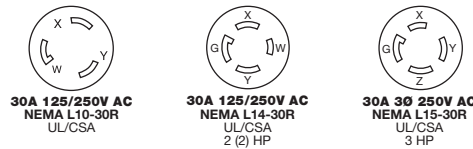

**Connector Bodies**

**Watertight Safety-Shroud®**

IP66 SUITABILITY UL Type 4x, 12

Description	Cord Dia.	Catalog Number		
Black Valox® housing, white Valox® clamps.	.350"-1.150" (9-29)	-	HBL2713SW	HBL2723SW
Reverse service, black Valox® housing, white Valox® clamps (use with HBL2715SWR), (Not shown).	.350"-1.150" (9-29)	-	HBL2713SR	-



**Insulgrip®**

IP20 SUITABILITY

Description	Cord Dia.	Catalog Number		
Black and white nylon.	.350"-1.150" (9-29)	-	HBL2713	HBL2723
Black and white nylon, (Not shown).	.300"- .950" (7.6-24.1)	HBL2663	-	-
Corrosion resistant, yellow nylon.	.350"-1.150" (9-29)	-	HBL27CM13	HBL27CM23
All black nylon.	.350"-1.150" (9-29)	-	HBL2713BK	-



Note: See page B-53 for accessories.

**Receptacles**

**Watertight Safety-Shroud®**

IP66 SUITABILITY UL Type 4x, 12

Description	Catalog Number		
Gray Valox® housing and flange, back wired.	-	HBL2710SW	HBL2720SW

Note: See page B-54 for accessories.

**Safety-Shroud® Twist-Lock®**

IP20 SUITABILITY

Description	Catalog Number		
Gray Valox® angle housing, one gang, back wired.	-	HBL2710AR	HBL2720AR
Gray Valox® surface mounting, one gang, back wired.	-	HBL2710SR	HBL2720SR
Gray Valox® semi-flush, two gang, back wired.	-	HBL2710SR2	HBL2720SR2

Note: See page B-54 for accessories.



**Single Flush Receptacles**

IP20 SUITABILITY

Description	Catalog Number		
Black nylon face, back and side wired.	-	HBL2710	HBL2720
Black nylon face, back and side wired, (Not shown).	HBL2660	-	-
Isolated ground, orange nylon face, back and side wired.	-	IG2710	IG2720
Ring terminal connection.	-	HBL2710RT	HBL2720RT

Note: See page B-52 for accessories.



**Insulgrip® Flanged Receptacles**

Description	Catalog Number		
Nylon casing, back wired.	-	HBL2716	HBL2726

Note: See page B-52 for accessories.

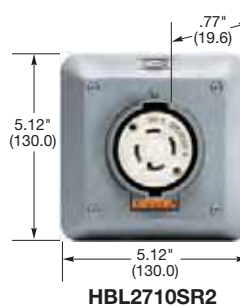
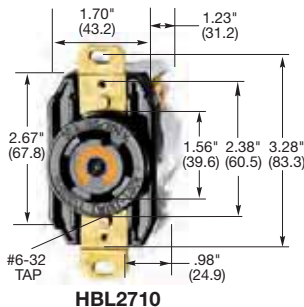

Valox® is a trademark of SABIC Innovative Plastics, acquired from General Electric Company.

Dimensions in Inches (mm)

Twist-Lock® Devices  
**30 Ampere, 3Ø 480 and 3Ø 600 Volts AC**  
 3 Pole, 4 Wire Grounding

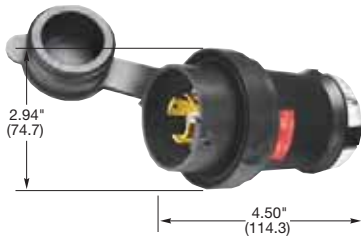

**HBL2731SW**



**HBL2731S**

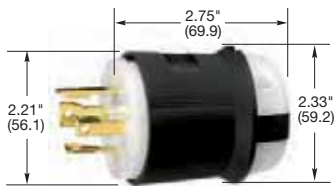

**HBL2731**



**HBL2735SW**

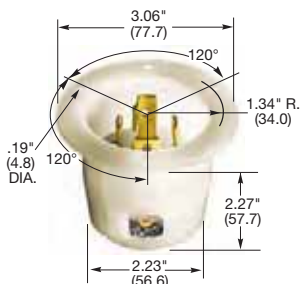

**HBL2735**

Dimensions in Inches (mm)

**Plugs**

**Watertight Safety-Shroud®**

Description	Cord Dia.	IP66 SUITABILITY	UL Type 4x, 12
Black Valox® housing, white Valox® clamps.	.350"-1.150" (9-29)	<b>HBL2731SW</b>	<b>HBL2741SW</b>

**Safety-Shroud®**

Description	Cord Dia.	IP20 SUITABILITY	Catalog Number
Black and white nylon body, white Valox® shroud. Can be used with the Insulgrip Connector Bodies.	.350"-1.150" (9-29)	<b>HBL2731S</b>	<b>HBL2741S</b>

Note: See page B-40 for accessories.

**Insulgrip®**

Description	Cord Dia.	IP20 SUITABILITY	Catalog Number
Black and white nylon.	.350"-1.150" (9-29)	<b>HBL2731</b>	<b>HBL2741</b>
Corrosion resistant, yellow nylon.	.350"-1.150" (9-29)	<b>HBL27CM31</b>	<b>HBL27CM41</b>

Note: See page B-53 for accessories.

**Flanged Inlets**

**Watertight Safety-Shroud®**

Description	IP66 SUITABILITY	UL Type 4x, 12
Gray Valox® housing and flange.	<b>HBL2735SW</b>	<b>HBL2745SW</b>

Note: See page B-54 for accessories.

**Insulgrip®**

Description	IP20 SUITABILITY	Catalog Number
Nylon casing, back wired.	<b>HBL2735</b>	<b>HBL2745</b>

Note: See page B-52 for accessories.

See pages B-69 and B-70 for technical information on Twist-Lock and Watertight Safety-Shroud devices.

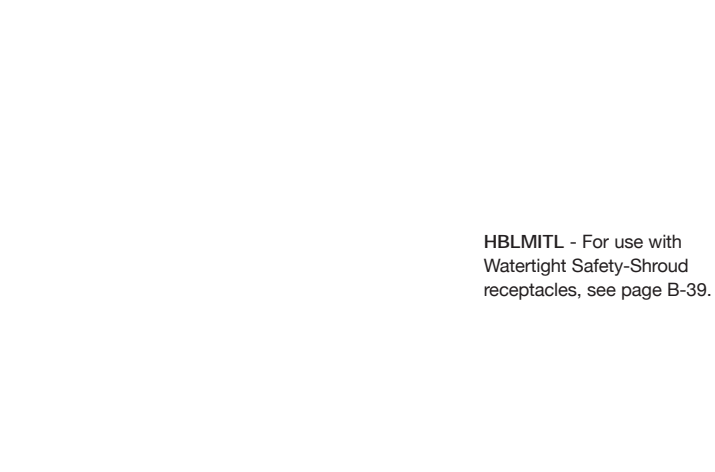

HBLMITL - For use with Watertight Safety-Shroud receptacles, see page B-39.

Valox® is a trademark of SABIC Innovative Plastics, acquired from General Electric Company.

Twist-Lock® Devices  
**30 Ampere, 3Ø 480 and 3Ø 600 Volts AC**  
 3 Pole, 4 Wire Grounding

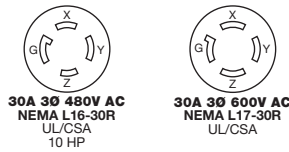

**Connector Bodies**

**Watertight Safety-Shroud®**

Description	Cord Dia.	IP66 SUITABILITY	UL Type 4x, 12
Black Valox® housing, white Valox® clamps.	.350"-1.150" (9-29)	<b>HBL2733SW</b>	<b>HBL2743SW</b>

**Insulgrip®**

Description	Cord Dia.	IP20 SUITABILITY	Catalog Number
Black and white nylon.	.350"-1.150" (9-29)	<b>HBL2733</b>	<b>HBL2743</b>
Corrosion resistant, yellow nylon.	.350"-1.150" (9-29)	<b>HBL27CM33</b>	<b>HBL27CM43</b>

Note: See page B-53 for accessories.



**HBL2733SW**

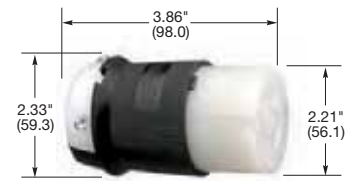

**HBL2733**

**Receptacles**

**Watertight Safety-Shroud®**

Description	Catalog Number	IP66 SUITABILITY	UL Type 4x, 12
Gray Valox® housing and flange, back wired.	<b>HBL2730SW</b>	<b>HBL2740SW</b>	

Note: See page B-54 for accessories.

**Safety-Shroud® Twist-Lock®**

Description	Catalog Number	IP20 SUITABILITY
Gray Valox® angle housing, one gang, back wired.	<b>HBL2730AR</b>	<b>HBL2740AR</b>
Gray Valox® surface mounting, one gang, back wired.	<b>HBL2730SR</b>	<b>HBL2740SR</b>
Gray Valox® semi-flush, two gang, back wired.	<b>HBL2730SR2</b>	<b>HBL2740SR2</b>

Note: See page B-54 for accessories.

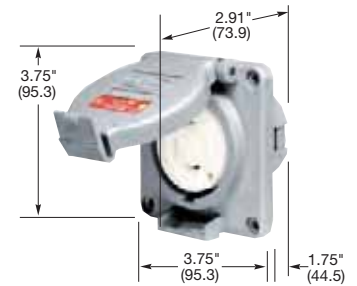

**HBL2730SW**

**Single Flush Receptacles**

Description	Catalog Number	IP20 SUITABILITY
Black nylon face, back and side wired.	<b>HBL2730</b>	<b>HBL2740</b>

Note: See page B-52 for accessories.



**HBL2730AR**

**Insulgrip® Flanged Receptacles**

Description	Catalog Number
Nylon casing, back wired.	<b>HBL2736</b>

Note: See page B-52 for accessories.



**HBL2736**

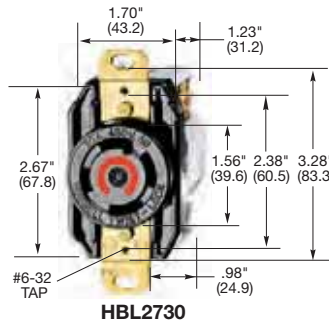

**HBL2730**

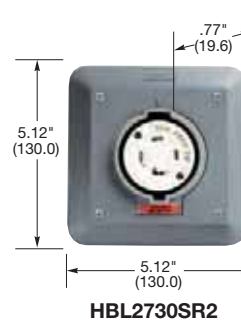

**HBL2730SR2**

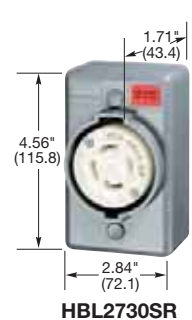

**HBL2730SR**

Valox® is a trademark of SABIC Innovative Plastics, acquired from General Electric Company.

Dimensions in Inches (mm)

Twist-Lock® Devices  
**30 Ampere, 3ØY 120/208, 277/480 and 347/600 Volts AC**  
 4 Pole, 5 Wire Grounding

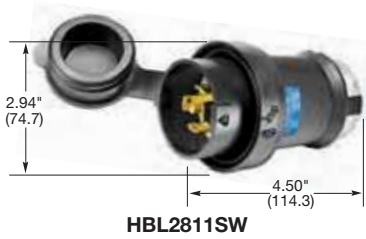

**HBL2811SW**



**HBL2811S**



**HBL2811**



**HBL2815SW**

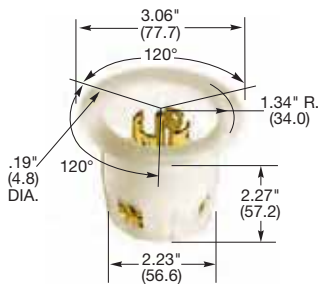

**HBL2815**

Dimensions in Inches (mm)

**Plugs**

**Watertight Safety-Shroud®**

Description	Cord Dia.	Catalog Number	IP66 SUITABILITY	UL Type 4x, 12
Black Valox® housing, white Valox® shroud. Can be used with the Insulgrip Connector Bodies.	.350"-1.150" (9-29)	<b>HBL2811SW</b>	<b>HBL2821SW</b>	<b>HBL2831SW</b>

**Safety-Shroud®**

Description	Cord Dia.	Catalog Number	IP20 SUITABILITY
Black and white nylon body, white Valox® shroud. Can be used with the Insulgrip Connector Bodies.	.350"-1.150" (9-29)	<b>HBL2811S</b>	-

Note: See page B-40 for accessories.

**Insulgrip®**

Description	Cord Dia.	Catalog Number	IP20 SUITABILITY
Black and white nylon.	.350"-1.150" (9-29)	<b>HBL2811</b>	<b>HBL2821</b> <b>HBL2831</b>
Corrosion resistant, yellow nylon.	.350"-1.150" (9-29)	<b>HBL28CM11</b>	-
Black and white for flat cable.	.350"-1.150" (9-29)	<b>HBL2811FC</b>	-
All black nylon.	.350"-1.150" (9-29)	<b>HBL2811BK</b>	-

Note: See page B-53 for accessories.

**Flanged Inlets**

**Watertight Safety-Shroud®**

Description	Catalog Number	IP66 SUITABILITY	UL Type 4x, 12
Gray Valox® housing and flange.	<b>HBL2815SW</b>	-	-

Note: See page B-54 for accessories.

**Insulgrip®**

Description	Catalog Number	IP20 SUITABILITY
Nylon casing, back wired.	<b>HBL2815</b>	<b>HBL2825</b> <b>HBL2835</b>

Note: See page B-52 for accessories.

See pages B-69 and B-70 for technical information on Twist-Lock and Watertight Safety-Shroud devices.

HBLMITL - For use with Watertight Safety-Shroud receptacles, see page B-39.



Valox® is a trademark of SABIC Innovative Plastics, acquired from General Electric Company.



Twist-Lock® Devices  
**30 Ampere, 3ØY 120/208, 277/480 and 347/600 Volts AC**  
 4 Pole, 5 Wire Grounding



**30A 3ØY  
 120/208V AC  
 NEMA L21-30R  
 UL/CSA  
 3 HP**



**30A 3ØY  
 277/480V AC  
 NEMA L22-30R  
 UL/CSA  
 10 HP**



**30A 3ØY  
 347/600V AC  
 NEMA L23-30R  
 UL/CSA**

**Connector Bodies**

**Watertight Safety-Shroud®**

IP66 SUITABILITY    UL Type 4x, 12

Description	Cord Dia.	Catalog Number		
Black Valox® housing, white Valox® clamps.	.350"-1.150" (9-29)	<b>HBL2813SW</b>	<b>HBL2823SW</b>	-



**HBL2813SW**

**Insulgrip®**

IP20 SUITABILITY

Description	Cord Dia.	Catalog Number			
Black and white nylon.	.350"-1.150" (9-29)	<b>HBL2813</b>	<b>HBL2823</b>	<b>HBL2833</b>	
Corrosion resistant, yellow nylon.	.350"-1.150" (9-29)	<b>HBL28CM13</b>	-	-	
Black and white for flat cable.	.350"-1.150" (9-29)	<b>HBL2813FC</b>	-	-	
All black nylon.	.350"-1.150" (9-29)	<b>HBL2813BK</b>	-	-	



**HBL2813**

Note: See page B-53 for accessories.

**Receptacles**

**Watertight Safety-Shroud®**

IP66 SUITABILITY    UL Type 4x, 12

Description	Catalog Number			
Gray Valox® housing and flange, back wired.	<b>HBL2810SW</b>	<b>HBL2820SW</b>	<b>HBL2830SW</b>	

Note: See page B-54 for accessories.

**Safety-Shroud® Twist-Lock®**

IP20 SUITABILITY

Description	Catalog Number			
Gray Valox® angle housing, one gang, back wired.	<b>HBL2810AR</b>	-	-	
Gray Valox® surface mounting, one gang, back wired.	<b>HBL2810SR</b>	-	-	
Gray Valox® semi-flush, two gang, back wired.	<b>HBL2810SR2</b>	-	-	

Note: See page B-54 for accessories.



**HBL2810SW**

**Single Flush Receptacles**

IP20 SUITABILITY

Description	Catalog Number			
Black nylon face, back and side wired.	<b>HBL2810</b>	<b>HBL2820</b>	<b>HBL2830</b>	
Isolated ground, orange nylon face, back and side wired.	<b>IG2810</b>	-	-	
Ring terminal connection.	<b>HBL2810RT</b>	-	-	

Note: See page B-52 for accessories.



**HBL2810AR**

**Insulgrip® Flanged Receptacles**

Description	Catalog Number			
Nylon casing, back wired.	<b>HBL2816</b>	<b>HBL2826</b>	<b>HBL2836</b>	

Note: See page B-52 for accessories.



**HBL2816**

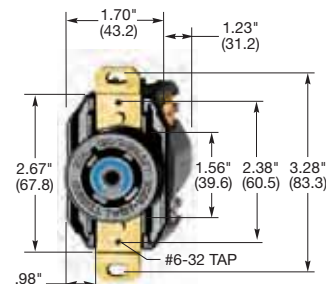

**HBL2810**

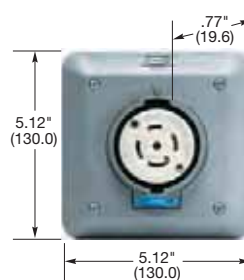

**HBL2810SR2**

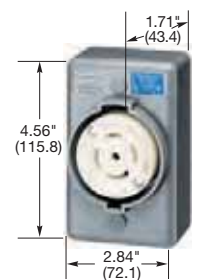

**HBL2810SR**

Valox® is a trademark of SABIC Innovative Plastics, acquired from General Electric Company.

Dimensions in Inches (mm)

Twist-Lock® Devices  
**30 Ampere, 3ØY 120/208, 277/480 and 347/600 Volts AC**  
 4 Pole, 4 Wire Non-Grounding



**HBL2751**

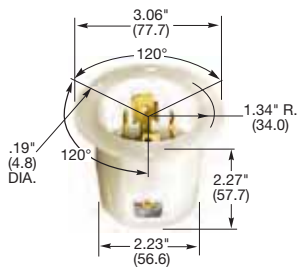

**HBL2755**



**HBL2753**

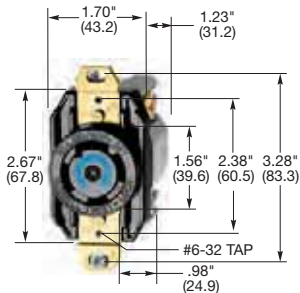

**HBL2750**

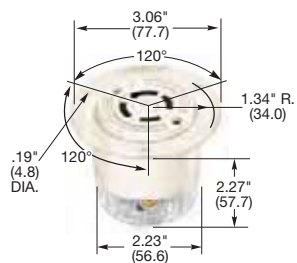

**HBL2756**

**IP20**  
SUITABILITY



**30A 3ØY  
120/208V AC  
NEMA L18-30P**  
UL Listed  
3 HP



**30A 3ØY  
277/480V AC  
NEMA L19-30P**  
UL Listed  
10 HP



**30A 3ØY  
347/600V AC  
NEMA L20-30P**  
UL Listed

## Plugs

Description	Cord Dia.	Catalog Number		
Black and white nylon.	.350"-1.150" (9-29)	<b>HBL2751</b>	<b>HBL2761</b>	<b>HBL2771</b>

*Note: See page B-53 for accessories.*

## Flanged Inlets

Description	Catalog Number		
Nylon casing, back wired.	<b>HBL2755</b>	<b>HBL2765</b>	<b>HBL2775</b>

*Note: See page B-52 for accessories.*

**IP20**  
SUITABILITY



**30A 3ØY  
120/208V AC  
NEMA L18-30R**  
UL Listed  
3 HP



**30A 3ØY  
277/480V AC  
NEMA L19-30R**  
UL Listed  
10 HP



**30A 3ØY  
347/600V AC  
NEMA L20-30R**  
UL Listed

## Connector Bodies

Description	Cord Dia.	Catalog Number		
Black and white nylon.	.350"-1.150" (9-29)	<b>HBL2753</b>	<b>HBL2763</b>	<b>HBL2773</b>

*Note: See page B-53 for accessories.*

## Single Flush Receptacles

Description	Catalog Number		
Black nylon face, back and side wired.	<b>HBL2750</b>	<b>HBL2760</b>	<b>HBL2770</b>

*Note: See page B-52 for accessories.*

## Flanged Receptacles

Description	Catalog Number		
Nylon casing, back wired.	<b>HBL2756</b>	<b>HBL2766</b>	<b>HBL2776</b>

*Note: See page B-52 for accessories.*

*See page B-69 for technical information on Twist-Lock devices.*

Dimensions in Inches (mm)

Twist-Lock® Devices  
**30 Ampere, 480 and 600 Volts AC**  
 2 Pole, 3 Wire Grounding



**IP20**  
 SUITABILITY



**30A 480V AC**  
 NEMA L8-30P  
 UL/CSA  
 5 HP



**30A 600V AC**  
 NEMA L9-30P  
 UL/CSA

**Plugs**

Description	Cord Dia.	Catalog Number	
Black and white nylon.	.325"-.930" (8.25-24)	<b>HBL2641</b>	<b>HBL2651</b>

Note: See page B-51 for accessories.



**HBL2651**

**Flanged Inlets**

Description	Catalog Number
Nylon casing, back wired.	<b>HBL2645</b> <b>HBL2655</b>

Note: See page B-50 for accessories.

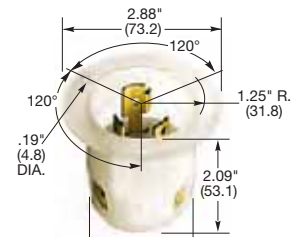

**HBL2655**

**IP20**  
 SUITABILITY



**30A 480V AC**  
 NEMA L8-30R  
 UL/CSA  
 5 HP



**30A 600V AC**  
 NEMA L9-30R  
 UL/CSA

**Connector Bodies**

Description	Cord Dia.	Catalog Number	
Black and white nylon.	.325"-.930" (8.25-24)	<b>HBL2643</b>	<b>HBL2653</b>

Note: See page B-51 for accessories.



**HBL2653**

**Single Flush Receptacles**

Description	Catalog Number
Black nylon face, back and side wired.	<b>HBL2640</b> <b>HBL2650</b>

Note: See page B-50 for accessories.

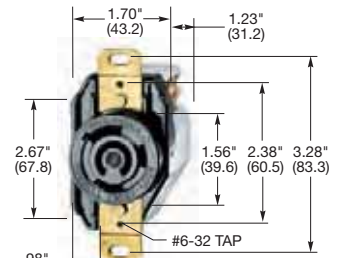

**HBL2650**

**Flanged Receptacles**

Description	Catalog Number
Nylon casing, back wired.	<b>HBL2646</b> <b>HBL2656</b>

Note: See page B-50 for accessories.

See page B-69 for technical information on Twist-Lock devices.

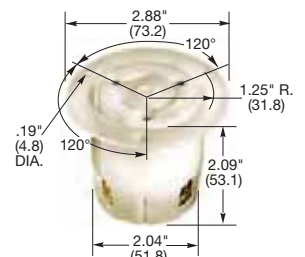

**HBL2656**

Dimensions in Inches (mm)

Twist-Lock® Devices  
**Switched Safety Enclosures**  
 Switched Twist-Lock® and Hubbellock® Enclosures

Lockable handle provides lockout protection for greater safety and complies with OSHA lockout requirements

Horsepower rated switch

Angled 20 or 30 amp Hubbell Twist-Lock® receptacle provides low profile and helps control cable arc of bend

Large receptacle gasketless door and hinge assembly

Premolded conduit entry hole is offset to prevent water condensation from falling directly on interior electrical components, while speeding installation by making it easier to pull conductors

SETL3

Heavy-duty internal frame bonds conduit and all grounds and has a DIN rail to accommodate the switch

Moveable feet may be used in horizontal or vertical position or may be removed and premarked holes drilled for Type 1 or 3R installations

The Switched Twist-Lock® and Hubbellock® Enclosures integrate a receptacle and a switch to produce distinct advantages for the user. This enclosure replaces box, switch, cover and all in a compact design that meets Type 3R Rainproof or 12K Dust-tight requirements. The receptacle is angled downward for a low profile, and it maintains a low profile while accommodating either a 20 or 30 Amp Twist-Lock receptacle or 30 Amp, 4 wire Hubbellock receptacle. The enclosure can be used in top, bottom or back feed applications. The handle is designed to be locked in the off position for lockout protection.

Hubbell has developed the Switched Safety Enclosure because users want to be able to disconnect higher voltage

devices confidently. Hubbell responded with a line of Switched Safety Enclosures for Twist-Lock and Hubbellock receptacles.

The provision of the integral switch and the receptacle in a compact, non-metallic enclosure encourages the safe operating practice of disconnecting at the switch rather than the plug and receptacle.

For plants and factories in a wide variety of industries, as well as light industrial facilities, Hubbell's Switched Enclosures offer an upgrade that's convenient, compact and easy to install.

# Twist-Lock® Devices Switched Safety Enclosures Switched Twist-Lock® and Hubbellock® Enclosures



UL Listed, CSA Certified  
Type 3R and 12K Enclosure Rating

**IP54**  
SUITABILITY

## Switched Enclosure Ready for Twist-Lock® Receptacle Addition

Ideal unit for stockroom. This single unit provides the complete enclosure ready to accept any Hubbell 20 or 30A Twist-Lock receptacle.

Description	Ratings	Catalog Number
Switched Twist-Lock enclosure accommodates any NEMA 2 pole, 3 wire to 4 pole, 5 wire grounding receptacle (sold separately).	Amperage, voltage, and horsepower ratings will be determined by the choice of the NEMA 20 or 30A Twist-Lock receptacle selected.	<b>SETL3</b>
Auxiliary contact.	"Break After Main Break", 1 set of n/o contacts, 1 set of n/c contacts.	<b>HBLAC1</b>
Auxiliary contact.	"Break Before Main Break", 1 set of n/o contacts.	<b>HBLAC2</b>

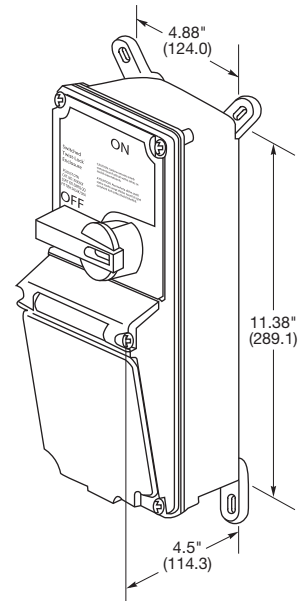

**SETL3**

## Switched Enclosure Complete with Twist-Lock® Receptacle

Completely pre-wired with a Twist-Lock receptacle, these application oriented combinations are available to satisfy your needs.

Description	Amps	Voltage	NEMA Config.	Horsepower	Switched Enclosure	Use Twist-Lock Plug
Switched Twist-Lock enclosure with a pre-wired HBL2720 receptacle.	30	3Ø 240V AC	L15-30R	3	<b>SE2720A</b>	<b>HBL2721</b>
Switched Twist-Lock enclosure with a pre-wired HBL2730 receptacle.	30	3Ø 480V AC	L16-30R	10	<b>SE2730A</b>	<b>HBL2731</b>



**SE2720A**

## Switched Enclosure Ready for Hubbellock® Receptacle Addition

Ideal unit for stockroom. This single unit provides the complete enclosure ready to accept your 30A, 4 wire Hubbellock receptacle choice.

Description	Ratings	Catalog Number
Switched enclosure for use with 3 pole 4 wire 30A Hubbellock receptacle (sold separately).	Amperage, voltage, and horsepower ratings will be determined by the choice of the 4 wire Hubbellock receptacle selected.	<b>SEHBL3</b>
Auxiliary contact.	"Break After Main Break", 1 set of n/o contacts, 1 set of n/c contacts.	<b>HBLAC1</b>
Auxiliary contact.	"Break Before Main Break", 1 set of n/o contacts.	<b>HBLAC2</b>



**HBLAC1**

**HBLAC2**

## Replacement Mounting Feet

Description	Catalog Number
For 30A switches.	<b>HBLRFT1<sup>A</sup></b>

Note: <sup>A</sup> Package of 10 feet and 10 screws.  
For technical information see page B-72.



**HBLRFT1**

Dimensions in Inches (mm)

Twist-Lock® Devices  
**Mechanical Interlock Switched Safety Enclosures**  
 Circuit-Lock® Unfused Safety-Shroud® Twist-Lock®

Lockable handle provides lockout protection for greater safety and complies with OSHA lockout requirements

Heavy-duty interlock linkage prevents make and break under load

Angled 20 or 30 amp Hubbell Watertight Safety-Shroud® Twist-Lock® receptacle provides watertight, low profile and mechanical interlock capabilities (ordered separately)

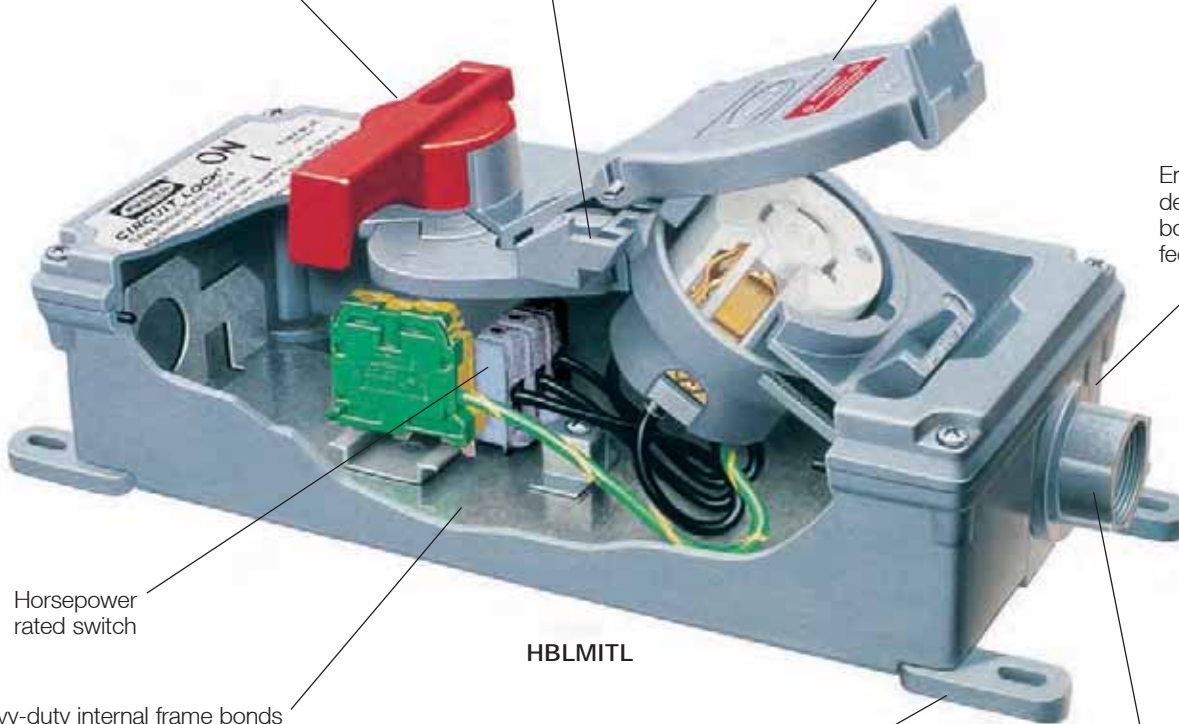

Enclosure back is designed for top, bottom or back feed options

Horsepower rated switch

**HBLMITL**

Heavy-duty internal frame bonds conduit and all grounds and has a DIN rail to accommodate the switch

Moveable feet may be used in horizontal or vertical position or may be removed and premarked holes drilled for Type 1 or 3R installations

Premolded conduit entry hole is offset to prevent water condensation from falling directly on interior electrical components, while speeding installation by making it easier to pull conductors

Hubbell offers the only mechanical interlock for Twist-Lock®. This new, unfused mechanical interlock for watertight Safety-Shroud® Twist-Lock® integrates a watertight receptacle with a linked disconnect switch to provide a mechanically interlocked receptacle. This virtually eliminates the possibility of making or breaking the circuit while under load or making a casual or “lazy” connection.

The switch cannot be turned “ON” until the plug is properly inserted and locked, and the plug cannot be removed until the switch is turned “OFF.” All these protective features are included in a compact Type 4X hose-directed water and

corrosion resistant enclosure that allows for top, bottom or back feed options.

The non-metallic enclosure is nonconductive, yet has an internal frame to assure ground continuity with metallic conduit.

In addition, this interlock works with all Safety-Shroud Twist-Lock Plugs. The new unfused mechanical interlock for watertight Safety-Shroud Twist-Lock can be locked out as a method of compliance with OSHA lockout/tagout regulations.

# Twist-Lock® Devices Mechanical Interlock Switched Safety Enclosures Circuit-Lock® Unfused Safety-Shroud® Twist-Lock®



UL Listed, CSA Certified TYPE 4,  
4X and TYPE 12K Enclosure Rating

**IP66**  
SUITABILITY

## Mechanical Interlock Ready for Twist-Lock® Receptacle Addition

This unit is a complete enclosure ready to accept any 20 or 30A Watertight Safety-Shroud Twist-Lock Receptacle.

Description	Ratings	Catalog Number
Mechanical Interlock accommodates 20A or 30A Watertight Safety-Shroud Twist-Lock receptacles.	Amperage and voltage ratings will be determined by the choice of the Watertight Safety-Shroud Twist-Lock selected. Supplied with 3/4" NPT Hub.	<b>HBLMITL</b>

## Accepts the following Watertight Safety-Shroud® Twist-Lock® Receptacles: 20A

Rating	Voltage AC	NEMA Config.	Max. HP Rating*	Receptacle Catalog Number	Use Watertight Safety-Shroud Twist-Lock Plug
2 Pole, 3 Wire	120	L5-20	1	<b>HBL2310SW</b>	<b>HBL2311SW</b>
	208-240	L6-20	2.5	<b>HBL2320SW</b>	<b>HBL2321SW</b>
	277	L7-20	3	<b>HBL2330SW</b>	<b>HBL2331SW</b>
3 Pole, 4 Wire	120/240	L14-20	2.5	<b>HBL2410SW</b>	<b>HBL2411SW</b>
	240 3Ø	L15-20	5 (3@208V)	<b>HBL2420SW</b>	<b>HBL2421SW</b>
	480 3Ø	L16-20	10	<b>HBL2430SW</b>	<b>HBL2431SW</b>
4 Pole, 5 Wire	120/208 3ØY	L21-20	3	<b>HBL2510SW</b>	<b>HBL2511SW</b>

## 30A

2 Pole, 3 Wire	120	L5-30	1	<b>HBL2610SW</b>	<b>HBL2611SW</b>
	208-240	L6-30	3	<b>HBL2620SW</b>	<b>HBL2621SW</b>
3 Pole, 4 Wire	120/240	L14-30	3	<b>HBL2710SW</b>	<b>HBL2711SW</b>
	240 3Ø	L15-30	7.5	<b>HBL2720SW</b>	<b>HBL2721SW</b>
	480 3Ø	L16-30	15	<b>HBL2730SW</b>	<b>HBL2731SW</b>
4 Pole, 5 Wire	600 3Ø	L17-30	15	<b>HBL2740SW</b>	<b>HBL2741SW</b>
	120/208 3ØY	L21-30	7.5	<b>HBL2810SW</b>	<b>HBL2811SW</b>
	277/480	L22-30	7.5	<b>HBL2820SW</b>	<b>HBL2821SW</b>
	347/600	L23-30	7.5	<b>HBL2830SW</b>	<b>HBL2831SW</b>

## 30A Reverse Service

2 Pole, 3 Wire	120	L5-30	1	<b>HBL2615SWR</b>	<b>HBL2613SR</b>
3 Pole, 4 Wire	120/240	L14-30	3	<b>HBL2715SWR</b>	<b>HBL2713SR</b>
3 Pole, 4 Wire	240 3Ø	L15-30	7.5	<b>HBL2725SWR</b>	<b>HBL2723SR</b>

## Auxiliary Contacts

Description	Ratings	Catalog Number
Auxiliary contact.	"Break After Main Break", 1 set of n/o contacts, 1 set of n/c contacts.	<b>HBLAC1</b>
Auxiliary contact.	"Break Before Main Break", 1 set of n/o contacts.	<b>HBLAC2</b>

## Replacement Parts

Description	Catalog Number
Ground block.	<b>HBL30RGB</b>
Neutral block.	<b>HBL30RNB</b>
Replacement switch.	<b>HBLDS3RS</b>

## Replacement Mounting Feet

Description	Catalog Number
For 30A switches.	<b>HBLRFT1<sup>Δ</sup></b>

Note: \*HP ratings for the final unit are determined by the HP rating of the switch, limited by the full load current capability of the receptacle at 80% of rated current, number of phases and line voltage. HP ratings listed above are AC only.

<sup>Δ</sup>Package of 10 feet and 10 screws.

See pages B-52 and B-53 for accessories.

See page B-73 for technical information.

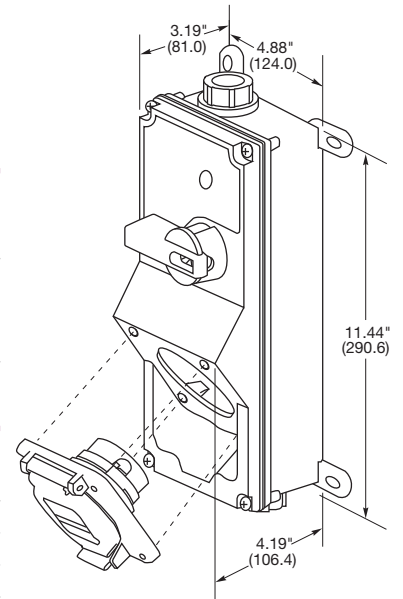

**HBLMITL**



**HBL2620SW**



**HBL2713SR**



**HBLAC1**



**HBLAC2**



**HBL30RGB**



**HBL30RNB**



**HBLRFT1**

Dimensions in Inches (mm)



### Safety-Shroud® Twist-Lock® – 20 and 30 Ampere

The Add-A-Shroud® devices allow conversion of existing 20A and 30A 3 to 5 wire Hubbell Insulgrip® Twist-Lock devices to a Safety-Shroud Twist-Lock plug. These devices provide a convenient and cost-effective way to convert existing Hubbell Insulgrip Twist-Lock plugs to Safety-Shroud Twist-Lock plugs. The Safety-Shroud Twist-Lock plug permits engagement with the Hubbell Mechanical Interlock Enclosure which virtually prevents make and break under load.

### Add-A-Shroud® Catalog Number HBLSS3

For conversion of all 3 wire Hubbell Insulgrip Twist-Lock Devices.

Rating	Voltage AC	NEMA Config. Reference Number	Plug Catalog Number	Add-A-Shroud Catalog Number
20A, 2 Pole 3 Wire Grounding	125V	L5-20	<b>HBL2311</b>	<b>HBLSS3</b>
	250V	L6-20	<b>HBL2321</b>	<b>HBLSS3</b>
	277V AC	L7-20	<b>HBL2331</b>	<b>HBLSS3</b>
	480V AC	L8-20	<b>HBL2341</b>	<b>HBLSS3</b>
	600V AC	L9-20	<b>HBL2351</b>	<b>HBLSS3</b>
30A, 2 Pole 3 Wire Grounding	125V	L5-30	<b>HBL2611</b>	<b>HBLSS3</b>
	250V	L6-30	<b>HBL2621</b>	<b>HBLSS3</b>
	277V AC	L7-30	<b>HBL2631</b>	<b>HBLSS3</b>
	480V AC	L8-30	<b>HBL2641</b>	<b>HBLSS3</b>
	600V AC	L9-30	<b>HBL2651</b>	<b>HBLSS3</b>



### Add-A-Shroud® Catalog Number HBLSS45

For conversion of all 4 and 5 wire Hubbell Insulgrip Twist-Lock Devices.

Rating	Voltage AC	NEMA Config. Reference Number	Plug Catalog Number	Add-A-Shroud Catalog Number
20A, 3 Pole 4 Wire Grounding	125/250V AC	L14-20	<b>HBL2411</b>	<b>HBLSS45</b>
	3Ø250V AC	L15-20	<b>HBL2421</b>	<b>HBLSS45</b>
	3Ø480V AC	L16-20	<b>HBL2431</b>	<b>HBLSS45</b>
30A, 3 Pole 4 Wire Grounding	125/250V AC	L14-30	<b>HBL2711</b>	<b>HBLSS45</b>
	3Ø250V AC	L15-30	<b>HBL2721</b>	<b>HBLSS45</b>
	3Ø480V AC	L16-30	<b>HBL2731</b>	<b>HBLSS45</b>
	3Ø600V AC	L17-30	<b>HBL2741</b>	<b>HBLSS45</b>
20A, 4 Pole 5 Wire Grounding	3ØY 120/208V AC	L21-20	<b>HBL2511</b>	<b>HBLSS45</b>
	3ØY 277/480V AC	L22-20	<b>HBL2521</b>	<b>HBLSS45</b>
	3ØY 347/600V AC	L23-20	<b>HBL2531</b>	<b>HBLSS45</b>
30A, 4 Pole 5 Wire Grounding	3ØY 120/208V AC	L21-30	<b>HBL2811</b>	<b>HBLSS45</b>
	3ØY 277/480V AC	L22-30	<b>HBL2821</b>	<b>HBLSS45</b>
	3ØY 347/600V AC	L23-30	<b>HBL2831</b>	<b>HBLSS45</b>





# Non-NEMA Twist-Lock® Devices

## 10 Ampere, 250 Volts, 15 Ampere 125 Volts

3 Pole, 3 Wire and 2 Pole, 3 Wire

For Replacement Use Only

**IP20**  
SUITABILITY

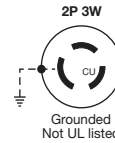

### Plugs

Description	Cord Dia.	Catalog Number	
Black and white nylon. Multiple drive screws.	230"-.720" (5.8-18.3)	<b>HBL7567C</b>	-
Yellow and white nylon. Multiple drive screws.	230"-.720" (5.8-18.3)	<b>HBL7567CY</b>	-

Note: See page B-49 for accessories.



### Flanged Inlets

Description	Catalog Number	
Stainless steel casing.	<b>HBL7556</b>	<b>HBL7556G</b>

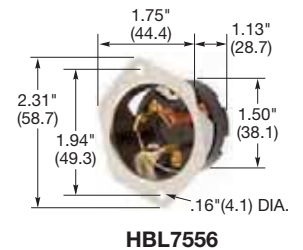

For Replacement Use Only

**IP20**  
SUITABILITY

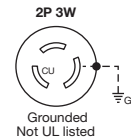

### Connector Bodies

Description	Cord Dia.	Catalog Number	
Insulgrip connector, black and white nylon. Multiple drive screws.	230"-.720" (5.8-18.3)	<b>HBL7565C</b>	-
Insulgrip connector, yellow and white nylon. Multiple drive screws.	230"-.720" (5.8-18.3)	<b>HBL7565CY</b>	-
Black phenolic.	.296"-.625" (7.5-15.9)	<b>HBL7555</b>	<b>HBL7555G</b>

Note: See page B-49 for accessories.



### Receptacles

Description	Catalog Number	
Duplex, black RTP*, back and side wired.	<b>HBL7580</b>	<b>HBL7580G</b>
Single, black phenolic, back and side wired.	<b>HBL7582</b>	<b>HBL7582G</b>

Note: See page B-48 for accessories.

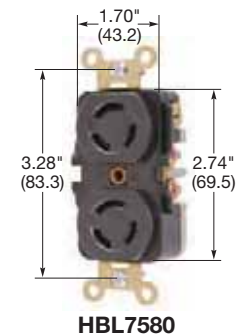

### Flanged Receptacles

Description	Catalog Number	
Stainless steel casing.	<b>HBL7557</b>	<b>HBL7557G</b>

Note: See page B-49 for accessories.

\*RTP is an abbreviation for reinforced thermoplastic.  
The devices shown on this page are not listed by Underwriters Laboratories Inc. and are for replacement use only in existing installations.

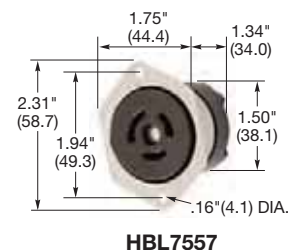

**CAUTION:** To avoid electrical shock, review premises carefully and do not use if slot or blade configuration (design) is already in a circuit having a rating differing from the rating of this device.

Dimensions in Inches (mm)

# Non-NEMA Twist-Lock® Devices 20 Ampere, 250, 125/250 Volts and 3ØY 120/208 Volts AC Insulgrip® Plugs, Flanged Inlets, Connector Bodies and Receptacles



**HBL9965C**

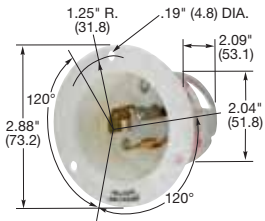

**HBL3325C**



**HBL7411C**

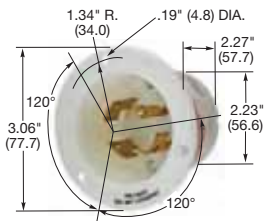

**HBL7408C**

For Replacement Use Only

**IP20**  
SUITABILITY

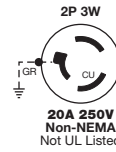

## Plugs

Description	Cord Dia.	Catalog Number	
Black and white nylon.	.360"-.930" (9-24)	<b>HBL9965GCB</b>	<b>HBL9965C</b>
Corrosion resistant, yellow nylon.	.360"-.930" (9-24)	-	<b>HBL99CM65C</b>

Note: See page B-51 for accessories.

## Flanged Inlets

Description	Catalog Number
Nylon casing, back wired.	- <b>HBL3325C</b>

Note: See page B-50 for accessories.

For Replacement Use Only

**IP20**  
SUITABILITY



## Plugs

Description	Cord Dia.	Catalog Number	
Black and white nylon.	.350"-1.150" (9-29)	<b>HBL7411GCB</b>	<b>HBL7411C</b>

Note: See page B-53 for accessories.

## Flanged Inlets

Description	Catalog Number
Nylon casing, back wired.	- <b>HBL7408C</b>

Note: See page B-52 for accessories.

See page B-69 for technical information.

The devices shown on this page are not listed by Underwriters Laboratories Inc. and are for replacement use only in existing installations.

Dimensions in Inches (mm)

**CAUTION:** To avoid electrical shock, review premises carefully and do not use if slot or blade configuration (design) is already in a circuit having a rating differing from the rating of this device.

# Non-NEMA Twist-Lock® Devices 20 Ampere, 250, 125/250 Volts and 3ØY 120/208 Volts AC Insulgrip® Plugs, Flanged Inlets, Connector Bodies and Receptacles

For Replacement Use Only

**IP20**  
SUITABILITY

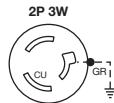

**2P 3W**  
**20A 250V**  
Non-NEMA  
Not UL Listed



**3P 3W**  
**20A 125/250V**  
Non-NEMA  
Not UL Listed

## Connector Bodies

Description	Cord Dia.	Catalog Number
Black and white nylon.	.360"-.930" (9-24)	<b>HBL7314GCB</b> <b>HBL7314C</b>
Corrosion resistant, yellow nylon.	.360"-.930" (9-24)	- <b>HBL73CM14C</b>

Note: See page B-51 for accessories.



**HBL7314C**

## Single Flush Receptacles

Description	Catalog Number
Black nylon face, back wired.	<b>HBL7310BG</b> <b>HBL7310B</b>

Note: See page B-50 for accessories.

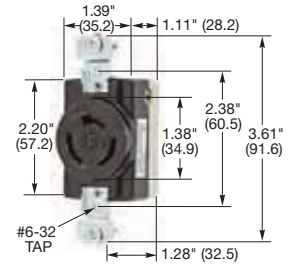

**HBL7310B**

## Flanged Receptacles

Description	Catalog Number
Nylon casing, back wired.	- <b>HBL3326C</b>

Note: See page B-50 for accessories.

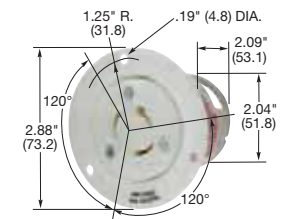

**HBL3326C**

For Replacement Use Only

**IP20**  
SUITABILITY

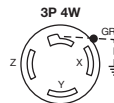

**3P 4W**  
**20A 3Ø 250V AC**  
Non-NEMA  
Not UL Listed



**4P 4W**  
**20A 3Ø Y**  
**120/208V AC**  
Non-NEMA  
Not UL Listed

## Connector Bodies

Description	Cord Dia.	Catalog Number
Black and white nylon.	.350"-1.150" (9-29)	<b>HBL7413GCB</b> <b>HBL7413C</b>

Note: See page B-53 for accessories.



**HBL7413GCB**

## Single Flush Receptacles

Description	Catalog Number
Black thermoset, back wired.	<b>HBL7410BG</b> <b>HBL7410B</b>
Mounted on a 4" (101.6) round metal cover.	- <b>HBL7417B</b>

Note: See page B-52 for accessories.

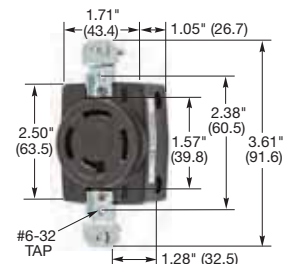

**HBL7410BG**

## Flanged Receptacles

Description	Catalog Number
Nylon casing, back wired.	- <b>HBL7409C</b>

Note: See page B-52 for accessories.

The devices shown on this page are not listed by Underwriters Laboratories Inc. and are for replacement use only in existing installations.

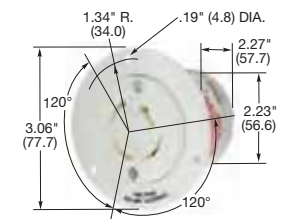

**HBL7409C**

**CAUTION:** To avoid electrical shock, review premises carefully and do not use if slot or blade configuration (design) is already in a circuit having a rating differing from the rating of this device.

Dimensions in Inches (mm)

# Non-NEMA Twist-Lock® Devices 30 Ampere, 250, 125/250 Volts and 3ØY 120/208 Volts AC



**HBL3331GC**

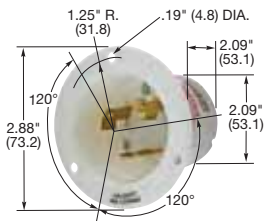

**HBL3334C**



**HBL3431C**

For Replacement Use Only

**IP20**  
SUITABILITY

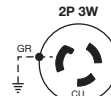

**30A 250V**  
Non-NEMA  
Not UL listed



**30A 125/250V**  
Non-NEMA  
Not UL Listed

## Insulgrip® Plugs

Description	Cord Dia.	Catalog Number	
Black and white nylon.	.360"-.930" (9-24)	<b>HBL3331GC</b>	<b>HBL3331C</b>

Note: See page B-51 for accessories.

## Insulgrip® Flanged Inlets

Description	Catalog Number
Nylon casing, back wired.	- <b>HBL3334C</b>

Note: See page B-50 for accessories.

For Replacement Use Only

**IP20**  
SUITABILITY

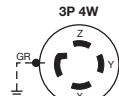

**30A 3Ø 250V AC**  
Non-NEMA  
Not UL Listed



Non-NEMA  
**30A 3Ø Y**  
**120/208V AC**  
Not UL Listed

## Insulgrip® Plugs

Description	Cord Dia.	Catalog Number	
Black and white nylon.	.350"-1.150" (9-29)	<b>HBL3431GCB</b>	<b>HBL3431C</b>

Note: See page B-53 for accessories.

See page B-69 for technical information.

The devices shown on this page are not listed by Underwriters Laboratories Inc. and are for replacement use only in existing installations.

Dimensions in Inches (mm)

**CAUTION:** To avoid electrical shock, review premises carefully and do not use if slot or blade configuration (design) is already in a circuit having a rating differing from the rating of this device.

# Non-NEMA Twist-Lock® Devices 30 Ampere, 250, 125/250 Volts and 3ØY 120/208 Volts AC

For Replacement Use Only

**IP20**  
SUITABILITY

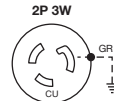

**2P 3W**  
**30A 250V**  
Non-NEMA  
Not UL listed



**3P 3W**  
**30A 125/250V**  
Non-NEMA  
Not UL Listed

## Insulgrip® Connector Bodies

Description	Cord Dia.	Catalog Number
Black and white nylon.	.360"-.930" (9-24)	<b>HBL3333GC</b> <b>HBL3333C</b>

Note: See page B-51 for accessories.



**HBL3333GC**

## Single Flush Receptacles

Description	Catalog Number
Black thermoset, back wired.	<b>HBL3330G</b> <b>HBL3330</b>

Note: See page B-50 for accessories.

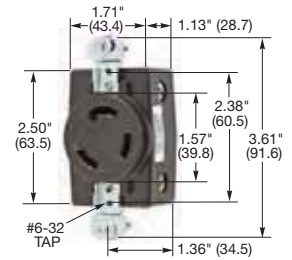

**HBL3330G**

## Insulgrip® Flanged Receptacles

Description	Catalog Number
Nylon casing, back wired.	- <b>HBL3335C</b>

Note: See page B-50 for accessories.

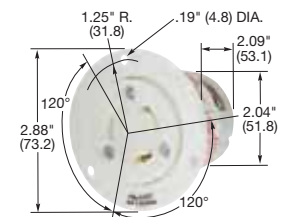

**HBL3335C**

For Replacement Use Only

**IP20**  
SUITABILITY

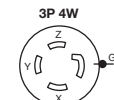

**3P 4W**  
**30A 3Ø 250V AC**  
Non-NEMA  
Not UL Listed



**4P 4W**  
**30A 3Ø Y**  
**120/208V AC**  
Non-NEMA  
Not UL Listed

## Insulgrip® Connector Bodies

Description	Cord Dia.	Catalog Number
Black and white nylon.	.350"-1.150" (9-29)	<b>HBL3433GCB</b> <b>HBL3433C</b>

Note: See page B-53 for accessories.



**HBL3433C**

## Single Flush Receptacles

Description	Catalog Number
Black thermoset, back wired.	<b>HBL3430G</b> <b>HBL3430</b>

Note: See page B-52 for accessories.

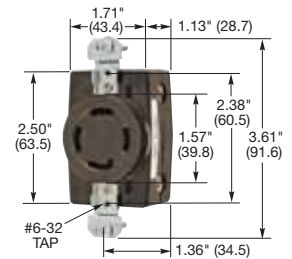

**HBL3430**

## Insulgrip® Flanged Receptacles

Description	Catalog Number
Nylon casing, back wired.	<b>HBL3435CM2</b> -

Note: See page B-50 for accessories.

The devices shown on this page are not listed by Underwriters Laboratories Inc. and are for replacement use only in existing installations.

**CAUTION:** To avoid electrical shock, review premises carefully and do not use if slot or blade configuration (design) is already in a circuit having a rating differing from the rating of this device.

Dimensions in Inches (mm)

Non-NEMA Twist-Lock® Devices  
**20 Ampere, 250 Volts, 10 Ampere, 600 Volts AC**  
 4 Pole, 5 Wire Grounding



**HBL3521C**

For Replacement Use Only

**IP20**  
SUITABILITY



**Plugs**

Description	Cord Dia.	Catalog Number
Black and white nylon.	.350"-1.150" (9-29)	<b>HBL3521C</b>

*Note: See page B-53 for accessories.*

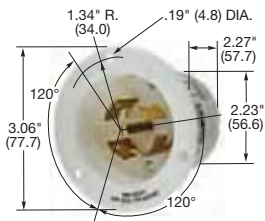

**HBL3524C**

**Flanged Inlets**

Description	Catalog Number
Insulgrip nylon casing, back wired.	<b>HBL3524C</b>

*Note: See page B-52 for accessories.*



**HBL3523C**

**IP20**  
SUITABILITY



**Connector Bodies**

Description	Cord Dia.	Catalog Number
Black and white nylon.	.350"-1.150" (9-29)	<b>HBL3523C</b>

*Note: See page B-53 for accessories.*

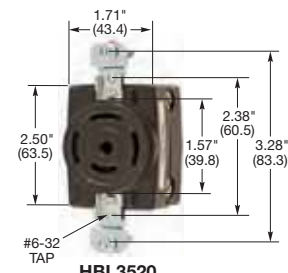

**HBL3520**

**Single Flush Receptacles**

Description	Catalog Number
Black thermoset, back wired.	<b>HBL3520</b>

*Note: See page B-52 for accessories.*

**Flanged Receptacles**

Description	Catalog Number
Insulgrip nylon casing, back wired.	<b>HBL3525C</b>

*Note: See page B-52 for accessories.  
 See page B-69 for technical information.*

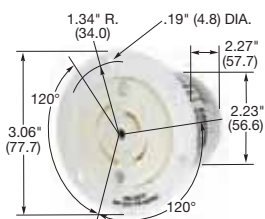

**HBL3525C**

Dimensions in Inches (mm)

**CAUTION:** To avoid electrical shock, review premises carefully and do not use if slot or blade configuration (design) is already in a circuit having a rating differing from the rating of this device.

Non-NEMA Twist-Lock® Devices  
 30 Ampere, 250 Volts DC Max. and 600 Volts AC Max. 50 - 400Hz  
 20 Ampere, 3ØY 120/208 Volts AC 400Hz



**Variload® Twist-Lock® Devices**

In many large plants and laboratories the number of circuits of different ratings and frequency is greater than the number of blade configurations available in conventional wiring devices.

Prior to NEMA configuration standardization the solution was “Variload® Twist-Lock®” devices with four non-interchangeable center pin and slot configurations that can be assigned within the same premises to circuits of same voltage, frequency and supply (AC or DC), in accordance with NEC® 406.4(F) and 406.8 and with CE Code, Part I, Rule 26-700(3).

**30A, 250V DC Max. and 600V AC Max. 50 - 400Hz**

Center Pin Configuration	Plugs	Flanged Inlets	Connector Bodies	Receptacles
	HBL45115	-	HBL45135	HBL45105
	HBL45215	-	HBL45235	HBL45205
	HBL45315	-	HBL45335	HBL45305



HBL45315



HBL45335

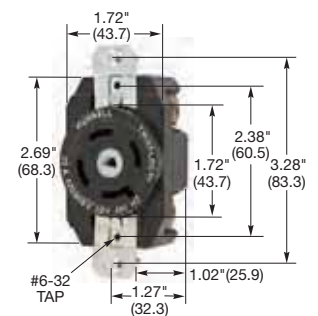

HBL45305

**20A 3ØY, 120/208V AC Only, 400Hz**

Center Pin Configuration	Plugs	Flanged Inlets	Connector Bodies	Receptacles
	HBL45915†	HBL45985CL†	HBL45935†	HBL45905†

Note: †UL Listed only.

**Receptacle Wallplates**

Description	Single Receptacle with Face Dia. 1.74" (44.2) Catalog Number
Stainless steel 302/304, .035 in. (0.9), horizontal brushed finish.	SS725



SS725

**IP55\***  
 SUITABILITY

**Weatherproof Boots**

Description	Catalog Number
Seal-Tite® black elastomer for Variload® plugs.	HBL6027**
Seal-Tite® black elastomer for Variload® connector bodies.	HBL6028**

Note: \*When installed and used properly with plug and connector body combinations.  
 \*\* Weatherproof boots not UL Listed, nor CSA Certified.



HBL6027



HBL6028

**CAUTION:** To avoid electrical shock, review premises carefully and do not use if slot or blade configuration (design) is already in a circuit having a rating differing from the rating of this device.

Dimensions in Inches (mm)



SS8

SS7



HBL5206WO



HBL5221



HBL7423WO



WP1

### Wallplates, 1-Gang

Description	Color	Duplex Receptacles Catalog Number	Single Receptacles with Face Dia. 1.40" (35.6) Catalog Number
Nylon, smooth.	Brown Ivory	NP8 NP8I	NP7 NP7I
Stainless steel 302/304, .035 in. (0.9), horizontal brushed finish.		SS8	SS7
Stainless steel 430, .035 in. (0.9), horizontal brushed finish.		SS8L	SS7L
Brass .04 in. (1.0), horizontal brushed finish.		SB8	SB7
Aluminum .05 in. (1.3), horizontal brushed finish.		SA8	SA7

**IP44**  
SUITABILITY

### Weatherproof Covers

Description	Catalog Number	Catalog Number
Cast aluminum, for standard horizontal box mount.	HBL5205WO	-
Same as above except FS/FD box mount.	HBL5206WO	-
Cast aluminum vertical FS/FD box mount.	-	HBL7420
Gray thermoplastic, vertical standard box mount, corrosion resistant.	HBL5222*	-
Same as above except yellow.	HBL52CM22*	-
Gray thermoplastic, vertical FS/FD box mount, corrosion resistant.	HBL5221*	HBL7423WO
Yellow thermoplastic, vertical FS/FD box mount, corrosion resistant.	HBL52CM21*	HBL74CM23WO
White thermoplastic, vertical FS/FD box mount, corrosion resistant.	HBL52CM21W*	-

Note: \*IP20 Suitability only.

**IP44**  
SUITABILITY

### Weatherproof Covers for 15A Nylon Flanged Receptacles and Inlets

Description	Catalog Number
Gray thermoplastic, corrosion resistant.	WP1

Note: All weatherproof covers listed above are UL Listed for wet and damp locations with cover closed. Those with suffix WO are UL Listed with cover open. See page N-23 for additional information on covers.



# Twist-Lock® Devices Accessories

for 15 Ampere 2 and 3 Wire Plugs, Connector Bodies and Flanged Devices



Tinted lid is aesthetically pleasing in any location. High-impact, polycarbonate while-in-use cover will not rust or corrode; cover is NEMA 3R rated

Compact 2-gang design

HBLPKL520

Locking receptacle prevents unintentional disconnection of mating pump plug

### Pool Kit Contains:

- Heavy duty, industrial grade locking receptacle NEMA L5-20, 20A 125V
- Single-pole switch (20A, 120-277V AC)
- Two gang, 2 inch deep die-cast aluminum weatherproof box with (4) 3/4 inch threaded outlets
- Two gang, weatherproof while-in-use cover
- Includes mounting hardware, gasket, wire connector and (3) closure plugs
- Complete assembly instructions



### Pool Pump Kit

Description	Catalog Number
Pool pump receptacle kit.	HBLPKL520



HBL6023



HBL6024



HBL7529A

### Weatherproof, Seal-Tite®, Triple Seal Boots for 15A Insulgrip® Devices



Description	Catalog Number
Black elastomer boot for plugs when used in a cord set and connector bodies when used with a flange inlet.	HBL6023
Same as above except yellow elastomer.	HBL60CM23
Black elastomer boot for connector bodies when used in cord sets.	HBL6024
Same as above except yellow elastomer.	HBL60CM24

Note: \*When installed and used properly with plug and connector body combinations.

### Closure Cover

Description	Catalog Number
For use with 3 wire 15A Twist-Lock flush or flanged receptacles.	HBL7529A

### PLUGOUT® Lockout Devices

Description	Catalog Number
Lockout device for 15A and 20A straight blade plugs.	HLDMP
Lockout device for attachable 20 and 30A plugs, straight body or angle types, with or without weatherproof covers.	HLD

Note: See section Z for additional information on PLUGOUT Lockout devices.



HLDMP

Dimensions in Inches (mm)



SS720

### Wallplates, 1-Gang

Description	Color	Single Receptacles with Face Dia. 1.60" (40.6) Catalog Number
Nylon, smooth.	Black	NP720BK
Stainless steel 302/304, .035 in. (0.9), horizontal brushed finish.		SS720
Brass .04 in. (1.0), horizontal brushed finish.		SB720



HBL7425WOA

**IP44**  
SUITABILITY

### Weatherproof Covers

Description	Catalog Number
Cast aluminum, for FS/FD box mounting.	HBL7420
Gray thermoplastic, for FS/FD box mounting, corrosion resistant.	HBL7425WOA
Same as above except yellow.	HBL74CM25WOA



WP2

**IP44**  
SUITABILITY

### Weatherproof Covers for Flanged Inlets and Flanged Receptacles

Description	Catalog Number
Gray thermoplastic, corrosion resistant.	WP2

*Note: Weatherproof covers are UL Listed for wet and damp location with cover closed. Those with suffix WOA are UL Listed with cover open. See page N-23 for additional information on covers.*



HBL2899

### Closure Cover for 3 Wire Flanged Inlets

Description	Catalog Number
Rubber closure plug.	HBL2899

*Note: Closure cover not UL Listed, CSA Certified.*

# Twist-Lock® Devices Accessories

for 20 and 30 Ampere, 3 Wire Plugs and Connector Bodies

**IP55\***  
SUITABILITY

## Insulgrip®

### Weatherproof, Seal-Tite®, Triple Seal Boots

Description	Catalog Number
Black elastomer boot for plugs when used in a cord set and connector bodies when used in flanged inlets.	<b>HBL6031</b>
Same as above except yellow.	<b>HBL60CM31</b>
Black elastomer boot for connector bodies when used in a cord set.	<b>HBL6032</b>
Same as above except yellow.	<b>HBL60CM32</b>



HBL6031



HBL6032

### Angle Adapter

Description	Catalog Number
Nylon, angle adapter for Insulgrip plugs and connector bodies, cord grip range .325"-.930" (8.3-24).	<b>HBL3WAA</b>



HBL3WAA

### PLUGOUT® Lockout Devices

Description	Catalog Number
Lockout device for attachable 20 and 30A locking plugs, straight body or angle types, with or without weatherproof covers.	<b>HLD</b>
Lockout device for 20 and 30A 3 wire angle plugs and watertight Safety-Shroud® Twist-Lock® plugs.	<b>HLD2</b>

Note: See section Z for additional information on PLUGOUT Lockout devices.  
\*When installed and used properly with plug and connector body combinations.



### Insulgrip® Plug and Connector Body Latching Kit

The Hubbell latching kit provides both improved safety and security through a double locking feature that makes unintentional disconnection virtually impossible – even under high vibration situations. The plug and connector body lock once when first connected, then again when you push the special position locking slide into place.

### Insulgrip® Latching Kit

Description	Catalog Number
For all 3 wire 20A and 30A Twist-Lock Insulgrip plugs and connectors.	<b>SK2</b>



SK2

## Valise®

**IP55\***  
SUITABILITY

### Weatherproof, Seal-Tite®, Triple Seal Boots

Description	Catalog Number
Yellow Seal-Tite® elastomer triple seal cover for use with Valise plugs when used in cord set and Valise connector bodies when used with flanged inlet.	<b>HBL60CM31V</b>
Yellow Seal-Tite® elastomer triple seal cover for use with Valise connector bodies.	<b>HBL60CM32V</b>

Note: \*When installed and used properly with plug and connector body combinations.



HBL60CM31V



HBL60CM32V



NP720BK

### Wallplates, 1-Gang

Description	Color	Single Receptacles with Face Dia. 1.60" (40.6) Catalog Number
Nylon, smooth.	Black	NP720BK
Stainless steel 302/304, .035 in. (0.9), horizontal brushed finish, 1-gang.		SS720
Brass .04 in. (1.0), horizontal brushed finish.		SB720



SS720

**IP44**  
SUITABILITY

### Weatherproof Covers

Description	Catalog Number
Cast aluminum, for FS/FD box mounting.	HBL7420
Gray thermoplastic, for FS/FD box mounting, corrosion resistant.	HBL7425WOA
Same as above except yellow.	HBL74CM25WOA



HBL7425WOA

**IP44**  
SUITABILITY

### Weatherproof Covers for Flanged Inlets and Flanged Receptacles

Description	Catalog Number
Gray thermoplastic, corrosion resistant.	WP2

*Note: Weatherproof covers are UL Listed for wet and damp location with cover closed. Those with suffix WOA are UL Listed with cover open. See page N-23 for additional information on covers.*



WP2

# Twist-Lock® Devices Accessories

for 20 and 30 Ampere, 4 and 5 Wire Plugs and Connector Bodies

**IP55\***  
SUITABILITY

## Insulgrip®

### Weatherproof, Seal-Tite®, Triple Seal Boots

Description	Catalog Number
Seal-Tite® triple seal cover for plug when used on a cord set or when used with flush receptacles or connector bodies when used with flanged inlets. Black elastomer.	<b>HBL6035</b>
Same as above except yellow.	<b>HBL60CM35</b>
Seal-Tite triple seal cover for connector bodies, when used on interconnecting cord sets. Black elastomer.	<b>HBL6036</b>
Same as above except yellow.	<b>HBL60CM36</b>



HBL6035



HBL6036

### Angle Adapter

Description	Catalog Number
Nylon, angle adapter for Insulgrip plugs and connectors, cord grip range .350"-1.15" (8.9-29.2).	<b>HBL45WAA</b>



HBL45WAA

### PLUGOUT® Lockout Device

Description	Catalog Number
Lockout device for attachable 20 and 30A plugs, straight body or angle types, with or without weatherproof covers.	<b>HLD</b>
Lockout device for 20 and 30A, 4 and 5 wire angle plugs and watertight Safety-Shroud® Twist-Lock® plugs.	<b>HLD2</b>

Note: See section Z for additional information on PLUGOUT Lockout devices.  
\*When installed and used properly, with plug and connector body combinations.



HLD

### Insulgrip® Plug and Connector Body Latching Kit

When you want to make doubly sure that plugs and connector bodies stay connected, the Hubbell latching kit provides both improved safety and security through a double locking feature that makes unintentional disconnection virtually impossible – even under high vibration situations. The plug and connector body lock once when first connected, then again when you push the special position locking slide into place.

### Insulgrip® Latching Kit

Description	Catalog Number
For all 20 and 30A, 4 and 5 wire Twist-Lock Insulgrip plugs and connectors.	<b>SK3</b>



SK3



HLD2

Dimensions in Inches (mm)

# Twist-Lock® Devices Safety-Shroud® Twist-Lock® Accessories

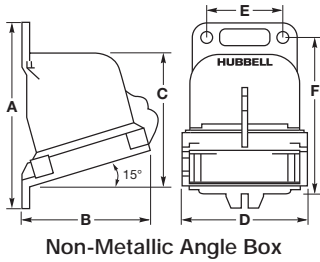

## 15° Angle Non-Metallic Back Box

NPT Hub Size	A Inch (mm)	B Inch (mm)	C Inch (mm)	D Inch (mm)	E Inch (mm)	F Inch (mm)	Cubic Inch Capacity	Catalog Number
For 20A and 30A Watertight Safety-Shroud Twist-Lock Receptacles and Inlets.	1" (144.0)	5.67" (144.0)	4.44" (112.8)	4.05" (102.9)	3.91" (99.3)	2.35" (59.7)	4.92" (125.0)	30.00" <b>BB2030N</b>

Note: Hub is not included; order Raco part number 1704. This box meets IP67 requirement and Type 4X requirements when installed with a watertight conduit hub.

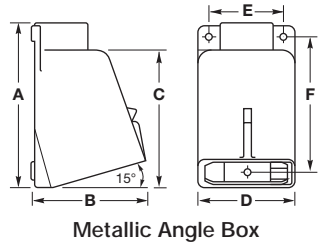

## 15° Angle Metallic Back Boxes

NPT Hub Size	A Inch (mm)	B Inch (mm)	C Inch (mm)	D Inch (mm)	E Inch (mm)	F Inch (mm)	Cubic Inch Capacity	Catalog Number
For 20A and 30A Watertight Safety-Shroud Twist-Lock Receptacles and Inlets.	3/4"	5.13" (130.2)	4.00" (101.6)	4.19" (106.4)	3.75" (95.3)	3.00" (76.2)	4.00" (101.6)	30.00" <b>BB201W</b>
	1"	5.13" (130.2)	4.00" (101.6)	4.19" (106.4)	3.75" (95.3)	3.00" (76.2)	4.00" (101.6)	30.00" <b>BB301W</b>

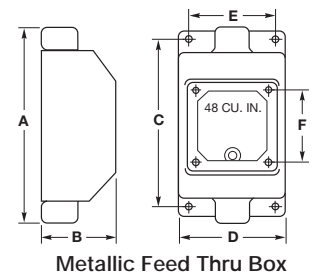

## Metallic Feed Thru Back Boxes

NPT Hub Size	A Inch (mm)	B Inch (mm)	C Inch (mm)	D Inch (mm)	E Inch (mm)	F Inch (mm)	Cubic Inch Capacity	Catalog Number
For 20A and 30A Watertight Safety-Shroud Twist-Lock Receptacles and Inlets.	3/4"	8.25" (209.6)	3.06" (77.8)	7.14" (181.4)	4.50" (114.3)	3.75" (95.3)	3.13" (79.5)	48.00" <b>FT202W</b>
	1"	8.25" (209.6)	3.06" (77.8)	7.14" (181.4)	4.50" (114.3)	3.75" (95.3)	3.13" (79.5)	48.00" <b>FT302W</b>

Note: These boxes are cast aluminum and are finished with enamel paint. These boxes withstand a 500-hour salt spray test as well as UL raintight and external icing tests. NPT (metric designator).

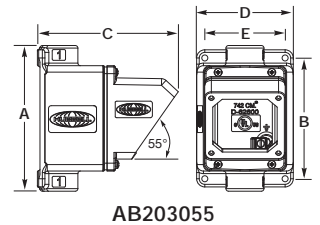

## 55° Angle Metallic Adapter and Back Box

NPT Hub Size	A Inch (mm)	B Inch (mm)	C Inch (mm)	D Inch (mm)	E Inch (mm)	F Inch (mm)	Cubic Inch Capacity	Catalog Number
For 20A and 30A Watertight Safety-Shroud Twist-Lock Receptacles and Inlets	1"	6.80" (172.4)	5.63" (142.9)	6.60" (167.0)	4.50" (114.3)	3.74" (95.0)	-	45.27" <b>AB203055</b>

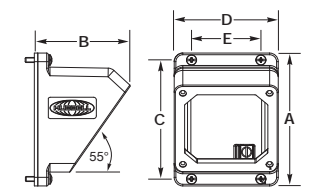

## 55° Angle Metallic Adapter with Grounding Lug

Description	A Inch (mm)	B Inch (mm)	C Inch (mm)	D Inch (mm)	E Inch (mm)	F Inch (mm)	Cubic Inch Capacity	Catalog Number
For 20A and 30A Watertight Safety-Shroud Twist-Lock Receptacles and Inlets	4.89" (124.8)	3.33" (84.8)	4.29" (109.1)	3.75" (95.3)	2.50" (63.5)	-	25.00"	<b>AA203055</b>



## Straight Watertight Wall Box Adapter

Description	Catalog Number
Adapts 20A and 30A Watertight Safety-Shroud Twist-Lock receptacles and inlets to 2-gang, device mount, FD boxes.	<b>HBL2030AP</b>



## Non-Watertight Angle Wall Box Adapter

Description	Catalog Number
Adapts 20A and 30A Watertight Safety-Shroud Twist-Lock receptacles to 1- or 2-gang standard wall boxes (4" or 4 1/16" square).	<b>AA2030PS</b>

Dimensions in Inches (mm)

Twist-Lock® Devices  
**50 Amp Plugs and Connector Bodies**  
*Features and Benefits*

**The Difference Is Insulgrip® ...and a Whole Lot More**

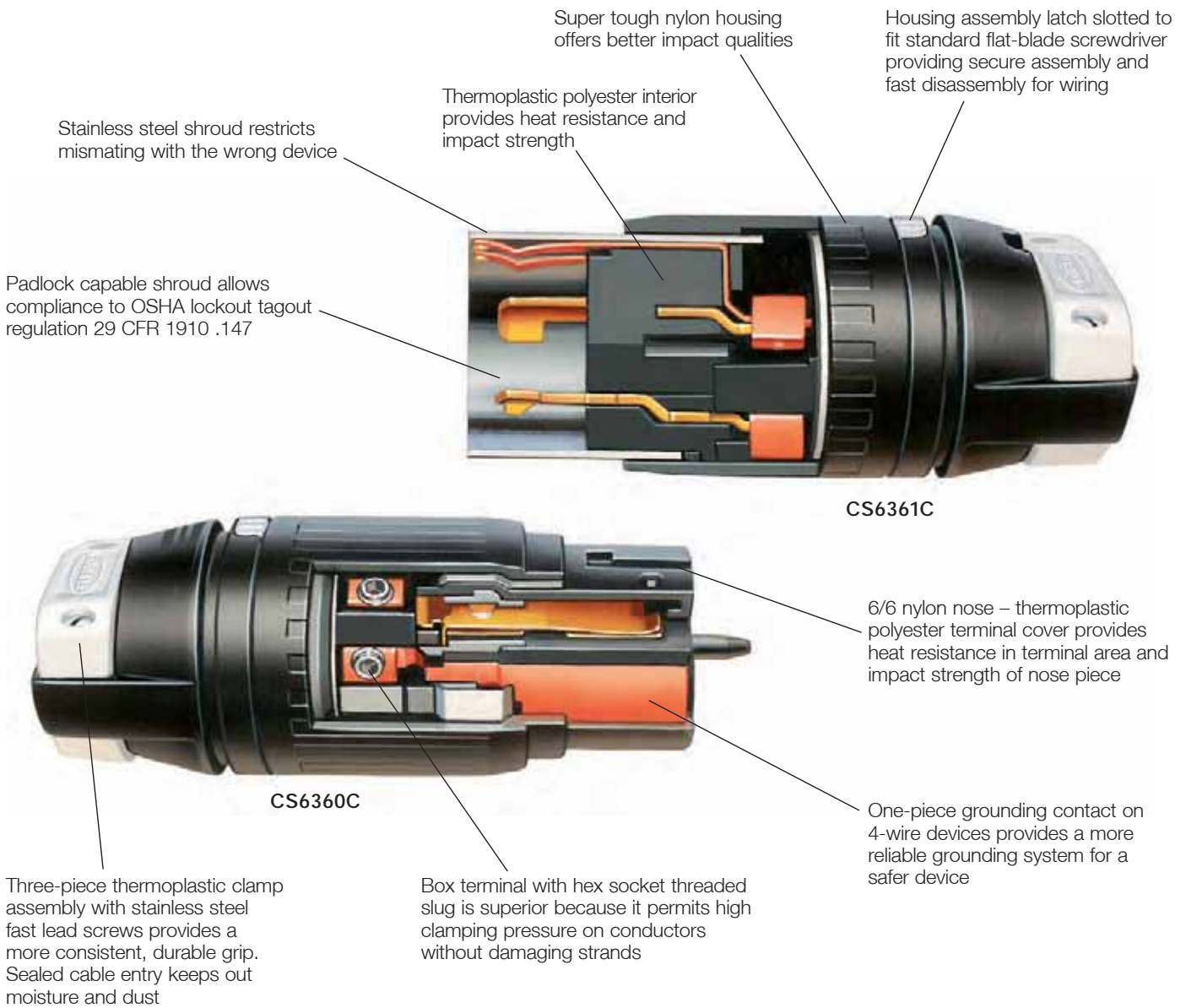

Hubbell's 50 amp Twist-Lock® devices features heavy-duty design built for heavy-duty applications. These Hubbell 50 amp Twist-Lock plugs and connector bodies are built to go where you need power, even in some of the harshest environments.

On the outside, 50 amp plugs and connectors are made of Super tough nylon for better impact resistance. On the plug, the stainless steel shroud not only provides protection and durability, but safety as well. That's because the rigid construction restricts distortion, thus minimizing the possibility of mating incorrect devices.

On the inside are the kinds of features that separate Hubbell from all the rest. The cord grip has been designed with offset gripping jaws to securely hold the conductors – not just the cord jacket. Hubbell's box terminals speed wiring and provide a superior termination. The plug's thermoplastic polyester interior provides excellent heat resistance without compromising strength.

In all, it's the combination of function and performance that Hubbell demands of all its products. And it's why we'll never add a feature that compromises performance.



**IP20**  
 SUITABILITY



## Plugs

Description	Cord Dia.	Catalog Number		
Nylon housing, thermoplastic polyester interior.	.830"-1.250" (21.08-31.75)	<b>CS6361C</b>	<b>CS8265C</b>	<b>CS8465C</b>

Note: See page B-60 for accessories.



## Flanged Inlets

Description	Catalog Number		
Zinc plated steel casing, thermoset interior.	<b>CS6377†</b>	<b>CS8275</b>	<b>CS8475†</b>



**IP20**  
 SUITABILITY



## Connector Bodies

Description	Cord Dia.	Catalog Number		
Nylon housing, thermoplastic polyester interior.	.830"-1.250" (21.08-31.75)	<b>CS6360C</b>	<b>CS8264C</b>	<b>CS8464C</b>

Note: See page B-60 for accessories.



## Receptacles

Description	Catalog Number		
Black phenolic.	<b>CS6370</b>	<b>CS8269</b>	<b>CS8469†</b>

Note: See page B-60 for accessories.  
 See page B-71 for technical information.  
 †Not CSA Certified.

Dimensions in Inches (mm)



Twist-Lock® Devices  
 50 Ampere, 125/250, 3Ø 250 Volts and 3Ø 480 Volts AC  
 3 Pole, 4 Wire Grounding



**IP20**  
SUITABILITY



**Plugs**

Description	Cord Dia.	Catalog Number		
Nylon cover, thermoplastic polyester interior.	.830"-1.250" (21.08-31.75)	<b>CS6365C</b>	<b>CS8365C</b>	<b>CS8165C</b>

Note: See page B-60 for accessories.

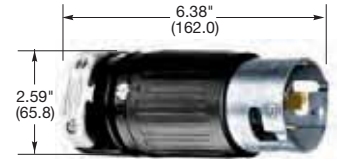

**CS6365C**

**Flanged Inlets**

Description	Catalog Number		
Zinc plated steel casing, thermoset interior.	<b>CS6375</b>	<b>CS8375</b>	<b>CS8175</b>
Zinc plated steel casing, thermoset interior with lift cover.	<b>CS6375M2</b>	-	-
Gray Valox® housing and flange.	<b>HBL6375S*</b>	-	-

Note: \*Type 3R.

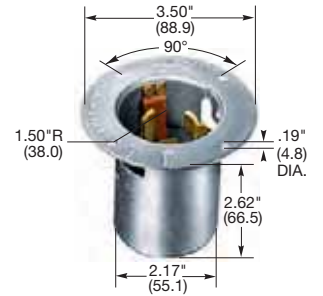

**CS6375**

**IP20**  
SUITABILITY



**Connector Bodies**

Description	Cord Dia.	Catalog Number		
Nylon cover, thermoplastic polyester interior.	.830"-1.250" (21.08-31.75)	<b>CS6364C</b>	<b>CS8364C</b>	<b>CS8164C</b>

Note: See page B-60 for accessories.

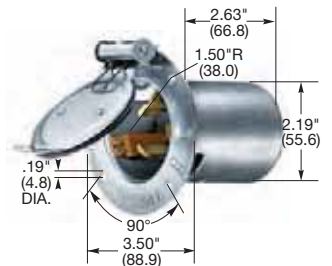

**CS6375M2**

**Receptacles**

Description	Catalog Number		
Black phenolic.	<b>CS6369</b>	<b>CS8369</b>	<b>CS8169</b>

Note: See page B-60 for accessories.



**CS6364C**

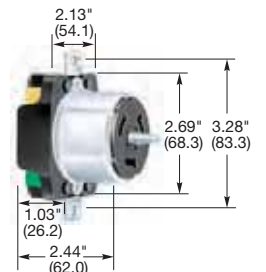

**CS6369**

Valox® is a trademark of SABIC Innovative Plastics, acquired from General Electric Company.

Dimensions in Inches (mm)



**HBL3763C**

**IP20**  
SUITABILITY



### Plugs

Description	Cord Dia.	
Nylon housing, thermoplastic polyester interior.	.830"-1.250" (21.08-31.75)	<b>HBL3763C</b>

*Note: See page B-60 for accessories.*

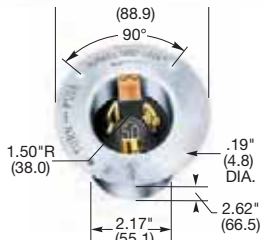

**HBL3777**

### Flanged Inlets

Description	
Zinc plated steel casing, thermoset interior.	<b>HBL3777</b>
Zinc plated steel casing, thermoset interior with lift cover.	<b>HBL3767</b>

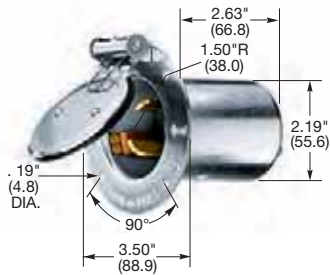

**HBL3767**

**IP20**  
SUITABILITY



### Connector Bodies

Description	Cord Dia.	
Nylon housing, thermoplastic polyester interior.	.830"-1.250" (21.08-31.75)	<b>HBL3762C</b>

*Note: See page B-60 for accessories.*

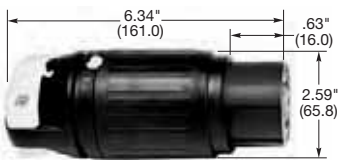

**HBL3762C**

### Receptacles

Description	
Black phenolic.	<b>HBL3771</b>

*Note: See page B-60 for accessories.  
 See page B-71 for technical information.*

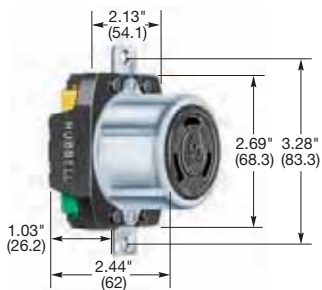

**HBL3771**

Dimensions in Inches (mm)

Twist-Lock® Devices  
 50 Ampere, 250 Volts DC and 600 Volts AC  
 3 Pole, 4 Wire Grounding



**Important Note:** Catalog numbers HBL7765C, HBL7958, HBL7968, HBL7764C, HBL7379 are for replacement use only. See other singly rated 50A Twist-Lock® devices in this section. HBL3700 series Twist-Lock devices do not interchange with any other devices in this section.

### Plugs

Description	Cord Dia.	Catalog Number	
Nylon cover, thermoplastic polyester interior.	.830"-1.250" (21.08-31.75)	HBL3765C	HBL7765C

Note: See page B-60 for accessories.

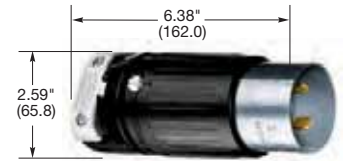

HBL3765C

### Flanged Inlets

Description	Catalog Number	
Zinc plated steel casing, thermoset interior.	HBL3775	HBL7958
Zinc plated steel casing, thermoset interior with lift cover.	HBL3768	HBL7968

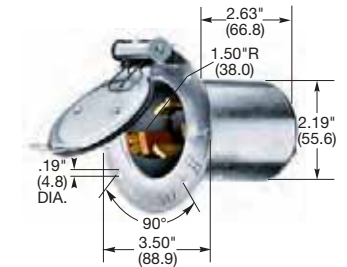

HBL3768

### Connector Bodies

Description	Cord Dia.	Catalog Number	
Nylon cover, thermoplastic polyester interior.	.830"-1.250" (21.08-31.75)	HBL3764C	HBL7764C

Note: See page B-60 for accessories.



HBL3775

### Receptacles

Description	Catalog Number	
Black phenolic.	HBL3769	HBL7379

Note: See page B-60 for accessories.

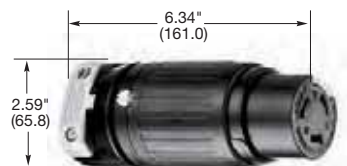

HBL3764C

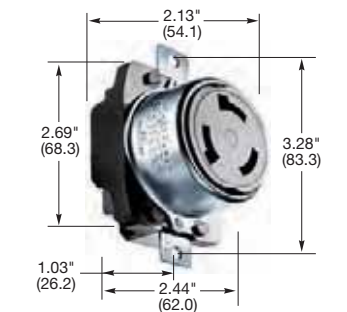

HBL3769

Dimensions in Inches (mm)



HBL7774WO



HBL7382



HBL7382



HBL50SC



SS750



HBL7716C



HBL7717C



HBL4892



HBLCSCK

**IP44**  
SUITABILITY

**Weatherproof Receptacle Lift Cover Plates for FS/FD Box Mounting**

Description	Catalog Number
Corrosion resistant, gray thermoplastic.	HBL7774WO
Same as above except yellow.	HBL77CM74WO
Cast aluminum.	HBL7770

Note: See section N for additional information on weatherproof plates.

**Receptacle Plates for FS/FD Box Mounting**

Description	Catalog Number
Cast aluminum with lift cover.	HBL7382**
Same as above less lift cover.	HBL7383•
Stainless steel, single gang, wallplate.	SS750▲

**Receptacle ½" Raised Cover**

Description	Catalog Number
Galvanized Steel fits 4" square or 2-gang box.	HBL50SC▲

**IP55\*\***  
SUITABILITY

**Weatherproof Boots**

Description	Catalog Number
Seal-Tite® triple seal black elastomeric cover for plugs when used in a cord set and connector bodies when used with flanged inlets.	HBL7716C†
Seal-Tite triple seal black elastomeric cover for connector bodies when used with cord sets.	HBL7717C†

**Inlet Closure Plug**

Description	Catalog Number
Black closure plug.	HBL4892†

**Replacement Parts**

Description	Catalog Number
Cord clamp Kit.	HBLCSCK

Note: •Will only fit non-"CS" type 50A Twist-Lock receptacles.

\*Not UL Listed "WDL Closed".

\*\*When installed and used properly with plug and connector body combinations.

▲IP20 SUITABILITY.

†Not UL Listed.

Hubbellok® Devices  
**Plugs and Connector Bodies**  
*Features and Benefits*

Three-piece thermoplastic clamp assembly with fast-lead stainless screws provides a more consistent durable grip. Grommets provide a sealed cable entry that protects against the entry of moisture and dust

Impact resistance in the interior of the female device comes from a strong thermoplastic material

No "lazy" connections because a spring-loaded safety shutter automatically ejects the plug if it hasn't been properly locked into the female device. This eliminates teasing of the contacts, a major cause of contact burn-up

Longer contact life is assured by supplementary springs. Other devices rely just on contacts themselves to provide proper contact pressure

Insulated non-metallic housing enhances safety and abuse resistance

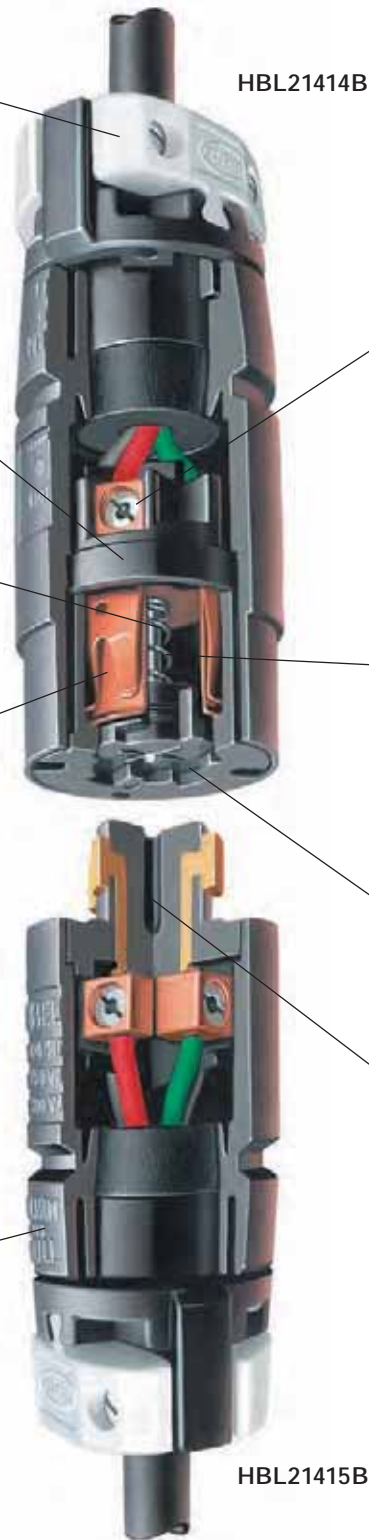

Superior wire terminations are assured with box terminals and screws with pressure pads. This design captures stray wire strands and permits more clamping pressure on the wire without damaging it. Loosening of terminations and resulting heat build-up are greatly reduced

Arcs are snuffed out, when devices are mated or unmated under load, by spring-loaded safety shutter

Enhanced safety because access to live female contacts is restricted by the spring-loaded safety shutter

Positive locking is ensured by the nose of the plug being keyed into a detent in female device. This lock is independent of the contacts or a separate mechanical lock

*Note: Above cut-away view and call-outs are construction elements pertaining specifically to the 30A Hubbellok series. While the Hubbellok contact interface design applies to all, there are construction elements that are different, depending on the amperage.*



**HBL23035B**

**IP30**  
SUITABILITY



**20A 125V**

### Plug

Description	Cord Dia.	Catalog Number
Nylon housing, thermoset interior.	.320"-.660" (8.12-16.5)	<b>HBL23035B</b>



**HBL23032B**



**20A 125V**

### Connector Body

Description	Cord Dia.	Catalog Number
Nylon housing, thermoset interior.	.320"-.660" (8.12-16.5)	<b>HBL23032B</b>

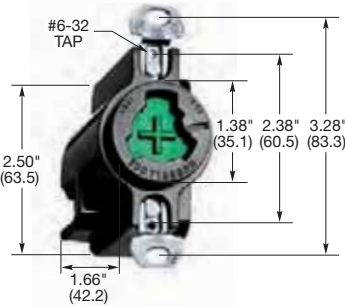

**HBL23030**



**20A 125V**

### Receptacle

Description	Catalog Number
Black phenolic, back wired.	<b>HBL23030</b>

*Note: Devices listed above are not interchangeable with any other Hubbellock device listed in this catalog.*

### Accessories

#### Weatherproof Covers

Description	Catalog Number
Gray polycarbonate for FS/FD box mounting, corrosion resistant. IP44 SUITABILITY.	<b>HBL7423WO</b>
Same as above except yellow.	<b>HBL74CM23WO</b>
Cast aluminum, lift cover for indoor use only.	<b>HBL23007</b>
Stainless steel 302/304, single receptacle wallplate.	<b>SS7</b>
Stainless steel 430, single receptacle wallplate.	<b>SS7L</b>



**HBL7423WO**



**HBL23007**

Dimensions in Inches (mm)

# Hubbellock® Devices

20 Ampere, 125 Volts AC or DC, 10 Ampere, 250 Volts DC, 480 Volts AC

2 Pole, 3 Wire Grounding

## Plug

Description	Cord Dia.	Catalog Number
Nylon housing, thermoset interior.	.320"-.660" (8.12-16.5)	<b>HBL23005GB</b>

**IP30**  
SUITABILITY



20A 125V

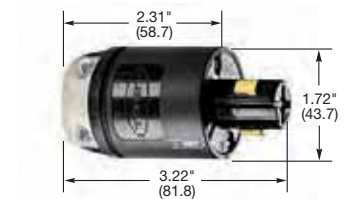

**HBL23005GB**

## Connector Body

Description	Cord Dia.	Catalog Number
Nylon housing, thermoset interior.	.320"-.660" (8.12-16.5)	<b>HBL23002GB</b>



20A 125V



**HBL23002GB**

## Receptacle

Description	Catalog Number
Black phenolic, back wired.	<b>HBL23000G</b>



20A 125V

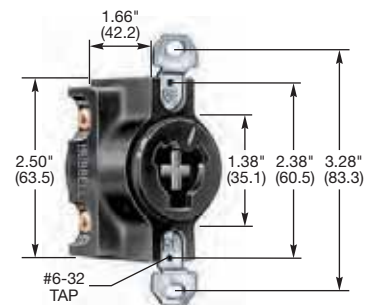

**HBL23000G**

## Accessories

### Weatherproof Covers

Description	Catalog Number
Gray polycarbonate for FS/FD box mounting, corrosion resistant. IP44 SUITABILITY.	<b>HBL7423WO</b>
Same as above except yellow.	<b>HBL74CM23WO</b>
Cast aluminum, lift cover for indoor use only.	<b>HBL23007</b>
Stainless steel 302/304, single receptacle wallplate.	<b>SS7</b>
Stainless steel 430, single receptacle wallplate.	<b>SS7L</b>



**HBL7423WO**



**HBL23007**

Dimensions in Inches (mm)



**IP30**  
 SUITABILITY

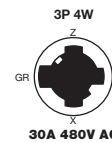

## Plugs

Description	Cord Dia.	Catalog Number		
Black nylon housing, thermoplastic interior.	.700"-1.200" (17.78-30.5)	<b>HBL21415B</b>	-	-
Same as above except corrosion resistant.	.700"-1.200" (17.78-30.5)	<b>HBL21CM415B</b>	-	-
Red nylon housing, thermoset interior.	.700"-1.200" (17.78-30.5)	-	<b>HBL20445B<sup>†</sup></b>	-
Black nylon housing, thermoset interior, steel shroud.	.700"-1.200" (17.78-30.5)	-	-	<b>HBL25415B</b>

Note: See page B-68 for accessories.  
<sup>†</sup>Not CSA Certified.

## Flanged Inlets

Description	Catalog Number		
Weathertight, corrosion resistant, nickel plated brass plate, for FS/FD box mounting.	<b>HBL22CM428</b>	-	-
Black phenolic interior, aluminum housing, for FS/FD box mounting (not shown).	<b>HBL20418</b>	-	-
Aluminum angle housing, with 3/4" NPT hub for surface mounting.	<b>HBL21447</b>	-	-



**SEHBL3** - Switched enclosure for use with 3 pole 4 wire 30A Hubbellok receptacle. Receptacle not included. See page B-37 for additional information.

Dimensions in Inches (mm)



**IP30**  
SUITABILITY

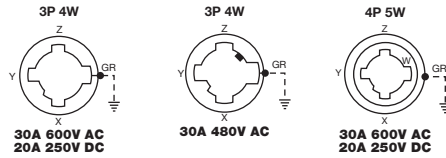

## Connector Bodies

Description	Cord Dia.	Catalog Number		
Black nylon housing, thermoplastic interior.	.700"-1.200" (17.78-30.5)	<b>HBL21414B</b>	-	-
Same as above except corrosion resistant.	.700"-1.200" (17.78-30.5)	<b>HBL21CM414B</b>	-	-
Red nylon housing, thermoset interior.	.700"-1.200" (17.78-30.5)	-	<b>HBL20444B</b>	-
Black nylon housing, thermoplastic interior.	.700"-1.200" (17.78-30.5)	-	-	<b>HBL25414B</b>

Note: See page B-68 for accessories.



**HBL21414B**



**HBL20444B**



**HBL25414B**

## Receptacles

Description	Catalog Number		
Black phenolic.	<b>HBL20403</b>	-	-
Weathertight, corrosion resistant, nickel plated brass plate, for FS/FD box mounting. IP44 SUITABILITY.	<b>HBL22CM427</b>	-	-
Aluminum angle housing, with 3/4" NPT hub for surface mounting. IP44 SUITABILITY.	<b>HBL21420</b>	-	-
Black phenolic, red center insert.	-	<b>HBL20443</b>	-
Black phenolic interior, aluminum housing, blue finish, for FS/FD box mounting.	-	-	<b>HBL25403</b>
Black phenolic interior, aluminum weatherproof housing, blue finish for FS/FD box mounting. IP44 SUITABILITY.	-	-	<b>HBL25250</b>

Note: See page B-68 for accessories.

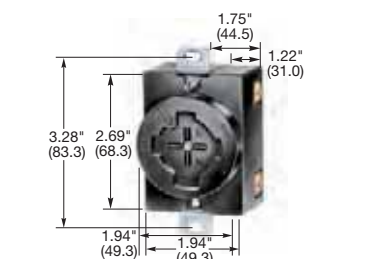

**HBL20403**

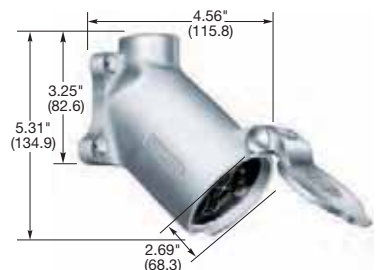

**HBL21420**

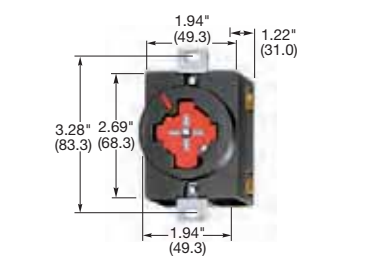

**HBL20443**

## Receptacle Accessories

Description	Catalog Number
Thermoplastic, wet and damp locations with cover "open", gray.	<b>HBL7428WOG*</b>
Thermoplastic, wet and damp locations with cover "open", yellow.	<b>HBL7428WOY*</b>
Thermoplastic, wet and damp locations with cover "open", red.	<b>HBL7428WOR*</b>
Cast aluminum, wet locations only when cover "closed" and damp locations, lift cover plate.	<b>HBL20405</b>
Cast aluminum, wet locations only when cover "closed" and damp locations, red finish.	<b>HBL20446</b>
302/304 stainless, single gang, smooth. NOT weatherproof.	<b>SS737</b>

Note: \*Features two #6-32 threaded inserts to back mount device to cover.

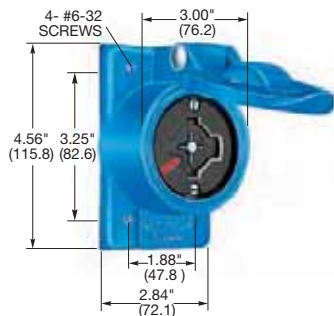

**HBL25250**

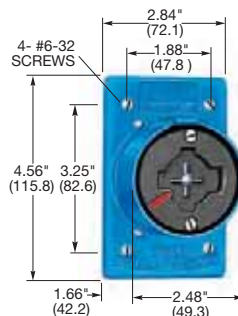

**HBL25403**

Dimensions in Inches (mm)



**IP30**  
SUITABILITY

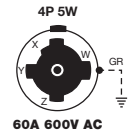
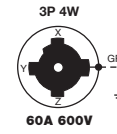

## Plugs

Description	Cord Dia.	Catalog Number	
Black phenolic interior with yellow thermoplastic sleeve over steel housing.	.920"-1.450" (23.36-36.83)	<b>HBL26419</b>	-
Black phenolic interior with blue thermoplastic sleeve and steel housing.	1.00"-1.50" (25.40-38.10)	-	<b>HBL26519</b>

**IP30**  
SUITABILITY

## Flanged Inlets

Description	Catalog Number	
Black phenolic interior with steel housing and flange.	<b>HBL26422</b>	-
Black phenolic interior with steel housing and flange with blue finish.	-	<b>HBL26522</b>

Dimensions in Inches (mm)

**IP30**  
SUITABILITY

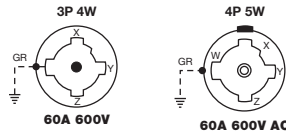

## Connector Bodies

Description	Cord Dia.	Catalog Number	
Black phenolic interior with yellow thermoplastic sleeve over steel cover.	.920"-1.450" (23.36-36.83)	<b>HBL26418</b>	-
Black phenolic interior with blue thermoplastic sleeve over steel cover.	1.00"-1.50" (25.40-38.10)	-	<b>HBL26516</b>



**IP44**  
SUITABILITY

## Receptacles

Description	Catalog Number	
Black phenolic interior with short aluminum housing and lift cover.	<b>HBL26410</b>	-
Black phenolic interior with long aluminum housing and lift cover.	<b>HBL26420</b>	-
Black phenolic interior with long aluminum housing with lift cover and blue finish.	-	<b>HBL26520</b>



**IP30**  
SUITABILITY

## Flanged Receptacles

Description	Catalog Number	
Black phenolic interior with steel housing and flange.	<b>HBL26421</b>	-
Black phenolic interior with steel housing and flange with blue finish.	-	<b>HBL26521</b>



## Receptacle Box and Adapter Plates (Box requires one adapter)

Description	Catalog Number
Box, cast aluminum, only for 60A Hubbell receptacles.	<b>HBL26401</b>
Straight adapter plate.	<b>HBL26402</b>
45° adapter plate.	<b>HBL26404</b>

*Note: Straight or angle adapter plate must be used when mounting a 60A receptacle to HBL26401 box. Cannot be used with round flanged receptacles and inlets. See page B-68 for additional information.*

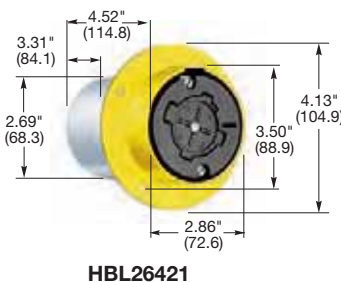

Dimensions in Inches (mm)

### 30 Amp Hubbellock® Accessories

#### Receptacle Plates for FS/FD Box Mounting

Description	Catalog Number
Thermoplastic, wet and damp locations with cover "open", gray.	HBL7428WOG*
Thermoplastic, wet and damp locations with cover "open", yellow.	HBL7428WOY*
Thermoplastic, wet and damp locations with cover "open", red.	HBL7428WOR*
Cast aluminum, wet location only when cover "closed" and damp locations, lift cover plate.	HBL20405
Cast aluminum, wet location only when cover "closed" and damp locations, red finish.	HBL20446
302/304 stainless, single gang, smooth. NOT weatherproof.	SS737

Note: \*Features two #6-32 threaded inserts to back mount device to cover.



HBL20405

**IP54**  
SUITABILITY

#### Switched Enclosure

Description	Catalog Number
Switched enclosure for use with 30A 3 pole 4 wire Hubbellock receptacle. Receptacle not included.	SEHBL3

Note: For more information on switched enclosures see page B-37.



SEHBL3

#### Liquidtight Metallic Conduit Adapters (Not Shown)

Description	Catalog Number
Adapter for use with 1/2" NPT conduit fittings.	SAB12
Adapter for use with 3/4" NPT conduit fittings.	SAB34

#### Boots

Description	Catalog Number
"Mini" boot for Hubbellock connector body.	HBL20424B†
"Mini" boot for Hubbellock plug.	HBL20425B†

Note: †Not UL Listed or CSA Certified.



SAB34

### 60 Amp Hubbellock® Accessories

#### Receptacle Box and Adapter Plates (Box requires one adapter)

Description	Catalog Number
Box, cast aluminum, only for 60A Hubbellock receptacles.	HBL26401
Straight adapter plate.	HBL26402
45° adapter plate.	HBL26404

Note: Straight or angle adapter plate must be used when mounting a 60A receptacle to HBL26401 box. Cannot be used with round flanged receptacles and inlets.



HBL20424B

#### Kellems® Cable Grip

Description	Cord Diameter	Catalog Number
Cable grip.	.830"-1.000" (21.1-25.4)	H660A
Cable grip (not shown).	1.000"-1.140" (25.4-28.9)	H661A
Cable grip (not shown).	1.125"-1.328 (28.6-33.7)	H662A



HBL20425B

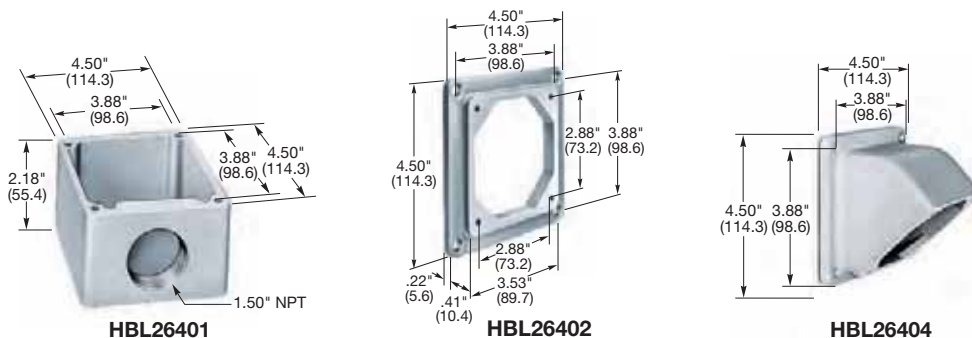

H660A

Dimensions in Inches (mm)

# Twist-Lock® and Safety Shroud Devices

## Technical Information

15-30 Ampere Twist-Lock, 20-30 Ampere Safety-Shroud® Twist-Lock

### Specifications

#### Listings

Listed to UL Standard 498 (Attachment Plugs and Receptacles).

Fed. Spec. W-C-596 (Insulgrip® and Safety-Shroud®).

Certified to CSA Standard C22.2 No.42 (General Use Receptacles, Attachment Plugs and Similar Wiring Devices).

#### Plugs and Connector

Bodies (Insulgrip®)	15-30A
Blade/Contact Carrier	Natural (white) nylon
Terminal Retainer	Clear polycarbonate
Cover (Housing)	Black nylon (yellow in "CM" devices)
Cord Clamp	Natural (white) nylon
Dust Shield	EPDM
Blades/Contacts	Brass
Terminal Clamp	Cold rolled steel – nickel plated
Terminal Screws	15A (8-32), 20-30A (10-32) Brass (white finish on neutral screw when used)
Grounding Screw	Brass (green finish)
Cord Clamp Screws	Steel, zinc plated
Body Holding Screws	Steel, zinc plated

#### Flanged Inlet/Receptacles

	15-30A
Flanged Casing	Natural (white) nylon
Blade/Contact Carrier	Natural (white) nylon
Terminal Retainer	Clear polycarbonate
Blades/Contacts	Brass
Drive Screws	Steel, zinc plated
Terminal Clamp	Cold rolled steel, nickel plated
Terminal Screws	15A (8-32), 20-30A (10-32) Brass (white finish on neutral screw when used)
Grounding Screw	Brass (green finish)
Mounting Screws	Nickel plated brass round head screws
Screw Sizes	15A: 6-32, 3/8" long 20A and 30A: 8-32, 7/16" long

Receptacle, Single	15A	20A and 30A
Cover (Top)	Nylon (Black)	Nylon (Black)
Base	RTP (Black)	RTP (Natural)
Contact Springs	.031" Brass	.040" Brass
Clamp	.031" Brass	.040" Brass
Ground Contact	.031" Brass	.040" Brass
Ground Shunt	–	.015" Brass
Bridge (Mounting Strap)	.050" Steel, zinc plated	–
End Plates (Mounting)	–	.050" Brass
Back Plate	–	.040" Brass
Terminal Screws	Brass (8-32)	Brass (10-32) (white finish on neutral screw when used)
Grounding Screw	Brass (Green)	Bronze (Green)
Flat Head Mounting Screws	Steel, zinc plated	Steel, zinc plated
Auto Ground Clip	Stainless steel	Stainless steel (Used only on IG receptacle)

#### Safety-Shroud® Receptacles Angle, Surface Semi-Flush

	20-30A
Housing and Mounting Flange	Gray Valox®
Mounting Plate (Angle Housing Only)	Galvanized steel
Body Contact Carrier	Natural (white) nylon
Terminal Retainer	Clear polycarbonate
Body Holding Screws	Steel, zinc plated
Contact Springs	Brass
Spring Binding Plate	Brass
Terminal Clamp	Steel, nickel plated .080" curved, scalloped
Terminal Screws	10-32 Brass (white finish on neutral screw when used)
Grounding Screw	Brass (green finish)
Mounting Plate Screws	Steel, zinc plated
Wallplate Mounting Screws	Steel, zinc plated

#### Safety-Shroud® Twist-Lock® Plug

	20-30A
Insulgrip Plug with Safety-Shroud installed	
Safety-shroud	White Valox®
Cord Clamp	White nylon

#### Performance (Twist-Lock® and Safety Shroud Devices)

Electrical	
Dielectric Voltage	Withstands 2,000V minimum.
Max. Working Voltage	600 Volts RMS.
Current Interrupting	Certified for current interrupting at full rated current.
Temperature Rise Fed. Spec.	Max 30°C temperature rise at full rated current after 250 cycles of overload at 200% of rated current at a power factor of 75% (WC 596).

#### Mechanical (Twist-Lock® and Safety Shroud Devices)

Cord Accommodation (Plugs and connectors only)	Round portable service cords of diameters commensurate with the device rating as defined in UL Standard 62, CSA C22.2 No. 49.
Cord Grip Accommodation (Insulgrip)	15A: .230"-.720" (5.8-18.3); 20A and 30A 3W: .360"-.930" (9-24); 20A and 30A 4W-5W: .350"-.1.150" (9-29).
Terminal Identification	Terminals identified in accordance with UL 498 (X, Y, Z, White, Green).
Terminal Accommodation	20A and 30A, #16-#8 AWG. 15A, #18-#10 AWG. Solid or stranded copper wire only.
Product Identification	Ratings are a permanent part of the device housing.

#### Environmental (Twist-Lock® and Safety Shroud Devices)

Flammability (Enclosure)	HB or better per UL94/CSA 22.2 No. 0.17.
Plugs, Connectors, Flanged Receptacles and Flanged Inlets Receptacles (Box Mount)	V2 or better.
Operating Temperatures	Maximum Continuous 75°C. Minimum -40°C (w/o impact).

Valox® is a trademark of SABIC Innovative Plastics, acquired from General Electric Company.

# Watertight Safety-Shroud® Twist-Lock® Devices

## Technical Information

20 and 30 Ampere

### Specifications

#### Listings

Listed to UL Standard 498 (Attachment Plugs and Receptacles).  
 Certified to CSA Standard No.42 (General Use Receptacles, Attachment Plugs and Similar Wiring Devices).  
 Fed. Spec. WC-596.  
 UL Listed, CSA Certified to Type 4, 4X and Type 12.

Part	Materials
<b>Watertight Safety-Shroud® Plug (Insulgrip®)</b>	<b>20 and 30A</b>
Blade Holder	Natural (white) nylon
Terminal Retainer	Clear polycarbonate
Cover (Housing)	Black Valox®
Cord Clamp	White Valox®
Blades	Brass
Terminal Clamp	Steel, nickel plated .080" curved scalloped
Terminal Screws	10-32 brass (white finish on neutral screw when used) multiple drive head
Grounding Screw	Brass (green finish) combination head
Cord Clamp Screws	Stainless steel 302/304, combination head
Body Holding Screws	Stainless steel 302/304, combination head
Closure Cap and Strap	Neoprene EPDM Blend

<b>Watertight Safety-Shroud® Connector (Insulgrip®)</b>	<b>20 and 30A</b>
Body Contact Carrier	Natural (white) nylon
Terminal Retainer	Clear polycarbonate
Contact Spring	Brass
Spring Binding Plate	Brass
Cover (Housing)	Black Valox®
Cord Clamp	White Valox®
Terminal Clamp	Steel, nickel plated .080" curved scalloped
Terminal Screws	10-32 brass (white finish on neutral screws when used) multiple drive head
Grounding Screw	Brass (green finish) combination head
Cord Grip Screws	Stainless steel 302/304, combination head
Body Holding Screws	Stainless steel 302/304, combination head
Closure Cap and Strap	Polypropylene with Neoprene gasket

<b>Watertight Safety-Shroud Receptacle, Single*</b>	<b>20 and 30A</b>
Housing and Flange	Gray Valox
Body Contact Carrier	Natural (white) nylon
Terminal Retainer	Clear polycarbonate
Drive Screws	Steel, zinc plated
Contact Spring	Brass
Spring Binding Plate	Brass
Terminal Clamp	Steel, nickel plated .080" curved, scalloped
Flange Gasket	Closed-cell neoprene foam
Lid Gasket	Closed-cell neoprene foam
Cover Hinge Pin	Stainless steel 302/304
Cover Spring	Stainless steel 302/304
Terminal Screws	10-32 brass (white finish on neutral screw when used) multiple drive head
Grounding Screw	Brass (green finish) combination head
Mounting Screws	Stainless steel 302/304 combination head

<b>Watertight Safety-Shroud® Flanged Inlet</b>	<b>20 and 30A</b>
Housing and Flange	Gray Valox
Blade Holder	Natural (white) nylon
Terminal Retainer	Clear polycarbonate
Blades	Brass
Drive Screws	Steel, zinc plated
Terminal Clamp	Steel, nickel plated .080" curved scalloped
Terminal Screws	10-32 brass (white finish on neutral screw when used) multiple drive head
Grounding Screw	Brass (green finish) combination head
Closure Cap	Neoprene EPDM blend
Mounting Screws	Stainless steel 302/304 combination head

### Performance

Electrical	
Dielectric Voltage	Withstands 2,000V minimum.
Max. Working Voltage	600 Volts RMS.
Current Interrupting	Certified for current interrupting at full rated current.
Temperature Rise	Max 30°C temperature rise at full rated current after 250 cycles of overload at 200% of rated current at a power factor of 75% (WC 596).

Mechanical	
Cord Accommodation (Plugs and connectors only)	Round portable service cords of diameters commensurate with the device rating as defined in UL Standard 62, CSA C22.2 No. 49.
Cord Grip Accommodation	20 and 30A, 3W: .32"- .93" (8.1-24.0mm) #16-3 Type SJ-#8-3 Type S, SO; 20 and 30A, 4W: .35"-1.15" (9.0-29.2mm) #16-4 Type SJ-#8-4 Type S, SO; 20 and 30A, 5W: .35"-1.15" (9.0-29.2mm) #16-5 Type S, SO - #8-5 Type S, SO. Terminals identified in accordance with UL 498 (X, Y, Z, White, Green).
Terminal Identification	#16- #8 AWG solid or stranded copper wire only.
Terminal Accommodation	Ratings are a permanent part of the device blade holder, and are also labeled on device color coded by voltage, visible in use. Catalog No. I.D. is on device visible in use.
Product Identification	

Environmental	
Moisture Resistance	Type 4, 4X, 12, IP66 suitability.
Flammability (Enclosure)	V0 per UL94 or CSA 22.2 No. 0.17.
Operating Temperatures	Maximum Continuous 75°C; Minimum -40°C (w/o impact).

Note: \*Suitable for use as a flanged receptacle.

Valox® is a trademark of SABIC Innovative Plastics, acquired from General Electric Company.

## Specifications

### Listings

Listed to UL Standard 498 (Attachment Plugs and Receptacles).

Certified to CSA Standard No. 42 (General Use Receptacles, Attachment Plugs and Similar Wiring Devices).

Part	Materials
<b>Plug (Twist-Lock)</b>	<b>50A</b>
Blade Holder	Thermoplastic polyester (black)
Power Blades	Brass
Terminal Set Screw	Stainless steel
Terminal Retainer	Thermoplastic polyester
Front and Rear (housing)	Supertough nylon
Cord Clamp	Thermoplastic polyester (white)
Seal	Neoprene
Seal Cup	Nylon
Box Terminal	Copper
Latches	Supertough nylon
Ground Contact Spring	One piece copper/nickel
Cord Clamp Screws	302/304 Stainless steel
Shroud	302/304 Stainless steel

Part	Materials
<b>Connector (Twist-Lock)</b>	<b>50A</b>
Contact Nose	Nylon (black)
Terminal Retainer	Thermoplastic polyester (black)
Terminal Set Screw	302/304 Stainless steel
Contact Spring	Brass
Assembly Ring	302/304 Stainless steel
Front and Rear (housing)	Supertough nylon (black)
Latches	Supertough nylon (white)
Cord Clamp	Thermoplastic polyester (white)
Box Terminal	Copper
Contact Holder	Thermoplastic polyester (black)
Ground Contact	One piece copper/nickel
Seal Cup	Nylon
Cord Grip screws	302/304 Stainless steel
Seal	Neoprene

Part	Materials
<b>Flanged Inlet</b>	<b>50A</b>
Flanged Casing	.062" Steel, zinc plate
Blade Holder	Phenolic
Pressure Screws	Steel, zinc plate
Blades	.100" Brass
Ground Spring	.025" Bronze
Terminals	.050" Steel, brass finish
Grounding Terminal	.062" Copper, green finish
Round Head Screws	Steel, zinc plate

Part	Materials
<b>Receptacle</b>	<b>50A</b>
Body	Phenolic
Face	Phenolic
Contact Springs	.100" Brass alloy
Contact Binding Plates	.100" Brass
Ground Contact	.031" Brass
Insulator	.093" Laminated phenolic
Bridge (Mounting Strap)	.062" Steel, zinc plate
Pressure Screws	Steel, zinc plate
Terminals	.050" Steel
Casing	.062" Steel, zinc plate
Center Pin (CS Devices)	Steel, zinc plate

## Product Identification

Ratings	Molded into face for all devices and stamped into stainless steel shroud on plug devices.
Catalog Number	Molded into face for plug and connector bodies and stamped into stainless steel shroud on plug devices.

## Performance

### Electrical

Dielectric Voltage	Withstands 2,000V minimum.
Max. Working Voltage	600 Volts RMS.
Current Interrupting	Certified for current interrupting at full rated current.
Temperature Rise	Max. 30°C temperature rise at full rated current after 50 cycles of overload at 150% rated DC current (UL 498).

### Mechanical

Terminal Accommodation	#10 AWG min. - #6 AWG max. Solid or stranded copper wire only.
Cord Grip Accommodation	.750"-1.150" (19.1-29.2).

### Environmental

Flammability	UL 94 V0 for Receptacles and Inlets. HB or better for Plugs and Connectors.
Operating Temperatures	Maximum continuous 75°C; minimum -40°C (w/o impact).

Note: Please consult the factory for product dimensions and specifications for other products listed in this catalog.

# Switched Safety Enclosures

## Technical Information

### Switched Twist-Lock® and Hubbellock® Enclosures

#### Specifications

##### Typical Specifications

Manufacturer's Identification	Hubbell SETL3/SEHBL3-SE2730A.
Description	Lockable Switched Enclosure. This unit is a complete enclosure ready to accept any 20 or 30A Twist-Lock or 30A Hubbellock receptacle.
Electrical Type	2 Pole + Earth through 4 Pole and Earth.
Rating	20 or 30A, 125V through 3ØY 347/600V AC.
Configuration	NEMA Locking L5-20R through L23-30R.
Enclosure Type	Outdoor – Type 3R (Rainproof, Sleet, External Ice), IP54 suitability. Indoor – Type 12K (Dust-tight, Falling Dirt, Noncorrosive Liquids, with Knockout).
Enclosure Material	Non-metallic enclosure suitable for metallic conduit.

#### Materials

Part	Materials
Base	Valox®
Top	Valox®
Handle	Valox®
Conduit Hub	Zinc ¾" watertight
Enclosure Gasket	Neoprene
Shaft	Valox®
Shaft Seal	Molded neoprene
Frame	Galvanized steel
Lift Cover	Valox®
Enclosure Screws	Stainless steel 300 series
Hinge Spring and Pin	Stainless steel 300 series

#### Performance

Electrical	
Dielectric Voltage	Withstands 3,000V minimum.
Max. Working Voltage	600V RMS.
Current Interrupting	Certified for current interrupting at full rated current and voltage.
Short Circuit Withstand	Suitable for use on a circuit capable of delivering not more than 10,000 RMS symmetrical amperes at the voltage rating of the receptacle.
Operations	Mechanical 10,000 cycles; Electrical 6,000 cycles.
Mechanical	
Impact Resistance	In accordance with UL 746C.
Terminal Identification	In accordance with UL, CSA and international conventions.
Product Identification	Identification and ratings are part of external label and receptacle face.
Weight	3.5 pounds.
Mounting	External fully adjustable feet.
Environmental	
Moisture Resistance	Outdoor – Type 3R (Rainproof, Sleet, External Ice), IP54 suitability. Indoor – Type 12K (Dust-tight, Falling Dirt, Noncorrosive Liquids, with Knockout).
Flammability	UL94 – 5 VA and V0 classification.
Operating Temperature	Maximum continuous +75°C; Minimum continuous -40°C.
UV Resistance	All materials are UV stabilized.

Note: This device provides on/off switched control of a plug connected load and includes lockout provision: ON-OFF control knob (in the OFF position) accepts up to a 5/16" (8.0) diameter shackle of suitable padlock lockout device to isolate energy from the receptacle and cord connected equipment as a method of compliance to OSHA Lockout/Tagout Regulation 29CFR Part 1910.147.

Valox® is a trademark of SABIC Innovative Plastics, acquired from General Electric Company.



# Switched Safety Enclosures

## Technical Information

### Mechanical Interlock Switched Safety Enclosures

#### Specifications

##### Typical Specifications

Manufacturer's Identification	Hubbell HBLMITL.
Description	Circuit-Lock Mechanical Interlock.
Electrical Type	2 Pole + Earth through 4 Pole and Earth.
Rating	Up to 30A, 3Ø 600V AC.
Enclosure Type	Outdoor – 4X (Watertight, Washdown); Indoor – 12K (Dust-tight, Falling Dirt and noncorrosive liquids with knockout. IP66 suitability.
Enclosure Material	Non-metallic enclosure suitable for metallic conduit.

#### Materials

Part	Material
Base	Valox®
Top	Valox®
Handle	Valox®
Conduit Hub	Zinc ¾" watertight
Enclosure Gasket	Neoprene
Shaft	Valox®
Shaft Seal	Neoprene
Frame	Galvanized steel
Enclosure Screws	Stainless steel 300 series

#### Performance

##### Electrical

Dielectric Voltage	Withstands 3,000V Min.
Max. Working Voltage	600V RMS.
Current Interrupting	Certified for current interrupting at full rated current voltage.
Short Circuit Withstand Rating	Suitable for use on a circuit capable of delivering not more than 10,000 RMS symmetrical amperes at the voltage rating of the receptacle.
Operations	Mechanical 10,000 cycles; Electrical 6,000 cycles.

##### Mechanical

Impact Resistance	In accordance with UL 746C.
Terminal Identification	In accordance with UL, CSA.
Product Identification	Identification and ratings are part of the external label and receptacle face.
Weight	3.5 pounds.
Mounting	External full adjustable feet.

##### Environmental

Moisture Resistance	Outdoor – 4X (Hose-Directed Water, Corrosion Resistance), IP66 suitability.
Flammability	Meets UL 94V0 material classification.
Operating Temperature	Maximum continuous +75°C; Minimum continuous -40°C.
UV Resistance	All exposed materials are UV stabilized.

Valox® is a trademark of SABIC Innovative Plastics, acquired from General Electric Company.

## Specifications

### Plugs

Typical Specification - Catalog No. HBL4723VY.  
 Description - Straight Body Plug  
 Type - 2 Pole, 3 Wire, Grounding  
 Rating - 15 and 20A 125V, 250V, and 277V AC, 30A 125 and 250V  
 Certification - UL Listed File E1706, CSA Certified  
 IP SUITABILITY - **IP20**

### Part

Part	Material
Plug	15, 20 and 30A
Housing	Nylon
Blades	Brass
Ground Blade	Brass
Terminal Screws	Steel multiple drive
Cable Inserts	Polyphenylene Oxide
Terminal Clamps	CR Steel
Body Holding Screws	Steel multiple drive

### Connector Bodies

Typical Specification- Catalog No. HBL4729VY  
 Description - Straight Body Connector  
 Type - 2 Pole, 3 Wire, Grounding  
 Rating - 15 and 20A 125V, 250V, and 277V AC, 30A 125 and 250V  
 Certification - UL Listed File E1706, CSA Certified  
 IP SUITABILITY - **IP20**

### Part

Part	Material
Connector	15, 20 and 30A
Housing	Nylon
Contact and Ground Springs	Brass
Terminal Screws	Steel multiple drive
Cable Inserts	Polyphenylene Oxide
Terminal Clamps	CR Steel
Body Holding Screws	Steel multiple drive

## Performance

### Electrical

Dielectric Voltage Withstands 2,000V minimum.  
 Max. Working Voltage 125V, 250V or 277V AC as rated.  
 Current Interrupting Certified for full rated current.  
 Temperature Rise Max. 30°C temperature rise at full rated current after 50 cycles of overload at 150% rated DC current.

### Mechanical

Terminal Identification Screw Color per UL 498 (Brass, White and Green).  
 Terminal Accommodation 15A-18 to 12AWG. Solid or stranded copper wire only.  
 20A-18 to 10AWG. Solid or stranded copper wire only.  
 30A-14 to 8AWG. Solid or stranded copper wire only.  
 Product Identification Molded rating on device face.  
 Torque 12 in-lb terminal screws, 7 in-lb assembly screws.

### Cord Range

15A .220" to .660" (5.6mm to 16.8mm).  
 20A .325" to .720" (8.26mm to 18.3mm).  
 30A .590" to .930" (15.0mm to 23.6mm).

### Environmental

Flammability UL 94HB.  
 Operating Temperature Maximum continuous 75°C, minimum -40°C (w/o impact).

### Standards

Listed to UL Standard UL498  
 Certified to CSA Standard C22.2 No. 42

# Section C Watertight Devices

## Index

Product	Page
<b>Watertight Safety-Shroud® Twist-Lock® Devices</b>	
20A and 30A Devices . . . . .	C-2
Accessories . . . . .	C-4
<b>Watertight Devices</b>	
15A and 20A, Straight Blade Devices . . . . .	C-6
15A and 20A, Twist-Lock® Devices . . . . .	C-7
20A and 30A, Twist-Lock® Devices . . . . .	C-8
Portable Outlet Boxes, Plates and Accessories . . . . .	C-10
Heavy-Duty Portable Outlet Boxes and Plates . . . . .	C-11
Specifications . . . . .	C-12

### Watertight Safety-Shroud® Twist-Lock®



### Watertight Devices and Lift Covers



### Portable Outlet Boxes and Cover Plates



### Heavy-Duty Outlet Boxes and Cover Plates



# Twist-Lock® Devices

## Watertight Safety-Shroud® Twist-Lock® Devices

Features and Benefits



Note: Works with Mechanical Interlocks, see page B-39 for additional information.



### TPE Gland Seal

Assorted glands accommodate a wide range of cord sizes from #16-3 Type SJ to #8-5 Type S, SO



### Panel or Box Mount Receptacles and Inlets

- High impact, thermoplastic housing for heavy-duty industrial environments.
- Catalog number and color-coded voltage rating are easily visible when in use.
- Stainless Steel 302/304, #10 multiple drive head mounting screws provide corrosion resistance.
- Mounting screw recesses minimize screwdriver slippage.
- Lockout/tagout hole on inlets allow compliance to OSHA regulation 29 CFR 1910.147.
- TPE closure cap provided with inlets for environmental seal when not in use.
- Accepts all mating NEMA locking plugs and most connector bodies, allowing interchangeability with existing devices.



### Spring-Loaded Cover

One-step push-to-close spring-loaded cover with latch allows for fast opening and closing of lift cover. Result: environmental sealing is assured



### Safety-Shroud

- Virtually eliminates bent and broken plug blades, leading to longer equipment life.
- Extends life of mating receptacles by eliminating damage caused by insertion of bent blades.
- Extra protection for personnel by significantly reducing chance of inadvertent contact with blades when connecting or disconnecting energized receptacles and connector bodies.
- Reduces exposure to arcing when connecting or disconnecting plugs under load.
- Compliance with California Code of Regulations, Title 8, Article 51, subsection 2510.7(b), which requires shrouding for devices exceeding 300 volts.
- Lockout/tagout hole allows compliance with OSHA regulation 29 CFR 1910.147.
- Sealing gland and thermoplastic guard assure sealing when fully connected.





## Watertight Devices

NEMA Rating Color Coded by Voltage		Poles/Wires	Plug	Connector	Flanged Inlet	Receptacle	
20A 125V		L5-20	2P/3W	HBL2311SW	HBL2313SW	HBL2315SW	HBL2310SW
20A 250V		L6-20	2P/3W	HBL2321SW	HBL2323SW	HBL2325SW	HBL2320SW
277V AC		L7-20	2P/3W	HBL2331SW	HBL2333SW	HBL2335SW	HBL2330SW
125/250V AC		L14-20	3P/4W	HBL2411SW	HBL2413SW	HBL2415SW	HBL2410SW
20A 3Ø 250V AC		L15-20	3P/4W	HBL2421SW	HBL2423SW	HBL2425SW	HBL2420SW
20A 3Ø 480V AC		L16-20	3P/4W	HBL2431SW	HBL2433SW	HBL2435SW	HBL2430SW
3ØY 120/208V AC		L21-20	4P/5W	HBL2511SW	HBL2513SW	HBL2515SW	HBL2510SW
30A 125V		L5-30	2P/3W	HBL2611SW	HBL2613SW	HBL2615SW	HBL2610SW
30A 250V		L6-30	2P/3W	HBL2621SW	HBL2623SW	HBL2625SW	HBL2620SW
30A 125/250V AC		L14-30	3P/4W	HBL2711SW	HBL2713SW	HBL2715SW	HBL2710SW
30A 3Ø 250V AC		L15-30	3P/4W	HBL2721SW	HBL2723SW	HBL2725SW	HBL2720SW
30A 3Ø 480V AC		L16-30	3P/4W	HBL2731SW	HBL2733SW	HBL2735SW	HBL2730SW
3Ø 600V AC		L17-30	3P/4W	HBL2741SW	HBL2743SW	HBL2745SW	HBL2740SW
3ØY 120/208V AC		L21-30	4P/5W	HBL2811SW	HBL2813SW	HBL2815SW	HBL2810SW

Note: For technical information on Watertight Safety-Shroud devices see page B-70.

## Mechanical Interlock Switched Safety Enclosure

Description	Catalog Number
Unfused mechanical interlock integrates a watertight safety shroud receptacle with a linked disconnect switch. For additional details, see page B-39.	HBLMITL



HBLMITL

## Specifications

### Listings

Listed to UL Standard 498.  
 Certified to CSA Standard No.42.  
 Fed. Spec. WC-596.

### Environmental

Moisture Resistance	UL Type 4, 4X, 12, IP66 suitability.
Flammability (Enclosure)	V0 per UL94 or CSA 22.2 No. 0.17.
Operating Temperatures	Maximum Continuous 75°C; Minimum -40°C (w/o impact).

# Watertight Devices Safety-Shroud® Twist-Lock® Accessories

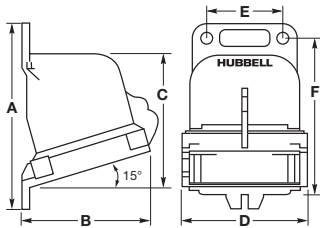

Non-Metallic Angle Box

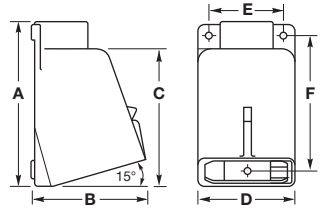

Metallic Angle Box

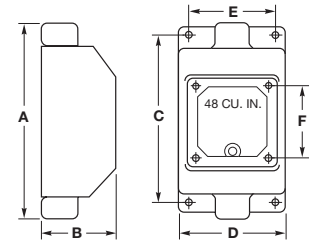

Metallic Feed Thru Box

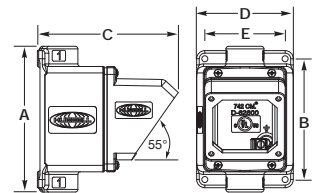

AB203055

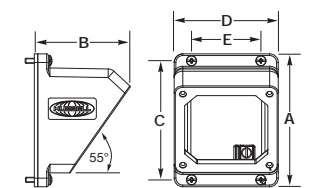

AA203055



HBL2030AP



AA2030PS

Dimensions in Inches (mm)

## 15° Angle Non-Metallic Back Box

	NPT Hub Size	A Inch (mm)	B Inch (mm)	C Inch (mm)	D Inch (mm)	E Inch (mm)	F Inch (mm)	Cubic Inch Capacity	Catalog Number
For 20A and 30A Watertight Safety-Shroud Twist-Lock Receptacles and Inlets.	1"	5.67" (144.0)	4.44" (112.8)	4.05" (102.9)	3.91" (99.3)	2.35" (59.7)	4.92" (125.0)	30.00"	<b>BB2030N</b>

Note: Hub is not included; order Raco part number 1704. This box meets IP67 requirement and Type 4X requirements when installed with a watertight conduit hub.

## 15° Angle Metallic Back Boxes

	NPT Hub Size	A Inch (mm)	B Inch (mm)	C Inch (mm)	D Inch (mm)	E Inch (mm)	F Inch (mm)	Cubic Inch Capacity	Catalog Number
For 20A and 30A Watertight Safety-Shroud Twist-Lock Receptacles and Inlets.	3/4"	5.13" (130.2)	4.00" (101.6)	4.19" (106.4)	3.75" (95.3)	3.00" (76.2)	4.00" (101.6)	30.00"	<b>BB201W</b>
	1"	5.13" (130.2)	4.00" (101.6)	4.19" (106.4)	3.75" (95.3)	3.00" (76.2)	4.00" (101.6)	30.00"	<b>BB301W</b>

## Metallic Feed Thru Back Boxes

	NPT Hub Size	A Inch (mm)	B Inch (mm)	C Inch (mm)	D Inch (mm)	E Inch (mm)	F Inch (mm)	Cubic Inch Capacity	Catalog Number
For 20A and 30A Watertight Safety-Shroud Twist-Lock Receptacles and Inlets.	3/4"	8.25" (209.6)	3.06" (77.8)	7.14" (181.4)	4.50" (114.3)	3.75" (95.3)	3.13" (79.5)	48.00"	<b>FT202W</b>
	1"	8.25" (209.6)	3.06" (77.8)	7.14" (181.4)	4.50" (114.3)	3.75" (95.3)	3.13" (79.5)	48.00"	<b>FT302W</b>

Note: These boxes are cast aluminum and are finished with enamel paint. These boxes withstand a 500-hour salt spray test as well as UL raintight and external icing tests. NPT (metric designator).

## 55° Angle Metallic Adapter and Back Box

	NPT Hub Size	A Inch (mm)	B Inch (mm)	C Inch (mm)	D Inch (mm)	E Inch (mm)	F Inch (mm)	Cubic Inch Capacity	Catalog Number
For 20A and 30A Watertight Safety-Shroud Twist-Lock Receptacles and Inlets	1"	6.80" (172.4)	5.63" (142.9)	6.60" (167.0)	4.50" (114.3)	3.74" (95.0)	-	45.27"	<b>AB203055</b>

## 55° Angle Metallic Adapter with Grounding Lug

Description	A Inch (mm)	B Inch (mm)	C Inch (mm)	D Inch (mm)	E Inch (mm)	F Inch (mm)	Cubic Inch Capacity	Catalog Number
For 20A and 30A Watertight Safety-Shroud Twist-Lock Receptacles and Inlets	4.89" (124.2)	3.33" (84.1)	4.29" (109.0)	3.75" (95.3)	2.50" (63.5)	-	25.00"	<b>AA203055</b>

## Straight Watertight Wall Box Adapter

Description	Catalog Number
Adapts 20A and 30A Watertight Safety-Shroud Twist-Lock receptacles and inlets to 2-gang, device mount, FD boxes.	<b>HBL2030AP</b>

## Non-Watertight Angle Wall Box Adapter

Description	Catalog Number
Adapts 20A and 30A Watertight Safety-Shroud Twist-Lock receptacles to 1- or 2-gang standard wall boxes (4" or 4 1/16" square).	<b>AA2030PS</b>

# Watertight Devices

## Watertight Devices

Features and Benefits

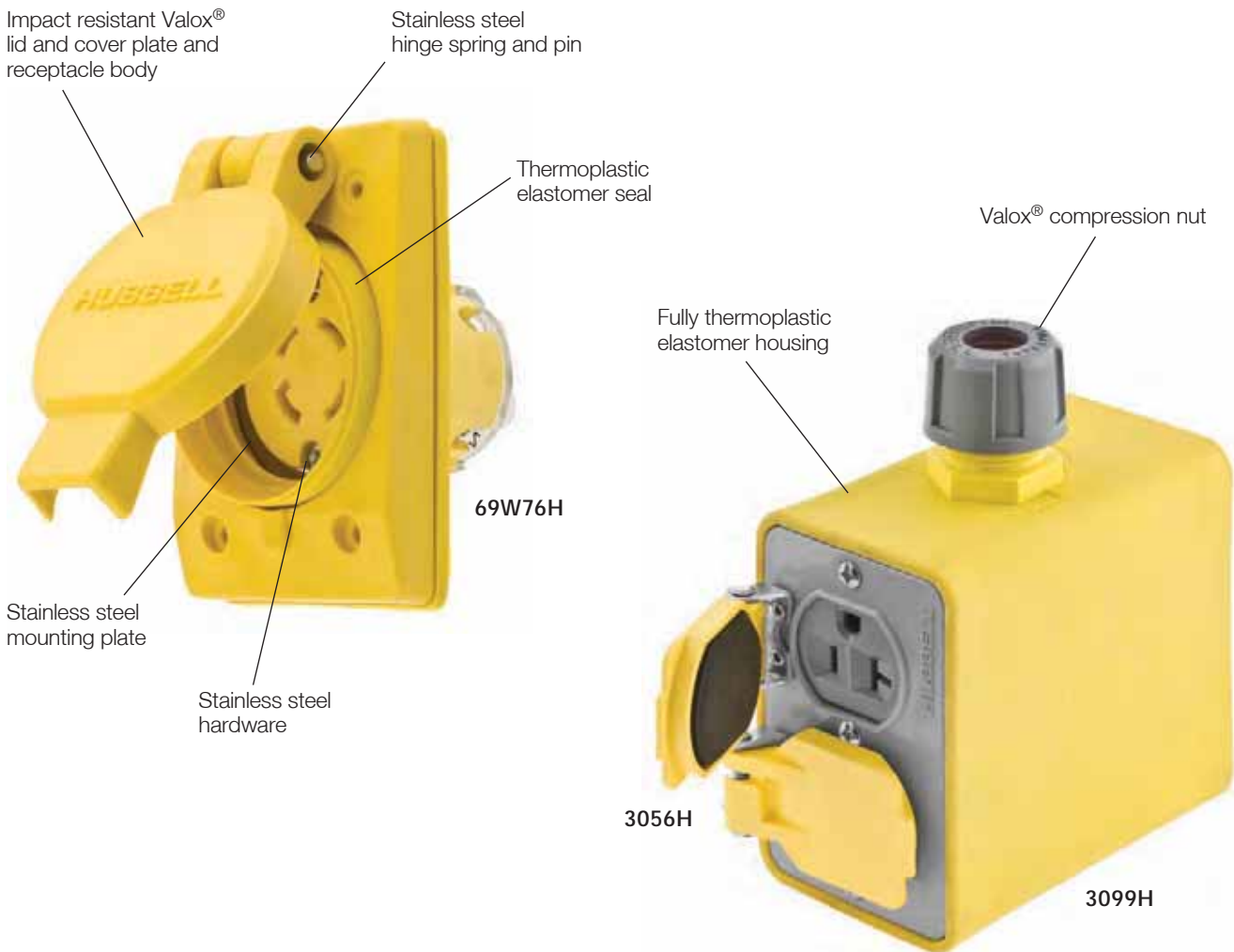
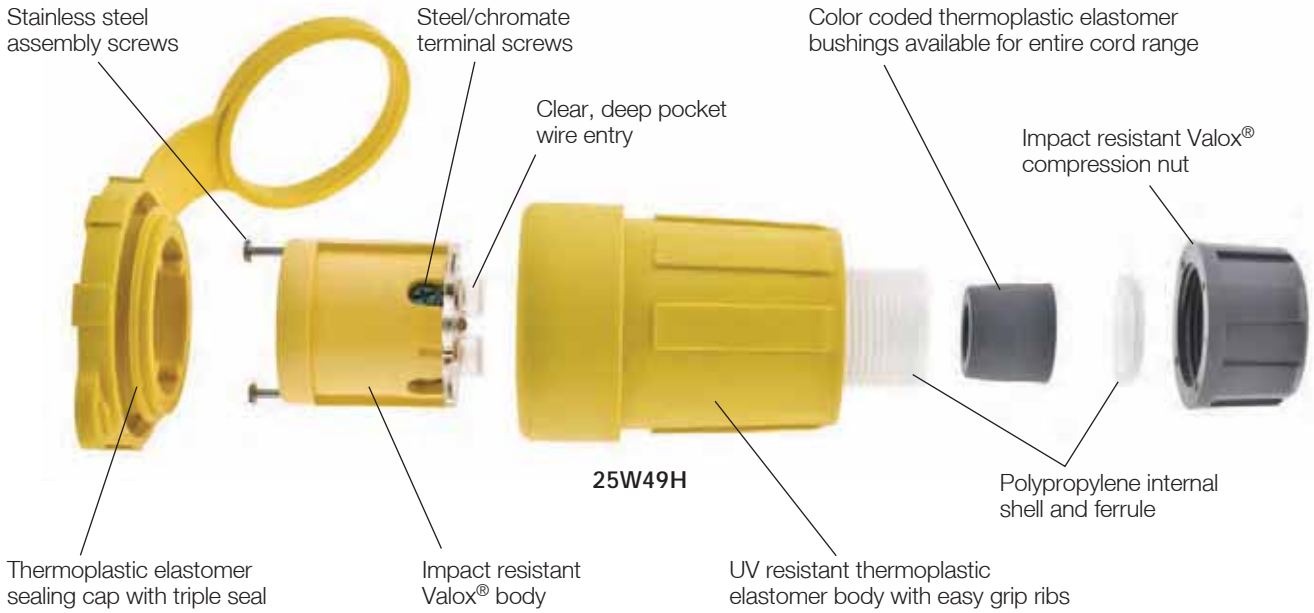

Valox® is a trademark of SABIC Innovative Plastics, acquired from General Electric Company.

**IP65, 66, 67**  
SUITABILITY



14W33H



2P 3W  
**15A 125V**  
NEMA 5-15P  
UL CSA



2P 3W  
**15A 250V**  
NEMA 6-15P  
UL CSA



3P 3W  
15A 125V  
10A 600V  
NON-NEMA

**15A Straight Blade Plugs**

Description	Color	Cord Dia.	Catalog Number	Catalog Number	Catalog Number
Thermoplastic elastomer plugs.	Yellow Black	.300"-.625" (7.6-15.9)	<b>14W47H</b> <b>14W47HBK</b>	<b>14W49H</b> —	<b>14W07H▲</b> —



2P 3W  
**15A 125V**  
NEMA 5-15R  
UL CSA  
0.5 HP



2P 3W  
**15A 250V**  
NEMA 6-15R  
UL CSA  
1.5 HP



3P 3W  
15A 125V  
10A 600V  
NON-NEMA

**15A Straight Blade Connectors/Receptacles\***

Description	Color	Cord Dia.	Catalog Number	Catalog Number	Catalog Number
Thermoplastic elastomer connectors.	Yellow Black	.300"-.625" (7.6-15.9)	<b>15W47H</b> <b>15W47HBK</b>	<b>15W49H</b> —	<b>15W07H▲</b> —
Thermoplastic elastomer receptacles.	Yellow	—	<b>60W47H</b>	<b>60W49H</b>	—



15W47H

**IP65, 66, 67**  
SUITABILITY



60W47H



2P 3W  
**20A 125V**  
NEMA 5-20P  
UL CSA



2P 3W  
**20A 250V**  
NEMA 6-20P  
UL CSA

**20A Straight Blade Plugs**

Description	Cord Dia.	Catalog Number	Catalog Number	Catalog Number
Thermoplastic elastomer yellow plugs.	.300"-.625" (7.6-15.9)	<b>14W33H</b>	<b>14W48H</b>	—



2P 3W  
**20A 125V**  
NEMA 5-20R  
UL CSA  
1 HP



2P 3W  
**20A 250V**  
NEMA 6-20R  
UL CSA  
2 HP

**20A Straight Blade Connectors/Receptacles\***

Description	Cord Dia.	Catalog Number	Catalog Number	Catalog Number
Thermoplastic elastomer yellow connectors.	.300"-.625" (7.6-15.9)	<b>15W33H•</b>	<b>15W48H•</b>	—
Thermoplastic elastomer yellow receptacles.	—	<b>60W33H</b>	<b>60W48H</b>	—

Note: \*Receptacles are NEMA 3R, IP44 suitability.  
Horsepower ratings for receptacle/plug connection are AC voltage only.  
▲ CSA certified only.  
• UL listed only.



**IP65, 66, 67**  
SUITABILITY

**15A Twist-Lock® Plugs**

Description	Cord Dia.	Catalog Number		
Thermoplastic elastomer yellow plugs.	.300"-.625" (7.6-15.9)	24W47H	24W49H	24W34H



15A 125V  
NEMA L5-15P  
UL/CSA



15A 250V  
NEMA L6-15P  
UL/CSA



15A 277V AC  
NEMA L7-15P  
UL/CSA



24W49H

**15A Twist-Lock® Connectors/Receptacles\***

Description	Cord Dia.	Catalog Number		
Thermoplastic elastomer yellow connectors.	.300"-.625" (7.6-15.9)	25W47H	25W49H	25W34H
Thermoplastic elastomer yellow receptacles.	—	65W47H	65W49H	65W34H



15A 125V  
NEMA L5-15R  
UL/CSA  
1 HP



15A 250V  
NEMA L6-15R  
UL/CSA  
1.5 HP



15A 277V AC  
NEMA L7-15R  
UL/CSA  
2 HP



25W49H

**IP65, 66, 67**  
SUITABILITY

**20A Twist-Lock® Plugs**

Description	Cord Dia.	Catalog Number		
Thermoplastic elastomer yellow plugs.	.475"-.720" (12.1-19.2)	26W47H	26W48H	26W49H



20A 125V  
NEMA L5-20P  
UL/CSA



20A 250V  
NEMA L6-20P  
UL/CSA



20A 277V AC  
NEMA L7-20P  
UL/CSA



65W49H

**20A Twist-Lock® Connectors/Receptacles\***

Description	Cord Dia.	Catalog Number		
Thermoplastic elastomer yellow connectors.	.475"-.720" (12.1-19.2)	27W47H	27W48H	27W49H
Thermoplastic elastomer yellow receptacles.	—	67W47H	67W48H	67W49H



20A 125V  
NEMA L5-20R  
UL/CSA  
1 HP



20A 250V  
NEMA L6-20R  
UL/CSA  
2 HP



20A 277V AC  
NEMA L7-20R  
UL/CSA  
2 HP

Note: \*Receptacles are NEMA 3R, IP44 suitability.  
Horsepower ratings for receptacle/plug connection are AC voltage only.



28W48H

**IP65, 66, 67**  
SUITABILITY

**20A Twist-Lock® Plugs**

Description	Color	Cord Dia.	Catalog Number
Thermoplastic elastomer plugs.	Yellow	.560"-.775"	26W74H
	Black	(14.2-19.9)	—

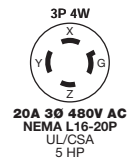

**20A Twist-Lock® Connectors/Receptacles\***

Description	Color	Cord Dia.	Catalog Number
Thermoplastic elastomer connectors.	Yellow	.560"-.775"	27W74H
	Black	(14.2-19.9)	—
Thermoplastic elastomer receptacles.	Yellow	—	67W74H

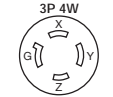
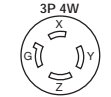

29W48H

**IP65, 66, 67**  
SUITABILITY

**Non-NEMA 20A Twist-Lock® Plugs**

Description	Cord Dia.	Catalog Number
Thermoplastic elastomer yellow plugs.	.475"-.720" (12.1-19.2)	26W08H 26W09H



69W48H

**Non-NEMA 20A Twist-Lock® Connectors/Receptacles\***

Description	Cord Dia.	Catalog Number
Thermoplastic elastomer yellow connectors.	.475"-.720" (12.1-19.2)	27W08H 27W09H
Thermoplastic elastomer yellow receptacles.	—	67W08H 67W09H



**IP65, 66, 67**  
SUITABILITY

**30A Twist-Lock® Plugs**

Description	Cord Dia.	Catalog Number
Thermoplastic elastomer yellow plugs.	.475"-.720" (12.1-19.2)	28W47H 28W48H 28W49H

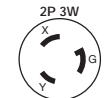

**30A Twist-Lock® Connectors/Receptacles\***

Description	Cord Dia.	Catalog Number
Thermoplastic elastomer yellow connectors.	.475"-.720" (12.1-19.2)	29W47H 29W48H 29W49H
Thermoplastic elastomer yellow receptacles.	—	69W47H 69W48H 69W49H

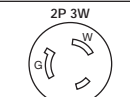
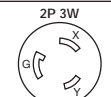

Note: \*Receptacles are NEMA 3R, IP44 suitability.

**IP65, 66, 67**  
SUITABILITY



3P 4W  
30A 125/250V  
NEMA L14-30P  
UL/CSA  
2 (2) HP

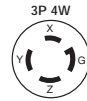

3P 4W  
30A 3Ø 250V AC  
NEMA L15-30P  
UL/CSA  
3 HP

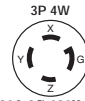

3P 4W  
30A 3Ø 480V AC  
NEMA L16-30P  
UL/CSA  
10 HP

**30A Twist-Lock® Plugs**

Description	Cord Dia.	Catalog Number		
Thermoplastic elastomer yellow plugs.	.640"-.930" (16.3-23.6)	28W74H	28W75H	28W76H



28W76H

**30A Twist-Lock® Connectors/Receptacles\***

Description	Cord Dia.	Catalog Number		
Thermoplastic elastomer yellow connectors.	.640"-.930" (16.3-23.6)	29W74H	29W75H	29W76H
Thermoplastic elastomer yellow receptacles.	—	69W74H	69W75H	69W76H



3P 4W  
30A 125/250V  
NEMA L14-30R  
UL/CSA  
2 (2) HP



3P 4W  
30A 3Ø 250V AC  
NEMA L15-30R  
UL/CSA  
3 HP



3P 4W  
30A 3Ø 480V AC  
NEMA L16-30R  
UL/CSA  
10 HP



29W76H

**IP65, 66, 67**  
SUITABILITY



3P 4W  
30A 3Ø 600V AC  
NEMA L17-30P  
UL/CSA



4P 4W  
30A 3ØY  
120/208V AC  
NEMA L18-30P  
UL Listed  
3 HP

**30A Twist-Lock® Plugs**

Description	Cord Dia.	Catalog Number		
Thermoplastic elastomer yellow plugs.	.640"-.930" (16.3-23.6)	28W77H	28W78H	

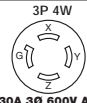

3P 4W  
30A 3Ø 600V AC  
NEMA L17-30R  
UL/CSA



4P 4W  
30A 3ØY  
120/208V AC  
NEMA L18-30R  
UL Listed  
3 HP

**30A Twist-Lock® Connectors/Receptacles\***

Description	Cord Dia.	Catalog Number		
Thermoplastic elastomer yellow connectors.	.640"-.930" (16.3-23.6)	29W77H	29W78H	
Thermoplastic elastomer yellow receptacles.	—	69W77H	—	



69W76H

**IP65, 66, 67**  
SUITABILITY



3P 3W  
30A 125/250V  
Non-NEMA



4P 4W  
30A 3Ø Y  
120/208V AC  
Non-NEMA

**Non-NEMA 30A Twist-Lock® Plugs**

Description	Cord Dia.	Catalog Number	Cord Dia.	Catalog Number
Thermoplastic elastomer yellow plugs.	.475"-.720" (12.1-19.2)	28W08H	.640"-.930" (16.3-23.6)	28W09H*



3P 3W  
30A 125/250V  
Non-NEMA



4P 4W  
30A 3Ø Y  
120/208V AC  
Non-NEMA

**Non-NEMA 30A Twist-Lock® Connectors/Receptacles\***

Description	Cord Dia.	Catalog Number	Cord Dia.	Catalog Number
Thermoplastic elastomer yellow connectors.	.475"-.720" (12.1-19.2)	29W08H*	.640"-.930" (16.3-23.6)	29W09H*
Thermoplastic elastomer yellow receptacles.	—	69W08H*	—	—

Note: \*Receptacles are NEMA 3R, IP44 suitability.  
•UL listed only.



### NEMA Type 3R Weather Protective Lift Covers\*\*

Description	Catalog Number
Lift cover assembly; for use with 15A or 20A straight blade receptacles and 15A locking receptacle; receptacle not included.	6500H
Lift cover assembly; for use with locking 20A receptacles; receptacle not included.	6700H
Lift cover assembly; for use with locking 30A receptacles*; receptacle not included.	6800H

*Note: \*When mating with 28W08H plug, use 6700H.  
\*\*For use with FS/FD boxes.*



6700H

### NEMA Type 1 Portable Outlet Box

Description	Catalog Number
Portable outlet box.	3059H
Portable outlet box; deep.	3099H
Portable outlet box with feed thru.	3090FH
Portable outlet box with (2) duplex cover plates.	3000H

*Note: For use with NEMA Type 1 portable outlet box covers listed below.*



3059H

### NEMA Type 1 Portable Outlet Box Cover Plates

Description	Catalog Number
Outlet box lift cover, duplex receptacle.	3056H
Outlet box cover, duplex receptacle.	3051H
Outlet box lift cover, 1.39" diameter receptacle.	3057H
Outlet box cover, 1.39" diameter receptacle.	3052H
Outlet box lift cover, 1.572" diameter receptacle.	3058H
Outlet box cover, 1.572" diameter receptacle.	3055H
Outlet box lift cover; GFCI.	3061H
Outlet box cover; GFCI.	3060H
Outlet box cover plate, blank.	3054H



3099H



3090FH



3000H



### Dimensions

#### Portable Outlet Boxes

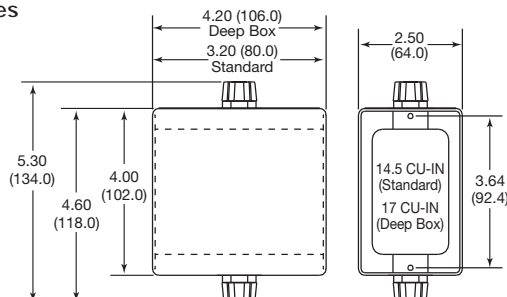

Dimensions in Inches (mm)

## Heavy-Duty Portable Outlet Boxes and Cover Plates

Description	Catalog Number
Box with cord strain relief, with one blank cover plate.	HBLPOB1
Box with cord strain relief, with one blank cover plate, black.	HBLPOB1BK
Box with cord strain relief, with two duplex (indoor) cover plates.	HBLPOB1D
Box with cord strain relief, with two duplex (indoor), yellow cover plates.	HBLPOB1DY
Blank, non-metallic FS cover plate with foam gasket, gray.	HBLP14FS
Duplex, non-metallic FS cover plate, gray.	HBLP8FS
Duplex, non-metallic FS cover plate, yellow.	HBLP8FSY
Single receptacle (1.39"), non-metallic FS cover plate, gray.	HBLP7FS
Single receptacle (1.56"), non-metallic FS cover plate, gray.	HBLP720FS
Rectangular opening, non-metallic FS cover plate, gray.	HBLP26FS



HBLPOB1

## Other Cover Plates and Devices

which may be used with Heavy-Duty Portable Outlet Boxes

Description	Catalog Number
Duplex cover plate, weatherproof.	HBL5221, HBL52CM21
Single receptacle (1.39") cover plate, weatherproof.	HBL7423WO, HBL74CM23WO
Single receptacle (1.56") cover plate, weatherproof.	HBL7425WOA, HBL74CM25WOA
Safety-Shroud Twist-Lock® surface receptacles.	HBL2310SR, HBL2320SR, HBL2330SR, HBL2610SR, HBL2620SR



Cover Plates

Note: Standard product gray, CM yellow.

## Deluxe Cord Grips Straight Male Thread

Nylon Fittings, Stainless Steel Mesh, Liquidtight, for Insulated Cables

Grip Diameter Range Inches (cm.)	Thread Size NPT (inches)	Form Size	Catalog Number
.375"-.500" (.95-1.27)	3/4"	F3	074011335
.500"-.625" (1.27-1.59)	3/4"	F3	074011336
.625"-.750" (1.59-1.90)	3/4"	F3	074011337

## Nylon Cord Connector Straight Male Thread

Grip Diameter Range Inches (cm.)	Thread Size NPT (inches)	Form Size	Catalog Number
.375"-.500" (.95-1.27)	3/4"	F3	SHC1035CR
.500"-.625" (1.27-1.59)	3/4"	F3	SHC1036CR
.625"-.750" (1.59-1.90)	3/4"	F3	SHC1037CR



Deluxe Cord Grips  
(purchased separately)

## Specifications for Heavy-Duty Portable Outlet Boxes and Cover Plates

UL Listed	UL 514C, UL467 and UL50 Enclosures Types 1, 3R.
CSA Certified	C22.2 No. 18 and C22.2 No. 94 Enclosures Types 1, 3R and C22.2 No. 0.4 (Impedance).
Box Specifications:	
Moisture Resistance	Wet and damp locations, Enclosure Type 3R when used with weatherproof cover plates. Dry, indoors locations, Enclosure Type 1 with all other cover plates.
Flammability	UL 94V-0, 94-5VA classification.
Operating Temperature	80°C maximum; -35°C minimum.
UV Resistance	All materials are UV stabilized.
Impact and Crush Resistance	in accordance with UL 514C, UL50, C22.2 No. 18 and C22.2 No. 94.
Material	Valox®.
Cord Connector Materials	Nylon nut; Nylon Gotcha® ring; Neoprene grommet.
Cord Diameter Range	.38" to .75" diameter.
Bonding Strap Material	Brass.
Threaded Inserts	Brass.
Grounding Screw Material	Brass.
Indoor Cover Plate Screws Material	Zinc Plated Steel.
Outdoor Cover Plate Screws Material	Stainless Steel.
Cover Plate Gasket Material	UL recognized closed-cell foam (aging and oil resistant).



Gray Nylon  
Cord Connector

## Dimensions

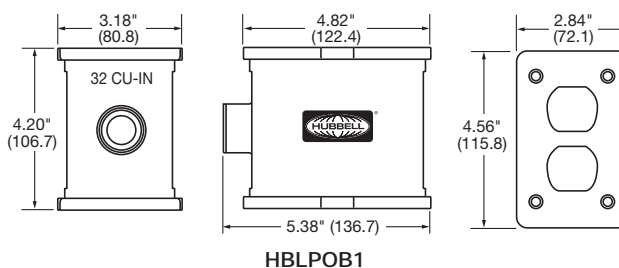

HBLPOB1

Valox® is a trademark of SABIC Innovative Plastics, acquired from General Electric Company.

Dimensions in Inches (mm)

# Watertight Devices Technical Information

## Specifications

Listings (Plug/Connector and Flip Lid Assembly)

Listed to UL498.

Certified to CSA C22.2 No. 42.

Meets NEMA WD-1, WD-6 and ANSI standards.

## Materials

### Plug/Connector

Part	Materials
Blade/Contact Carrier	PBT Thermoplastic, yellow
Terminal Retainer	Polycarbonate, clear
Housing	Thermoplastic Elastomer, yellow
Housing Insert	Polypropylene, natural
Strain Relief Nut	PBT Thermoplastic, gray
Grommet	Thermoplastic Elastomer, various colors
Ferrule	Polypropylene, natural
Blades/Contacts	Brass, nickel
Terminal Screws	Steel, chromate
Terminal Screw Size	#8-32
Body Holding Screws	Stainless steel
Drive Screws	Steel, chromate

### Flip Lid Assembly (see connector for device materials)

Part	Materials
Flip lid and cover plate	PBT Thermoplastic, yellow
Sealing Collar	Thermoplastic elastomer, yellow
Mounting Plate	Stainless steel
Spring	Stainless steel
Hinge Pin	Stainless steel
Mounting Screws	Stainless steel

### Portable Outlet box and Accessories

Part	Materials
Box Enclosure	Thermoplastic Elastomer, yellow
Strain Relief Nut	PBT Thermoplastic, gray
Grommet	Thermoplastic Elastomer, various colors
Ferrule	Polypropylene, natural
Strain relief insert	Nylon, yellow
Locknut	Steel, zinc plate
Threaded inserts	Polypropylene, natural
Strain relief wire	Brass
Duplex receptacle screw	Stainless steel
Cover plate screws	Steel, black oxide
Cover Plate	Nylon, gray
Flip covers	PBT Thermoplastic, yellow
Flip cover seal	Foam rubber, black
Cover plate Spring	Stainless steel
Hinge Pin	Aluminum
Hinge bracket	Stainless steel
Rivets	Brass

## Performance

### Electrical

Dielectric Voltage	Connectors:	2000V AC if rated 300V or less 3000V AC if rated above 300V
	Plugs:	2500V AC if rated 300V or less 3500V AC if rated above 300V
Max Working Voltage		As marked
Current Interrupting		Rated for current interruption per UL498
Temperature Rise		30°C max per UL498 at rated current

### Mechanical

Cord and terminal accommodations:

#### Plugs and Connectors

15 and 20A straight blade and 15A locking	Types S, SO, ST, SJ, SJO, SJT 18/3 to 12/3, .300 min. to .625 in. max (7.6 to 15.9 mm) dia.
20 and 30A 3-wire locking	12/3 SJ, 14/3 S to 10/3 S (.475" to .720") (12.1 mm to 19.2 mm)
20A 4-wire locking	14/4 S to 10/4 S (.560" to .775") (14.2 mm to 19.9 mm)
30A 4-wire locking	12/4 S to 8/4 S, 6/4 MSHA (.640" to .930") (16.3 mm to 23.6 mm)

Receptacles – use solid or stranded building wire or flexible cord only as outlined below:

All 15 and 20A straight blade	18 AWG to 12 AWG
20A locking and 30A 3-wire	14 AWG to 10 AWG
30A 4-wire	12 AWG to 6 AWG

#### Portable Outlet Boxes

All	16/3 SO through 12/3 SO cord
Wiring Volume	Standard - 14.5 cu. in. Deep - 17 cu. in.

### Environmental

Moisture Resistance	NEMA 4, 4X, 12, 6, 6P (Plug and Connector only) NEMA 3R (Flip lid assemblies) NEMA TYPE 1 (Portable Outlet Box)
Flammability	UL94V0 (boxes and wiring device interiors) UL94V2 (cover plates) UL94HB (wiring device housings, flip lid seals)
Operating temperatures	-40°C (without impact) to +60°C continuous
UV resistance	All exposed materials are UV stabilized

## Dimensions

### Watertight Plugs and Connectors

#### Straight Blade and 15A Locking

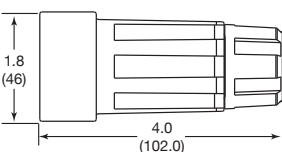
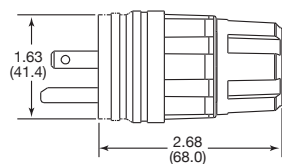

#### Locking

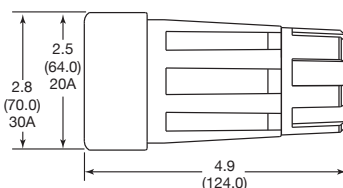
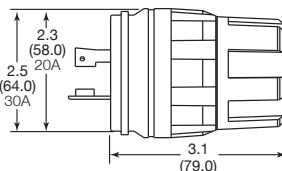

#### Receptacles with Lift Cover and Cover Assemblies

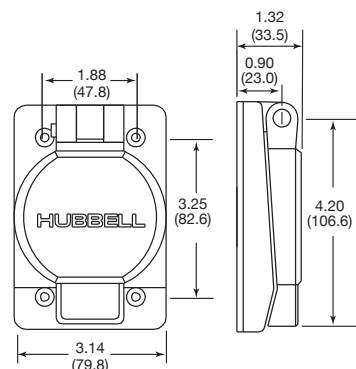

Dimensions in Inches (mm)

# Section D Switches

## Index

Product	Page
<b>SNAPConnect® Toggle and Decorator Series</b>	
SNAPConnect® Toggle Series . . . . .	D-4
SNAPConnect® Decorator Series . . . . .	D-5
<b>HBL® Extra Heavy Duty Industrial Grade</b>	
Toggle and Locking Type Switches with Ground Screw . . . . .	D-6
Toggle Type Illuminated and Pilot Light Switches with Ground Screw . . . . .	D-7
3-Position, 2-Circuit Center Off Switches . . . . .	D-7
<b>Hubbell-PRO Heavy Duty Industrial Series</b>	
Toggle Switches . . . . .	D-8
Pre-Wired/Leaded Switches . . . . .	D-8
Hospital Call Switch with Lanyard . . . . .	D-8
<b>Pre-Wired/Leaded Commercial Toggle and Decorator Switches . . . . .</b>	<b>D-9</b>
<b>Specification Grade Commercial Switches . . . . .</b>	<b>D-10</b>
<b>Style Line® Decorator Series Specification Grade . . . . .</b>	<b>D-11</b>
<b>Extra Heavy Duty Industrial 347V AC Toggle and PresSwitch® . . . . .</b>	<b>D-12</b>
<b>Switch Accessories</b>	
Pilot Light, SWITCHOUT® Lockout Device and Weatherproof Switch Plates for Toggle Switches . . . . .	D-13
<b>Switch Certification Chart . . . . .</b>	<b>D-14</b>
<b>Nylon and Metal Wallplates . . . . .</b>	<b>D-15</b>
<b>Dimmers</b>	
Slide and Rotary Control Dimmers . . . . .	D-16
Dimmer Ganging and Derating . . . . .	D-17
<b>Heavy Duty Panel Mount and Bat Handle Switches . . . . .</b>	<b>D-18</b>
<b>Technical Information . . . . .</b>	<b>D-20</b>

SNAPConnect® Switches

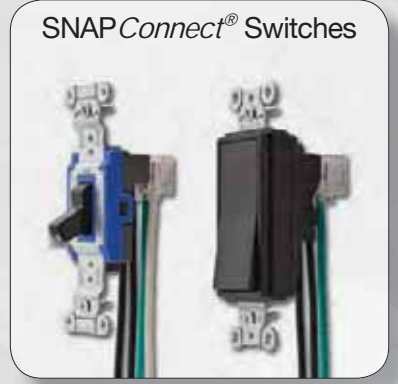

Toggle Switches



Pre-Wired/Leaded Switches



PresSwitch® and  
Panel Mount Switches



Switches

**SNAP Connect® Toggle and Decorator Series**

Features and Benefits

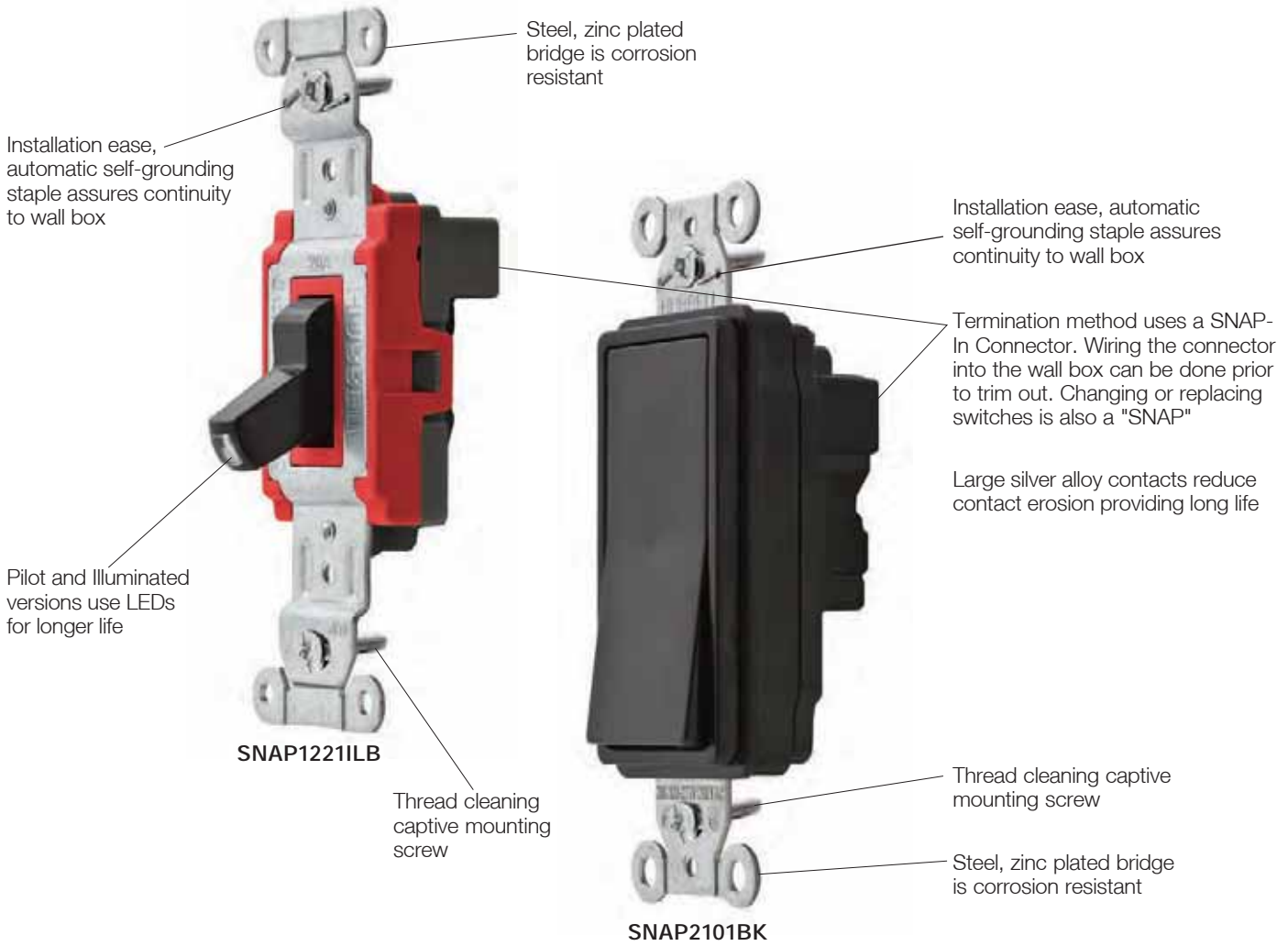

**Many of these products are Assembled in USA, as indicated, and many are Buy American Compliant. Please contact Hubbell with any certification requirements.**



3 Wire Connector for Single Pole and Single Pole Illuminated

SNAPSP1NA  
SNAPSP2NA



4 Wire Connector for Single Pole Pilot Light Switch

SNAPSP1NA  
SNAPSP2NA



4 Wire Connector for Three Way and Three Way Illuminated

SNAP3W1NA  
SNAP3W2NA



# Switches

## HBL® Extra Heavy Duty Industrial Grade

Features and Benefits

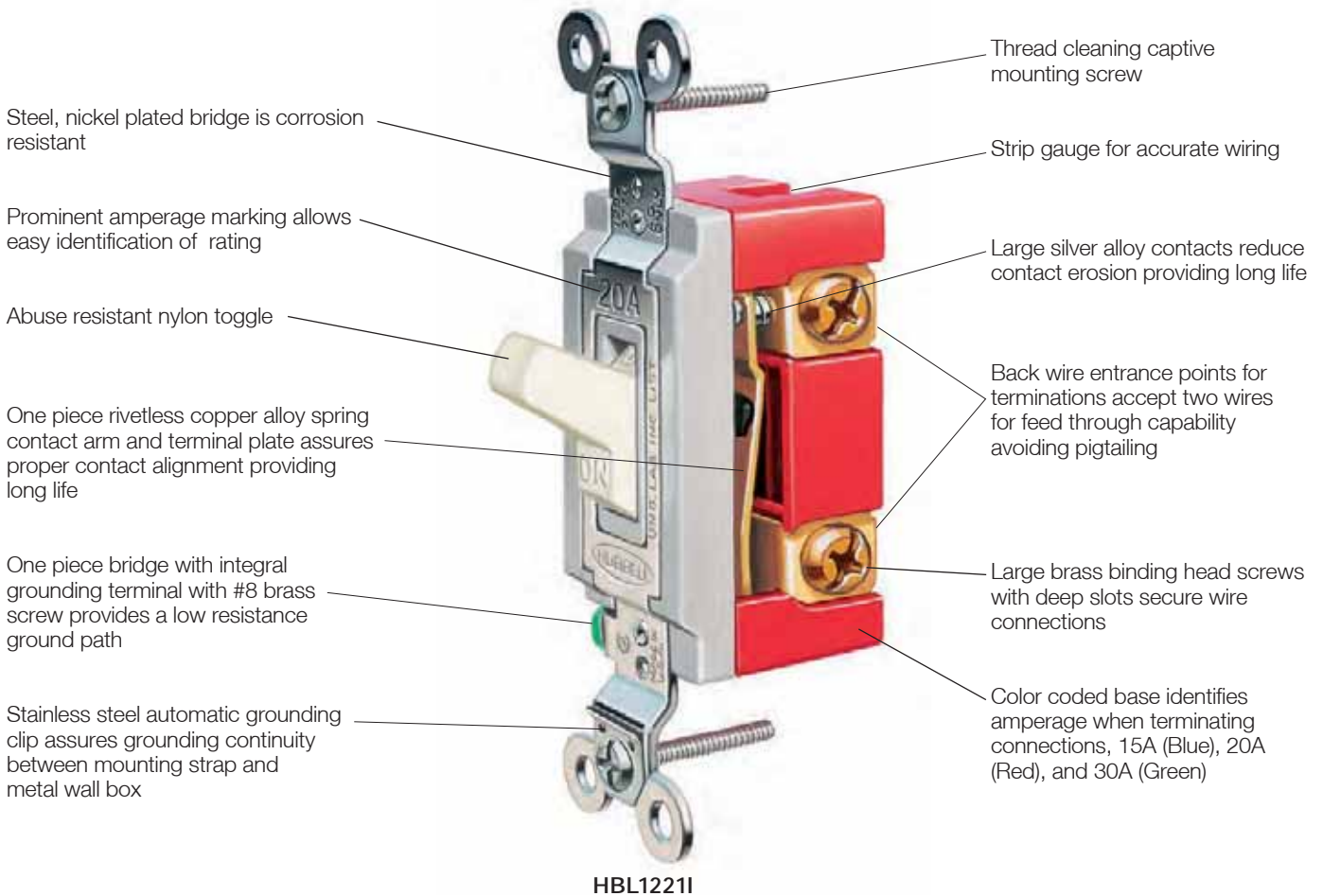

One piece rivetless copper alloy spring contact arm and terminal plate assures proper contact alignment reducing heat rise. Large silver alloy contacts reduce contact erosion and prevent welding, providing long life.



Elastomer rocker assures quiet operation and precise timing. Permanently lubricated assembly provides long life and trouble free operation.



Heavy duty nylon toggle resists abuse and chemical attack making it suitable for use in the toughest environments.



One piece integral grounding terminal with #8 brass screw allows compliance to NEC®. Stainless steel automatic self-grounding clip assures grounding continuity between mounting strap and metal wall box. Steel nickel plated mounting strap provides a corrosion resistant finish.

NEC® is a registered trademark of the National Fire Protection Association (NFPA).

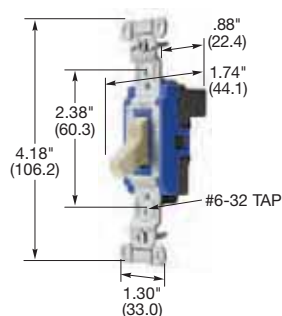

SNAP1201INA

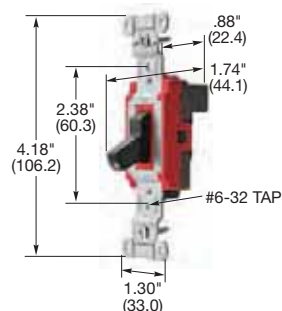

SNAP1221BKNA

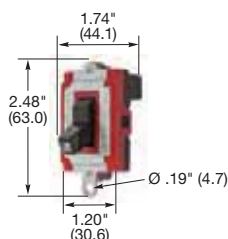

SNAPSWJUMP



SNAP3W1NA

## HP Conversion Chart

	120V	208V	240V	277V AC
15A	.5HP	1.5HP	2HP	2HP
20A	1HP	2HP	2HP	2HP

Dimensions in Inches (mm)

**SNAPConnect® Specification Grade Toggle Series, Assembled in USA**  
**15A, 120-277V AC**

Description	Toggle Color	Single Pole	Double Pole	Three Way	Four Way
SNAPConnect® Toggle.	Black	SNAP1201BKNA	—	SNAP1203BKNA	—
	Brown	SNAP1201BRNA	—	SNAP1203BRNA	—
	Gray	SNAP1201GYNA	—	SNAP1203GYNA	—
	Ivory	SNAP1201INA	—	SNAP1203INA	—
	Lt. Almond	SNAP1201LANA	—	SNAP1203LANA	—
	Red	SNAP1201RNA	—	SNAP1203RNA	—
	White	SNAP1201WNA	—	SNAP1203WNA	—

**20A, 120-277V AC**

Description	Toggle Color	Single Pole	Double Pole	Three Way	Four Way
SNAPConnect® Toggle.	Black	SNAP1221BKNA	—	SNAP1223BKNA	—
	Brown	SNAP1221BRNA	—	SNAP1223BRNA	—
	Gray	SNAP1221GYNA	—	SNAP1223GYNA	—
	Ivory	SNAP1221INA	—	SNAP1223INA	—
	Lt. Almond	SNAP1221LANA	—	SNAP1223LANA	—
	Red	SNAP1221RNA	—	SNAP1223RNA	—
	White	SNAP1221WNA	—	SNAP1223WNA	—

**Illuminated, Light On with Load Off**  
**15A, 120-277V AC**

Description	Toggle Color	Single Pole	Double Pole	Three Way	Four Way
Illuminated, Light On with Load Off, Toggle, Blue LED.	Black	SNAP1201ILBKNA	—	SNAP1203ILBKNA	—
	Ivory	SNAP1201ILINA	—	SNAP1203ILINA	—
	Red	SNAP1201ILRNA	—	SNAP1203ILRNA	—
	White	SNAP1201ILWNA	—	SNAP1203ILWNA	—

**20A, 120-277V AC**

Description	Toggle Color	Single Pole	Double Pole	Three Way	Four Way
Illuminated, Light On with Load Off, Toggle, Blue LED.	Black	SNAP1221ILBKNA	—	SNAP1223ILBKNA	—
	Ivory	SNAP1221ILINA	—	SNAP1223ILINA	—
	Red	SNAP1221ILRNA	—	SNAP1223ILRNA	—
	White	SNAP1221ILWNA	—	SNAP1223ILWNA	—

**Pilot, Light On with Load On**  
**15A, 120-277V AC**

Description	Toggle Color	Single Pole	Double Pole	Three Way	Four Way
Pilot, Light On with Load On, Toggle, Red LED.	Black	SNAP1201PLBKNA	—	—	—
	Ivory	SNAP1201PLINA	—	—	—
	Red	SNAP1201PLRNA	—	—	—
	White	SNAP1201PLWNA	—	—	—

**20A, 120-277V AC**

Description	Toggle Color	Single Pole	Double Pole	Three Way	Four Way
Pilot, Light On with Load On, Toggle, Red LED.	Black	SNAP1221PLBKNA	—	—	—
	Ivory	SNAP1221PLINA	—	—	—
	Red	SNAP1221PLRNA	—	—	—
	White	SNAP1221PLWNA	—	—	—

**Jumper/Tester**

Description	Catalog Number
Jumper/Tester for Single Pole Circuits, Black Toggle, Blue LED Indicator.	<b>SNAPSWJUMP</b>
Jumper/Tester for Three Way Circuits, Black Toggle, Blue LED Indicator.	<b>SNAP3WJUMP</b>

**SNAPConnect® Switch Pigtailed Connector, Assembled in USA**

Description	Single Pole (3 Wires)	Single Pole with Pilot	3 Way (4 Wires)
Clear right angle terminal, 6 inch leads, solid wire.	SNAPSP1NA	SNAPSPP1NA	SNAP3W1NA
Clear right angle terminal, 6 inch leads, stranded wire.	SNAPSP2NA	SNAPSPP2NA	SNAP3W2NA

Note: See page D-13 for accessories.

See page D-15 for wallplates.

See page D-20 for technical information.

**Many of these products are Assembled in USA, as indicated, and many are Buy American Compliant. Please contact Hubbell with any certification requirements.**

# Switches

## 15 and 20 Ampere, 120-277 Volts AC

SNAPConnect® Heavy Duty Style Line® Decorator Switches



### SNAPConnect® Spec. Grade Style Line® Decorator Series, Assembled in USA

#### 15A, 120-277V AC

Description	Toggle Color	Single Pole	Double Pole	Three Way	Four Way
SNAPConnect® Rocker.	Black	SNAP2101BKNA	—	SNAP2103BKNA	—
	Brown	SNAP2101BRNA	—	SNAP2103BRNA	—
	Gray	SNAP2101GYNA	—	SNAP2103GYNA	—
	Ivory	SNAP2101INA	—	SNAP2103INA	—
	Lt. Almond	SNAP2101LANA	—	SNAP2103LANA	—
	Red	SNAP2101RNA	—	SNAP2103RNA	—
	White	SNAP2101WNA	—	SNAP2103WNA	—

#### 20A, 120-277V AC

Description	Toggle Color	Single Pole	Double Pole	Three Way	Four Way
SNAPConnect® Rocker.	Black	SNAP2121BKNA	—	SNAP2123BKNA	—
	Brown	SNAP2121BRNA	—	SNAP2123BRNA	—
	Gray	SNAP2121GYNA	—	SNAP2123GYNA	—
	Ivory	SNAP2121INA	—	SNAP2123INA	—
	Lt. Almond	SNAP2121LANA	—	SNAP2123LANA	—
	Red	SNAP2121RNA	—	SNAP2123RNA	—
	White	SNAP2121WNA	—	SNAP2123WNA	—

### Illuminated, Light On with Load Off

#### 15A, 120-277V AC

Description	Toggle Color	Single Pole	Double Pole	Three Way	Four Way
Illuminated, Light On with Load Off, Rocker, Blue LED.	Black	SNAP2101ILBKNA	—	SNAP2103ILBKNA	—
	Ivory	SNAP2101ILINA	—	SNAP2103ILINA	—
	Red	SNAP2101ILRNA	—	SNAP2103ILRNA	—
	White	SNAP2101ILWNA	—	SNAP2103ILWNA	—

#### 20A, 120-277V AC

Description	Toggle Color	Single Pole	Double Pole	Three Way	Four Way
Illuminated, Light On with Load Off, Rocker, Blue LED.	Black	SNAP2121ILBKNA	—	SNAP2123ILBKNA	—
	Ivory	SNAP2121ILINA	—	SNAP2123ILINA	—
	Red	SNAP2121ILRNA	—	SNAP2123ILRNA	—
	White	SNAP2121ILWNA	—	SNAP2123ILWNA	—

### Pilot, Light On with Load On

#### 15A, 120-277V AC

Description	Toggle Color	Single Pole	Double Pole	Three Way	Four Way
Pilot, Light On with Load On, Rocker, Red LED.	Black	SNAP2101PLBKNA	—	—	—
	Ivory	SNAP2101PLINA	—	—	—
	Red	SNAP2101PLRNA	—	—	—
	White	SNAP2101PLWNA	—	—	—

#### 20A, 120-277V AC

Description	Toggle Color	Single Pole	Double Pole	Three Way	Four Way
Pilot, Light On with Load On, Rocker, Red LED.	Black	SNAP2121PLBKNA	—	—	—
	Ivory	SNAP2121PLINA	—	—	—
	Red	SNAP2121PLRNA	—	—	—
	White	SNAP2121PLWNA	—	—	—

### Jumper/Tester

Description	Catalog Number
Jumper/Tester for Single Pole Circuits, Black Toggle, Blue LED Indicator.	SNAPSWJUMP
Jumper/Tester for Three Way Circuits, Black Toggle, Blue LED Indicator.	SNAP3WJUMP

### SNAPConnect® Switch Pigtailed Connector, Assembled in USA

Description	Single Pole (3 Wires)	Single Pole with Pilot	3 Way (4 Wires)
Clear right angle terminal, 6 inch leads, solid wire.	SNAPSP1NA	SNAPSPP1NA	SNAP3W1NA
Clear right angle terminal, 6 inch leads, stranded wire.	SNAPSP2NA	SNAPSPP2NA	SNAP3W2NA

Note: See page D-13 for accessories.  
See page D-15 for wallplates.  
See page D-20 for technical information.

Many of these products are Assembled in USA, as indicated, and many are Buy American Compliant. Please contact Hubbell with any certification requirements.



SNAP2101INA

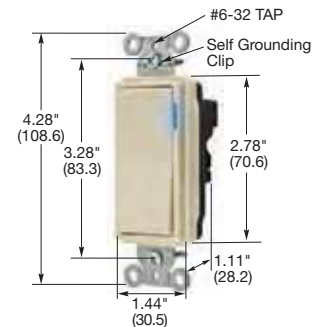

SNAP2121ILINA

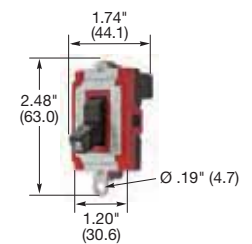

SNAPSWJUMP



HP Conversion Chart				
	120V	208V	240V	277V AC
15A	.5HP	1.5HP	2HP	2HP
20A	1HP	2HP	2HP	2HP

Dimensions in Inches (mm)

Switches  
**15, 20 and 30 Ampere, 120-277 Volts AC**  
*HBL® Extra Heavy Duty Industrial Series*

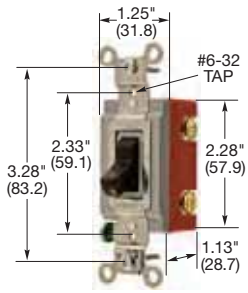

**HBL1221**

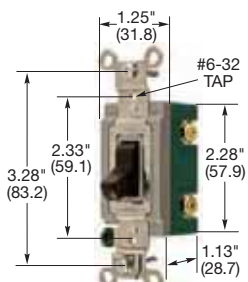

**HBL3031**

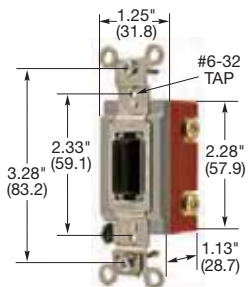

**HBL1221L and Key**

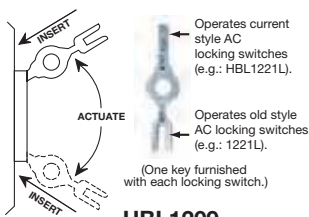

**HBL1209**

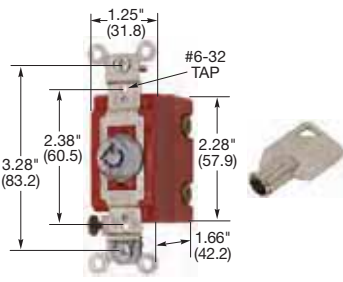

**HBL1222RKL and Key**

Dimensions in Inches (mm)

**HBL Extra Heavy Duty Industrial Series, Back and Side Wired**  
**15A, 120-277V AC**

Description	Toggle Color	Single Pole	Double Pole	Three Way	Four Way
Toggle, back and side wired.	Black	HBL1201BK	—	HBL1203BK	HBL1204BK
	Brown	HBL1201	HBL1202	HBL1203	HBL1204
	Gray	HBL1201GY	—	HBL1203GY	HBL1204GY
	Ivory	HBL1201I	HBL1202I	HBL1203I	HBL1204I
	Light Almond	HBL1201LA	—	—	—
	Red	HBL1201R	—	—	—
	White	HBL1201W	—	HBL1203W	HBL1204W

**20A, 120-277V AC**

Description	Toggle Color	Single Pole	Double Pole	Three Way	Four Way
Toggle, back and side wired.	Black	HBL1221BK	HBL1222BK	HBL1223BK	HBL1224BK
	Brown	HBL1221	HBL1222	HBL1223	HBL1224
	Gray	HBL1221GY	HBL1222GY	HBL1223GY	HBL1224GY
	Ivory	HBL1221I	HBL1222I	HBL1223I	HBL1224I
	Light Almond	HBL1221LA	HBL1222LA	HBL1223LA	HBL1224LA
	Office White	HBL1221OW	HBL1222OW	HBL1223OW	HBL1224OW
	Red	HBL1221R	HBL1222R	HBL1223R	HBL1224R
	White	HBL1221W	HBL1222W	HBL1223W	HBL1224W

**30A, 120-277V AC**

Description	Key Guide Color	Single Pole	Double Pole	Three Way	Four Way
Nylon toggle.	Brown	HBL3031	HBL3032	HBL3033	—
	Ivory	HBL3031I	HBL3032I	HBL3033I	—
	White	—	HBL3032W	—	—

**HBL Extra Heavy Duty Industrial Locking Series, Back and Side Wired**  
**15A, 120-277V AC**

Description	Key Guide Color	Single Pole	Double Pole	Three Way	Four Way
Key Guide, back and side wired.	Black	HBL1201L	HBL1202L	HBL1203L	HBL1204L
	Gray	HBL1201LG	HBL1202LG	HBL1203LG	HBL1204LG
	Ivory	HBL1201LI	HBL1202LI	HBL1203LI	HBL1204LI
	White	HBL1201LW	HBL1202LW	HBL1203LW	HBL1204LW

Key for Locking switch. HBL1209\*

**20A, 120-277V AC**

Description	Key Guide Color	Single Pole	Double Pole	Three Way	Four Way
Key Guide, back and side wired.	Black	HBL1221L	HBL1222L	HBL1223L	HBL1224L
	Gray	HBL1221LG	HBL1222LG	HBL1223LG	HBL1224LG
	Ivory	HBL1221LI	HBL1222LI	HBL1223LI	HBL1224LI
	White	HBL1221LW	HBL1222LW	HBL1223LW	HBL1224LW

Key for Locking switch. HBL1209\*

**HBL Extra Heavy Duty Industrial AC Barrel Key Locking Switch†, Back and Side Wired**  
**20A, 120-277V AC**

Description	Key Guide Color	Single Pole	Double Pole	Three Way	Four Way
Chrome operator, back and side wired.	Chrome	HBL1221RKL**	HBL1222RKL**	HBL1223RKL**	HBL1224RKL**
Replacement Barrel Key.		HBL1209RKL*			

Note: Keys are supplied with each locking switch. For extra keys order HBL1209.

\*Not UL Listed, CSA Certified.

\*\*Not Fed. Spec.

† See Wallplate section, page N-17 for wallplates.

See page D-13 for accessories.

See page D-15 for wallplates.

See page D-20 for technical information.

**HP Conversion Chart**

	120V	208V	240V	277V AC
15A	.5HP	1.5HP	2HP	2HP
20A	1HP	2HP	2HP	2HP
30A	2HP	2HP	2HP	2HP

## Switches

# 15, 20 and 30 Ampere, 120-277 and 347 Volts AC

HBL® Extra Heavy Duty Industrial Series



### HBL Extra Heavy Duty Industrial Series, Illuminated Toggle Switches, Light On with Load Off, Back and Side Wired

Description	Toggle Color	Rating	Single Pole	Double Pole	Three Way
Nylon toggle, back and side wired.	Ivory	15A 120-277V AC	HBL1201IL	—	HBL1203IL
	Ivory	20A 120-277V AC	HBL1221IL	—	HBL1223IL
	Clear		HBL1221ILC	—	HBL1223ILC
	Red		HBL1221ILR	—	—

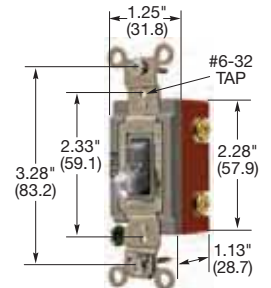

HBL1221ILC

### HBL Extra Heavy Duty Industrial Series, Pilot Light Switches, Light On with Load On, Back and Side Wired

Description	Toggle Color	Rating	Single Pole	Double Pole	Three Way
Nylon toggle, back and side wired.	Red	15A 120-277V AC	HBL1201PL	—	HBL1203PL
	Red	20A 120-277V AC	HBL1221PL	HBL1222PL	HBL1223PL
	Clear		HBL1221PLC	—	HBL1223PLC
	Green		HBL1221PLG	—	—
	Red	30A 120-277V AC	HBL3031PL	HBL3032PL	—

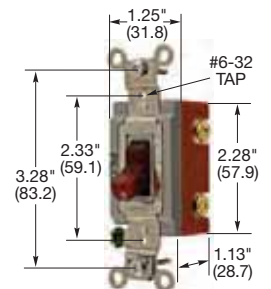

HBL1221PL

### Momentary Contact, Specification Grade, Three Position, Two Circuit, Center Off, Back and Side Wired

Description	Toggle Color	15A, 120-277V AC	20A, 120-277V AC
Nylon toggle, back and side wired.	Brown	HBL1556	HBL1557
	Gray	HBL1556GY	HBL1557GY
	Ivory	HBL1556I	HBL1557I
	Red	HBL1556R	—
	White	HBL1556W	HBL1557W
Key guide, back and side wired.	Black	HBL1556L	HBL1557L
	Gray	HBL1556LG	HBL1557LG
	Ivory	HBL1556LI	HBL1557LI
	White	HBL1556LW	HBL1557LW
Key for Locking switch.		HBL1209*	

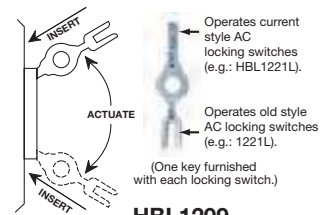

HBL1209

### Maintained Contact, Specification Grade, Three Position, Two Circuit, Center Off, Single Pole, Double Throw

Description	Toggle Color	15A 120-277V AC	20A 120-277V AC	30A 120-277V AC
Nylon toggle, back and side wired.	Brown	HBL1381	HBL1385	—
	Ivory	HBL1381I	HBL1385I	—
	White	—	HBL1385W	—

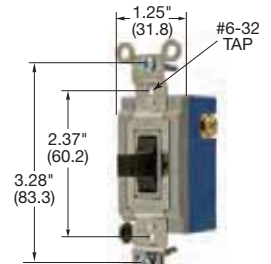

HBL1381

### Three Position, Two Circuit, Center Off, Double Pole, Double Throw

Description	Toggle Color	15A 120-277V AC	20A 120-277V AC	30A 120-277V AC
Nylon toggle, back and side wired.	Brown	HBL1382	HBL1386	HBL1388
	Ivory	HBL1382I	HBL1386I	HBL1388I
Locking.		—	HBL1386L	—
Key for Locking switch.		—	HBL1209*	—

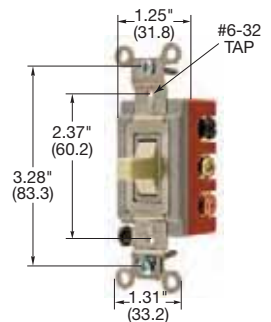

HBL1386I

Note: Keys are supplied with each locking switch. For extra keys order HBL1209.

\*Not UL Listed, CSA Certified.

See page D-13 for accessories.

See page D-15 for wallplates.

See page D-20 for technical information.

### HP Conversion Chart

	120V	208V	240V	277V AC
15A	.5HP	1.5HP	2HP	2HP
20A	1HP	2HP	2HP	2HP
30A	2HP	2HP	2HP	2HP

Dimensions in Inches (mm)

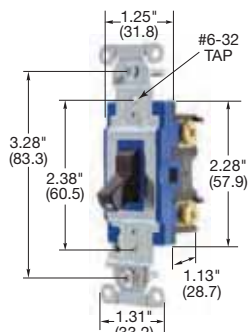

**1201BK**

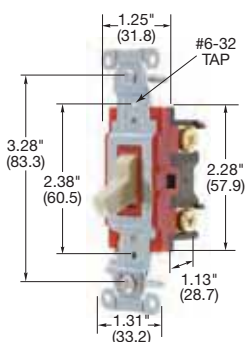

**1221I**

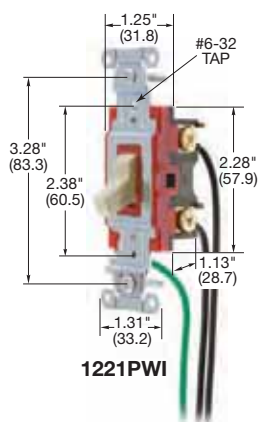

**1221PWI**

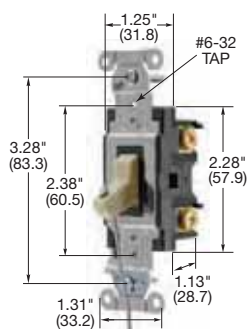

**HBL1221IHCS**

Dimensions in Inches (mm)

**Hubbell-PRO Heavy Duty Industrial Series, 15A, 120-277V AC**

Description	Toggle Color	Single Pole	Double Pole	Three Way	Four Way
Toggle, back and side wired.	Almond	1201AL	—	1203AL	—
	Black	1201BK	—	1203BK	—
	Brown	1201B	—	1203B	—
	Gray	1201GY	—	1203GY	—
	Ivory	1201I	—	1203I	—
	Light Almond	1201LA	—	1203LA	—
	White	1201W	—	1203W	—

**Hubbell-PRO Heavy Duty Industrial Series, 20A, 120-277V AC**

Description	Toggle Color	Single Pole	Double Pole	Three Way	Four Way
Toggle, back and side wired.	Almond	1221AL	1222AL	1223AL	1224AL
	Black	1221BK	1222BK	1223BK	1224BK
	Brown	1221B	1222B	1223B	1224B
	Gray	1221GY	1222GY	1223GY	1224GY
	Ivory	1221I	1222I	1223I	1224I
	Light Almond	1221LA	1222LA	1223LA	1224LA
	Red	1221R	1222R	1223R	1224R
	White	1221W	1222W	1223W	1224W

**Hubbell-PRO Pre-Wired/Leaded Heavy Duty Industrial Series 20A, 120-277V AC - 8" #12 AWG THHN**

Description	Toggle Color	Single Pole	Double Pole	Three Way	Four Way
Toggle, Pre-wired leads.	Almond	1221PWAL	1222PWAL	1223PWAL	1224PWAL
	Black	1221PWBK	1222PWBK	1223PWBK	1224PWBK
	Brown	1221PWB	1222PWB	1223PWB	1224PWB
	Gray	1221PWGY	1222PWGY	1223PWGY	1224PWGY
	Ivory	1221PWI	1222PWI	1223PWI	1224PWI
	Light Almond	1221PWLA	1222PWLA	1223PWLA	1224PWLA
	Red	1221PWR	1222PWR	1223PWR	1224PWR
	White	1221PWW	1222PWW	1223PWW	1224PWW

**Hubbell-PRO Hospital Call Switch, with Lanyard 20A, 120-277V AC**

Description	Toggle Color	Single Pole	Double Pole	Three Way	Four Way
Toggle, back and side wired.	Gray	HBL1221GHCS	—	—	—
	Ivory	HBL1221IHCS	—	—	—
	White	HBL1221WHCS	—	—	—

Note: See page D-13 for accessories.  
See page D-15 for wallplates.  
See page D-20 for technical information.

**HP Conversion Chart**

	120V	208V	240V	277V AC
15A	.5HP	1.5HP	2HP	2HP
20A	1HP	2HP	2HP	2HP

## Switches

# 15 and 20 Ampere, 120-277 Volts AC

Pre-Wired/Leaded Toggle and Decorator Series

### Pre-Wired/Leaded Toggle Series Specification Grade 15A, 120-277V AC - 8" #12 AWG THHN



Description	Toggle Color	Single Pole	Double Pole	Three Way	Four Way
Toggle, Nylon, Pre-wired leads.	Almond	CSL115AL	CSL215AL	CSL315AL	CSL415AL
	Black	CSL115BK	CSL215BK	CSL315BK	CSL415BK
	Brown	CSL115	CSL215	CSL315	CSL415
	Gray	CSL115GY	CSL215GY	CSL315GY	CSL415GY
	Ivory	CSL115I	CSL215I	CSL315I	CSL415I
	Light Almond	CSL115LA	CSL215LA	CSL315LA	CSL415LA
	Office White	CSL115OW	CSL215OW	CSL315OW	CSL415OW
	White	CSL115W	CSL215W	CSL315W	CSL415W

### 20A, 120-277V AC

Description	Toggle Color	Single Pole	Double Pole	Three Way	Four Way
Toggle, Nylon, Pre-wired leads.	Almond	CSL120AL	CSL220AL	CSL320AL	CSL420AL
	Black	CSL120BK	CSL220BK	CSL320BK	CSL420BK
	Brown	CSL120	CSL220	CSL320	CSL420
	Gray	CSL120GY	CSL220GY	CSL320GY	CSL420GY
	Ivory	CSL120I	CSL220I	CSL320I	CSL420I
	Light Almond	CSL120LA	CSL220LA	CSL320LA	CSL420LA
	Office White	CSL120OW	CSL220OW	CSL320OW	CSL420OW
	Red	CSL120R	CSL220R	CSL320R	CSL420R
	White	CSL120W	CSL220W	CSL320W	CSL420W

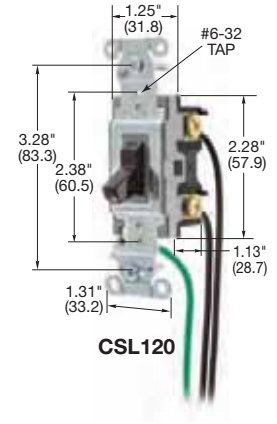

### Pre-Wired/Leaded Decorator Series Specification Grade 15A, 120-277V AC - 8" #12 AWG THHN



Description	Rocker Color	Single Pole	Double Pole	Three Way	Four Way
Rocker, Polycarbonate, Pre-wired leads.	Almond	DSL115AL	—	DSL315AL	—
	Black	DSL115BK	—	DSL315BK	—
	Brown	DSL115	—	DSL315	—
	Gray	DSL115GY	—	DSL315GY	—
	Ivory	DSL115I	—	DSL315I	—
	Light Almond	DSL115LA	—	DSL315LA	—
	Office White	DSL115OW	—	DSL315OW	—
	White	DSL115W	—	DSL315W	—

### 20A, 120-277V AC

Description	Rocker Color	Single Pole	Double Pole	Three Way	Four Way
Rocker, Polycarbonate, Pre-wired leads.	Almond	DSL120AL	DSL220AL	DSL320AL	DSL420AL
	Black	DSL120BK	DSL220BK	DSL320BK	DSL420BK
	Brown	DSL120	DSL220	DSL320	DSL420
	Gray	DSL120GY	DSL220GY	DSL320GY	DSL420GY
	Ivory	DSL120I	DSL220I	DSL320I	DSL420I
	Light Almond	DSL120LA	DSL220LA	DSL320LA	DSL420LA
	Office White	DSL120OW	DSL220OW	DSL320OW	DSL420OW
	White	DSL120W	DSL220W	DSL320W	DSL420W

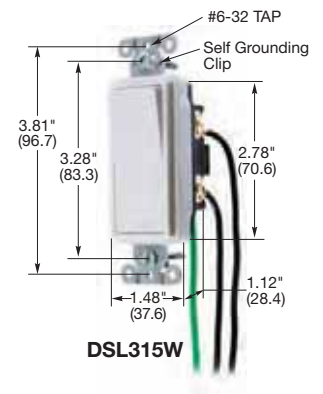

### Illuminated, Light On with Load Off 20A, 120-277V AC

Description	Rocker Color	Single Pole	Double Pole	Three Way	Four Way
Rocker, Polycarbonate, Pre-wired leads, Blue LED.	Ivory	DSL120IL	—	DSL320IL	—
	White	DSL120ILW	—	DSL320ILW	—

### Pilot, Light On with Load On 20A, 120-277V AC

Description	Rocker Color	Single Pole	Double Pole	Three Way	Four Way
Rocker, Polycarbonate, Pre-wired leads, Red LED.	Red	DSL120PL	—	—	—

Note: See page D-13 for accessories.  
See page D-15 for wallplates.  
See page D-20 for technical information.

#### HP Conversion Chart

	120V	208V	240V	277V AC
15A	.5HP	1.5HP	2HP	2HP
20A	1HP	2HP	2HP	2HP

Dimensions in Inches (mm)

Switches  
**15 and 20 Ampere, 120-277 Volts AC**  
 Specification Grade Commercial Series



**Specification Grade Commercial Series,  
 15A, 120-277V AC**

Description	Toggle Color	Single Pole	Double Pole	Three Way	Four Way
Toggle, back and side wired.	Almond	CSB115AL	CSB215AL	CSB315AL	CSB415AL
	Black	CSB115BK	CSB215BK	CSB315BK	CSB415BK
	Brown	CSB115	CSB215	CSB315	CSB415
	Gray	CSB115GY	CSB215GY	CSB315GY	CSB415GY
	Ivory	CSB115I	CSB215I	CSB315I	CSB415I
	Light Almond	CSB115LA	CSB215LA	CSB315LA	CSB415LA
	White	CSB115W	CSB215W	CSB315W	CSB415W

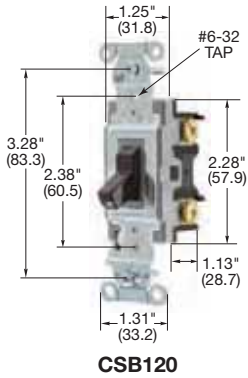

**Specification Grade Commercial Series,  
 20A, 120-277V AC**

Description	Toggle Color	Single Pole	Double Pole	Three Way	Four Way
Toggle, back and side wired.	Almond	CSB120AL	CSB220AL	CSB320AL	CSB420AL
	Black	CSB120BK	CSB220BK	CSB320BK	CSB420BK
	Brown	CSB120	CSB220	CSB320	CSB420
	Gray	CSB120GY	CSB220GY	CSB320GY	CSB420GY
	Ivory	CSB120I	CSB220I	CSB320I	CSB420I
	Light Almond	CSB120LA	CSB220LA	CSB320LA	CSB420LA
	Red	CSB120R	CSB220R	CSB320R	CSB420R
	White	CSB120W	CSB220W	CSB320W	CSB420W

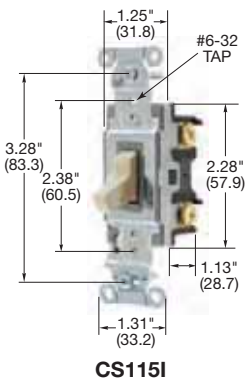

**Specification Grade Commercial Series,  
 15A, 120-277V AC**

Description	Toggle Color	Single Pole	Double Pole	Three Way	Four Way
Toggle, side wired only.	Almond	CS115AL	—	CS315AL	—
	Black	CS115BK	—	CS315BK	—
	Brown	CS115	—	CS315	—
	Gray	CS115GY	—	CS315GY	—
	Ivory	CS115I	—	CS315I	—
	Light Almond	CS115LA	—	CS315LA	—
	White	CS115W	—	CS315W	—

**Specification Grade Commercial Series,  
 20A, 120-277V AC**

Description	Toggle Color	Single Pole	Double Pole	Three Way	Four Way
Toggle, side wired only.	Almond	CS120AL	—	CS320AL	—
	Black	CS120BK	—	CS320BK	—
	Brown	CS120	—	CS320	—
	Gray	CS120GY	—	CS320GY	—
	Ivory	CS120I	—	CS320I	—
	Light Almond	CS120LA	—	CS320LA	—
	White	CS120W	—	CS320W	—

Note: See page D-9 for pre-wired/leaded devices.  
 See page D-13 for accessories.  
 See page D-15 for wallplates.  
 See page D-20 for technical information.

**HP Conversion Chart**

	120V	208V	240V	277V AC
15A	.5HP	1.5HP	2HP	2HP
20A	1HP	2HP	2HP	2HP

Dimensions in Inches (mm)



# Switches

## 15 and 20 Ampere, 120-277 Volt AC

Style Line® Decorator Series Specification Grade



### Style Line® Decorator Series Specification Grade, 15A, 120-277V AC

Description	Rocker Color	Single Pole	Double Pole	Three Way	Four Way
Rocker, back and side wired.	Almond	DS115AL	—	DS315AL	—
	Black	DS115BK	—	DS315BK	—
	Brown	DS115	—	DS315	—
	Gray	DS115GY	—	DS315GY	—
	Ivory	DS115I	—	DS315I	—
	Light Almond	DS115LA	—	DS315LA	—
	Office White	DS115OW	—	DS315OW	—
	White	DS115W	—	DS315W	—

### Style Line® Decorator Series Specification Grade, 20A, 120-277V AC

Description	Rocker Color	Single Pole	Double Pole	Three Way	Four Way
Rocker, back and side wired.	Almond	DS120AL	DS220AL	DS320AL	DS420AL
	Black	DS120BK	DS220BK	DS320BK	DS420BK
	Brown	DS120	DS220B	DS320	DS420
	Gray	DS120GY	DS220GY	DS320GY	DS420GY
	Ivory	DS120I	DS220I	DS320I	DS420I
	Light Almond	DS120LA	DS220LA	DS320LA	DS420LA
	Office White	DS120OW	DS220OW	DS320OW	DS420OW
	Red	DS120R	DS220R	DS320R	DS420R
	White	DS120W	DS220W	DS320W	DS420W

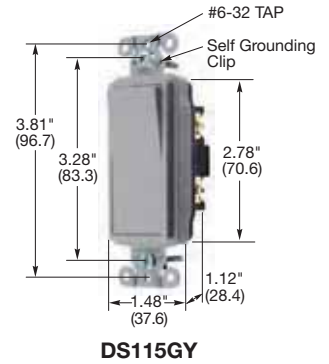

### Style Line® Decorator Series Specification Grade, Illuminated, Light On with Load Off 20A, 120-277V AC

Description	Rocker Color	Single Pole	Double Pole	Three Way	Four Way
Rocker, with Blue LED, back and side wired.	Black	DS120ILBK	—	DS320ILBK	—
	Ivory	DS120IL	—	DS320IL	—
	White	DS120ILW	—	DS320ILW	—

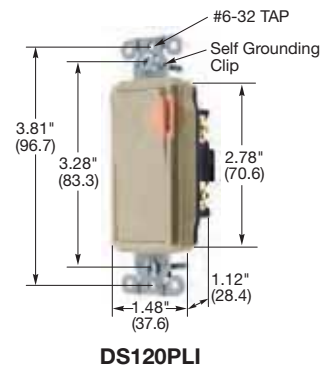

### Style Line® Decorator Series Specification Grade, Pilot, Light On with Load On 20A, 120-277V AC

Description	Rocker Color	Single Pole	Double Pole	Three Way	Four Way
Rocker, with Red LED, back and side wired.	Black	DS120PLBK	—	—	—
	Ivory	DS120PLI	—	—	—
	White	DS120PLW	—	—	—

Note: See page D-9 for pre-wired/leaded devices.  
 See page D-13 for accessories.  
 See page D-15 for wallplates.  
 See page D-20 for technical information.

#### HP Conversion Chart

	120V	208V	240V	277V AC
15A	.5HP	1.5HP	2HP	2HP
20A	1HP	2HP	2HP	2HP

Dimensions in Inches (mm)

## Switches

# 15 and 20 Ampere, 120-277 and 347 Volts AC

HBL® Extra Heavy Duty Industrial Series

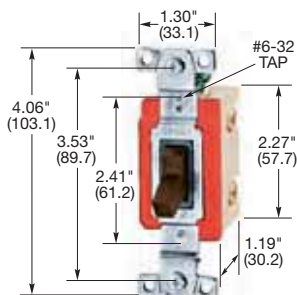

**HBL18221CN**

### HBL® Extra Heavy Duty Industrial Series 15A, 347V AC



Description	Toggle Color	Single Pole	Double Pole	Three Way	Four Way
Nylon toggle, back and side wired.	Brown	HBL18201CN	—	HBL18203CN	—
	Ivory	HBL18201ICN	—	HBL18203ICN	HBL18204ICN
Locking.		HBL18201LCN	—	HBL18203LCN	—
Key for Locking switch.		HBL1209*			

### HBL® Extra Heavy Duty Industrial Series 20A, 347V AC



Description	Toggle Color	Single Pole	Double Pole	Three Way	Four Way
Nylon toggle, back and side wired.	Brown	HBL18221CN	—	HBL18223CN	—
	Ivory	HBL18221ICN	—	HBL18223ICN	HBL18224ICN

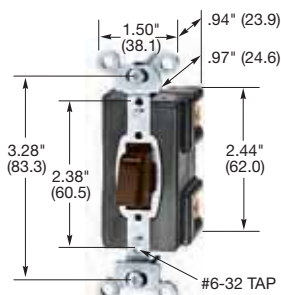

**HBL1281**

### PresSwitch® Specification Grade Push Button, Standard Type 20A, 120-277V AC



Description	Toggle Color	Single Pole	Double Pole	Three Way	Four Way
Nylon actuator, side wired only.	Brown	HBL1281	HBL1282	HBL1283*	HBL1284*
	Ivory	HBL1281I	HBL1282I	HBL1283I*	HBL1284I*

### Momentary Type® 20A, 120-277V AC

Description	Toggle Color	Single Pole	Double Pole	Three Way	Four Way
Circuit normally closed, side wired only.	Brown	HBL1281MC*	—	—	—
Circuit normally open, side wired only.	Brown	HBL1281MO*	—	—	—

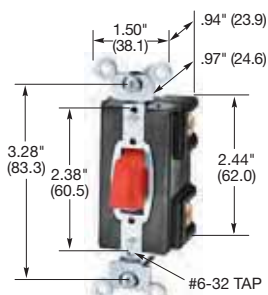

**HBL1297**

### Illuminated and Pilot Light PresSwitch®, 120V AC Lighted Actuator, Light On with Load Off®



Description	Toggle Color	Single Pole	Double Pole	Three Way	Four Way
15A, nylon actuator.	Ivory	—	—	—	HBL12591*
20A, nylon actuator.	Ivory	HBL1287I	—	HBL1288I*	—

### Pilot Light Actuator, Light On with Load On 20A, 120V AC



Description	Toggle Color	Single Pole	Double Pole	Three Way	Four Way
Nylon actuator.	Red	HBL1297	—	HBL1298*	—

Note: Keys are supplied with each locking switch. For extra keys order HBL1209.

\*Not UL Listed, CSA Certified.

•Not HP rated.

See page D-13 for accessories.

See page D-15 for wallplates.

See page D-20 for technical information.

Dimensions in Inches (mm)

#### HP Conversion Chart

	120V	208V	240V	277V AC
15A	.5HP	1.5HP	2HP	2HP
20A	1HP	2HP	2HP	2HP
30A	2HP	2HP	2HP	2HP

# Switches Accessories

Pilot Light, SWITCHOUT® Lockout Device and Weatherproof Switch Plates for Toggle Switches

## Pilot Light, 120-277V AC

IP44  
SUITABILITY



Description	Catalog Number
Red neon pilot light, back and side wired, fits standard switch plate.	HBL1220RJ



HBL1220RJ

## Brass Locking Attachment for Switches Available in Master Keying and Straight Keying Systems

Description	Catalog Number
Straight keying (all locks alike). Appropriate for most applications. Straight cylinder type lock, each HBL96061 ordered operates on the same key. All locks are keyed alike.	HBL96061*

Same as above except in dull chrome finish to match stainless steel plates.	HBL96061DCH*
---	--------------

Straight keying (individual). Straight cylinder type lock, each HBL96062 ordered operates on a different key. All locks are keyed differently and individually. This type cannot be master keyed.	HBL96062*
---	-----------



HBL96061 shown with wallplate and switch (sold separately)

## SWITCHOUT® Lockout Device

Description	Catalog Number
Yellow, nylon toggle switch lockout device (Two devices per package).	HSLDPK2*

## Weatherproof Plates



Description	Catalog Number
Clear bubble plate, silicone rubber for use with all general purpose AC toggle and PresSwitch® switches. Fits both FS/FD and standard boxes.	HBL1795
Cast aluminum lift cover plate with fiber shield. For standard toggle and PresSwitch®. Fits only FS/FD boxes.	HBL7420



HSLDPK2

## Weatherproof Plates for PresSwitch®



Description	Catalog Number
Gray neoprene PresSwitch® plate. Fits FS/FD and standard boxes.	HBL1750
Same as above except yellow.	HBL17CM50
Gray neoprene PresSwitch® plate with 125V red pilot light. Fits only FS/FD boxes.	HBL1785
Same as above except yellow.	HBL17CM85

Note: \*Not UL Listed or CSA Certified.  
Each locking wallplate is supplied with two keys.  
See section Z for additional information on safety lockout devices.  
See section N for additional wallplates.

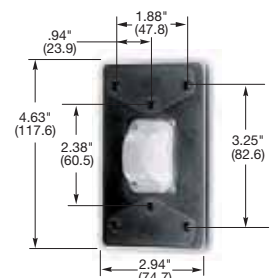

HBL1795

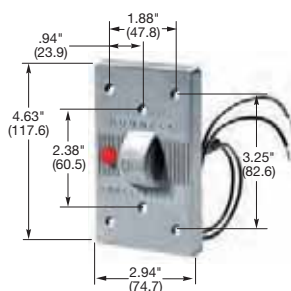

HBL1785

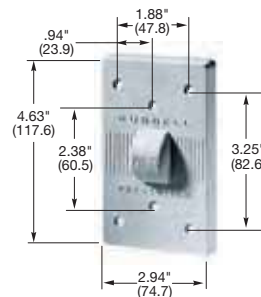

HBL1750

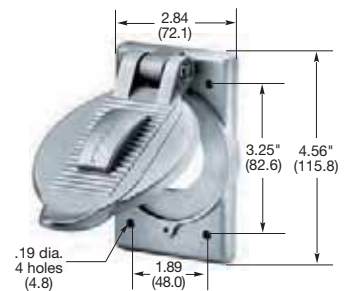

HBL7420

Dimensions in Inches (mm)

# Switches Certification Chart

## UL, CSA, and Fed. Spec. Listing Data

Catalog Number	WS896 Listed	UL Listed UL20	CSA Certified	Catalog Number	WS896 Listed	UL Listed UL20	CSA Certified
1201	Yes	Yes	Yes	HBL1224	Yes	Yes	Yes
1203	Yes	Yes	Yes	HBL1221L	Yes	Yes	Yes
1221	Yes	Yes	Yes	HBL1222L	Yes	Yes	Yes
1222	Yes	Yes	Yes	HBL1223L	Yes	Yes	Yes
1223	Yes	Yes	Yes	HBL1224L	Yes	Yes	Yes
1224	Yes	Yes	Yes	HBL1221IL	Yes	Yes	Yes
1221PW	Yes	Yes	Yes	HBL1223IL	Yes	Yes	Yes
1222PW	Yes	Yes	Yes	HBL1221PL	Yes	Yes	Yes
1223PW	Yes	Yes	Yes	HBL1222PL	Yes	Yes	Yes
1224PW	Yes	Yes	Yes	HBL1223PL	Yes	Yes	Yes
CS115	Yes	Yes	Yes	HBL1221RKL	No	Yes	Yes
CS315	Yes	Yes	Yes	HBL1222RKL	No	Yes	Yes
CS120	Yes	Yes	Yes	HBL1223RKL	No	Yes	Yes
CS320	Yes	Yes	Yes	HBL1224RKL	No	Yes	Yes
CSB115	Yes	Yes	Yes	HBL1259I	No	No	No
CSB215	Yes	Yes	Yes	HBL1281	No	Yes	Yes
CSB315	Yes	Yes	Yes	HBL1282	No	Yes	Yes
CSB415	Yes	Yes	Yes	HBL1283	No	No	No
CSB120	Yes	Yes	Yes	HBL1284	No	No	No
CSB220	Yes	Yes	Yes	HBL1287I	No	Yes	Yes
CSB320	Yes	Yes	Yes	HBL1288I	No	No	No
CSB420	Yes	Yes	Yes	HBL1281MO	No	No	No
CSL115	Yes	Yes	Yes	HBL1281MC	No	No	No
CSL215	Yes	Yes	Yes	HBL1297	No	Yes	Yes
CSL315	Yes	Yes	Yes	HBL1298	No	No	No
CSL415	Yes	Yes	Yes	HBL1381	No	Yes	Yes
CSL120	Yes	Yes	Yes	HBL1382	No	Yes	Yes
CSL220	Yes	Yes	Yes	HBL1385	No	Yes	Yes
CSL320	Yes	Yes	Yes	HBL1386	No	Yes	Yes
CSL420	Yes	Yes	Yes	HBL1386L	No	Yes	Yes
DS115	No	Yes	Yes	HBL1388	No	Yes	Yes
DS315	No	Yes	Yes	HBL1556	No	Yes	Yes
DS120	No	Yes	Yes	HBL1557	No	Yes	Yes
DS220	No	Yes	Yes	HBL1556L	No	Yes	Yes
DS320	No	Yes	Yes	HBL1557L	No	Yes	Yes
DS420	No	Yes	Yes	HBL3031	Yes	Yes	Yes
DS120IL	No	Yes	Yes	HBL3032	Yes	Yes	Yes
DS320IL	No	Yes	Yes	HBL3033	Yes	Yes	Yes
DS120PL	No	Yes	Yes	HBL3031PL	Yes	Yes	Yes
DSL115	No	Yes	Yes	HBL3031PL	Yes	Yes	Yes
DSL215	No	Yes	Yes	HBL3032PL	Yes	Yes	Yes
DSL315	No	Yes	Yes	SNAP1201	No	Yes	Yes
DSL415	No	Yes	Yes	SNAP1201IL	No	Yes	Yes
DSL120	No	Yes	Yes	SNAP1201PL	No	Yes	Yes
DSL220	No	Yes	Yes	SNAP1203	No	Yes	Yes
DSL320	No	Yes	Yes	SNAP1203IL	No	Yes	Yes
DSL420	No	Yes	Yes	SNAP1221	No	Yes	Yes
HBL1201	Yes	Yes	Yes	SNAP1221IL	No	Yes	Yes
HBL1202	Yes	Yes	Yes	SNAP1221PL	No	Yes	Yes
HBL1203	Yes	Yes	Yes	SNAP1223	No	Yes	Yes
HBL1204	Yes	Yes	Yes	SNAP1223	No	Yes	Yes
HBL1201IL	Yes	Yes	Yes	SNAP1223IL	No	Yes	Yes
HBL1203IL	Yes	Yes	Yes	SNAP2101	No	Yes	Yes
HBL1201PL	Yes	Yes	Yes	SNAP2101IL	No	Yes	Yes
HBL1203PL	Yes	Yes	Yes	SNAP2101PL	No	Yes	Yes
HBL1201L	Yes	Yes	Yes	SNAP2103	No	Yes	Yes
HBL1202L	Yes	Yes	Yes	SNAP2103IL	No	Yes	Yes
HBL1203L	Yes	Yes	Yes	SNAP2121	No	Yes	Yes
HBL1204L	Yes	Yes	Yes	SNAP2121IL	No	Yes	Yes
HBL1221	Yes	Yes	Yes	SNAP2121PL	No	Yes	Yes
HBL1222	Yes	Yes	Yes	SNAP2123	No	Yes	Yes
HBL1223	Yes	Yes	Yes	SNAP2123IL	No	Yes	Yes

Note: Catalog numbers above represent all colors and variations.



1-Gang



2-Gang

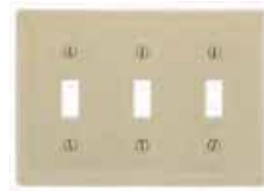

3-Gang

**Standard Size, Smooth Nylon, Toggle Switch Plates**

Color	Catalog Number		
Almond	NP1AL	NP2AL	NP3AL
Black	NP1BK	NP2BK	NP3BK
Brown	NP1	NP2	NP3
Gray	NP1GY	NP2GY	NP3GY
Ivory	NP1I	NP2I	NP3I
Light Almond	NP1LA	NP2LA	NP3LA
Office White	NP1OW	NP2OW	NP3OW
Red	NP1R	NP2R	—
White	NP1W	NP2W	NP3W

**Standard Size, Smooth Metal, Toggle Switch Plates**

Color	Catalog Number		
Aluminum	SA1	SA2	①
Brass	SB1	SB2	SBP3*
Stainless Steel, 302/304	SS1	SS2	SS3
Stainless Steel, 430	SS1L	SS2L	SS3L



1-Gang



2-Gang

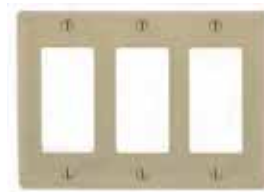

3-Gang

**Standard Size, Smooth Nylon, Style Line® Switch Plates**

Color	Catalog Number		
Almond	NP26AL	NP262AL	NP263AL
Black	NP26BK	NP262BK	NP263BK
Brown	NP26	NP262	NP263
Gray	NP26GY	NP262GY	NP263GY
Ivory	NP26I	NP262I	NP263I
Light Almond	NP26LA	NP262LA	NP263LA
Office White	NP26OW	NP262OW	NP263OW
Red	NP26R	NP262R	NP263R
White	NP26W	NP262W	NP263W

**Standard Size, Smooth Metal, Style Line® Switch Plates**

Color	Catalog Number		
Aluminum	①	①	①
Brass	SB26	SB262	①
Stainless Steel, 302/304	SS26	SS262	SS263
Stainless Steel, 430	SS26L	SS262L	—

Note: See section N for additional wallplates.

\*Brass plated.

① Available as a custom metal wallplate. See section N for additional information.

## Switches

# 600 to 2000 Watts, 120 Volts AC 60Hz

Slide and Rotary Control Dimmers

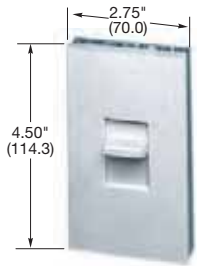

600 and 1000W Dimmer  
Fits Single-Gang Wall Boxes.  
**AS63 and AS103**

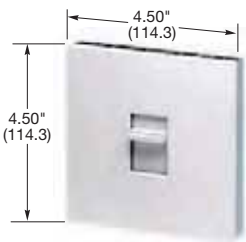

1500 and 2000W Dimmer  
Fits Single-Gang Wall Boxes.  
**AS153 and AS203**



600 and 1000W Dimmer  
Fits Single-Gang Wall Boxes.  
**AR61 and AR101**

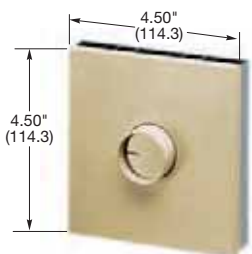

1500 and 2000W Dimmer  
Fits Single-Gang Wall Boxes.  
**AR151 and AR201**

### Architectural Grade, Incandescent Preset Slide Control Dimmers

Description	Color	Rating	Catalog Number
Single pole/three way - preset.	White	600W, 120V AC, 60Hz	<b>AS63</b>
Single pole/three way - preset.	White	1000W, 120V AC, 60Hz	<b>AS103</b>
Single pole/three way - preset.	White	1500W, 120V AC, 60Hz	<b>AS153</b>
Single pole/three way - preset.	White	2000W, 120V AC, 60Hz	<b>AS203</b>

### Accessories

Description	Color	Catalog Number
Small plate kit for 600W and 1000W models.	Ivory	<b>AS1I</b>
Includes non-metallic trimplate and slide.	White	<b>AS1W</b>
Large plate kit for 1500W and 2000W models.	Ivory	<b>AS2I</b>
Includes non-metallic trimplate and slide.	White	<b>AS2W</b>

*Note: The dimmers listed above can be wired for single pole or three way applications.  
See page D-17 for ganging and derating.*

### Architectural Grade, Incandescent Rotary Control Dimmers

Description	Color	Rating	Catalog Number
Single pole - push on/off.	Beige	600W, 120V AC, 60Hz	<b>AR61</b>
Three way - push on/off.	Beige		<b>AR63</b>
Single pole - push on/off.	Beige	1000W, 120V AC, 60Hz	<b>AR101</b>
Three way - push on/off.	Beige		<b>AR103</b>
Single pole, rotary on/off.	Beige	1500W, 120V AC, 60Hz	<b>AR151</b>
Single pole, rotary on/off.	Beige	2000W, 120V AC, 60Hz	<b>AR201</b>

### Accessories

Description	Color	Catalog Number
Small plate kit for 600W and 1000W models.	Beige	<b>AR1BE</b>
Includes non-metallic trimplate and knob.	White	<b>AR1W</b>
Large plate kit for 1500W and 2000W models.	Beige	<b>AR2BE</b>
Includes non-metallic trimplate and knob.	White	<b>AR2W</b>

*Note: See page D-17 for ganging and derating.*

# Switches

## Dimmer Ganging and Derating

### Architectural Grade Slide and Rotary Series Number of Switchboxes Required with Dimmer Side sections Intact

		Number of Small Controls (600W and 1000W)						
		0	1	2	3	4	5	6
Number of Large Controls (1500W and 2000W)	0	0	1	1+1	4	1+4	7	1+7
	1	1	3	5	6	8	9	11
	2	4	6	7	9	10	12	13
	3	6	8	10	11	13	14	16
	4	9	11	12	14	15	17	18
		Number of Gangs Required						

Note: When ganging an even number of small controls with no side sections removed (plus numbers in chart), use gangable switchboxes with tapped ears as shown below. Do not use plaster rings or gangbox covers. Space an additional switchbox 3/4 in. apart from the other switchbox(es). A 3/4 in. close nipple is recommended as a spacer between the switchboxes.

### Example of 4-Gang Installation

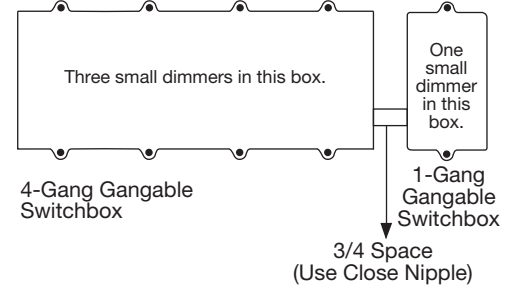

### Number of Switchboxes Required with Side Sections Removed

		Number of Small Controls (600W and 1000W)						
		0	1	2	3	4	5	6
Number of Large Controls (1500W and 2000W)	0	0	1	2	3	4	5	6
	1	1	3	4	5	6	7	8
	2	3	5	6	7	8	9	10
	3	5	7	8	9	10	11	12
	4	7	9	10	11	12	13	14
		Number of Gangs Required						

Note: When removing side sections, remove only inner side sections. Do not remove side sections on outer ends of gang. The same installation rules apply to rotary dimmers (not shown).

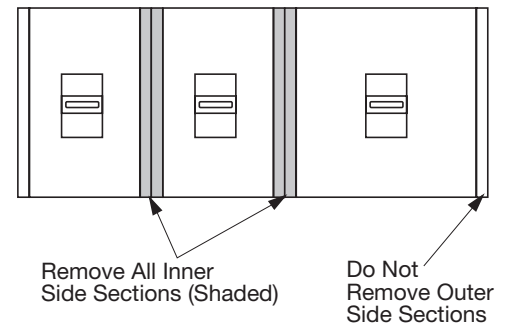

### Derating Chart

No side sections removed	One side section removed	Both side sections removed
600W	600W	500W
1000W	900W	700W
1500W	1250W	1000W
2000W	1800W	1500W

Note: When ganging any combination of small and large controls, place a small control on one extreme end of the gang, and a large control at the other end of the gang. When ganging with side sections intact, use offset mounting holes. When ganging with side sections removed, use center mounting holes. Allow a 1/2 in. gap (space) between controls for ease in attaching the faceplate.

### Specification Grade Slide and Rotary Series Switchboxes Required: Side sections removed

#### Derating Chart

1 dimmer in wall box	2 dimmers in wall box	3 or more dimmers in wall box
600W	500W	400W
1000W	800W	650W
5A fan speed	4A fan speed	3A fan speed



HBL11



HBL123SP

**10A 250V AC 20A 125V AC Horsepower Rated 3/4 HP, 125-250V AC**

Description		Terminal	Catalog Number
Single pole/ single throw.		Screw Spade	<b>HBL11</b> <b>HBL11SP</b>
Single pole/ single throw momentary.		Screw Spade	<b>HBL11M</b> <b>HBL11SPM</b>
Single pole/ double throw.		Screw Spade	<b>HBL12</b> <b>HBL12SP</b>
Single pole/ double throw 3-position center off.		Screw Spade	<b>HBL123</b> <b>HBL123SP</b>
Single pole/ double throw 3-position center off momentary.		Screw Spade	<b>HBL123MM</b> <b>HBL123SPMM</b>

Note: All threaded stems 1/32 in.-32 thread.

**10A 240V AC 15A 120V AC**

Description		Terminal	Catalog Number
Single pole/ single throw.		Screw	<b>HBL118</b>

Note: 1/32 in.-32 thread.

**4A 250V 8A 125V 10A 120V AC 1/3 HP 120V AC**

Description		Terminal	Catalog Number
Single pole/ single throw.		#18 Std. AWG Copper Wire Leads 105° C Black.	<b>HBL11WL</b>

Note: 1/32 in.-32 thread, keyway .080 x .035.

**Specifications**

- Impact Resistant Thermoplastic Body.
- Fine Silver Contacts.
- Knurled Nut, Hex Nut And Strap All Nickel Plated.
- Keyed Brass Bushing Nickel Plated.
- Brass Toggle Nickel Plated.
- Choice of Terminal Design: .250 in. (6.3) Male Tab Spade Type or 6/32 Screw Type.
- UL Recognized.

Dimensions in Inches (mm)



# Switches

## Heavy Duty Panel Mount

Panel Mount and Bat Handle Switches

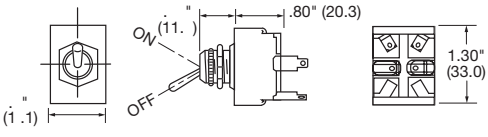
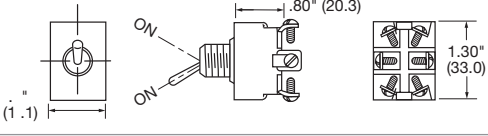
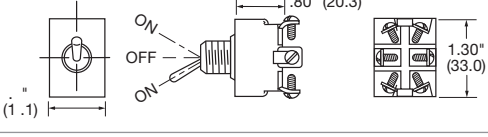
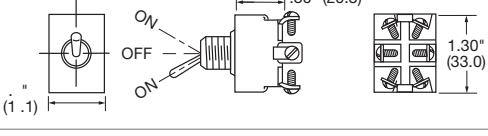

### 10A 250V AC 20A 125V AC Horsepower Rated 1½ HP, 125-250V AC

Description	Terminal	Catalog Number
Double pole/ single throw. 	Screw Spade	<b>HBL21</b> <b>HBL21SP</b>
Double pole/ single throw. 	Screw Spade	<b>HBL22</b> <b>HBL22SP</b>
Double pole/ double throw 3-position center off. 	Screw Spade	<b>HBL223</b> <b>HBL223SP</b>
Double pole/ double throw 3-position center off momentary. 	Screw Spade	<b>HBL223MM</b> <b>HBL223SPMM</b>
Silicone rubber boot.	Screw Spade	<b>SSB1</b>

Note: All threaded stems 1/32 in. -32 thread.  
See Y-33 for information on 12V DC tapered handle switches.



HBL21



HBL223



SSB1

### 4A 250V 8A 125V 10A 120V AC 1/3 HP 120V AC

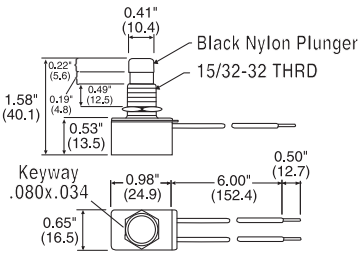
Description	Terminal	Catalog Number
Single pole/ single throw. 	#18 Std. AWG Copper Wire Leads 105° C Black.	<b>HBL11PBWL</b>

Note: 1/32 in. -32 thread, keyway .080 x .035.



HBL11PBWL

Dimensions in Inches (mm)

# Switches

## Technical Information

Toggle Switch Wiring Diagrams and Specifications

### Standard Toggle Type Switches

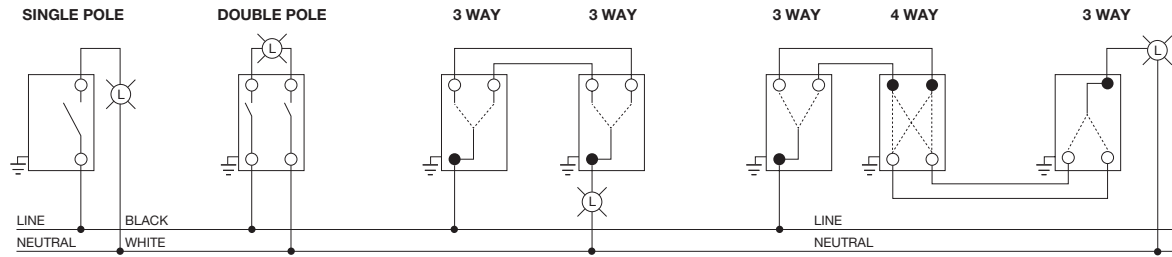

### Illuminated Switches (light on with load off)

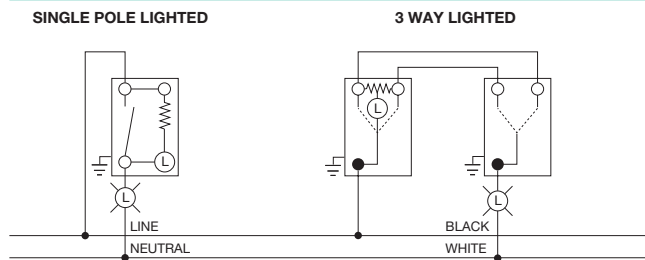

### Pilot Light Switches (light on with load on)

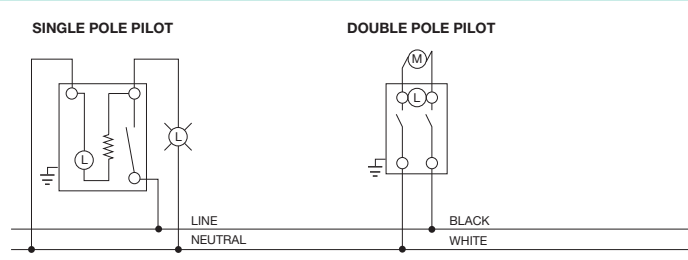

### Three Way Pilot Switches

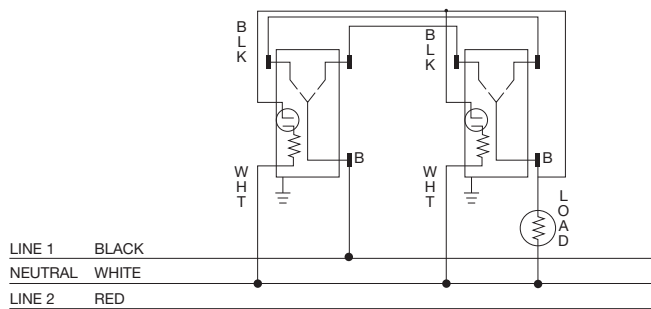

### Three Position Switches, Momentary and Maintained

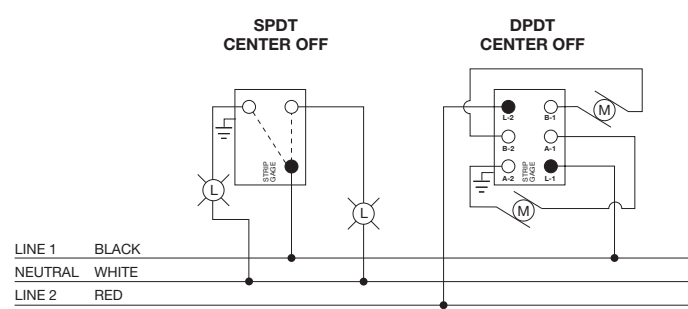

### Specifications - HBL® Extra Heavy Duty Industrial Grade Switches (SP, DP, 3-Way, 4-Way)

Listings	Component	Material
UL Listed	Base	Thermoset, Color Coded by Amperage
CSA Certified	Top	Thermoset, Gray
Verified to Fed. Spec. W-S-896,	Toggle	Nylon
SP, DP, 3-way and 4-way	Terminals	Brass
	Terminal Screws	Brass
	Mounting Bridge	Nickel Plated Steel
	Contacts	Silver Alloy
	Moveable Contact Arm	Brass
	Rocker	Elastomer
	Ground Terminal	Nickel-Plated Steel
	Ground Screw	Brass
	Automatic Grounding Clip	Stainless Steel

### Performance Data

Electrical	
Dielectric Voltage	Withstands 1500V AC minimum for 1 minute.
Max. Working Voltage	277V AC.
Overload	Minimum 4.8 times rated current for 100 cycles.
Temperature Rise	30°C maximum at rated current.
Max. Continuous Current	15A, 20A, 30A.
Endurance	50,000 cycles min., tungsten filament lamp load Fed. Spec. #WS896, SP, DP, 3-way and 4-way.
Mechanical	
Terminal Accommodations	#14 AWG min. - #10 AWG max. solid and stranded copper wire only.
Environmental	
Flammability	UL 94V-2.
Operating Temperature	Max. continuous: 75°C; Min. continuous: -40°C without impact.

# Section E H-MOSS® Controls

## Index

Product	Page
<b>Sensor Technology</b>	
Technologies for Smart Buildings . . . . .	E-2
Energy Savings with Occupancy Sensors . . . . .	E-3
<b>Wall Switches</b>	
Wall Switches with Adaptive Technology . . . . .	E-5
Wall Switches with Passive Infrared Technology and Digital Timer . . . . .	E-6
<b>Ceiling Sensors</b>	
Low Voltage and Line Voltage Ceiling Sensors . . . . .	E-7
Wall Mount Sensors, Control Units and Accessories . . . . .	E-8
OPTIMYZER™ High Bay Controls and Daylight Harvesting . . . . .	E-9
<b>H-MOSS® MAXX™ Harsh Environment Occupancy Sensors</b>	
Watertight OPTIMYZER® . . . . .	E-11
<b>WL-Series Wireless Sensors and Controls</b>	
Wall Switches with Adaptive Technology . . . . .	E-12
<b>Plug Load Control Products for ASHRAE and CEC Title 24 Compliance</b>	
System Overview / Methods for Compliance . . . . .	E-14
Control Units . . . . .	E-15
<b>Coverage Patterns, Specifications and Wiring Schematics</b>	
WL-Series Wireless Sensors . . . . .	E-16
Wall Switches . . . . .	E-19
Ceiling Sensors . . . . .	E-22
OPTIMYZER™ High Bay Controls . . . . .	E-23
H-MOSS® MAXX™ Harsh Environment Occupancy Sensors . . . . .	E-24
Control Units and Add-A-Relay . . . . .	E-25
WLC Load Control with Wireless Receive . . . . .	E-26
Ceiling and Wall Mount Sensors . . . . .	E-27

### Wall and Ceiling Mount Sensors



### H-MOSS®|MAXX™ Sensors



### WL-Series Wireless Sensors and Controls



### High Bay and Daylight Harvesting



H-MOSS® Occupancy Sensors Combine Innovative  
Technologies for Industry Proven Performance.



**Adaptive Technology**

Adaptive Technology is a Hubbell breakthrough that delivers benefits to both building owners and occupants. The building owner achieves reduced energy costs, fewer adjustments and less maintenance, and the building occupant experiences fewer false-offs and disturbances.

Adaptive technology occupancy sensors use microprocessors that make all the decisions for setting adjustments. Internal software constantly monitors the controlled area and automatically adjusts the sensitivity and timer based on environmental history. This means that instead of manually adjusting the sensor for seasonal changes, modified airflow, furniture layout or occupancy pattern changes, the sensor automatically adjusts itself. These automatic adjustments eliminate the need for multiple manual adjustments by maintenance personnel or outside contractors. Hubbell offers adaptive technology throughout its product offering—wall switches, ceiling and wall mount sensors—in conjunction with dual technology, ultrasonic and passive infrared products.

**How to Select the Right Technology for the Proper Application**

**Dual Technology**

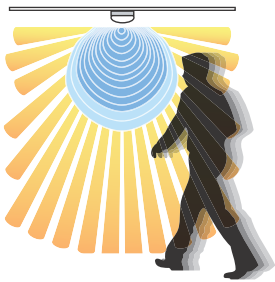

Dual technology occupancy sensors combine both passive infrared (PIR) and ultrasonic (US) technologies for maximum reliability. Because US and PIR need to both detect occupancy to turn lighting on, dual technology sensors minimize the risk of lights coming on when the space is unoccupied—false triggering. Continued detection by only one technology then keeps lighting on as necessary. Dual technology sensors offer the best performance for most applications.

**Ultrasonic (US)**

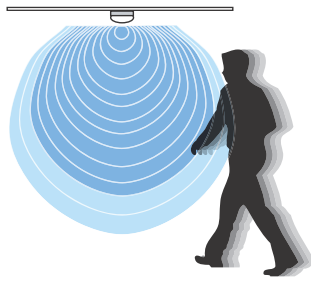

Ultrasonic (US) technology senses occupancy by bouncing sound waves (32 kHz - 45 kHz) off of objects and detecting a frequency shift between the emitted and reflected sound waves. Movement by a person or object within a space causes a shift in frequency, which the sensor interprets as occupancy. While US occupancy sensors have a limited range, they are excellent at detecting even minor motion such as typing and filing, and they do not require an unobstructed line-of-sight. This makes US technology sensors ideal for an application like an office with cubicles or a restroom with stalls.

**Passive Infrared (PIR)**

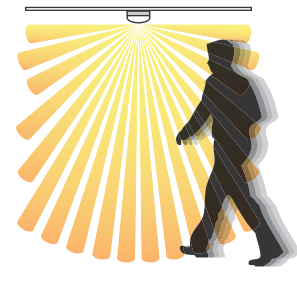

Passive infrared (PIR) technology senses occupancy by detecting the movement of heat emitted from the human body against the background space. Unlike US technology, PIR sensors require an unobstructed line-of-sight for detection. These sensors use a segmented lens, which divides the coverage area into zones. Movement between zones is then interpreted as occupancy. PIR sensors are ideal for detecting major motion (e.g. walking), and they work best in small, enclosed spaces with high levels of occupant movement.

# H-MOSS® Controls Energy Savings with Occupancy Sensors

## Typical Applications



Applications are generalized. Consult your Hubbell representative for the type of technology and products that fit your needs.

Application		Sensor Technology				Sensor Style		
		Adaptive	Dual	Ultrasonic	PIR	Wall Switch	Ceiling	Wall
Office	Small	✓+	✓+		✓	✓+	✓	
	Large	✓+	✓+	✓			✓+	
Open Office		✓+	✓	✓+			✓+	
Storage/ Warehouse	Small				✓+	✓+		
	Large	✓+			✓+		✓+	✓+
Rest Room	Small			✓+	✓+	✓+	✓	
	Large	✓+		✓+			✓+	
Conference Room	Small	✓+	✓+			✓+	✓	
	Large	✓+	✓+				✓+	
Classroom	Small	✓+	✓+			✓+	✓	
	Large	✓+	✓+				✓+	
Hall		✓+		✓+	✓		✓+	✓

## Hubbell Occupancy Sensors Play a Key Role

In the U.S., lighting consumes 22% of electricity and represents \$40 billion a year in energy costs. Using advanced technology, Hubbell's H-MOSS® Occupancy Sensors are doing their part to save energy and provide sustainability by automatically and effectively turning lights on when a room is occupied and off when a room is vacant. In a typical office building, where lighting accounts for 35 to 45% of energy use, H-MOSS Occupancy Sensors have the potential to reduce wasted lighting by 13% to 90% for a significant return on investment (ROI).

Hubbell offers a broad range of occupancy and vacancy sensors and lighting controls that meet the latest codes and standards, including ASHRAE/IESNA 90.1 and California Energy Commission (CEC) Title 24. H-MOSS Occupancy Sensors can also provide LEED® points in categories like Sustainable Sites, Energy and Atmosphere, Indoor Environmental Quality and Innovative Design Process.

### Electrical bill impact for a typical office building\*

Lighting Uses 39% of Total Electricity

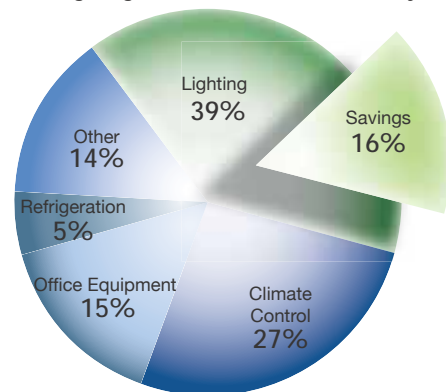

Note: \*Energy Information Administration:  
- Commercial Buildings  
- Energy Consumption Survey

\*\*Based on 40% lighting savings from sensors. Actual results may vary.

## Backed by Hubbell Service and Support

H-MOSS® Occupancy Sensors are backed by Hubbell's GreenWise™ sustainability initiative and superior service and support including:

- Valuable online H-MOSS ROI worksheet for calculating energy savings
- Detailed H-MOSS online e-learning courses that can be taken anywhere, anytime
- Product selection guide for choosing the right H-MOSS Occupancy Sensor and technology
- Online specification assistance through spec wizard, AutoCAD drawings, templates, BIM objects and documentation
- Comprehensive design assistance for deploying occupancy sensors in a variety of applications
- Highly knowledgeable network of specification professionals and trained, dedicated sales staff
- Backed by Hubbell who is committed to safeguarding the environment through environmental stewardship, innovative products and efficient operations



## H-MOSS® Controls Adaptive Dual Technology Wall Switches

Features and Benefits



Available in ivory, white, black, gray and light almond

Impact resistant hard lens is standard and color matched to the switch

Dual technology sensing combines the individual advantages of passive infrared and ultrasonic detection

Designed for use on 120 or 277V AC circuits. No neutral needed for fast retrofits

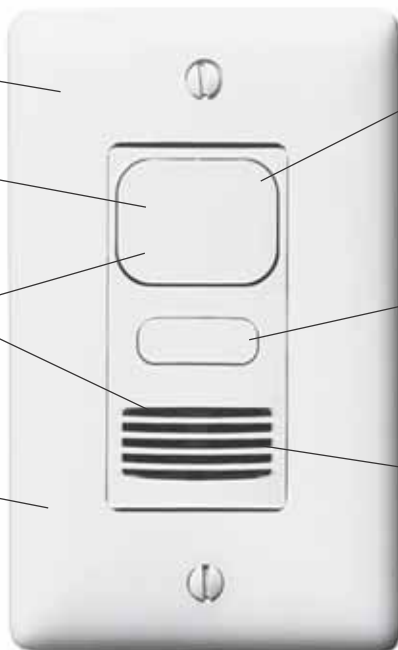

Built in photocell with manual super saver mode for daylight harvesting

Auto or manual "On" operating modes. Available in either single relay or dual relay versions for enhanced savings with bi-level switching applications

Adaptive technology - "Install and forget" operation, analyzes environment and adjusts sensitivity and timer, eliminating the need for manual adjustment

**AD2000W1  
with NP26W**

## Adaptive Passive Infrared Wall Switches

Features and Benefits

Wall plate included for simplified ordering

High density 1200 square foot 180° coverage with tough tamper resistant lens

Photocell can prevent lights from turning on with sufficient natural light

Front press switch allows the occupant to switch the sensor from automatic operation to momentary off mode

Designed for use on 120 or 277V AC circuits. No neutral needed for fast retrofits



Heavy-duty relay controls up to 1000 watts at 120V AC or 1800 watts at 277V AC

Nightlight version available to provide minimum illumination when the lights are off

Tamper resistant push button covers the time-out, service switch, and vac/occ operation mode settings

**ATP2000W**

### Adaptive Technology

- Adaptive technology - "Install and forget" operation
- All digital sensing technology
- Dual 120/277V AC operation. No neutral required
- Auto or manual "On" operating modes
- No minimum load requirements
- Hard lens (dual technology, passive infrared)
- Steel mounting strap
- Zero arc point switching
- Built in photocell with manual super saver mode for daylight harvesting
- Bi-level switching or dual load control (2 or 2N suffix)
- cULus



AD2000W1



AD2000W1N  
 AD2000W2N



AU2000W1



AU2000W2



AP2000W1



AP2000W2

### Dual (Ultrasonic and Passive Infrared)

1000 square foot coverage with photocell, 800W Incandescent, 1000W Fluorescent at 120V AC, 1800W Fluorescent at 277V AC, 50/60Hz.

Description	Color	Single Circuit		Dual Circuit	
		1 button for manual/auto control	Auto control with no button	2 buttons for manual/auto control	Auto control with no button
Dual (ultrasonic and passive infrared)	Black	AD2000BK1	AD2000BK1N	AD2000BK2	AD2000BK2N
	Gray	AD2000GY1	AD2000GY1N	AD2000GY2	AD2000GY2N
	Ivory	AD2000I1	AD2000I1N	AD2000I2	AD2000I2N
	Light Almond	AD2000LA1	AD2000LA1N	AD2000LA2	AD2000LA2N
	White	AD2000W1	AD2000W1N	AD2000W2	AD2000W2N

Note: Wallplate sold separately. Neutral wire versions available. Use ADN prefix when ordering. See pages E-16 and E-17 for coverage patterns and technical specifications.

### Ultrasonic

400 square foot coverage with photocell, 800W Incandescent, 1000W Fluorescent at 120V AC, 1800W Fluorescent at 277V AC, 50/60Hz.

Description	Color	Single Circuit		Dual Circuit	
		1 button for manual/auto control	Auto control with no button	2 buttons for manual/auto control	Auto control with no button
Ultrasonic	Black	AU2000BK1	AU2000BK1N	AU2000BK2	AU2000BK2N
	Gray	AU2000GY1	AU2000GY1N	AU2000GY2	AU2000GY2N
	Ivory	AU2000I1	AU2000I1N	AU2000I2	AU2000I2N
	Light Almond	AU2000LA1	AU2000LA1N	AU2000LA2	AU2000LA2N
	White	AU2000W1	AU2000W1N	AU2000W2	AU2000W2N

Note: Wallplate sold separately. Neutral wire versions available. Use AUN prefix when ordering. See pages E-16 and E-17 for coverage patterns and technical specifications.

### Passive Infrared

1000 sq. ft. coverage with photocell, 800W Incandescent, 1000W Fluorescent at 120V AC, 1800W Fluorescent at 277V AC, 50/60Hz.

Description	Color	Single Circuit		Dual Circuit	
		1 button for manual/auto control	Auto control with no button	2 buttons for manual/auto control	Auto control with no button
Passive infrared	Black	AP2000BK1	AP2000BK1N	AP2000BK2	AP2000BK2N
	Gray	AP2000GY1	AP2000GY1N	AP2000GY2	AP2000GY2N
	Ivory	AP2000I1	AP2000I1N	AP2000I2	AP2000I2N
	Light Almond	AP2000LA1	AP2000LA1N	AP2000LA2	AP2000LA2N
	White	AP2000W1	AP2000W1N	AP2000W2	AP2000W2N

Note: Wallplate sold separately. Neutral wire versions available. Use APN prefix when ordering. See pages E-16 and E-17 for coverage patterns and technical specifications.



AT1277W

**Adaptive Technology, Passive Infrared**

- Adaptive technology - "Install and forget" operation
- Passive infrared technology
- Dual 120/277V AC operation, no neutral required
- Heavy duty relay (AT1277xx)
- Audible alarm before turning lights off (AT1277xx)
- 1200 sq. ft. coverage
- Built in photocell for daylight harvesting
- Wallplate included
- Steel mounting strap
- cULus

Description	Color	Standard	w/ Nightlight	w/ Neutral	w/ Nightlight and Neutral
High load adaptive wall switch, 1800W @ 120V AC and 4166W @ 277V AC	Ivory White	<b>AT1277I</b> <b>AT1277W</b>	— —	— —	— —
Adaptive auto-adjusting; selectable manual/auto-on operation; dual-voltage 120/277V; 3-way capable	Gray Ivory Light Almond White	<b>ATP2000GY</b> <b>ATP2000I</b> <b>ATP2000LA</b> <b>ATP2000W</b>	<b>ATP2000NGY</b> <b>ATP2000NI</b> <b>ATP2000NLA</b> <b>ATP2000NW</b>	— <b>ATP2004I</b> — <b>ATP2004W</b>	— <b>ATP2004NI</b> — <b>ATP2004NW</b>

Note: See pages E-17 and E-18 for coverage patterns and technical specifications.



ATP2000W

**Passive Infrared Wall Switches**

- Passive infrared technology
- Manual adjustment time delay (20 sec. to 30 min.)
- Photocell (WS2000 series)
- No neutral required
- 1200 sq. ft. coverage
- Wallplate included
- Steel mounting strap
- cULus

Description	Color	Standard	w/ Nightlight	w/ Neutral	w/ Nightlight and Neutral
Manual adjusting; selectable manual/auto-on operation; dual-voltage 120/277V; 3-way capable	Gray Ivory Light Almond White	<b>WS2000GY</b> <b>WS2000I</b> <b>WS2000LA</b> <b>WS2000W</b>	<b>WS2000NGY</b> <b>WS2000NI</b> <b>WS2000NLA</b> <b>WS2000NW</b>	— <b>WS2004I</b> — <b>WS2004W</b>	— <b>WS2004NI</b> — <b>WS2004NW</b>
Manual adjusting; auto-on operation; 120V AC only	Ivory White	<b>WS1000I</b> <b>WS1000W</b>	<b>WS1000NI</b> <b>WS1000NW</b>	— —	— —
Manual adjusting; Manual-on operation; 120V AC only	Ivory White	<b>WS1001I</b> <b>WS1001W</b>	<b>WS1001NI</b> <b>WS1001NW</b>	— —	— —

Note: See pages E-17 and E-18 for coverage patterns and technical specifications.



WS2000W  
WS1000W



DT2000W

**Digital Timer Wall Switch**

Description	Color	Catalog Number
Dip switch enabled preset intervals, user adjustable up to 4 hours, 3-way capable, 960W @ 120V AC and 1200W @ 277V AC. Includes an on/off momentary push button switch feature	White	<b>DT2000W</b>

**Count Down Timer Wall Switch**

Description	Color	30 Minutes: Off, 5, 10, 20, 30	60 Minutes: Off, 15, 30, 45, 60	12 Hours: Off, 2, 4, 8, 12
1000W @ 120V AC and 1400W @ 277V AC	Ivory Light Almond White	<b>DT5030I</b> <b>DT5030LA</b> <b>DT5030W</b>	<b>DT5060I</b> <b>DT5060LA</b> <b>DT5060W</b>	<b>DT5012I</b> <b>DT5012LA</b> <b>DT5012W</b>

**Ceiling Accessories**

Description	Catalog Number
Ceiling sensor infrared NEMA 4X enclosure	<b>ACIPE</b>
Ceiling mount wire guard	<b>ACMG</b>
Ceiling mount raceway adapter	<b>ACMRA</b>

**Wall Accessories**

Description	Catalog Number
Wall switch wire guard	<b>AWSG</b>
Wall mount wire guard	<b>AWMG</b>



ACIPE



ACMG



AWSG



AWMG



### Adaptive Technology

- Adaptive technology - "Install and forget"
- All digital sensing technology
- Photocell for daylight harvesting and relay to interface with auxiliary systems such as HVAC (CRP models)
- Mounting base included with sensor
- Non-volatile memory settings retained after power outage
- Low voltage units: 24V DC, 33mA
- Line voltage units: 20A, 120-277V
- 32kHz (ATD/ATU500C and CRP - 40kHz)
- cULus



ATD2000C Series

### Dual (Ultrasonic and Passive Infrared)

Combines the excellent minor motion detection of ultrasonic with the outstanding passive infrared (PIR) long-range major motion detection.

Description	Coverage	Color	Catalog Number
Low voltage sensor with photocell and isolated relay	2000 sq. ft. (360°)	White	ATD2000CRP
Low voltage sensor	2000 sq. ft. (360°)	White	ATD2000C
Line voltage sensor	2000 sq. ft. (360°)	White	ATD2000CL
Low voltage sensor with photocell and isolated relay	1000 sq. ft. (180°)	White	ATD1000CRP
Low voltage sensor	1000 sq. ft. (180°)	White	ATD1000C
Line voltage sensor	1000 sq. ft. (180°)	White	ATD1000CL
Low voltage sensor with photocell and isolated relay	500 sq. ft. (180°)	White	ATD500CRP
Low voltage sensor	500 sq. ft. (180°)	White	ATD500C

Note: Low voltage ATD ceiling sensors must use a CU series control units. See page E-8 for details. See pages E-19 and E-20 for coverage patterns and technical specifications.



ATD1000C/  
ATD500C Series

### Ultrasonic

Excellent minor motion detection.

Description	Coverage	Color	Catalog Number
Low voltage sensor with photocell and isolated relay	2000 sq. ft. (360°)	White	ATU2000CRP
Low voltage sensor	2000 sq. ft. (360°)	White	ATU2000C
Line voltage sensor	2000 sq. ft. (360°)	White	ATU2000CL
Low voltage sensor with photocell and isolated relay	1000 sq. ft. (180°)	White	ATU1000CRP
Low voltage sensor	1000 sq. ft. (180°)	White	ATU1000C
Line voltage sensor	1000 sq. ft. (180°)	White	ATU1000CL
Low voltage sensor with photocell and isolated relay	500 sq. ft. (180°)	White	ATU500CRP
Low voltage sensor	500 sq. ft. (180°)	White	ATU500C

Note: Low voltage ATU ceiling sensors must use a CU series control units. See page E-8 for details. See pages E-19 and E-20 for coverage patterns and technical specifications.



ATU2000C Series



ATU1000C/  
ATU500C Series

### Passive Infrared

Outstanding long range major motion detection.

Description	Coverage	Color	Catalog Number
Low voltage sensor with photocell and isolated relay	1500 sq. ft. (360°)	White	ATP1500CRP
Low voltage sensor	1500 sq. ft. (360°)	White	ATP1500C
Line voltage sensor	1500 sq. ft. (360°)	White	ATP1500CL
Low voltage sensor with photocell and isolated relay	450 sq. ft. (360°)	White	ATP600CRP
Low voltage sensor	450 sq. ft. (360°)	White	ATP600C
Line voltage sensor	450 sq. ft. (360°)	White	ATP600CL

Note: Low voltage ATP ceiling sensors must use a CU series control units. See page E-8 for details. See pages E-19 and E-20 for coverage patterns and technical specifications.



ATP1500C/  
ATP600C Series

### Low Profile, Line Voltage Passive Infrared (PIR)

Outstanding long range major motion detection in a compact low profile housing.

Voltage	Coverage	Load Rating	Color	Catalog Number
120-347V AC with photocell and isolated relay	1500 sq. ft.	800W Inc. 1000W Fl. @ 120V AC 1800W Fl. @ 277V AC 2200W Fl. @ 347V AC	White	LVPR1500R



LVPR1500R



ATD1600W  
 Series

### Adaptive Technology Wall Mount Sensors

- Adaptive technology - "Install and forget" operation
- Swivel mounting bracket included for wall or ceiling mounting
- All digital sensing technology
- Photocell for daylight harvesting and relay interface with auxiliary systems such as HVAC (RP models)
- 24V DC, 33mA
- cULus

### Dual (Ultrasonic and Passive Infrared)

Description	Coverage	Color	Catalog Number
Low voltage sensor 32kHz with photocell and isolated relay	1600 sq. ft.	White	<b>ATD1600WRP</b>
Low voltage sensor 32kHz	1600 sq. ft.	White	<b>ATD1600W</b>



ATP1600W,  
 ATP120HB  
 Series

### Passive Infrared

Description	Coverage	Color	Catalog Number
Low voltage sensor with photocell and isolated relay	1600 sq. ft.	White	<b>ATP1600WRP</b>
	1600 sq. ft.	White	<b>ATP1600W</b>
Low voltage sensor for aisle and high bay applications, with photocell and isolated relay	120 linear ft.	White	<b>ATP120HBRP</b>
	120 linear ft.	White	<b>ATP120HB</b>

*Note: All wall mount sensors must use a CU series control units. See below for details. See pages E-19 and E-20 for coverage patterns and technical specifications.*

### Accessories

#### Control Units

The CU300 series provides 24V DC power supply for sensors or sensor/Add-A-Relay combinations. The control units contain an internal relay for the control of an external lighting load. Control units are plenum rated cULus Listed.

Description	Catalog Number
Automatic-on operation, 120/277V AC, 50/60Hz for use with 1 to 4 ATD, ATU and ATP series ceiling/wall mount sensors	<b>CU300A</b>
Manual-on operation, 120/277V AC, 50/60Hz for use with 1 to 4 ATD, ATU and ATP series ceiling/wall mount sensors	<b>CU300M</b>
Auto or manual-on operation, 120/277V AC, 50/60Hz for use with 1 to 6 ATD, ATU and ATP series ceiling/wall mount sensors, heavy duty latching relay for reactive loads and plug-load control	<b>CU300HD</b>
Automatic-on operation, 347V AC, 60Hz, for use with 1 to 3 ATD, ATU and ATP series ceiling and wall mount sensors	<b>CU347A</b>

*Note: See page E-25 for technical specifications.*

#### Add-A-Relay

Hubbell AAR Add-A-Relay contains an internal relay for control of an external lighting load. The AAR requires a 24V DC power supply from the Hubbell CU series control unit. The AAR is typically used when: 1. It is desired to switch more than one circuit when occupancy is sensed. 2. The lighting load exceeds the maximum rating of the control unit.

Description	Catalog Number
For use with CU series control units and Hubbell ATD, ATU and ATP series ceiling and wall mount sensors	<b>AAR</b>

#### Low Voltage Switches

- Attractive, architectural design
- Available latching or momentary contact
- Mounts to standard single gang box
- 2-year warranty

Description	Color	Catalog Number
Low voltage switch, latching, 1 button	Ivory	<b>DSL3011</b>
	White	<b>DSL30W1</b>
Low voltage switch, momentary, 1 button	Ivory	<b>DSM3011</b>
	White	<b>DSM30W1</b>
Low voltage switch, momentary, 2 button	Ivory	<b>DSM30I2</b>
	White	<b>DSM30W2</b>

*Note: Wallplate sold separately.*



DSL30W1

## Multi-Level Relays

Description	Catalog Number
Enclosed independent control for multiple ballast light fixtures from one existing wall switch, bi-level; 120/208-277V AC	<b>AARBL2</b>
Enclosed independent control for multiple ballast light fixtures from one existing wall switch, tri-level; 120/208-277V AC	<b>AARBL3</b>



AARBL2

## Enclosed 10 Amp SPDT Relays

Description	Catalog Number
Enclosed relay 10 Amp SPDT with 10-30V AC/DC/120V AC coil	<b>AAR10C120</b>
Enclosed relay 10 Amp SPDT with 10-30V AC/DC/208-277V AC coil	<b>AAR10C277</b>



AAR10C277

## OPTIMYZER® High Bay Controls

- Digital passive infrared (PIR) sensor
- Multiple (single and dual) output versions
- Single and dual timer operation
- Low-profile design
- Supports mounting heights up to 40 ft
- Area and aisle coverage
- Universal voltage (120/277/347V AC) models available
- No minimum load

### Standard

Description	Voltage	Catalog Number
Fluorescent high bay PIR sensor, 1 relay	120-347V AC	<b>HMHB21U</b>
Fluorescent high bay PIR sensor, 2 relays	120-347V AC	<b>HMHB22U</b>
Fluorescent high bay PIR sensor, 1 double pole relay	208/240V AC	<b>HMHB23A</b>
Fluorescent high bay PIR sensor, 1 double pole relay	480V AC	<b>HMHB23B</b>
Fluorescent high bay PIR sensor	24V DC	<b>HMHB2LV*</b>



HMHB21U

## Daylight Harvesting (With Photocells)

Description	Voltage	Catalog Number
Fluorescent high bay PIR sensor, 1 relay with photocell	120-347V AC	<b>HMHB21UP</b>
Fluorescent high bay PIR sensor, 2 relays with photocell	120-347V AC	<b>HMHB22UP</b>
Fluorescent high bay PIR sensor, 1 double pole relay with photocell	208/240V AC	<b>HMHB23AP</b>
Fluorescent high bay PIR sensor, 1 double pole relay with photocell	480V AC	<b>HMHB23BP</b>
Fluorescent high bay PIR sensor with photocell	24V DC	<b>HMHB2LVP*</b>

See pages E-20 for coverage patterns and technical specifications.



HMHB21UP

## OPTIMYZER® Accessories

Description	Catalog Number
High bay mounting extension adapter	<b>HMHB5A</b>
External daylight control	<b>HMHBEP</b>



HMHB5A

## Daylight Harvesting

- Multiple calibration options
- Selectable 3- or 8-second dimming rate
- Low-profile design
- Light-sensitivity range of 0–500 foot candles

Description	Voltage	Catalog Number
Single zone continuous automatic dimming control	10V DC	<b>DHADC†</b>
Indoor photocell	24V DC	<b>DHIP▲</b>
Outdoor photocell	24V DC	<b>DHOP▲</b>
Atrium photocell	24V DC	<b>DHAP▲</b>
Skylight photocell	24V DC	<b>DHSP▲</b>
Control module	24V DC	<b>DHCM</b>
Daylight tracker with on/off control	24V DC	<b>DHT*</b>
Daylight tracker with dimming control	24V DC	<b>DHTD†</b>

Note: \*For use with CU series control units. See page E-10 for details.

†For use with 0-10V DC dimming ballasts.

▲ For use with DHCM and CU series control units.



DHIP, DHOP



DHAP, DHSP



DHCM



DHT

H-MOSS® Controls  
**H-MOSS®|MAXX™ Harsh Environment Occupancy Sensors**  
*Features and Benefits*



**H-MOSS®|MAXX™** products provide users with methods to reduce energy usage in harsh environments. These applications often have lights being left on and ventilation/HVAC systems constantly working. **H-MOSS®|MAXX™** products are designed to withstand these challenging environments and provide increased operating efficiency.

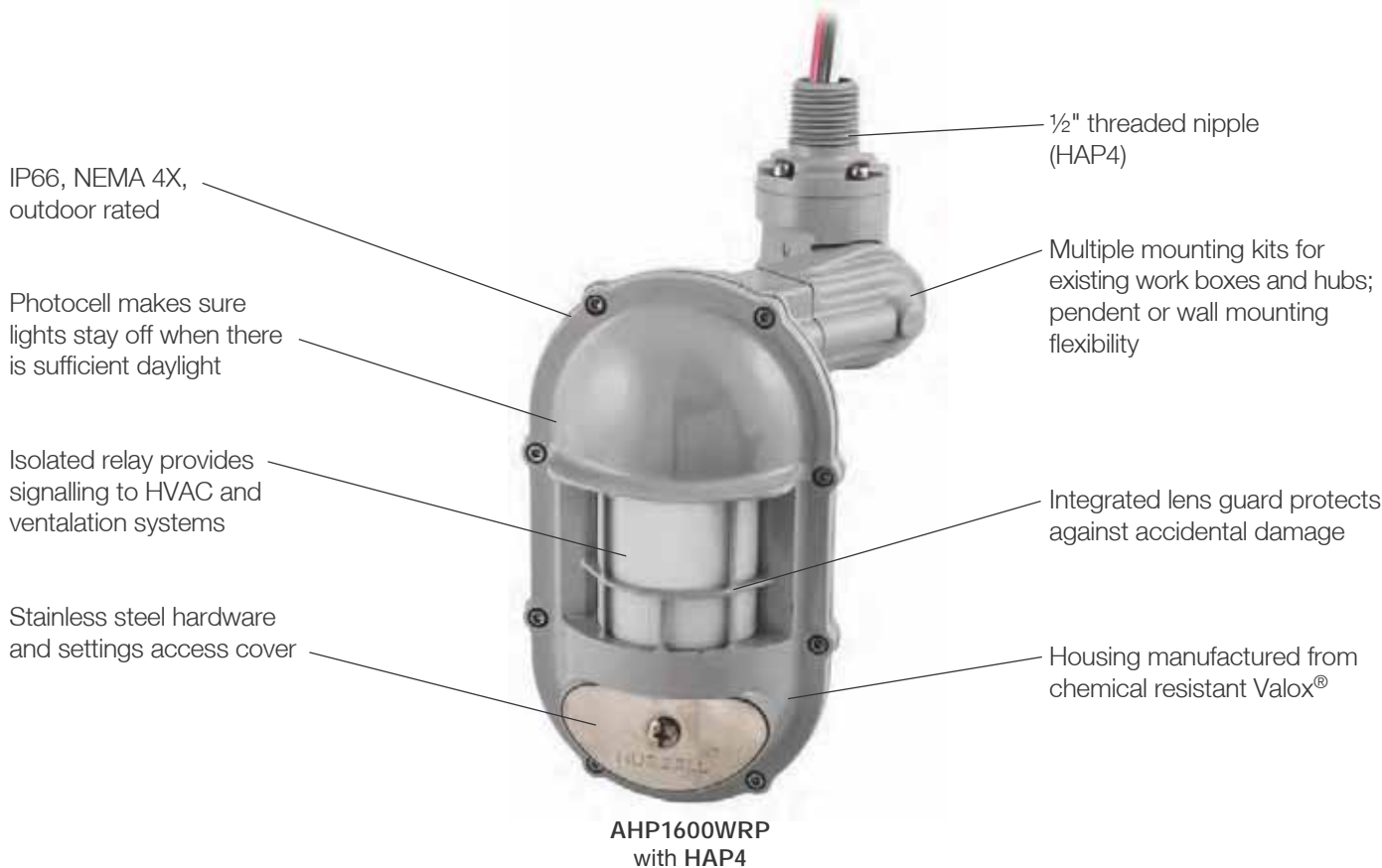

*Valox® is a trademark of SABIC Innovative Plastics, acquired from General Electric Company.*

### Outdoor Rated Watertight Wall Mount PIR Sensor

IP66, NEMA 4X, heavy duty wall or pendant mount sensor with -40°F to 149°F (-40°C to 65°C) operating temperature range and 160° of coverage.

Description	Voltage	Catalog Number
PIR sensor, with isolated relay and photocell	24V DC	<b>AHP1600WRP</b>
Adaptor plate for 1-gang FS boxes	—	<b>HAP1</b>
Adaptor hub and nipple for Killark NJ series boxes	—	<b>HAP2</b>
Adaptor plate for Killark NV series boxes	—	<b>HAP3</b>
½" NPT threaded hub	—	<b>HAP4</b>

Note: For use with a CU series control unit: CU300HD (120/277V AC, 50/60 Hz), CU347A (347V AC, 60 Hz).  
 See pages E-21 for coverage patterns and technical specifications.



**AHP1600WRP**

### Extreme Temperature PIR Ceiling Sensor

Upgraded ceiling sensor with -40°F to 149°F (-40°C to 65°C) operating temperature range. Use ACIPE to make NEMA 4X watertight.

Description	Voltage	Catalog Number
PIR sensor, with isolated relay and photocell	24V DC	<b>AHP1500CRP</b>
IP66, NEMA 4X enclosure	—	<b>ACIPE</b>

Note: For use with a CU series control unit: CU300HD (120/277V AC, 50/60 Hz), CU347A (347V AC, 60 Hz).  
 See pages E-21 for coverage patterns and technical specifications.



**ACIPE with  
AHP1500CRP**

### Heavy Duty Control Unit

Robust latching relay provides reliable performance over many different applications, including plug loads. 20A 100-277V AC, 1HP @ 120V, 2HP @ 240/277V. Auto or Manual-On operation. Powers up to six low voltage sensors.

Description	Voltage	Catalog Number
Heavy duty control unit	120-277V AC	<b>CU300HD</b>

Note: See page E-25 for technical specifications.



**CU300HD**

### Watertight OPTIMYZER®

IP65, NEMA 3R, outdoor rated, -40°F to 149°F (-40°C to 65°C) operating temperature range.

Description	Voltage	Catalog Number
Pir sensor, relay with photocell	120-347V AC	<b>HMHB21UPCW</b>
Pir sensor, 2 relays with photocell	120-347V AC	<b>HMHB22UPCW</b>
Pir sensor, 1 double pole relay with photocell	208, 240V AC	<b>HMHB23APCW</b>
Pir sensor, 1 double pole relay with photocell	480V AC	<b>HMHB23BPCW</b>
Pir sensor, with photocell	24V DC	<b>HMHB2LVPCW*</b>
180° Lens	—	<b>HMHBL180</b>
360° Lens (included)	—	<b>HMHBL360</b>
Aisle lens	—	<b>HMHBLA</b>
End of aisle lens	—	<b>HMHBLEA</b>

Note: \*For use with a CU series control unit: CU300HD (120/277V AC, 50/60 Hz), CU347A (347V AC, 60 Hz).  
 See pages E-21 for coverage patterns and technical specifications.



**HMHB21UPCW**

H-MOSS® Controls  
**WL-Series Wireless Sensors and Controls**  
*Features and Benefits*



Three operation modes available:  
 Auto-On, Auto-On Low-Light  
 and Manual-On

Passive infrared motion detection  
 with advanced digital signal  
 processing for fine motion  
 detection

Auto-On Low-Light feature will  
 only turn lights on automatically  
 if there is less than approximately  
 10 Lux (1 fc) of ambient light

10-year battery life design

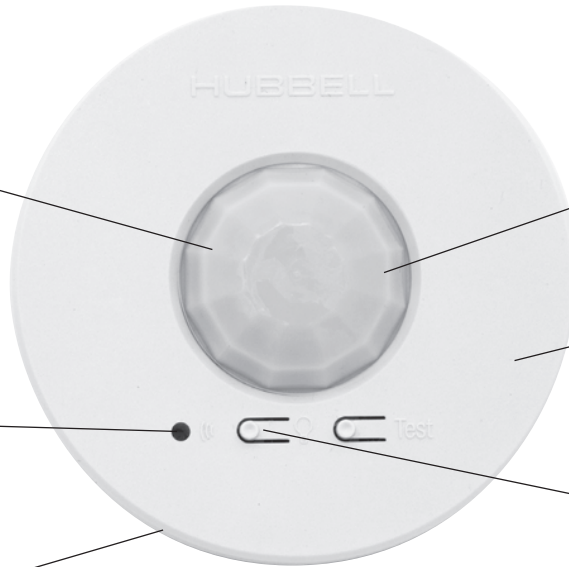

Lens illuminates during  
 test mode to verify  
 coverage

Adjustments available  
 for Timeout, Activity,  
 and Auto-On settings

Accessible test buttons  
 make setup easy

**WLP450C**

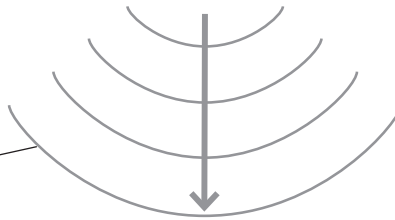

8A lighting, 3A fan  
 load capacity

Green LED provides  
 operation and setup  
 feedback

No neutral required,  
 no leakage to ground



**WLS1278W  
 with NP26W**

LED and CFL compatible  
 with supplied load adaptor

Digital push button  
 operation provides user  
 control

Service switch prevents  
 lights from coming on  
 during re-lamping

*Clear Connect™ is a registered trademark of Lutron Electronics Co., Inc.*

Hubbell's WL-Series Wireless Sensors and Controls are the ideal solution for renovation projects aimed at reducing energy consumption. These sensors use DSP Enhanced passive infrared technology to detect movement of heat from people to turn lights on when a room is occupied and off when vacant. The sensors wirelessly transmit Clear Connect™ commands to the associated control devices, reducing the need for additional wiring for ease and speed of installation and energy savings.

- Eliminates need to run extra wires
- Supports highly reconfigured spaces
- Complete projects quickly
- Helps manage energy consumption

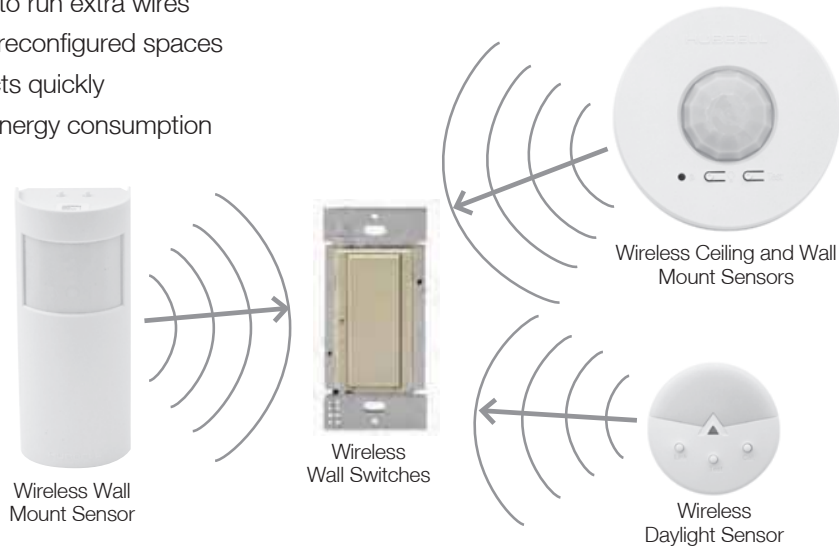

### Wireless Ceiling Mount Sensor

Description	Color	Catalog Number
Ceiling mount 360° / 324-676 ft <sup>2</sup>	White	<b>WLP450C</b>



WLP450C

### Wireless Wall Mount Sensor

- Detection at longer distances is best when motion occurs at right angles to the sensor
- Multiple sensors can be used to extend coverage
- Mount Hallway Sensor at the end of a hallway with a clear view down the length of a hall

Description	Wall mount 180° / 3000 ft <sup>2</sup>	Corner mount 90° / 2500 ft <sup>2</sup>	Hallway up to 150 linear ft
Color	White	White	White
Catalog Number	<b>WLP3000W</b>	<b>WLP2500W</b>	<b>WLP150H</b>



WLP150H

*Compatible Controls: WSL1278xx switch, WLC316R control unit, or any Lutron Clear Connect enabled control device.*

### Wireless Wall Switches

Description	Color	Catalog Number
8A Lighting, 3A Fan (1/10 HP motor, 120V only), Spec Grade Electronic Switch 120–277V. No neutral wire required	Ivory White	<b>WLS1278I</b> <b>WLS1278W</b>
Accessory Switch 120V	Ivory White	<b>WLAS120I</b> <b>WLAS120W</b>
Accessory Switch 277V	Ivory White	<b>WLAS277I</b> <b>WLAS277W</b>



WLS1278I

WLAS277W

*Compatible Transmitters: WLP series and WLDH sensors any Lutron Clear Connect enabled sensor.*

### Wireless Control Unit

Description	Catalog Number
Wireless load control unit with isolated relay, 16A, 120V or 277V AC	<b>WLC316R</b>

*Compatible Transmitters: WLP series and WLDH sensors any Lutron Clear Connect enabled sensor.*



WLC316R

### Wireless Daylight Sensor

Description	Color	Catalog Number
Daylight sensor 0–107,000 Lux (0-10,000 fc)	White	<b>WLDH</b>

*Compatible Controls: WSL1278xx switch, WLC316R control unit, or any Lutron Clear Connect enabled control device.  
 Note: See pages E-22 to E-24 for coverage patterns and technical specifications.*



WLDH

*Clear Connect™ is a registered trademark of Lutron Electronics Co., Inc.*



**DR20LA**

Shown with adhesive label to denote the device is being automatically controlled. Labels provided with each plug load control unit.

ASHRAE 90.1-2010 mandates that 50% of all outlets in private offices, open offices, and computer classrooms must be automatically controlled by occupancy or time based schedules. This also includes outlets in modular furniture. Hubbell provides solutions for compliance that are cost effective and installer friendly. Below are two examples. Additional examples and design resources are located at [www.hubbell-wiring.com/energy.aspx](http://www.hubbell-wiring.com/energy.aspx)

## Wired

Utilizing low voltage wiring provides installers with a familiar method of wiring and installation. Specify CU300HD to control outlets and use AAR or CU300A to control the lighting. Utilize alternating outlet or split receptacle wiring as required to control at least 50% of the outlets in the space.

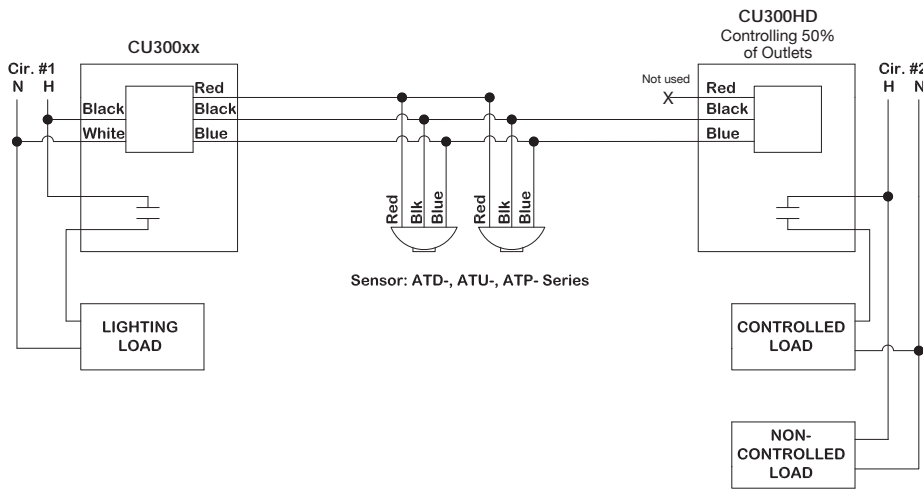

## Wireless

Wireless communication takes complexity out of retrofit and difficult installations by eliminating low voltage wires running between lighting and receptacle control units. This gives installers flexibility to quickly deploy, add additional devices, and configure and re-configure the system as needed. Hubbell's WL series controls utilize Lutron's proven Clear Connect™ communication and are compatible with other Clear Connect™ devices, such as Hubbell's wireless occupancy sensors.

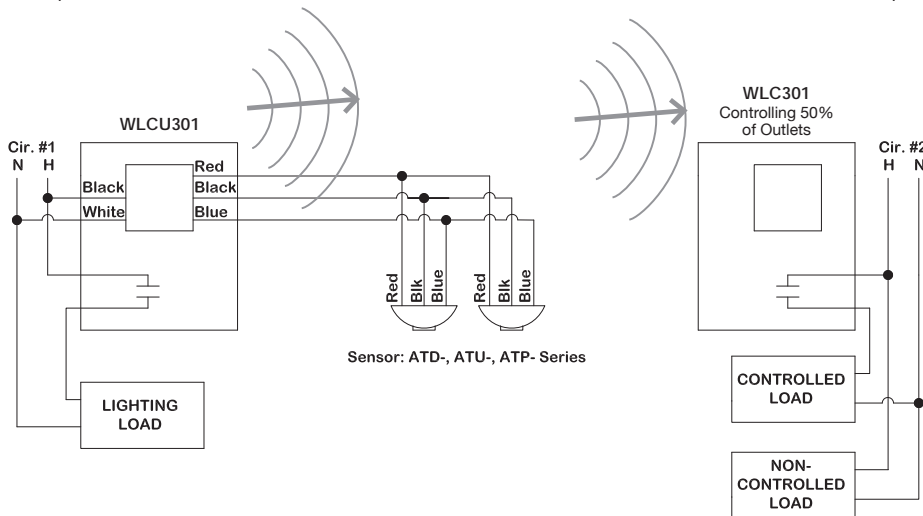

Clear Connect™ is a registered trademark of Lutron Electronics Co., Inc.



### Hubbell Plug Load Control Products

- Wired or wireless flexibility
- UL/cUL 916 listed for energy management equipment
- Listed for 20A enclosed switching
- Heavy duty 60A rated mechanical latching relay; silver alloy contacts
- Zero cross switching
- Expanded operating temperature range
- 24V DC, 250mA DC power output on applicable units
- Low voltage output short circuit protection
- UL2043 plenum rated except WLC402
- Controlled outlet labels provided with control units

## Wired

### Heavy Duty Control Unit

Robust latching relay provides reliable performance over many different applications, including plug loads. 20A 100-277V AC, 1HP @ 120V, 2HP @ 240/277V. Auto or manual-on operation. Power up to six low voltage sensors.

Description	Voltage	Catalog Number
Heavy duty control unit	100-277V AC	<b>CU300HD</b>

Note: See page E-25 for technical specifications.



CU300HD

## Wireless

Operates in a “quiet” 434MHz FCC band. Communication range: 30 ft obstructed or 60 ft line of sight



### Heavy Duty Control Unit with Wireless Transmit

CU300HD with functionality of WLCA integrated to wirelessly activate additional load control units. Takes the place of CU300A's normally used to control just lighting. 20A 100-277V AC, 1HP @ 120V, 2HP @ 240/277V. Auto or manual-on operation. Power up to six low voltage sensors.

Description	Voltage	Catalog Number
Heavy duty control unit with Clear Connect	100-277V AC	<b>WLCU301</b>



WLCU301

### Wireless Status Transmitter

Low voltage powered unit transmits occupancy or timer status to associated load control receivers. Use with CU300xx and low voltage sensors/timers to upgrade existing lighting control systems to support plug load control.

Description	Voltage	Catalog Number
Wireless transmitter with Clear Connect, for use with CU300xx	24V DC	<b>WLCA</b>



WLCA

### Heavy Duty Load Control Units with Wireless Receive

These units receive wireless Clear Connect™ commands to turn on and off power to downstream loads. Utilize these control units to wirelessly switch a circuit of receptacles or any other applicable load. 20A 100-277V AC, 1HP @ 120V, 2HP @ 240/277V.

Description	Voltage	Catalog Number
1 - Circuit heavy duty control unit with Clear Connect	100-277V AC	<b>WLC301</b>
2 - Circuit heavy duty control unit with Clear Connect	100-277V AC	<b>WLC302</b>



WLC301

### Furniture Feed Box with Heavy Duty Relays and Wireless Receive

Furniture feed box receives wireless Clear Connect™ commands and controls 2-circuits in furniture electrical feeds. It supports wall mounting to existing 1 or 2-gang junction boxes. Additionally, the box can be secured to the furniture or on the floor. 20A 100-277V AC, 1HP @ 120V, 2HP @ 240/277V.

Description	Voltage	Catalog Number
2 - Circuit heavy duty furniture feed box with Clear Connect	100-277V AC	<b>WLC402W</b>

Note: See page E-26 for technical specifications.



WLC402W

Clear Connect™ is a registered trademark of Lutron Electronics Co., Inc.

# H-MOSS® Controls

## Specifications and Wiring Schematics

Dual Technology and Ultrasonic Wall Switches

### Adaptive Dual Technology Wall Switches AD2000 Series

Electrical	
Power Supply	120/277V AC, 50/60Hz
Load Capacity	
Incandescent	0 to 800 watts
120V AC Ballast	0 to 1000 watts
277V AC Ballast	0 to 1800 watts
Agency Approvals	cULus Listed
Physical	
Housing	High impact plastic (UL-94-5V)
Lens	Dual element pyrometer and 12 element cylindrical hard lens
Dimensions	Face 2.59"H x 1.73"W, 0.37"D (from wall out)
Mounting Height	42 to 54 inches above floor
Environmental	
Operating	32°F to 104°F (0°C to 40°C); 0% to 95% non-condensing relative humidity
Controls	
Time Delay	Digital, adaptive 4 to 30 minutes
Ambient Light	Adjustable ambient light override, 10 to 500 foot candles
Front Press Switch	Auto/Off
Sensitivity	Adaptive 0% to 100%
Service Switch	Air gap off
Sensing Indicator	
Passive Infrared	Red LED
Ultrasonic	Green LED

### Adaptive Technology Ultrasonic and PIR Wall Switches AP2000 and AU2000 Series

Electrical	
Power Supply	120/277V AC, 50/60Hz
Load Capacity	
Incandescent	0 to 800 watts
120V AC Ballast	0 to 1000 watts
277V AC Ballast	0 to 1800 watts
Agency Approvals	cULus Listed
Physical	
Housing	High impact plastic (UL-94-5V)
Lens	Dual element pyrometer and 12 element cylindrical hard lens (AP2000 only)
Dimensions	Face 2.59"H x 1.73"W, 0.37"D (from wall out)
Mounting Height	42 to 54 inches above floor
Environmental	
Operating	32° F to 104°F (0°C to 40°C); 0% to 95% non-condensing relative humidity
Controls	
Time Delay	Digital, adaptive 4 to 30 minutes 20 minutes default
Ambient Light	Adjustable ambient light override, 10 to 500 foot candles
Front Press Switch	Auto/Off
Sensitivity	Adaptive 0% to 100%
Service Switch	Air gap off
Sensing Indicator	
Passive Infrared	Red LED (AP series only)
Ultrasonic	Green LED (AU series only)

### Wiring Schematic AD, AU, AP, 1277/2000 Series Wall Switch Sensors

Single Circuit Wiring

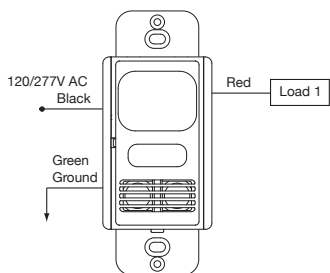

Dual Circuit Sensor, Wired for Dual Circuits

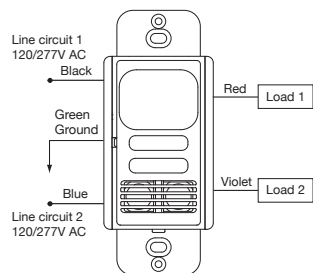

Dual Circuit Sensor, Wired for Single Circuit

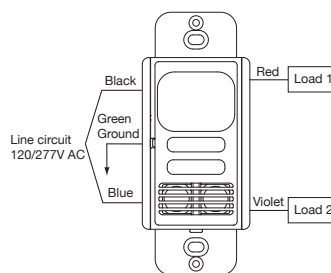

For step dimming, bi-level, and dual ballasted fixtures

Single Circuit Sensors, Wired as 3-Way Sensors\*

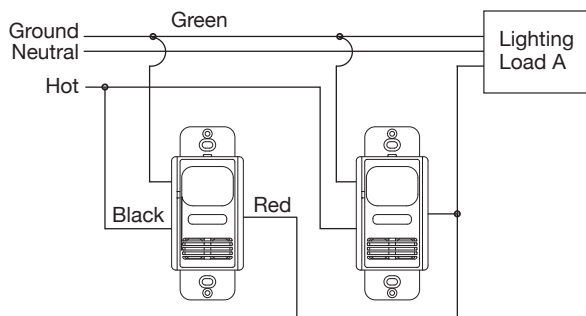

Dual Circuit Sensors, Wired as 3-Way Sensors\*

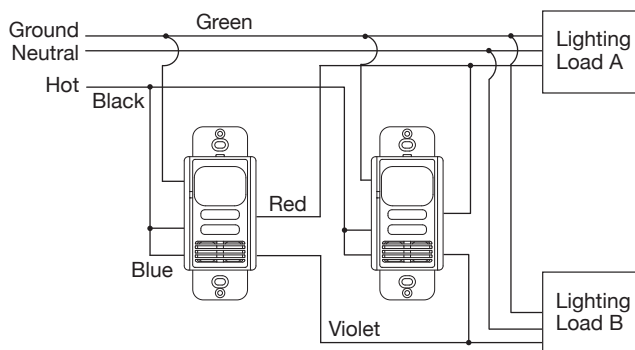

Note: \*Load can not exceed the rating of one switch.  
Sensor is shipped with all dip switches in the OFF position (factory default).

# H-MOSS® Controls Coverage Patterns

## Wall Switches Coverage Patterns

Minor Motion: ■ Ultrasonic ■ PIR    Major Motion: ■ Ultrasonic ■ PIR

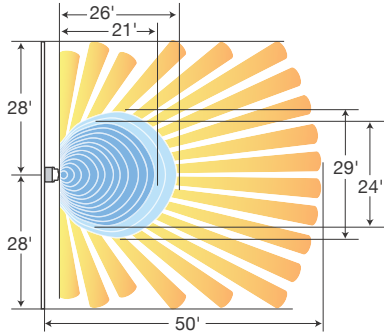

AD2000 Series

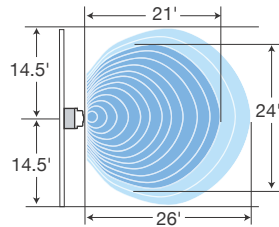

AU2000 Series

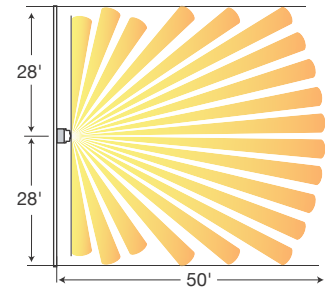

AP2000 Series

## Wall Switches Coverage Patterns

Minor Motion: ■ PIR    Major Motion: ■ PIR

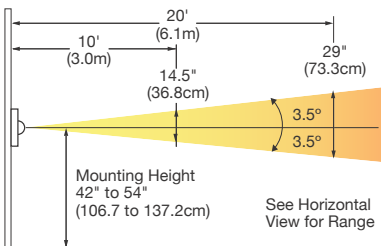

Vertical Coverage  
AT1277 Series

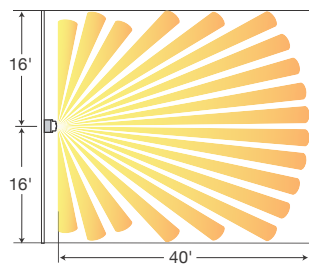

AT1277 Series

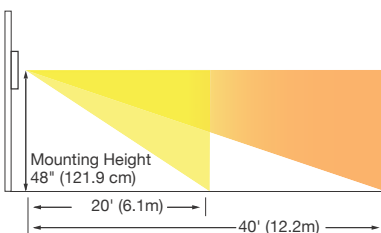

Vertical Coverage  
ATP2000, WS2000 Series

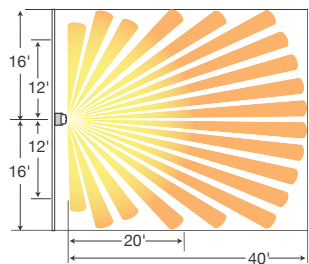

ATP2000, WS2000 Series

# H-MOSS® Controls

## Specifications and Wiring Schematics

Passive Infrared Wall Switches

### Adaptive Technology PIR Wall Switches AT1277 Series

Electrical	AT1277 Series
Power Supply	120/277V AC, 50/60Hz
Load Capacity	0 to 1800 watts
120V AC	0 to 4155 watts
277V AC	
Agency Approvals	UL Listed, cULus Certified
Physical	
Housing	Flame retardant UL 94 V-0 ABS
Lens	Polyethylene
Dimensions	Face 2.61"H x 1.29"W, 0.73"D (from wall out)
Mounting Height	42 to 54 inches above floor
Environmental	
Operating	32°F to 122°F (0°C to 50°C) with rate of change not exceeding 20°F (11°C) per hour; 20% to 90% non-condensing relative humidity
Storage	-20°F to 150°F (-29°C to 65°C); 20% to 90% non condensing relative humidity
Controls	
Time Delay	Digital, test (15 seconds), Adaptive 5 to 30 minutes
Ambient Light	Digital, pushbutton, 30 to 300 foot candles
Front Press Switch	Auto/Momentary Off (30 minutes after last motion, switch returns to automatic mode)
Service Switch	Auto/Off
Sensing Indicators	
Passive Infrared	2-color LED (red, green)

### Adaptive Technology PIR Wall Switches ATP2000, WS2000 and WS1000 Series

Electrical	ATP/WS2000 Series	WS1000 Series
Power Supply	120/277V AC, 60Hz	120V AC, 60Hz
Load Capacity		
Incandescent	0 to 1000 watts	0 to 500 watts
120V Ballast	0 to 1000 watts	0 to 500 watts
277V Ballast	0 to 1800 watts	N/A
Agency Approvals	cULus Listed	cULus Listed
Warranty	5 years	5 years
Physical	ATP/WS2000 and WS1000 Series	
Housing	Flame retardant UL 94 V-0 ABS	
Lens	Polyethylene	
Dimensions	Face 2.59"H x 1.30"W, 0.61"D (from wall out)	
Mounting Height	42 to 54 inches above floor	
Environmental	ATP/WS2000 and WS1000 Series	
Operating	32°F to 122°F (0°C to 50°C) with rate of change not exceeding 20°F (11°C) per hour; 20% to 90% non-condensing relative humidity	
Storage	-40°F to 150°F (-40°C to 65°C); 20% to 90% non condensing relative humidity	
Controls	ATP/WS2000 Series	WS1000 Series
Time Delay	ATP: Auto WS: Manual 20 seconds to 30 minutes	Manual 20 seconds to 30 minutes
Ambient Light	Digital, pushbutton, 10 to 500 foot candles	n/a
Front Press Switch	On/Off	On/Off
Service Switch	Off (service) Vac (manual-on) Occ (auto-on)	Off (service) On (normal operation)
Sensing Indicator	ATP/WS2000 and WS1000 Series	
Passive Infrared	Red LED	

### Wiring Schematic ATP2000 and WS2000 Series Wall Switches

#### Normal Wiring

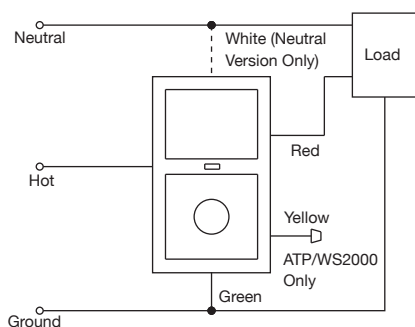

#### Sensors Wired as 3-Way Sensors\* (ATP/WS2000 Only)

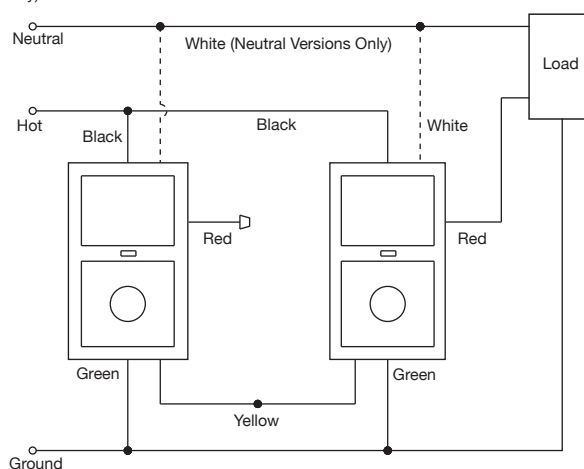

Note: \*Load can not exceed the rating of one switch.

## Ceiling Sensors Coverage Patterns

Minor Motion: ■ Ultrasonic ■ PIR Major Motion: ■ Ultrasonic ■ PIR

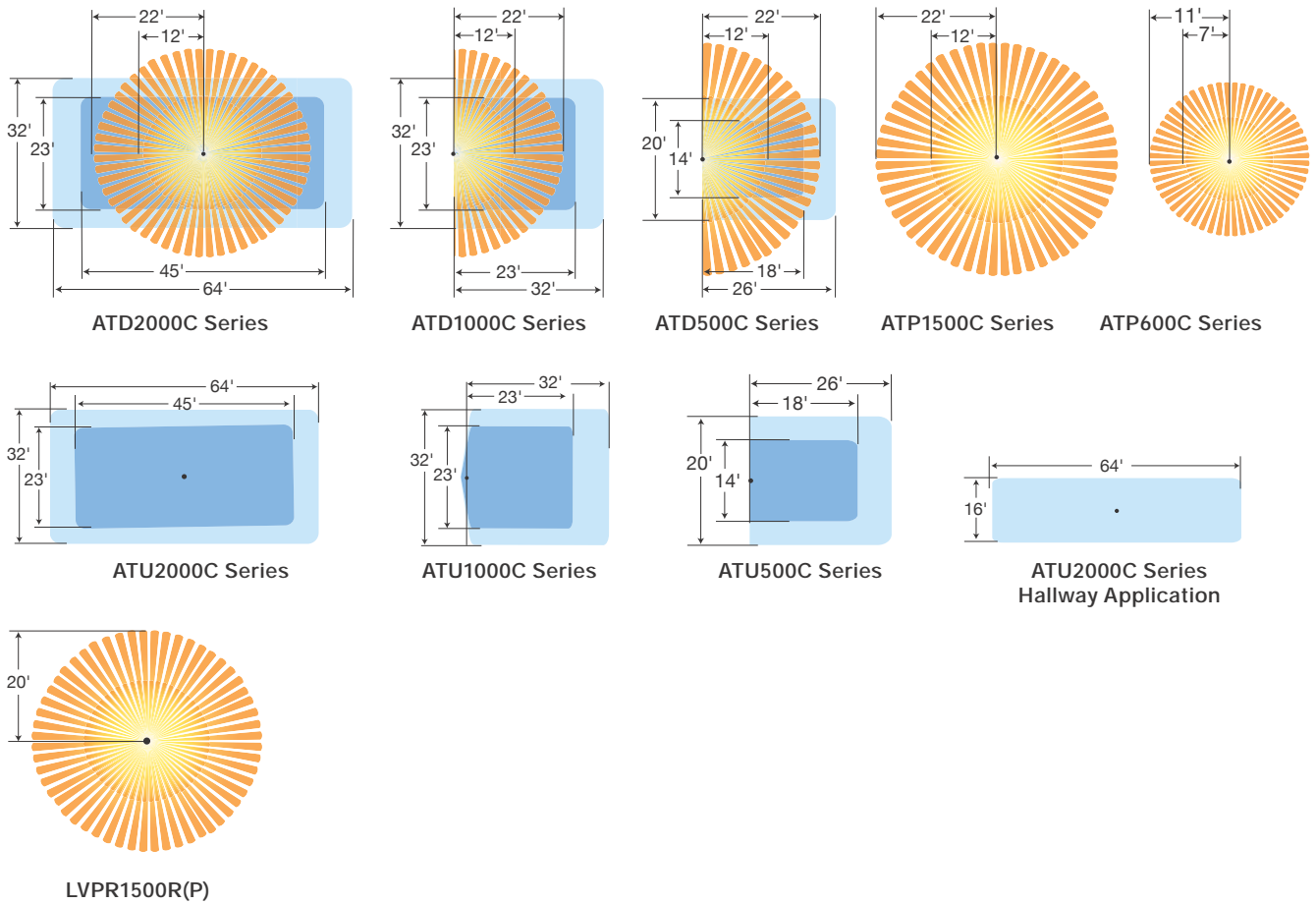

## Wall Mount Sensors Coverage Patterns

Minor Motion: ■ Ultrasonic ■ PIR Major Motion: ■ Ultrasonic ■ PIR

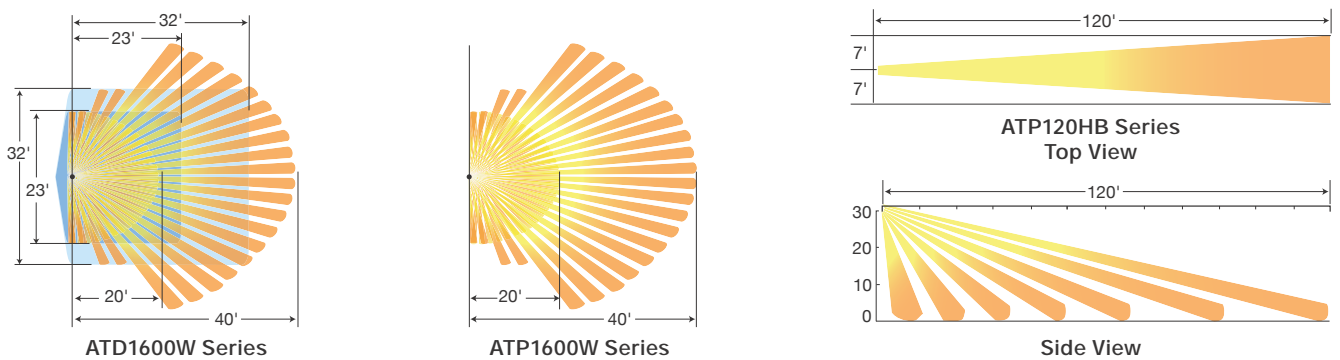

# H-MOSS® Controls

## Specifications

Ceiling and Wall Mount Sensors

### Adaptive Dual Technology, Ultrasonic and Passive Infrared Ceiling and Wall Mount Sensors ATD, ATU, and ATP Series

Electrical	
Power Requirements	24V DC nominal, 33mA from Hubbell CU series control unit
Isolated Relay (sensors with RP suffix)	Normally open and normally closed Terminals available
Agency Approvals	UL Listed
Physical	
Ceiling Sensors	
Housing	Flame retardant UL 94 V-0 ABS
Lens	Polyethylene
Dimensions	1.5"H x 4.5"D
Color	Office white
Mounting Height	8 to 12 feet
Wall Mount Sensors	
Housing	Flame retardant UL 94 V-0 ABS
Lens	Polyethylene
Dimensions	6"H x 2"W x 1.5"D
Color	Office white
Mounting Height	8 to 12 feet, 8 to 30 feet (ATP120HB series)
Environmental	
Operating	32°F to 104°F (0°C to 40°C) with rate of change not exceeding 20°F (11°C) per hour; 0% to 95% non condensing relative humidity
Storage	-20°F to 150°F (-29°C to 65°C); 0% to 95% non-condensing relative humidity
Controls	
Time Delay	Test (8 seconds), adaptive 8 to 40 minutes
Ambient Light Sensitivity	1 to 1000 foot candles Adaptive 0 to 100%
Sensing Indicators	
Ultrasonic (ATD and ATU Series)	Green LED
Passive Infrared (ATD and ATP Series)	Red LED

### OPTIMYZER® High Bay HMHB Series

User Interface	2 four-pin dip switches (standard version) 3 four-pin dip switches (photosensor version)
Timer time-outs	Primary: 8-second test mode – 4, 8, 16 and 30 minute time-outs Secondary: Can be disabled – 30, 60 and 90 minute time-outs
Passive infrared	Dual element pyrometer and spherical Fresnel lens
Photosensor Range (Photosensor version only)	50 to 3000 foot candles, set point adjustable
Coverage	360° (includes masking kit for aisle and end-of-aisle applications). Lens: Below 30 ft: 1.4 – 42 ft radius; mounted @ 30 ft; up to 45 ft: 1.1 - 49.5 ft radius; mounted @ 45 ft
Load ratings (line voltage units)	120V AC: 0 to 800 watts watts      480V AC: 0 to 2400 watts ballast 277V AC: 0 to 1200 watts ballast    ¼-HP motor load @ 120V AC, 347V AC: 0 to 1500 watts ballast    1/6 HP @ 347V 208/240V AC: 0 to 1200 watts ballast
Operating environment (Indoor use only)	Operating temperature: (standard version) 32°F to 149°F (0°C to 65°C); Relative humidity (non-condensing): 0% to 95%
Construction	Casing: High-impact injection-molded thermoplastic
Size and weight	Size: 4.4 inch x 3.6 inch x 2.0 inch; Weight: 7 oz.
Color	White
Mounting	Mounts directly to the end of a fixture through an extended ½ inch chase nipple. For deeper body fixtures, an optional Extender Adapter (available separately) positions the sensor flush or below the bottom of the reflector for a full field of view
Certifications	cULus Listed

### Coverage Pattern

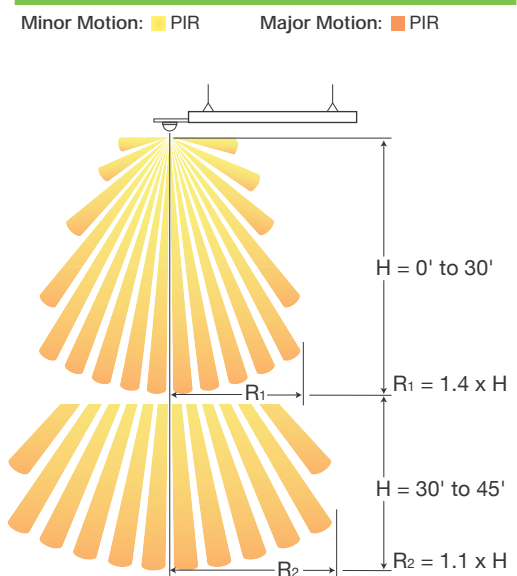

# H-MOSS® Controls Specifications

Ceiling and Wall Mount Sensors

## HMHBxxUPCW Series

User Interface	2 four-pin dip switches (standard version) 3 four-pin dip switches (photosensor version)
Timer time-outs	Primary: 8-second test mode 4, 8, 16 and 30 minute time-outs Secondary: Can be disabled 30, 60 and 90 minute time-outs
Passive infrared	Dual element pyrometer and spherical Fresnel lens
Photosensor Range (Photosensor version only)	50 to 3000 foot candles, set point adjustable
Coverage	360° (includes masking kit for aisle and end-of-aisle applications) Lens: Below 30 ft: 1.4 – 42 ft radius; mounted @ 30 ft.; Up to 45 ft.: 1.1 - 49.5 ft. radius; mounted @ 45 ft.
Load ratings (line voltage units)	120V AC: 0 to 800 watts ballast or tungsten 277V AC: 0 to 1200 watts ballast 347V AC: 0 to 1500 watts ballast 208/240V AC: 0 to 1200 watts ballast 480V AC: 0 to 2400 watts ballast ¼-HP motor load @ 120V AC, 1/6 HP @ 347V
Operating environment (Indoor use only)	Operating temperature: (standard version) 32°F to 149°F (0°C to 65°C); (low temperature version): -40°F to 149°F (-40°C to 65°C) Relative humidity (non-condensing): 0% to 95%
Construction	Casing: High-impact injection-molded thermoplastic
Size and weight	Size: 4.4 inch x 3.6 inch x 2.0 inch; Weight: 7 oz.
Color	White
Mounting	Mounts directly to the end of a fixture through an extended ½ inch chase nipple. For deeper body fixtures, an optional Extender Adapter (available separately) positions the sensor flush or below the bottom of the reflector for a full field of view
Certifications	ETL, Conforms to UL STD 916, Certified to CAN/USA STD 22.2 No. 61010-1-04 and Title 24 Certified
Warranty	5 year limited

## Coverage Pattern

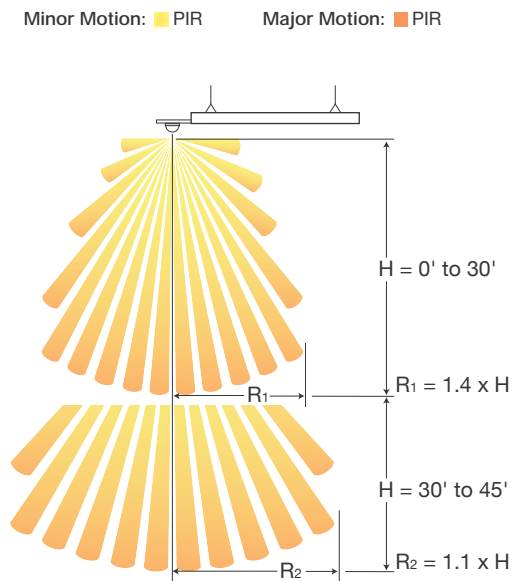

## Harsh Environment Passive Infrared Ceiling and Wall Mount Sensors AHP Series

<b>Electrical</b>	
Power Requirements	24V DC nominal, 33mA from Hubbell CU series control unit
Isolated Relay (sensors with RP suffix)	Normally open and normally closed Terminals available
Agency Approvals	cULus Listed
<b>Physical</b>	
<b>Ceiling Sensor</b>	
Housing	Flame retardant UL 94 V-0 ABS
Protection	NEMA 4X, when used with ACIPE
Lens	Polyethylene
Dimensions	1.5"H x 4.5"D
Color	Office white
Mounting Height	8 to 12 feet
<b>Physical</b>	
<b>Wall Mount Sensor</b>	
Housing	Flame retardant UL 94 V-0 Valox®
Protection	NEMA 4X, IP66, outdoor use rated
Lens	Polyethylene
Dimensions	6"H x 2"W x 1.5"D
Color	Gray
Mounting Height	8 to 12 feet
<b>Environmental</b>	
Operating	-40°F to 149°F (-40°C to 65°C) with rate of change not exceeding 20°F (11°C) per hour; 0% to 95% non condensing relative humidity
<b>Controls</b>	
Time Delay	Test (8 seconds), adaptive 8 to 40 minutes
Ambient Light	1 to 1000 foot candles
Sensitivity	Adaptive 0 to 100%
<b>Sensing Indicators</b>	
Passive Infrared	Red LED

## Coverage Pattern

Minor Motion: ■ PIR      Major Motion: ■ PIR

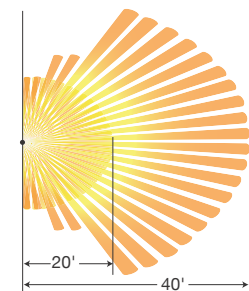

AHP1600WRP

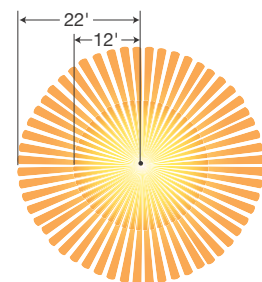

AHP1500CRP

Valox® is a trademark of SABIC Innovative Plastics, acquired from General Electric Company.

**Wireless Ceiling Mount Sensor Coverage Patterns**

Top View

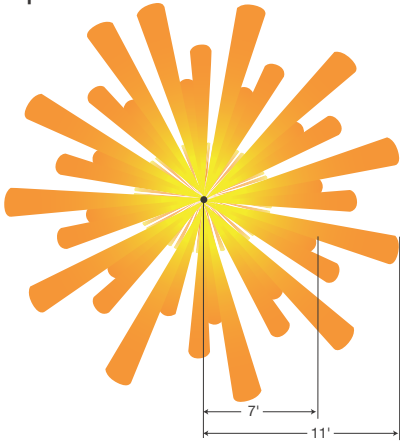

Side View

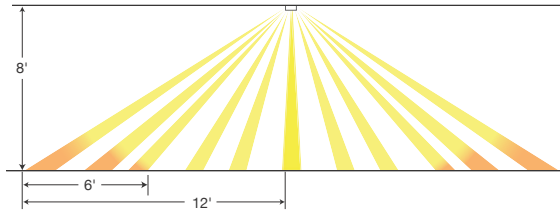

WLP450C

**Sensor Coverage Chart (for sensor mounted in center of room)**

Ceiling height	Maximum room dimensions for complete floor coverage*	
8 ft (2.4 m)	18 ft x 18 ft (5.5 m x 5.5 m)	324 ft <sup>2</sup> (30.2 m <sup>2</sup> )
9 ft (2.7 m)	20 ft x 20 ft (6.1 m x 6.1 m)	400 ft <sup>2</sup> (37.2 m <sup>2</sup> )
10 ft (3.0 m)	22 ft x 22 ft (6.7 m x 6.7 m)	484 ft <sup>2</sup> (44.9 m <sup>2</sup> )
12 ft (3.7 m)	26 ft x 26 ft (7.9 m x 7.9 m)	676 ft <sup>2</sup> (62.4 m <sup>2</sup> )

Note: \* 12 ft (3.7 m) is the recommended maximum mounting height

**Wireless Wall Mount Sensor Coverage Patterns**

Top View

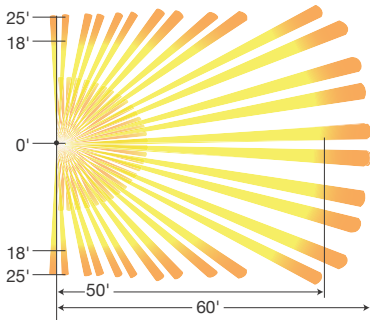

Side View

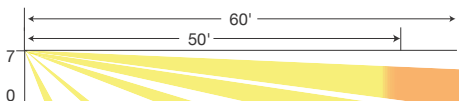

WLP3000W

**Corner Mount Coverage Patterns**

Top View

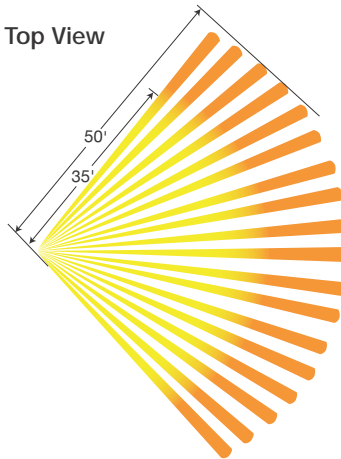

Side View

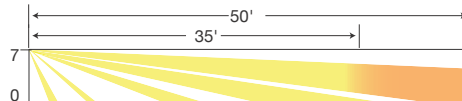

WLP2500W

Note: \*Sensor mounting shown at 7 ft (2.1 m). Mounting height should be between 6 and 8 ft (1.6 and 2.4 m).



Clear Connect™ is a registered trademark of Lutron Electronics Co., Inc.



**Wireless Hallway Sensor Coverage Patterns**

**Top View**



**Side View**



**WPL150H**

**Sensor Coverage Chart (Hallway)**

Width of Hall	Length of Hall
6 ft (1.0 m) or less	50 ft (15.2 m)
8 ft (2.4 m)	100 ft (30.5 m)
10 ft (3.0 m) or more	150 ft (45.7 m)

*Note: \*Sensor mounting shown at 7 ft (2.1 m). Mounting height should be between 6 and 8 ft (1.6 and 2.4 m).*

**Specifications**

Electrical	Operating voltage: 3V Operating current: 14 µA nominal 10-year battery life design Supplied with one CR 123 lithium battery Non-volatile memory (saved changes are stored during power loss)
Construction	High impact, UL 94-5V plastic
Operating Environment	Indoor use only Operating temperature: 32°F to 104°F (0°C to 40°C)
Range	RF range is 30 ft (10m) obstructed, 60 ft (18m) line of sight
Sensor Coverage Test	Dedicated test button Lens illuminates orange in response to motion during test mode
Wireless Communication Test	Dedicated test button; Turn associated loads on and off
Time Out Options	1 minute (intended for use in high-activity, briefly occupied areas only); 5 minutes; 15 minutes (default setting); 30 minutes
Auto-On Options	“Enabled” – Sensor turns lights ON and OFF automatically – default setting “Disabled” – Lights must be turned ON manually from a switching device Sensor turns lights OFF automatically
Sensitivity Options	Low Activity (default setting); Medium Activity; High Activity
Certifications	cULus Listed, FCC Certified, IC Certified Meets CA (USA) Energy Commission Title 24 requirements
Warranty	1 year



*Clear Connect™ is a registered trademark of Lutron Electronics Co., Inc.*

# H-MOSS® Controls Specifications and Wiring Schematics

WL-Series Wireless Load Controls

## Wireless Control Unit (WLC316R)

Electrical	Operating voltage: 120/277V, 50/60Hz LED status indicator: displays load status and provides programming feedback Power failure memory: (Relay returns to previous level prior to interruption) Output is non-latching
Operating Environment	Indoor use only Ambient operating temperature: 32°F to 131°F (0°C to 55°C); Relative humidity: 0% to 90% humidity, non-condensing
Load	Maximum load: 16A general purpose. No minimum Motor rating: 0.5 HP (120V AC), 1.5 HP (277V AC)
Isolated Relay	Normally open (NO) and normally closed (NC) dry contacts Maintained latching output The isolated relay is not rated to control unclamped, inductive loads. Inductive loads include, but are not limited to relays, solenoids and motors. To control these types of equipment
Range	RF range is 30 ft (10m) obstructed, 60 ft (18m) line of sight
Certifications	UL Listed, UL 2043 Plenum Rated, FCC Approved. Complies with the limits for a Class B device, pursuant to Part 15 of the FCC rules. CSA and IC
Warranty	1 year

## Range Diagram

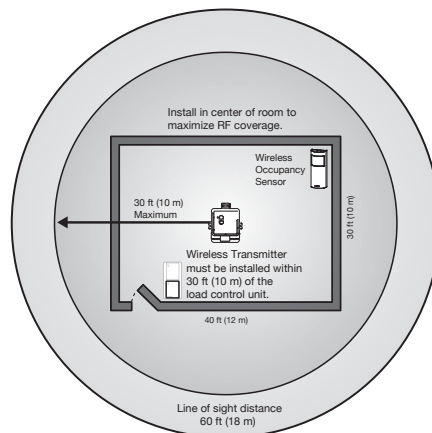

Contact Hubbell first for applications using foil-backed or metallic ceiling tiles.

## Wireless Wall Switch (WLS1278 Series)

Electrical	Operating voltage: 120/277V, 50/60Hz Green indicator light
Operating Environment	Indoor use only Ambient operating temperature: 32°F to 104°F (0°C to 40°C), Relative humidity: 0% to 90% humidity, non-condensing
Wire Size	#20 to 16 AWG (0.5 to 1.5mm <sup>2</sup> ) solid or stranded wire
Capacity	Up to 9 WLAS accessory switches can be configured to work together with one WLS1278
Range	RF range is 30 ft (10m) obstructed, 60 ft (18m) line of sight
Certifications	UL Listed, CSA Certified, FCC Approved Complies with the limits for a Class B digital device, pursuant to Part 15 of the FCC rules
Warranty	1 year

## Wiring Diagram - Wireless Wall Switch (WLS1278 Series)

### Single Location Installation

WLS1278xx\*

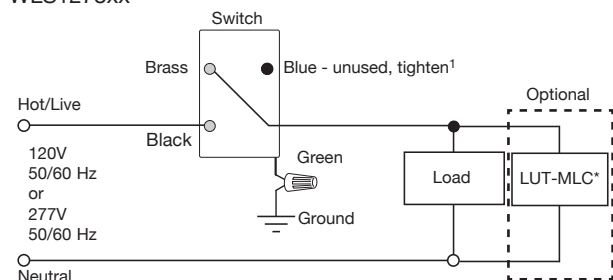

Note: \*The included LUT-MLC ensures proper function when fluorescent, CFL, or LED loads are used. Install the LUT-MLC inside a load fixture or in a separate J-box of the circuit.

- 1 When using controls in single location installations, tighten the blue terminal without any wires attached. DO NOT connect the blue terminal to any other wiring or to ground.
- 2 Up to 9 Accessory Switches may be connected to the Wireless Switch. Total blue terminal wire length may be up to 250 ft (76m).
- 3 Requires WLAS120 for 120V applications, and WLAS277 for 277V applications.

### Multi-Location Installation<sup>2</sup> with WLAS1278xx or WLAS277xx<sup>3</sup>

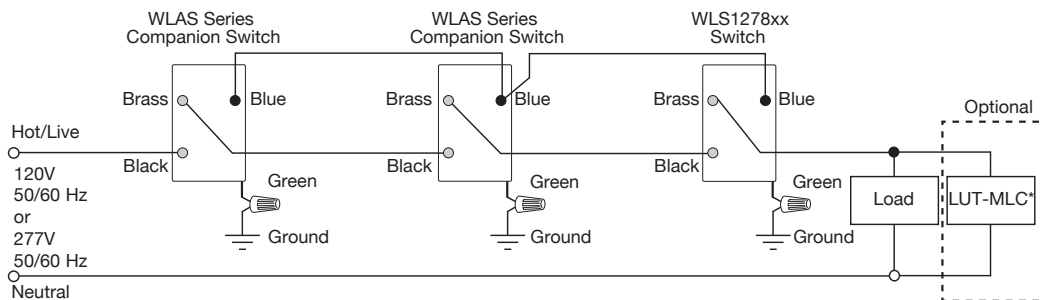

Clear Connect™ is a registered trademark of Lutron Electronics Co., Inc.

# H-MOSS® Controls

## Specifications

Control Units and Add-A-Relay

### Control Units - CU300/347A Series

Electrical	CU300A(M)	CU347A	CU300HD
Power Supply	120-277V AC, 50/60Hz	347V AC, 60Hz	100-277V AC, 50/60 Hz
Power Output	24V DC, 150mA	24V DC, 100mA	24V DC 250mA
Load Capacity			
Incandescent	0 to 1800 watts	NA	100-277V, 20A Enclosed Switching
120V Ballast	0 to 2400 watts	NA	Motor Loads:
230V Ballast	NA	NA	1HP @ 120V
277V Ballast	0 to 5540 watts	NA	2HP @ 240/277V
347V Ballast	NA	0 to 5205 watts	
AT Sensor/AAR Capacity	1 to 4 combined	1 to 3 combined	1 to 6 combined
Agency Approvals	UL Listed, cULus Certified	UL Listed, cULus Certified	UL Listed, cULus
<b>Physical</b>			
Housing	Flame retardant UL 94-5VA thermoplastic		Flame retardant UL 94-5VA thermoplastic
Dimensions	3.69"L x 2.33"W x 1.36"H		4.00"L x 3.4"W x 1.73"H
Color	Black		Black
<b>Environmental</b>			
Operating	32°F to 104°F (0°C to 40°C); 0% to 90% non condensing relative humidity		See CU300HD data sheet for ratings
Storage	-20°F to 150°F (-29°C to 65°C); 0% to 90% non condensing relative humidity		

### Add-A-Relay - AAR

Electrical	
Power Input	24V DC nominal, 33mA from Hubbell CU series control unit
Load Capacity	
Incandescent	0 to 1800 watts
120V Ballast	0 to 2400 watts
230V Ballast	0 to 3680 watts
277V Ballast	0 to 5540 watts
347V Ballast	0 to 5205 watts
Agency Approvals	UL Listed
<b>Physical</b>	
Housing	Flame retardant UL 94-5V thermoplastic
Dimensions	3.69"L x 2.33"W x 1.36"H
Color	Black
<b>Environmental</b>	
Operating	32°F to 104°F (0°C to 40°C); 0% to 90% non condensing relative humidity
Storage	-20°F to 150°F (-29°C to 65°C); 0% to 90% non condensing relative humidity

### Wired Lighting and Plug Load Control

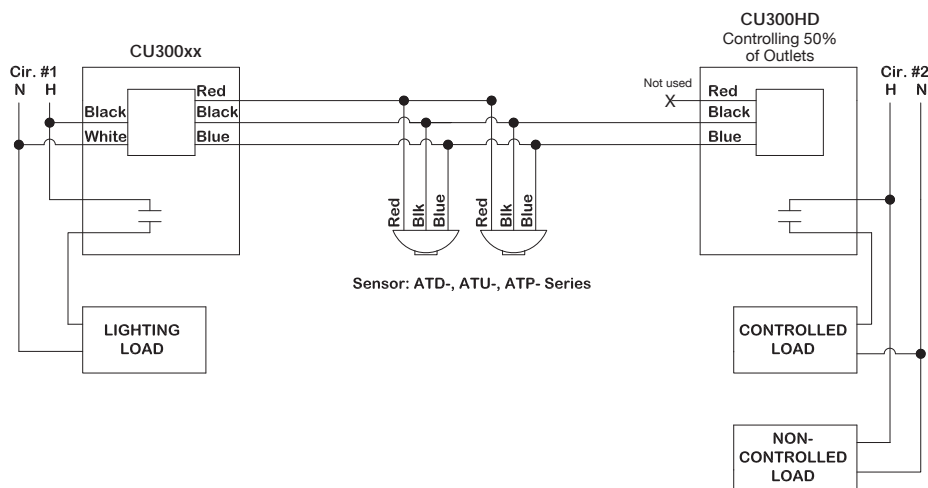

# H-MOSS® Controls

## Specifications and Wiring Schematics

Passive Infrared Wall Switches

### WLC Load Control with Wireless Clear Connect Communication

Electrical	WLCA	WLCU301	WLC301	WLC302	WLC402W
Power Supply	24V DC	100-277V AC, 50/60Hz	100-277V AC, 50/60Hz	100-277V AC, 50/60Hz	100-277V AC, 50/60Hz
Power Output	N/A	24V DC 250mA	N/A	N/A	N/A
Circuits Controlled	N/A	1	1	2	2
Load Capacity		100-277V, 20A 1HP @ 120V AC 2HP @ 240/277V	100-277V, 20A 1HP @ 120V AC 2HP @ 240/277V	100-277V, 20A 1HP @ 120V AC 2HP @ 240/277V	100-277V, 20A 1HP @ 120V AC 2HP @ 240/277V
Agency Approvals	UL Listed, cULus, FCC, IC				
Device Type (Transmit or Receive)	TX	TX	RX	RX	RX
Range (Standard/Obstructed)	30 ft (10m)	30 ft (10m)	30 ft (10m)	30 ft (10m)	30 ft (10m)
Range (Unobstructed, line of site)	60 ft (30m)	60 ft (30m)	60 ft (30m)	60 ft (30m)	60 ft (30m)
<b>Physical</b>					
Housing	Flame retardant UL 94-5VA thermoplastic				
Dimensions	4.00"L x 3.4"W x 1.73"H				4.68"L x 4.94"W x 2.78"H
Color	Black	Black	Black	Black	White

### Wireless Lighting and Plug Load Control

Easily upgrade existing occupancy based lighting control systems to support automated plug load controls.

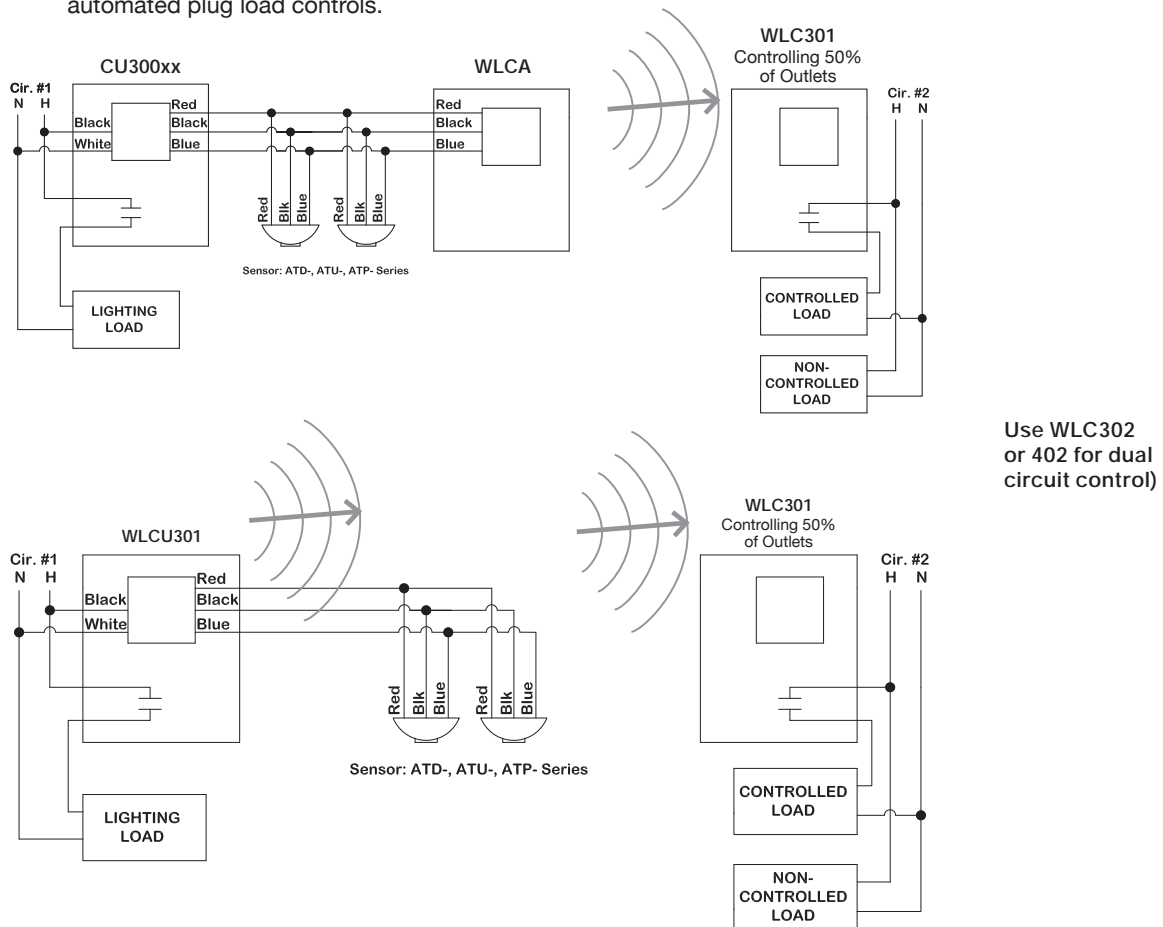

Clear Connect™ is a registered trademark of Lutron Electronics Co., Inc.

**Adaptive Dual Technology, Ultrasonic, and Passive Infrared Ceiling and Wall Mount Sensors**  
**ATD, ATU and ATP Series**

**Single Circuit Application:**

1 to 4 sensors wired to control unit with optional override off switch.

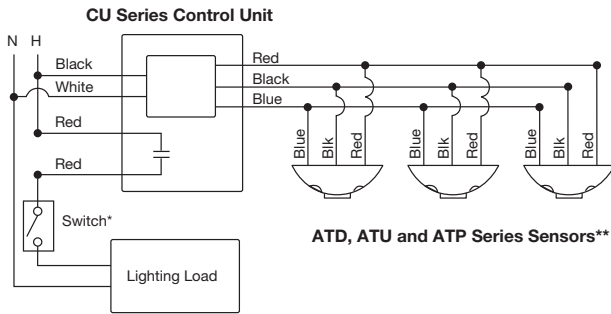

\*Optional Override Off Switch

**Two Circuit Application:**

1 to 4 sensors wired to control unit and Add-A-Relay (control unit switches circuit 1, Add-A-Relay switches circuit 2).

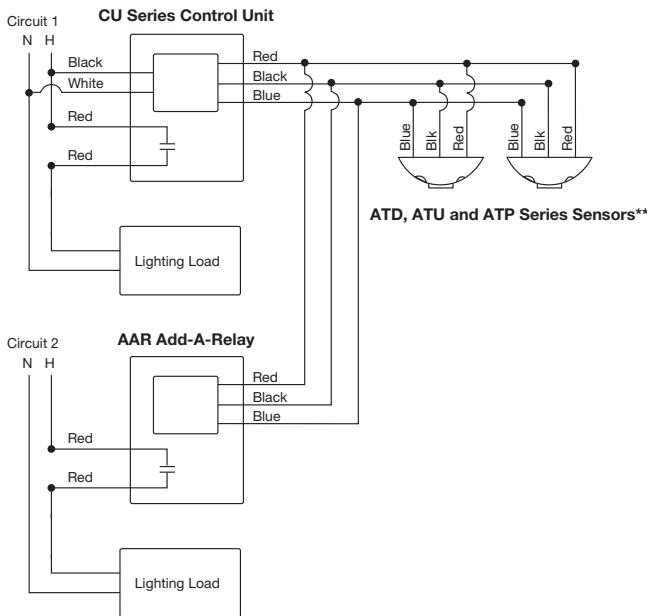

Note: \*\*For wiring sensors with isolated relay and photocell option (models with "RP" suffix): Photocell Option: Cap off Blue sensor wire. Connect Gray sensor wire to Blue control unit wire. Isolated Relay Option: Common-Blue/White wire, Normally Closed-Black/White wire, Normally Open-Yellow/White wire.

**Single Circuit Application:**

Two control units wired in parallel to operate 5 to 8 sensors in a single zone. Maximum 4 sensors per control unit any sensor will activate lighting.

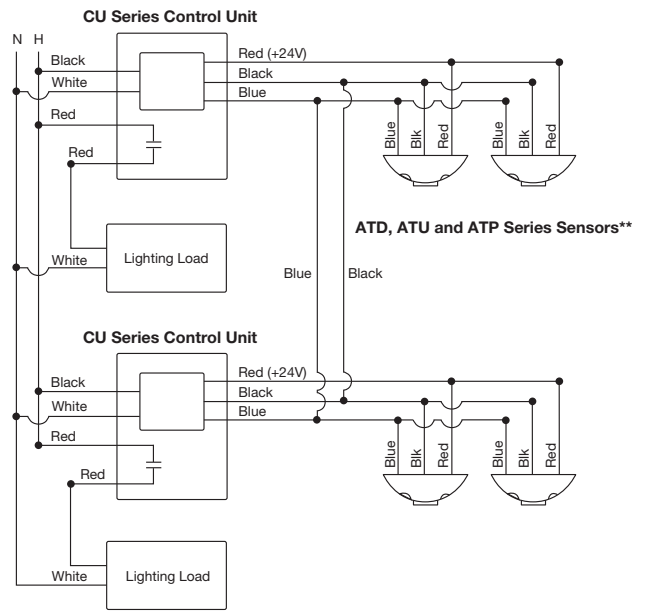

**Two Circuit Application:**

Two control units wired in two circuits to operate 2 to 8 sensors in a single zone. Maximum 4 sensors per control unit any sensor will activate both lighting loads.

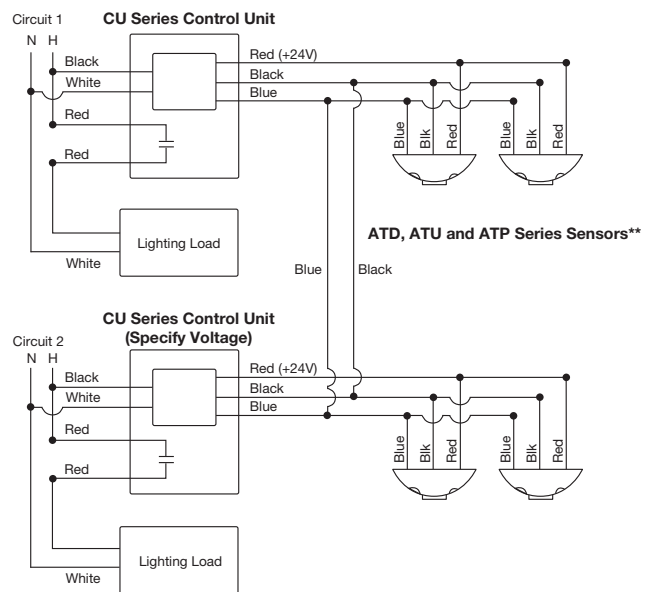

**Adaptive Technology Dual, Ultrasonic, and Passive Infrared Ceiling and Wall Mount Sensors**  
**ATD, ATU and ATP Series**

**Single Circuit, Dual Level Switching Application:**  
 1 to 4 sensors wired to control unit with optional override off switches.

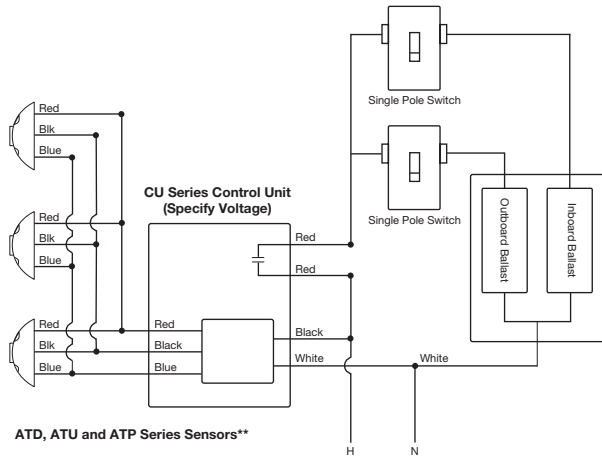

ATD, ATU and ATP Series Sensors\*\*

**Single Circuit, 3-Way Switching Application:**  
 1 to 4 sensors wired to control unit with optional override off switches.

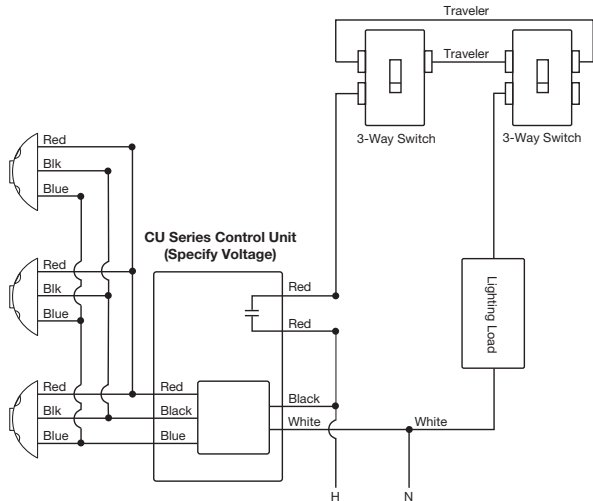

ATD, ATU and ATP Series Sensors\*\*

**Multi-Circuit Application:**  
 1 to 4 sensors wired to control unit that is wired to a multi-pole lighting contactor.

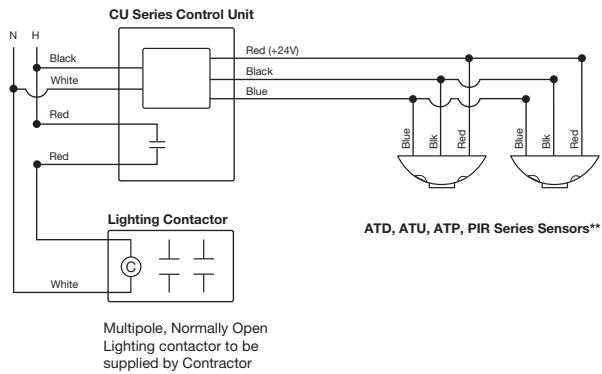

ATD, ATU, ATP, PIR Series Sensors\*\*

**Single Circuit, 4-Way Switching Application:**  
 1 to 4 sensors wired to control unit with optional override off switches.

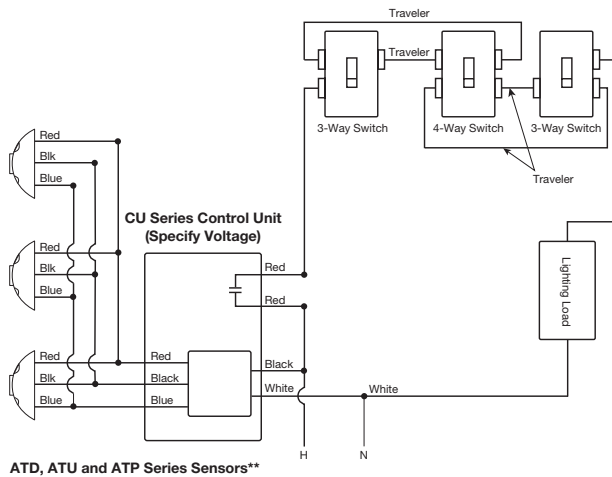

ATD, ATU and ATP Series Sensors\*\*

Note: \*\*For wiring sensors with isolated relay and photocell option (models with "RP" suffix): Photocell Option: Cap off Blue sensor wire. Connect Gray sensor wire to Blue control unit wire. Isolated Relay Option: Common-Blue/White wire, Normally Closed-Black/White wire, Normally Open-Yellow/White wire.

# Section F Switched Disconnects and Enclosures

## Index

Product	Page
Summary .....	F-2
Ratings Quick Reference Guide .....	F-3
<b>Circuit-Lock® Unfused Disconnect Switches</b>	
30, 60 and 100 Amp Units .....	F-5
Accessories and Replacement Parts .....	F-6
Dimensions and Specifications .....	F-7
<b>MotorQuick® Disconnect Switches</b>	
Cost of Ownership Analysis .....	F-8
Quick Disconnect Switches and Accessories .....	F-9
Dimensions and Specifications .....	F-10
<b>Circuit-Lock® Fused Disconnect Switches</b>	
30 and 60 Amp Units .....	F-12
Horsepower Ratings and Specifications .....	F-13
<b>Hazardous Locations</b>	
Unfused Disconnect Switches .....	F-15
<b>AC Manual Toggle Controllers/Disconnects</b>	
600V AC Manual Motor Controllers/Disconnects .....	F-17
<b>NEMA 1 Disconnect Switches</b> .....	F-18
<b>NEMA 3/3R and 3R Disconnect Switches</b> .....	F-19
<b>30 Ampere, 600 Volts AC Manual Motor Controllers</b> .....	F-20
<b>40, 50, 60 and 85 Ampere, 600 Volts AC Manual Motor Controllers</b> ...	F-21
<b>NEMA 4X Disconnect Switches</b> .....	F-22
<b>Pendant Pushbutton Stations</b>	
CPB2 and PBS Series .....	F-23
Accessories and Replacement Parts .....	F-24

Circuit-Lock® Unfused Disconnect Switches



Fused Disconnects, MotorQuick® and VFDs



Hazardous Locations



NEMA 1, 3/3R and 4X Disconnect Switches



# Hubbell's Circuit-Lock<sup>®</sup> Manual Motor Controllers

*"Suitable as Motor Disconnects"*

Hubbell manufactures one of the most complete lines of motor disconnects on the market. Designed to ensure maximum reliability and performance, Hubbell Circuit-Lock<sup>®</sup> motor controllers meet or exceed all industry requirements. Because our Circuit-Lock<sup>®</sup> motor controllers are also disconnects, they ensure safety, compliance, flexibility and productivity for today's industrial and commercial environments. Whether controlling motor loads, safely terminating power or isolating equipment, Hubbell has the solution for you—no matter what the environment or application.



## Hubbell Flexibility

With Hubbell's wide range of Circuit-Lock<sup>®</sup> motor controllers and disconnects that offer several mounting options, NEC<sup>®</sup> line of sight requirements are easily achieved at the equipment or on the wall in virtually any industrial environment. Switches with a compact footprint, a variety of NEMA<sup>®</sup> type enclosures and plug-and-play LINKOSITY<sup>®</sup> make switch placement easier and more flexible than ever.



## Hubbell Productivity

Circuit-Lock<sup>®</sup> keeps assembly lines, goods and services moving. By offering a dual motor controller-disconnect rating, power can be safely terminated at any point in the circuit to perform maintenance on a single motor without shutting down the entire line. With the plug-and-play LINKOSITY<sup>®</sup> power system, MotorQuick<sup>®</sup> reduces motor change-out time by more than 65% to get equipment up and running faster.

## Hubbell Safety

Safety of personnel and equipment is paramount in any manufacturing environment. Hubbell Circuit-Lock<sup>®</sup> motor controllers withstand short circuits and provide a high degree of safety across the factory floor. Disconnect Switches for Variable Frequency Drives (VFDs) safely terminate power to prevent risk of injury and damage to high-performance output devices used for controlling today's conveyor systems.



## Hubbell Compliance

Compliance with codes and regulations is a must in any industrial environment. Hubbell motor controllers meet a variety of requirements, including OSHA lockout/tagout, NSF certification for hygiene and hazardous location ratings. Each Circuit-Lock<sup>®</sup> motor controller is UL listed as "Suitable as Motor Disconnect". The NEC<sup>®</sup> allows for the disconnect and controller to be in one unit.



## Variable Frequency Disconnects



## Each Controller is Also a Disconnect



NEC<sup>®</sup> is a registered trademark of the National Fire Protection Association (NFPA).  
NEMA<sup>®</sup> is a registered trademark of the National Electrical Manufacturers Association.



# Switched Disconnects and Enclosures

## Hubbell Manual Motor Controllers and Disconnects

"Suitable as Motor Disconnects"

### Ratings Quick Reference Guide

#### Circuit-Lock® Switched Enclosures

Amp	Description	Phase	Poles	HP				Catalog Number
				120	240	480	600	
30	TYPE 1 Non-Metallic	3	3	3	7.5	15	20	HBL1389MQR
	TYPE 1 Non-Metallic	3	3	3	7.5	15	20	HBL1389MQ5
	TYPE 1 Non-Metallic	3	3	3	7.5	15	20	HBL1389MQR2
	NEMA 1 Aluminum	1	2	2	5	10	15	HBL1372D
	NEMA 1 Aluminum	3	3	3	7.5	15	20	HBL1379D
	NEMA 1 Non-Metallic	1	2	2	5	10	15	HBL1392D
	NEMA 1 Non-Metallic	3	3	3	7.5	15	20	HBL1389D
	NEMA 3/3R Non-Metallic	1	2	2	5	10	15	HBL13R22D
	NEMA 3/3R Non-Metallic	3	3	3	7.5	15	20	HBL13R23D
	NEMA 3R Die Cast Aluminum	1	2	2	5	10	15	HBL13R12D
	NEMA 3R Die Cast Aluminum	3	3	3	7.5	15	20	HBL13R13D
	NEMA 3R Aluminum	1	2	2	5	10	15	HBL13R92D
	NEMA 3R Aluminum	3	3	3	7.5	15	20	HBL13R89D
	TYPE 4X Non-Metallic	3	3	1	7.5	15	15	HBLDS3
	TYPE 4X Non-Metallic	3	3	1	7.5	15	15	HBLDS3AC
	TYPE 4X Non-Metallic	3	3	1	7.5	15	15	HBLDS3NK
	TYPE 4X Non-Metallic	3	3	1	7.5	15	15	HBLDS3ACNK
	TYPE 4X Non-Metallic	3	3	1	5	10	10	HBLDS33ACNK
	TYPE 4X Non-Metallic	3	3	1	7.5	15	15	HBLDS3MQR
	TYPE 4X Non-Metallic	3	3	1	7.5	15	15	HBLDS3MQ5
TYPE 4X Non-Metallic	3	3	1	7.5	15	15	HBLDS3MQR2	
TYPE 4X Stainless Steel	3	3	1	7.5	15	15	HBLDS3SS	
TYPE 4X Stainless Steel	3	3	1	7.5	15	15	HBLDS3SSAC	
TYPE 4X Stainless Steel	3	3	1	7.5	15	15	HBLDS3SSVFD	
TYPE 4X Stainless Steel	3	3	2	7.5	15	15	HBLDS3SSMQR	
TYPE 4X Stainless Steel	3	3	1	7.5	15	15	HBLDS3SSMQ5	
TYPE 4X Non-Metallic Fused Disconnect	3	3	1	7.5	15	20	FDS30	
NEMA 4X Stainless Steel	3	3	3	7.5	15	20	HBL13S33D	
NEMA 4X Non-Metallic	3	3	3	7.5	15	20	HBL13X33D	
60	NEMA 3R Aluminum	1	2	—	10	15	20	HBL16R92D
	NEMA 3R Aluminum	3	3	—	10	25	30	HBL16R93D
	TYPE 4X Non-Metallic	3	3	7.5	30	50	50	HBLDS6
	TYPE 4X Non-Metallic	3	3	7.5	30	50	50	HBLDS6AC
	TYPE 4X Stainless Steel	3	3	7.5	30	50	50	HBLDS6SS
	TYPE 4X Stainless Steel	3	3	7.5	30	50	50	HBLDS6SSAC
	TYPE 4X Non-Metallic Fused Disconnect	3	3	3	15	30	40	FDS60
	NEMA 4X Stainless Steel	3	3	—	10	25	30	HBL16S63D
NEMA 4X Non-Metallic	3	3	—	10	25	30	HBL16X63D	
100	TYPE 4X Non-Metallic	3	3	7.5	30	50	50	HBLDS10
	TYPE 4X Non-Metallic	3	3	7.5	30	50	50	HBLDS10AC
	TYPE 4X Stainless Steel	3	3	7.5	30	50	50	HBLDS10SS
	TYPE 4X Stainless Steel	3	3	7.5	30	50	50	HBLDS10SSAC



#### Circuit-Lock® Switches

Amp	Description	Phase	Poles	HP				Catalog Number
				120	240	480	600	
30	Toggle Switch	1	2	2	5	10	15	HBL7832D
	Short Toggle Switch	1	2	2	5	10	15	HBL7832DS
	Toggle Switch, Bulk Pack	1	2	2	5	10	15	HBL7832DX
	Toggle Switch	3	3	3	7.5	15	20	HBL7810D
	Short Toggle Switch	3	3	3	7.5	15	20	HBL7810DS
40	Toggle Switch	1	2	2	5	10	15	HBL7842D
	Toggle Switch	3	3	3	7.5	15	20	HBL7843D
50	Toggle Switch	1	2	2	5	10	15	HBL7852D
	Toggle Switch	3	3	3	7.5	15	25	HBL7853D
—	Finger guard (30–50A Switches)	—	—	—	—	—	—	HBLFG30
60	Toggle Switch	1	2	—	10	15	20	HBL7862D
	Toggle Switch	3	3	—	10	25	30	HBL7863D
	Toggle Switch – Front Wire	1	2	—	10	15	20	HBL7862FWD
	Toggle Switch – Front Wire	3	3	—	10	25	30	HBL7863FWD
85	Toggle Switch	1	2	—	10	15	20	HBL7882D
	Toggle Switch	3	3	—	10	25	40	HBL7883D





**Circuit-Lock® 30, 60, and 100 Ampere Unfused Disconnect Switches**

NEC section 430.102(B) requires each motor controller to have a disconnect within line of sight from the motor and driven equipment. NEC section 430.109(A)(6) recognizes that a manual motor controller and disconnect can be the same unit, provided it has been tested for this purpose. Hubbell's Circuit-Lock® Unfused Disconnect Switches are UL listed as a manual motor controller and also "suitable as a motor disconnect" and meet these code requirements. In addition, the enclosure offers the ability to lock directly wired motor loads in the OFF position to comply with OSHA Lockout/Tagout regulations. This safety enclosure is Type 4X (Wash down, Corrosion resistant) and is also suitable for use with metallic conduit. The switch is mounted on an internal frame that is integral with the enclosure and bonds all grounds, and it accepts auxiliary contacts that can be used to signal PLC controllers.

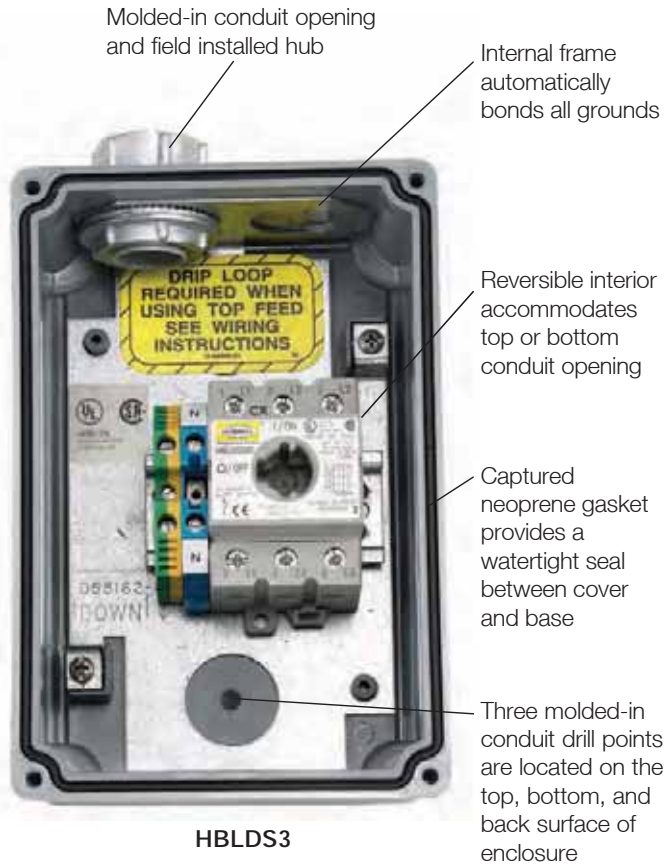

Circuit-Lock® Unfused Disconnect Switches are available in 30, 60 and 100 Amp, 600V AC ratings.



Auxiliary contacts are available for control circuit applications including the ON/OFF control of pilot lights or signal for programmable controllers.



Conduit hub and adjustable mounting feet are supplied for ease of installation.

Valox® is a trademark of SABIC Innovative Plastics, acquired from General Electric Company.

# Switched Disconnects and Enclosures Circuit-Lock® Unfused Disconnect Switches

*"Suitable as Motor Disconnects"*



UL Listed, CSA Certified  
TYPE 4, 4X and  
12 Enclosure Rating

**IP66**  
SUITABILITY

## Unfused Disconnect Switches in Non-Metallic Enclosure\*

Description	Catalog Number
30A Circuit-Lock disconnect switch.	<b>HBLDS3</b>
30A Circuit-Lock disconnect switch for use with variable frequency drives.	<b>HBLDS3VFD</b>
30A Circuit-Lock disconnect switch with HBLAC1 auxiliary contact.	<b>HBLDS3AC</b>
30A Circuit-Lock disconnect switch with HBLAC2 auxiliary contact.	<b>HBLDS3AC2</b>
30A Circuit-Lock disconnect switch without conduit knockout or conduit fitting.	<b>HBLDS3NK</b>
30A Circuit-Lock disconnect switch with HBLAC1 auxiliary contact without conduit knockout or conduit fitting.	<b>HBLDS3ACNK</b>
30A Circuit-Lock disconnect switch with 3 auxiliary contacts, w/o conduit knockouts. Break before main break – 1 set "normally open", 1 set "normally closed". Break after main break – 2 sets "normally open", 1 set "normally closed".	<b>HBLDS33ACNK</b>
60A Circuit-Lock disconnect switch.	<b>HBLDS6</b>
60A Circuit-Lock disconnect switch with HBLAC1 auxiliary contact.	<b>HBLDS6AC</b>
60A Circuit-Lock disconnect switch for use with variable frequency drives.	<b>HBLDS6VFD</b>
100A Circuit-Lock disconnect switch.	<b>HBLDS10</b>
100A Circuit-Lock disconnect switch with HBLAC1 auxiliary contact.	<b>HBLDS10AC</b>
100A Circuit-Lock disconnect switch for use with variable frequency drives.	<b>HBLDS10VFD</b>



**HBLDS3**



**HBLDS3SS**



**HBLAC1**



**HBLAC2**

## Unfused Disconnect Switches in Stainless Steel Enclosure\*

Description	Catalog Number
30A Circuit-Lock disconnect switch.	<b>HBLDS3SS</b>
30A Circuit-Lock disconnect switch with HBLAC1 auxiliary contact.	<b>HBLDS3SSAC</b>
30A Circuit-Lock disconnect switch for use with variable frequency drives.	<b>HBLDS3SSVFD</b>
60A Circuit-Lock disconnect switch.	<b>HBLDS6SS</b>
60A Circuit-Lock disconnect switch with HBLAC1 auxiliary contact.	<b>HBLDS6SSAC</b>
60A Circuit-Lock disconnect switch for use with variable frequency drives.	<b>HBLDS6SSVFD</b>
100A Circuit-Lock disconnect switch.	<b>HBLDS10SS</b>
100A Circuit-Lock disconnect switch with HBLAC1 auxiliary contact.	<b>HBLDS10SSAC</b>
100A Circuit-Lock disconnect switch for use with variable frequency drives.	<b>HBLDS10SSVFD</b>

## Auxiliary Contacts for 30, 60 and 100 Amp Switch, NEMA A600 Pilot Duty

Description	Catalog Number
"Break After Main Break", 1 set of n/o contacts, 1 set of n/c contacts.	<b>HBLAC1**</b>
"Break Before Main Break", 1 set of n/o contacts.	<b>HBLAC2**</b>

Note: \*Certified by NSF, International.

\*\*Up to two auxiliary contacts per enclosure. Not for use with HBLDS33ACNK.  
30A Units are supplied with one 3/4 in. NPT Raintight conduit fitting.  
60A and 100A Units are supplied with two 1 1/4 in. NPT Raintight conduit fittings.

## Variable Frequency Drive Diagram



# Switched Disconnects and Enclosures

## Circuit-Lock® Unfused Disconnect Switches

"Suitable as Motor Disconnects"

**IP66**  
SUITABILITY



HBLDS3RC

### Replacement Covers

Description	Catalog Number
For 30A non-metallic switches.	HBLDS3RC
For 30A stainless steel switches.	HBLDS3SSRC
For 60A non-metallic switches.	HBLDS6RC
For 60A stainless steel switches.	HBLDS6SSRC
For 100A non-metallic switches.	HBLDS10RC
For 100A stainless steel switches.	HBLDS10SSRC



HBL30RGB



HBL60100RGB

### Replacement Ground Block

Description	Catalog Number
For 30A switches.	HBL30RGB
For 60A and 100A switches.	HBL60100RGB

### Replacement Neutral Block

Description	Catalog Number
For 30A switches.	HBL30RNB
For 60A switches.	HBL60RNB
For 100A switches.	HBL100RNB



HBLDS3RS

### Replacement Switches

Description	Catalog Number
For 30A switches.	HBLDS3RS
For 60A and 100A switches.	HBLDS60100RS
For HBLDS33ACNK.	HBLDS33ACRS



HBLRFT1

### Replacement Mounting Feet

Description	Catalog Number
For 30A non-metallic switches.	HBLRFT1 <sup>Δ</sup>
For 60A and 100A non-metallic switches.	HBLRFT2 <sup>Δ</sup>

Note: <sup>Δ</sup> Package of 10 feet and 10 screws.

# Switched Disconnects and Enclosures

## Circuit-Lock® Unfused Disconnect Switches

Dimensions and Specifications

### Dimensions

Key	Non-Metallic		Stainless Steel	
	30A inch (mm)	60A/100A inch (mm)	30A inch (mm)	60A/100A inch (mm)
A	6.00 (152)	7.75 (197)	—	—
B	5.12 (130)	6.87 (175)	4.87 (124)	7.30 (185)
C	4.12 (105)	4.75 (121)	3.30 (84)	5.50 (140)
D	6.62 (168)	8.00 (203)	—	—
E	7.62 (194)	9.95 (253)	7.05 (179)	10.30 (262)
F	8.50 (216)	11.00 (279)	8.38 (213)	11.63 (296)
G	4.12 (105)	5.94 (151)	5.39 (137)	5.93 (151)

### Horsepower Ratings

Voltage	30A	30A*	60A	100A
1Ø 120V AC	1	1	7.5	7.5
1Ø 200–240V AC	3	2.5	15	15
1Ø 480V AC	5	5	30	30
3Ø 200–240V AC	7.5	5	30	30
3Ø 480V AC	15	10	50	50
3Ø 600V AC	15	10	50	50

Note: \*HBLDS33ACNK.

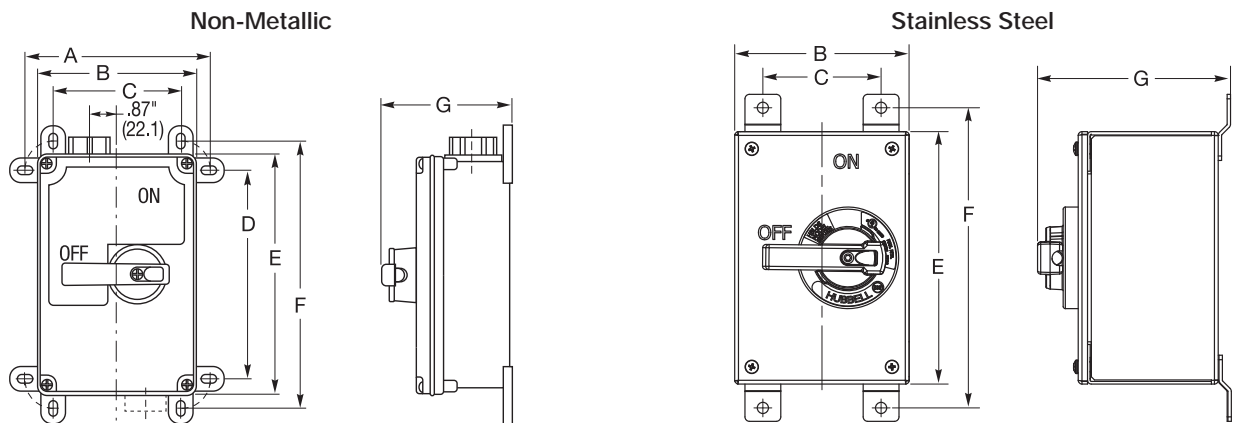

### Circuit-Lock® Unfused Disconnect Switches

#### Specifications

Moisture Resistance	Indoor and Outdoor – Type 4X (Wash down, Corrosion resistant); Indoor – 30, 60A and 100A Type 12 (Dust-tight, Falling Dirt, Noncorrosive Liquids).
Flammability	UL94-5VA and V0 Classification.
Operating Temperature	Maximum Continuous 75°C; Minimum Continuous -40°C without impact.
UV Resistance	All materials are UV stabilized.
Dielectric Voltage	Withstands 3000V AC minimum.
Max. Working Voltage	600V AC RMS.
Current Interrupting	Certified for current interrupting at full rated current and voltage.
Short Circuit Current Ratings (SCCR): (Motor Disconnect)	<ul style="list-style-type: none"> <li>• 30/60/100A: Suitable for use on a circuit capable of delivering not more than 10kA RMS symmetrical, 600V AC max.</li> <li>• 30A: Suitable for use on a circuit capable of delivering not more than 65kA RMS symmetrical, 600V AC max. when protected by Class J fuses rated 30A max.</li> <li>• 60/100A: Suitable for use on a circuit capable of delivering not more than 65kA RMS symmetrical, 600V AC max. when protected by Class J fuses rated 100A max.</li> </ul>
Terminal Identification	In accordance with UL, CSA and international conventions.
Product Identification	Identification and ratings are part of external label.
Mounting	Non-Metallic - External fully adjustable feet. Stainless Steel - Feet are fixed.
Impact Resistance	In accordance with UL 746C.

#### Materials

Part	Non-Metallic	Stainless Steel
Base	Valox®	#14 Gauge Type 304 Stainless Steel
Top	Valox®	#14 Gauge Type 304 Stainless Steel
Handle	Valox®	Valox®
Conduit Hub	Zinc 30A Unfused - 3/4 in. Zinc 60/100A Unfused - 1 1/4 in.	Zinc 30A - 3/4 in. Zinc 60/100A - 1 1/4 in.
Enclosure Gasket	Neoprene	Neoprene
Shaft (Unfused)	Valox®	Valox®
Shaft Seal	Molded Neoprene	Molded Neoprene
Frame	Galvanized Steel	N/A
Enclosure Screws	Stainless Steel 300 Series	Stainless Steel

Valox® is a trademark of SABIC Innovative Plastics, acquired from General Electric Company.

Dimensions in Inches (mm)

# Switched Disconnects and Enclosures

## Hubbell's Motor-Quick®

Plug and Play Technology

MotorQuick® significantly reduces the time it takes to replace motors by combining the plug-and-play technology of the LINKOSITY® power system with the versatility of Circuit-Lock® motor disconnect switches. Quick disconnect terminations will reduce motor change-out time by approximately 65%. Keeping spare motors already pre-

wired with a LINKOSITY® inlet enables wiring to be done off-line when it is convenient, not critical. Motor rotation can be pre-checked in a maintenance shop to further speed the installation.

The net result is that equipment is up and running in a fraction of the time, helping improve the bottom line.



### MotorQuick® Cost of Ownership Analysis

#### Traditional Motor Changeout

Catalog Number	Total Material Cost	Labor Cost/ Hr	Downtime	Total Labor Cost	Downtime Cost/hr	Total Downtime Cost	Total Cost
HBL1389D	\$106.00	\$53.00	1 hour	\$53.00	\$750.00	\$750.00	\$909.00
HBLDS3	\$185.00	\$53.00	1 hour	\$53.00	\$750.00	\$750.00	\$988.00

#### MotorQuick® Motor Changeout

Catalog Number	Total Material Cost	Labor Cost/ Hr	Downtime	Total Labor Cost	Downtime Cost/hr	Total Downtime Cost	Total Cost	Total Savings
HBL1389MQ*	\$299.00	\$53.00	20 minutes	\$17.67	\$750.00	\$250.00	\$566.67	<b>\$342.33</b>
HBLDS3MQ*	\$411.00	\$53.00	20 minutes	\$17.67	\$750.00	\$250.00	\$678.67	<b>\$309.33</b>

Note: \*MotorQuick catalog numbers are based on the average cost of the various designs.

30 Ampere, 600 Volts AC

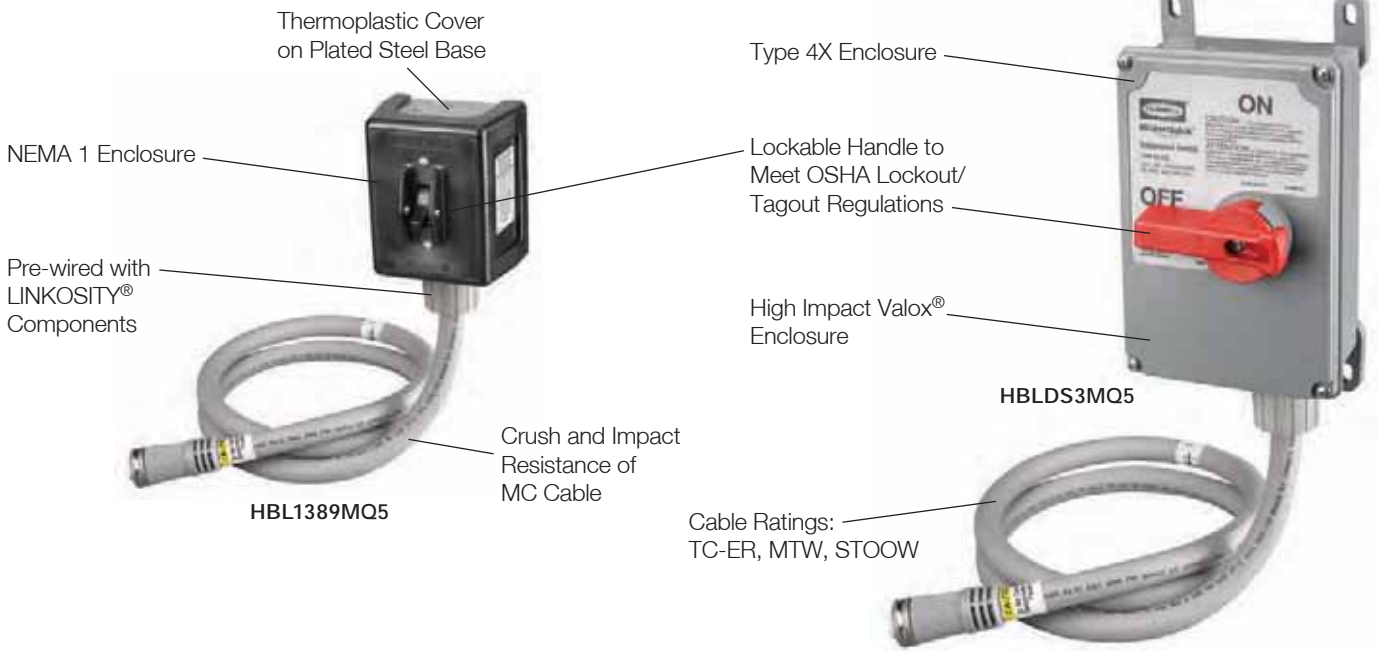

Quick Disconnect Switches

Description	Catalog Number
Type 1 Non-Metallic Enclosure 30A 3 Pole 600V AC	
HBL1389D with one pre-wired LINKOSITY® female receptacle (load side).	HBL1389MQR
HBL1389D with 5 foot pre-wired LINKOSITY® female cable (load side).	HBL1389MQ5
HBL1389D with one pre-wired LINKOSITY® male receptacle (line side) and one pre-wired LINKOSITY® female receptacle (load side).	HBL1389MQR2
Type 4X Non-Metallic Enclosure 30A 3 Pole 600V AC	
HBLDS3 with one pre-wired LINKOSITY® female receptacle (load side).	HBLDS3MQR
HBLDS3 with 5 foot pre-wired LINKOSITY® female cable (load side).	HBLDS3MQ5
HBLDS3 with one pre-wired LINKOSITY® male receptacle (line side) and one pre-wired LINKOSITY® female receptacle (load side).	HBLDS3MQR2
Type 4X Stainless Steel Enclosure 30A 3 Pole 600V AC	
HBLDS3SS with one pre-wired LINKOSITY® female receptacle (load side).	HBLDS3SSMQR
HBLDS3SS with 5 foot pre-wired LINKOSITY® female cable (load side).	HBLDS3SSMQ5
HBLDS3SS with one pre-wired LINKOSITY® male receptacle (line side) and one pre-wired LINKOSITY® female receptacle (load side).	HBLDS3SSMQR2

Accessories

Description	Catalog Number
3P 4W LINKOSITY® male receptacle for installation on motor.	RM3004PA001
3P 4W LINKOSITY® female receptacle for installation in switch.	RF3004PA001
3P 4W LINKOSITY® double ended (male/female) 5-50 foot cable.	PH3004PAxxx*
3P 4W LINKOSITY® single ended (female) 5-50 foot cable.	PF3004PAxxx*
Cord connector, ¼ in. NPT .63-.75 in. (16.0-19.1) diameter.	SHC1037CR
Lock-on cover for LINKOSITY® connections.	PH2030C

Note: \*Cables available from 5-50 feet in 5 foot increments. To purchase larger cable, replace the **xxx** with the required length in feet. (Examples: PH3004PA005 = 5 foot cable, PH3004PA050 = 50 foot cable.)

Sample Set Up

(1) HBLDS3MQR + (1) PH3004PAxxx + (1) RM3004PA001 = Total Set Up\*\*

Note: \*\* Retrofit parts available for pre-existing disconnect switch installations. Please consult factory for availability.

Valox® is a trademark of SABIC Innovative Plastics, acquired from General Electric Company.



### Dimensions

#### Type 1

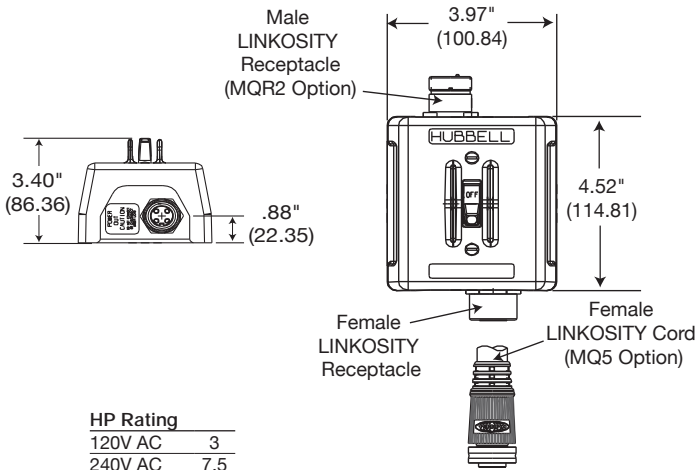

HP Rating	
120V AC	3
240V AC	7.5
480V AC	15
600V AC	20

#### Type 4X

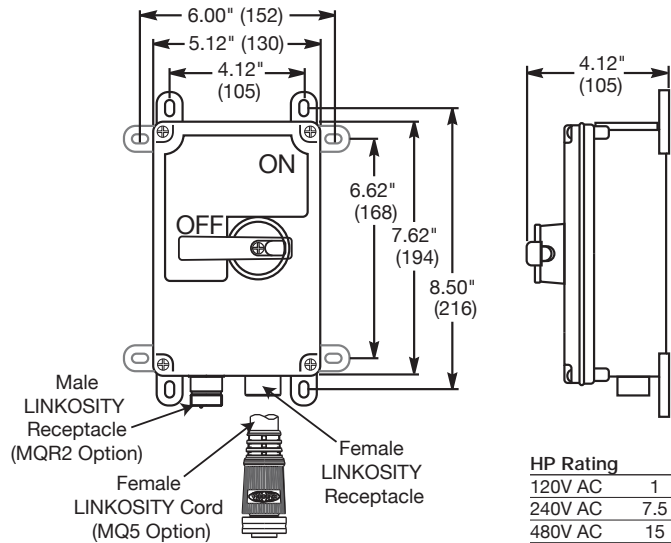

HP Rating	
120V AC	1
240V AC	7.5
480V AC	15
600V AC	15

### Specifications

#### Type 1

#### Type 4X

Electrical Performance		Type 1		Type 4X	
Dielectric Voltage		2,200V AC minimum for 1 minute.		2,200V AC minimum for 1 minute.	
Electrical Life		6,000 cycles with load.		6,000 cycles with load.	
Max. Working Voltage		600V AC RMS.		600V AC RMS.	
Short Circuit Current Ratings (SCCR): (Motor Disconnect)		10,000 RMS symmetrical amps when tested with 60A max J fuses.		<ul style="list-style-type: none"> <li>• 30: Suitable for use on a circuit capable of delivering not more than 10kA RMS symmetrical, 600V AC max.</li> </ul>	
Short Circuit Current Ratings (SCCR): (Motor Controller)		10,000 RMS symmetrical amps when tested with 125A RK5 fuses.		<ul style="list-style-type: none"> <li>• 30A: Suitable for use on a circuit capable of delivering not more than 65kA RMS symmetrical, 600V AC max. when protected by Class J fuses rated 30A max.</li> </ul>	
Mechanical		Type 1		Type 4X	
Mechanical Life		10,000 minimum cycles.		10,000 minimum cycles.	
Terminal Accommodations		Amps	AWG Min.	AWG Max.	
Terminal Torque		30	#14	#10	
Impact Resistance		30	20 inch pounds	30	20 inch pounds
					UL746C
Environmental		Type 1		Type 4X	
Flammability		UL94HB/V-0.		UL94-5VA and V0 Classification.	
Operating Temp.		Max. continuous	60°C	Max. continuous	75°C
		Min. continuous w/o impact	-40°C	Min. continuous	-40°C
Listings		Type 1		Type 4X	
UL 508		Industrial Control Equipment File #E36355		Industrial Control Equipment File #E36355	

### LINKOSITY® Connection

Certifications	
Connecting Components	Listed to UL 2238 and UL 50E.
Electrical Performance	
Voltage	Up to 600V AC.
Amperage	Up to 30A.
Environmental	
Connectivity System Components	
Moisture Resistance	UL Type 4, 4X, 12 and 13.
Ingress Protection	IP67 Suitability.
Flammability	UL94HB cables / UL94V-0 receptacles.

Materials	
Connectivity System Components	
Contact Carrier	Nylon 6/6, white.
Contact Materials	Pins - brass. Sockets - leaded nickel copper w/ stainless steel sleeve.
Contact Plating	Hard gold over palladium/nickel.
Overmold Material	Glass filled polyurethane, gray.
Coupling Hardware	Nickel plated brass.
Cable (16 AWG and Up)	UL 600V Type TC-ER, MTW 90°C or STOOW 600V 105°C.

Dimensions in Inches (mm)



Switched Disconnects and Enclosures  
**Circuit-Lock® Fused Disconnect Switches** "Suitable as Motor Disconnects"  
*Features and Benefits*

**Circuit-Lock® 30 and 60 Ampere Fused Disconnect Switches**

The Circuit-Lock Fused Disconnect Switch provides fused switched control of a directly wired load. The switch cannot be turned ON unless the enclosure cover is closed. The fuses cannot be accessed until the switch is turned OFF. The fuse holder accepts Class "J" fuses. This enclosure is non-metallic and is listed for Outdoor/Indoor (Type 4X Wash down, Corrosion resistant). The handle can be locked in the OFF position to comply with OSHA Lockout/Tagout regulations.

Three molded-in conduit drill points are located on the top, bottom, and back surface of enclosure. Conduit hub provided: 30A 1 inch NPT, 60A 1 1/4 inch NPT

Adjustable mounting feet (4) can be mounted in any of three positions for ease of installation

Stainless steel hardware for corrosion resistance

Fused disconnect switches accept Class "J" fuses

Safety interlocked fuse access door

Non-metallic enclosure meets UL 50E Type 4X (watertight) 12 (dust-tight) and IP66 suitability requirements. Enclosure is molded of rugged Valox® to resist abuse, corrosion and enhance safety. All external hardware is stainless steel

Removable door for ease of wiring and installation

FDS30

Lockable high visibility red handle to meet OSHA Lockout/Tagout



Conduit hub and adjustable mounting feet are supplied with each Circuit-Lock® Fused Disconnect Switch.



Stainless steel 1/4 inch turn door fasteners for quick, easy access to fuses.



Enclosure door can be locked to prevent unauthorized access. Additionally, if the switch is ON, the door cannot be opened.



Compact Fused Disconnect Switch accepts Class "J" fuses. Fuse holders are top mounted for easy access. The switch accepts auxiliary contacts for control circuit applications including the ON/OFF control of remote pilot lights or signal for programmable controllers.

*Valox® is a trademark of SABIC Innovative Plastics, acquired from General Electric Company.*

**IP66**  
 SUITABILITY



FDS30

### 30 and 60 Amp Fused Disconnect Switches

Description	Catalog Number
30A Circuit-Lock fused disconnect switch.	FDS30*
60A Circuit-Lock fused disconnect switch.	FDS60*

*Note: \*Class "J" fuses not included.*

### Auxiliary Contacts

Description	Catalog Number
Auxiliary contact, normally open, A600 pilot duty.	ACFSNO
Auxiliary contact, normally closed, A600 pilot duty.	ACFSNC



ACFSNO

### Watertight Closure Plug Kits

Description	Catalog Number
For 30A Circuit-Lock fused disconnect switch.	MICPK30
For 60A Circuit-Lock fused disconnect switch.	MICPK60



MICPK30

### Replacement Mounting Feet

Description	Catalog Number
Replacement mounting feet and screws for 30A and 60A fused disconnect switches.	HBLRFT2 <sup>Δ</sup>

*Note: 30A Units supplied with two 1 in. NPT raintight conduit fittings.  
 60A Units supplied with two 1 1/4 in. NPT raintight conduit fittings.  
<sup>Δ</sup> Package of 10 feet and 10 screws.*



HBLRFT2

### Dimensions

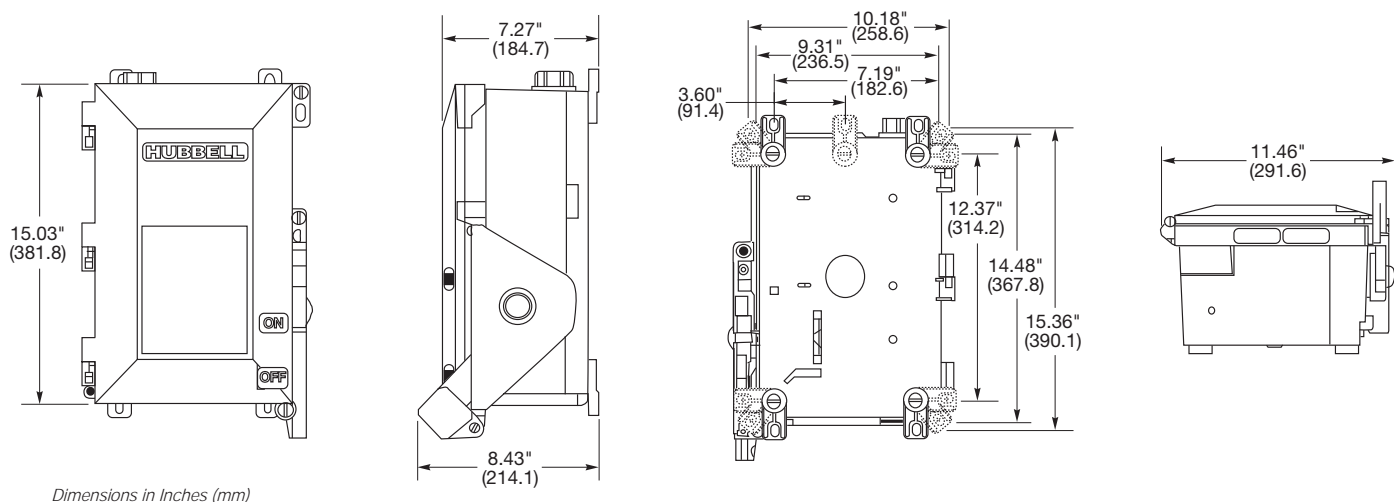

# Switched Disconnects and Enclosures

## Circuit-Lock® Fused Disconnect Switches

Horsepower Ratings and Specifications

### Horsepower Ratings

Ratings	Volts	Standard HP	Maximum HP*	Catalog Number
30A	120V AC	0.5	2	<b>FDS30</b>
600V AC	208-240V AC	1.5	3	
Max.	3Ø 240V AC	3	7.5	
	3Ø 480V AC	5	15	
	3Ø 600V AC	7.5	20	
	3Ø Y 120/208V AC	3	5	
	3Ø Y 277/480V AC	5	15	
	3Ø Y 347/600V AC	7.5	20	
60A	120V AC	1.5	3	<b>FDS60</b>
600V AC	208-240V AC	3	7.5	
Max.	3Ø 240V AC	7.5	15	
	3Ø 480V AC	15	30	
	3Ø 600V AC	15	50	
	3Ø Y 120/208V AC	7.5	15	
	3Ø Y 277/480V AC	15	30	
	3Ø Y 347/600V AC	15	40	

Note: \*Requires time delay fuses.

### Fuse and Short Circuit Information

Horsepower Ratings	The starting current of motors of more than the standard horsepower rating may require the use of fuses with appropriate time-delay characteristics.
Short Circuit Withstand Rating	Suitable for use on a circuit capable of delivering not more than 200,000 RMS symmetrical amperes at the voltage rating of receptacle when protected by Class "J" fuses.

Note: Replacement fused switch must be the same type Hubbell switch as original and have equal or greater short circuit current withstand rating.

### Circuit-Lock® Fused Disconnect Switch

Specifications	
Moisture Resistance	Indoor and Outdoor – Type 4X (Wash down, Corrosion resistant); Indoor – Type 12 (Dust-tight, Falling Dirt, Noncorrosive Liquids).
Flammability	UL94-5VA and V0 Classification.
Operating Temperature	Maximum Continuous 75°C; Minimum Continuous -40°C without impact.
UV Resistance	All materials are UV stabilized.
Dielectric Voltage	Withstands 3000V AC minimum.
Max. Working Voltage	600V AC RMS.
Impact Resistance	In accordance with UL 746C.
Terminal Identification	In accordance with UL, CSA and international conventions.
Product Identification	Identification and ratings are part of external label.
Mounting	External fully adjustable feet.
Fuse Types	UL Listed, Class "J"; CSA Certified, HRCI-J.

Materials	
Part	Material
Base	Valox®
Door	Valox®
Handle	Valox®
Conduit Hub	Zinc, 30A Fused – 1 in., 60A Fused – 1¼ in.
Enclosure Gasket	Neoprene
Shaft	Brass
Shaft Seal	Neoprene
Frame	Galvanized Steel
Ground Plate	Galvanized Steel
Enclosure Screws	Stainless Steel 300 Series

Valox® is a trademark of SABIC Innovative Plastics, acquired from General Electric Company.

## Hazardous Location Non-Fused Disconnect Switches

Hubbell's hazardous location line of non-fused disconnect switches are typically used for applications with the presence of flammable gasses or vapors, ignitable dusts and fibers. They are also suitable for use in outdoor or indoor damp, wet and dirty locations or in areas where frequent wash downs, heavy rain, or water spray routinely occurs. These switches are compact in size to reduce cost and make it easier to position on the wall or piece of equipment. The enclosures are made of copper-free aluminum and have a polyester/epoxy finish to prevent corrosion. The high visibility handles can be locked out to comply with OSHA lock out/tag out regulations.



Class I, Div. 1 & 2, Groups B,C,D  
 Class I, Zones 1 & 2, Groups IIB+ H2, IIA  
 Class II, Div. 1 & 2, Groups E,F,G  
 Class III, NEMA 3, 4, 4X, 7(B,C,D), 9(E,F,G)

Copper-free aluminum construction with electrostatically applied polyester/epoxy finish to prevent corrosion

Compact NEMA 4X enclosure and footprint allows easy installation in tight locations

- 316 Stainless steel bolts
- Top and bottom drilled and tapped conduit entrances
- For use as motor disconnects



HBLB7NFD13A

Lockable handle to meet OSHA Lockout/Tagout regulations



HBLB7NFD26A

Large visible rotary handle with "On-Off" indicator allows a quick means of disconnecting power

Lockable handle to meet OSHA Lockout/Tagout regulations



### Features

- Compact size enclosures provide application flexibility with cost savings over industry standard sizes.
- Fewer cover bolts reduces installation and maintenance time.
- Gasketed flange with O-ring located inside bolt circle to seal out moisture.
- Rotary handle style operating mechanism with lockout provision as standard.
- Removable ductile mounting lugs adjust to irregular mounting surfaces.
- Bodies have top and bottom drilled and tapped conduit entrances for power connection.
- UL98 certified switch.

### Applications

- Grain manufacturing and storage
- Industrial chemical and gas manufacturing
- Petroleum refining
- Fertilizer manufacturing
- Vehicle repair/paint shops
- Coal mining
- Cotton and fabric mills

# Switched Disconnects and Enclosures Wiring Devices for Hazardous Locations

30, 60 and 100 Ampere



## Standard Materials/Finish

- Enclosures: Copper-free aluminum (less than 4/10 of 1% copper content)
- Cover Bolts: 316 Stainless Steel
- O-Ring Gasket: Silicone
- Finish: Grey Powder Polyester painted exterior, electrostatically applied
- Ratings: 600V AC, 230V DC 30–100 Amp

## 30, 60 and 100 Amp Unfused Hazardous Location Disconnect Switches

Description	Catalog Number
30A 3 Pole disconnect switch.	<b>HBLB7NFD13A</b>
30A 3 Pole disconnect switch with auxiliary contact.	<b>HBLB7NFD13AA</b>
60A 3 Pole disconnect switch.	<b>HBLB7NFD26A</b>
60A 3 Pole disconnect switch with auxiliary contact.	<b>HBLB7NFD26AA</b>
100A 3 Pole disconnect switch.	<b>HBLB7NFD21A</b>
100A 3 Pole disconnect switch with auxiliary contact.	<b>HBLB7NFD21AA</b>



HBLB7NFD13A



HBLB7NFD26A



HBLB7NFD21A



HBLVP3485

## Unfused Mechanical Interlocks and Plugs

Amp	Poles/Wires	Voltage AC	Receptacle	Plug
30	3 Pole, 2 Wire	600V AC	<b>HBLVSQ3023</b>	<b>HBLVP3385</b>
	4 Pole, 3 Wire	600V AC	<b>HBLVSQ3034</b>	<b>HBLVP3485</b>
60	3 Pole, 2 Wire	600V AC	<b>HBLVSQ6023</b>	<b>HBLVP6385</b>
	4 Pole, 3 Wire	600V AC	<b>HBLVSQ6034</b>	<b>HBLVP6485</b>

Note: HBLVSQ 30 amp models come standard with 1" drilled and tapped conduit openings top and bottom plus two 1" x 3/4" reducers and one 3/4" close-up plug for maximum flexibility. 60 amp models come with one 1/2" opening on top and bottom and one 1/2" close-up plug.

## Horsepower Ratings

Switch Amps/Phase	Single Phase HP			Three Phase HP			DC HP	Terminal Wire Size	Conduit Sizes	Catalog Number
	120V AC	230V AC	208V AC	230V AC	480V AC	600V AC	230V DC			
30A / 3P	2	5	10	10	20	30	1	#14-10	1 NPT	<b>HBLB7NFD13A</b>
60A / 3P	3	7.5	20	20	40	40	10	#14-4	1 1/2 NPT	<b>HBLB7NFD26A</b>
100A / 3P	5	15	25	30	50	50	20	#8-1	1 1/2 NPT	<b>HBLB7NFD21A</b>

## Dimensions

	Outside Box			Inside Box				Mounting Dimensions				
	A	B	C	D	E	F	G	H	I	J	K	
30 Amp	5 3/4	8 1/16	6 5/16	3 5/8	5 19/16	5 1/16	3 1/8	8 1/8	–	–	1 1/4	
60 & 100 Amp	8 1/8	13 1/16	7 13/16	4 1/4	9 3/16	6 5/16	2 1/2	11 3/8	6 3/8	7 1/2	1 13/16	

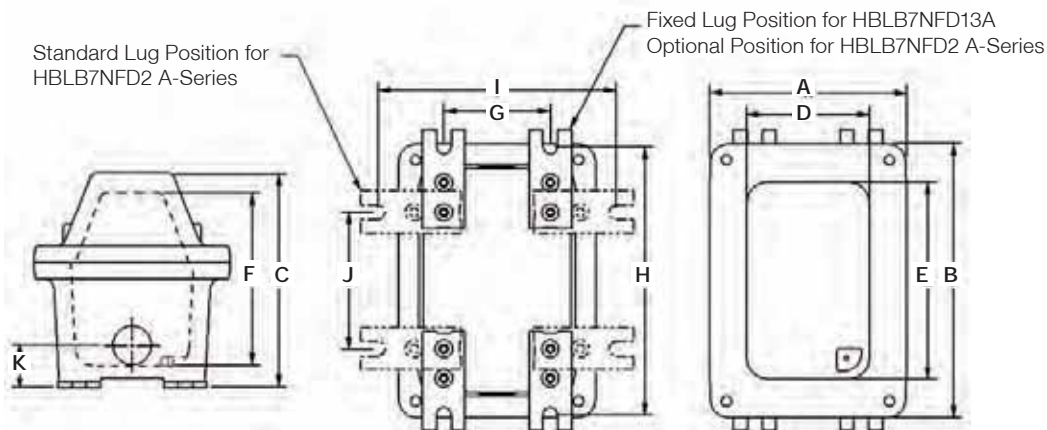

Dimensions in Inches (mm)

# Switched Disconnects and Enclosures AC Manual Toggle Controllers/Disconnects

30, 40, 50, 60 and 85A 600V AC

## Circuit-Lock® controllers rated "Suitable as Motor Disconnect"

The most complete offering of controllers with top horsepower and high amperage ratings in such a compact device.



30A, 40A and 50A

**#10 Brass Terminal Screw**  
Clamping plate for secure back or side wiring (30A only)

**Optional Side Guard**  
For close wall applications and finger safe environments



## Shared Features

Strong on/off action with quick-make, slow break operation

- Provides long-life reliability
- 10,000 Amp High Fault Short Circuit Withstand Rating

Thermoset Body

- Provides high resistance to electrical arc tracking
- Withstands high temperatures
- Excellent dimensional stability
- Superior dielectric strength



60A and 85A

**Front and Back Wiring**  
Steel Screws and Copper Terminals

**Recessed Wiring Wells**  
Finger safe environments



**Optional Side Finger Guards**  
For close wall applications and finger safe environments. For 30A, 40A and 50A controllers.



**Four Large Silver Alloy Contacts per Pole**

- Excellent conductivity
- Maximum longevity



**100% Copper Contact Arm**

- High heat management
- Reliability



**Lubrication-Free Controller**

- Continued on/off cycling even in harsh, dust and high heat environments

# Switched Disconnects and Enclosures AC Manual Toggle Controllers/Disconnects

30, 40, 50, 60 and 85A 600V AC

## 600V AC Manual Motor Controllers/Disconnects

For use in almost any industrial environment. Ideal component switch for motor control and as a disconnect. Toggle controllers can be built into equipment and enclosures for either box or panel-mount installation.

Amp	Poles	ToggleType	Wire	HP Rating				Catalog Number
				120V AC 1Ø	240V AC 3Ø	480V AC 3Ø	600V AC 3Ø	
30	2	Standard	Back/Side	2	5	10	15	<b>HBL7832D</b>
	2	Short	Back/Side	2	5	10	15	<b>HBL7832DS</b>
	2	Standard	Back/Side	2	5	10	15	<b>HBL7832DX</b>
	3	Standard	Back/Side	3	7.5	15	20	<b>HBL7810D</b>
	3	Short	Back/Side	3	7.5	15	20	<b>HBL7810DS</b>
40	2	Standard	Side	2	5	10	15	<b>HBL7842D</b>
	3	Standard	Side	3	7.5	15	20	<b>HBL7843D</b>
50	2	Standard	Side	2	5	10	15	<b>HBL7852D</b>
	3	Standard	Side	3	7.5	15	25	<b>HBL7853D</b>
60	2	Standard	Back	—	10	15	20	<b>HBL7862D</b>
	3	Standard	Back	—	10	25	30	<b>HBL7863D</b>
	2	Standard	Front	—	10	15	20	<b>HBL7862FWD</b>
	3	Standard	Front	—	10	25	30	<b>HBL7863FWD</b>
85	2	Standard	Back	—	10	15	20	<b>HBL7882D</b>
	3	Standard	Back	—	10	25	40	<b>HBL7883D</b>

Optional Side Guard, for close wall applications and finger safe environments. **HBLFG30\***

Note: \*For 30A, 40A and 50A controllers.



HBL7810D



HBL7853D



HBL7863D



HBLFG30

## Specifications

### Electrical Performance

Dielectric Voltage	Min. 2,200V AC minimum for 1 minute
Electrical Life	Min. 6,000 Cycles at rated switch load
Max. Working Voltage	600V AC RMS
Switches	10,000 RMS
Short Circuit	30A & 40A 60A max. when protected by J fuses
Withstand Rating	50A 50A max. when protected by J fuses
as Motor Disconnect	60A & 85A 80A max. when protected by J fuses
Short Circuit	
Withstand Rating	All Switches 125A max. RK5 fuses
as Motor Controller	

### Mechanical

Mechanical Life	Min. 10,000 minimum cycles
Switch Rating	AWG Max.
Terminal	30A #10
Accommodations	40A & 50A #8**
	60A & 85A #4
Wire Type	Solid and stranded copper wire only.
Terminal Torque	30A – 50A 20 inch pounds
Switch Rating	60A – 85A 25 inch pounds

### Environmental

Flammability	UL94HB/VO
Operating Temp.	Max. 75°C
	Min. -40°C continuous without impact

### Listings

	Industrial Control File
UL 508	#E70402
CSA-C22.2 No.14	LR-46186

Note: \*\*Use listed certified ring terminal.

## Dimensions

### 30, 40 and 50 Amp Standard Toggles

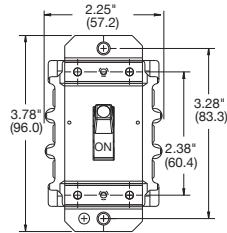

Front

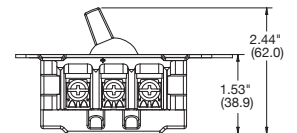

Side

### 60 and 85 Amp Standard Toggles

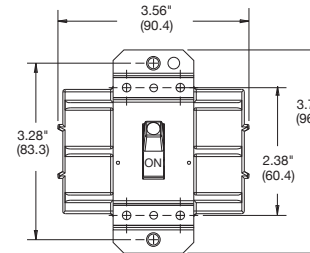

Front

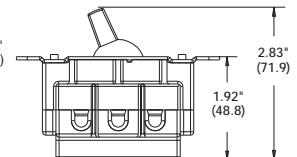

Side

Dimensions in Inches (mm)

# Switched Disconnects and Enclosures

## NEMA 1 Disconnect Switches

"Suitable as Motor Disconnects"



HBL1389D

Thermoplastic Cover  
on a Plated Steel Base  
Durable, non-conductive cover



HBL1379D

All Aluminum  
Cover and Base  
Base is pre-drilled for  
rear surface mounting

### Shared Features

Wiring conduit knockouts

- 1/2" and 3/4" NPT
- Top, bottom or back wire entry points

Surface mount control

Switch can be locked in the off position as a method of compliance with OSHA lockout/tagout

### Circuit-Lock® NEMA 1 Enclosures with Switch

Ideal for use in industrial environments, i.e. conveyer systems, industrial fans, etc.

Amp	Poles	Enclosure Material	HP Rating				Catalog Number
			120V AC 1Ø	240V AC 3Ø	480V AC 3Ø	600V AC 3Ø	
30	2	Thermoplastic	2	5	10	15	HBL1392D
30	3	Thermoplastic	3	7.5	15	20	HBL1389D
30	2	Aluminum	2	5	10	15	HBL1372D
30	3	Aluminum	3	7.5	15	20	HBL1379D

Note: See page F-17 for technical information.

### Circuit-Lock® NEMA 1 Enclosures without Switch

For use with switches shown on page F-17.

Description	Cover Material	Base Material	No. Equipment Grounds	Catalog Number
For use with 30A switch.	Thermoplastic	Steel	1	HBL1390
For use with 30A switch.	Aluminum	Aluminum	2	HBL1370



HBL1389D



HBL1379D



HBL1390



HBL1370

### Dimensions

HBL1370, HBL1372D and HBL1379D

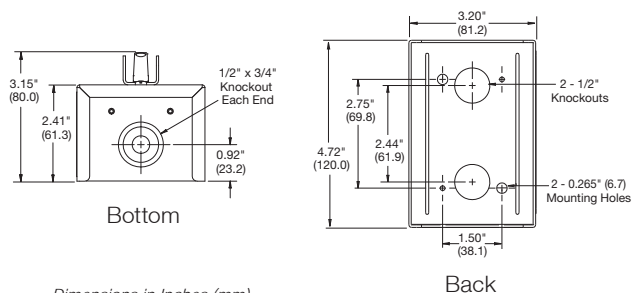

Dimensions in Inches (mm)

HBL1390, HBL1389D and HBL1392D

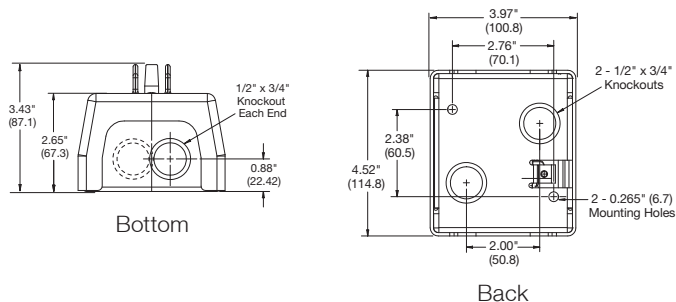



# Switched Disconnects and Enclosures NEMA 3/3R and 3R Disconnect Switches

"Suitable as Motor Disconnects"

## Circuit-Lock® NEMA 3/3R Enclosures with Switch

Ideal for use on outdoor equipment.

Amp	Poles	Enclosure Material	HP Rating				Catalog Number
			120V AC 1Ø	240V AC 3Ø	480V AC 3Ø	600V AC 3Ø	
30	2	Thermoplastic	2	5	10	15	<b>HBL13R22D</b>
30	3	Thermoplastic	3	7.5	15	20	<b>HBL13R23D</b>
30	2	Aluminum	2	5	10	15	<b>HBL13R12D†</b>
30	3	Aluminum	3	7.5	15	20	<b>HBL13R13D†</b>

Note: See page F-17 for technical information.

\*Drill weep hole to alter from NEMA 3 to NEMA 3R.

†Equipped with HBLFG30 sidewall insulation barriers.



## Dimensions

### HBL13R22D and HBL13R23D

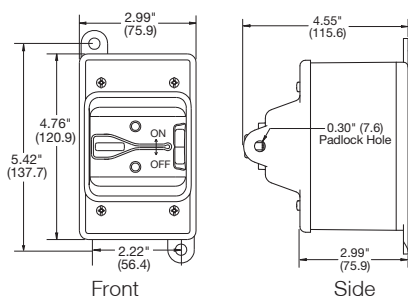

### HBL13R12D and HBL13R13D

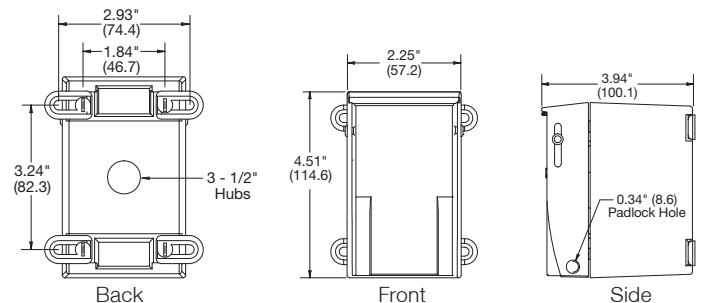

## Circuit-Lock® NEMA 3R Enclosures with Switch

Ideal for use in outdoor environments.

Amp	Poles	Enclosure Material	HP Rating				Catalog Number
			120V AC 1Ø	240V AC 3Ø	480V AC 3Ø	600V AC 3Ø	
30	2	Aluminum	2	5	10	15	<b>HBL13R92D</b>
30	3	Aluminum	3	7.5	15	20	<b>HBL13R89D</b>
60	2	Aluminum	—	10	15	20	<b>HBL16R92D</b>
60	3	Aluminum	—	10	25	30	<b>HBL16R93D</b>

Note: For switch specifications refer to page F-17.



## Circuit-Lock® NEMA 3R Enclosures without Switch

For use with switches shown on page F-17.

Description	Enclosure Material	Catalog Number
For use with 30A switch.	Aluminum	<b>HBL13R90</b>
For use with 60A switch.	Aluminum	<b>HBL16R90</b>

## Dimensions

### HBL13R90, HBL13R89D and HBL13R92D

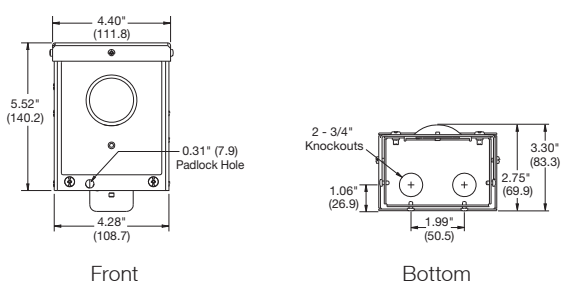

### HBL16R90, HBL16R92D and HBL16R93D

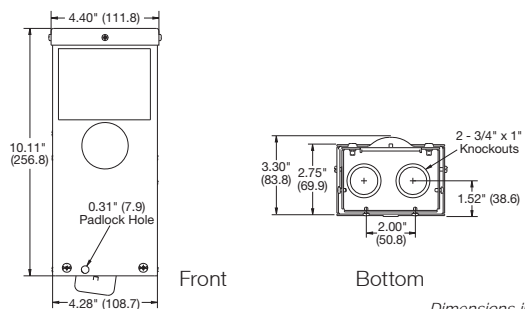

Dimensions in Inches (mm)

## Switches

# 30 Ampere, 600 Volts AC Manual Motor Controllers

"Suitable as Motor Disconnect"

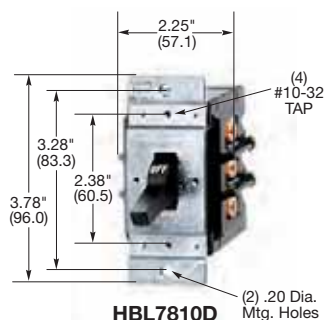

**HBL7810D**

(2) .20 Dia. Mtg. Holes

### 30A 600V AC Manual Motor Controllers, Double Pole

Description	Catalog Number
30A, double pole, single throw, AC manual motor controller, black nylon handle, side and back wired.	<b>HBL7832D</b>
30A, double pole, single throw, AC manual motor controller, black nylon handle, short toggle.	<b>HBL7832DS</b>
30A, double pole, single throw, AC manual motor controller. 50 piece bulk pack.	<b>HBL7832DX</b>
HBL7832D in HBL1390 Type 1 enclosure with non-metallic cover, ½ in. and ¾ in. knockouts on top, bottom and back of steel frame.	<b>HBL1392D</b>
HBL7832D in HBL1370 metal Type 1 enclosure.	<b>HBL1372D</b>
HBL7832D in NEMA 3R non-metallic enclosure.	<b>HBL13R22D</b>
HBL7832D in HBL13R90 metal Type 3R enclosure.	<b>HBL13R92D</b>
HBL7832D in NEMA 3R flip-lid enclosure.	<b>HBL13R12D</b>

Note: See page F-17 for technical information.

### 30A 600V AC Manual Motor Controllers, Three Pole

Description	Catalog Number
30A, three pole, single throw, AC manual motor controller, black nylon handle, side and back wired.	<b>HBL7810D</b>
30A, three pole, single throw, AC manual motor controller, black nylon handle, short toggle.	<b>HBL7810DS</b>
HBL7810D in HBL1390 Type 1 enclosure with non-metallic cover, ½ in. and ¾ in. knockouts on top, bottom and back of steel frame.	<b>HBL1389D</b>
HBL7810D in HBL1370 metal Type 1 enclosure.	<b>HBL1379D</b>
HBL7810D in NEMA 3R non-metallic enclosure.	<b>HBL13R23D</b>
HBL7810D in HBL13R90 metal Type 3R enclosure.	<b>HBL13R89D</b>
HBL7810D in NEMA 3R flip-lid enclosure.	<b>HBL13R13D</b>
30A, 600V, three pole, rotary controller in NEMA 4X stainless steel enclosure.	<b>HBL13S33D</b>
30A, 600V, three pole, rotary controller in NEMA 4X non-metallic enclosure.	<b>HBL13X33D</b>

Note: See page F-17 for technical information.

### Motor Rating

Product	120V AC	240V AC	480V AC	600V AC	Phase
30A Double Pole	2HP	5HP	10HP	15HP	1
30A Three Pole	3HP	7½HP	15HP	20HP	3
40A Double Pole	2HP	5HP	10HP	15HP	1
40A Three Pole	3HP	7½HP	15HP	20HP	3
50A Double Pole	2HP	5HP	10HP	15HP	1
50A Three Pole	3HP	7½HP	15HP	25HP	3
60A Double Pole	-	10HP	15HP	20HP	1
60A Three Pole	-	10HP	25HP	30HP	3
85A Double Pole	-	10HP	15HP	20HP	1
85A Three Pole	-	10HP	25HP	40HP	3



**HBL1389D**



**HBL13R13D**

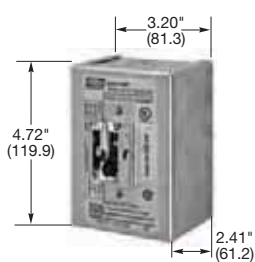

**HBL1379D**

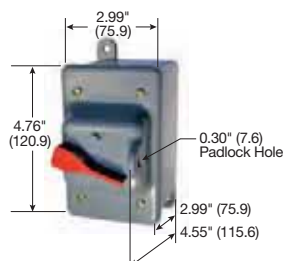

**HBL13R23D**



**HBL13R89D**



**HBL13S33D**

Dimensions in Inches (mm)

## AC Switches

# 40, 50, 60 and 85 Ampere, 600 Volts AC Manual Motor Controllers

"Suitable as Motor Disconnect"

**IP44\***  
SUITABILITY

### 40A 600V AC Manual Motor Controllers

Description	Catalog Number
40A, double pole, single throw, AC manual motor controller, black nylon handle, side wired.	<b>HBL7842D</b>
40A, three pole, single throw, AC manual motor controller, black nylon handle, side wired.	<b>HBL7843D</b>

*Note: See page F-17 for technical information.*

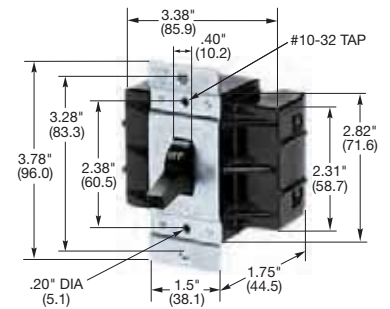

**HBL7862D**

### 50A 600V AC Manual Motor Controllers

Description	Catalog Number
50A, double pole, single throw, AC manual motor controller, black nylon handle, side wired.	<b>HBL7852D</b>
50A, three pole, single throw, AC manual motor controller, black nylon handle, side wired.	<b>HBL7853D</b>

*Note: See page F-17 for technical information.*

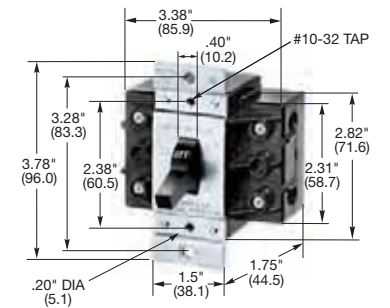

**HBL7862FWD**

### 60A 600V AC Manual Motor Controllers

Description	Catalog Number
60A, double pole, single throw, AC manual motor controller, black nylon handle, back wired.	<b>HBL7862D</b>
Same as HBL7862D except front wired.	<b>HBL7862FWD</b>
HBL7862FWD in Type 3R enclosure.	<b>HBL16R92D</b>
60A, three pole, single throw, AC manual motor controller, black nylon handle, back wired.	<b>HBL7863D</b>
Same as HBL7863D except front wired.	<b>HBL7863FWD</b>
HBL7863FWD in a Type 3R enclosure.	<b>HBL16R93D</b>
60A, 600V, three pole, rotary controller in NEMA 4X stainless steel enclosure.	<b>HBL16S63D</b>
60A, 600V, three pole, rotary controller in NEMA 4X non-metallic enclosure.	<b>HBL16X63D</b>

*Note: See page F-17 for technical information.*



**HBL16R93D**

### 85A 600V AC Manual Motor Controllers

Description	Catalog Number
85A, double pole, single throw, AC manual motor controller, black nylon handle, back wired.	<b>HBL7882D</b>
85A, three pole, single throw, AC manual motor controller, black nylon handle, back wired.	<b>HBL7883D</b>

*Note: See page F-17 for technical information.*

### Motor Controller Accessories

Description	Catalog Number
Finger Guards, fit 30A, 40A and 50A controllers.	<b>HBLFG30</b>
Auxiliary Contacts, NO/Common/NC, for use in rotary switches only.	<b>HBLAUX</b>



**HBL16S63D**

Dimensions in Inches (mm)

# Switched Disconnects and Enclosures NEMA 4X Disconnect Switches

"Suitable as Motor Disconnects"

## Shared Features

Un-drilled case allows custom placement of wire entry

Switch can be locked in the off position as a method of compliance with OSHA lockout/tagout

Hinged Cover with Removable Continuous Pin

304 Stainless Steel Enclosure  
Chemical and corrosion resistant

Valox® Handle and Collar  
Chemical and impact resistant

Thermoplastic 4X Non-Metallic Enclosures

HBL13S33D

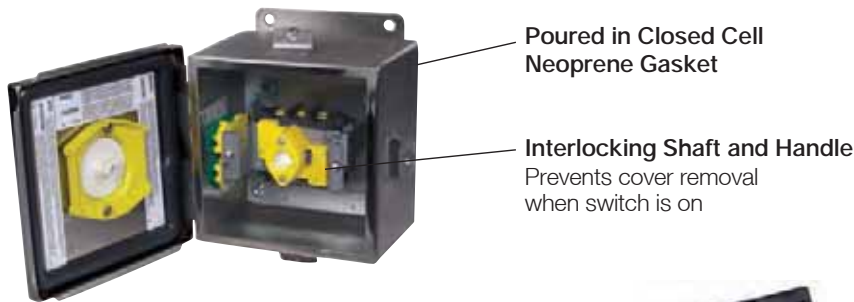

Poured in Closed Cell Neoprene Gasket

Interlocking Shaft and Handle  
Prevents cover removal when switch is on

Up to 2 Optional Auxiliary Contacts  
For PLCs and external indicators



HBL13X33D

## Circuit-Lock® NEMA 4X Enclosures with Switch and Accessories

Ideal for use in environments where wash-down is necessary, i.e. food processing, laboratories, etc.



HBL16S63D

HBL13X33D

Amp	Poles	Enclosure Material	HP Rating				Catalog Number
			120V AC 1Ø	240V AC 3Ø	480V AC 3Ø	600V AC 3Ø	
30	2	Stainless Steel	3	7.5	15	20	HBL13S33D
30	3	Valox	3	7.5	15	20	HBL13X33D
60	3	Stainless Steel	—	10	25	30	HBL16S63D
60	3	Valox	—	10	25	30	HBL16X63D
Finger Guard option for 30A switch.							HBLFG30
NO/Comon/NC auxiliary contact, 10A 120/250V AC for 30 and 60 Amp switches.							HBLAUX

Note: See page F-17 for technical information.

## Dimensions

### HBL13S33D

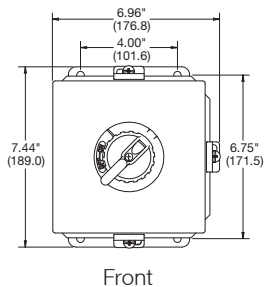

Front

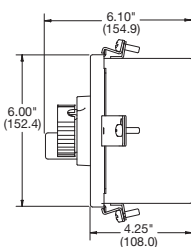

Side

### HBL16S63D

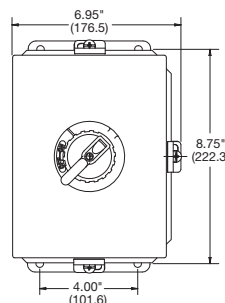

Front

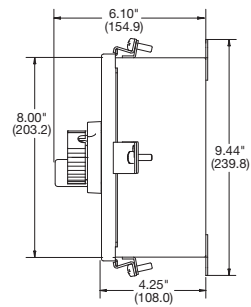

Side

Dimensions in Inches (mm)

Valox® is a trademark of SABIC Innovative Plastics, acquired from General Electric Company.

# Switched Disconnects and Enclosures Pendant Pushbutton Stations

CPB and PBS Series



**IP55**  
SUITABILITY

## CPB Series Compact Pendant Stations, Two Button, NEMA 4X

Description	Catalog Number
Single-speed normally open-normally closed without mechanical interlock.	<b>CPB20</b>
Single-speed with mechanical interlock between pushbuttons.	<b>CPB21</b>
Two-speed with mechanical interlock between pushbuttons.	<b>CPB22</b>

*Note: Included with product: nylon cord grip and sealing washer (must be installed to achieve NEMA 4X rating).  
Indication label pack. Cord dia. range .375-.625 in. (9.5-15.9)  
Ambient temperatures: 25°F to 140°F (32°C to 60°C).  
Typical applications: Package electric motor hoists. Remote control of machinery.*

## Contact Ratings, CPB Series

Single-Speed	Voltage	Current
AC	120V	6A
35% PF	240V	3A
DC	125V	1.1A
IND	250V	.55A
Two-Speed	Voltage	Current
AC	120V	3A
35% PF	240V	1.5A



**CPB21**

## Wiring Diagram CPB2 Series

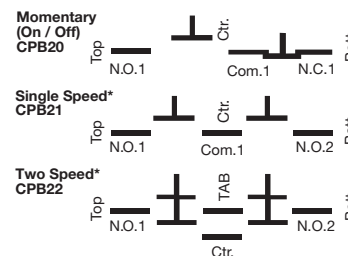

\*Mechanical "floating ball" interlock prevents activating both Pushbuttons simultaneously.

**IP44**  
SUITABILITY

## PBS Series Heavy Duty Pendant Pushbutton Stations, NEMA 3R

Description	Catalog Number
2 button, single speed.	<b>PBS2</b>
2 button, two speed.	<b>PBS22</b>
4 button, single speed.	<b>PBS4</b>
4 button, two speed.	<b>PBS42</b>
6 button, single speed.	<b>PBS6</b>
6 button, two speed.	<b>PBS62</b>
8 button, single speed.	<b>PBS8</b>
8 button, two speed.	<b>PBS82</b>

## Product Dimensions, PBS Series

Style	A	Approx. Wt. Assembled	Catalog Number
2 button	7.88" (200.0)	2.5 lbs	<b>PBS2</b>
4 button	13.69" (347.6)	4.5 lbs	<b>PBS4</b>
6 button	18.0" (457.2)	5.5 lbs	<b>PBS6</b>
8 button	22.31" (566.7)	7.5 lbs	<b>PBS8</b>

*Note: Housing: Yellow vinyl rubber.*

## Contact Interrupting Ratings, PBS Series

Two-Speed Single Break	Voltage	Current
AC	120V	6A
35% PF	240V	3A
DC	125V	.4A
IND	250V	.2A
Single-Speed Double Break	Voltage	Current
AC	120V	6A
35% PF	240V	3A
DC	125V	1.1A
IND	250V	.55A



**PBS6**

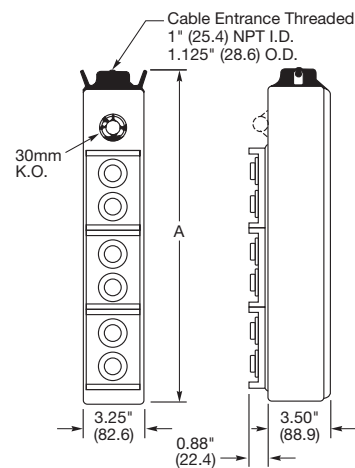

Dimensions in Inches (mm)

# Switched Disconnects and Enclosures Pendant Pushbutton Stations

Accessories and Replacement Parts



PG2



PG6



MS2



MS5

## Replacement Inserts

When the insert switches are in need of replacement, simply unplug the old insert and plug in a new one.

Description	Catalog Number
Single speed insert momentary N.O. and N.C.	<b>PG2</b>
On-Off insert (no mechanical interlock). Momentary, start-stop, reset-stop.	<b>PG6</b>
2 or 3 speed insert, momentary. Used to a maximum of 3 speed points.	<b>MS2</b>
5 speed insert, momentary. Used to a maximum of 5 speed points. For five speed applications replace an existing terminal board with the TB5 terminal board and replace an existing insert with the five speed (MS5) insert.	<b>MS5</b>



TB2



TB5

## Conversion Inserts

In addition to single speed and two speed applications, pre-assembled units can be adapted to handle other applications.

Description	Catalog Number
Terminal board, required for each insert switch PG2, PG6 and MS2.	<b>TB2</b>
Terminal board, required for insert switch MS5.	<b>TB5</b>

## Accessories

Description	Catalog Number
Indicator labels for replacement package contains 1 each: hoist, trolley, bridge, forward-reverse, raise-lower, in-out, right left, east-west, north-south, reset-stop, start-stop, power, main hoist, auxiliary hoist, on-off, up-down.	<b>PBSLP</b>
Rubber button cover for replacement purposes.	<b>PBSBC</b>
120V red pilot light for 4, 6, and 8 button units only.	<b>PBSPL1*</b>

*Note: \*Each pendant station can accommodate one of the pilot light in the 1.20 in. (30.6) diameter mounting hole.*



PBSLP



PBSBC



PBSPL1

## Kellems® Deluxe Aluminum Cord Fitting

Outdoor or indoors where subject to moisture, splash or submersion. Kellems grips provide strain relief for multi-conductor cable.

Description	Cord Range	Catalog Number
Kellems grip.	.750"-.875" (19-22.2)	<b>07401023</b>
Kellems grip.	.875"-1.00" (22.2-25.4)	<b>07401025</b>



07401023

# Section G Pin and Sleeve Devices/Mechanical Interlocks

## Index

Product	Page
Configurations Chart .....	G-3
<b>IEC Pin and Sleeve</b>	
Watertight Devices .....	G-6
Corrosion Resistant Devices .....	G-8
Data Center Pin and Sleeve .....	G-9
Back Boxes .....	G-10
Accessories .....	G-11
Dimensions .....	G-12
<b>Unfused Circuit-Lock® Mechanical Interlocks</b>	
Devices and “Reverse Service” .....	G-17
Accessories and Dimensions .....	G-18
<b>Fused Circuit-Lock® Mechanical Interlocks</b>	
Devices and Accessories .....	G-21
<b>Low Profile Pin and Sleeve</b>	
Devices and Specifications .....	G-24
Low Profile Dimensions .....	G-25
<b>IEC Pin and Sleeve Terminal Identification</b> .....	G-26
<b>UL 1686 C1 Insulgrip® Pin and Sleeve</b>	
Style I and Style II Devices .....	G-30
“Reverse Service” Style I and II Devices .....	G-31
Back Boxes and Accessories .....	G-32
Dimensions .....	G-33
<b>Insulgrip® Mechanical Interlocks</b>	
Style II, Fused and Unfused Devices .....	G-37
<b>Hazardous Location Devices</b>	
Mechanical Interlocks and Plugs .....	G-40

**HBL® Watertight  
IEC Pin and Sleeve**



**Insulgrip® NEMA 4X  
UL 1686 C1 Pin and Sleeve**



**Circuit-Lock® Unfused and  
Fused Mechanical Interlocks**



**Back Boxes & Accessories**



## Pin and Sleeve Devices Summary



### IEC Watertight Devices

Provide safe and dependable performance in the most demanding environments. Heavy duty non-conductive nylon construction provides impact and corrosion protection. Thermoset polyester contact carriers withstand high temperatures and provide resistance to electrical tracking.



### Insulgrip® NEMA 4X UL 1686 C1 Devices

Metallic where you want it and non-metallic where you need it. This tough product line is NEMA 4X rated for use in the harshest environments. The devices are fully interchangeable with other manufacturers of UL1686 C1 devices.



### Back Boxes and Accessories

A complete line of metallic and non-metallic back boxes, angle adapters, closure caps and liquidtight adapters are available. These accessories help complement the line and aid in the installation of the product.

## Hubbell Produces the Highest Quality and Most Extensive Pin and Sleeve Offering.

Similar to our Twist-Lock® devices, Hubbell's Pin and Sleeve line of plugs, connectors, inlets, receptacles, mechanical interlocks and accessories are the highest performing products available. The HBL® series of IEC pin and sleeve and Insulgrip lines are assembled in the USA and have a full list of innovative features.

The IEC line of plugs and connectors are made with a rugged super tough, one-piece housing. The thermoset polyester contact carrier provides a high resistance to electrical tracking. They withstand higher temperatures which may result from overload or arcing. The heavy-duty, external cord grip provides superior strain relief on the conductors.

The Insulgrip line of pin and sleeve is listed UL Type 4X which provides a watertight, dust-tight seal for harsh environments. The non-metallic bodies of the plugs and connectors provide excellent insulating, impact and UV resistant properties. The patented beryllium copper spring-pin design of the contacts maintains high unit pressure on mating sleeves. This ensures reliable electrical contact while minimizing heat rise. There are two styles of Insulgrip pin and sleeve devices. Style I devices achieve grounding by attaching the metallic shell to a ground terminal within the device. Style II devices feature redundant grounding by including an additional ground pin and sleeve to the grounding method used in Style I. The full Insulgrip line of devices is interchangeable with other manufacturers of UL1686 C1 devices which makes it ideal for use in industrial applications where multiple manufactures of product may be present.

Both the IEC and Insulgrip lines of pin and sleeve are used often in conjunction with mechanical interlocks. Mechanical interlocks prevent users from mating or breaking the circuit under load. This feature is critical to maintain a safe electrical connection. The interlocks are also available in reverse service applications where a generator is providing power to an electrical system.



### Circuit-Lock® Mechanical Interlocks

Hubbell's Circuit-Lock enclosure products virtually eliminate making or breaking the circuit under load. This revolutionary design incorporates a disconnect switch and receptacle in one compact non-metallic unit. They are available in either a fused or non-fused versions.



### Low Profile Devices

90° Angled plugs and recessed receptacles allow for connections in tight spaces. Cords can be controlled easily along the wall. The integrated cord grips limit strain on terminals and prevent strain on plugs and cables exiting perpendicular from the wall.



### Corrosion Resistant Devices

This superior grade of IEC and Insulgrip devices are ideal for the most demanding environments. Nickel-plated brass on the IEC and nickel-plated Tellurium copper on the Insulgrip contacts prevent corrosion and heat rise.



### Reverse Service

Generators and portable power distribution units require devices to deliver power in a reverse direction to power up a piece of equipment or building. Hubbell manufactures reverse service devices in both the IEC and Insulgrip Pin and Sleeve configurations as well as IEC Mechanical Interlock Inlets.



# IEC Pin and Sleeve IEC Configurations Chart

## Singly Rated Configurations

Hubbell Pin and Sleeve products are designed and manufactured to meet the International Standard IEC 60309-1 and IEC 60309-2. This device standard calls out a singly rated, non-interchangeable configuration for every voltage and type of service throughout the world. Pin and sleeve device housings are color coded by voltage rating.

## Voltage

The voltage is determined by the location of the female ground contact relative to the housing keyway. Simply by manufacturing the device with a ground contact in a certain "clock" position, the device will be rated for a particular voltage system. The diagram shows the keying position and the color coding that is associated with each voltage.

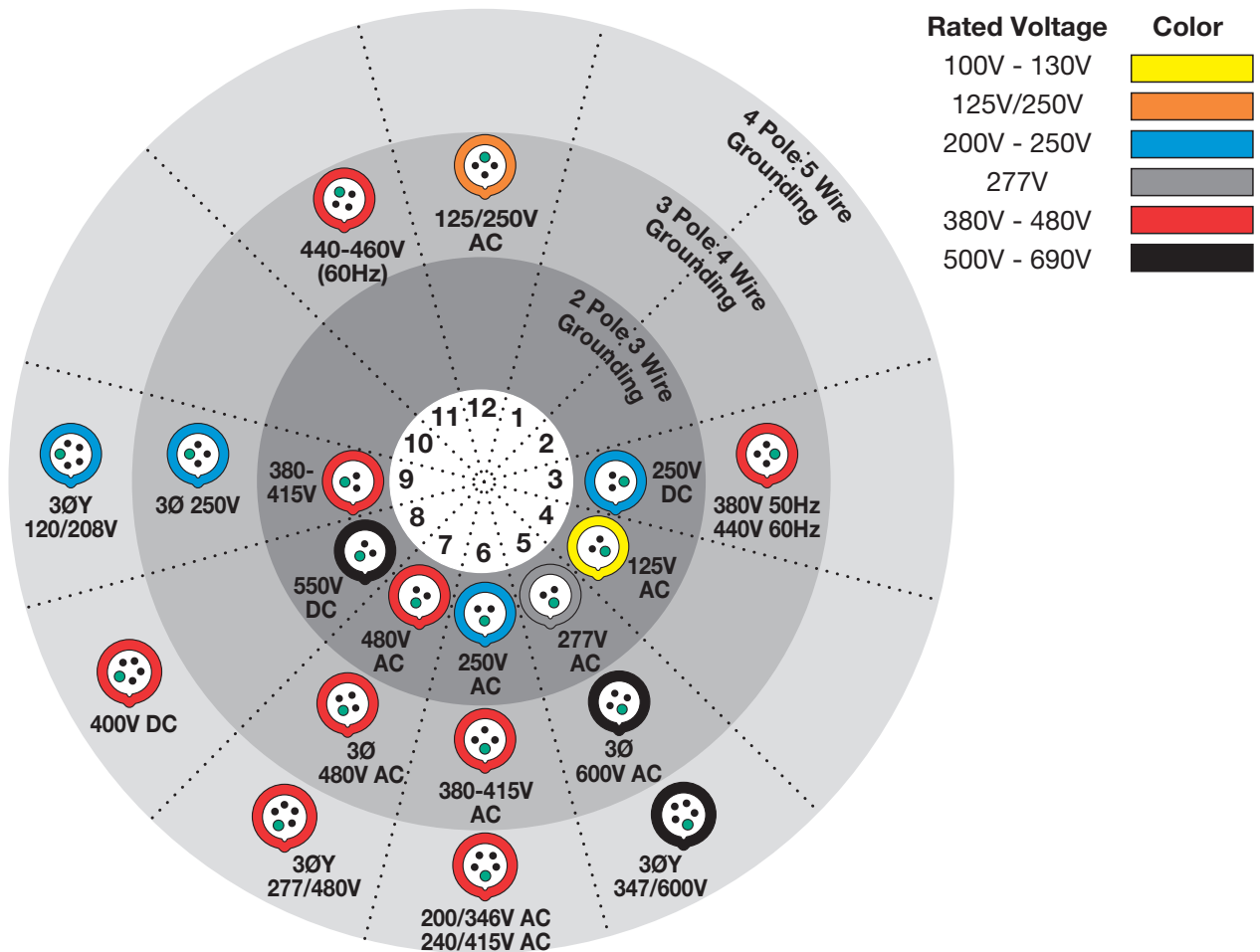

## Typical IEC Pin and Sleeve Catalog Number

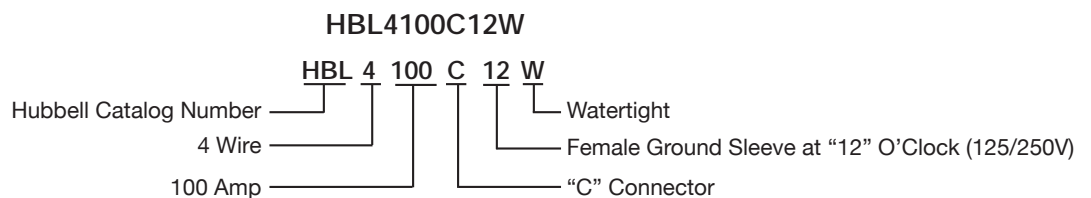

### Explanation

- |  |   |   |  |   |                                   |
|--|---|---|--|---|-----------------------------------|
| <p>1 (HBL) Designates Hubbell Catalog Number</p> | <p>2 First Digit<br/>3-3 wire<br/>4-4 wire<br/>5-5 wire</p> | <p>3 Next Series Of Digits Preceding a letter<br/>20-20 Amp<br/>30-30 Amp<br/>60-60 Amp<br/>100-100 Amp</p> | <p>4 Letter<br/>P-Plug<br/>R-Receptacle<br/>C-Connector<br/>B-Inlet<br/>MI-Mechanical Interlock<br/>MIF-Mechanical Interlock Fused</p> | <p>5 Last Digit(s)<br/>After the letter. This denotes the position of the ground sleeve and the assigned voltage in the receptacle as it relates to the hours of the clock. This is done to eliminate interchangeability between devices with different voltages.</p> | <p>6 Letter: W<br/>Watertight</p> |
|--|---|---|--|---|-----------------------------------|

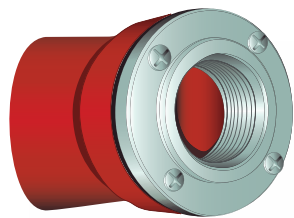

**Liquidtight Conduit Adapters**

Machined aluminum adapters are available to provide a means for attaching flexible liquidtight metal conduit to rear of Hubbell Pin and Sleeve plug or connector

**IP67**  
 SUITABILITY

**Self-Closing Gasketed Cover**

Detents into position to fully close automatically. Corrosion-resistant hardware



**Watertight Neoprene Sealing Glands**

Provide a reliable seal at the cable entry point. Prevents infiltration of contaminants

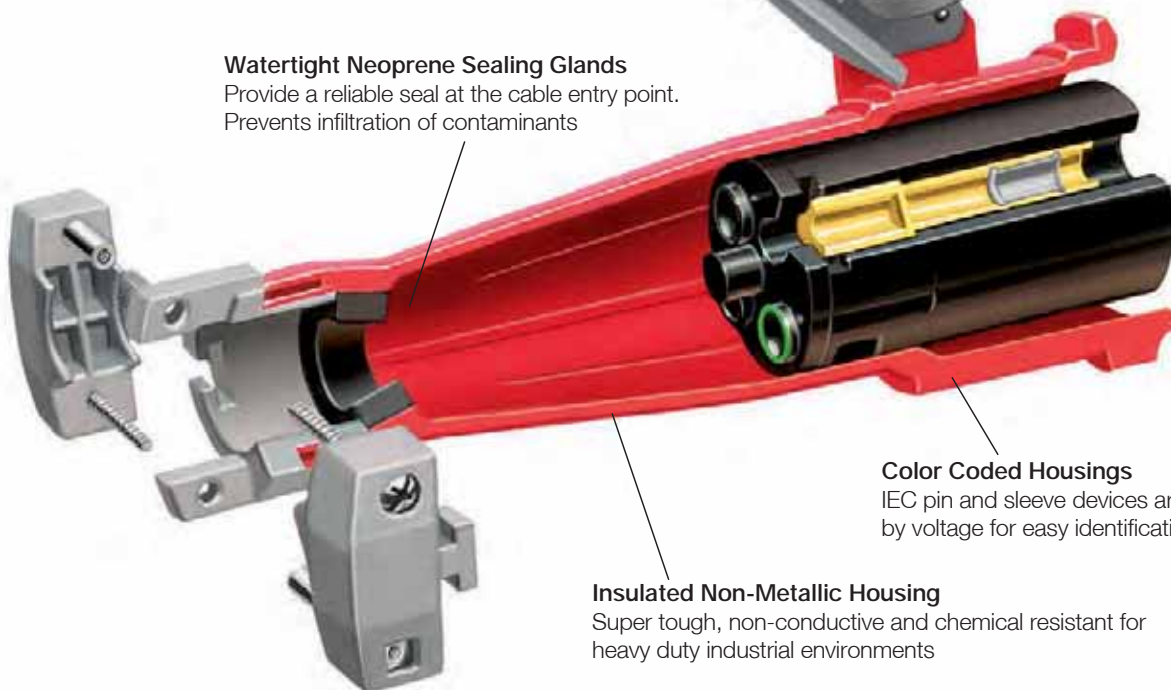

**Color Coded Housings**

IEC pin and sleeve devices are color coded by voltage for easy identification

**Insulated Non-Metallic Housing**

Super tough, non-conductive and chemical resistant for heavy duty industrial environments



**Powerful Mechanical Cord Grip**

Hubbell's design incorporates two molded-in teeth to securely grip the outer cable jacket, and internal conductors to prevent slippage and strain on terminations. Captive barrel nuts ease assembly and allow higher tightening torque for maximum cord retention.



**Watertight Cord Entrance**

The tapered bore entrance creates high compression forces on sealing gland, providing a watertight seal around cord. Individual solid neoprene glands are supplied to match a full range of cord sizes and assure watertight performance.



**Multi-Contact Spring**

(60/63 and 100/125 Amp) Recessed within the female sleeve, provides and maintains high unit pressure on mating pins to minimize temperature rise. Broaches oxide film to achieve low resistance contact for cooler operation.



**Sequential Contact Engagement**

Ground makes first and breaks last. Neutral makes second and breaks second (to prevent a momentary over-voltage on components connected phase to neutral). Phase contacts make last and break first.

# IEC Pin and Sleeve Watertight Devices

Features and Benefits



**IP67**  
SUITABILITY

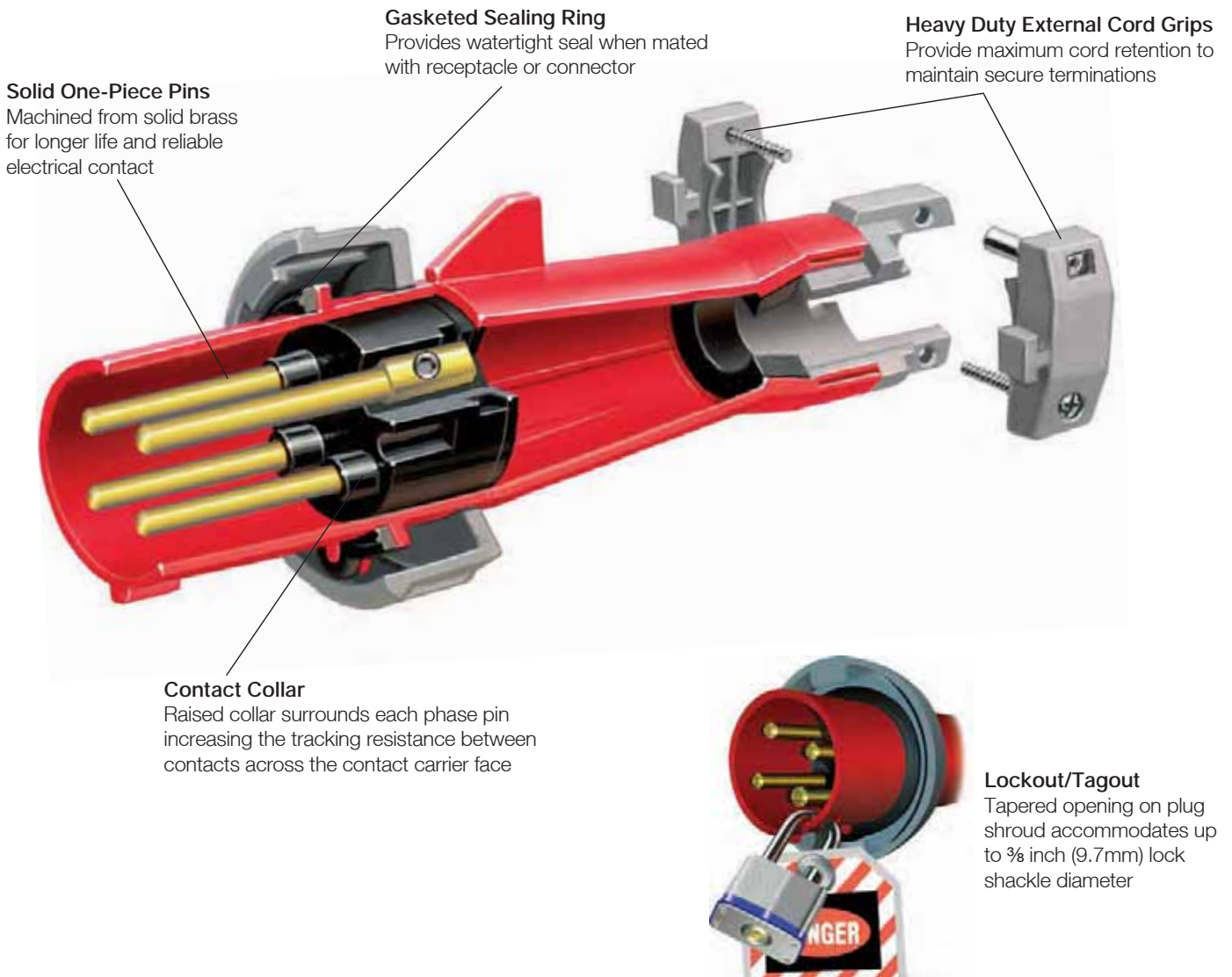

**Rugged One-Piece Housing**  
Thick wall construction protects internal components, eliminates joints preventing infiltration of contaminants. Amperage/voltage rating and catalog number molded in housing for easy identification.



**Shrouded Pins**  
Super tough plug shroud protects pins from deforming from physical abuse. Protects the user from the possibility of touching live contacts during insertion and withdrawal of mating parts.



**Swivel Pressure Pads**  
16/20 and 30/32 Amp devices feature patented swiveling pressure pad terminal screws and prevent damage to conductor strands. 60/63 and 100/125 Amp devices feature large hex-head stainless steel screws which provide higher torque levels for secure terminations. The large box terminals are designed for North American conductors.



**Thermoset Polyester Contact Carrier**  
Molded thermoset polyester provides high resistance to electrical tracking. Withstands higher temperatures which may result from overload or arcing. Thermoset properties provide dimensional stability for this critical assembly.

# IEC Pin and Sleeve Watertight Devices

20 and 30 Ampere – North American Ratings, 16 and 32 Ampere – International Ratings



**IP67**  
SUITABILITY

Rating					Watertight Devices				Accessories			Replacement Interiors	
Amps	Poles and Wires	Configuration Recep./ Conn.	Plug/ Inlet	AC Voltage	Receptacle	Plug	Connector	Inlet	Back Boxes		Closure Caps	Recep./ Conn.	Plug/ Inlet
									Non-Metallic	Metallic			
16	2P 3W			100–130V	HBL316R4W	HBL316P4W	HBL316C4W	HBL316B4W†	BB2030N	BB201W BB301W	PC320	IN320BF	IN320BM
	2P 3W			220–240V	HBL316R6W	HBL316P6W	HBL316C6W	HBL316B6W	BB2030N	BB201W BB301W	PC320	IN320BF	IN320BM
	3P 4W			380–415V	HBL416R6W	HBL416P6W	HBL416C6W	HBL416B6W†	BB2030N	BB201W BB301W	PC420	IN420DF	IN420DM
	4P 5W			220/380V 240/415V	HBL516R6W	HBL516P6W	HBL516C6W	HBL516B6W	BB2030N	BB201W BB301W	PC520	IN520EF†	IN520EM
20	2P 3W			125V	HBL320R4W	HBL320P4W	HBL320C4W	HBL320B4W	BB2030N	BB201W BB301W	PC320	IN320AF	IN320AM
	2P 3W			250V	HBL320R6W	HBL320P6W	HBL320C6W	HBL320B6W	BB2030N	BB201W BB301W	PC320	IN320BF	IN320BM
	2P 3W			480V	HBL320R7W	HBL320P7W	HBL320C7W	HBL320B7W	BB2030N	BB201W BB301W	PC320	IN320BF	IN320BM
	3P 4W			125/250V	HBL420R12W	HBL420P12W	HBL420C12W	HBL420B12W	BB2030N	BB201W BB301W	PC420	IN420CF	IN420CM
	3P 4W			3Ø 250V	HBL420R9W	HBL420P9W	HBL420C9W	HBL420B9W	BB2030N	BB201W BB301W	PC420	IN420DF	IN420DM
	3P 4W			3Ø 480V	HBL420R7W	HBL420P7W	HBL420C7W	HBL420B7W	BB2030N	BB201W BB301W	PC420	IN420DF	IN420DM
	3P 4W			3Ø 600V	HBL420R5W	HBL420P5W	HBL420C5W	HBL420B5W	BB2030N	BB201W BB301W	PC420	IN420DF	IN420DM
	4P 5W			3ØY 120/208V	HBL520R9W	HBL520P9W	HBL520C9W	HBL520B9W	BB2030N	BB201W BB301W	PC520	IN520EF†	IN520EM
	4P 5W			3ØY 277/480V	HBL520R7W	HBL520P7W	HBL520C7W	HBL520B7W	BB2030N	BB201W BB301W	PC520	IN520EF†	IN520EM
	4P 5W			3ØY 347/600V	HBL520R5W	HBL520P5W	HBL520C5W	HBL520B5W	BB2030N	BB201W BB301W	PC520	IN520EF†	IN520EM
30	2P 3W			125V	HBL330R4W	HBL330P4W	HBL330C4W	HBL330B4W	BB2030N	BB201W BB301W	PC3430	IN330AF	IN330AM†
	2P 3W			250V	HBL330R6W	HBL330P6W	HBL330C6W	HBL330B6W	BB2030N	BB201W BB301W	PC3430	IN330BF	IN330BM
	2P 3W			480V	HBL330R7W	HBL330P7W	HBL330C7W	HBL330B7W	BB2030N	BB201W BB301W	PC3430	IN330BF	IN330BM
	3P 4W			125/250V	HBL430R12W	HBL430P12W	HBL430C12W	HBL430B12W	BB2030N	BB201W BB301W	PC3430	IN430CF	IN430CM
	3P 4W			3Ø 250V	HBL430R9W	HBL430P9W	HBL430C9W	HBL430B9W	BB2030N	BB201W BB301W	PC3430	IN430DF	IN430DM
	3P 4W			3Ø 480V	HBL430R7W	HBL430P7W	HBL430C7W	HBL430B7W	BB2030N	BB201W BB301W	PC3430	IN430DF	IN430DM
	3P 4W			3Ø 600V	HBL430R5W	HBL430P5W	HBL430C5W	HBL430B5W	BB2030N	BB201W BB301W	PC3430	IN430DF	IN430DM
	4P 5W			3ØY 120/208V	HBL530R9W	HBL530P9W	HBL530C9W	HBL530B9W	BB2030N	BB201W BB301W	PC530	IN530EF	IN530EM
	4P 5W			3ØY 277/480V	HBL530R7W	HBL530P7W	HBL530C7W	HBL530B7W	BB2030N	BB201W BB301W	PC530	IN530EF	IN530EM
	4P 5W			3ØY 347/600V	HBL530R5W	HBL530P5W	HBL530C5W	HBL530B5W	BB2030N	BB201W BB301W	PC530	IN530EF	IN530EM
32	2P 3W			100–130V	HBL332R4W†	HBL332P4W†	HBL332C4W†	HBL332B4W†	BB2030N	BB201W BB301W	PC3430	IN330BF	IN330BM
	2P 3W			220–240V	HBL332R6W	HBL332P6W	HBL332C6W	HBL332B6W	BB2030N	BB201W BB301W	PC3430	IN330BF	IN330BM
	3P 4W			380–415V	HBL432R6W	HBL432P6W	HBL432C6W	HBL432B6W	BB2030N	BB201W BB301W	PC3430	IN430DF	IN430DM
	3P 4W			380V 50Hz 440V 60Hz	HBL432R3W	HBL432P3W	HBL432C3W	HBL432B3W†	BB2030N	BB201W BB301W	PC3430	IN430DF	IN430DM
	4P 5W			220/380V 240/415V	HBL532R6W	HBL532P6W	HBL532C6W	HBL532B6W	BB2030N	BB201W BB301W	PC530	IN530EF	IN530EM

Note: See page G-10 and G-11 for back boxes and accessories, G-12 and G-13 for product dimensions, G-14 and G-15 for product specifications and HP ratings.  
See page G-11 for closure caps, purchased separately. PC320, PC420, PC520, PC3430, PC530 are not UL or CSA.  
†Consult factory.

# IEC Pin and Sleeve Watertight Devices

60 and 100 Ampere – North American Ratings, 63 and 125 Ampere – International Ratings



**IP67**  
SUITABILITY

Rating					Watertight Devices				Accessories		Replacement Interiors		
Amps	Poles and Wires	Configuration Recept./ Conn.	Plug/ Inlet	AC Voltage	Receptacle	Plug	Connector	Inlet	Back Boxes		Closure Caps	Recept./ Conn.	Plug/ Inlet
									Non-Metallic	Metallic			
60	2P 3W			125V	HBL360R4W	HBL360P4W	HBL360C4W	HBL360B4W	BB60N	BB601W BB602W	PC60	IN360AF	IN360AM
	2P 3W			250V	HBL360R6W	HBL360P6W	HBL360C6W	HBL360B6W	BB60N	BB601W BB602W	PC60	IN360BF	IN360BM†
	2P 3W			480V	HBL360R7W	HBL360P7W	HBL360C7W	HBL360B7W	BB60N	BB601W BB602W	PC60	IN360BF	IN360BM†
	3P 4W			125/250V	HBL460R12W	HBL460P12W	HBL460C12W	HBL460B12W	BB60N	BB601W BB602W	PC60	IN460CF	IN460CM
	3P 4W			3Ø 250V	HBL460R9W	HBL460P9W	HBL460C9W	HBL460B9W	BB60N	BB601W BB602W	PC60	IN460DF	IN460DM
	3P 4W			3Ø 480V	HBL460R7W	HBL460P7W	HBL460C7W	HBL460B7W	BB60N	BB601W BB602W	PC60	IN460DF	IN460DM
	3P 4W			3Ø 600V	HBL460R5W	HBL460P5W	HBL460C5W	HBL460B5W	BB60N	BB601W BB602W	PC60	IN460DF	IN460DM
	4P 5W			3ØY 120/208V	HBL560R9W	HBL560P9W	HBL560C9W	HBL560B9W	BB60N	BB601W BB602W	PC60	IN560EF	IN560EM†
	4P 5W			3ØY 277/480V	HBL560R7W	HBL560P7W	HBL560C7W	HBL560B7W	BB60N	BB601W BB602W	PC60	IN560EF	IN560EM†
	4P 5W			3ØY 347/600V	HBL560R5W	HBL560P5W	HBL560C5W	HBL560B5W	BB60N	BB601W BB602W	PC60	IN560EF	IN560EM†
63	2P 3W			220–240V	HBL363R6W	HBL363P6W	HBL363C6W	HBL363B6W	BB60N	BB601W BB602W	PC60	IN360BFS	IN360BMS†
	3P 4W			380–415V	HBL463R6W	HBL463P6W	HBL463C6W	HBL463B6W	BB60N	BB601W BB602W	PC60	IN460DFS	IN460DMS
	4P 5W			220/380V 240/415V	HBL563R6W	HBL563P6W	HBL563C6W	HBL563B6W	BB60N	BB601W BB602W	PC60	IN560EFS†	IN560EMS
100	2P 3W			125V	HBL3100R4W	HBL3100P4W	HBL3100C4W	HBL3100B4W	BB100N	BB1001W BB1002W	PC100	IN3100AF	IN3100AM
	2P 3W			250V	HBL3100R6W	HBL3100P6W	HBL3100C6W	HBL3100B6W	BB100N	BB1001W BB1002W	PC100	IN3100BF	IN3100BM†
	2P 3W			480V	HBL3100R7W	HBL3100P7W	HBL3100C7W	HBL3100B7W	BB100N	BB1001W BB1002W	PC100	IN3100BF	IN3100BM†
	3P 4W			125/250V	HBL4100R12W	HBL4100P12W	HBL4100C12W	HBL4100B12W	BB100N	BB1001W BB1002W	PC100	IN4100CF†	IN4100CM
	3P 4W			3Ø 250V	HBL4100R9W	HBL4100P9W	HBL4100C9W	HBL4100B9W	BB100N	BB1001W BB1002W	PC100	IN4100DF	IN4100DM
	3P 4W			3Ø 480V	HBL4100R7W	HBL4100P7W	HBL4100C7W	HBL4100B7W	BB100N	BB1001W BB1002W	PC100	IN4100DF	IN4100DM
	3P 4W			3Ø 600V	HBL4100R5W	HBL4100P5W	HBL4100C5W	HBL4100B5W	BB100N	BB1001W BB1002W	PC100	IN4100DF	IN4100DM
	4P 5W			3ØY 120/208V	HBL5100R9W	HBL5100P9W*	HBL5100C9W	HBL5100B9W	BB100N	BB1001W BB1002W	PC100	IN5100EF	IN5100EM
	4P 5W			3ØY 277/480V	HBL5100R7W	HBL5100P7W	HBL5100C7W	HBL5100B7W	BB100N	BB1001W BB1002W	PC100	IN5100EF	IN5100EM
	4P 5W			3ØY 347/600V	HBL5100R5W	HBL5100P5W	HBL5100C5W	HBL5100B5W	BB100N	BB1001W BB1002W	PC100	IN5100EF	IN5100EM
125	2P 3W			220–240V	HBL3125R6W	HBL3125P6W	HBL3125C6W	HBL3125B6W	BB100N	BB1001W BB1002W	PC100	IN3100BFS†	IN3100BMS†
	3P 4W			380–415V	HBL4125R6W	HBL4125P6W	HBL4125C6W	HBL4125B6W	BB100N	BB1001W BB1002W	PC100	IN4100DFS	IN4100DMS
	4P 5W			220/380V 240/415V	HBL5125R6W	HBL5125P6W	HBL5125C6W	HBL5125B6W	BB100N	BB1001W BB1002W	PC100	IN5100EFS	IN5100EMS

Note: See page G-10 and G-11 for back boxes and accessories, G-12 and G-13 for product dimensions, G-14 and G-15 for product specifications and HP ratings.  
 All 63A and all 125A devices have pilot pins or contacts.  
 See page G-11 for closure caps, purchased separately. PC60 and PC100 are not UL or CSA.  
 \*See page G-12 for additional information on short housing plug. IP22 suitability - length 8.30" (210.8).  
 †Consult factory.

# IEC Pin and Sleeve Corrosion Resistant Devices

100 Ampere Devices

IP67  
SUITABILITY



## Devices that Withstand the Most Abusive Environments

Hubbell offers a superior grade of 100A IEC Pin and Sleeve designed for use in the most demanding environments. These devices feature nickel plated solid brass pins for long life and reliable electrical contact in the most corrosive environments. They have a high visibility yellow supertough nylon housing. The heavy duty external cord clamps provide maximum cord retention to maintain secure terminations. The screws and fasteners are made from stainless steel.



- Food Processing
- Factory
- Water Treatment
- Washdown
- Temporary Power
- Meat Packing
- Construction
- Agriculture
- Outdoor Entertainment

## Standard Service

Rating					Watertight Devices			Accessories		
Amps	Poles And Wires	Configuration Recep./ Conn.	Plug	AC Voltage	Receptacle	Plug	Connector	Back Boxes Non-Metallic	Back Boxes Metallic	Closure Caps
100	3P 4W			125/250V	M4100R12	M4100P12	M4100C12	BB100N	BB1001W BB1002W	PC100
	4P 5W			3ØY 120/208V	M5100R9	M5100P9	M5100C9	BB100N	BB1001W BB1002W	PC100
	4P 5W			3ØY 277/480V	M5100R7	M5100P7	M5100C7	BB100N	BB1001W BB1002W	PC100

## "Reverse Service"

Rating					Watertight Devices			Accessories		
Amps	Poles And Wires	Configuration Conn.	Inlet	AC Voltage	Inlet	Plug	Connector	Back Boxes Non-Metallic	Back Boxes Metallic	Closure Caps
100	3P 4W			125/250V	M4100B12R	—	M4100C12R	BB100N	BB1001W BB1002W	PC100
	4P 5W			3ØY 120/208V	M5100B9R	—	M5100C9R	BB100N	BB1001W BB1002W	PC100
	4P 5W			3ØY 277/480V	M5100B7R	—	M5100C7R	BB100N	BB1001W BB1002W	PC100

Note: See page Z-17 for corrosion resistant cord sets.

# IEC Pin and Sleeve Data Center Pin and Sleeve

**IP67**  
SUITABILITY



## DC Rated Pin and Sleeve Devices

In today's environmentally conscious world, energy savings is a pinnacle part of going green. DC (Direct Current) is being used to reduce power consumption and decrease the amount of infrastructure needed to energize specific types of data center equipment. Electrical devices provide a means of connecting DC power.

Hubbell is the first manufacturer to introduce a series of IEC Pin and Sleeve devices configured for the UL1686 eight o'clock ground position for DC voltage (Disconnecting use only). Hubbell's IEC DC rated pin and sleeve line has been qualified by UL to the requirements of DC voltage. The thermoset polyester contact carrier provide high resistance to electrical tracking, it withstands higher temperatures for this type of demanding application. The solid one-piece pins are machined from solid brass for longer life and reliable electrical contact. In addition, the heavy-duty external cord grips provide maximum cord retention to maintain secure terminations. Finally, the super tough, color coded, non-conductive V-0 rated Valox® housing is heavy duty for safety and protecting the internal components.



Rating					Watertight Devices		
Amps	Poles And Wires	Configuration Recep./ Conn.	Plug	DC Voltage	Receptacle	Plug	Connector
30	2P 3W			550V	HBL330R8WDC	HBL330P8V0DC	HBL330C8V0DC
60	2P 3W			550V	HBL360R8WDC*	HBL360P8V0DC	HBL360C8V0DC
100	2P 3W			550V	HBL3100R8WDC	HBL3100P8V0DC	HBL3100C8V0DC
	4P 5W			400V	HBL5100R8WDC	HBL5100P8V0DC	HBL5100C8V0DC

Note: \*Inlet available - HBL360B8WDC.

**IP67**  
SUITABILITY



## Dual Certified Pin and Sleeve Devices

Hubbell's dual certified pin and sleeve devices are ideal for the data center and high tech server industry. They are UL Listed to UL1682 for the North American market and are TUV Rheinland Certified for the European and International market. Customers can use the same plug and connector for multiple electrical configurations. They reduce the number of SKU's end users have to use if they sell to both domestic and overseas customers. These devices are IP67 rated, RoHs compliant and showcase all the inherent safety benefits of their V-0 rated Valox® housing and internal components.

Rating					Watertight Devices			
Amps	Poles And Wires	Configuration Recep./ Conn.	Plug	AC Voltage	Receptacle	Plug	Connector	Inlet
30/32	3P 4W			380-415V	HBL430R6V02	HBL430P6V02	HBL430C6V02	HBL430B6V02
	4P 5W			200/346V 240/415V	HBL530R6V02	HBL530P6V02	HBL530C6V02	HBL530B6V02
60/63	3P 4W			380-415V	HBL460R6V02	HBL460P6V02	HBL460C6V02	HBL460B6V02
	4P 5W			200/346V 240/415V	HBL560R6V02	HBL560P6V02	HBL560C6V02	HBL560B6V02

Valox® is a trademark of SABIC Innovative Plastics, acquired from General Electric Company.



BB60N



BB601W



FW6010055



FT202W



FW60100



HBL2030AP



AA2030PS

## Back Boxes

Hubbell manufactures an extensive line of back boxes for use with IEC Pin and Sleeve devices. Each back box is designed to give the user the maximum amount of wiring room while achieving grounding to metallic conduit. Hubbell back boxes are available in non-metallic and cast metal versions.

### Non-Metallic 15° Angle Back Box

Description	NPT Hub Size*	Catalog Number
Back box for 16, 20, 30 and 32A devices.	1"	BB2030N
Back box for 60 and 63A devices.	1¼"	BB60N
Back box for 100 and 125A devices.	1½"	BB100N

Note: \*Hub is not included; order one of the following Racco® part numbers: 1 in. = 1704, 1¼ in. = 1705, 1½ in. = 1706. These boxes meet IP67 requirements and Type 4X requirements when installed with a watertight conduit hub.

### Metallic 15° Angle Back Box\*\*

Description	NPT Hub Size	Catalog Number
Back box for 16, 20, 30 and 32A devices.	¾"	BB201W
	1"	BB301W
Back box for 60 and 63A devices.	1¼"	BB601W
	1½"	BB602W
Back box for 100 and 125A devices.	1½"	BB1001W
	2"	BB1002W

Note: \*\*These boxes are cast aluminum, suitable for IP56 requirements and are finished with enamel paint.

### Metallic 55° Angle Back Box and Adapter\*\*

Description	NPT Hub Size	Catalog Number
Feed-thru box back box and adapter for 16, 20, 30 and 32A devices.	1"	AB203055
Angle adapter only.		AA203055
Back box and adapter for 60, 63, 100 and 125A devices.	1½"	FW6010055
Angle adapter only.		AA6010055

Note: \*\*These boxes are cast aluminum, suitable for IP56 requirements and are finished with enamel paint.

### Metallic Feed-Thru Back Box\*\*

Description	NPT Hub Size	Catalog Number
Feed-thru box for 16, 20, 30 and 32A devices.	¾"	FT202W
	1"	FT302W

Note: \*\*These boxes are cast aluminum, suitable for IP56 requirements and are finished with enamel paint.

### Metallic Four-Way 15° Angle Back Box\*\*

Description	NPT Hub Size	Catalog Number
Four-way box for 60, 63, 100 and 125A devices.	1½"	FW60100

Note: \*\*These boxes are cast aluminum, suitable for IP56 requirements and are finished with enamel paint.

### Straight Wall Box Adapter

Description	Catalog Number
Adapts 16, 20, 30 and 32A Watertight IEC Pin and Sleeve devices to 2-gang, device boxes and FD boxes.	HBL2030AP

### Angle Wall Box Adapter

Description	Catalog Number
Adapts 16, 20, 30 and 32A Watertight IEC Pin and Sleeve devices to standard wall boxes.	AA2030PS

Note: Adapts 20 and 30A Watertight Pin and Sleeve receptacle to single, 2-gang standard wall box and 4 or 4¼ inch square for non-watertight applications.



# IEC Pin and Sleeve Accessories

## Closure Caps

Cap assemblies provide watertight sealing to a disconnected male IEC Pin and Sleeve plug or inlet. Manufactured of the same tough non-metallic material as the watertight IEC Pin and Sleeve devices for corrosion and abuse resistance.

Description	Catalog Number
Fits all 16 and 20A, 3 wire plugs and inlets.	PC320
Fits all 16 and 20A, 4 wire plugs and inlets.	PC420
Fits all 16 and 20A, 5 wire plugs and inlets.	PC520
Fits all 30 and 32A, 3 and 4 wire plugs and inlets.	PC3430
Fits all 30 and 32A, 5 wire plugs and inlets.	PC530
Fits all 60 and 63A plugs and inlets.	PC60
Fits all 100 and 125A plugs and inlets.	PC100



PC3430

## Cover Assemblies

Replacement cover assemblies for use with watertight connector bodies and receptacles. Kit contains cover, arm assembly and installation tool.

Description	Catalog Number
Fits all 16 and 20A, 3 wire watertight female devices.	CA320
Fits all 16 and 20A, 4 wire watertight female devices.	CA420
Fits all 16 and 20A, 5 wire watertight female devices.	CA520
Fits all 30 and 32A, 3 and 4 wire watertight female devices.	CA3430
Fits all 30 and 32A, 5 wire watertight female devices.	CA530
Fits all 60 and 63A watertight female devices.	CA60
Fits all 100 and 125A watertight female devices.	CA100



CA3430

## Cord Clamp and Locking Ring

Replacement cord clamp and locking ring for use with IEC plugs, connectors and inlets.

Description	Cord Clamp and Locking Ring	Locking Ring Only
Fits all 16 and 20A, 3 wire plugs, connectors and inlets.	CC320	LR320*
Fits all 16 and 20A, 4 wire plugs, connectors and inlets.	CC420	LR420*
Fits all 16 and 20A, 5 wire plugs, connectors and inlets.	CC520†	LR520*
Fits all 30 and 32A, 3 and 4 wire plugs, connectors and inlets.	CC3430	LR3430*
Fits all 30 and 32A, 5 wire plugs, connectors and inlets.	CC530†	LR530*
Fits all 60 and 63A plugs, connectors and inlets.	CC60	LR60*
Fits all 100 and 125A plugs, connectors and inlets.	CC100	LR100*

Note: \*Locking Ring only for plugs and inlets.  
†Consult factory.



CC3430

LR3430

## Liquidtight Adapters

Machined aluminum adapters are available to provide a means for attaching flexible liquidtight metal conduit to rear of a Hubbell Pin and Sleeve plug or connector. To install, remove cord grip and two gland cap screws. Use screws to attach adapter. Kellems® liquidtight conduit connectors are available to control arc of bend and to prevent conduit pull-out where vibration, motion or strain is present. These grips interface directly with Hubbell's liquidtight adapters and are available in a wide variety of NPT sizes and configurations. Consult your local code grounding requirements before using liquidtight adapters.

Rating of Hubbell Pin and Sleeve Device	Liquidtight Conduit Size	Hubbell Liquidtight Adapter	Optional Kellems Liquidtight Conduit Grip
16 and 20 Amp 3 and 4 Wire	½" NPT	SAA12	074093402
	¾" NPT	SAA34	074093403
16 and 20 Amp 5 wire and 30 and 32 Amp 3 and 4 wire	½" NPT	SAB12	074093402
	¾" NPT	SAB34	074093403
	1" NPT	SAB100	074093404
30 and 32 Amp 5 wire	¾" NPT	SAC34	074093403
30 and 32 Amp 5 wire and 60 and 63 Amp (all)	1" NPT	SAC100	074093404
	1¼" NPT	SAC125	074093405
100 and 125 Amp (all)	1¼" NPT	SAD125	074093405
	1½" NPT	SAD150	074093406



SAB34



074093403

# IEC Pin and Sleeve Dimensions

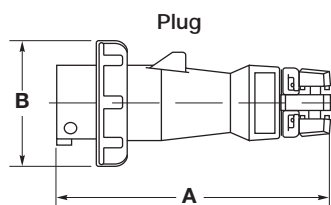

## Plug Dimensions

Type	A	B	Cord Grip Range
HBL320P	6.61" (167.8)	2.87" (73.0)	.330"-.830" (8.4-21.1)
HBL420P	7.00" (177.8)	3.19" (81.0)	.330"-.830" (8.4-21.1)
HBL520P	7.65" (194.3)	3.50" (89.0)	.330"-.830" (8.4-21.1)
HBL330P	8.05" (204.5)	3.74" (95.0)	.375"-1.250" (9.5-31.8)
HBL430P	8.05" (204.5)	3.74" (95.0)	.375"-1.250" (9.5-31.8)
HBL530P	8.54" (216.9)	4.02" (102.0)	.500"-1.450" (12.7-36.8)
HBL360P, HBL460P, HBL560P	10.15" (257.8)	4.49" (114.0)	.500"-1.450" (12.7-36.8)
HBL3100P, HBL4100P, M4100P, HBL5100P, M5100P	12.63" (320.8)	4.92" (125.0)	1.065"-1.940" (27.1-49.3)

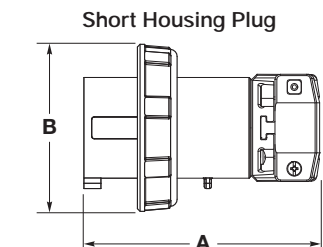

## Short Housing Plug Dimensions

Type	A	B	Cord Grip Range
HBL5100P9WSH	8.30" (210.82)	4.92" (125.0)	1.065"-1.940" (27.1-49.3)

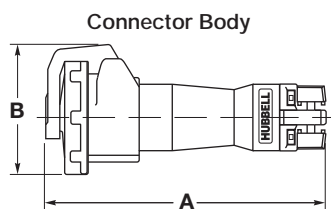

## Connector Body Dimensions

Type	A	B	Cord Grip Range
HBL320C	7.49" (190.3)	3.33" (84.6)	.330"-.830" (8.4-21.1)
HBL420C	7.90" (200.6)	3.66" (93.0)	.330"-.830" (8.4-21.1)
HBL520C	8.54" (216.9)	3.94" (100.0)	.330"-.830" (8.4-21.1)
HBL330C	9.05" (229.9)	4.27" (108.5)	.375"-1.250" (9.5-31.8)
HBL430C	9.05" (229.9)	4.27" (108.5)	.375"-1.250" (9.5-31.8)
HBL530C	9.68" (245.8)	4.70" (119.5)	.500"-1.450" (12.7-36.8)
HBL360C, HBL460C, HBL560C	11.15" (283.2)	5.10" (129.5)	.500"-1.450" (12.7-36.8)
HBL3100C, HBL4100C, M4100C, HBL5100C, M5100C	13.57" (344.7)	5.71" (145)	1.065"-1.940" (27.1-49.3)

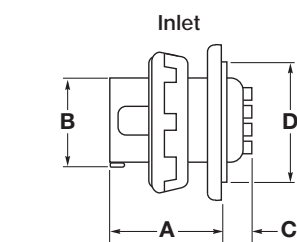

## Inlet Dimensions

Type	A	B	C	D	E	F
HBL320B	2.54" (64.5)	1.85" (47.0)	1.14" (29.0)	2.72" (69.0)	3.75" (95.3)	3.13" (79.5)
HBL420B	2.54" (64.5)	2.11" (53.6)	1.14" (29.0)	2.72" (69.0)	3.75" (95.3)	3.13" (79.5)
HBL520B	2.54" (64.5)	2.41" (61.2)	1.14" (29.0)	2.72" (69.0)	3.75" (95.3)	3.13" (79.5)
HBL330B	2.99" (76.0)	2.49" (63.2)	1.04" (26.5)	2.72" (69.0)	3.75" (95.3)	3.13" (79.5)
HBL430B	2.99" (76.0)	2.49" (63.2)	1.04" (26.5)	2.72" (69.0)	3.75" (95.3)	3.13" (79.5)
HBL530B	2.99" (76.0)	2.75" (69.9)	1.04" (26.5)	2.80" (71.0)	3.75" (95.3)	3.13" (79.5)
HBL360B, HBL460B, HBL560B	4.04" (102.6)	2.97" (75.5)	1.18" (30.0)	3.46" (88.0)	4.50" (114.3)	3.88" (98.5)
HBL3100B, HBL4100B, M4100B, HBL5100B, M5100B	4.53" (115)	3.44" (87.5)	1.95" (49.5)	3.94" (100.0)	5.50" (139.7)	4.88" (124.0)

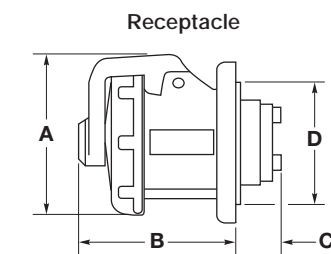
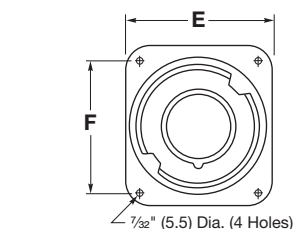

## Receptacle Dimensions

Type	A	B	C	D	E	F
HBL320R	3.33" (84.5)	2.78" (70.6)	1.02" (26.0)	2.72" (69.0)	3.75" (95.3)	3.13" (79.5)
HBL420R	3.66" (93.0)	2.78" (70.6)	1.02" (26.0)	2.72" (69.0)	3.75" (95.3)	3.13" (79.5)
HBL520R	3.94" (100.0)	2.78" (70.6)	1.02" (26.0)	2.72" (69.0)	3.75" (95.3)	3.13" (79.5)
HBL330R	4.27" (108.5)	3.09" (78.5)	1.16" (29.5)	2.72" (69.0)	3.75" (95.3)	3.13" (79.5)
HBL430R	4.27" (108.5)	3.09" (78.5)	1.16" (29.5)	2.72" (69.0)	3.75" (95.3)	3.13" (79.5)
HBL530R	4.70" (119.4)	3.09" (78.5)	1.16" (29.5)	2.83" (71.9)	3.75" (95.3)	3.13" (79.5)
HBL360R, HBL460R, HBL560R	5.10" (129.5)	4.07" (103.4)	1.69" (43.0)	3.46" (88.0)	4.50" (114.3)	3.88" (98.6)
HBL3100R, HBL4100R, M4100R, HBL5100R, M5100R	5.71" (145)	4.23" (107.4)	2.46" (62.5)	3.95" (100.3)	5.50" (139.7)	4.88" (123.9)

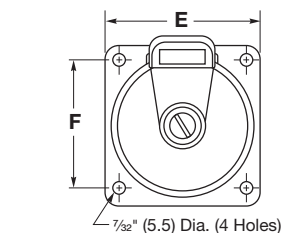

Note: 20, 30, 60 and 100A devices are dimensionally equivalent to 16, 32, 63 and 125A devices, respectively.

Dimensions in Inches (mm)

# IEC Pin and Sleeve Dimensions

## Non-Metallic 15° Angle Back Box

Description	NPT Hub Size	A Inch (mm)	B Inch (mm)	C Inch (mm)	D Inch (mm)	E Inch (mm)	F Inch (mm)	Cubic Inch Capacity	Catalog Number
Back box for 16, 20, 30 & 32A devices.	1"	5.67" (144.0)	4.44" (112.8)	4.05" (102.9)	3.91" (99.3)	2.35" (59.7)	4.92" (125.0)	30.00"	<b>BB2030N</b>
Back box for 60 & 63A devices.	1¼"	7.76" (197.0)	5.16" (131.0)	5.87" (149.0)	4.72" (120.0)	2.99" (76.0)	6.94" (176.0)	70.00"	<b>BB60N</b>
Back box for 100 & 125A devices.	1½"	8.21" (209.0)	6.23" (158.0)	6.31" (160.3)	5.71" (145.0)	3.99" (101.0)	7.41" (188.0)	120.00"	<b>BB100N</b>

Note: \*Hub is not included; order one of the following Racor® part numbers: 1 inch = 1704, 1¼ inch = 1705, 1½ inch = 1706. These boxes meet IP67 requirement and Type 4X requirements when installed with a watertight conduit hub.

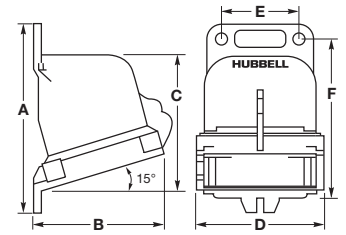

Non-Metallic Angle Box

## Metallic 15° Angle Back Box

Description	NPT Hub Size	A Inch (mm)	B Inch (mm)	C Inch (mm)	D Inch (mm)	E Inch (mm)	F Inch (mm)	Cubic Inch Capacity	Catalog Number
Back box for 16, 20, 30 & 32A devices.	¾"	5.12" (130.2)	4.00" (101.6)	4.19" (106.4)	3.75" (95.3)	3.00" (76.2)	4.00" (101.6)	30.00"	<b>BB201W</b>
Back box for 16, 20, 30 & 32A devices.	1"	5.12" (130.2)	4.00" (101.6)	4.19" (106.4)	3.75" (95.3)	3.00" (76.2)	4.00" (101.6)	30.00"	<b>BB301W</b>
Back box for 60 & 63A devices.	1¼"	7.25" (184.2)	5.25" (133.4)	6.00" (152.4)	4.50" (114.3)	3.75" (95.3)	6.19" (157.2)	80.00"	<b>BB601W</b>
Back box for 60 & 63A devices.	1½"	7.25" (184.2)	5.25" (133.4)	6.00" (152.4)	4.50" (114.3)	3.75" (95.3)	6.19" (157.2)	80.00"	<b>BB602W</b>
Back box for 100 & 125A devices.	1½"	8.12" (206.4)	6.75" (171.5)	6.88" (174.6)	5.50" (139.7)	4.75" (120.7)	6.94" (176.2)	130.00"	<b>BB1001W</b>
Back box for 100 & 125A devices.	2"	8.12" (206.4)	6.75" (171.5)	6.88" (174.6)	5.50" (139.7)	4.75" (120.7)	6.94" (176.2)	130.00"	<b>BB1002W</b>

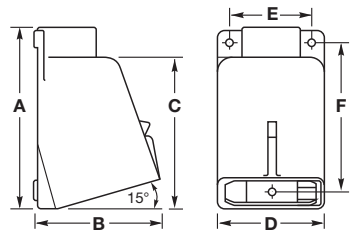

Metallic 15° Angle Box

## Metallic 55° Angle Back Box and Adapter

Description	NPT Hub Size	A Inch (mm)	B Inch (mm)	C Inch (mm)	D Inch (mm)	E Inch (mm)	F Inch (mm)	Cubic Inch Capacity	Catalog Number
Feed-thru box and angle adapter for 16, 20, 30 & 32A devices.	1"	6.80" (172.4)	6.60" (167.0)	5.63" (142.9)	4.50" (114.3)	3.74" (95.0)	-	42.27"	<b>AB203055</b>
Angle adapter for 16, 20, 30 & 32A devices.	-	4.89" (124.3)	3.33" (84.6)	4.29" (109.0)	3.75" (95.2)	2.50" (63.5)	-	25.00"	<b>AA203055</b>
Back box and angle adapter for 60, 63, 100 & 125A devices.	1½"	8.50" (215.9)	8.00" (202.9)	7.75" (196.8)	6.90" (174.8)	6.00" (152.4)	-	100.00"	<b>FW6010055</b>
Angle adapter for 60, 63, 100 & 125A devices.	-	6.75" (171.4)	4.48" (113.7)	6.00" (152.4)	6.75" (171.4)	6.00" (152.4)	-	79.00"	<b>AA6010055</b>

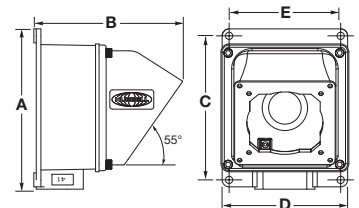

Metallic 55° Angle Box

## Metallic Feed-Thru Back Box

Description	NPT Hub Size	A Inch (mm)	B Inch (mm)	C Inch (mm)	D Inch (mm)	E Inch (mm)	F Inch (mm)	Cubic Inch Capacity	Catalog Number
Feed-thru box for 16, 20, 30 & 32A devices.	¾"	8.25" (209.6)	3.06" (77.8)	7.14" (181.4)	4.50" (114.3)	3.75" (95.3)	3.13" (79.5)	48.00"	<b>FT202W</b>
Feed-thru box for 16, 20, 30 & 32A devices.	1"	8.25" (209.6)	3.06" (77.8)	7.14" (181.4)	4.50" (114.3)	3.75" (95.3)	3.13" (79.5)	48.00"	<b>FT302W</b>

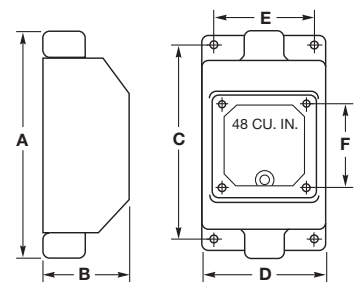

Metallic Feed-Thru Box

## Metallic Four-Way 15° Angle Back Box

Description	NPT Hub Size	A Inch (mm)	B Inch (mm)	C Inch (mm)	D Inch (mm)	E Inch (mm)	F Inch (mm)	Cubic Inch Capacity	Catalog Number
Four-way box for 60, 63, 100 & 125A devices.	1½"	8.75" (222.3)	9.75" (247.7)	7.75" (196.9)	6.75" (171.5)	6.00" (152.4)	-	210.00"	<b>FW60100</b>

Note: These boxes are cast aluminum, suitable for IP56 requirements and are finished with enamel paint. These boxes withstand a 500-hour salt spray test as well as UL rain tight and external icing test.

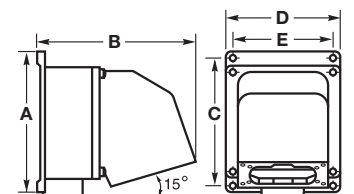

Metallic Four-Way Angle Box

Dimensions in Inches (mm)

# IEC Pin and Sleeve Listings and Specifications

IEC Pin and Sleeve Inlet, Connector Body, Plug and Receptacle

## Watertight Materials

Part	Material
<b>Inlet</b>	
Housing	Zytel® 101 Nylon*
Locking Ring	Reinforced Thermoplastic Polyester
Mounting Flange	Zytel® 101 Nylon
Mounting Screws	Stainless Steel (300 Series)
Contact Carrier	High-Impact Thermoset
Retainer	High-Impact Thermoset
Ground, Phase Pins	Brass (M-Series - Nickel-plated brass)
Terminal Screws	Stainless Steel (300 Series)
Assembly Screws (2)	Stainless Steel (300 Series)
Gaskets	Solid Neoprene
<b>Connector Body</b>	
Housing	Zytel® ST801 Nylon
Cord Clamps	Reinforced Thermoplastic Polyester
Glands	Solid Neoprene
Cover Arms	Reinforced Thermoplastic Polyester
Arm Springs	Stainless Steel (17-7 type)
Covers	Reinforced Thermoplastic Polyester
Cover Screw	Nickel-plated brass
Rotating Sealing Disc	Polycarbonate
Gaskets	Solid Neoprene
Contact Carrier	High-Impact Thermoset
Retainer	High-Impact Thermoset
Phase, Ground Sleeves	Brass
Sleeve Spring	20A and 30A Stainless Steel (300 Series); others are Beryllium Copper multi-contact inserts with silver plating
Terminal Screws	Stainless Steel (300 Series)
Assembly Screws	Stainless Steel (300 Series)
<b>Plug</b>	
Housing	Zytel® ST801 Nylon
Locking Ring	Reinforced Thermoplastic Polyester
Sealing Gasket	Solid Neoprene
Cord Clamp	Reinforced Thermoplastic Polyester
Gland Cap	Reinforced Thermoplastic Polyester
Gland	Solid Neoprene
Cord Clamp Screws	Stainless Steel (300 Series)
Clamp Nut	Nickel-Plated Brass
Gland Clamp Screws	Stainless Steel (300 Series)
Contact Carrier	High-Impact Thermoset
Retainer	High-Impact Thermoset
Ground, Phase Pins	Brass (M-Series - Nickel-plated brass)
Terminal Screws	Stainless Steel (300 Series)
Assembly Screws	Stainless Steel (300 Series)
<b>Receptacle</b>	
Housing	Zytel® 101 Nylon
Mounting Flange	Zytel® 101 Nylon
Arm Spring	Stainless Steel (17-7 type)
Cover Arm	Reinforced Thermoplastic Polyester
Cover	Reinforced Thermoplastic Polyester
Cover Screw	Nickel-plated brass
Rotating Sealing Disc	Polycarbonate
Gaskets	Solid Neoprene
Mounting Screws	Stainless Steel (300 Series)
Terminal Screws	Stainless Steel (300 Series)
Phase, Ground Sleeves	Brass
Sleeve Spring	20A and 30A Stainless Steel (300 Series); others are Beryllium Copper multi-contact inserts with silver plating

Listed to standard UL1682/CSA C22.2 No. 182.1-02, Plugs, Receptacles and cable connectors of the Pin and Sleeve Type.

UL Classified to IEC Standards 60309-1 (Plugs, Socket Outlets, and Couplers for Industrial Purposes) for Series I (European) rated voltages and services.

When used with cord, these devices require no further investigation by UL for equipment Classification to IEC 435 or IEC 380.

## Specifications

Typical Specification	
Manufacturer's Identification	Hubbell HBL520P9W
Description	Plug, Power Supply
Type	3 Pole + Neutral + Earth
Rating	20A, 120/208V AC, 3 Phase WYE
Configuration	UL 1686 C2, IEC 60309-2, Clock Position 9, Watertight
Certification	UL Listed, File E146032 Receptacles and Inlets, E146033 Plugs and Connectors, UL Standard UL1682 and UL 1686C2, CSA Certified File LR280C for Plugs, Connectors Inlets and LR285C for Receptacle CSA Standard C22.2 No. 182.1, UL Classified to IEC 60309-1 IEC 60309-2

Note: \*All devices on page G-9 have Valox® housings.

® Zytel is registered trademark of E.I. DuPont.

Valox® is a trademark of SABIC Innovative Plastics, acquired from General Electric Company.

# IEC Pin and Sleeve Specifications and Horsepower Ratings

## Performance

Electrical	
Dielectric Withstand Voltage	3000V AC.
Max. Working Voltage	600V RMS (i.e., minimum creepage distance 10 millimeters, minimum clearance 8 millimeters, per IEC 60309-1 for devices rated over 500V).
Current Interrupting	Certified for current interrupting at full rated current (Except DC rated devices).
Temperature Rise	Max. 30°C temperature rise at full rated current after 50 cycles of overload at 150% of rated current at a power factor of 75%.
Endurance	5,000 connect and disconnect cycles with load for 16A and 20A, 1,000 cycles with load and 1,000 cycles without load for 30A, 32A, 60A and 63A, and 250 cycles with load and 250 cycles without load for 100A and 125A.
Mechanical	
Impact Resistance	Per CSA C22.2 No. 182.1 / UL1682.
Cord Grip Cable Retention	Per CSA C22.2 No. 182.1 / UL1682.
Cord Accommodation	Round portable service cords of diameters commensurate with the device rating as defined in UL Standard 62, CSA C22.2 No. 49 and the harmonized <HAR> European Standards.
Terminal Identification	Terminals identified in accordance with North American and IEC conventions.
Product Identification	Identification and ratings are a permanent part of the device housing.
Environmental	
Moisture Resistance	Watertight per IEC 60309-1.
Ingress Protection	IP67 Suitability.
Flammability	HB or better per UL 94 or CSA C22.2 No. 0.17.
Operating Temperatures	Maximum Continuous 75°C; Minimum - 40°C without impact.
Materials	
Housings	Nylon.
All Other Materials	Resistant to corrosion and chemical attack.

Note: Specification sheets for all other Pin and Sleeve catalog numbers are available upon request.

## Horsepower Ratings for IEC Pin and Sleeve

AC Voltage Rating	Horsepower	Catalog Number			
3Ø 250	2	HBL420R9W	HBL420P9W	HBL420C9W	HBL420B9W
3Ø 480	5	HBL420R7W	HBL420P7W	HBL420C7W	HBL420B7W
3Ø 600	7.5	HBL420R5W	HBL420P5W	HBL420C5W	HBL420B5W
3ØY 120/208	.5	HBL520R9W	HBL520P9W	HBL520C9W	HBL520B9W
3ØY 277/480	5	HBL520R7W	HBL520P7W	HBL520C7W	HBL520B7W
3ØY 347/600	7.5	HBL520R5W	HBL520P5W	HBL520C5W	HBL520B5W
3Ø 250	3	HBL430R9W	HBL430P9W	HBL430C9W	HBL430B9W
3Ø 480	7.5	HBL430R7W	HBL430P7W	HBL430C7W	HBL430B7W
3Ø 600	10	HBL430R5W	HBL430P5W	HBL430C5W	HBL430B5W
3ØY 120/208	2	HBL530R9W	HBL530P9W	HBL530C9W	HBL530B9W
3ØY 277/480	7.5	HBL530R7W	HBL530P7W	HBL530C7W	HBL530B7W
3ØY 347/600	10	HBL530R5W	HBL530P5W	HBL530C5W	HBL530B5W
3Ø 250	5	HBL460R9W	HBL460P9W	HBL460C9W	HBL460B9W
3Ø 480	10	HBL460R7W	HBL460P7W	HBL460C7W	HBL460B7W
3Ø 600	15	HBL460R5W	HBL460P5W	HBL460C5W	HBL460B5W
3ØY 120/208	3	HBL560R9W	HBL560P9W	HBL560C9W	HBL560B9W
3ØY 277/480	10	HBL560R7W	HBL560P7W	HBL560C7W	HBL560B7W
3ØY 347/600	15	HBL560R5W	HBL560P5W	HBL560C5W	HBL560B5W
3Ø 250	10	HBL4100R9W	HBL4100P9W	HBL4100C9W	HBL4100B9W
3Ø 480	30	HBL4100R7W	HBL4100P7W	HBL4100C7W	HBL4100B7W
3Ø 600	30	HBL4100R5W	HBL4100P5W	HBL4100C5W	HBL4100B5W
3ØY 120/208	10	HBL5100R9W	HBL5100P9W	HBL5100C9W	HBL5100B9W
3ØY 277/480	30	HBL5100R7W	HBL5100P7W	HBL5100C7W	HBL5100B7W
3ØY 347/600	30	HBL5100R5W	HBL5100P5W	HBL5100C5W	HBL5100B5W

# IEC Pin and Sleeve Unfused Circuit-Lock® Pin and Sleeve Mechanical Interlocks

Features and Benefits

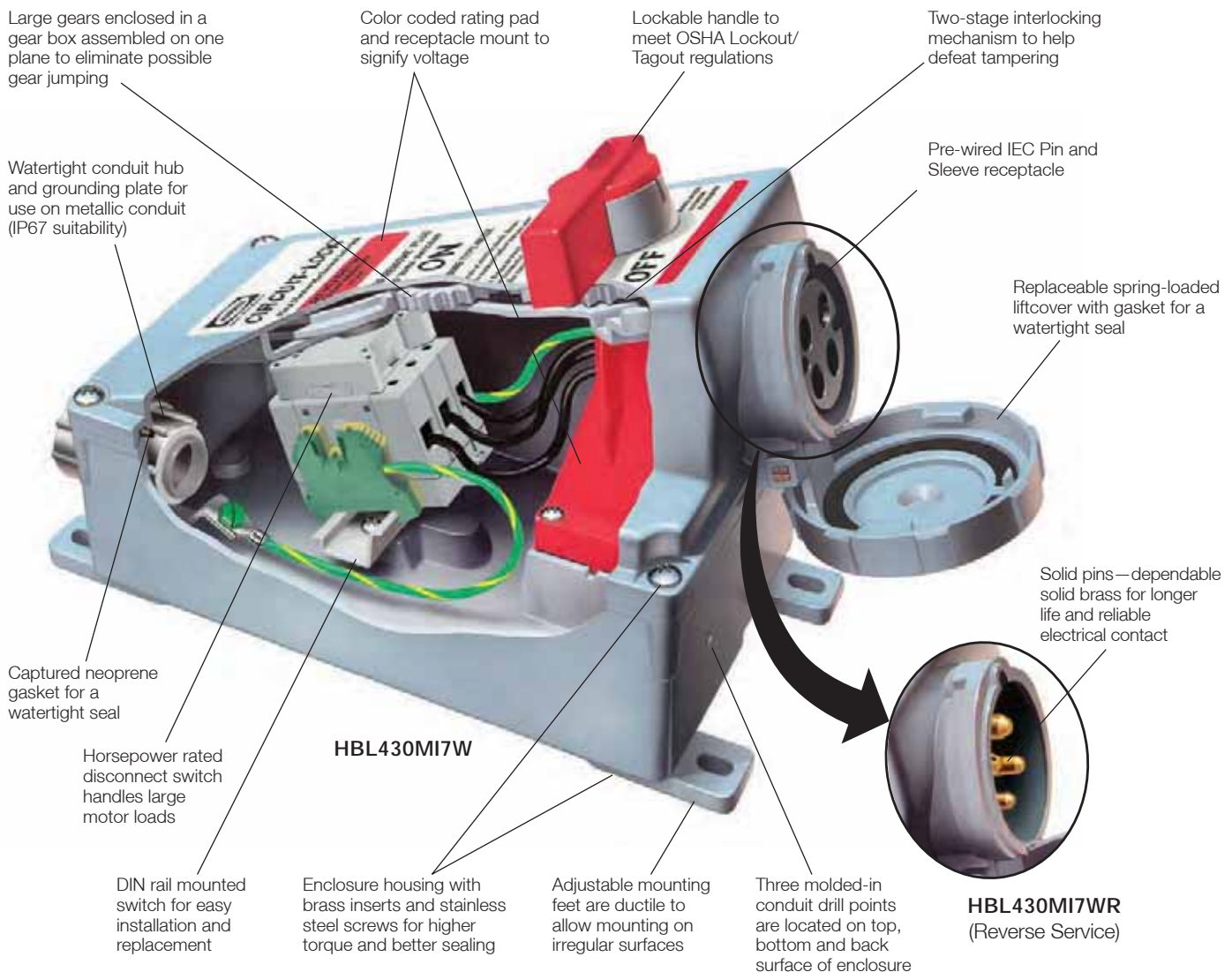

## Hubbell Circuit-Lock® Mechanical Interlocks

The National Electrical Code (NEC®) requires a separate disconnect means within sight of all motor loads. The NEC requires the disconnecting means in a motor-circuit be listed as "Suitable as Motor Disconnect" if the motor is rated greater than 2 HP.

Hubbell's revolutionary Circuit-Lock interlock incorporates the disconnect switch and receptacle in one compact, non-metallic and economical unit. Removing the plug and locking it out provides a visual means of verifying equipment has been disconnected. All Circuit-Lock mechanical interlocks can be locked out as a method of compliance with the OSHA Lockout/Tagout regulation.

The switch cannot be turned ON until the plug is completely engaged, and the plug cannot be removed until the switch is turned OFF. At the same time, it eliminates the possibility of making or breaking the circuit under load or making a

casual or "lazy" connection. The non-metallic enclosure can be connected to the metallic conduit and not interfere with the ground continuity.

In addition, these horsepower rated units are durable, watertight and easy to install. And they are compatible with IEC 60309-2 plugs.

These Circuit-Lock units are available in 20, 30, 60 and 100A models, and in 3, 4 and 5 wire configurations that are designed to the IEC 60309-1 and 60309-2 standards.

Hubbell's Circuit-Lock Mechanical Interlocks are also available in "Reverse Service" versions. These units incorporate the disconnect switch and reverse service receptacle (inlet) in one compact, non-metallic and economical unit. These units are available in 30, 60 and 100A models, 4 wire configurations.

NEC® is a registered trademark of the National Fire Protection Association (NFPA).



# IEC Pin and Sleeve Unfused Circuit-Lock® Devices

20, 30, 60 and 100 Ampere – North American Ratings, 32 Ampere – International Rating



**IP67**  
SUITABILITY

Enclosure Type 4X, 12

Rating					Unfused Circuit-Lock® Devices		Reverse Service	
Amps	Poles and Wires	Configuration Recep.	Plug	AC Voltage				
					Mechanical Interlock	Mating Plug	Mechanical Interlock	Mating Plug
20	3P 4W			120/240V	HBL420MI12W	HBL420P12W	—	—
	3P 4W			3Ø 240V	HBL420MI9W	HBL420P9W	—	—
	3P 4W			3Ø 480V	HBL420MI7W	HBL420P7W	—	—
	3P 4W			3Ø 600V	HBL420MI5W	HBL420P5W	—	—
30	2P 3W			120V	HBL330MI4W	HBL330P4W	—	—
	2P 3W			240V	HBL330MI6W	HBL330P6W	—	—
	2P 3W			480V	HBL330MI7W	HBL330P7W	—	—
	3P 4W			120/240V	HBL430MI12W	HBL430P12W	—	—
	3P 4W			3Ø 240V	HBL430MI9W	HBL430P9W	HBL430MI9WR	HBL430P9WR
	3P 4W			3Ø 480V	HBL430MI7W	HBL430P7W	HBL430MI7WR	HBL430P7WR
	3P 4W			3Ø 600V	HBL430MI5W	HBL430P5W	HBL430MI5WR	HBL430P5WR
	4P 5W			3ØY 120/208V	HBL530MI9W	HBL530P9W	—	—
	4P 5W			3ØY 277/480V	HBL530MI7W	HBL530P7W	—	—
	4P 5W			3ØY 347/600V	HBL530MI5W	HBL530P5W	—	—
32	3P 4W			380V 50HZ - 440V 60Hz	HBL432MI3W	HBL432P3W	—	—
60	2P 3W			120V	HBL360MI4W	HBL360P4W	—	—
	2P 3W			240V	HBL360MI6W	HBL360P6W	—	—
	2P 3W			480V	HBL360MI7W	HBL360P7W	—	—
	3P 4W			120/240V	HBL460MI12W	HBL460P12W	HBL460MI12WR	HBL460P12WR
	3P 4W			3Ø 240V	HBL460MI9W	HBL460P9W	HBL460MI9WR	HBL460P9WR
	3P 4W			3Ø 480V	HBL460MI7W	HBL460P7W	HBL460MI7WR	HBL460P7WR
	3P 4W			3Ø 600V	HBL460MI5W	HBL460P5W	HBL460MI5WR	HBL460P5WR
	4P 5W			3ØY 120/208V	HBL560MI9W	HBL560P9W	—	—
	4P 5W			3ØY 277/480V	HBL560MI7W	HBL560P7W	—	—
	4P 5W			3ØY 347/600V	HBL560MI5W	HBL560P5W	—	—
100	2P 3W			240V	HBL3100MI6W	HBL3100P6W	—	—
	3P 4W			120/240V	HBL4100MI12W	HBL4100P12W	HBL4100MI12WR	HBL4100P12WR
	3P 4W			3Ø 240V	HBL4100MI9W	HBL4100P9W	HBL4100MI9WR	HBL4100P9WR
	3P 4W			3Ø 480V	HBL4100MI7W	HBL4100P7W	HBL4100MI7WR	HBL4100P7WR
	3P 4W			3Ø 600V	HBL4100MI5W	HBL4100P5W	HBL4100MI5WR	HBL4100P5WR
	4P 5W			3ØY 120/208V	HBL5100MI9W	HBL5100P9W	—	—

Note: 20, 30 and 32A – 1 inch NPT hub supplied; 60 and 100A – 1¼ inch hub supplied.

# IEC Pin and Sleeve Circuit-Lock® Pin and Sleeve Mechanical Interlocks

Accessories and Dimensions



HBLAC1



HBLAC2



HBL30RGB

HBL30RNB



MICPK30



CA3430MI



HBL30MIRS



HBLRFT2

Dimensions in Inches (mm)

## Auxiliary Contacts for 20, 30, 32, 60 and 100A Switch, NEMA A600 Pilot Duty

Description	Catalog Number
"Break After Main Break", 1 set of n/o contacts, 1 set of n/c contacts.	HBLAC1
"Break Before Main Break", 1 set of n/o contacts.	HBLAC2

## Ground Block

Description	Catalog Number
For 20, 30 and 32A switches.	HBL30RGB
For 60 and 100A switches.	HBL60100RGB

## Neutral Block

Description	Catalog Number
For 20, 30 and 32A switches.	HBL30RNB
For 60A switches.	HBL60RNB
For 100A switches.	HBL100RNB

## Watertight Closure Plug Kits

Description	Catalog Number
For 20, 30 and 32A Circuit-Lock Unfused and Fused Pin and Sleeve mechanical interlocks.	MICPK30
For 60 and 100A Circuit-Lock Unfused and Fused Pin and Sleeve mechanical interlocks.	MICPK60

## Replacement Flip Covers

Description	Catalog Number
For 20A mechanical interlocks.	CA420MI
For 30 and 32A, 3 and 4 wire mechanical interlocks.	CA3430MI
For 30A, 5 wire mechanical interlocks.	CA530MI
For 60A mechanical interlocks.	CA60MI
For 100A mechanical interlocks.	CA100MI

## Replacement Switches

Description	Catalog Number
For 20A mechanical interlocks.	HBLDS3RS
For 30 and 32A mechanical interlocks.	HBL30MIRS
For 60 and 100A mechanical interlocks.	HBLDS60100RS

## Replacement Mounting Feet

Description	Catalog Number
For 20, 30, 32, 60 and 100A mechanical interlocks.	HBLRFT2*

## Dimensions

KEY	20A and 30A Inches (mm)	60A Inches (mm)	100A Inches (mm)
A	7.75" (196.9)	7.75" (196.9)	7.75" (196.9)
B	6.87" (174.5)	6.87" (174.5)	6.87" (174.5)
C	4.75" (120.7)	4.75" (120.7)	4.75" (120.7)
D	1.02" (25.9)	1.02" (25.9)	1.02" (25.9)
E	1.60" (40.6)	1.46" (37.1)	1.46" (37.1)
F	11.00" (279.4)	12.75" (323.9)	12.75" (323.9)
G	8.75" (222.3)	8.75" (222.3)	8.75" (222.3)
H	8.00" (203.2)	9.75" (247.7)	9.75" (247.7)
I	10.12" (257.0)	11.87" (301.5)	11.87" (301.5)
J	6.88" (174.8)	6.88" (174.8)	6.88" (174.8)
K	1.93" (49.0)	2.09" (53.1)	2.09" (53.1)
L	11.25" (285.8)**	13.65" (346.7)	13.65" (346.7)
M	7.75" (196.9)	8.60" (218.4)	9.30" (236.2)
HUB SIZE	1.00" NPT	1.25" NPT	1.25" NPT

Note: \*Package of 10 feet and 10 screws.  
 \*\*30 and 32A, 3 and 4W = 11.50" (292.1);  
 30A, 5W = 11.59" (294.4).

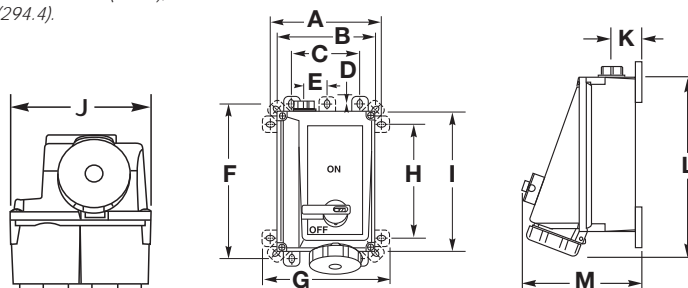



# IEC Pin and Sleeve Unfused Circuit-Lock®

Specifications and Horsepower Ratings

## Typical Specifications

Manufacturer's Identification	Hubbell HBL430MI7W
Description	Circuit-Lock® Pin and Sleeve Mechanical Interlock
Electrical Type	3 Pole + Earth
Rating	30A, 480V AC, 3 Phase
Configuration	IEC 60309-2, UL1686 C2, Clock position 7
Enclosure Type	Outdoor - 4X (Watertight, Washdown); Indoor - 12 (Dust-tight, Falling Dirt and Noncorrosive Liquids)
Ingress Protection	IP67 Suitability
Enclosure Material	Non-metallic, enclosure suitable for metallic conduit
Certification	UL Listed, CSA Certified

Note: This device provides on/off switched control of a plug connected load and includes an interlocking feature to prevent the plug from being disconnected while the receptacle is energized. The switch cannot be turned "ON" until the plug is inserted properly, and the plug cannot be removed until the switch is turned "OFF."

## Materials

Part	Material	Part	Material
Base	Valox®	Top	Valox®
Handle	Valox®	Conduit Hub	Zinc
Enclosure Gasket	Neoprene	Shaft	Valox®
Shaft Seal	Neoprene	Ground Plate	Galvanized Steel
Enclosure Screws	Stainless Steel 300 Series	Enclosure Inserts	Brass
Hinge Pins	Nickel Plated Brass	Hinge Spring	Stainless Steel 300 Series

## Performance

Electrical	
Dielectric Voltage	Withstands 3,000V AC Min.
Max. Working Voltage	600V AC RMS.
Current Interrupting	Certified for current interrupting at full rated current and voltage.
Short Circuit Withstand Rating	Suitable for use on a circuit capable of delivering not more than 10,000 RMS symmetrical amperes at the voltage rating of the receptacle. 20A and 30A models: Suitable for use on a circuit capable of delivering not more than 65,000 RMS symmetrical amperes, 600V when protected by class "J" fuses rated 30A.
Operations	Mechanical 10,000 cycles, electrical 6,000 cycles.

### Operations

Mechanical	
Impact Resistance	In accordance with UL 746C.
Terminal Identification	In accordance with UL, CSA and international conventions.
Product Identification	Identification and ratings are part of the external label and molded into the receptacle mount.
Mounting	External adjustable feet.

### Environmental

Moisture Resistance	Outdoor - 4X (Watertight, Washdown); Indoor - 12 (Dust-tight, Falling Dirt and Noncorrosive Liquids).
Ingress Protection	IP67 Suitability.
Flammability	UL94-5VA and V-0 Classification.
Operating Temperature	Max. Continuous +75°C; Min. Continuous -40°C.
UV Resistance	All materials are UV stabilized.

## Horsepower Ratings

Amps	AC Voltage Rating	Horsepower	Mechanical Interlock	Mating Plug
20	120/240V AC	2	HBL420MI12W	HBL420P12W
20	3Ø 240V AC	5	HBL420MI9W	HBL420P9W
20	3Ø 480V AC	5	HBL420MI7W	HBL420P7W
20	3Ø 600V AC	10	HBL420MI5W	HBL420P5W
30	120V AC	2	HBL330MI4W	HBL330P4W
30	240V AC	3 (208-240V AC)	HBL330MI6W	HBL330P6W
30	480V AC	7.5	HBL330MI7W	HBL330P7W
30	120/240V AC	3 (208-240V AC)	HBL430MI12W	HBL430P12W
30	3Ø 600V AC	20	HBL430MI5W	HBL430P5W
30	3Ø 480V AC	15	HBL430MI7W	HBL430P7W
30	3Ø 250V AC	7.5	HBL430MI9W	HBL430P9W
30	3ØY 347/600V AC	20	HBL530MI5W	HBL530P5W
30	3ØY 277/480V AC	15	HBL530MI7W	HBL530P7W
30	3ØY 120/208V AC	5	HBL530MI9W	HBL530P9W
32	380V AC 50Hz – 440V AC 60Hz	15 (440V AC 3Ø 60Hz)	HBL432MI3W	HBL432P3W
60	120V AC	3	HBL360MI4W	HBL360P4W
60	240V AC	7.5 (208-240V AC)	HBL360MI6W	HBL360P6W
60	480V AC	20	HBL360MI7W	HBL360P7W
60	120/240V AC	7.5 (208-240V AC)	HBL460MI12W	HBL460P12W
60	3Ø 600V AC	40	HBL460MI5W	HBL460P5W
60	3Ø 480V AC	30	HBL460MI7W	HBL460P7W
60	3Ø 250V AC	15	HBL460MI9W	HBL460P9W
60	3ØY 347/600V AC	40	HBL560MI5W	HBL560P5W
60	3ØY 277/480V AC	30	HBL560MI7W	HBL560P7W
60	3ØY 120/208V AC	15	HBL560MI9W	HBL560P9W
100	240V AC	15 (10 @ 208V AC)	HBL3100MI6W	HBL3100P6W
100	120/240V AC	15	HBL4100MI12W	HBL4100P12W
100	3Ø 600V AC	50	HBL4100MI5W	HBL4100P5W
100	3Ø 480V AC	50	HBL4100MI7W	HBL4100P7W
100	3Ø 250V AC	25 (208-240V AC)	HBL4100MI9W	HBL4100P9W
100	3ØY 120/208V AC	20	HBL5100MI9W	HBL5100P9W

Valox® is a trademark of SABIC Innovative Plastics, acquired from General Electric Company.

# IEC Pin and Sleeve Fused Circuit-Lock® Pin and Sleeve Mechanical Interlocks

## Features and Benefits

Non-metallic enclosure meets UL 50E Type 4X (watertight), 12 (dust-tight) and IP66 suitability requirements. Enclosure is molded of rugged thermoplastic Valox® to resist abuse, corrosion and enhance safety. All external hardware is stainless steel

Three molded-in conduit drill points are located on the top, bottom, and back surface of enclosure. Conduit hub provided: 30A 1 inch NPT, 60A 1 1/4 inch NPT

Adjustable mounting feet (4) can be mounted in any 1 of 3 positions for ease of installation

The patented Plug-Check™ mechanism detects the presence of the plug. It operates as a clutch to engage the handle with the switch and captures the plug. This action prevents the plug from being removed until the switch is turned OFF

High visibility red handle can be locked in the OFF position as a method of compliance with OSHA lockout requirements. Accepts up to a 5/16 inch padlock shackle

Removable door for ease of wiring and installation

Replaceable spring-loaded receptacle liftcover with gasket ensures dust tight rating; liftcover provides watertight seal when turned and locked

**HBL460MIF5W**

Conduit hub and mounting feet are supplied with each IEC Mechanical Interlock



Compact Fused Disconnect Switch accepts Class "J" fuses. Fuse holders are top mounted for easy access. The switch accepts auxiliary contacts for control circuit applications including the ON/OFF control of remote pilot lights or signal for programmable controllers.



Thermoset polyester contact carrier provides resistance to electrical tracking and withstands higher temperatures. Thermoset properties provide excellent dimensional stability, low moisture absorption, and superior dielectric strength.



Stainless steel 1/4 inch turn door fasteners for quick, easy access to fuses.



Enclosure door can be locked to prevent unauthorized access. Additionally, if the switch is ON, the door can not be opened.

Valox® is a trademark of SABIC Innovative Plastics, acquired from General Electric Company.

# IEC Pin and Sleeve Fused Circuit-Lock® Devices and Accessories

30 and 60 Ampere – North American Ratings



**IP66**  
SUITABILITY

Enclosure Type 4X, 12

Rating				Fused Circuit-Lock® Devices		
Amps	Poles and Wires	Configuration Recep./ Conn.	Plug/ Inlet	AC Voltage	Mechanical Interlock	Mating Plug
30	3P 4W			120/240V		
	3P 4W			3Ø 240V	HBL430MIF9W	HBL430P9W
	3P 4W			3Ø 480V	HBL430MIF7W	HBL430P7W
	3P 4W			3Ø 600V	HBL430MIF5W	HBL430P5W
	4P 5W			3ØY 277/480V	HBL530MIF7W	HBL530P7W
	4P 5W			3ØY 347/600V	HBL530MIF5W	HBL530P5W
60	3P 4W			120/240V	HBL460MIF12W	HBL460P12W
	3P 4W			3Ø 240V	HBL460MIF9W	HBL460P9W
	3P 4W			3Ø 480V	HBL460MIF7W	HBL460P7W
	3P 4W			3Ø 600V	HBL460MIF5W	HBL460P5W
	4P 5W			3ØY 120/208V	HBL560MIF9W	HBL560P9W

Note: 30A – 1 inch NPT hub supplied; 60A – 1¼ inch hub supplied.



## Replacement Auxiliary Contacts

Description	Black Style Switch Catalog Number	Gray Style Switch Catalog Number
Auxiliary contact, normally open, A600 pilot duty, break before break.	ACFSNO	HBLACFSNO
Auxiliary contact, normally closed, A600 pilot duty, break before break.	ACFSNC	HBLACFSNC

Note: Auxiliary contacts are specific to the style switch noted and are NOT interchangeable.

## Replacement Switches

Description	Black Style Switch Catalog Number	Gray Style Switch Catalog Number
For 30A fused switches.	30MIFRS	HBL30MIFRS
For 60A fused switches. Gray Style switch will retro fit Black Style switch.	—	HBL60MIFRS

Note: If replacing a Black Style switch, you must use the 30MIFRS. All other applications can use the Gray Style switch.



## Watertight Closure Plug Kits

Description	Catalog Number
For 30A Circuit-Lock® unfused and fused Pin and Sleeve mechanical interlocks.	MICPK30
For 60 and 100A Circuit-Lock® unfused and fused Pin and Sleeve mechanical interlocks.	MICPK60



## Replacement Flip Covers

Description	Catalog Number
For 30A, 3 and 4 wire mechanical interlocks.	CA3430MI
For 30A, 5 wire mechanical interlocks.	CA530MI
For 60A mechanical interlocks.	CA60MI

## Replacement Mounting Feet

Description	Catalog Number
Replacement mounting feet and screws for 30 and 60A fused mechanical interlocks.	HBLRFT2 <sup>A</sup>

Note: <sup>A</sup>Package of 10 feet and 10 screws.



# IEC Pin and Sleeve Fused Circuit-Lock®

Specifications and Horsepower Ratings

## Specifications

Typical Specifications	
Manufacturer's Identification	Hubbell HBL460MIF7W
Description	Fused Circuit-Lock Pin and Sleeve Mechanical Interlock
Electrical Type	3 Pole + Earth
Rating	60A, 480V AC, 3 Phase
Configuration	IEC 60309-2, UL1686C2, Clock Position 7
Enclosure Type	Outdoor - 4X (Watertight, Washdown) Indoor - 12 (Dust-tight, Falling dirt)
Certification	UL Listed for US and Canada

## Materials

Part	Material
Base and Top	Valox®
Handle	Valox®
Conduit Hub	Zinc, 30A-1", 60A-1¼" NPT
Enclosure Gasket	Neoprene
Shaft	Brass
Shaft Seal	Neoprene
Ground Plate	Galvanized Steel
Enclosure Screws	Stainless Steel
Mounting Inserts	Brass
Hinge Pin	Nickel-Plated Brass
Hinge Spring	Stainless Steel

Note: This device provides fused switched control of a plug connected load and includes an interlocking feature to prevent the plug from being disconnected or the fuse door opened while the receptacle is energized. The switch cannot be turned on until the plug is inserted properly.

## Performance

Electrical	
Dielectric Voltage	Withstands 3,000V AC Min.
Max. Working Voltage	600V AC.
Current Interrupting	Certified for current interrupting at full rated current and voltage.
Short Circuit Withstand Rating	Suitable for use on a circuit capable of delivering not more than 200,000 RMS symmetrical amperes at the voltage rating of receptacle.
Operations	
	Mechanical 10,000 cycles minimum.
Mechanical	
Impact Resistance	In accordance with UL 746C.
Terminal Identification	In accordance with UL, CSA and international conventions.
Product Ratings	Ratings are part of the external label and molded into the receptacle mount and color-coded.
Mounting	External adjustment feet.
Environmental	
Moisture Resistance	Outdoor - 4X (Watertight, Washdown); Indoor - 12 (Dust-tight, Falling dirt).
Ingress Protection	IP66 Suitability.
Flammability	UL94-5VA and V-0 Classification.
Operating Temperatures	Max. Continuous +75°C; Min. Continuous -40°C.
UV Resistance	All materials are UV stabilized.
Fuse Types	UL Listed Class "J". CSA Certified HRCI-J.

## Horsepower Ratings

Amps	AC Voltage Rating	Standard	Maximum**	Mechanical Interlock	Use Pin and Sleeve Plug
30	3Ø 600V AC	7.5	20	HBL430MIF5W	HBL430P5W
30	3Ø 480V AC	5	15	HBL430MIF7W	HBL430P7W
30	3Ø 240V AC	3	7.5	HBL430MIF9W	HBL430P9W
30	120/240V AC	1.5*	3*	HBL430MIF12W	HBL430P12W
30	3ØY 277/480V	5	15	HBL530MIF7W	HBL530P7W
30	3ØY 347/600V	7.5	20	HBL530MIF5W	HBL530P5W
60	3Ø 600V AC	15	50	HBL460MIF5W	HBL460P5W
60	3Ø 480V AC	15	30	HBL460MIF7W	HBL460P7W
60	3Ø 240V AC	7.5	15	HBL460MIF9W	HBL460P9W
60	120/240V AC	3*	10*	HBL460MIF12W	HBL460P12W
60	3ØY 120/208V	7.5	15	HBL560MIF9W	HBL560P9W

Note: \*208-240V AC L-L.

\*\*Requires time delay fuses.

## Dimensions

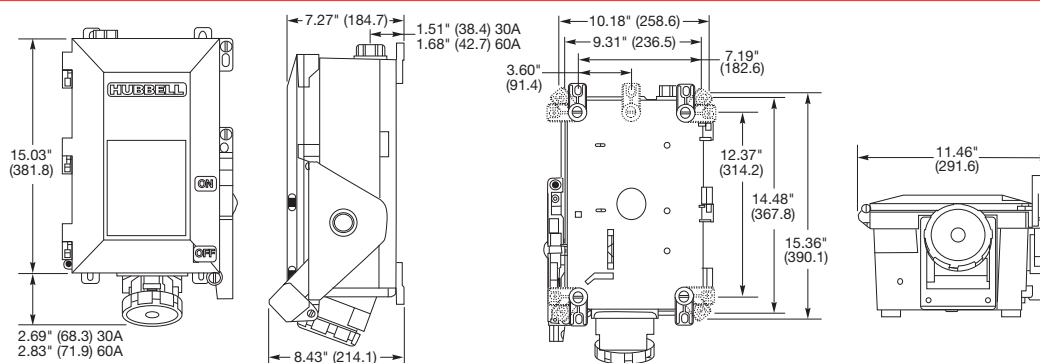

Dimensions in Inches (mm)

Valox® is a trademark of SABIC Innovative Plastics, acquired from General Electric Company.

Pin and Sleeve  
**20 and 30 Amps Low Profile**  
*Features and Benefits*



**Brass Box Terminal**

Permits high clamping pressure on conductors without damaging wire strands for best electrical conductivity

**Solid One-Piece Pins**

Solid construction. Long life, reliable electrical contact and maximum conductivity

**Nylon Construction**

Both interior and exterior are made of tough, durable nylon

**Split Sleeves**

Split sleeves with self-adjusting stainless steel springs assure constant contact pressure (20A and 30A). On 60A devices, Beryllium Copper insert with multiple contact points assures easy insertion and a tight fit

**Stainless Steel Terminal Screws**

Resist rust and corrosion

**Terminal Identification**

Large markings for easy recognition results in ease of wiring on the assembly line or in the field

**Color Coding**

Quick, easy visual identification of mating devices

**Shrouding**

Recessed pins are protected from impact and abuse

**Product Identification**

Ratings and certification are molded into the nylon housing. Benefit: Easy identification for reorder

**Integrated Cord Grip**

Limits strain on terminals, keeps cord connected

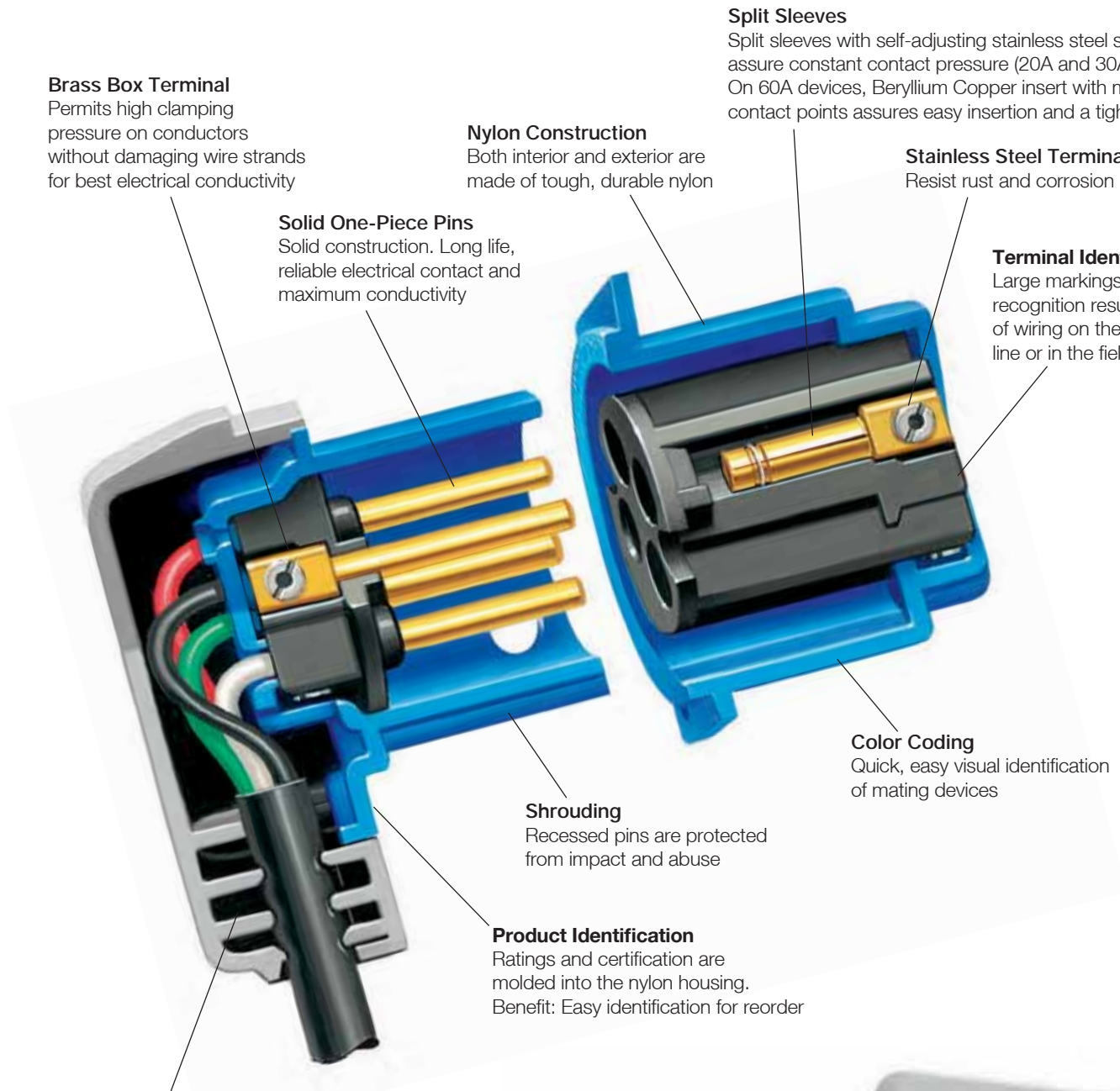

L420P9



L420R9

# Pin and Sleeve Low Profile Devices and Specifications

20, 30 and 60 Ampere - North American Ratings



## Low Profile Devices

Rating					Devices		Cord Diameter
Amps	Poles and Wires	Configuration Recep./ Plug/ Conn. Inlet		AC Voltage	Plug	Receptacle	Min. Max. Inches (mm)
20	3P 4W			3Ø 250V			.350" - .710" (8.3 - 15.9)
30	3P 4W			125/250V			.390" - .775" (9.9 - 19.7)
30	3P 4W			3Ø 250V			.390" - .775" (9.9 - 19.7)
60	3P 4W			3Ø 250V			.75" - 1.25" (19.1 - 31.8)
60	4P 5W			3ØY 120/208V			.89" - 1.42" (22.6 - 36.1)
100	4P 5W			3ØY 120/208V			1.34" - 1.50" (34.0 - 38.1)

## Specifications

Electrical	
Dielectric Withstand Voltage	3000V AC.
Max. Working Voltage	250V RMS.
Current Interrupting	Certified for current interruption at full rated current.
Temperature Rise	Max. 30 C temperature rise at full rated current after 50 cycles of overload at 150% of rated current at a power factor of 75%.
Endurance	Up to 5,000 connect and disconnect cycles at full rated current and voltage.
Mechanical	
Impact Resistance	Per CSA C22.2 No. 182.1 / UL1682.
Cord Grip Cable Retention	Per CSA C22.2 No. 182.1 / UL1682.
Cord Accommodation	Round portable service cords of diameters commensurate with the device rating as defined in UL standard 62, CSA C22.2 No. 49 and the <HAR> European Standards.
Terminal Identification	Terminals identified in accordance with North American convention.
Product Identification	Ratings are a permanent part of the device housing.
Environmental	
Flammability	HB or better per UL 94 or CSA. C22.2 No. 0.17.
Ingress Protection	IP22 Suitability
Operating Temperatures	Maximum Continuous 75° C; Minimum -40°C without impact.

## Application Guide

Agriculture	Indoor location and maintenance.
Chemical Processing	Indoor location and maintenance.
Construction	Indoors for added safety and abuse resistance.
Entertainment	Indoor location and maintenance.
Food Service	Food service areas where aesthetics and space are concerns.
Light Manufacturing	Indoor locations and maintenance.
Manufacturing	Light assembly areas, stamping operations and maintenance areas.
Military	Warehouse and maintenance areas.

## Materials

Plug	Material
Case	Zytel® 101 Nylon
Shroud	Zytel® 101 Nylon
Pin Carrier 20 & 30A	Zytel® 101 Nylon
Pin and Carrier 60A	High-Impact Thermoset
Pins	Brass CDA#360
Assembly Screws	Stainless Steel (300 series)
Terminal Screws	Stainless Steel (300 series)
Receptacle	
Body	Zytel® 101 Nylon
Sleeve Carrier 20 & 30A	Zytel® 101 Nylon
Sleeve Carrier 60A	High-Impact Thermoset
Sleeves	Brass CDA #360
Assembly Screws	Stainless Steel (300 series)
Terminal Screws	Stainless Steel (300 series)
Adapter Plate 20 & 30A	Galvanized Steel
Adapter Plate 60A	Aluminum
Wall Trim Plate	Zytel® 101 Nylon
Panel Mount Trim Plate	Stainless Steel (300 series)

Note: See page G-25 for product dimensions.

® Zytel and Rynite are registered trademarks of E.I. DuPont Corp.

# Pin and Sleeve Low Profile Dimensions

## Plug Dimensions

Type	A	B	C	D	Cord Range Diameter
L420P9	2.47" (62.7)	3.78" (96.0)	2.93" (74.4)	1.49" (37.8)	.350"-.710" (8.9-18.0)
L430P12	2.97" (75.4)	4.18" (106.2)	3.50" (88.9)	1.71" (43.4)	.390"-.775" (9.9-19.7)
A460P9	3.38" (85.9)	4.25" (108.0)	7.00" (177.8)	-	.75"-1.25" (19.1- 31.8)
A5100P9	4.92" (125.00)	5.07" (128.81)	8.60" (218.35)	-	1.34"-1.50" (34.0- 38.1)

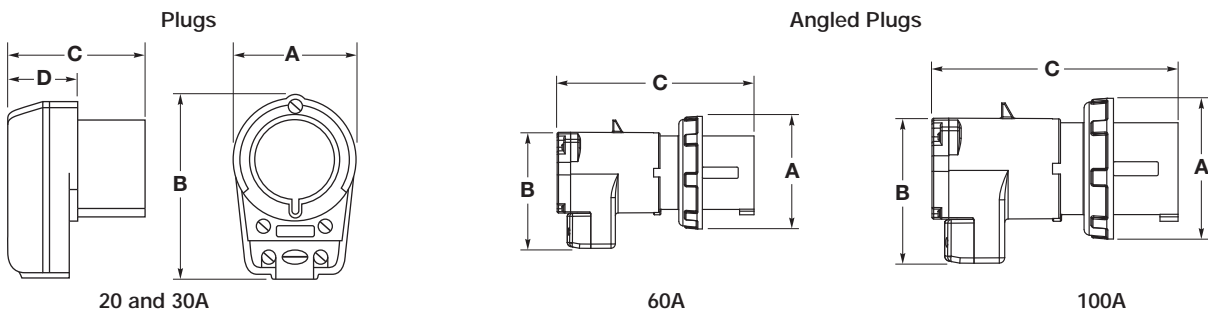

## Wall Mount Receptacle Dimensions

Type	A	B	C	D	E	F
L420R9	2.60" (66.0)	2.81" (71.4)	2.28" (57.9)	2.38" (60.5)	-	-
L430R12	3.12" (79.2)	3.12" (79.2)	2.77" (70.4)	2.76" (70.1)	-	-
A460R9	4.50" (114.3)	4.50" (114.3)	4.48" (113.8)	-	3.62" (91.9)	.50" (12.7)

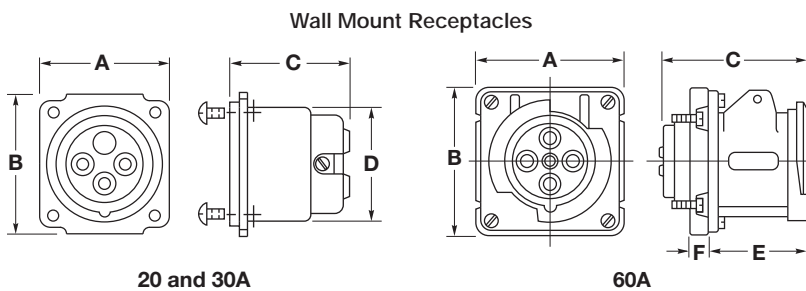

## Adapter Plate (Included with "L" and "A" series receptacles)

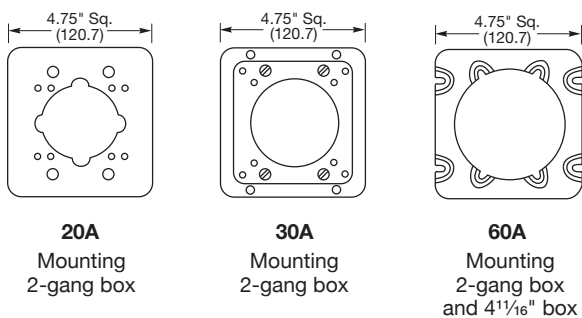

## Panel Cutout

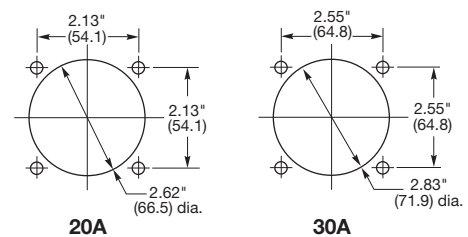









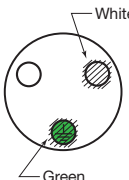
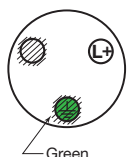
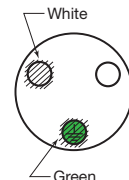
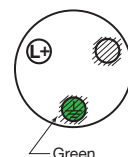
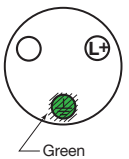

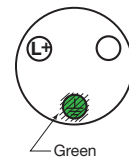

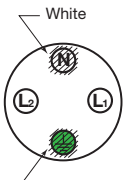

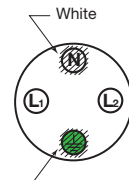

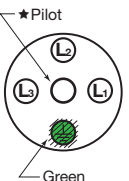
Dimensions in Inches (mm)

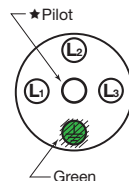
# Pin and Sleeve Devices

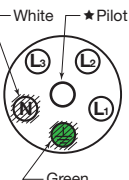
## IEC Pin and Sleeve Terminal Identification

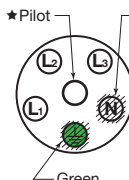
### IEC Pin and Sleeve Terminal Identification – Rear View

Description	Rating		Terminal Marking Pattern*			
	Domestic	International	Receptacle and Connector		Plug and Inlet	
			Domestic	International	Domestic	International
3 Wire	125V AC 277V AC	100-130V				
3 Wire	250V AC 480V AC 600V AC	200-250V 380-415V AC				
4 Wire	125/250V AC 1ØY 120/208V	—				
4 Wire	(3Ø Δ) 250V AC 480V AC 600V AC	380-415V AC				
5 Wire	(3ØY) 120/208V AC 277/480V AC 347/600V AC	220/380V 50Hz 250/440V 60Hz 200/346V to 240/415V 50 and 60Hz				

Note: \*Location of grounding contact position will change as clock positions assigned to specific voltages change.

★Pilot contacts supplied on 4 and 5 wire, 63 and 125 Amp international rated devices.



**Ground Path**

To reduce the likelihood of electrical shock, the National Electrical Code requires that non-current carrying metallic components be grounded. Insulgrip Pin and Sleeve wiring devices offer two styles of grounding.

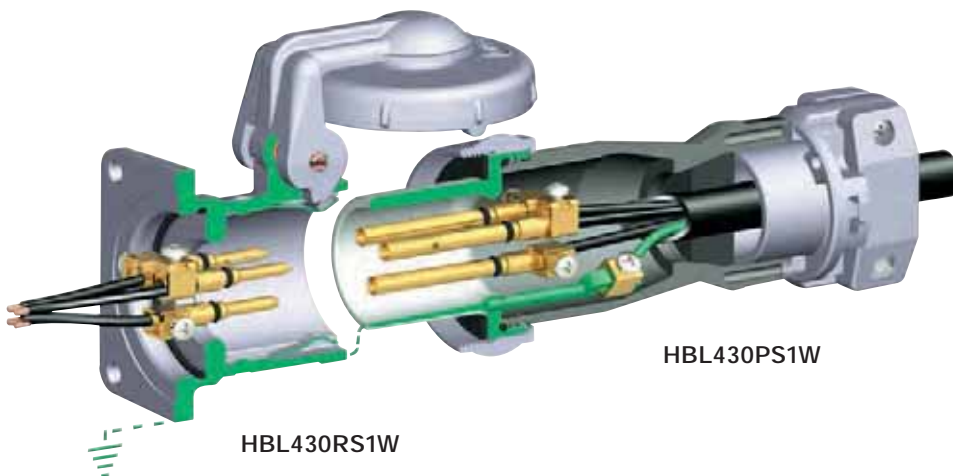

**Style I**

Receptacles achieve grounding by attaching the ground conductor to the ground screw inside the back box and utilizing the metallic receptacle shell as a ground source (see 3P 4W Style I illustration). Plugs and connectors establish grounding by means of connecting the flexible cable ground conductor to a ground terminal within each device, which, in turn, is grounded through the metallic plug or connector shroud. Any exposed metallic components are suitably grounded in the Style I offering.

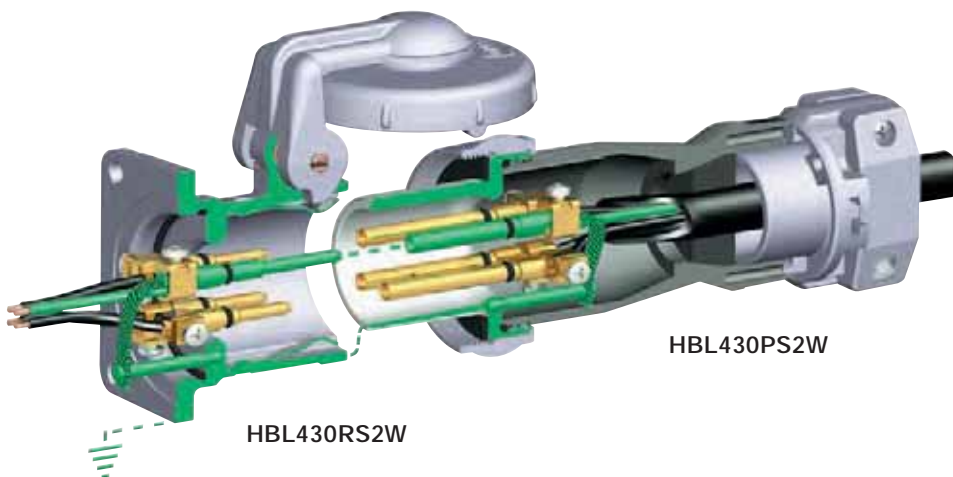

**Style II**

The Style II ground path offers two means of achieving the proper ground path. In addition to utilizing the same grounding method as in the Style I product, the Style II version incorporates a separate ground pin and sleeve (see 3P 4W Style II illustration). This provides a second ground path. The ground pin on Style II devices is longer than other pins, meaning that they “make first” and “break last,” assuring protection for people and equipment.

**New Pole and Wire Terminology**

Style I			Style II		
New	Old	No. of Contacts	New	Old	No. of Contacts
2P 3W	2W 2P	2	2P 3W	2W 3P	3
3P 4W	3W 3P	3	3P 4W	3W 4P	4
4P 5W	4W 4P	4			

UL 1686 C1 Pin and Sleeve  
**Insulgrip® Pin and Sleeve Devices**  
*Features and Benefits*

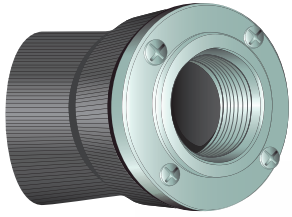

**Liquidtight Conduit Adapters**  
 Machined aluminum adapters are available to provide a means for attaching flexible liquidtight metal conduit to rear of Hubbell Pin and Sleeve plug or connector

**Spring-Loaded, Gasketed Cover**  
 Provides a UL Type 4X watertight, dust-tight seal on connectors and receptacles

**Lid-Stay**  
 Provides a hands-free means of holding the cover in the open position for engaging mating device, troubleshooting or maintenance purpose

**Watertight Neoprene Sealing Glands**  
 Provide a reliable seal at the cable entry point

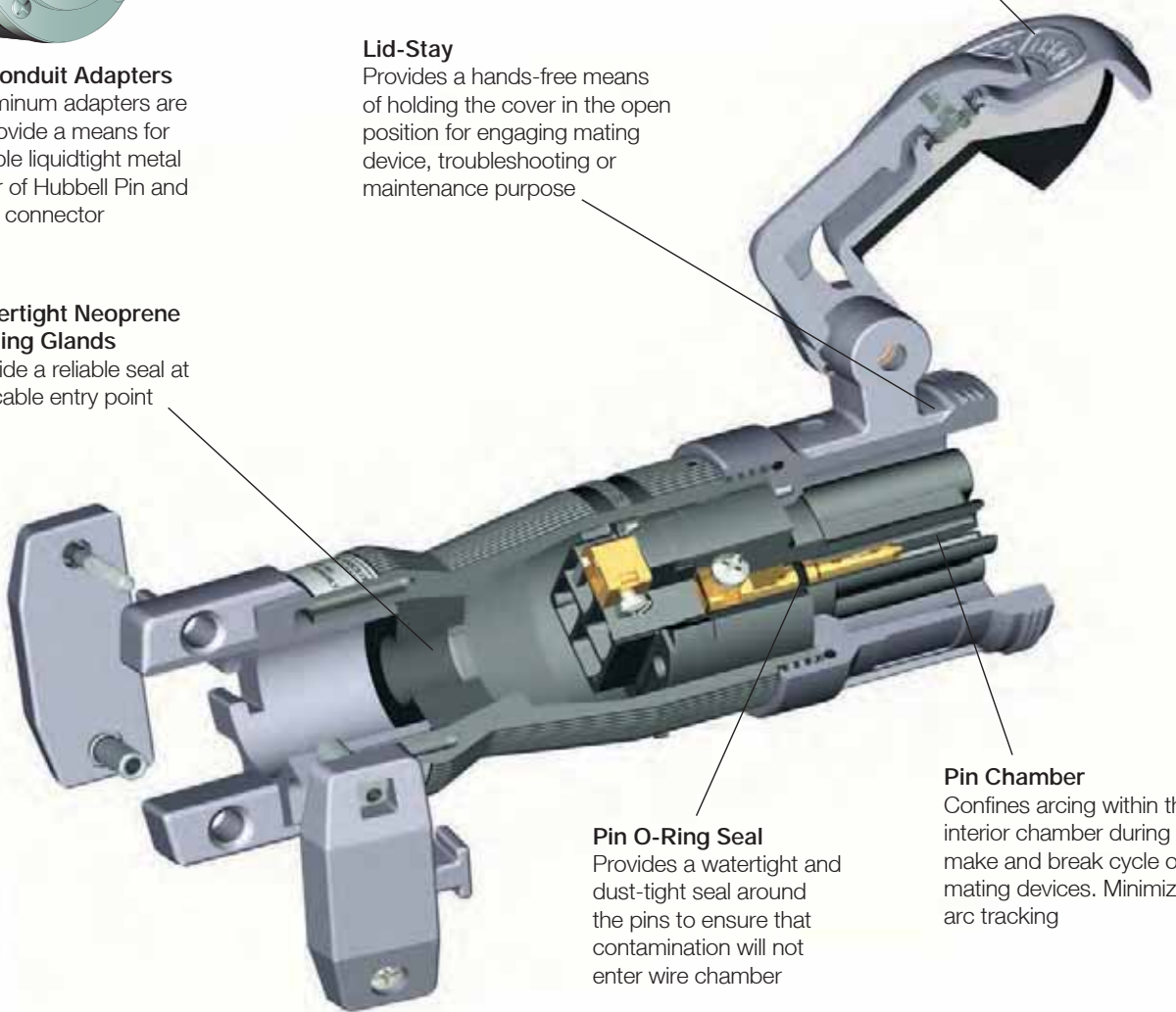

**Pin O-Ring Seal**  
 Provides a watertight and dust-tight seal around the pins to ensure that contamination will not enter wire chamber

**Pin Chamber**  
 Confines arcing within the interior chamber during make and break cycle of mating devices. Minimizes arc tracking



**Powerful Mechanical Cord Grip**  
 Hubbell's design incorporates two molded-in teeth to securely grip the outer cable jacket, and internal conductors to prevent slippage and strain on terminations. Captive barrel nuts ease assembly and allow higher tightening torque for maximum cord retention.



**Watertight Cord Entrance**  
 The tapered bore entrance creates high compression forces on sealing gland, providing a watertight seal around cord. Individual solid neoprene glands are supplied to match a full range of cord sizes and assure watertight performance.



**Anti-Vibration Box Terminals**  
 Interlocking box terminals ensure that terminal screws remain secure and cannot loosen. The floating box is designed to obtain high-torque values without damaging stranded conductors.



**Terminal Entrance Holes**  
 Large, square funneled entrance holes isolate each conductor to protect against shorts due to stray conductor strands. Tapered hole provides a fast and easy guide into the termination chamber.

UL 1686 C1 Pin and Sleeve  
**Insulgrip® Pin and Sleeve Devices**  
*Features and Benefits*

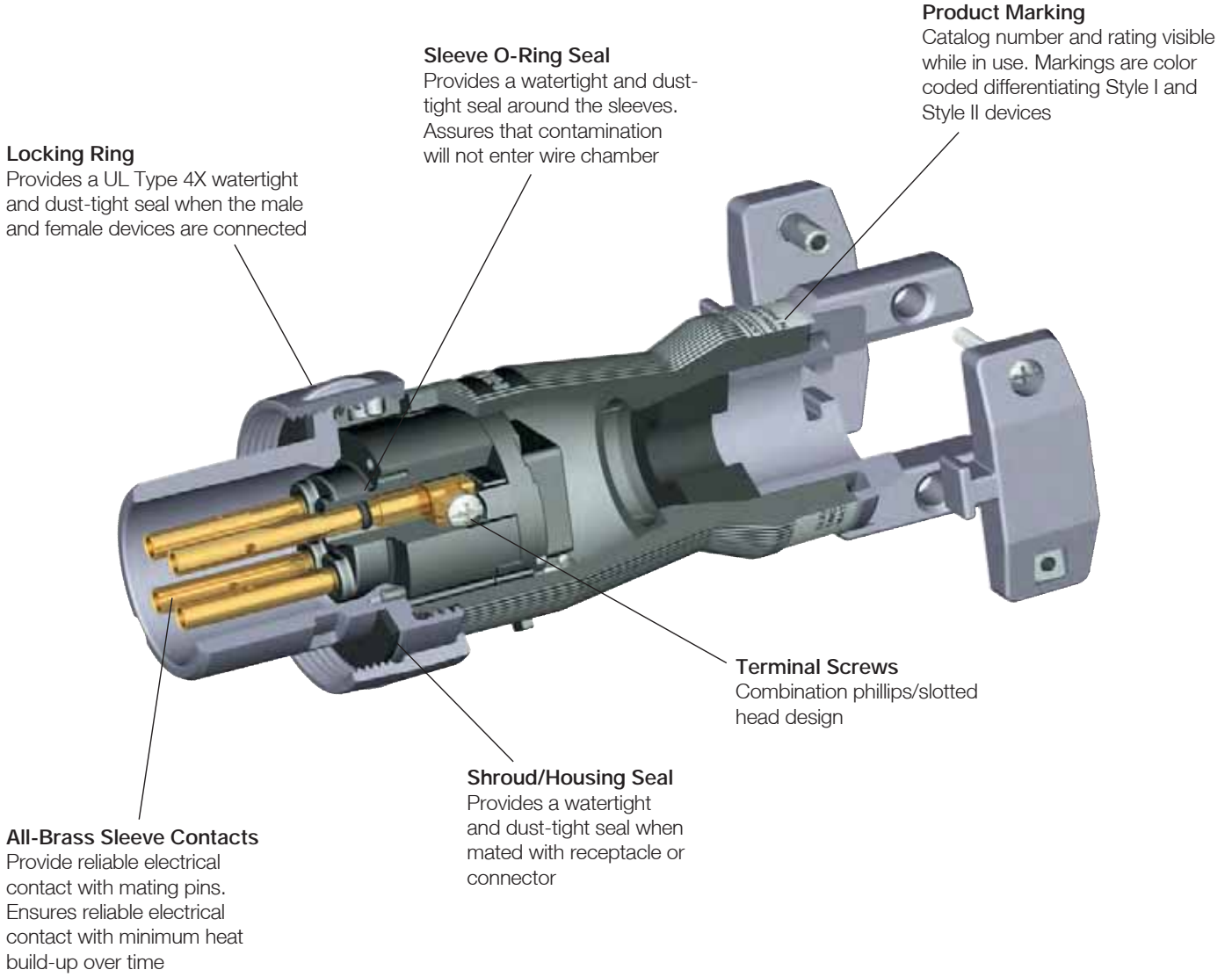

**Thermoplastic Housing**  
 Provides excellent insulating, impact, corrosion, and UV resistant properties. Protects users and internal components in the roughest of environments.

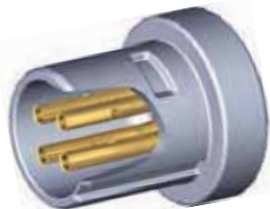

**Shrouded Sleeves**  
 The shroud protects contact sleeves from deforming from physical abuse. The design protects the user from the possibility of touching live contacts during insertion and withdrawal of mating parts.

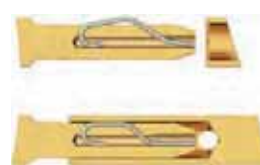

























**Beryllium Copper Spring-Pin Design (Patented)**  
 Maintains high unit pressure on mating sleeves. Ensures reliable electrical contact while minimizing heat rise due to normal pin wear over time.









**Thermoset Polyester Contact Carrier**  
 Molded thermoset polyester provides high resistance to electrical tracking. Withstands higher temperatures which may result from overload or arcing. Thermoset properties provide dimensional stability for this critical assembly.

UL 1686 C1 Pin and Sleeve  
**Insulgrip® Pin and Sleeve Devices - Style I and II**  
 30, 60, 100 and 200 Ampere, 600/250 Voltage AC/DC, 50-400 Hertz



Rating				Style I Devices			Replacement Interiors	
Amps	Poles and Wires	Receptacle/Connector Configuration*	Maximum Voltage AC/DC	 Receptacle	 Plug	 Connector	 Connector & Receptacle	 Plug
30	2P 3W		600/250	HBL330RS1W	HBL330PS1W	HBL330CS1W	IN330FS1	IN330MS1
	3P 4W		600/250	HBL430RS1W	HBL430PS1W	HBL430CS1W	IN430FS1	IN430MS1
	4P 5W		600/250	HBL530RS1W	HBL530PS1W	HBL530CS1W	IN530FS1	IN530MS1
60	2P 3W		600/250	HBL360RS1W	HBL360PS1W	HBL360CS1W	IN360FS1	IN360MS1
	3P 4W		600/250	HBL460RS1W	HBL460PS1W	HBL460CS1W	IN460FS1	IN460MS1
	4P 5W		600/250	HBL560RS1W	HBL560PS1W	HBL560CS1W	IN560FS1	IN560MS1
100	2P 3W		600/250	HBL3100RS1W	HBL3100PS1W	HBL3100CS1W	IN3100FS1	IN3100MS1
	3P 4W		600/250	HBL4100RS1W	HBL4100PS1W	HBL4100CS1W	IN4100FS1	IN4100MS1
	4P 5W		600/250	HBL5100RS1W	HBL5100PS1W	HBL5100CS1W	IN5100FS1	IN5100MS1
200	3P 4W		600/250	HBL4200RS1W	HBL4200PS1W	HBL4200CS1W	IN4200FS1†	IN4200MS1†
	4P 5W		600/250	HBL5200RS1W	HBL5200PS1W	HBL5200CS1W	IN5200FS1†	IN5200MS1†
Rating				Style II Devices			Replacement Interiors	
Amps	Poles and Wires	Receptacle/Connector Configuration*	Maximum Voltage AC/DC	Receptacle	Plug	Connector	Connector & Receptacle	Plug
30	2P 3W		600/250	HBL330RS2W	HBL330PS2W	HBL330CS2W	IN330FS2	IN330MS2
	3P 4W		600/250	HBL430RS2W	HBL430PS2W	HBL430CS2W	IN430FS2	IN430MS2
60	2P 3W		600/250	HBL360RS2W	HBL360PS2W	HBL360CS2W	IN360FS2	IN360MS2
	3P 4W		600/250	HBL460RS2W	HBL460PS2W	HBL460CS2W	IN460FS2	IN460MS2
100	2P 3W		600/250	HBL3100RS2W	HBL3100PS2W	HBL3100CS2W	IN3100FS2	IN3100MS2
	3P 4W		600/250	HBL4100RS2W	HBL4100PS2W	HBL4100CS2W	IN4100FS2	IN4100MS2
200	2P 3W		600/250	HBL3200RS2W	HBL3200PS2W	HBL3200CS2W	IN3200FS2†	IN3200MS2†
	3P 4W		600/250	HBL4200RS2W	HBL4200PS2W	HBL4200CS2W	IN4200FS2†	IN4200MS2†

























Rating				Corrosion Resistant Devices			Accessories	
Amps	Poles and Wires	Receptacle/Connector Configuration*	Maximum Voltage AC/DC	 Receptacle	 Plug	 Connector	 Back Boxes	 Angle Adapter
200	4P 5W		600/250	M5200RS1	M5200PS1	M5200CS1	MB2003W MB2004W	AA20045





Note: **\*CAUTION:** To avoid electrical shock, review premises carefully and DO NOT use if Pin and Sleeve configuration (design) is already in a circuit having a rating differing from the rating of this device.

\*\*While in use or with cover closed.

†Consult factory.

Corrosion resistant cord sets are available on page Z-17 of this catalog.

Rating				Style I Devices			Replacement Interiors	
Amps	Poles and Wires	Receptacle/ Connector Configuration*	Maximum Voltage AC/DC	 Receptacle	 Plug	 Connector	 Connector & Receptacle	 Plug
30	2P 3W		600/250	HBL330RS1WR	HBL330PS1WR	HBL330CS1WR	IN330MS1	IN330FS1
	3P 4W		600/250	HBL430RS1WR	HBL430PS1WR	HBL430CS1WR	IN430MS1	IN430FS1
	4P 5W		600/250	HBL530RS1WR	HBL530PS1WR	HBL530CS1WR	IN530MS1	IN530FS1
60	2P 3W		600/250	HBL360RS1WR	HBL360PS1WR	HBL360CS1WR	IN360MS1	IN360FS1
	3P 4W		600/250	HBL460RS1WR	HBL460PS1WR	HBL460CS1WR	IN460MS1	IN460FS1
	4P 5W		600/250	HBL560RS1WR	HBL560PS1WR	HBL560CS1WR	IN560MS1	IN560FS1
100	2P 3W		600/250	HBL3100RS1WR	HBL3100PS1WR	HBL3100CS1WR	IN3100MS1	IN3100FS1
	3P 4W		600/250	HBL4100RS1WR	HBL4100PS1WR	HBL4100CS1WR	IN4100MS1	IN4100FS1
	4P 5W		600/250	HBL5100RS1WR	HBL5100PS1WR	HBL5100CS1WR	IN5100MS1	IN5100FS1
200	3P 4W		600/250	HBL4200RS1WR	HBL4200PS1WR	HBL4200CS1WR	IN4200MS1†	IN4200FS1†
	4P 5W		600/250	HBL5200RS1WR	HBL5200PS1WR	HBL5200CS1WR	IN5200MS1†	IN5200FS1†
Rating				Style II Devices			Replacement Interiors	
Amps	Poles and Wires	Receptacle/ Connector Configuration*	Maximum Voltage AC/DC	Receptacle	Plug	Connector	Connector & Receptacle	Plug
30	2P 3W		600/250	HBL330RS2WR	HBL330PS2WR	HBL330CS2WR	IN330MS2	IN330FS2
	3P 4W		600/250	HBL430RS2WR	HBL430PS2WR	HBL430CS2WR	IN430MS2	IN430FS2
60	2P 3W		600/250	HBL360RS2WR	HBL360PS2WR	HBL360CS2WR	IN360MS2	IN360FS2
	3P 4W		600/250	HBL460RS2WR	HBL460PS2WR	HBL460CS2WR	IN460MS2	IN460FS2
100	2P 3W		600/250	HBL3100RS2WR	HBL3100PS2WR	HBL3100CS2WR	IN3100MS2	IN3100FS2
	3P 4W		600/250	HBL4100RS2WR	HBL4100PS2WR	HBL4100CS2WR	IN4100MS2	IN4100FS2
200	2P 3W		600/250	HBL3200RS2WR	HBL3200PS2WR	HBL3200CS2WR	IN3200MS2†	IN3200FS2†
	3P 4W		600/250	HBL4200RS2WR	HBL4200PS2WR	HBL4200CS2WR	IN4200MS2†	IN4200FS2†

Rating				Corrosion Resistant Devices			Accessories	
Amps	Poles and Wires	Receptacle/ Connector Configuration*	Maximum Voltage AC/DC	 Receptacle	 Plug	Connector	 Back Boxes	 Angle Adapter
200	4P 5W		600/250	M5200BS1R	M5200CS1R	—	MB2003W MB2004W	AA20045

Note: \*CAUTION: To avoid electrical shock, review premises carefully and DO NOT use if Pin and Sleeve configuration (design) is already in a circuit having a rating differing from the rating of this device.

\*\*While in use or with cover closed.

†Consult factory.

Corrosion resistant cord sets are available on page Z-17 of this catalog.

# UL 1686 C1 Pin and Sleeve Insulgrip® Pin and Sleeve Device Accessories



## Insulgrip Pin and Sleeve Metallic Back Boxes

Hubbell manufactures an extensive line of back boxes for use with UL 1686 Pin and Sleeve devices. Each back box is designed to give the user the maximum amount of wiring room while achieving grounding to metallic conduit.

### Metallic 30° Angle Back Box\*

Description	Amps	NPT Hub Size	Catalog Number
Back box for 30A devices.	30	¾"	<b>MB301W</b>
	30	1"	<b>MB302W</b>

### Metallic 15° Angle Back Box\*

Description	Amps	NPT Hub Size	Catalog Number
Back box for 60A devices.	60	1"	<b>MB601W</b>
	60	1¼"	<b>MB602W</b>
	60	1½"	<b>MB603W</b>

### Metallic Feed-Thru Back Box\*

Description	Amps	NPT Hub Size	Catalog Number
Straight feed-thru box for 30A devices.	30	¾"	<b>MB303W</b>
	30	1"	<b>MB304W</b>
Straight feed-thru box for 60A devices.	60	1"	<b>MB604W</b>
	60	1¼"	<b>MB605W</b>
	60	1½"	<b>MB606W</b>

### Metallic Four-Way Angle Back Box\*

Description	Amps	NPT Hub Size	Catalog Number
Four-way 15° angle box for 60 and 100A devices.	60/100	1¼"	<b>MB601002W</b>
	60/100	1½"	<b>MB601003W</b>
	60/100	2"	<b>MB601004W</b>
Four-way 45° angle box for 200A devices.	200	2"	<b>MB2003W</b>
	200	2½"	<b>MB2004W</b>
45° Angle adapter only for 200A devices.	200	-	<b>AA20045</b>

### Metallic Four-Way Feed-Thru 15° Angle Back Box\*

Description	Amps	NPT Hub Size	Catalog Number
Four-way feed-thru, 15° angle for 60 and 100A devices.	60/100	1¼"	<b>MB601006W</b>
	60/100	1½"	<b>MB601007W</b>
	60/100	2"	<b>MB601008W</b>

Note: \*These boxes are cast aluminum, suitable for IP54 requirements and are finished with enamel paint.

### Replacement Cord Clamp and Locking Ring

Description	Used on	Cord Clamp Catalog Number	Locking Ring Catalog Number
Fits all 30A plugs and connectors.	All 3, 4, 5 wire	<b>CC3430</b>	<b>ILR1**</b>
Fits all 60A plugs and connectors.	4 wire (Style 2) and all 5 wire	<b>CC60</b>	<b>ILR2**</b>
	All 3 wire and 4 wire (Style 1)	<b>CC60</b>	<b>ILR3**</b>
Fits all 100A plugs and connectors.	4 wire (Style 2) and all 5 wire	<b>CC100</b>	<b>ILR4**</b>
	All 3 wire and 4 wire (Style 1)	<b>CC100</b>	<b>ILR5**</b>
Fits all 200A plugs and connectors.	All 3, 4, 5 wire	<b>CC201</b>	—

Note: \*\*Locking Ring only.

### Liquidtight Adapters

Rating of Hubbell Pin and Sleeve Device	Liquidtight Conduit Size	Hubbell Liquidtight Adapter	Optional Kellems Liquidtight Conduit Grip
30 Amp	½" NPT	<b>SAB12</b>	<b>074093402</b>
	¾" NPT	<b>SAB34</b>	<b>074093403</b>
	1" NPT	<b>SAB100</b>	<b>074093404</b>
60 Amp	1" NPT	<b>SAC100</b>	<b>074093404</b>
	1¼" NPT	<b>SAC125</b>	<b>074093405</b>
100 Amp	1¼" NPT	<b>SAD125</b>	<b>074093405</b>
	1½" NPT	<b>SAD150</b>	<b>074093406</b>

# UL 1686 C1 Pin and Sleeve Insulgrip® Pin and Sleeve Device Dimensions

## Receptacle Dimensions

Amps	Type	A		B		C		D		E	
		Style I	Style II	Style I	Style II	Style I	Style II	Style I	Style II	Style I	Style II
30	330R	2.72" (69)	2.72" (69)	3.40" (86)	3.40" (86)	3.89" (99)	3.89" (99)	3.19" (81)	3.19" (81)	1.37" (35)	1.37" (35)
	430R	2.72" (69)	2.72" (69)	3.40" (86)	3.40" (86)	3.89" (99)	3.89" (99)	3.19" (81)	3.19" (81)	1.37" (35)	1.37" (35)
	530R	2.72" (69)		3.40" (86)		3.89" (99)		3.19" (81)		1.37" (35)	
60	360R	3.50" (89)	3.50" (89)	4.25" (108)	4.25" (108)	4.66" (118)	4.66" (118)	4.42" (112)	4.42" (112)	1.54" (39)	1.54" (39)
	460R	3.50" (89)	3.50" (89)	4.25" (108)	4.25" (108)	4.66" (118)	4.66" (118)	4.42" (112)	4.42" (112)	1.54" (39)	1.54" (39)
	560R	3.50" (89)		4.25" (108)		4.66" (118)		4.42" (112)		1.54" (39)	
100	3100R	3.50" (89)	3.50" (89)	4.25" (108)	4.25" (108)	4.66" (118)	4.70" (119)	5.30" (135)	5.30" (135)	1.54" (39)	1.54" (39)
	4100R	3.50" (89)	3.50" (89)	4.25" (108)	4.25" (108)	4.66" (118)	4.70" (119)	5.30" (135)	5.30" (135)	1.54" (39)	1.54" (39)
	5100R	3.50" (89)		4.25" (108)		4.66" (118)		5.30" (135)		1.54" (39)	
200	3200R		6.50" (165)		7.00" (177)		5.63" (143)		7.76" (197)		.99" (25)
	4200R	6.50" (165)	6.90" (170)	7.00" (177)	7.39" (187)	5.63" (143)	5.63" (143)	7.76" (197)	7.76" (197)	.99" (25)	.99" (25)
	5200R	6.90" (170)		7.39" (187)		5.63" (143)		7.76" (197)		.99" (25)	

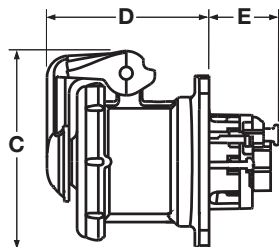
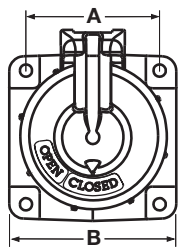

30, 60 and 100 Amp

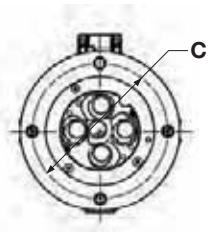
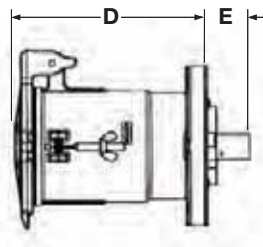
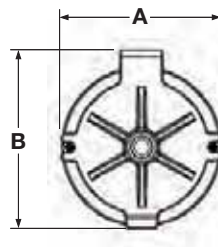

200 Amp

## Plug Dimensions

Amps	Type	A		B		Cord Grip Range
		Style I	Style II	Style I	Style II	
30	330P	7.53" (191)	7.53" (191)	3.00" (76)	3.00" (76)	.375-1.20" (9.5-30.5)
	430P	7.53" (191)	7.53" (191)	3.00" (76)	3.00" (76)	.375-1.20" (9.5-30.5)
	530P	7.53" (191)		3.00" (76)		.375-1.20" (9.5-30.5)
60	360P	9.40" (239)	9.40" (239)	3.40" (86)	3.40" (86)	.500-1.45" (12.7-36.8)
	460P	9.40" (239)	9.40" (239)	3.40" (86)	3.70" (94)	.500-1.45" (12.7-36.8)
	560P	9.40" (239)		3.70" (94)		.500-1.45" (12.7-36.8)
100	3100P	10.70" (272)	10.70" (272)	3.70" (94)	3.70" (94)	.925-1.94" (27.0-49.3)
	4100P	10.70" (272)	10.90" (277)	3.70" (94)	4.00" (102)	.925-1.94" (27.0-49.3)
	5100P	10.90" (277)		4.00" (102)		.925-1.94" (27.0-49.3)
200	3200P		11.13" (282)		6.35" (161)	1.00-2.50" (25.4-63.5)
	4200P	11.13" (282)	11.13" (282)	6.35" (161)	6.70" (170)	1.00-2.50" (25.4-63.5)
	5200P	11.13" (282)		6.70" (170)		1.00-2.50" (25.4-63.5)

## Connector Body Dimensions

Amps	Type	A		B		Cord Grip Range
		Style I	Style II	Style I	Style II	
30	330C	8.38" (213)	8.38" (213)	3.74" (95)	3.74" (95)	.375-1.20" (9.5-30.5)
	430C	8.38" (213)	8.38" (213)	3.74" (95)	3.74" (95)	.375-1.20" (9.5-30.5)
	530C	8.38" (213)		3.74" (95)		.375-1.20" (9.5-30.5)
60	360C	9.90" (251)	9.90" (251)	3.50" (89)	3.50" (89)	.500-1.45" (12.7-36.8)
	460C	9.90" (251)	10.10" (256)	3.50" (89)	3.80" (96)	.500-1.45" (12.7-36.8)
	560C	10.10" (256)		3.80" (96)		.500-1.45" (12.7-36.8)
100	3100C	11.70" (297)	11.70" (297)	4.50" (114)	4.50" (114)	.925-1.94" (27.0-49.3)
	4100C	11.70" (297)	11.90" (302)	4.50" (114)	4.70" (119)	.925-1.94" (27.0-49.3)
	5100C	11.90" (302)		4.70" (119)		.925-1.94" (27.0-49.3)
200	3200C		13.65" (346)		7.00" (177)	1.00-2.50" (25.4-63.5)
	4200C	13.65" (346)	13.65" (346)	7.00" (177)	7.39" (187)	1.00-2.50" (25.4-63.5)
	5200C	13.65" (346)		7.39" (187)		1.00-2.50" (25.4-63.5)

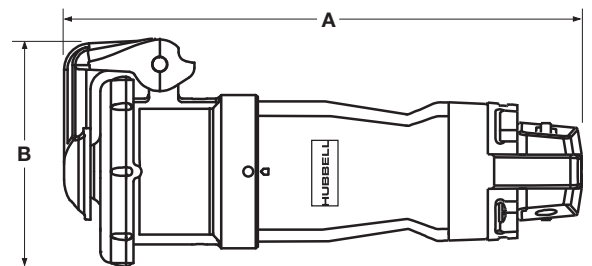
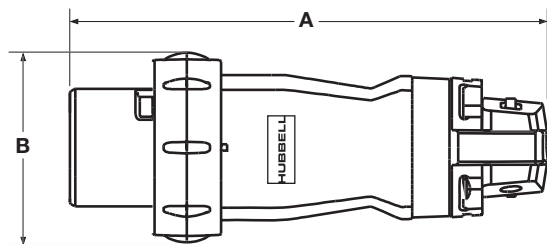

Dimensions in Inches (mm)

# UL 1686 C1 Pin and Sleeve Insulgrip® Pin and Sleeve Device Dimensions

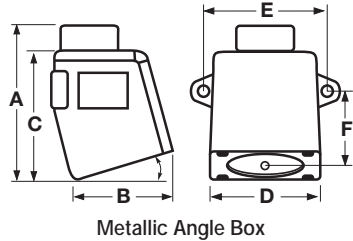

Metallic Angle Box

## Metallic Angle Back Box

Description	NPT Hub Size	A Inch (mm)	B Inch (mm)	C Inch (mm)	D Inch (mm)	E Inch (mm)	F Inch (mm)	Catalog Number
30° Angle back box for 30A devices.	¾"	4.87" (124.0)	2.94" (75.0)	4.02" (102.0)	3.40" (86.0)	4.25" (108.0)	2.12" (54.0)	<b>MB301W</b>
	1"	4.87" (124.0)	2.94" (75.0)	4.02" (102.0)	3.40" (86.0)	4.25" (108.0)	2.12" (54.0)	<b>MB302W</b>
15° Angle back box for 60A devices.	1"	–	4.80" (121.9)	–	–	5.25" (133.4)	2.69" (68.3)	<b>MB601W</b>
	1¼"	–	4.80" (121.9)	–	–	5.25" (133.4)	2.69" (68.3)	<b>MB602W</b>
	1½"	–	4.80" (121.9)	–	–	5.25" (133.4)	2.69" (68.3)	<b>MB603W</b>

## Metallic Feed-Thru Back Box

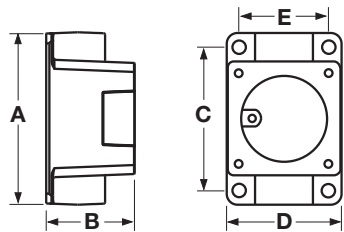

Metallic Feed-Thru Box

Description	NPT Hub Size	A Inch (mm)	B Inch (mm)	C Inch (mm)	D Inch (mm)	E Inch (mm)	F Inch (mm)	Catalog Number
Back box for 30A devices.	¾"	5.35" (136.0)	2.91" (74.0)	4.53" (115.0)	3.59" (91.0)	2.62" (67.0)	–	<b>MB303W</b>
	1"	5.35" (136.0)	2.91" (74.0)	4.53" (115.0)	3.59" (91.0)	2.62" (67.0)	–	<b>MB304W</b>
Back box for 60A devices.	1"	6.50" (165.1)	3.80" (97.0)	5.75" (146.1)	4.50" (114.3)	3.50" (88.9)	–	<b>MB604W</b>
	1¼"	6.50" (165.1)	3.80" (97.0)	5.75" (146.1)	4.50" (114.3)	3.50" (88.9)	–	<b>MB605W</b>
	1½"	6.50" (165.1)	3.80" (97.0)	5.75" (146.1)	4.50" (114.3)	3.50" (88.9)	–	<b>MB606W</b>

## Metallic Four-Way Angle Back Box

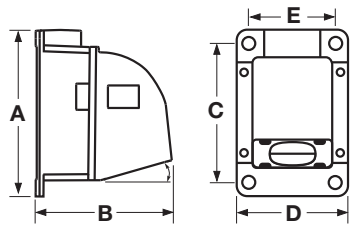

Metallic Four-Way Angle Box

Description	NPT Hub Size	A Inch (mm)	B Inch (mm)	C Inch (mm)	D Inch (mm)	E Inch (mm)	F Inch (mm)	Catalog Number
15° Angle four-way box for 60 and 100A devices.	1¼"	7.92" (201.0)	8.52" (216.0)	7.00" (178.0)	6.14" (156.0)	4.88" (124.0)	–	<b>MB601002W</b>
	1½"	7.92" (201.0)	8.52" (216.0)	7.00" (178.0)	6.14" (156.0)	4.88" (124.0)	–	<b>MB601003W</b>
	2"	7.92" (201.0)	8.52" (216.0)	7.00" (178.0)	6.14" (156.0)	4.88" (124.0)	–	<b>MB601004W</b>
45° Angle four-way box for 200A devices.	2"	10.82" (274.8)	9.86" (250.4)	9.50" (241.3)	8.17" (207.5)	6.75" (171.5)	–	<b>MB2003W</b>
	2½"	10.82" (274.8)	9.86" (250.4)	9.50" (241.3)	8.17" (207.5)	6.75" (171.5)	–	<b>MB2004W</b>
45° Angle adapter only for 200A devices.	–	8.00" (203.2)	6.00" (152.4)	7.00" (178.0)	8.00" (203.2)	7.00" (178.0)	–	<b>AA20045</b>

## Metallic Four-Way Feed-Thru 15° Angle Back Box

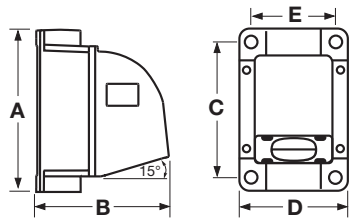

Metallic Feed-Thru Angle Box

Description	NPT Hub Size	A Inch (mm)	B Inch (mm)	C Inch (mm)	D Inch (mm)	E Inch (mm)	F Inch (mm)	Catalog Number
Four-way Feed-thru box for 60 and 100A devices.	1¼"	7.98" (202.7)	8.55" (217.2)	7.00" (178.0)	6.14" (156.0)	4.88" (124.0)	–	<b>MB601006W</b>
	1½"	7.98" (202.7)	8.55" (217.2)	7.00" (178.0)	6.14" (156.0)	4.88" (124.0)	–	<b>MB601007W</b>
	2"	7.98" (202.7)	8.55" (217.2)	7.00" (178.0)	6.14" (156.0)	4.88" (124.0)	–	<b>MB601008W</b>

Note: These boxes are cast aluminum, suitable for IP54 requirements and are finished with enamel paint.

Dimensions in Inches (mm)



# UL 1686 C1 Pin and Sleeve Technical Information

Insulgrip® Pin and Sleeve Device Listings

## Materials (30, 60, 100, and 200 Amp)

Plug	Material
Housing	Valox® 357 (200A Aluminum)
Plug Shroud	Aluminum
Cord Clamps	Rynite® SST35 (200A Aluminum)
Clamp Nut	Nickel Plated Brass
Gland Cap	Rynite® SST35
Gland	Neoprene
O-Rings, Gaskets & Seals	Neoprene
Contact Carrier	Thermoset Polyester
Retainer	Thermoset Polyester
Sleeves	Brass (M-Series - Nickel-plated tellurium copper)
Box Terminal	Heat Treated & Zinc Plated Steel
Screws (Terminal, Assembly & Set)	Stainless Steel (300 Series)
Ground Standoff	Brass
Ground Bracket	Nickel Plated Spring Bronze
Locking Ring	Epoxy Painted Aluminum
<b>Connector Body</b>	
Housing	Valox® 357 (200 Amp Aluminum)
Connector Shroud	Epoxy Painted Aluminum
Cord Clamps	Rynite® SST35
Clamp Nut	Nickel Plated Brass
Gland Cap	Rynite® SST35 (200A Aluminum)
Gland	Neoprene
O-Rings, Gaskets & Seals	Neoprene
Contact Carrier	Thermoset Polyester
Retainer	Thermoset Polyester
Pin	Brass (M-Series - Nickel-plated tellurium copper)
Pin Spring	Beryllium Copper
Box Terminal	Heat Treated & Zinc Plated Steel
Screws (Terminal, Assembly & Set)	Stainless Steel (300 Series)
Ground Standoff	Brass
Ground Bracket	Nickel Plated Spring Bronze
Cover	Epoxy Painted Aluminum
Cover Arm	Epoxy Painted Aluminum
Spring Guide	Stainless Steel (300 Series)
Springs (Arm & Wave)	Stainless Steel (300 Series)
Spring Washer	Stainless Steel (300 Series)
Hinge Bushing	Aluminum
Rivet	Aluminum
<b>Receptacle</b>	
Housing/Flange	Epoxy Painted Aluminum
O-Rings, Gaskets & Seals	Neoprene
Contact Carrier	Thermoset Polyester
Retainer	Thermoset Polyester
Pin	Brass (M-Series - Nickel-plated tellurium copper)
Pin Spring	Beryllium Copper
Box Terminal	Heat Treated & Zinc Plated Steel
Screws (Terminal, Assembly & Set)	Stainless Steel (300 Series)
Ground Standoff	Brass
Ground Bracket	Steel
Cover	Epoxy Painted Aluminum
Cover Arm	Epoxy Painted Aluminum
Spring Guide	Stainless Steel (300 Series)
Springs (Arm & Wave)	Stainless Steel (300 Series)
Spring Washer	Stainless Steel (300 Series)
Hinge Bushing	Aluminum
Rivet	Aluminum

Valox® is a trademark of SABIC Innovative Plastics, acquired from General Electric Company.  
Rynite® is a registered trademark of E.I. DuPont Corp.

## Typical Specification

Manufacturer's ID	Hubbell HBL430PS2W
Description	Plug, Power Supply
Electrical Type	3 Pole + Earth
Max. Rating	30 Amp, 600V AC, 250V DC, 50-400Hz
Configuration	UL 1686, Watertight, C1 Configuration
Certification	UL Listed, UL Standard 1682, UL 50, and UL 1010 (plugs only), CSA Certified to CSA Spec. C22.2 No. 182.1, No. 94 and No. 159 (plugs only), UL Listed and CSA Certified Type 4X

## Performance

Electrical	
Dielectric Voltage	Withstands 3,000V AC.
Max. Working Voltage	600V AC RMS (i.e., minimum creepage and clearance distance of 6.4 millimeters, per UL 1682).
Current Interrupting	Certified for current interrupting at full rated current.
Temperature Rise	Max. 30°C temperature rise at full rated current after 50 cycles of overload at 150% of rated current.
Endurance	Up to 1,000 connect and disconnect cycles at full rated current and voltage.
Mechanical	
Impact Resistance	Per CSA C22.2, No. 182.1, UL 1682.
Cord Grip Cable Retention	Per CSA C22.2, No. 182.1, UL 1682.
Cord Accommodation	Round portable service cords of diameters commensurate with the device rating as defined in UL Standard 62, CSA C22.2 No. 49 and the harmonized <HAR> European Standards.
Terminal Identification	Terminals identified in accordance with UL 1686 (1, 2, 3, Green).
Product Identification	Identification and ratings are permanently fastened to the device housing.
Environmental	
Hose Down & Moisture Resistance	Type 3, 4, 4X per UL 50E and CSA 22.2, No. 94.
Flammability (Enclosure)	UL 94V-0 and CSA C22.2 No. 0.17.
Operating Temperatures	Maximum Continuous 75°C; Minimum -40°C without impact -25° with impact.
Hazardous Location (30, 60 & 100A) (plug only)	Class I, Division I & II, Groups B, C & D and Class II, Division I & II, Groups F & G per UL 1010 & CSA 22.2, No. 159.
Materials	
Housings	Valox® 357 (200A Aluminum).
All Other Materials	Resistant to corrosion and chemical attack.

## Watertight Application Guide

Industry	Watertight.
Agriculture	Outdoor for fans, heaters, pumps, etc.
Chemical Processing	Where subject to water, corrosion.
Construction	Outdoors subject to severe weather conditions.
Entertainment	Outdoors subject to severe weather.
Food Processing	Where subject to water, corrosion.
Food Service	Areas subject to wash downs & heavy cleaning.
Light Manufacturing	Subjected to cleaning, solvents & chemicals.
Manufacturing	Where subject to water, corrosion.
Military	Outdoor construction or maintenance.

# Pin and Sleeve Insulgrip® Mechanical Interlocks

Features and Benefits

Non-metallic enclosure meets UL 50E Type 4X (watertight), 12 (dust-tight) and IP66 suitability requirements. Enclosure is molded of rugged thermoplastic Valox® to resist abuse, corrosion and enhance safety. All external hardware is stainless steel

Three “molded in” conduit drill points are located on the top, bottom, and back surface of enclosure. Conduit hub provided: 30A 1 inch NPT, 60A 1 1/4 inch NPT

Adjustable mounting feet (4) can be mounted in any 1 of 3 positions for ease of installation



The patented Plug-Check™ mechanism detects the presence of the plug. It operates as a clutch to engage the handle with the switch and captures the plug. This action prevents the plug from being removed until the switch is turned OFF

High visibility red handle can be locked in the OFF position as a method of compliance with OSHA lockout requirements. Accepts up to a 5/16 inch padlock shackle

Removable door for ease of wiring and installation

Spring-loaded receptacle liftcover with gasket ensures dust tight rating; liftcover provides watertight seal when turned and locked

**HBL430MIFS2W**



Conduit hub and mounting feet are supplied with each Insulgrip® Mechanical Interlock



Compact Fused Disconnect Switch accepts Class “J” fuses. Fuse holders are top mounted for easy access. The switch accepts auxiliary contacts for control circuit applications including the ON/OFF control of remote pilot lights or signal for programmable controllers.



Thermoset polyester contact carrier provides resistance to electrical tracking and withstands higher temperatures. Thermoset properties provide excellent dimensional stability, low moisture absorption, and superior dielectric strength.



Stainless steel 1/4 turn door fasteners for quick, easy access to fuses.



Enclosure door can be locked to prevent unauthorized access. Additionally, if the switch is ON, the door cannot be opened.

Valox® is a trademark of SABIC Innovative Plastics, acquired from General Electric Company.

Type 4X\*\*

**Style II - Fused**

Rating				Insulgrip® Mechanical Interlocks	
Amps	Poles and Wires	Receptacle/ Connector Configuration*	Maximum Voltage AC/DC	Mechanical Interlock	Mating Plug
30	3P 4W		600/250	HBL430MIFS2W	HBL430PS2W
60	3P 4W		600/250	HBL460MIFS2W	HBL460PS2W

**Style II - Unfused**

Rating				Insulgrip® Mechanical Interlocks	
Amps	Poles and Wires	Receptacle/ Connector Configuration*	Maximum Voltage AC/DC	Mechanical Interlock	Mating Plug
30	3P 4W		600/250	HBL430MIS2W	HBL430PS2W
60	3P 4W		600/250	HBL460MIS2W	HBL460PS2W



Note: 30A – 1 inch NPT hub supplied; 60A – 1¼ inch hub supplied.

**CAUTION:** To avoid electrical shock, review premises carefully and DO NOT use if Pin and Sleeve configuration (design) is already in a circuit having a rating differing from the rating of this device.

\*\*While in use or with cover closed.

**Replacement Auxiliary Contacts**

Description	Black Style Switch	Gray Style Switch
Auxiliary contact, normally open, A600 pilot duty, break before break.	ACFSNO	HBLACFSNO
Auxiliary contact, normally closed, A600 pilot duty, break before break.	ACFSNC	HBLACFSNC

Note: Auxiliary contacts are specific to the style switch noted and are NOT interchangeable.

**Replacement Switches**

Description	Black Style Switch	Gray Style Switch
For 30A fused switches.	30MIFRS	HBL30MIFRS
For 60A fused switches. Gray Style switch will retro fit Black Style switch.	—	HBL60MIFRS
For 30A unfused switches.	30MISRS	HBL30MISRS
For 60A unfused switches. Gray Style switch will retro fit Black Style switch.	—	HBL60MISRS

Note: If replacing a Black Style switch, you must use the 30MIFRS. All other applications can use the Gray Style switch.



MICPK30

**Watertight Closure Plug Kits**

Description	Catalog Number
For 30A Circuit-Lock® unfused and fused Pin and Sleeve mechanical interlocks.	MICPK30
For 60 and 100A Circuit-Lock® unfused and fused Pin and Sleeve mechanical interlocks.	MICPK60



HBLRFT2

**Replacement Mounting Feet**

Description	Catalog Number
Replacement mounting feet and screws for 30 and 60A fused mechanical interlocks.	HBLRFT2 <sup>Δ</sup>

Note: <sup>Δ</sup>Package of 10 feet and 10 screws.

# Pin and Sleeve Technical Information

Specifications, HP Ratings and Dimensions

## Typical Specifications

Manufacturer's Identification	Hubbell HBL460MIFS2W
Description	Fused Insulgrip® Pin and Sleeve Mechanical Interlock
Electrical Type	3 Pole + Earth
Rating	60A, 250VDC/600VAC
Configuration	Per UL 1686 C1
Enclosure Type (UL 50E)	Outdoor - 4X (Watertight, Washdown) Indoor - 12 (Dust Tight, Falling Dirt)
Ingress Protection Certification	IP66 Suitability UL Listed for US and Canada

*Note: This device provides fused switched control of a plug connected load and includes an interlocking feature to prevent the plug from being disconnected or the door from opening while the receptacle is energized. The switch cannot be turned on until the plug is fully inserted.*

## Materials

Part	Material
Base, Door and Handle	Valox®
Conduit Hub	Zinc, 30A – 1 in., 60A – 1¼ in. NPT
Enclosure Gasket and Shaft Seal	Neoprene
Shaft and Mounting Inserts	Brass
Ground Plate	Galvanized Steel
Enclosure Screws and Hinge Spring	Stainless Steel
Hinge Pin	Nickel-Plated Brass
Contact Carrier	Thermoset Polyester

## Horsepower Ratings

### 30A Horsepower Ratings

3 Phase A.C.	Standard	Maximum*
200-240V	3	7.5
480V	5	15
600V	7.5	20

### 60A Horsepower Ratings

3 Phase A.C.	Standard	Maximum*
200-240V	7.5	15
480V	15	30
600V	15	50

*Note: \*Requires time delay fuses.*

## Dimensions

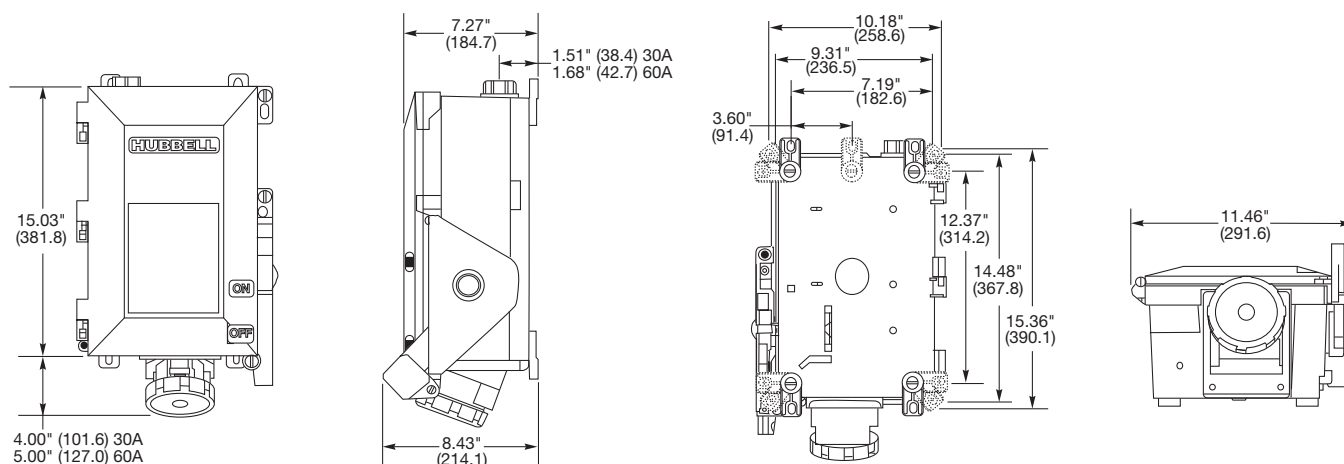

*Note: 30A – 1 inch NPT hub supplied; 60A – 1¼ inch hub supplied.*

Dimensions in Inches (mm)

Valox® is a trademark of SABIC Innovative Plastics, acquired from General Electric Company.

## Performance

Electrical	
Dielectric Voltage	Withstands 3,000VAC Min.
Max. Working Voltage	250VDC/600VAC.
Current Interrupting	Certified for current interrupting at full rated current and voltage.
Short Circuit Withstand Rating	Suitable for use on a circuit capable of delivering not more than 200,000 RMS symmetrical amperes at the voltage rating of receptacle.
Operations	Mechanical 10,000 cycles minimum.
Mechanical	
Impact Resistance	In accordance with UL 746C.
Terminal Identification	In accordance with UL, CSA and international conventions.
Product Ratings	Ratings are part of the external label and molded into the receptacle housing.
Mounting	External adjustable feet.
Environmental	
Moisture Resistance	Outdoor - 4X (Watertight, Washdown); Indoor - 12 (Dust-tight, Falling dirt).
Ingress Protection	IP66 Suitability.
Flammability	UL94-5VA and V-0 Classification.
Operating Temperatures	Max. Continuous +60°C; Min. Continuous -40°C w/o impact.
UV Resistance	All exposed insulating materials are UV stabilized.
Fuse Types	UL Listed Class "J". CSA Certified HRCI-J.

**Hazardous Location Non-Fused UL1686 Mechanical Interlocks and Plugs**

Hubbell's hazardous location line of non-fused mechanically interlocked disconnect switches are typically used for applications with the presence of flammable gasses or vapors, ignitable dusts and fibers. They are also suitable for use in outdoor or indoor damp, wet and dirty locations or in areas where frequent wash downs, heavy rain, or water spray routinely occurs. These switches are compact in size to reduce cost and make it easier to position on the wall or piece of equipment. The enclosures are made of copper-free aluminum and have a polyester/epoxy finish to prevent corrosion. The high visibility handles can be locked out to comply with OSHA lock out/tag out regulations.



VSQ Hazardous Location Ratings  
 Class I, Div. 1 & 2, Groups B,C,D  
 Class I, Zones I & 2, Groups IIB+H2, IIA  
 Class II, Div. 1 & 2, Groups F & G  
 Class III  
 NEMA 3, 4, 4X, 7 (B,C,D), 9 (F,G)

Copper-free aluminum construction with electrostatically applied polyester/epoxy finish to prevent corrosion

Large visible rotary handle with "On-Off" indicator allows a quick means of disconnecting power



Lockable handle to meet OSHA Lockout/Tagout regulations

Compact NEMA 4X enclosure and footprint allows easy installation in tight locations

**HBLVSQ3034**



**HBLVP3485**

**Features**

- Product is UL1686 and is fully interchangeable with other UL1686 configured and listed devices.
- NEMA 4X with receptacle lid turned shut or with plug locking ring tightened.
- Handle mechanism is chemical resistant Valox® (TM Sabic) thermoplastic.
- Plug and switch are interlocked. Switch cannot be turned "ON" without fully inserted plug. Plug cannot be removed with switch in "ON" position.
- Plug held in place when switch is "Off" for convenience. Pull operated release mechanism.
- Auxiliary Contact (late-make early-break) contact rated 10 Amp, 1/3 HP at 125/250VAC. Can be used for operating pilot lights or starter coils.
- Feed-through construction.
- Internal switch horsepower rated as "suitable as a motor disconnect".

*Valox® is a trademark of SABIC Innovative Plastics, acquired from General Electric Company.*

# Control Products

## Wiring Devices for Hazardous Locations

30 and 60 Ampere



HBLVSQ3034

### 30 and 60 Amp Non-Fused UL1686 Mechanical Interlocks and Plugs



Amp	Circuit	Mechanical Interlock	Plug
30 Amp 600V AC	2W 3P	<b>HBLVSQ3023</b>	<b>HBLVP3385</b>
	3W 4P	<b>HBLVSQ3034</b>	<b>HBLVP3485</b>
60 AMP 600V AC	2W 3P	<b>HBLVSQ6023</b>	<b>HBLVP6385</b>
	3W 4P	<b>HBLVSQ6034</b>	<b>HBLVP6485</b>

Note: HBLVSQ 30 Amp models come standard with 1" drilled and tapped conduit openings top and bottom plus two 1" x 3/4" reducers and one 3/4" close-up plug for maximum flexibility. 60 amp models come with one 1 1/2" opening on top and bottom and one 1 1/2" close-up plug.



HBLVP3485

### Horsepower Ratings (VAC)\*



Amp	Circuit	120	240	480	600
30 Amp	1Ø	2	5	10	15
	3Ø	3	7.5	15	20
60 Amp	1Ø	–	10	15	20
	3Ø	–	10	25	30

Note: \*Internal switch only.

### Dimensions

Mechanical Interlocks	A	B	C	D	E	F
30A	5.75 (146)	10.50 (267)	9.75 (248)	3.75 (95)	3.13 (79)	8.13 (206)
60A	8.13 (206)	14.16 (360)	11.28 (287)	4.03 (102)	2.50 (64)	11.38 (289)

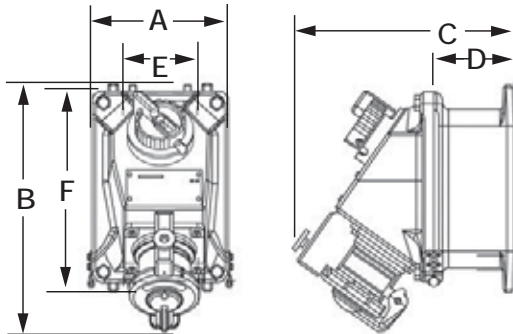

Plugs	A	B	C	D	E
30A Both	6.69 (170)	3.00 (76)	1.88 (48)	5.38 (137)	2.53 (64)
60A, 3 Pole	8.81 (224)	3.38 (86)	2.25 (57)	6.50 (165)	3.00 (76)
60A, 4 Pole	8.81 (224)	3.69 (94)	2.53 (64)	6.50 (165)	3.00 (76)

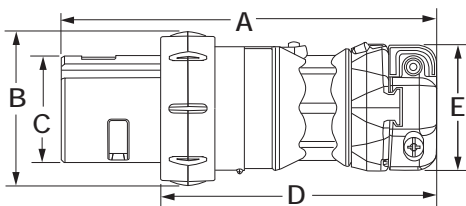

Dimensions in Inches (mm)

Wire Range	30A	60A
Reg. Stranded	#10 – #6	#6 – #4
Extra Flex	#10 – #8	#6 – #4
Grip Range	.55–1.2 (14–30)	.65–1.5 (16–38)

# Section H Single Pole Devices and Temporary Power

## Index

Single Pole Devices	Page
<b>Series 15 - 150 Ampere, 600V AC/250V DC</b>	
Plugs, Receptacles, Protective Caps and Snap Back Covers . . . . .	H-3
Tees, Gender Reversing, Replacement Bodies and Accessories . . . . .	H-4
<b>Series 16 - 300 and 400 Ampere, 600V AC/250V DC</b>	
Plugs, Receptacles, Protective Caps, Snap Back Covers and Weather Protective Covers . . . . .	H-6
Tees, 3-Fers, Gender Reversing Devices, Distribution Block, Replacement Bodies and Accessories . . . . .	H-7
Temporary Power	Page
Spider® II Temporary Power Boxes . . . . .	H-10
Cable Sets and Receptacles, Replacement Parts. . . . .	H-11
Temporary Power Distribution Boxes and Power Cables. . . . .	H-12
Heavy-Duty Portable Outlet Boxes, Plates and Specifications. . . . .	H-13
Pre-Wired Portable Outlet Boxes, Worklights and Accessories . . . . .	H-14

Single Pole  
Plugs and Receptacles



Single Pole Accessories



Spider® II and  
60A Class "L" Spider® II



Heavy-Duty Outlet Boxes  
and Cover Plates



## Single Pole Devices

# Series 15 and 16 - 150, 300 and 400 Ampere, 600V AC/250V DC

### Features and Benefits

Hubbell Wiring Device-Kellems offers a full line of innovative, high quality, Series 15 and Series 16 single pole plugs, receptacles and accessories.

Single pole devices are the right choice for supplying temporary electrical power distribution for entertainment, theme parks, carnival equipment, concerts, movie making, and numerous other applications requiring temporary power.

Single pole devices have been designed with ease of assembly and disassembly in mind, no special tools are required. A high strength non-conductive retaining screw is all that is needed to securely lock the contacts to the insulated sleeve.



## Male Plug

Insulgrip® Style Housing for Superior Gripping conforms to the user's hand making it easy to connect and disconnect, even with gloves on

Non-Conductive Retaining Screw locks contacts in place and allows for easy installation. Prevents contact movement within housing. Special screw thread requires fewer turns than most competitors and reduces the risk of a conductive screw being substituted

Rounded Corners reduce the possibility of catching or snagging on structures or equipment

UL Enclosure Types 3R, 4X and 12 Rating suitable for use in almost any environment

Large Raised Alignment Arrow aids in the mating of devices and provides a visual indication that the devices are properly connected

Double Cam Design provides high contact pressure and vibration resistant connection, which helps reduce operating temperatures and extends life



## Female Plug

High Conductivity Brass Contact provides improved performance by helping to reduce operating temperatures and extends life

Turn and Lock Symbol aids in the mating of devices and provides a clear indication that the devices are properly connected

Easily Identifiable Cable with cut off points for secure fit allows you to easily customize the housing to the required cable size. Makes cutting to the correct cable size very easy. Accommodates wide range of cables

Extra Long non-conductive inner sleeve reduces force required to install housing over contacts. Easier to rotate contact in body for installing retaining screw

Strip Gauge molded into every plug and receptacle housing. Simplifies installation and saves time





# Single Pole Devices Series 15 - 150 Ampere, 600V AC/250V DC

Plugs, Receptacles, Protective Caps and Weather Protective Covers



## Enclosure Types 3R, 4X, 12



### Plugs, Male

Description	Color	Male Plug
150 amp, thermoplastic elastomer, cable size #8 - #2 AWG.	Black	<b>HBL15MBK</b>
	White	<b>HBL15MW</b>
	Green	<b>HBL15MGN</b>
	Red	<b>HBL15MR</b>
	Blue	<b>HBL15MBL</b>



### Plugs, Female

Description	Color	Female Plug
150 amp, thermoplastic elastomer, cable size #8 - #2 AWG.	Black	<b>HBL15FBK</b>
	White	<b>HBL15FW</b>
	Green	<b>HBL15FGN</b>
	Red	<b>HBL15FR</b>
	Blue	<b>HBL15FBL</b>

### Receptacles, Stud Type <sup>11</sup>/<sub>16</sub>" x <sup>3</sup>/<sub>4</sub>"



Description	Color	Female Receptacles	Male Receptacles
150 amp Panel Mount, thermoplastic, cable size #8 - #2 AWG.	Black	<b>HBL15FRSBK</b>	<b>HBL15MRSBK</b>
	White	<b>HBL15FRSW</b>	<b>HBL15MRSW</b>
	Green	<b>HBL15FRSGN</b>	<b>HBL15MRSGN</b>
	Red	<b>HBL15FRSR</b>	<b>HBL15MRSR</b>
	Blue	<b>HBL15FRSBL</b>	<b>HBL15MRSBL</b>

### Receptacles, Double Set Screw



Description	Female Receptacles	Male Receptacles
150 amp Panel Mount, thermoplastic, cable size #8 - #2 AWG.	<b>HBL15FRBK</b>	<b>HBL15MRBK</b>
	<b>HBL15FRW</b>	<b>HBL15MRW</b>
	<b>HBL15FRGN</b>	<b>HBL15MRGN</b>
	<b>HBL15FRR</b>	<b>HBL15MRR</b>
	<b>HBL15FRBL</b>	<b>HBL15MRBL</b>

### Protective Caps



Description	Color	Fits Male Devices	Fits Female Devices
Fits 150 amp plugs and receptacles.	Black	<b>HBL15MCAPBK</b>	<b>HBL15FCAPBK</b>
	White	<b>HBL15MCAPW</b>	<b>HBL15FCAPW</b>
	Green	<b>HBL15MCAPGN</b>	<b>HBL15FCAPGN</b>
	Red	<b>HBL15MCAPR</b>	<b>HBL15FCAPR</b>
	Blue	<b>HBL15MCAPBL</b>	<b>HBL15FCAPBL</b>

### Weather Protective Covers



Description	Color	Catalog Number
Use with stud type or double set screw receptacles.	Black	<b>HBL15NCBK</b>
	White	<b>HBL15NCW</b>
	Green	<b>HBL15NCGN</b>
	Red	<b>HBL15NCR</b>
	Blue	<b>HBL15NCBL</b>

# Single Pole Devices Series 15 - 150 Ampere, 600V AC/250V DC



Tees, Gender Reversing Devices, Replacement Bodies and Accessories

## Enclosure Types 3R, 4X, 12

### Tees

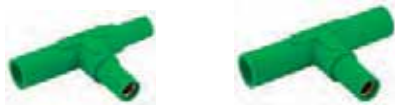

Color	Tapping Tee (Female-Female-Male)	Paralleling Tee (Female-Male-Male)
Black	HBL15TBK	HBL15PTBK
White	HBL15TW	HBL15PTW
Green	HBL15TGN	HBL15PTGN
Red	HBL15TR	HBL15PTR
Blue	HBL15TBL	HBL15PTBL

### Gender Reversing Devices



Color	Double Male (Male-Male)	Double Female (Female-Female)
Black	HBL15DMBK*	HBL15DFBK*
White	HBL15DMW	HBL15DFW
Green	HBL15DMGN	HBL15DFGN
Red	HBL15DMR*	HBL15DFR*
Blue	HBL15DMBL*	HBL15DFBL*

Note: \*Not UL listed, consult factory for availability.

### Replacement Bodies (25 Pack)



Color	Male Body	Female Body
Black	HBL15MBBK	HBL15FBBK
White	HBL15MBW	HBL15FBW
Green	HBL15MBGN	HBL15FBGN
Red	HBL15MBR	HBL15FBR
Blue	HBL15MBBL	HBL15FBBL

### Replacement Contacts (25 Pack)



Description	Male Pin	Female Sleeve
Contact, 150 amp	HBL15RCM	HBL15RCF

### Accessories

Description	Catalog Number
Accessory Kit, retaining screw, copper foil, terminal screws and brass wire.	HBL15PK
Replacement retaining screw (100 pack).	HBL15RS
Copper foil (100 pack).	HBL15CF
Brass wire (100 pack).	HBL15BW
Terminal screw - inline (100 pack).	HBL15TS25
Terminal screw - panel mount (100 pack).	HBL15TS375
Ferrule #2 AWG (100 pack).	HBL15F2
Ferrule #4 AWG (100 pack).	HBL15F4



HBL15PK



HBL15RS



HBL15CF



HBL15BW



HBL15TS25



HBL15TS375



HBL15F2  
HBL15F4

# Single Pole Devices

## Series 15 - 150 Ampere, 600V AC/250V DC

### Specifications and Dimensions

#### Specifications

Electrical	
Voltage Ratings	600V AC Maximum. 250V DC Maximum.
Amperage Rating	150A Maximum.
Mechanical	
Terminal Accommodation	Plug: #8 to #2 AWG. Recept.: #8 to #2 AWG.
Product Identification	Ratings are a permanent part of device.
Base Compound	Plug: Thermoplastic Elastomer (TPE). Recept.: Polybutylene Terephthalate (PBT).
Contact Material	Brass.
Retaining Screw Material	Nylon.

#### Certification / Environmental

UL and cUL Listed.  
UL Enclosure Types 3R, 4X, 12.  
UL 1691 standard for single pole locking-type separable connectors.  
National Electric Code (NEC), ANSI/NFPA 70.

#### Conductor Ampacity Chart (Type SC/PPC Wire)

Cable Size	Ampacity*
#8	80
#6	105
#4	140
#2	190

Note: \*90°C column NEC Table 400.5(A)(2).

#### Dimensions

##### Panel Mount Receptacles

Threaded Stud	A	B	C	D	E	F	Mounting Hole	Termination
Male	1.86" (47.2)	1.37" (34.8)	2.82" (71.6)	.86" (22.0)	.80" (20.4)	1.20" (30.5)	Through 3x Ø .20"	5/16-18 Threaded Stud
Female	1.86" (47.2)	1.37" (34.8)	2.88" (73.1)	.86" (22.0)	.80" (20.4)	1.26" (32.0)	Through 3x Ø .20"	5/16-18 Threaded Stud
Double Set Screw	A	B	C	D	E	F	Mounting Hole	Termination
Male	1.86" (47.2)	1.37" (34.8)	2.90" (73.6)	.86" (22.0)	.88" (22.2)	1.20" (30.5)	Through 3x Ø .20"	(2) 5/32 Socket Head Set Screws
Female	1.86" (47.2)	1.37" (34.8)	2.95" (74.9)	.86" (22.0)	.87" (22.2)	1.26" (32.0)	Through 3x Ø .20"	(2) 5/32 Socket Head Set Screws

Series 15 Threaded Stud

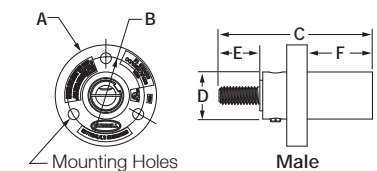

Series 15 Double Set Screw

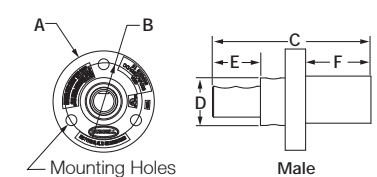

##### In Line Plugs

	A	B	C	D
Male	4.54" (115.3)	1.04" (26.4)	.86" (21.8)	3.22" (81.7)
Female	4.60" (116.8)	1.11" (28.2)	.68" (17.3)	3.28" (83.2)

Series 15 Male In Line Plug

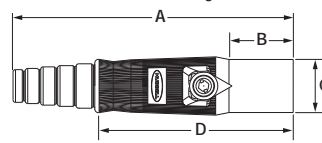

Series 15 Female In Line Plug

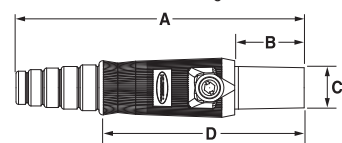

##### Gender Reversing Devices

	A	B	C
Double Male	4.22" (107.3)	.86" (21.8)	—
Double Female	4.22" (107.3)	1.05" (26.7)	.68" (17.3)

Series 15 Double Male

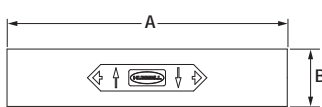

Series 15 Double Female

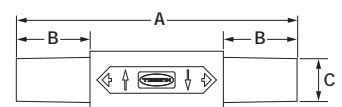

##### Tees

	A	B	C
Tapping Tee	2.67" (67.9)	4.28" (108.9)	.865" (21.9)
Paralleling Tee	2.67" (67.9)	4.22" (107.2)	.865" (21.9)

Series 15 Tapping Tee

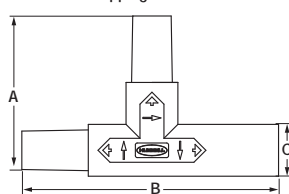

Series 15 Paralleling Tee

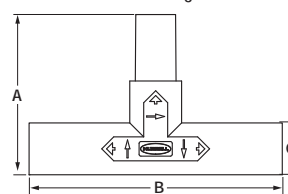

##### Weatherproof Cover

	A	B	C
Series 15	2.03" (51.5)	1.14" (29.0)	1.49" (37.9)

Series 15 Weatherproof Cover

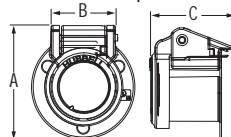

Dimensions in Inches (mm)

# Single Pole Devices

## Series 16 - 300 and 400 Ampere, 600V AC/250V DC



Plugs, Receptacles, Protective Caps, Snap Back Covers and Weather Protective Covers



### Plugs

Description	Color	Male Plug	Female Plug
300 amp, thermoplastic elastomer, cable size #6 - 2/0 AWG.	Black	HBL300MBK	HBL300FBK
	White	HBL300MW	HBL300FW
	Green	HBL300MGN	HBL300FGN
	Red	HBL300MR	HBL300FR
	Blue	HBL300MBL	HBL300FBL
	Brown	HBL300MBN	HBL300FBN
	Orange	HBL300MO	HBL300FO
Yellow	HBL300MY	HBL300FY	



Description	Color	Male Plug	Female Plug
400 amp, thermoplastic elastomer, cable size 2/0 - 4/0 AWG.	Black	HBL400MBK	HBL400FBK
	White	HBL400MW	HBL400FW
	Green	HBL400MGN	HBL400FGN
	Red	HBL400MR	HBL400FR
	Blue	HBL400MBL	HBL400FBL
	Brown	HBL400MBN	HBL400FBN
	Orange	HBL400MO	HBL400FO
Yellow	HBL400MY	HBL400FY	



### Receptacles, Female Stud Type

Description	Color	Through Hole Mounting	Threaded Mounting Holes
400 amp Panel Mount, thermoplastic elastomer, mates with 300 and 400 amp plugs.	Black	HBLFRSBK	HBLFRSCBK
	White	HBLFRSW	HBLFRSCW
	Green	HBLFRSGN	HBLFRSCGN
	Red	HBLFRSR	HBLFRSCR
	Blue	HBLFRSBL	HBLFRSCBL
	Brown	HBLFRSBN	HBLFRSCBN
	Orange	HBLFRSO	HBLFRSCO
Yellow	HBLFRSY	HBLFRSCY	



### Receptacles, Male Stud Type

Description	Color	Through Hole Mounting	Threaded Mounting Holes
400 amp Panel Mount, thermoplastic elastomer, mates with 300 and 400 amp plugs.	Black	HBLMRSBK	HBLMRSCBK
	White	HBLMRSW	HBLMRSCW
	Green	HBLMRSGN	HBLMRSCGN
	Red	HBLMRSR	HBLMRSCR
	Blue	HBLMRSBL	HBLMRSCBL
	Brown	HBLMRSBN	HBLMRSCBN
	Orange	HBLMRSO	HBLMRSCO
Yellow	HBLMRSY	HBLMRSCY	



### Receptacles, Double Set Screw

Description	Color	Female Receptacles	Male Receptacles
400 amp Panel Mount, thermoplastic elastomer, cable size #4 - 4/0 AWG, mates with 300 and 400 amp plugs.	Black	HBLFRBK	HBLMRBK
	White	HBLFRW	HBLMRW
	Green	HBLFRGN	HBLMRGN
	Red	HBLFRR	HBLMRR
	Blue	HBLFRBL	HBLMRBL
	Brown	HBLFRBN	HBLMRBN
	Orange	HBLFRO	HBLMRO
Yellow	HBLFRY	HBLMRY	



### Receptacles, Bus Bar Mount

Description	Color	Female Receptacles	Male Receptacles
400 amp Mount, thermoplastic elastomer, mates with 300 and 400 amp plugs.	Black	HBLFRBBK	HBLMRBBK
	White	HBLFRBW	HBLMRBW
	Green	HBLFRBGN	HBLMRBGN
	Red	HBLFRBR	HBLMRBR
	Blue	HBLFRBBL	HBLMRBBL
	Brown	HBLFRBBN	HBLMRBBN
	Orange	HBLFRBO	HBLMRBO
Yellow	HBLFRBY	HBLMRBY	



### Protective Caps

Color	Fits Male Devices	Fits Female Devices
Black	HBLMCAPBK	HBLFCAPBK
White	HBLMCAPW	HBLFCAPW
Green	HBLMCAPGN	HBLFCAPGN
Red	HBLMCAPR	HBLFCAPR
Blue	HBLMCAPBL	HBLFCAPBL
Brown	HBLMCAPBN	HBLFCAPBN
Orange	HBLMCAPO	HBLFCAPO
Yellow	HBLMCAPY	HBLFCAPY



### Snap Back Covers

Color	Through Hole Mounting	Threaded Mounting Holes
Black	HBLSCBK*	HBLSCCBK*
White	HBLSCW*	HBLSCCW*
Green	HBLSCGN*	HBLSCCGN*
Red	HBLSCR*	HBLSCCR*
Blue	HBLSCBL*	HBLSCCBL*
Brown	HBLSCBN*	HBLSCCBN*
Orange	HBLSCO*	HBLSCCO*
Yellow	HBLSCY*	HBLSCCY*

Note: \*3R only.



### Weather Protective Covers

Color	Catalog Number
Black	HBLNCBK
White	HBLNCW
Green	HBLNCGN
Red	HBLNCR
Blue	HBLNCBL
Brown	HBLNCBN
Orange	HBLNCO
Yellow	HBLNCY

# Single Pole Devices Series 16 - 300 and 400 Ampere, 600V AC/250V DC



Tees, 3-Fers, Gender Reversing Devices, Distribution Block, Replacement Bodies and Accessories

## Enclosure Types 3R, 4X, 12



## Tees and 3-Fers

Color	Tapping Tee (Female-Female-Male)	Paralleling Tee (Female-Male-Male)	3-Fer (Male-Female- Female-Female)	3-Fer (Female-Male- Male-Male)	Soft 3-Fer (Male-Female- Female-Female)	Soft 3-Fer (Female- Male-Male-Male)
Black	HBLTBK	HBLPTBK	HBLM3FBK	HBLF3MBK	HBLM3FSBK	—
White	HBLTW	HBLPTW	HBLM3FW	HBLF3MW	—	—
Green	HBLTGN	HBLPTGN	HBLM3FGN	HBLF3MGN	—	HBLF3MSGN
Red	HBLTR	HBLPTR	HBLM3FR	HBLF3MR	—	—
Blue	HBLTBL	HBLPTBL	HBLM3FBL	HBLF3MBL	—	—
Brown	HBLTBN	HBLPTBN	HBLM3FBN	HBLF3MBN	—	—
Orange	HBLTO	HBLPTO	HBLM3FO	HBLF3MO	—	—
Yellow	HBLTY	HBLPTY	HBLM3FY	HBLF3MY	—	—

## Gender Reversing Devices



Color	Double Male (Male-Male)	Double Female (Female-Female)
Black	HBLDMBK	HBLDFBK
White	HBLDMW	HBLDFW
Green	HBLDMGN	HBLDFGN
Red	HBLDMR	HBLDFR
Blue	HBLDMBL	HBLDFBL
Brown	HBLDMBN	HBLDFBN
Orange	HBLDMO	HBLDFO
Yellow	HBLDMY	HBLDFY

## Distribution Block (1-Male, 6-Females)

Color	Catalog Number
Black	HBL7DBBK
White	HBL7DBW
Green	HBL7DBGN
Red	HBL7DBR
Blue	HBL7DBBL
Brown	HBL7DBBN
Orange	HBL7DBO
Yellow	HBL7DBY



## Replacement Bodies (100 Pack)



Color	Male Body	Female Body
Black	HBLMBBK	HBLFBK
White	HBLMBW	HBLFBW
Green	HBLMBGN	HBLFBGN
Red	HBLMBR	HBLFBR
Blue	HBLMBBL	HBLFBBL
Brown	HBLMBBN	HBLFBBN
Orange	HBLMBO	HBLFBO
Yellow	HBLMBY	HBLFBY

## Replacement Contacts (20 Pack)



Description	Male Pin	Female Sleeve
Contact, 300 amp	HBL300RCM	HBL300RCF
Contact, 400 amp	HBL400RCM	HBL400RCF

## Accessories

Description	Catalog Number
Accessory Kit, retaining screw, copper foil, terminal screws and brass wire	HBLPK
Replacement retaining screw (500 pack)	HBLRS
Copper foil (500 pack)	HBLCF
Brass wire (500 pack)	HBLBW
Terminal screw - panel mount (500 pack)	HBLTS
Terminal screw - inline (500 pack)	HBLTSR



# Single Pole Devices

## Series 16 - 300 and 400 Ampere, 600V AC/250V DC

### Specifications and Dimensions

#### Specifications

Electrical	
Voltage Ratings	600V AC Maximum. 250V DC Maximum.
Amperage Rating	400A Maximum.
Mechanical	
Terminal Accommodation	Plug- 300A - #6 to 2/0 AWG. Plug- 400A - 2/0 to 4/0 AWG. Recept.- 400A - #4 to 4/0 AWG.
Product Identification	Ratings are a permanent part of device.
Base Compound	Thermoplastic Elastomer (TPE).
Contact Material	Brass.
Retaining Screw Material	Nylon.

#### Certification / Environmental

UL and cUL Listed.  
UL Enclosure Types 3R, 4X, 12.  
Flammability: HB per UL94 or CSA 22.2: 0.17.  
UL 498 for attachment plugs and receptacles.  
UL 1691 draft standard for single pin and sleeve devices intended for theatre, stage and studio applications (Series 16 pending).  
National Electric Code (NEC), ANSI/NFPA 70.

#### Conductor Ampacity Chart (Type SC/PPC Wire)

Cable Size	Ampacity*
#4	140
#2	190
2/0	300
4/0	405

Note: \*90°C column NEC Table 400.5(A)(2).

#### Dimensions

##### Panel Mount Receptacles

Threaded Stud	A	B	C	D	E	F	G	Mounting Hole	Termination
Male & Female w/ through hole mounting	2.20" (55.9)	2.20" (55.9)	1.50" (38.1)	4.10" (104.3)	1.48" (47.4)	1.25" (31.7)	1.74" (44.2)	Through 4x Ø .20"	1/2-13 UNC-2A Threaded Stud
Male & Female w/ threaded mounting holes	2.20" (55.9)	2.20" (55.9)	1.50" (38.1)	3.67" (93.2)	1.48" (47.4)	1.11" (28.2)	1.55" (39.4)	Threaded 4x #10-32	1/2-13 UNC-2A Threaded Stud
Double Set Screw	A	B	C	D	E	F	G	Mounting Hole	Termination
Male & Female w/ threaded mounting holes	2.20" (55.9)	2.20" (55.9)	1.50" (38.1)	4.10" (104.3)	1.48" (47.4)	1.36" (34.5)	1.74" (44.2)	Threaded 4x #10-32	(2) 7/32 Socket Head Set Screws
Busbar Type	A	B	C	D	E	F	G	Mounting Hole	Termination
Male & Female w/ threaded mounting holes	2.20" (55.9)	2.20" (55.9)	1.50" (38.1)	3.57" (90.7)	1.48" (37.6)	1.01" (25.7)	1.55" (39.4)	Threaded 4x #10-32	(1) 5/16-18 UNC-2B Threaded Hole

Series 16 Threaded Stud

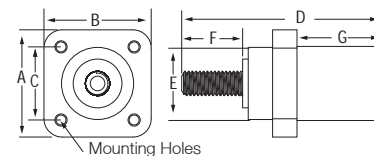

Series 16 Double Set Screw

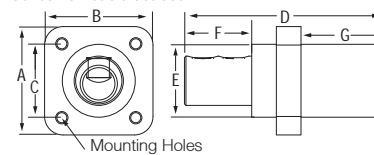

Series 16 Busbar Type

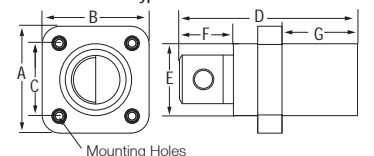

##### In Line Plugs

	A	B	C	D
Male	7.01" (178.0)	1.38" (35.1)	1.48" (37.6)	4.78" (121.4)
Female	7.10" (180.5)	1.44" (36.6)	1.06" (27.0)	4.90" (121.3)

Series 16 Inline Plug Male

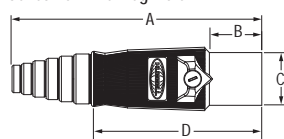

Series 16 Inline Plug Female

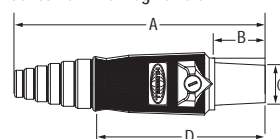

##### Gender Reversing Devices

	A	B	C
Double Male	4.65" (118.1)	1.48" (37.6)	—
Double Female	4.84" (122.9)	1.44" (36.6)	1.06" (27.0)

Series 16 Double Male

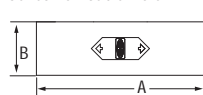

Series 16 Double Female

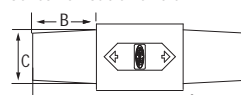

##### Tees and 3-Fers

	A	B	C
Tapping Tee	3.18" (80.8)	4.74" (120.4)	1.48" (37.6)
Paralleling Tee	3.18" (80.8)	4.65" (118.1)	1.48" (37.6)
3-Fer	5.88" (149.3)	5.78" (146.9)	1.48" (37.6)

Series 16 Tapping Tee

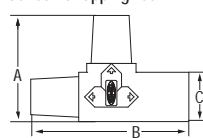

Series 16 Paralleling Tee

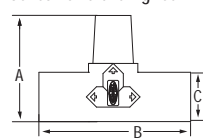

Series 16 3-FER

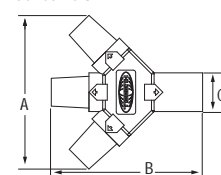

##### Covers

	A	B	C
Weatherproof Cover	2.20" (55.88)	1.16" (29.44)	2.03" (51.5)
Snap Back Cover to be used with receptacles	2.26" (57.4)	2.37" (60.2)	—

Series 16 Weatherproof Cover

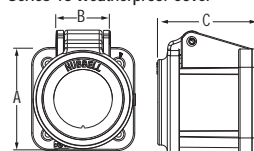

Series 16 Snap Back Cover

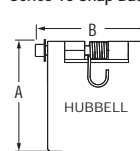

Dimensions in Inches (mm)

## Temporary Power Spider® II Temporary Power Boxes

Features and Benefits

Individual  
GFCI modules

Gasketed latching  
receptacle lift covers

Available with flush 50 Amp  
Twist-Lock® inlet or 60 Amp  
IEC reversed service Pin and  
Sleeve receptacle

Replaceable legs

Six 20 Amp straight blade  
or Twist-Lock® watertight  
receptacles

Standard stab termination circuit  
breakers with gasketed lift cover



SBSB1A

- Compact electronic supervisory circuit.
- Detailed wiring diagram.
- TYPE 3R metallic enclosure and heavy duty, abuse resistant legs.

Hubbell's Spider® II temporary power distribution system sets the safety and performance standard for temporary power needs. Construction sites and outdoor events place more demands on electrical power than ever before. Hubbell's Spider box steps up to the challenge by offering advanced electrical and safety features. The Spider II box incorporates the most advanced ground fault module technology available in the industry today, ensuring safe and reliable distribution of electrical power for a wide variety of temporary power applications.

### Breadth of Line and Innovation

Hubbell manufactures a variety of Spider II Boxes and temporary power products for both indoor and outdoor power and lighting applications. Hubbell's Spider products incorporate the most

innovative wiring devices in the Hubbell Safety Shroud Twist-Lock® system. The shrouded Twist-Lock design extends the life of the plug by protecting the blades from abuse and, more importantly, the shroud protects the user from arcing. The Spider II temporary power system incorporates Watertight Safety Shroud Twist-Lock receptacles to provide a UL Type 4X rating when the receptacles are used with Watertight Safety Shroud Twist-Lock plugs. Standard Twist-Lock and Safety Shroud Twist-Lock plugs may be used with these receptacles when water ingress during use is not a concern. To ensure an overall 3R rating when all receptacles are in use, Hubbell has also designed a weatherproof boot. This weatherproof boot for straight blade plugs maintains a 3R rating when it is used with the Spider II straight blade receptacles.

### Environmental Protection

All Pin and Sleeve, Twist-Lock and straight blade receptacles on each Spider box are protected when not in use by a gasketed, spring loaded flip lid. Hubbell has taken multiple steps to ensure that the Spider II boxes can withstand today's harsh environmental requirements and as a result, the Spider II boxes have earned a 3R enclosure rating for outdoor rainproof applications. In addition to the added safety and water resistant features, Hubbell makes the boxes user friendly by offering a full line of replacement parts for field reparability.

### Certifications

Hubbell's Spider II Boxes meet NEC requirements for personal protection against electrical shock on job sites and are listed to the latest UL 1640 standard for Portable Power Distribution Equipment.

# Temporary Power

## Spider® II Temporary Power Boxes

Ordering Information



50A Spider® II



60A Spider® II



60A Class "L" Spider® II

### Spider® II Boxes

Rating	Type	Qty	Receptacle Ratings	Receptacle Components	Protection		Catalog Number
					Overload	GFI	
30A, 120/240V AC (Maximum)	Straight Blade	7	20A, 125V	HBL53R61	Yes	Yes	<b>SDSB1A</b>
	Twist-Lock® (inlet)	1	30A, 120/240V	HBL2715SWR	No	No	
	Twist-Lock® (outlet)	1	30A, 120/240V	HBL2710	No	No	
50A, 120/240V AC (Maximum)	Straight Blade	7	20A, 125V	HBL53R61	Yes	Yes	<b>SBSB1A</b>
	Twist-Lock® (inlet)	1	50A, 125/250V	HBL6375S	No	No	
	Twist-Lock® (outlet)	1	50A, 125/250V	CS6369	No	No	
50A, 120/240V AC (Maximum)	Straight Blade	6	20A, 125V	HBL53R61	Yes	Yes	<b>SBSB2</b>
	Twist-Lock®	1	30A, 250V	HBL2620SW	Yes	Yes	
	Twist-Lock® (inlet)	1	50A, 125/250V	HBL6375S	No	No	
	Twist-Lock® (outlet)	1	50A, 125/250V	CS6369	No	No	
50A, 120/240V AC (Maximum)	Twist-Lock®	7	20A, 125V	HBL2310SW	Yes	Yes	<b>SBTL1A</b>
	Twist-Lock® (inlet)	1	50A, 125/250V	HBL6375S	No	No	
	Twist-Lock® (outlet)	1	50A, 125/250V	CS6369	No	No	
50A, 120/240V AC (Maximum)	Twist-Lock®	6	20A, 125V	HBL2310SW	Yes	Yes	<b>SBTL2</b>
	Twist-Lock®	1	30A, 250V	HBL2620SW	Yes	Yes	
	Twist-Lock® (inlet)	1	50A, 125/250V	HBL6375S	No	No	
	Twist-Lock® (outlet)	1	50A, 125/250V	CS6369	No	No	
60A, 3Ø 120/208V AC (Maximum)	Straight Blade	6	20A, 125V	HBL53R61	Yes	Yes	<b>SCSB0*</b>
	Pin and Sleeve (inlet)	1	60A, 3ØY 120/208V	HBL560B9R	No	No	
	Pin and Sleeve (outlet)	1	60A, 3ØY 120/208V	HBL560R9W	No	No	
60A, 3Ø 120/208V AC (Maximum)	Twist-Lock®	6	20A, 125V	HBL2310SW	Yes	Yes	<b>SCTLO*</b>
	Pin and Sleeve (inlet)	1	60A, 3ØY 120/208V	HBL560B9R	No	No	
	Pin and Sleeve (outlet)	1	60A, 3ØY 120/208V	HBL560R9W	No	No	

### Class "L" Spider® II Boxes

Rating	Type	Qty	Receptacle Ratings	Receptacle Components	Protection		Catalog Number
					Overload	GFI	
60A, 3Ø 120/208V AC (Maximum)	Straight Blade	6	20A, 125V	HBL53R61	Yes	Yes**	<b>SCSB0M2</b>
	Class "L" (inlet)	1	60A, 3ØY, 120/208V	—	No	No	
	Class "L" (outlet)	1	60A, 3ØY, 120/208V	—	No	No	
60A, 3Ø 120/208V AC (Maximum)	Twist-Lock®	6	20A, 125V	HBL2310SW	Yes	Yes**	<b>SCTLOM2</b>
	Class "L" (inlet)	1	60A, 3ØY, 120/208V	—	No	No	
	Class "L" (outlet)	1	60A, 3ØY, 120/208V	—	No	No	

Note: \*60A units are UL and cUL only.  
\*\*GFCI protection on 4 devices only.

### Specifications

Spider® II	
Listing/Certification	UL 1640 cUL and CSA, UL 943.
Environment	Indoor and outdoor wet and dry locations.
Enclosure Type	3R, rainproof, suitable for use in damp locations.
Code Compliance	NEC®, ANSI/NFPA 70.

### Dimensions

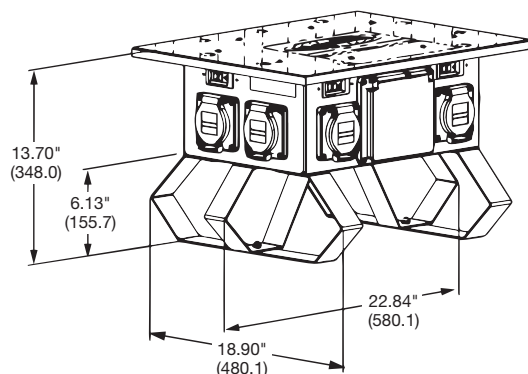

Dimensions in Inches (mm)



# Temporary Power Cable Sets and Receptacles, Replacement Parts

## Cable Sets and Receptacles

Description	Catalog Number
50A pre-wired wall mounted receptacle, with 2 ft. wire leads.	SR50
50A cord set - 50 ft. cable (input/output).	SCB50
50A cord set - 100 ft. cable (input/output).	SCB100
60A cord set - 6 ft. cable (input/output).	SCC06
60A cord set - 50 ft. cable (input/output).	SCC50
60A, 3Ø 120/208V Pin and Sleeve wall mounted receptacle.	HBL560R9W
1¼" hub 15 deg. non-metallic angle back box for 60A receptacle.	BB601W
1½" hub 15 deg. metallic 4-way angle back box for 60A receptacle.	FW60100

Note: Consult factory for alternate cable lengths.



SR50



SCB50

## Replacement Parts

Description	Catalog Number
20A, 125V straight blade receptacle.	HBL53R61
20A, 125V Safety-Shroud Twist-Lock® receptacle.	HBL2310SW
30A, 250V Safety-Shroud Twist-Lock® receptacle.	HBL2620SW
30A, Reverse Service Safety-Shroud connector.	HBL2713SR
30A, Reverse Service inlet.	HBL2715SWR
50A, 125/250V Twist-Lock® receptacle.	CS6369
50A, 125/250V Twist-Lock® inlet.	HBL6375S
60A, 3Ø 120/208V Pin and Sleeve reversed service receptacle (inlet).	HBL560B9R
60A, 3Ø 120/208V Pin and Sleeve receptacle (outlet).	HBL560R9W
60A, 3Ø 120/208V Pin and Sleeve reversed service plug (female).	HBL560P9WR
60A, 3Ø 120/208V Pin and Sleeve plug (male).	HBL560P9W
GFCI module.	GFM20
50A Spider supervisory kit.	SSK
60A Spider supervisory kit.	SSK60
Spider circuit breaker cover.	SCBC
Spider leg kit.	SLK
Spider leg kit, green.	SLKG
50A receptacle cover plate.	HBL77CM74WO



HBL2310SW



HBL2713SR



SCBC



HBL77CM74WO



GFM20



SSK

# Temporary Power

## Temporary Power Distribution Boxes and Power Cables

Ordering Information

Durable Hi Visibility Yellow  
Powder Coated Steel Construction

Individual GFCI modules

NEMA 3R Enclosure

Save space in the warehouse  
and on the truck with nesting  
leg design

Hubbell 50 Amp Twist-Lock®  
receptacle and inlet

Six 20 Amp straight blade  
or Twist-Lock® covered  
receptacles

TPDL – Twist-Lock®  
TPDS – Straight Blade



TPC50 – 50' Cable  
TPC100 – 100' Cable

### Temporary Power Distribution Boxes

Rating	Type	Qty	Receptacle Rating	Protection		Catalog Number
				Overload	GFI	
50A, 120/240V AC (Maximum)	Twist-Lock®	6	20A, 125V	Yes	Yes	<b>TPDL</b>
	Twist-Lock®	1	30A, 250V	Yes	No	
	Twist-Lock® (Inlet)	1	50A, 125/250V	No	No	
	Twist-Lock® (Outlet)	1	50A, 125/250V	No	No	
50A, 120/240V AC (Maximum)	Straight Blade	6	20A, 125V	Yes	Yes	<b>TPDS</b>
	Twist-Lock®	1	30A, 250V	Yes	No	
	Twist-Lock® (Inlet)	1	50A, 125/250V	No	No	
	Twist-Lock® (Outlet)	1	50A, 125/250V	No	No	

### Temporary Power Cables

Rating	Cable Type	Length	Male Device	Female Device	Weatherproof Boot	Catalog Number
50A, 125/250V	6/3, 8/1	50 ft.	CS6365L	CS6364L	No	<b>TPC50</b>
50A, 125/250V	6/3, 8/1	100 ft.	CS6365L	CS6364L	No	<b>TPC100</b>

### Specifications

#### Boxes

Listings/Certifications	UL 1640, UL 943
Operation	Indoor and outdoor wet and dry locations
Enclosure Type	3R, rainproof, suitable for use in damp locations
Code Compliance	NEC, ANSI/NFPA 70

#### Cables

Listings/Certifications	Connectors: UL/CSA; Cable: MSHA
Operation	Indoor and outdoor wet and dry locations

### Dimensions

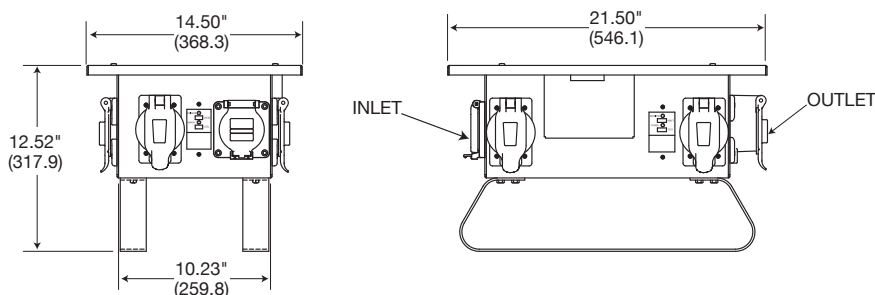

Dimensions in Inches (mm)

## Heavy-Duty Portable Outlet Boxes and Cover Plates

Description	Catalog Number
Box with cord strain relief, with one blank cover plate.	<b>HBLPOB1</b>
Box with cord strain relief, with one blank cover plate, black.	<b>HBLPOB1BK</b>
Box with cord strain relief, with two duplex (indoor) cover plates.	<b>HBLPOB1D</b>
Box with cord strain relief, with two duplex (indoor), yellow cover plates.	<b>HBLPOB1DY</b>
Blank, non-metallic FS cover plate with foam gasket, gray.	<b>HBLP14FS</b>
Duplex, non-metallic FS cover plate, gray.	<b>HBLP8FS</b>
Duplex, non-metallic FS cover plate, yellow.	<b>HBLP8FSY</b>
Single receptacle (1.39"), non-metallic FS cover plate, gray.	<b>HBLP7FS</b>
Single receptacle (1.56"), non-metallic FS cover plate, gray.	<b>HBLP720FS</b>
Rectangular opening, non-metallic FS cover plate, gray.	<b>HBLP26FS</b>



**HBLPOB1**

## Other Cover Plates and Devices

which may be used with Heavy-Duty Portable Outlet Boxes

Description	Catalog Number
Duplex cover plate, weatherproof.	<b>HBL5221, HBL52CM21</b>
Single receptacle (1.39") cover plate, weatherproof.	<b>HBL7423WO, HBL74CM23WO</b>
Single receptacle (1.56") cover plate, weatherproof.	<b>HBL7425WOA, HBL74CM25WOA</b>
Safety-Shroud Twist-Lock® surface receptacles.	<b>HBL2310SR, HBL2320SR, HBL2330SR, HBL2610SR, HBL2620SR</b>

Note: Standard product gray, CM yellow.



**Cover Plates**

## Deluxe Cord Grips Straight Male Thread Nylon Fittings, Stainless Steel Mesh, Liquidtight, for Insulated Cables

Grip Diameter Range Inches (cm)	Thread Size NPT (inches)	Form Size	Catalog Number
.375"-.500" (.95-1.27)	3/4"	F3	<b>074011335</b>
.500"-.625" (1.27-1.59)	3/4"	F3	<b>074011336</b>
.625"-.750" (1.59-1.90)	3/4"	F3	<b>074011337</b>

## Nylon Cord Connector Straight Male Thread

Grip Diameter Range Inches (cm)	Thread Size NPT (inches)	Form Size	Catalog Number
.375"-.500" (.95-1.27)	3/4"	F3	<b>SHC1035CR</b>
.500"-.625" (1.27-1.59)	3/4"	F3	<b>SHC1036CR</b>
.625"-.750" (1.59-1.90)	3/4"	F3	<b>SHC1037CR</b>



**Deluxe Cord Grips  
(purchased separately)**

## Specifications for Heavy-Duty Portable Outlet Boxes and Cover Plates

UL Listed	UL 514C, UL467 and UL50 Enclosures Types 1, 3R.
CSA Certified	C22.2 No. 18 and C22.2 No. 94 Enclosures Types 1, 3R and C22.2 No. 0.4 (Impedance).
Box Specifications:	
Moisture Resistance	Wet and damp locations, Enclosure Type 3R when used with weatherproof cover plates. Dry, indoors locations, Enclosure Type 1 with all other cover plates.
Flammability	UL 94V-0, 94-5VA classification.
Operating Temperature	80°C maximum; -35°C minimum.
UV Resistance	All materials are UV stabilized.
Impact and Crush Resistance	in accordance with UL 514C, UL50, C22.2 No. 18 and C22.2 No. 94.
Material	Valox®.
Cord Connector Materials	Nylon nut; Nylon Gotcha® ring; Neoprene grommet.
Cord Diameter Range	.38" to .75" diameter.
Bonding Strap Material	Brass.
Threaded Inserts	Brass.
Grounding Screw Material	Brass.
Indoor Cover Plate Screws Material	Zinc Plated Steel.
Outdoor Cover Plate Screws Material	Stainless Steel.
Cover Plate Gasket Material	UL recognized closed-cell foam (aging and oil resistant).

## Dimensions

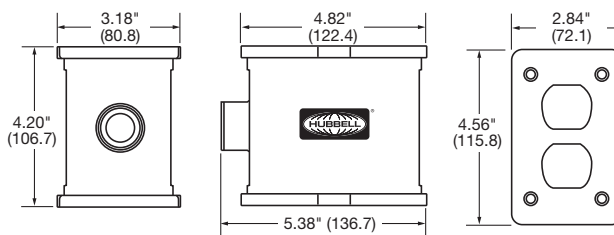

**HBLPOB1**

Valox® is a trademark of SABIC Innovative Plastics, acquired from General Electric Company.

Dimensions in Inches (mm)



**Gray Nylon  
Cord Connector**

# Temporary Power Pre-Wired Portable Outlet Boxes, Worklights and Accessories



SPB1

## Pre-Wired Portable Outlet Boxes

Description	Catalog Number
25 ft. with 2-15A, 125V, straight blade single receptacles and 1- 15A, 125V straight blade plug and boot.	SPB1
25 ft. with 2-20A, 125V, Twist-Lock® single receptacles and 1-20A, 125V Twist-Lock plug and boot.	SPB2



SPB2

## Worklights and Accessories

Description	Catalog Number
Temporary worklight with 15A, 125V straight blade plug, 25 ft. cord.	TW25F1
Temporary worklight with 20A, 125V Twist-Lock® plug, 25 ft. cord.	TW25F2
Temporary low voltage worklight with cigarette lighter plug, 20 ft. cord.	TWLV20F
Portable battery pack and charger for TWLV20F worklight.	TWBP
Non-metallic temporary worklight hook.	TWH



TW25F1

## Specifications

### Temporary Worklights

Listing/Certification	UL298 and cUL Portable Electric Hand Lamps.
Environment	Dry, indoor locations.
Fluorescent Lamp	13 watt twin tube only.

### Battery Pack and Charger

Environment	Indoor and outdoor dry locations.
Fluorescent Lamp Life	Fully charged-5 hour approx.
Charge Time	Fully charged-16 hours approx.
Battery Rating	12 volt.



TW25F2



TWLV20F

## Light Fixture

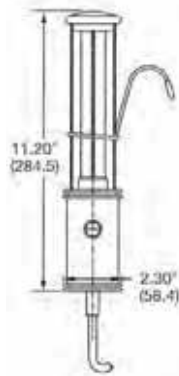

## Worklight Hook

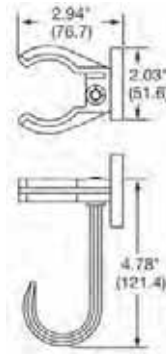

TWBP

## Battery Pack and Charger

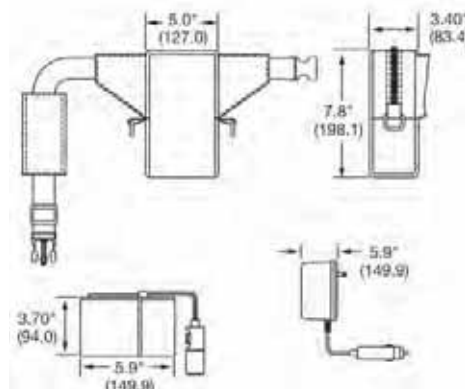

TWH

Dimensions in Inches (mm)



# Section I Industrial Connectivity and Control Products

## Index

Product	Page
<b>LINKOSITY® Power Components</b>	
Power Components . . . . .	I-2
Control Integration Components . . . . .	I-3
Power System Distribution Assemblies . . . . .	I-4
MotorQuick® Disconnect Switches . . . . .	I-7
<b>Mini-Quick® Control Connectors</b> . . . . .	I-8
2-6 Pole Plugs and Receptacles . . . . .	I-9
7-12 Pole Plugs and Receptacles . . . . .	I-13
Field Attachable Connectors - Screw Terminal Style . . . . .	I-17
<b>Micro-Quick® Control Connectors</b> . . . . .	I-18
Single Key 3-5 Pole Plugs and Receptacles . . . . .	I-19
Dual Key 2-6 Pole Plugs and Receptacles . . . . .	I-23
Field Attachable Connectors - Screw Terminal Style . . . . .	I-27
Field Attachable Connectors - IDC Style . . . . .	I-28
<b>Nano-Quick® Control Connectors</b> . . . . .	I-29
3-4 Pole Plugs and Receptacles . . . . .	I-30
Field Attachable Connectors - IDC Style . . . . .	I-32
<b>Signal-Quick® Sensor Mounting Accessories</b>	
Cushioned Sensor Mounts . . . . .	I-33
Flat and Right Angle Adjustable and Fixed Brackets . . . . .	I-34
End Caps and Block Mounts . . . . .	I-35
Universal Aiming Brackets . . . . .	I-36
<b>CableTrak® Hose and Cable Carrier System</b> . . . . .	I-37
CableTrak® Kit with and without Brackets . . . . .	I-38
Accessories . . . . .	I-39
Mounting Options and Specifications . . . . .	I-40
<b>DIN Rail Utility Box</b>	
Power and Data . . . . .	I-41
<b>PANEL-SAFE®</b> . . . . .	I-42
Power and Data Access Ports . . . . .	I-43
<b>HI-Impact</b>	
Industrial Ethernet Connector and Harsh Environment Connectors . . . . .	I-44



**Cables and Receptacles**

Device Type	Ratings	Wires	Conductor Colors**	Length (FT)
 <b>PH</b> = Double Ended Cable with Male/Female Straight <b>PM</b> = Male Single Ended Straight <b>PN</b> = Male Single Ended 90° <b>PF</b> = Female Single Ended Straight <b>PG</b> = Female Single Ended 90° <b>PQ</b> = Double Ended Cable with Female 90° <b>PR</b> = Double Ended Cable with Male 90° <b>PS</b> = Double Ended Cable with (2) 90° Connectors   <b>RF</b> = Female Receptacle*   <b>RM</b> = Male Receptacle (Inlet)*	<b>20</b> = 20A up to 600V	<b>02</b> <b>03</b> <b>04</b> <b>05</b>	<b>PA</b> = Green/Yellow Black (all others)	<b>001</b> = 1' <b>005</b> = 5' <b>010</b> = 10' <b>015</b> = 15' <b>020</b> = 20' <b>025</b> = 25' <b>030</b> = 30' <b>035</b> = 35' <b>040</b> = 40' <b>045</b> = 45' <b>050</b> = 50'
	20A up to 600V Specialty construction (Includes isolated ground on 6 wire and #10 AWG super neutral conductor on 5 and 6 wire devices, PB color code only)	<b>03</b> <b>04</b> <b>05</b> <b>06</b>		
	<b>30</b> = 30A up to 600V	<b>04</b>	<b>PE</b> = All Blue***	

Example: PH

23

06

PB









005

Note: \*½" NPT rear thread.

\*\*Other color codes available upon request.

\*\*\*Two wire only.

**Configurations (Male face view shown, female view is opposite)**

20 AMP				
20A SNIG (with super neutral and IG)				
30 AMP				

**Tees**

Description	Catalog Number
LINKOSITY® M/F/F Tee, 20A, 2P	TX2002002002T00
LINKOSITY® M/F/F Tee, 20A, 3P	TX2003002003T00
LINKOSITY® M/F/F Tee, 20A, 4P	TX2004002004T00
LINKOSITY® M/F/F Tee, 20A, 5P	TX2005002005T00
LINKOSITY® M/F/F Tee, 20A SNIG, 4P	TX2304002304T00
LINKOSITY® M/F/F Tee, 20A SNIG, 6P	TX2306002306T00
LINKOSITY® M/F/F Tee, 20A SNIG, A Phase Tap	TX2306002304A00
LINKOSITY® M/F/F Tee, 20A SNIG, B Phase Tap	TX2306002304B00
LINKOSITY® M/F/F Tee, 20A SNIG, C Phase Tap	TX2306002304C00
LINKOSITY® M/F/F Tee, 30A, 4P	TX3004003004T00



TX2304002304T00





CCMBC

**Closure Caps**

Description	For use with Female Receptacle	Male Inlet
20A and 30A Receptacle Closure Cap	CCMBC	CCFBC

## Cables and Receptacles

Device Type	Ratings	Wires	Conductor Colors**	Length (FT)
 <b>PH</b> = Double Ended Cable with Male/Female Straight <b>PM</b> = Male Single Ended Straight <b>PN</b> = Male Single Ended 90° <b>PF</b> = Female Single Ended Straight <b>PG</b> = Female Single Ended 90° <b>PQ</b> = Double Ended Cable with Female 90° <b>PR</b> = Double Ended Cable with Male 90° <b>PS</b> = Double Ended Cable with (2) 90° Connectors   <b>RF</b> = Female Receptacle*   <b>RM</b> = Male Receptacle (Inlet)*	<b>03</b> = 3A - 2W, 3W 3A - 4W up to 300V	<b>02</b> <b>03</b> <b>04</b>	<b>PA</b> = Green/Yellow Black (all others)	<b>001</b> = 1' <b>005</b> = 5' <b>010</b> = 10' <b>015</b> = 15' <b>020</b> = 20' <b>025</b> = 25' <b>030</b> = 30' <b>035</b> = 35' <b>040</b> = 40' <b>045</b> = 45' <b>050</b> = 50'
	<b>R3</b> = 3A - 2W, 3W 3A - 4W up to 300V	<b>02</b> <b>03</b> <b>04</b>		
	<b>10</b> = 10A - 2W, 3W 10A - 4W 10A - 5W, 6W, 7W 10A - 8W, 9W 7A - 10W, 12W up to 600V	<b>02</b> <b>03</b> <b>04</b> <b>05</b> <b>06</b> <b>07</b> <b>08</b> <b>09</b> <b>10</b> <b>12</b>	<b>PE</b> = All Blue***	

*Example: PH*

*10*

*06*

*PB*



*005*

Note: \*1/2" NPT rear thread.

\*\*Other color codes available upon request.

\*\*\*Two wire only.

## Configurations (Male face view shown, female view is opposite)

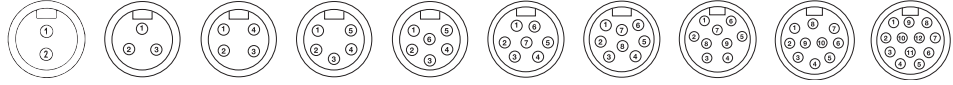
<b>03</b>		Typically used for inputs in DC control circuits
<b>R3</b>		Typically used for outputs in DC control circuits
<b>10</b>		

## Splitters/Tees

Description	Catalog Number
LINKOSITY® M/F/F Splitter, 3A/4W	TX0304000304T00
LINKOSITY® M/F/F Tee, 10A, 2 Pole	TX1002001002T00
LINKOSITY® M/F/F Tee, 10A, 3 Pole	TX1003001003T00
LINKOSITY® M/F/F Tee, 10A, 4 Pole	TX1004001004T00
LINKOSITY® M/F/F Tee, 10A, 5 Pole	TX1005001005T00
LINKOSITY® M/F/F Tee, 10A, 6 Pole	TX1006001006T00



TX1004001004T00

## Closure Caps

Description	For use with Female Receptacle	Male Inlet
3A Closure Cap	CCM1C	CCF1C
10A Closure Cap, 2, 3, 4, 4, 5 and 6 Pole	CCMAC	CCFAC
10A Closure Cap, 7 and 8 Pole	CCMBC	CCFBC
10A Closure Cap, 9, 10, 12 Pole	CCMCC	CCFCC



CCFAC

**Power System Distribution Assemblies**



Note: Accepts PH2304 series cables.

**Straight Blade - UL Type 1**

Device Type	Switch Types	# Recepts	Receptacle Type	Receptacle Feature	Pass-thru	Custom Configurations*
M	SL = Switch Local SM = Switch Master 00 = No Switch	1 2 3 4 5	SG = Spec Grade HG = Hospital Grade CR = Corrosion Resistant	IG = Isolated Ground GF = Ground Fault SS = Surge Suppression 00 = Standard	P = Pass-thru** 0 = No Pass-thru	D = 2 Circuit A = A Phase B = B Phase C = C Phase
Example: M	SL	1	SG	00	P	

**Twist-Lock® - UL Type 1**

Device Type	Switch Types	# Recepts	Receptacle Type	Receptacle Feature	Pass-thru	Custom Configurations*
M	SL = Switch Local SM = Switch Master 00 = No Switch	1 2 3 4 5	L1 = 15A L2 = 20A	IG = Isolated Ground 00 = Standard	P = Pass-thru 0 = No Pass-thru	6 = 250v
Example: M	00	3	L1	IG	0	

Note: Local switches control all receptacles in a box. Master switches control local and downstream receptacles. Consult factory for alternate wiring schemes.

\*Consult factory for wiring specifications and connecting cables.

\*\*Pass-thru on phase tap boxes are 3Ø.

**Switch Only (On/Off) - UL Type 1**

Device Type	Switch Types	Switch Style	Poles
S	1 = 1 Gang 2 = 2 Gang 3 = 3 Gang	2W = On/Off	1P = Single Pole DP = Two Pole
Example: S	1	2W	1P

**Switch Only (4-Way) - UL Type 1**

Device Type	Switch Types	Switch Style
S	1 = 1 Gang	4W = 4 Way
Example: S	1	4W

**Switch Only (3-Way) - UL Type 1**

Device Type	Switch Types	Switch Style	Position
S	1 = 1 Gang	3W = 3 Way	M = Main R = Remote LM = Line to Main LR = Load to Remote
Example: S	1	3W	M

Note: For use with Px2304PBxxx series cables.

**Features**

Receptacle Types		CR	HG	SG	L1
00	Standard	HBL53CM62	HBL8300GY	5362G	HBL4700
IG	Isolated Ground	—	—	CR5352IGGY	IG4700A
GF	Ground Fault	—	GFR8300HGYTR	GF20GYLA	—
SS	Surge Suppression	—	HBL8362GYSA	HBL5362GYSA	—
Switch Types		CR	HG	SG	L1
SL	Local On/Off	—	—	HBL1221PL	—
SM	Master On/Off	—	—	HBL1221PL	—



## LINKOSITY® Feed - UL Type 3R Rated\*

### 3R Rated Standard Items

Description	Catalog Number
20A 125V Ground Fault	M3R002SGGF0
20A 125V Switched, Spec Grade	M3RSL1SG000
20A 125V Switched, Ground Fault	M3RSL1SGGF0
20A 125V Spec Grade	M3R002SG000
20A 125V Ground Fault, Pass-Thru	M3R002SGGFP
20A 125V Switched, Spec Grade, Pass-Thru	M3RSL1SG00P
20A 125V Switched, Ground Fault Pass-Thru	M3RSL1SGGFP
Spec Grade, Pass-Thru	M3R002SG00P

Note: \*When cover closed.  
Accepts PH2304 series cables.



Device Type	Style	Type	No. of Devices	Device Type	Device Feature	Pass-Thru
M	3R - 3R Lids 3D - 3R Deep Cover	SL - Switch Local	1	SG - Spec Grade	IG - Isolated Ground	P - Pass-Thru
		SM - Switch Master	2	HG - Hospital Grade	GF - Ground Fault	0 - No Pass-Thru
		00 - None		CR - Corrosion Resistant	SI - Surge/IG	
				L1 - 15A Locking	SS - Surge	
					00 - Standard	



## LINKOSITY® Feed - UL Type 4X Rated\*

### 4X Rated NEMA Standard Items

Description	Catalog Number
20A 125V Straight Blade	MLWF2010
20A 125V WTSSTL	MLWF2020
20A 125V Straight Blade, Pass-Thru	MLWF201P
20A 125V WTSSTL, Pass-Thru	MLWF202P

Note: \*Watertight Safety-Shroud® Twist-Lock® Plug required when in use.  
\*\*Straight Blade are UL Type 4X when not in use only.  
WTSSTL is an abbreviation for Watertight Safety-Shroud® Twist-Lock®.  
Accepts PH2304 series cables.

Device Type	Style	Type	No. of Devices	Device Type	Pass-Thru
M	L - LINKOSITY	WF - Watertight Safety-Shroud Receptacle	2	01 - 20A 125V Straight Blade** 02 - 20A 125V Twist-Lock 03 - 20A 250V Twist-Lock 04 - 20A 277V Twist-Lock 05 - 30A 125V Twist-Lock 06 - 30A 250V Twist-Lock 07 - 20A 125/250V Twist-Lock 08 - 20A 3Ø 250V Twist-Lock 09 - 20A 3Ø 480V Twist-Lock 10 - 30A 125/250V Twist-Lock 11 - 30A 3Ø 250V Twist-Lock 12 - 30A 3Ø 480V Twist-Lock 13 - 30A 3Ø 600V Twist-Lock	P - Pass-Thru 0 - No Pass-Thru
		WM - Watertight Safety-Shroud Inlet			



## All LINKOSITY® - UL Type 4X Rated\*

### 4X Rated LINKOSITY Standard Items

Description	Catalog Number
20A 3W up to 600V, 4 Port	M4L2003PB0
20A 3W up to 600V, 4 Port Pass-Thru	M4L2003PBP

Note: \*Closure Cap required when not in use.  
Accepts PH2304 series cables.

Device Type	Style	Type	No. of Poles	Conductor Colors	Pass - Thru
M	4L - LINKOSITY	20 - 20A	02	PA - Green/Yellow Black (all others)	P - Pass-Thru 0 - No Pass-Thru
		23 - 20A Super Neutral Isolated Ground	03 04 05 06		
		30 - 30A		PB - Green/Yellow White Black (all others)	



## Conduit Feed - UL Type 4X Rated\*

### Conduit Feed Standard Items

Description	Catalog Number
20A 125V Straight Blade	MCWF2010
20A 125V WTSSTL	MCWF2020
20A 250V WTSSTL	MCWF2030
20A 277V WTSSTL	MCWF2040
30A 125V WTSSTL	MCWF2050
30A 250V WTSSTL	MCWF2060
20A 125/250V WTSSTL	MCWF2070
20A 3Ø, 250V WTSSTL	MCWF2080
20A 3Ø, 480V WTSSTL	MCWF2090
30A 125/250V WTSSTL	MCWF2100
30A 3Ø 250V WTSSTL	MCWF2110
30A 3Ø 480V WTSSTL	MCWF2120
30A 3Ø 600V WTSSTL	MCWF2130

Note: \*Watertight Safety-Shroud® Twist-Lock® Plug required when in use.  
WTSSTL is an abbreviation for Watertight Safety-Shroud® Twist-Lock®.

Device Type	Style	Type	No. of Devices	NEMA Device Type	Pass-Thru
M	C - Conduit Feed	WF - Watertight Safety-Shroud Receptacles	2	01 - 20A 125V Straight Blade 02 - 20A 125V Twist-Lock 03 - 20A 250V Twist-Lock 04 - 20A 277V Twist-Lock 05 - 30A 125V Twist-Lock 06 - 30A 250V Twist-Lock 07 - 20A 125/250V Twist-Lock 08 - 20A 3Ø 250V Twist-Lock 09 - 20A 3Ø 480V Twist-Lock 10 - 30A 125/250V Twist-Lock 11 - 30A 3Ø 250V Twist-Lock 12 - 30A 3Ø 480V Twist-Lock 13 - 30A 3Ø 600V Twist-Lock	0 - No Pass-Thru
		WM - Watertight Safety-Shroud Inlet			



## Replacement Mounting Feet

Description	Catalog Number
For Power Distribution Assemblies.	HBLRFT1 <sup>Δ</sup>

Note: <sup>Δ</sup> Package of 10 mounting feet and 10 screws.



HBLRFT1

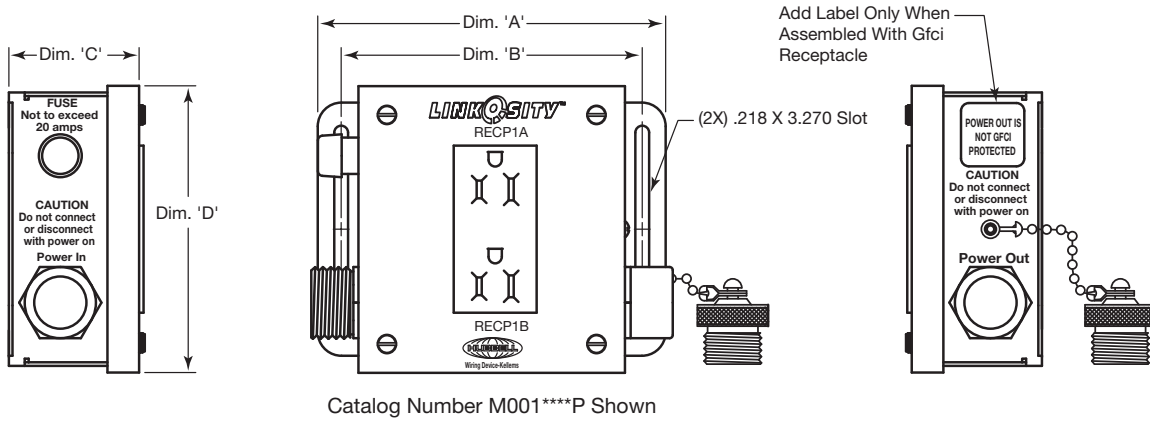

Catalog Number	Gangs	Dimension 'A'	Dimension 'B'	Dimension 'C'	Dimension 'D'
M001****P	1	5.50 (139.7)	4.75 (120.7)	2.25 (57.2)	4.53 (115.1)
M002****P	2	7.50 (190.5)	6.75 (171.5)	2.25 (57.2)	4.53 (115.1)
M003****P	3	9.50 (241.3)	8.75 (222.3)	2.25 (57.2)	4.53 (115.1)
M004****P	4	11.50 (292.1)	10.75 (273.1)	2.25 (57.2)	4.53 (115.1)
M005****P	5	13.50 (342.9)	12.75 (323.9)	2.25 (57.2)	4.53 (115.1)

## LINKOSITY® Specifications

Certifications	
System Level	ETL Classified to NEC
Component Assemblies (PSDA)	UL Listed
Connecting Components	Listed to UL2238 and UL 50
Cable (Up to #22 AWG)	UL 300V Type ITC/PLTC 105°C
Cable (#16 AWG and Up)	UL 600V Type TC-ER, MTW 90°C or ST00W 600V 105°C

## Cable Diameter

Amps	Wires	O.D.
20	3	.595 (15.1)
20	4	.645 (16.4)
20	5	.710 (18.0)
20	6	.760 (19.3)
30	4	.710 (18.0)

## Performance

Electrical	
Voltage	Up to 600V
Amperage	Up to 30A

## Environmental

Connectivity System Components	
Moisture Resistance	UL Type 4, 4X, 12 and 13
Ingress Protection	IP66 Suitability
Flammability	UL94HB Cables/UL94V-0 receptacles

Power System Distribution Assemblies	
Moisture Resistance	NEMA Type 1, Type 3R, Type 4X

Dimensions in Inches (mm)

# Disconnect Switches

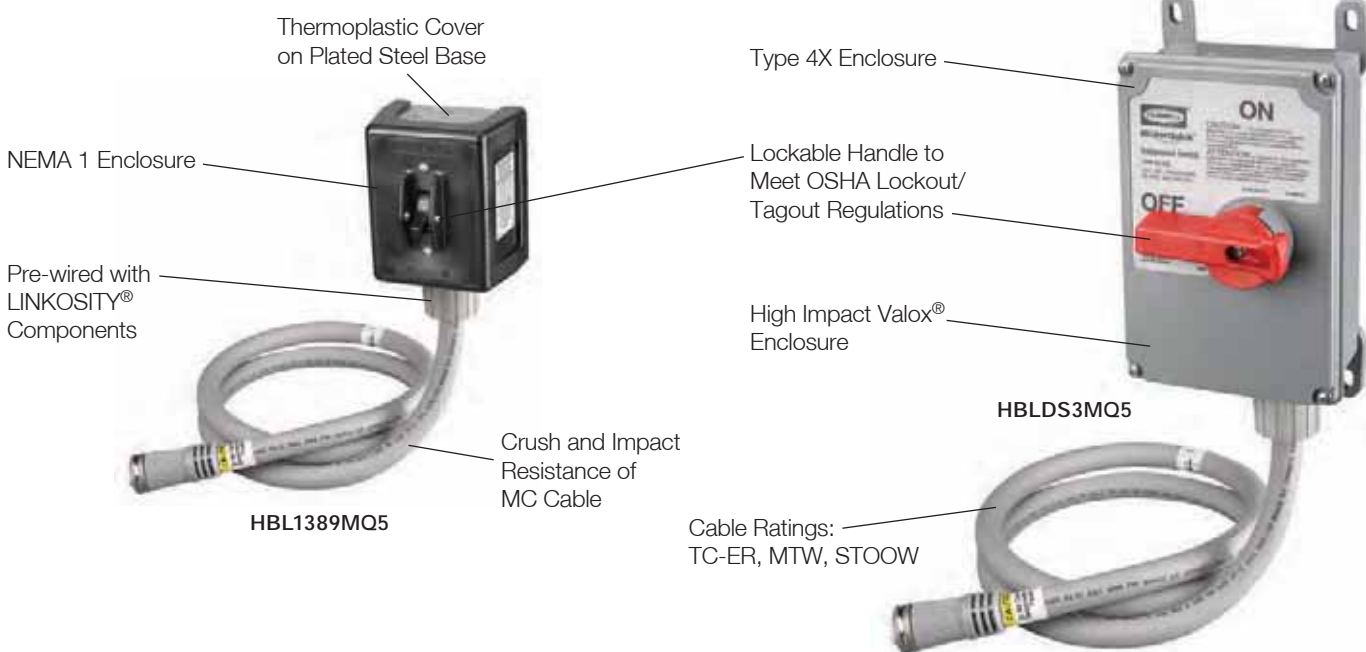

## Quick Disconnect Switches

Type 1 Non-Metallic Enclosure 30A 3 Pole 600V AC	Catalog Number
HBL1389D with one pre-wired LINKOSITY® female receptacle (load side).	HBL1389MQR
HBL1389D with 5 foot pre-wired LINKOSITY® female cable (load side).	HBL1389MQ5
HBL1389D with one pre-wired LINKOSITY® male receptacle (line side) and one pre-wired LINKOSITY® female receptacle (load side).	HBL1389MQR2
Type 4X Non-Metallic Enclosure 30A 3 Pole 600V AC	Catalog Number
HBLDS3 with one pre-wired LINKOSITY® female receptacle (load side).	HBLDS3MQR
HBLDS3 with 5 foot pre-wired LINKOSITY® female cable (load side).	HBLDS3MQ5
HBLDS3 with one pre-wired LINKOSITY® male receptacle (line side) and one pre-wired LINKOSITY® female receptacle (load side).	HBLDS3MQR2
Type 4X Stainless Steel Enclosure 30A 3 Pole 600V AC	Catalog Number
HBLDS3SS with one pre-wired LINKOSITY® female receptacle (load side).	HBLDS3SSMQR
HBLDS3SS with 5 foot pre-wired LINKOSITY® female cable (load side).	HBLDS3SSMQ5
HBLDS3SS with one pre-wired LINKOSITY® male receptacle (line side) and one pre-wired LINKOSITY® female receptacle (load side).	HBLDS3SSMQR2



## Accessories

Description	Catalog Number
3P 4W LINKOSITY® male receptacle for installation on motor.	RM3004PA001
3P 4W LINKOSITY® female receptacle for installation in switch.	RF3004PA001
3P 4W LINKOSITY® double ended (male/female) 5-50 foot cable.	PH3004PAxxx*
3P 4W LINKOSITY® single ended (female) 5-50 foot cable.	PF3004PAxxx*
Cord connector, ¼ in. NPT .63-.75 in. (16.0-19.1) diameter.	SHC1037CR
Lock-on cover for LINKOSITY® connections.	PH2030C

Note: \*Cables available from 5-50 feet in 5 foot increments. To purchase larger cable, replace the **xxx** with the required length in feet. (Examples: PH3004PA005 = 5 foot cable, PH3004PA050 = 50 foot cable.)

## Sample Set Up

(1) HBLDS3MQR + (1) PH3004PAxxx + (1) RM3004PA001 = Total Set Up\*\*

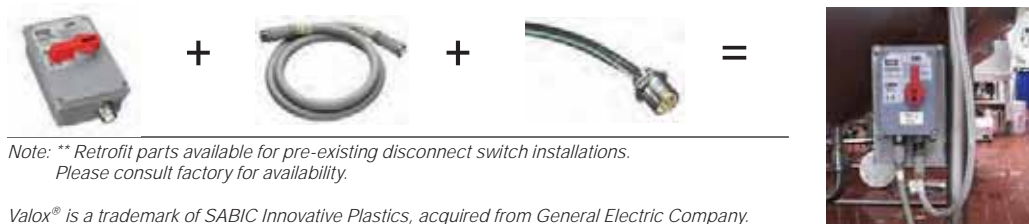

Valox® is a trademark of SABIC Innovative Plastics, acquired from General Electric Company.

**Hard Gold Over Palladium Nickel Contact Plating**  
Superior conductivity, extended contact life

**Gated Strain Relief with Graduated Window Sizes**  
Improved flexibility and strength protects wire terminations; superior arc of bend control

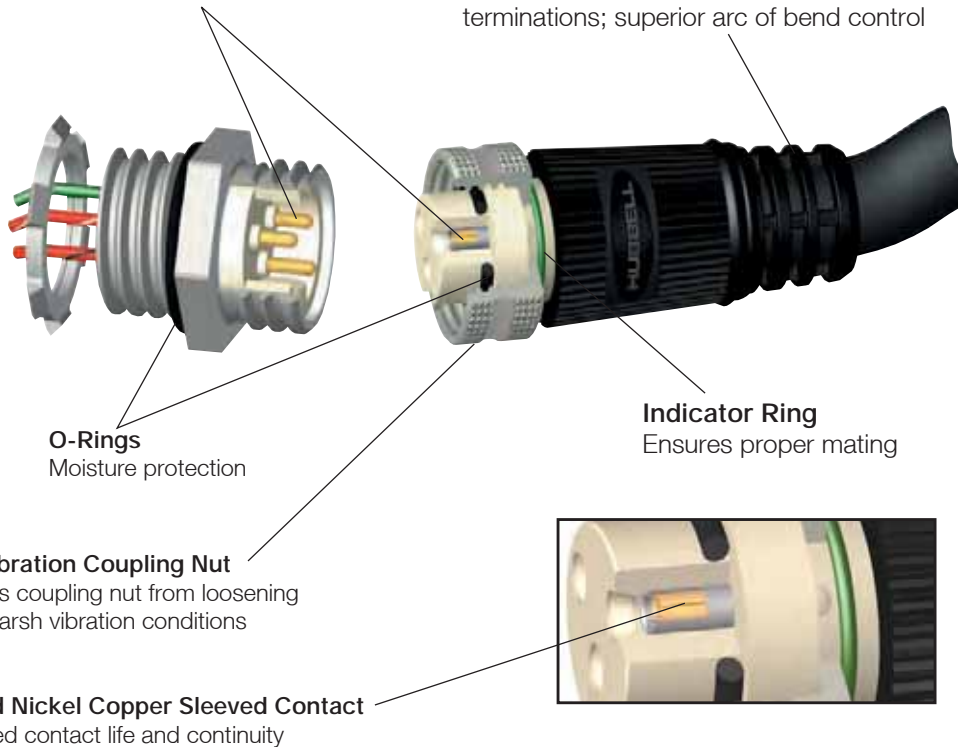

## Features

- Nickel plated brass coupling nuts and receptacle shells.
- Black overmold and cable.
- Insulgrip connector body design.
- UL Listed cable assemblies and receptacles.
- Plating resists corrosion in high abuse environments.

## Benefits

- Cable assembly resists dirt and blends with environment giving a clean look to the installation.
- Ergonomic connector body has an industrial look.
- Third party certified for electrical, mechanical and environmental performance.

## Material Specifications

Insulator Materials	Nylon 6/6, White
Contact Materials	Pins - Brass, Sockets Leaded nickel copper w/ stainless steel sleeve
Contact Plating	Hard gold over palladium/nickel
Overmold Material	Polyurethane, Black
Coupling Nut, Metallic	Nickel plated brass
Coupling Nut, Nylon	Nylon 6/6, Black
Receptacle Shell	Nickel plated brass, SST consult factory
Receptacle Shell, Nylon	Nylon 6/6, Black
Receptacle Shell, Right Angle	Nickel plated zinc alloy die cast, SST consult factory

Cable	#16 AWG SEOOW - TPE jacket, Black, PVC conductor insulation, Stranding - 65/34 #18 AWG SEOOW - TPE jacket, Black, PVC conductor insulation, Stranding - 41/34 #18 AWM2661 - PVC jacket, Black, PVC conductor insulation, Stranding - 41/34
Strain Relief	#16 AWG and #18 AWG - 30 pounds min per UL2238

## Electrical Specifications

Voltage Rating	600V DC/600V AC
Amperage	#16 AWG - 2&3P=15A, 4P=12A, 5&6P=10A 7P=10A, 8&9P=9A, 10&12P=8A #18 AWG - 2&3P=11A, 4P=8A, 5&6P=7A
Contact Resistance	≤ 5 mΩ
Isolation Resistance	≥ 1000 MΩ

## Environmental Specifications

Moisture Protection	UL Type 4, 4X, 12 and 13
Ingress Protection	IP66 Suitability
Operating Temperature	AWM2661 cables: -20°C to 105° C SEOOW cable: -40°C to 105° C
Corrosion Resistance	500 hours salt spray per MIL-STD-1344, Method 1001
Vibration Resistance	10 - 2,000 Hz @15g per MIL-STD-1344, Method 2005

## Certifications

UL 2238 and UL50E, File No. E192071

CSA Certified, C22.2 No. 182.3 and CSA C22.2 No. 94.2-07

Choose the appropriate configuration from the Selector below.

## Hubbell Logic Configurator

For example, catalog number **HCMA05212** is derived as follows:

DEVICE TYPE	COUPLING NUT MATERIAL	BODY STYLE	POLES	CONDUCTOR TYPE	CABLE LENGTH (ft)
HC = Plug, Female HP = Plug, Male HI = Plug, Male Inline♦ HE = Male/Female Extension Cable♦ HJ = Male/Female Jumper Cable	M = Metallic N = Nylon	A = Right Angle S = Straight	02 03 04 05 06	1 = #16 AWG SEOOW Cable 3 = #18 AWM2661 IEC Cable* 4 = #18 AWG SEOOW Cable  *3 - 5 Pole Only	** 03 06 12 20  **Replace with Length
↓ <b>HC</b>	↓ <b>M</b>	↓ <b>A</b>	↓ <b>05</b>	↓ <b>2</b>	↓ <b>12</b>

Note: Availability of specific items may vary. Consult factory for delivery. Consult the factory for additional cable lengths or cable types.

♦ Available with metallic coupling nut only.

## 2 - 6 Pole Plugs

Catalog numbers using #16 AWG SEOOW cable are listed below. For #18 AWG SEOOW or #18 AWM2661 IEC cable, change the conductor type per the Hubbell Logic chart above.

Poles	Male Face Shown Female - mirror image	Cable Length	Female Plugs		Male Plugs		Male/Female Jumper Cables
			Straight	Right Angle	Straight	Right Angle	
2		3 ft (0.91m) 6 ft (1.83m) 12 ft (3.66m) All other lengths▲	HCMS02103	HCMA02103	HPMS02103	HPMA02103	HJMS02103
			HCMS02106	HCMA02106	HPMS02106	HPMA02106	HJMS02106
			HCMS02112	HCMA02112	HPMS02112	HPMA02112	HJMS02112
			HCMS021**	HCMA021**	HPMS021**	HPMA021**	HJMS021**
			HCMS021**	HCMA021**	HPMS021**	HPMA021**	HJMS021**
3		3 ft (0.91m) 6 ft (1.83m) 12 ft (3.66m) All other lengths▲	HCMS03103	HCMA03103	HPMS03103	HPMA03103	HJMS03103
			HCMS03106	HCMA03106	HPMS03106	HPMA03106	HJMS03106
			HCMS03112	HCMA03112	HPMS03112	HPMA03112	HJMS03112
			HCMS031**	HCMA031**	HPMS031**	HPMA031**	HJMS031**
			HCMS031**	HCMA031**	HPMS031**	HPMA031**	HJMS031**
4		3 ft (0.91m) 6 ft (1.83m) 12 ft (3.66m) All other lengths▲	HCMS04103	HCMA04103	HPMS04103	HPMA04103	HJMS04103
			HCMS04106	HCMA04106	HPMS04106	HPMA04106	HJMS04106
			HCMS04112	HCMA04112	HPMS04112	HPMA04112	HJMS04112
			HCMS041**	HCMA041**	HPMS041**	HPMA041**	HJMS041**
			HCMS041**	HCMA041**	HPMS041**	HPMA041**	HJMS041**
5		3 ft (0.91m) 6 ft (1.83m) 12 ft (3.66m) All other lengths▲	HCMS05103	HCMA05103	HPMS05103	HPMA05103	HJMS05103
			HCMS05106	HCMA05106	HPMS05106	HPMA05106	HJMS05106
			HCMS05112	HCMA05112	HPMS05112	HPMA05112	HJMS05112
			HCMS051**	HCMA051**	HPMS051**	HPMA051**	HJMS051**
			HCMS051**	HCMA051**	HPMS051**	HPMA051**	HJMS051**
6		3 ft (0.91m) 6 ft (1.83m) 12 ft (3.66m) All other lengths▲	HCMS06103	HCMA06103	HPMS06103	HPMA06103	HJMS06103
			HCMS06106	HCMA06106	HPMS06106	HPMA06106	HJMS06106
			HCMS06112	HCMA06112	HPMS06112	HPMA06112	HJMS06112
			HCMS061**	HCMA061**	HPMS061**	HPMA061**	HJMS061**
			HCMS061**	HCMA061**	HPMS061**	HPMA061**	HJMS061**

Note: ▲ Replace \*\* with length required in feet. For nylon coupling nuts, replace "M" with "N" per the ordering chart above.

Example: change HPMA05106 to HPNA05106.

## Straight Plug

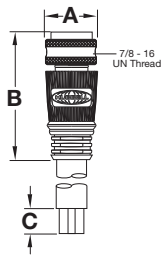

	MALE	FEMALE
A	0.99" (25.2)	0.99" (25.2)
B	2.44" (62.0)	2.40" (61.0)
C	2.75" (69.9)	2.75" (69.9)

## Right Angle Plug

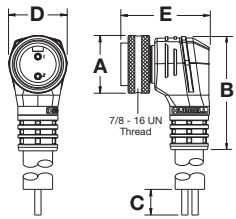

	MALE	FEMALE
A	0.99" (25.2)	0.99" (25.2)
B	2.14" (54.4)	2.14" (54.4)
C	2.75" (69.9)	2.75" (69.9)
D	1.03" (26.2)	1.03" (26.2)
E	1.64" (40.6)	1.60" (40.6)

## Inline Plug

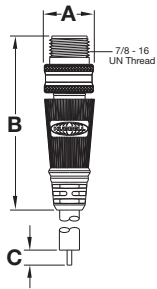

	MALE
A	0.99" (25.2)
B	2.47" (62.8)
C	2.75" (69.9)

Right Angle version also available.

## Accessories

Closure caps protect plugs and receptacles when not in use. Adapter rings allow the mating of male and female plugs for in-line applications. Shell size is 1, and the thread is 7/8-16 UN.

Description	Catalog Number	
Closure Cap	HPCAP1	
Closure Cap	HRCAP1	
Adapter Ring	HMQAR1	

Dimensions in Inches (mm)

## Jumper Cable

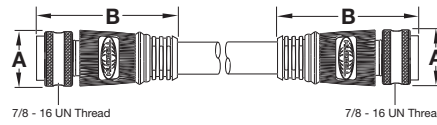

	MALE	FEMALE
A	0.99" (25.2)	0.99" (25.2)
B	2.44" (62.0)	2.40" (61.0)

## Male/Female Extension Cable

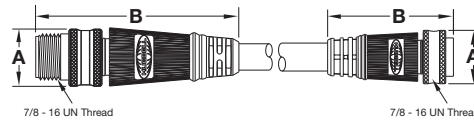

	MALE	FEMALE
A	0.99" (25.2)	0.99" (25.2)
B	2.47" (62.7)	2.40" (61.0)

## Cable Diameters By Cable Type

Number of Conductors	#16 AWG SEOOW	#18 AWG SEOOW
2	0.37" (9.4)	0.35" (8.9)
3	0.39" (9.9)	0.37" (9.4)
4	0.42" (10.7)	0.39" (9.9)
5	0.50" (12.7)	0.47" (11.9)
6	0.52" (13.2)	0.48" (12.2)

Number of Conductors	#18 AWM2661 IEC
3	0.26" (6.6)
4	0.26" (6.6)
5	0.26" (6.6)

## Conductor Color Code

### #16 AWG SEOOW Plugs

Contact Number	2 Pole	3 Pole	4 Pole	5 Pole	6 Pole
1	White	Green	Black	White	White
2	Black	Black	White	Red	Red
3		White	Red	Green	Green
4			Green	Orange	Orange
5				Black	Black
6					Blue

### #18 AWG SEOOW Plugs

Contact Number	3 Pole	4 Pole	5 Pole
1	Green	Black	White
2	Black	White	Red
3	White	Red	Green
4		Green	Orange
5			Black

### #18 AWM 2661 IEC

Contact Number	3 Pole	4 Pole	5 Pole
1	Yellow/Green	Black	Black
2	Brown	Blue	Blue
3	Blue	Brown	Yellow/Green
4		White	Brown
5			White

Choose the appropriate configuration from the Selector below.

## Hubbell Logic Configurator

For example, catalog number **HBMS05501** is derived as follows:

DEVICE TYPE	SHELL MATERIAL	BODY STYLE	POLES	CONDUCTOR TYPE	LEAD WIRE LENGTH (ft)
HR = Receptacle, Female HB = Receptacle, Male	M = Metallic N = Nylon	A = Right Angle* S = Straight F = Flange Mount*  *Metallic Only	02 03 04 05 06	5 = #16 AWG Discrete Wire 6 = #18 AWG IEC Discrete Wire (IEC colors)*  *3 - 5 Pole Only	01* **  *1 Standard Length **Replace with Length
↓ <b>HB</b>	↓ <b>M</b>	↓ <b>S</b>	↓ <b>05</b>	↓ <b>5</b>	↓ <b>01</b>

Note: Availability of specific items may vary. Consult factory for delivery. Use this chart to build receptacles to meet any application need. Consult the factory for additional wire lengths or wire types.

## 2 - 6 Pole Receptacles

#16 AWG Discrete Wire ♦

Poles	Male Face Shown Female - mirror image	Female Receptacles				Male Receptacles			
		Straight	Nylon	Right Angle	Flange Mount	Straight	Nylon	Right Angle	Flange Mount
2		HRMS02501	HRNS02501	HRMA02501	HRMF02501	HBMS02501	HBNS02501	HBMA02501	HBMF02501
3		HRMS03501	HRNS03501	HRMA03501	HRMF03501	HBMS03501	HBNS03501	HBMA03501	HBMF03501
4		HRMS04501	HRNS04501	HRMA04501	HRMF04501	HBMS04501	HBNS04501	HBMA04501	HBMF04501
5		HRMS05501	HRNS05501	HRMA05501	HRMF05501	HBMS05501	HBNS05501	HBMA05501	HBMF05501
6		HRMS06501	HRNS06501	HRMA06501	HRMF06501	HBMS06501	HBNS06501	HBMA06501	HBMF06501

Note: ♦ For #18 AWG IEC discrete wire, change the conductor type using the Hubbell Logic chart above.

## Straight Receptacles

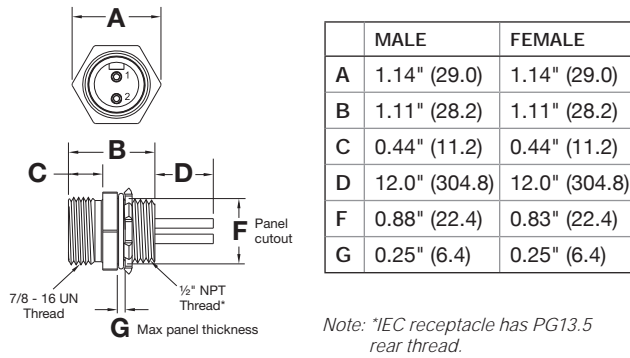

## Flange Mount Receptacles

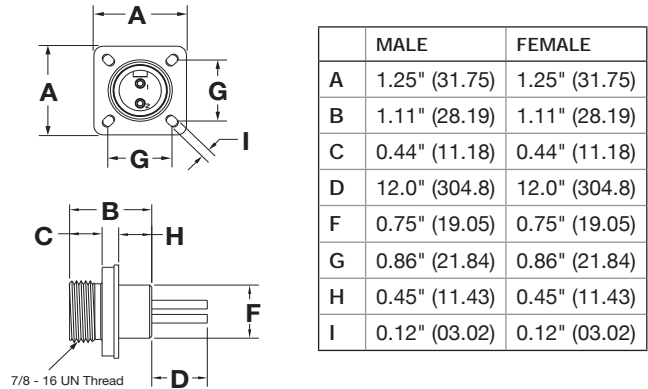

## Right Angle Receptacles

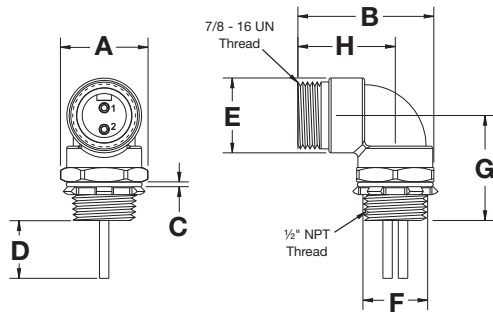

	MALE	FEMALE
A	1.14" (29.0)	1.14" (29.0)
B	1.76" (44.7)	1.76" (44.7)
C	0.25" (6.4)	0.25" (6.4)
D	12.0" (304.8)	12.0" (304.8)
E	0.97" (24.6)	0.97" (24.6)
F	0.83" (21.8)	0.83" (21.8)
G	1.36" (34.5)	1.36" (34.5)
H	1.26" (32.0)	1.26" (32.0)

## Accessories

Closure caps protect plugs and receptacles when not in use. Shell size is 1, and the thread is 7/8-16 UN.

Description	Catalog Number
Closure Cap	HPCAP1
Closure Cap	HRCAP1

Dimensions in Inches (mm)

## Color Code By Wire Type

### #16 AWG Receptacles

Contact Number	2 Pole	3 Pole	4 Pole	5 Pole	6 Pole
1	White	Green	Black	White	White
2	Black	Black	White	Red	Red
3		White	Red	Green	Green
4			Green	Orange	Orange
5				Black	Black
6					Blue

### #18 AWG Receptacles

Contact Number	3 Pole	4 Pole	5 Pole
1	Yellow/Green	Black	Black
2	Brown	Blue	Blue
3	Blue	Brown	Yellow/Green
4		White	Brown
5			White



Choose the appropriate configuration from the Selector below.

## Hubbell Logic Configurator

For example, catalog number **HCMA08112** is derived as follows:

DEVICE TYPE	COUPLING NUT MATERIAL	BODY STYLE	POLES	CONDUCTOR TYPE	CABLE LENGTH (ft)
HC = Plug, Female HP = Plug, Male HJ = Male/Female Jumper Cable	M = Metallic N = Nylon	A = Right Angle S = Straight	07 08 09 10 12	1 = #16 AWG SEOOW Cable	** 03 06 12 20  **Replace with Length
↓ <b>HC</b>	↓ <b>M</b>	↓ <b>A</b>	↓ <b>08</b>	↓ <b>1</b>	↓ <b>12</b>

Note: Availability of specific items may vary. Consult factory for delivery. Consult the factory for additional cable lengths or cable types.

## 7 - 12 Pole Plugs

Catalog numbers using #16 AWG SEOOW cable are listed below.

Poles	Male Face Shown Female - mirror image	Cable Length	Female Plugs		Male Plugs		Male/Female Jumper Cables
			Straight	Right Angle	Straight	Right Angle	Straight
7		3 ft (0.91m) 6 ft (1.83m) 12 ft (3.66m) All other lengths▲	HCMS07103	HCMA07103	HPMS07103	HPMA07103	HJMS07103
			HCMS07106	HCMA07106	HPMS07106	HPMA07106	HJMS07106
			HCMS07112	HCMA07112	HPMS07112	HPMA07112	HJMS07112
			HCMS071**	HCMA071**	HPMS071**	HPMA071**	HJMS071**
8		3 ft (0.91m) 6 ft (1.83m) 12 ft (3.66m) All other lengths▲	HCMS08103	HCMA08103	HPMS08103	HPMA08103	HJMS08103
			HCMS08106	HCMA08106	HPMS08106	HPMA08106	HJMS08106
			HCMS08112	HCMA08112	HPMS08112	HPMA08112	HJMS08112
			HCMS081**	HCMA081**	HPMS081**	HPMA081**	HJMS081**
9		3 ft (0.91m) 6 ft (1.83m) 12 ft (3.66m) All other lengths▲	HCMS09103	HCMA09103	HPMS09103	HPMA09103	HJMS09103
			HCMS09106	HCMA09106	HPMS09106	HPMA09106	HJMS09106
			HCMS09112	HCMA09112	HPMS09112	HPMA09112	HJMS09112
			HCMS091**	HCMA091**	HPMS091**	HPMA091**	HJMS091**
10		3 ft (0.91m) 6 ft (1.83m) 12 ft (3.66m) All other lengths▲	HCMS10103	HCMA10103	HPMS10103	HPMA10103	HJMS10103
			HCMS10106	HCMA10106	HPMS10106	HPMA10106	HJMS10106
			HCMS10112	HCMA10112	HPMS10112	HPMA10112	HJMS10112
			HCMS101**	HCMA101**	HPMS101**	HPMA101**	HJMS101**
12		3 ft (0.91m) 6 ft (1.83m) 12 ft (3.66m) All other lengths▲	HCMS12103	HCMA12103	HPMS12103	HPMA12103	HJMS12103
			HCMS12106	HCMA12106	HPMS12106	HPMA12106	HJMS12106
			HCMS12112	HCMA12112	HPMS12112	HPMA12112	HJMS12112
			HCMS121**	HCMA121**	HPMS121**	HPMA121**	HJMS121**

Note: ▲ Replace \*\* with length required in feet. For nylon coupling nuts, replace "M" with "N" per the ordering chart above.  
Example: change HPMA07106 to HPNA07106.

### Straight Plug

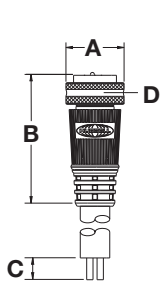

#### 7 - 8 Pole

	MALE	FEMALE
A	1.12" (28.5)	1.12" (28.5)
B	2.53" (64.3)	2.49" (63.3)
C	2.75" (69.9)	2.75" (69.9)
D	1 - 16 UN Thread	

#### 9 - 12 Pole

	MALE	FEMALE
A	1.25" (31.8)	1.25" (31.8)
B	2.77" (70.4)	2.73" (69.3)
C	2.75" (69.9)	2.75" (69.9)
D	1 1/8 - 16 UN Thread	

### Right Angle Plug

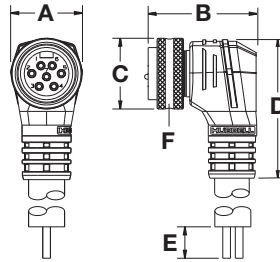

#### 7 - 8 Pole

	MALE	FEMALE
A	1.14" (29.0)	1.14" (29.0)
B	1.73" (43.9)	1.69" (42.9)
C	1.12" (28.5)	1.12" (28.5)
D	2.22" (56.4)	2.22" (56.4)
E	2.75" (69.9)	2.75" (69.9)
F	1 - 16 UN Thread	

#### 9 - 12 Pole

	MALE	FEMALE
A	1.25" (31.8)	1.25" (31.8)
B	1.84" (47.0)	1.80" (45.7)
C	1.25" (31.8)	1.25" (31.8)
D	2.54" (64.5)	2.54" (64.5)
E	2.75" (69.9)	2.75" (69.9)
F	1 1/8 - 16 UN Thread	

### Jumper Cable

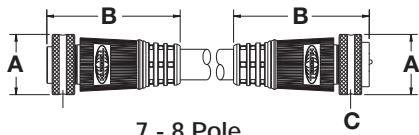

#### 7 - 8 Pole

	MALE	FEMALE
A	1.12" (28.5)	1.12" (28.5)
B	2.53" (64.3)	2.49" (63.3)
C	1 - 16 UN Thread	

#### 9 - 12 Pole

	MALE	FEMALE
A	1.25" (31.8)	1.25" (31.8)
B	2.77" (70.4)	2.73" (69.3)
C	1 1/8 - 16 UN Thread	

### Cable Diameters By Cable Type

Number of Conductors	#16 AWG STOOW
7	0.52" (13.2)
8	0.56" (14.2)
9	0.60" (15.2)
10	0.65" (16.7)
12	0.70" (17.7)

### Conductor Color Code

#### #16 AWG SEOOW Plugs

Contact Number	2 Pole	3 Pole	4 Pole	5 Pole	6 Pole	7 Pole	8 Pole	9 Pole	10 Pole	12 Pole
1	White	Green	Black	White	White	White/Black	Orange	Orange	Orange	Orange
2	Black	Black	White	Red	Red	Black	Blue	Blue	Blue	Blue
3		White	Red	Green	Green	White	White/Black	Red/Black	White/Black	White/Black
4			Green	Orange	Orange	Red	Black	Green/Black	Red/Black	Red/Black
5				Black	Black	Orange	White	White	Green/Black	Green/Black
6					Blue	Blue	Red	Red	Orange/Black	Orange/Black
7						Green	Green	Green	Red	Blue/Black
8							Red/Black	White/Black	Green	Black/White
9								Black	Black	Green
10									White	Red
11										White
12										Black

### Accessories

Closure caps protect plugs and receptacles when not in use. Adapter rings allow the mating of male and female plugs for in-line applications.

Description	Closure Cap			Closure Cap			Adapter Ring		
	Shell Size	Thread Size	Catalog Number	Shell Size	Thread Size	Catalog Number	Shell Size	Thread Size	Catalog Number
7 to 8 Pole	II	1 - 16 UN	HPCAP2	II	1 - 16 UN	HRCAP2	II	1 - 16 UN	HMQAR2
9 to 12 Pole	III	1 1/8 - 16UN	HPCAP3	III	1 1/8 - 16UN	HRCAP3	III	1 1/8 - 16UN	HMQAR3
Cap Size	II- 1.12" (28.5), III- 1.25" (31.8)			II- 1.13" (28.6), III- 1.25" (31.8)			II- 1.00" (25.4), III- 1.13" (28.6)		

Dimensions in Inches (mm)

Choose the appropriate configuration from the Selector below.

## Hubbell Logic Configurator

For example, catalog number **HRMS10501** is derived as follows:

DEVICE TYPE	SHELL MATERIAL	BODY STYLE	POLES	CONDUCTOR TYPE	LEAD WIRE LENGTH (ft)
HR = Receptacle, Female HB = Receptacle, Male	M = Metallic	S = Straight	07 08 09 10 12	5 = #16 AWG Discrete Wire	01* **
↓	↓	↓	↓	↓	↓
<b>HR</b>	<b>M</b>	<b>S</b>	<b>10</b>	<b>5</b>	<b>01</b>

*Note: Availability of specific items may vary. Consult factory for delivery. Consult the factory for additional wire lengths or wire types.*

## 7 - 12 Pole Receptacles

#16 AWG Discrete Wire

Poles	Male Face Shown Female - mirror image	Female Receptacles	Male Receptacles
7		HRMS07501	HBMS07501
8		HRMS08501	HBMS08501
9		HRMS09501	HBMS09501
10		HRMS10501	HBMS10501
12		HRMS12501	HBMS12501

## Straight Receptacles

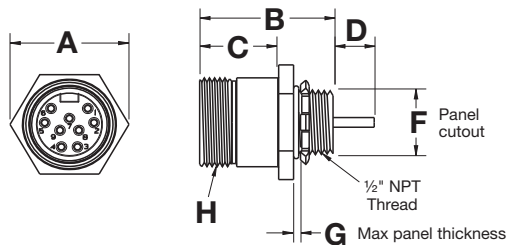

### 7 - 8 Pole

	MALE	FEMALE
A	1.29" (32.8)	1.29" (32.8)
B	1.44" (36.6)	1.44" (36.6)
C	0.80" (20.3)	0.80" (20.3)
D	12.0" (304.8)	12.0" (304.8)
F	0.83" (21.1)	0.83" (21.1)
G	0.25" (6.4)	0.25" (6.4)
H	1 - 16 UN Thread	

### 9 - 12 Pole

	MALE	FEMALE
A	1.44" (36.6)	1.44" (36.6)
B	1.62" (41.2)	1.62" (41.2)
C	0.96" (24.4)	0.96" (24.4)
D	12.0" (304.8)	12.0" (304.8)
F	0.83" (21.1)	0.83" (21.1)
G	0.25" (6.4)	0.25" (6.4)
H	1 1/8 - 16 UN Thread	

## Conductor Color Code

### #16 AWG Receptacles

Contact Number	2 Pole	3 Pole	4 Pole	5 Pole	6 Pole	7 Pole	8 Pole	9 Pole	10 Pole	12 Pole
1	White	Green	Black	White	White	White/Black	Orange	Orange	Orange	Orange
2	Black	Black	White	Red	Red	Black	Blue	Blue	Blue	Blue
3		White	Red	Green	Green	White	White/Black	Red/Black	White/Black	White/Black
4			Green	Orange	Orange	Red	Black	Green/Black	Red/Black	Red/Black
5				Black	Black	Orange	White	White	Green/Black	Green/Black
6					Blue	Blue	Red	Red	Orange/Black	Orange/Black
7						Green	Green	Green	Red	Blue/Black
8							Red/Black	White/Black	Green	Black/White
9								Black	Black	Green
10									White	Red
11										White
12										Black

## Accessories

Closure caps protect plugs and receptacles when not in use. Adapter rings allow the mating of male and female plugs for in-line applications.

Description	Closure Cap			Closure Cap			Adapter Ring		
	Shell Size	Thread Size	Catalog Number	Shell Size	Thread Size	Catalog Number	Shell Size	Thread Size	Catalog Number
7 to 8 Pole	II	1 - 16 UN	HPCAP2	II	1 - 16 UN	HRCAP2	II	1 - 16 UN	HMQAR2
9 to 12 Pole	III	1 1/8 - 16UN	HPCAP3	III	1 1/8 - 16UN	HRCAP3	III	1 1/8 - 16UN	HMQAR3
Cap Size	II- 1.12" (28.5), III- 1.25" (31.8)			II- 1.13" (28.6), III- 1.25" (31.8)			II- 1.00" (25.4), III- 1.13" (28.6)		

Dimensions in Inches (mm)

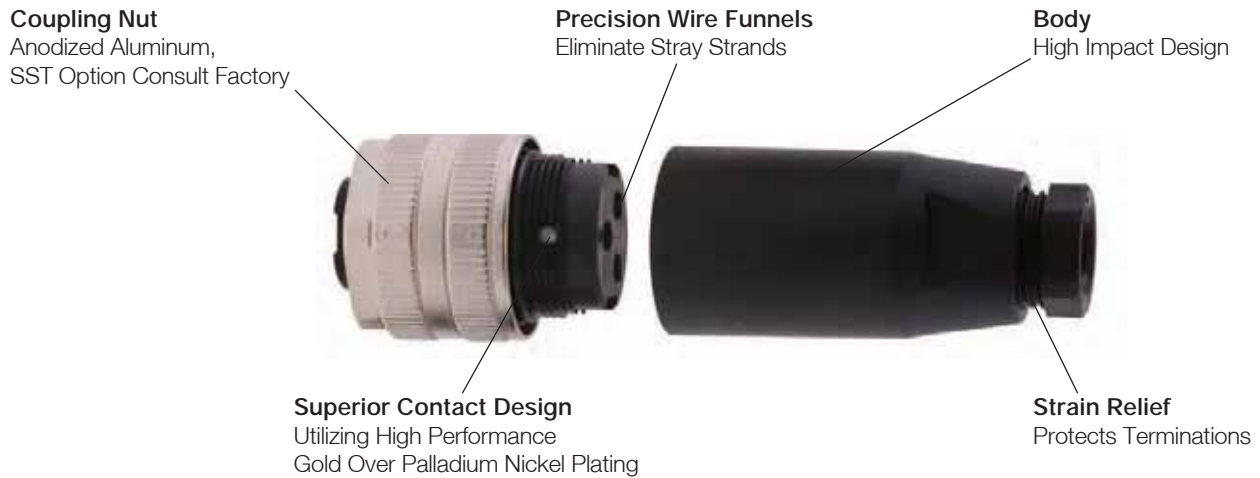

### 3 - 5 Pole Field Attachable Connectors

Poles	Male Face Shown Female - mirror image	Cable Range	Female Connector		Male In-Line Connector		Male Connector	
			Straight	Right Angle	Straight	Right Angle	Straight	Right Angle
3		.24"-.32" (6.1-8.1)	HCMS03F9	HCMA03F9	HIMS03F9	HIMA03F9	HPMS03F9	HPMA03F9
		.39"-.47" (9.9-11.9)	HCMS03F13	—	HIMS03F13	—	HPMS03F13	—
		.47"-.55" (11.9-13.1)	—	—	—	—	—	—
4		.24"-.32" (6.1-8.1)	HCMS04F9	HCMA04F9	HIMS04F9	HIMA04F9	HPMS04F9	HPMA04F9
		.39"-.47" (9.9-11.9)	HCMS04F13	—	HIMS04F13	—	HPMS04F13	—
		.47"-.55" (11.9-13.1)	HCMS04F16	—	HIMS04F16	—	HPMS04F16	—
5		.24"-.32" (6.1-8.1)	HCMS05F9	HCMA05F9	HIMS05F9	HIMA05F9	HPMS05F9	HPMA05F9
		.39"-.47" (9.9-11.9)	HCMS05F13	—	HIMS05F13	—	HPMS05F13	—
		.47"-.55" (11.9-13.1)	HCMS05F16	—	HIMS05F16	—	HPMS05F16	—

#### Electrical Specifications

Voltage Rating	250V
Amperage	3 Pin - 12A 4,5 Pin - 9A
Wire Size, Max	#16 AWG

#### Mechanical Specifications

Coupling Nut	Anodized aluminum, SST consult factory
Connector Shell	PBT
Connector Insert	PUR/PA
Contacts	Brass, gold plate over palladium nickel

#### Environmental Specifications

Moisture Resistance	IP66 Suitability
Operating Temperature	-40°C to 85°C

Female, Right Angle  
Male, Right Angle



Female, Straight  
Male, Straight



Male In-Line, Right Angle



Male In-Line, Straight



Dimensions in Inches (mm)

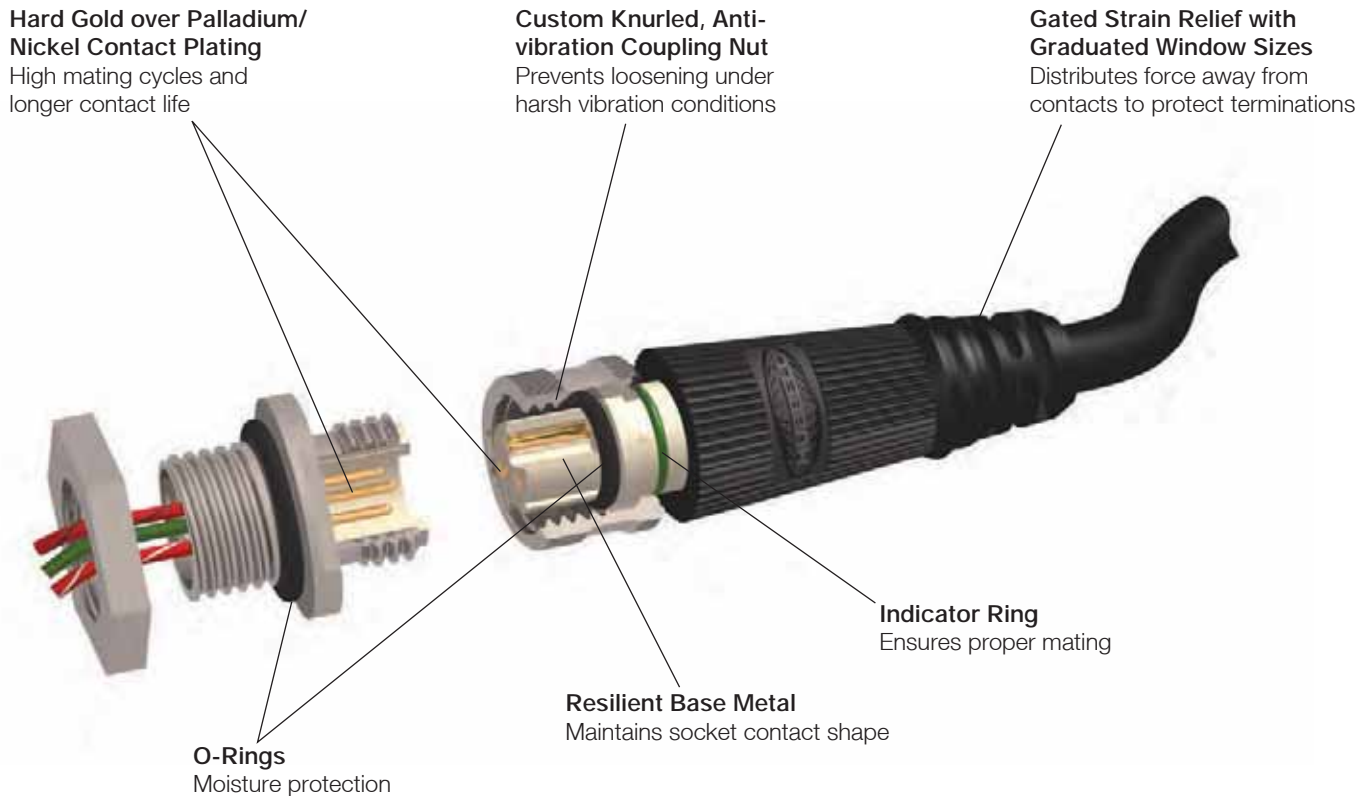

## Features

- Nickel plated brass coupling nuts and receptacle shells.
- Beryllium copper socket contacts.
- Standard #22 AWG cable 85% copper braid coverage.
- Black overmold and cable.
- Insulgrip connector body design.
- Plating resists corrosion in high abuse environments.

## Benefits

- Strong, resilient base metal ensures contacts maintain their shape and continuity over time.
- Cable resists nicks and abrasions and provides shielding when braid is terminated.
- Cable assembly resists dirt and blends with environment giving a clean look to the installation.
- Ergonomic connector body has an industrial look.

## Material Specifications

Insulator Materials	Nylon 6/6, White	Cable	#22 AWG - PVC jacket (black)
Contact Materials	Pins - Brass Sockets - Beryllium copper		PVC conductor insulation Copper braid - 85% coverage Stranding - 19/34
Contact Plating	Hard gold over palladium/nickel		#18 AWG - TPE jacket (black)
Overmold Material	Glass filled polyurethane, Black		PVC conductor insulation Stranding - 41/34
Coupling Nut, Metallic	Nickel plated brass	Strain Relief	#22 AWG - 20 pounds min per UL2238
Coupling Nut, Nylon	Nylon 6/6, Black		#18 AWG - 30 pounds min per UL 2238
Receptacle Shell	Nickel plated brass		

## Electrical Specifications

Voltage Rating	300V DC/300V AC
Amperage	#22 AWG - 2&3P=5A, 4&5P=4A, 6P=3A #18 AWG - 2&3P=8A, 4P=6A, 5P=5A
Contact Resistance	≤ 5 mΩ
Isolation Resistance	≥ 1000 MΩ

## Environmental Specifications

Moisture Protection	UL Type 4, 4X, 12 and 13
Ingress Protection	IP66 Suitability
Operating Temperature	#22 AWG PVC cable: -20°C to 105° C #18 AWG TPE cable: -40°C to 105° C
Corrosion Resistance	500 hours salt spray per MIL-STD-1344, Method 1001
Vibration Resistance	10 - 2,000 Hz @15g per MIL-STD-1344, Method 2005

## Certifications

UL 2238 and UL50E, File No. E192071

CSA Certified, C22.2 No. 182.3 and CSA C22.2 No. 94.2-07

Choose the appropriate configuration from the Selector below.

## Hubbell Logic Configurator

For example, catalog number **MCMS1312** is derived as follows:

DEVICE TYPE	COUPLING NUT MATERIAL	BODY STYLE	KEY STYLE	POLES	CONDUCTOR TYPE	CABLE LENGTH (m)
MC = Plug, Female MI = Plug, Male Inline ME = Male/Female Extension Cable	M = Metallic N = Nylon	A = Right Angle S = Straight	1 = Single	3 4 5	1 = #22 AWG PVC Cable 2 = #18 AWG TPE Cable*	** 2 4 5  **Replace with Length
↓	↓	↓	↓	↓	↓	↓
<b>MC</b>	<b>M</b>	<b>S</b>	<b>1</b>	<b>3</b>	<b>1</b>	<b>2</b>

Note: Availability of specific items may vary. Consult factory for delivery. Consult the factory for additional cable lengths or cable types.

## 3 - 5 Pole Single Key Plugs

Catalog numbers using #22 AWG PVC cable are listed below. For #18 AWG TPE cable, change the conductor type per the Hubbell Logic chart above.

Poles	Male Face Shown Female - mirror image	Cable Length	Female Plugs		Male In-Line Plugs	Male/Female Extension Cables
			Straight	Right Angle	Straight	Straight
3		6.56 ft (2m) 13.12 ft (4m) 16.40 ft (5m) All other lengths▲	MCMS1312	MCMA1312	MIMS1312	MEMS1312
			MCMS1314	MCMA1314	MIMS1314	MEMS1314
			MCMS1315	MCMA1315	MIMS1315	MEMS1315
			MCMS131**	MCMA131**	MIMS131**	MEMS131**
4		6.56 ft (2m) 13.12 ft (4m) 16.40 ft (5m) All other lengths▲	MCMS1412	MCMA1412	MIMS1412	MEMS1412
			MCMS1414	MCMA1414	MIMS1414	MEMS1414
			MCMS1415	MCMA1415	MIMS1415	MEMS1415
			MCMS141**	MCMA141**	MIMS141**	MEMS141**
5		6.56 ft (2m) 13.12 ft (4m) 16.40 ft (5m) All other lengths▲	MCMS1512	MCMA1512	MIMS1512	MEMS1512
			MCMS1514	MCMA1514	MIMS1514	MEMS1514
			MCMS1515	MCMA1515	MIMS1515	MEMS1515
			MCMS151**	MCMA151**	MIMS151**	MEMS151**

Note: ▲ Replace \*\* with length required in meters. For nylon coupling nuts, replace "M" with "N" per the ordering chart above.  
Example: change MCMA1412 to MCNA1412.

### Straight Female Plug

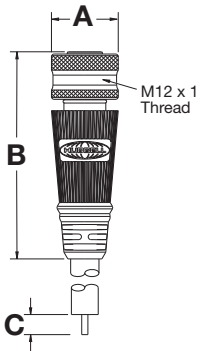

A	0.59" (15.0)
B	1.83" (46.5)
C	2.75" (69.9)

### Right Angle Female Plug

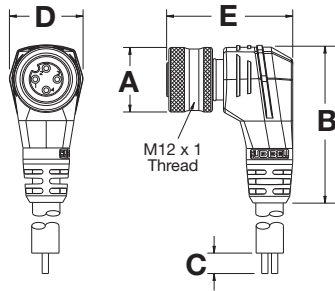

A	0.59" (15.0)
B	1.44" (36.6)
C	2.75" (69.9)
D	0.67" (17.0)
E	1.15" (29.2)

### Right Male In-Line Plug

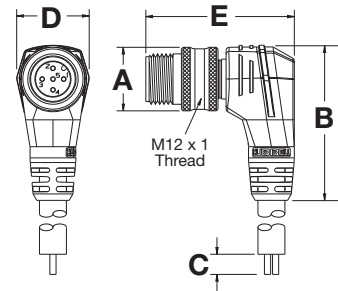

A	0.59" (15.0)
B	1.44" (36.6)
C	2.75" (69.9)
D	0.67" (17.0)
E	1.38" (35.1)

### Straight Male In-Line Plug

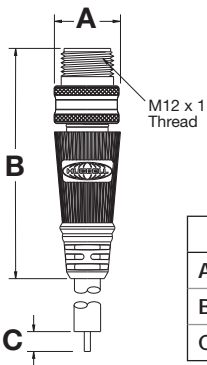

	MALE
A	0.59" (15.0)
B	2.06" (52.3)
C	2.75" (69.9)

### Extension Cable

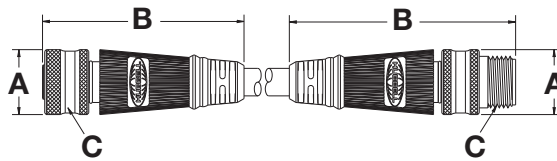

	FEMALE	MALE
A	0.59" (15.0)	0.59" (15.0)
B	1.83" (46.5)	2.06" (52.3)
C	M12 x 1	

### Cable Diameters By Cable Type

Number of Conductors	#22 AWG PVC	#18 AWG TPE
3	0.21" (5.3)	0.24" (6.1)
4	0.22" (5.7)	0.26" (6.6)
5	0.26" (6.6)	0.28" (7.1)

### Conductor Color Code

Contact Number	3 Pole	4 Pole	5 Pole
1	Brown	Brown	Brown
2	Not Used	White	White
3	Blue	Blue	Blue
4	Black	Black	Black
5	Not Used	Not Used	Gray

### Accessories

#### Dust Caps

Closure caps protect plugs and receptacles when not in use. Thread is M12 x 1.

Catalog Number	
MRCM1	
MPCM1	

Dimensions in Inches (mm)



Choose the appropriate configuration from the Selector below.

## Hubbell Logic Configurator

For example, catalog number **MRMS13314** is derived as follows:

DEVICE TYPE	COUPLING NUT MATERIAL	BODY STYLE	KEY STYLE	POLES	CONDUCTOR TYPE	REAR THREAD STYLE
MB = Receptacle, Male MF = Receptacle, Female Inverse	M = Metallic	S = Straight	1 = Single	3 4 5	3 = #22 AWG PVC Discrete Wire 4 = #18 AWG PVC Discrete Wire*	14 = M14x1* 25 = ¼" NPT** 50 = ½" NPT*
↓	↓	↓	↓	↓	↓	↓
<b>MR</b>	<b>M</b>	<b>S</b>	<b>1</b>	<b>3</b>	<b>3</b>	<b>14</b>

\*3 - 4 Pole Only  
\*MB Style Only  
\*\*MF Style Only

Note: Availability of specific items may vary. Consult factory for delivery. Consult the factory for additional cable lengths or cable types.

## 3 - 5 Pole Single Key Receptacles- #22 AWG Discrete Wire\*

Catalog numbers using #22 AWG PVC discrete wire are listed below. For #18 AWG PVC discrete wire, change the conductor type per the Hubbell Logic chart above.

Poles	Male Face Shown Female - mirror image	Male Receptacle Rear Thread Style		Female Inverse Receptacles Rear Thread Style
		M14 x 1	½" NPT	¼" NPT
3		MBMS13314	MBMS13350	MFMS13325
4		MBMS14314	MBMS14350	MFMS14325
5		MBMS15314	MBMS15350	MFMS15325

Note: \*For #18 AWG discrete wire, replace the conductor type per Hubbell Logic chart above.  
All receptacles available in 1ft. length standard. For additional lengths, please consult factory.

# Micro-Quick® Control Connectors Single Key 3 - 5 Pole Receptacles

Drawings (in/mm)



## Male Receptacle Rear Thread - M14x1

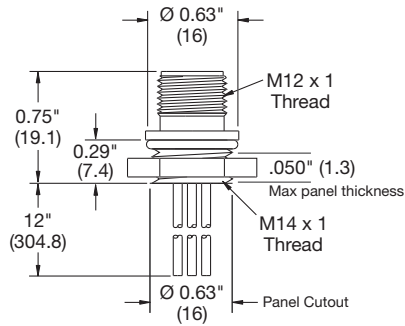

## Male Receptacle Rear Thread - ½" NPT

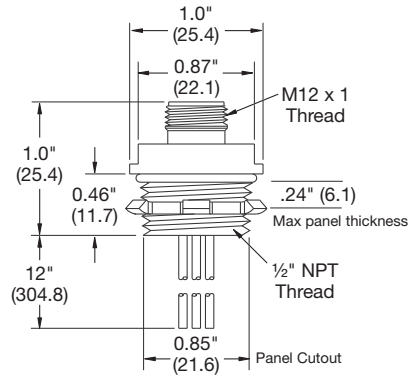

## Female Inverse Receptacle Rear Thread - ¼" NPT

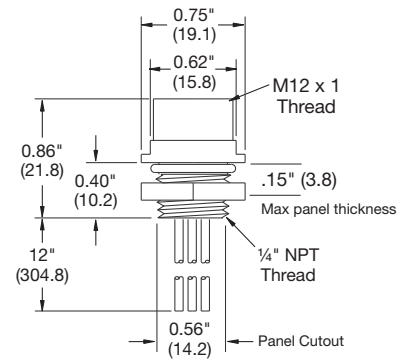

## Conductor Color Code - Single Key

Contact Number	3 Pole	4 Pole	5 Pole
1	Brown	Brown	Brown
2	Not Used	White	White
3	Blue	Blue	Blue
4	Black	Black	Black
5	Not Used	Not Used	Gray

## Accessories

### Dust Caps

Closure caps protect plugs and receptacles when not in use. Thread is M12 x 1.

Catalog Number	
MRCM1	
MPCM1	

Dimensions in Inches (mm)

Choose the appropriate configuration from the Selector below.

## Hubbell Logic Configurator

For example, catalog number **MPMS2512** is derived as follows:

DEVICE TYPE	COUPLING NUT MATERIAL	BODY STYLE	KEY STYLE	POLES	CONDUCTOR TYPE	CABLE LENGTH (m)
MC = Plug, Female MP = Plug, Male MI = Plug, Male Inline ME = Male/Female Extension Cable	M = Metallic N = Nylon	A = Right Angle S = Straight	2 = Dual	2 3 4 5 6	1 = #22 AWG PVC Cable 2 = #18 AWG TPE Cable*	** 2 4 5  **Replace with Length
↓	↓	↓	↓	↓	↓	↓
<b>MP</b>	<b>M</b>	<b>S</b>	<b>2</b>	<b>5</b>	<b>1</b>	<b>2</b>

Note: Availability of specific items may vary. Consult factory for delivery. Consult the factory for additional cable lengths or cable types.

## 2 - 6 Pole Dual Key Plugs

Catalog numbers using #22 AWG PVC cable are listed below. For #18 AWG TPE cable, change the conductor type per the Hubbell Logic chart above.

Poles	Male Face Shown Female - mirror image	Cable Length	Female Plugs		Male Plugs			Male/Female Extension Cables
			Straight	Right Angle	Straight	Right Angle	In-Line Straight	Straight
2		6.56 ft (2m)	MCMS2212	MCMA2212	MPMS2212	MPMA2212	MIMS2212	MEMS2212
		13.12 ft (4m)	MCMS2214	MCMA2214	MPMS2214	MPMA2214	MIMS2214	MEMS2214
		16.40 ft (5m)	MCMS2215	MCMA2215	MPMS2215	MPMA2215	MIMS2215	MEMS2215
		All other lengths▲	MCMS221**	MCMA221**	MPMS221**	MPMA221**	MIMS221**	MEMS221**
3		6.56 ft (2m)	MCMS2312	MCMA2312	MPMS2312	MPMA2312	MIMS2312	MEMS2312
		13.12 ft (4m)	MCMS2314	MCMA2314	MPMS2314	MPMA2314	MIMS2314	MEMS2314
		16.40 ft (5m)	MCMS2315	MCMA2315	MPMS2315	MPMA2315	MIMS2315	MEMS2315
		All other lengths▲	MCMS231**	MCMA231**	MPMS231**	MPMA231**	MIMS231**	MEMS231**
4		6.56 ft (2m)	MCMS2412	MCMA2412	MPMS2412	MPMA2412	MIMS2412	MEMS2412
		13.12 ft (4m)	MCMS2414	MCMA2414	MPMS2414	MPMA2414	MIMS2414	MEMS2414
		16.40 ft (5m)	MCMS2415	MCMA2415	MPMS2415	MPMA2415	MIMS2415	MEMS2415
		All other lengths▲	MCMS241**	MCMA241**	MPMS241**	MPMA241**	MIMS241**	MEMS241**
5		6.56 ft (2m)	MCMS2512	MCMA2512	MPMS2512	MPMA2512	MIMS2512	MEMS2512
		13.12 ft (4m)	MCMS2514	MCMA2514	MPMS2514	MPMA2514	MIMS2514	MEMS2514
		16.40 ft (5m)	MCMS2515	MCMA2515	MPMS2515	MPMA2515	MIMS2515	MEMS2515
		All other lengths▲	MCMS251**	MCMA251**	MPMS251**	MPMA251**	MIMS251**	MEMS251**
6		6.56 ft (2m)	MCMS2612	MCMA2612	MPMS2612	MPMA2612	MIMS2612	MEMS2612
		13.12 ft (4m)	MCMS2614	MCMA2614	MPMS2614	MPMA2614	MIMS2614	MEMS2614
		16.40 ft (5m)	MCMS2615	MCMA2615	MPMS2615	MPMA2615	MIMS2615	MEMS2615
		All other lengths▲	MCMS261**	MCMA261**	MPMS261**	MPMA261**	MIMS261**	MEMS261**

Note: ▲ Replace \*\* with length required in meters. For nylon coupling nuts, replace "M" with "N" per the ordering chart above.  
Example: change MCMS2314 to MCNS2314.

## Straight Plug

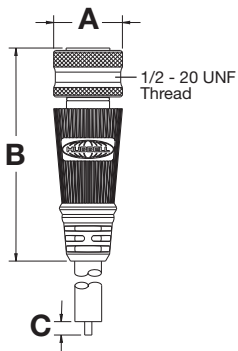

	MALE	FEMALE
A	0.59" (15.0)	0.59" (15.0)
B	1.83" (46.5)	1.83" (46.5)
C	2.75" (69.9)	2.75" (69.9)

## Right Angle Plug

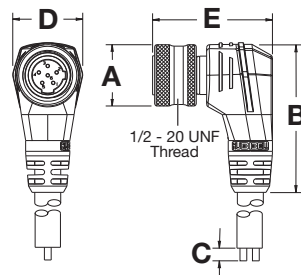

	MALE	FEMALE
A	0.59" (15.0)	0.59" (15.0)
B	1.44" (36.6)	1.44" (36.6)
C	2.75" (69.9)	2.75" (69.9)
D	0.67" (17.0)	0.67" (17.0)
E	1.15" (29.2)	1.15" (29.2)

## Right Angle Male In-Line Plug

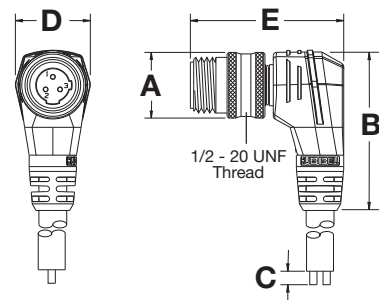

	MALE	FEMALE
A	0.59" (15.0)	0.59" (15.0)
B	1.44" (36.6)	1.44" (36.6)
C	2.75" (69.9)	2.75" (69.9)
D	0.67" (17.0)	0.67" (17.0)
E	1.38" (35.1)	1.38" (35.1)

## Male In-Line Plug

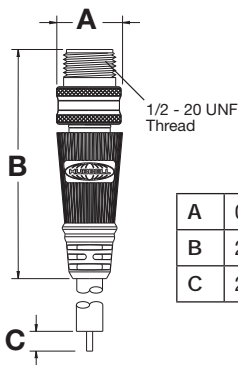

A	0.59" (15.0)
B	2.06" (52.3)
C	2.75" (69.9)

## Extension Cable

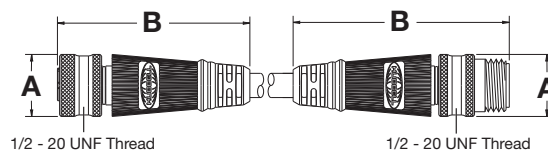

	MALE	FEMALE
A	0.59" (15.0)	0.59" (15.0)
B	2.06" (52.3)	1.83" (46.5)

## Conductor Color Code - Dual Key

Contact Number	2 Pole	3 Pole	4 Pole	5 Pole	6 Pole
1	Brown	Green	Red/Black	Red/White	Red/White
2	Blue	Red/Black	Red/White	Red	Red
3		Red/White	Red	Green	Green
4			Green	Red/Yellow	Red/Yellow
5				Red/Black	Red/Black
6					Red/Blue

## Cable Diameters By Cable Type

Number of Conductors	#22 AWG PVC	#18 AWG TPE
2	0.20" (5.1)	0.23" (5.8)
3	0.21" (5.3)	0.24" (6.09)
4	0.22" (5.7)	0.26" (6.6)
5	0.26" (6.7)	0.28" (7.1)
6	0.26" (6.5)	-

Dimensions in Inches (mm)

## Accessories

### Dust Caps

Closure caps protect plugs and receptacles when not in use. Key style is for dual with thread of 1/2"-20 UNF.

Catalog Number	
MRCM2	
MPCM2	

Choose the appropriate configuration from the Selector below.

## Hubbell Logic Configurator

For example, catalog number **MRMS22325** is derived as follows:

DEVICE TYPE	COUPLING NUT MATERIAL	BODY STYLE	KEY STYLE	POLES	CONDUCTOR TYPE	REAR THREAD STYLE
MR = Receptacle, Female MB = Receptacle, Male MF = Receptacle, Female Inverse	M = Metallic	S = Straight	2 = Dual	2 3 4 5 6	3 = #22 AWG PVC Discrete Wire 4 = #18 AWG PVC Discrete Wire*  *2 - 5 Pole Only	25 = ¼" NPT* 50 = ½" NPT  *MF Style Only
↓	↓	↓	↓	↓	↓	↓
<b>MR</b>	<b>M</b>	<b>S</b>	<b>2</b>	<b>2</b>	<b>3</b>	<b>25</b>

Note: Availability of specific items may vary. Consult factory for delivery. Consult the factory for additional cable lengths or cable types.

Male Receptacle Rear Thread Style		Female Inverse Receptacles Rear Thread Style
M14 X 1	½" NPT	¼" NPT

## 2 - 6 Pole Dual Key Receptacles

Catalog numbers using #22 AWG PVC cable are listed below. For #18 AWG PVC discrete wire, change the conductor type per the Hubbell Logic chart above.

Poles	Male Face Shown Female - mirror image	Female Receptacle Rear Thread Style		Male Receptacle Rear Thread Style		Female Inverse Receptacles
		¼" NPT	½" NPT	¼" NPT	½" NPT	
2		MRMS22325	MRMS22350	MBMS22325	MBMS22350	MFMS22325
3		MRMS23325	MRMS23350	MBMS23325	MBMS23350	MFMS23325
4		MRMS24325	MRMS24350	MBMS24325	MBMS24350	MFMS24325
5		MRMS25325	MRMS25350	MBMS25325	MBMS25350	MFMS25325
6		MRMS26325	MRMS26350	MBMS26325	MBMS26350	MFMS26325

## 1/4" NPT Rear Thread Receptacle

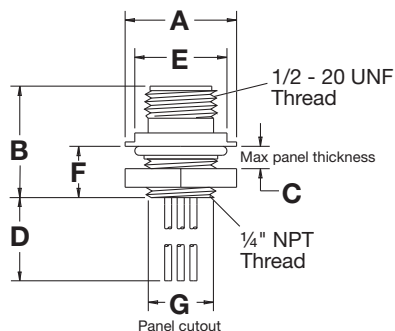

	MALE	FEMALE
A	0.75" (19.1)	0.75" (19.1)
B	0.75" (19.1)	0.86" (21.8)
C	0.10" (2.5)	0.10" (2.5)
D	12.0" (304.8)	12.0" (304.8)
E	0.62" (15.8)	0.62" (15.8)
F	0.35" (8.9)	0.38" (9.7)
G	0.56" (14.2)	0.56" (14.2)

## Female Inverse Receptacle 1/4" NPT Rear Thread

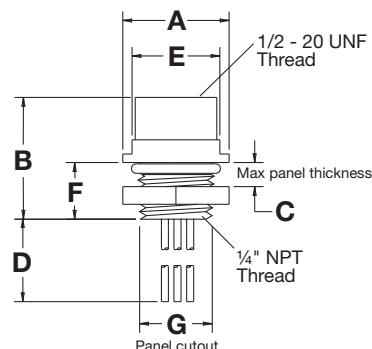

A	0.75" (19.1)
B	0.86" (21.8)
C	0.15" (3.8)
D	12.0" (304.8)
E	0.62" (15.8)
F	0.40" (10.2)
G	0.56" (14.2)

## 1/2" NPT Rear Thread Receptacle

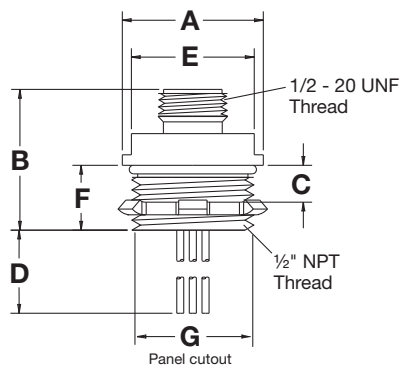

	MALE	FEMALE
A	1.00" (25.4)	1.00" (25.4)
B	1.00" (25.4)	1.00" (25.4)
C	0.24" (6.10)	0.24" (6.10)
D	12.0" (304.8)	12.0" (304.8)
E	0.87" (22.1)	0.87" (22.1)
F	0.46" (11.7)	0.46" (11.7)
G	0.85" (21.6)	0.85" (21.6)

## Conductor Color Code - Dual Key

Contact Number	2 Pole	3 Pole	4 Pole	5 Pole	6 Pole
1	Brown	Green	Red/Black	Red/White	Red/White
2	Blue	Red/Black	Red/White	Red	Red
3		Red/White	Red	Green	Green
4			Green	Red/Yellow	Red/Yellow
5				Red/Black	Red/Black
6					Red/Blue

## Accessories

### Dust Caps

Closure caps protect plugs and receptacles when not in use. Key style is for dual with thread of 1/2"-20 UNF.

Catalog Number	
MRCM2	
MPCM2	

Dimensions in Inches (mm)

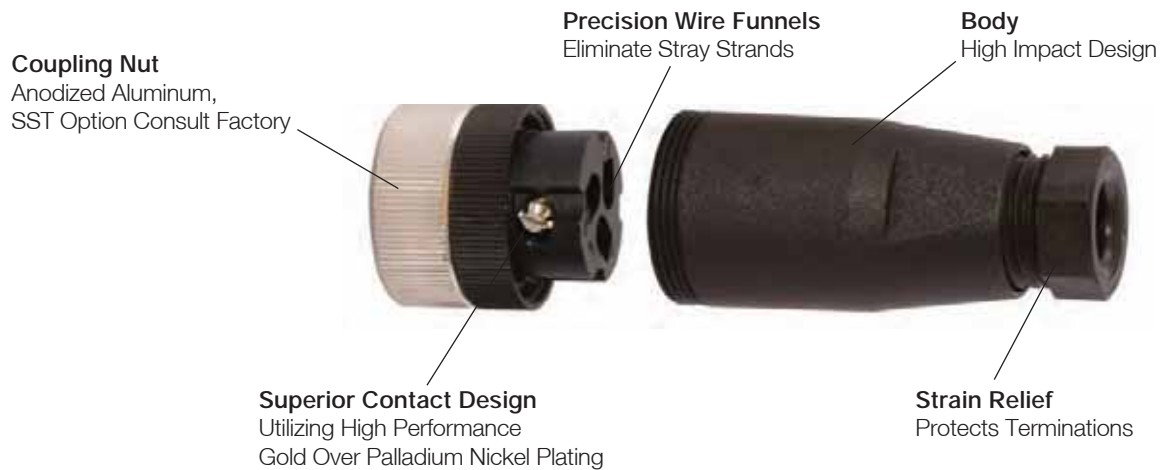

### 3 - 5 Pole Field Attachable Connectors

Poles	Male Face Shown Female - mirror image	Cable Range	Female Connector		Male In-Line Connector	
			Straight	Right Angle	Straight	Right Angle
3		.16"-.24" (4.1-6.1) .24"-.32" (6.1-8.1)	MCMS23F7	MCMA23F7	MIMS23F7	MIMA23F7
			MCMS23F9	MCMA23F9	MIMS23F9	MIMA23F9
4		.16"-.24" (4.1-6.1) .24"-.32" (6.1-8.1)	MCMS14F7	MCMA14F7	MIMS14F7	MIMA14F7
			MCMS14F9	MCMA14F9	MIMS14F9	MIMA14F9
5		.16"-.24" (4.1-6.1) .24"-.32" (6.1-8.1)	MCMS15F7	MCMA15F7	MIMS15F7	MIMA15F7
			MCMS15F9	MCMA15F9	MIMS15F9	MIMA15F9

#### Electrical Specifications

Voltage Rating	250V
Amperage	4A
Wire Size, Max	#18 AWG

#### Mechanical Specifications

Coupling Nut	Nickel plated brass, SST consult factory
Connector Shell	PBT
Connector Insert	Nylon
Contacts	Brass, gold plate over palladium nickel

#### Environmental Specifications

Moisture Resistance	IP66 Suitability
Operating Temperature	-40°C to 90°C

#### Female, Right Angle

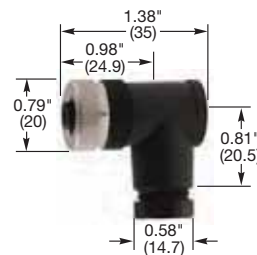

#### Female, Straight

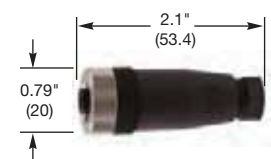

#### Male In-Line, Right Angle



#### Male In-Line, Straight



Dimensions in Inches (mm)

Allows field installation of control connector. Insulation Displacement Contacts do not require stripped conductors, greatly speeding installation.

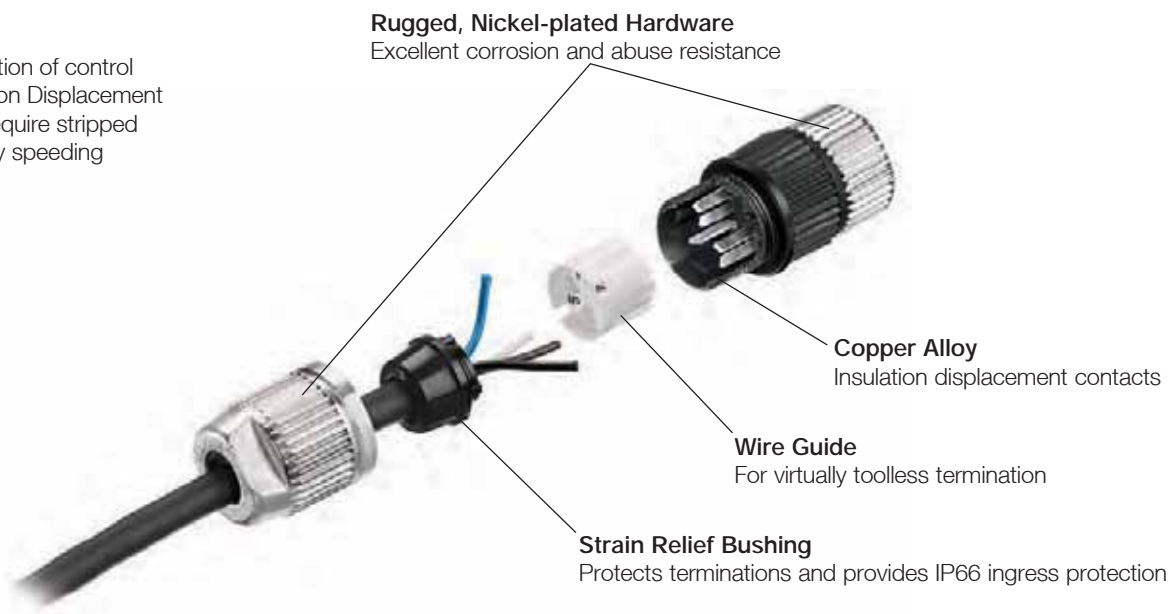

## Micro-Quick® IDC

Poles	Male Face Shown Female - mirror image	Cable Range	Wire Gauge	Female Connector		Male In-Line Connector	
				Straight	Right Angle	Straight	Right Angle
3		.16"-.21" (4.1-5.3) .22"-.32" (5.6-8.1)	22 - 24 18 - 22	MCMS13IDC	MCMA13IDC	MIMS13IDC	MIMA13IDC
				MCMS13IDCL	—	MIMS13IDCL	—
4		.16"-.21" (4.1-5.3) .22"-.32" (5.6-8.1)	22 - 24 18 - 22	MCMS14IDC	MCMA14IDC	MIMS14IDC	MIMA14IDC
				MCMS14IDCL	—	MIMS14IDCL	—



MCMS13IDC



MCMA13IDC



MCMS13IDCL



MIMS13IDC



MIMS13IDCL



MIMA13IDC

Dimensions in Inches (mm)

## Material Specifications

Housing	Polyester Elastomer, Black
Wire Guide	Nylon 6/6, Gray
Strain Relief Bushing	Neoprene, Black
Contact Materials	Copper Alloy
Contact Plating	Tin over Nickel
Coupling Nut	Zinc Alloy with Nickel Plating
O-ring	Neoprene, Black
Cable Compression Nut	Zinc Alloy with Nickel Plating

## Electrical Specifications

Catalog Suffix	IDC	IDCL
Voltage Rating	32V AC/DC	50V AC/DC
Wire Range	#22 AWG max., #24 AWG min.	#18 AWG max., #22 AWG min.
Cable Diameters	.160" to .211" (4.1 to 5.3 mm)	.22" to .32" (5.6 to 8.1 mm)
Amperage	3A	6A
Contact Res.	< 5 mΩ	< 5 mΩ

## Environmental Specifications

Ingress Protection	IP66 Suitability
Operating Temperature	-20°C to 110°C





## Features

- Nickel plated brass coupling nuts and receptacle shells.
- Black overmold and cable.
- Insulgrip connector body design.
- UL Listed cable assemblies and receptacles.
- Plating resists corrosion in high abuse environments.

## Benefits

- Strong, resilient base metal ensures contacts maintain their shape and continuity over time.
- Ergonomic connector body has an industrial look.
- Third party certified for electrical, mechanical and environmental performance.
- Cable assembly resists dirt and blends with environment giving a clean look to the installation.

## Material Specifications

Insulator Materials	Nylon 6/6, White	Cable	#24 AWG - PVC jacket, Black, PVC conductor insulation, Copper braid - 85% coverage, Stranding 19/36
Contact Materials	Pins - Brass, Sockets - Beryllium copper		#24 AWG - TPE jacket, Black, PVC conductor insulation, Stranding - 19/36
Contact Plating	Hard gold over palladium/nickel	Strain Relief	20 pounds min per UL 2238
Overmold Material	Polyurethane, Black		
Coupling Nut, Metallic	Nickel plated brass		
Receptacle Shell	Nickel plated brass		

## Electrical Specifications

Voltage Rating	125V AC/75V DC
Amperage	3&4P=4A
Contact Resistance	≤ 5 mΩ
Isolation Resistance	≥ 1000 MΩ

## Environmental Specifications

Moisture Protection	UL Type 4, 4X, 12 and 13
Ingress Protection	IP66 Suitability
Operating Temperature	PVC Cable: -20° to 105° C TPE Cable: -40°C to 105° C
Corrosion Resistance	500 hours salt spray per MIL-STD-1344, Method 1001
Vibration Resistance	10 - 2,000 Hz @15g per MIL-STD1344, Method 2005

## Certifications

UL 2238 and UL50E, File No. E192071

CSA Certified, C22.2 No. 182.3 and CSA C22.2 No. 94.2-07

# Nano-Quick® Control Connectors 3 - 4 Pole Plugs and Receptacles



Choose the appropriate configuration from the Selector below.

## Hubbell Logic Configurator

For example, catalog number **NCTA3105** is derived as follows:

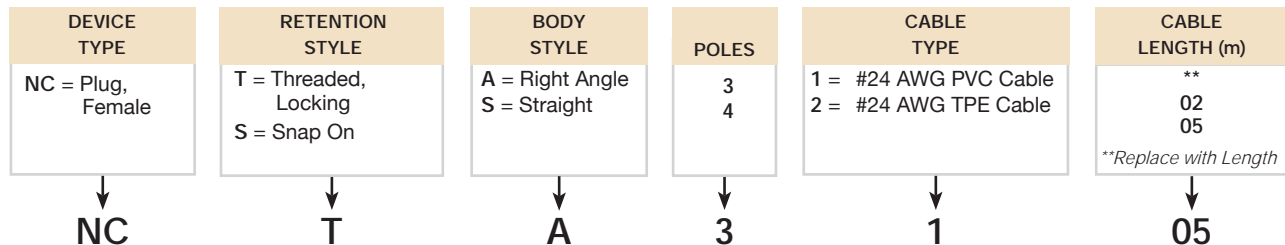

Note: Availability of specific items may vary. Consult factory for delivery. Use this chart to build plugs to meet any application need. Consult the factory for additional cable lengths or cable types.

## 3 - 4 Pole Female Plugs

Catalog numbers using #24 AWG PVC cable are listed below. For #24 AWG TPE cable, change the cable type per the Hubbell Logic chart above.

Poles	Female Face Shown	Cable Length	Threaded, Locking		Snap Together	
			Straight	Right Angle	Straight	Right Angle
3		6.56 ft (2m) 16.40 ft (5m) All other lengths ▲	NCTS3102	NCTA3102	NCSS3102	NCSA3102
			NCTS3105	NCTA3105	NCSS3105	NCSA3105
			NCTS31**	NCTA31**	NCSS31**	NCSA31**
4		6.56 ft (2m) 16.40 ft (5m) All other lengths ▲	NCTS4102	NCTA4102	NCSS4102	NCSA4102
			NCTS4105	NCTA4105	NCSS4105	NCSA4105
			NCTS41**	NCTA41**	NCSS41**	NCSA41**

Note: ▲ Replace \*\* with length required in feet. For snap on retention style, replace "T" with "S" per the ordering chart above.  
Example: change NCTA3105 to NCSA3105.

## Hubbell Logic Configurator

For example, Catalog Number **NBCS3D** is derived as follows:

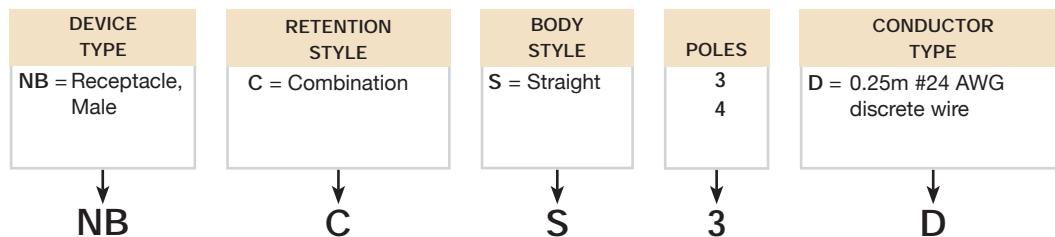

## 3 - 4 Pole Male Receptacles

Poles	Male Face Shown	Male Receptacle Rear Thread Style
		M8 x 1
3		NBCS3D

Poles	Male Face Shown	Male Receptacle Rear Thread Style
		M8 x 1
4		NBCS4D

Note: Replace \*\* with length required in feet.

### Straight Female Locking Plug

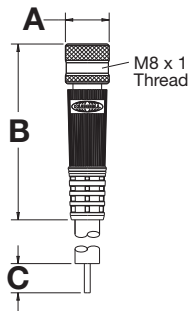

A	0.38" (9.7)
B	1.51" (38.4)
C	2.75" (69.9)

### Right Angle Female Locking Plug

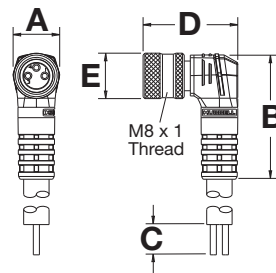

A	0.39" (9.9)
B	1.04" (26.4)
C	2.75" (69.9)
D	0.78" (19.8)
E	0.38" (9.7)

### Straight Female Snap Together Plug

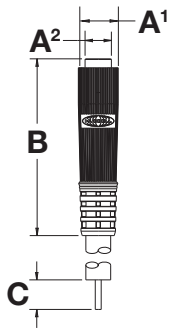

A <sup>1</sup>	0.34" (8.6)
A <sup>2</sup>	0.22" (5.6)
B	1.50" (38.1)
C	2.75" (69.9)

### Right Angle Female Snap Together Plug

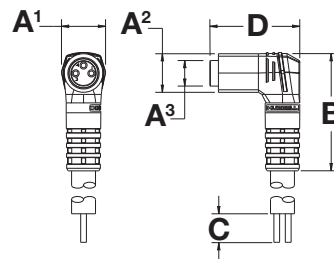

A <sup>1</sup>	0.39" (9.9)
A <sup>2</sup>	0.38" (9.7)
A <sup>3</sup>	0.22" (5.6)
B	1.04" (26.4)
C	2.75" (69.9)
D	0.79" (20.1)

### Male Combination Receptacle

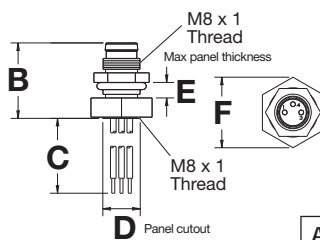

A	0.31" (7.9)
B	0.63" (16.0)
C	12.0" (304.8)
D	0.35" (8.8)
E	0.80" (2.0)
F	0.59" (15.0)

### Cable Diameters By Cable Type

Number of Conductors	#24 AWG PVC	#24 AWG TPE
3	0.21" (5.3)	0.21" (5.3)
4	0.21" (5.3)	0.21" (5.3)

### Conductor Color Code

Contact Number	3 Pole	4 Pole
1	Brown	Brown
2	Not Used	White
3	Blue	Blue
4	Black	Black

Dimensions in Inches (mm)

# Nano-Quick® Control Connectors Field Attachable Connectors - IDC Style

Allows field installation of control connector. Insulation Displacement Contacts do not require stripped conductors, greatly speeding installation.

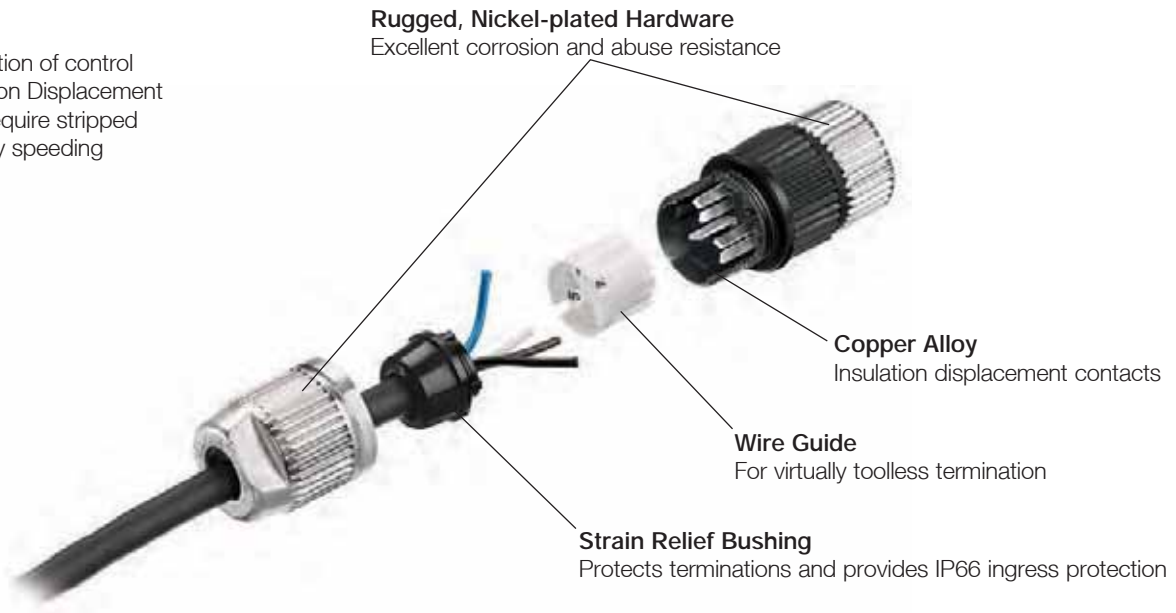

## Nano-Quick® IDC

Poles	Male Face Shown Female - mirror image	Cable Range	Wire Gauge	Female Connector	Male Connector
				Straight	Straight
3		.13"-.21" (3.3-5.3)	22 - 24	NCTS13IDC	NITS13IDC
4		.13"-.21" (3.3-5.3)	22 - 24	NCTS14IDC	NITS14IDC



NCTS13IDC

### Material Specifications

Housing	Polyester Elasmomer, Black
Wire Guide	Nylon 6/6, Gray
Strain Relief Bushing	Neoprene, Black
Contact Materials	Copper Alloy
Contact Plating	Tin over Nickel
Coupling Nut	Zinc Alloy with Nickel Plating
O-ring	Neoprene, Black
Cable Compression Nut	Zinc Alloy with Nickel Plating



NITS13IDC

### Electrical Specifications

Voltage Rating	32VAC/DC
Wire Range	#22 AWG max., #24 AWG min.
Cable Diameters	.13" to .21" (3.3 to 5.3 mm)
Amperage	3A
Contact Resistance	< 5 mΩ

### Environmental Specifications

Ingress Protection	IP66 Suitability
Operating Temperature	-20°C to 110°C

Dimensions in Inches (mm)

# Signal-Quick® Sensor Mounting Accessories

## Cushioned Sensor Mounts

### Sensor Mounts

Install tubular proximity sensors with a Cushioned Sensor Mount and protect against over-travel damage. Reduces replacement expenses and downtime. Hubbell's Cushioned Sensor Mounts feature:

- Spring-loaded housing eliminates impact damage.
- Reduces downtime and replacement expenses.
- Reduces spare sensor inventories.
- Shielded and non-shielded end caps eliminate abrasion damage.
- Block style or threaded housing designs.
- Anodized aluminum or stainless steel.

When something out of the ordinary happens or targets over-travel, the sensor simply retracts to avoid damage. The sensor returns to its original position and the equipment continues to operate.

### Material Specifications

Material: Anodized aluminum housing  
Zinc-plated brass jam nuts  
CSM12LP is all Stainless Steel

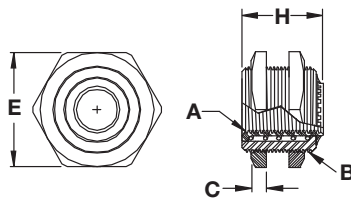

Threaded Style

### Threaded Style

Catalog Number	A	B	C	E	H
CSM8	M8 x 1	M16 x 1.5	0.12" (3.1)	0.87" (22.1)	0.87" (22.1)
CSM12LP	M12 x 1	M18 x 1	0.16" (4.1)	0.95" (24)	0.83" (21.1)
CSM18	M18 x 1	M30 x 1.5	0.20" (5.1)	1.41" (35.8)	1.17" (29.7)
CSM30	M30 x 1.5	M47 x 1.5	0.20" (5.1)	2.01" (51)	1.47" (37.3)

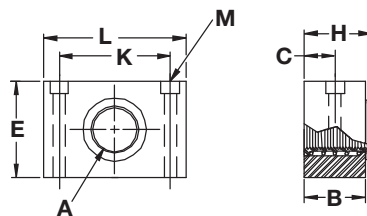

Block Style

### Block Style

Catalog Number	A	B	C	E	H	K	L	M
BCSM8	M8 x 1	0.75" (19)	0.37" (9.5)	0.62" (15.8)	0.87" (22.1)	0.72" (18.4)	1.0" (25.4)	0.14" (3.6)
BCSM12	M12 x 1	0.75" (19)	0.37" (9.5)	1.0" (25.4)	0.87" (22.1)	0.98" (24.8)	1.5" (38.1)	0.20" (5.2)
BCSM18	M18 x 1	1.0" (25.4)	0.50" (12.7)	1.25" (31.7)	1.17" (29.7)	1.21" (30.7)	1.5" (38.1)	0.18" (4.6)
BCSM30	M30 x 1.5	1.38" (34.9)	0.68" (17.5)	2.0" (50.8)	1.47" (37.4)	2.03" (51.5)	2.5" (63.5)	0.26" (6.7)

Dimensions in Inches (mm)

# Signal-Quick® Sensor Mounting Accessories

## Flat and Right Angle Adjustable Brackets



### Sensor Mounting Brackets

Eliminate design time and fabrication expense. Choose the Hubbell Angle Bracket or Flat Bracket to mount any tubular proximity sensor.

- Fixed mounting patterns or multi-slotted for positioning versatility.
- Industry standard mounting footprints.
- Rapid installation.
- Immediately available from stock.
- Cost savings over "make your own".

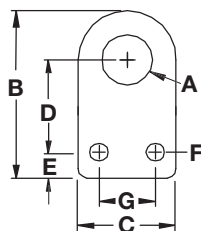

### Flat Brackets

Catalog Number	A	B	C	D	E	F	G	Thickness
FB12	0.48" (12.1)	1.95" (49.6)	1.25" (31.8)	0.86" (21.8)	0.47" (11.9)	0.22" (5.54)	0.75" (19.1)	0.12" (3.02)
FB18	0.72" (18.2)	2.27" (57.6)	1.38" (34.9)	1.36" (34.6)	0.22" (5.56)	0.24" (6.05)	1.0" (25.4)	0.12" (3.02)
FB30	1.19" (30.1)	3.42" (86.9)	2.0" (50.8)	2.05" (52)	0.37" (9.40)	0.31" (7.94)	1.25" (31.8)	0.12" (3.02)

### Material Specifications

Material: Stainless Steel

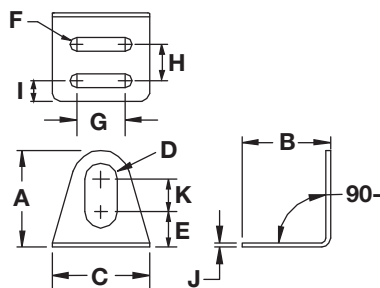

### Adjustable Angle Brackets

Catalog Number	A	B	C	D	E	F	G	H	I	J	K
AAB08	1.0" (25.4)	1.25" (31.8)	1.25" (31.8)	0.34" (8.74)	0.31" (7.92)	0.22" (5.54)	0.62" (15.9)	0.46" (11.9)	0.28" (7.14)	0.07" (1.78)	0.38" (9.53)
AAB12	1.5" (38.1)	1.37" (34.8)	1.5" (38.1)	0.50" (12.7)	0.55" (13.9)	0.22" (5.54)	0.75" (19.1)	0.56" (14.3)	0.31" (7.92)	0.07" (1.78)	0.50" (12.7)
AAB18	2.0" (50.8)	1.37" (34.8)	1.75" (44.5)	0.72" (18.3)	0.75" (19.1)	0.22" (5.54)	1.0" (25.4)	0.56" (14.3)	0.31" (7.92)	0.07" (1.78)	0.63" (15.9)
AAB22	2.0" (50.8)	1.37" (34.8)	1.75" (44.5)	0.88" (22.2)	0.69" (17.4)	0.22" (5.54)	1.0" (25.4)	0.56" (14.3)	0.31" (7.92)	0.07" (1.78)	0.63" (15.9)
AAB30	2.5" (63.5)	1.75" (44.5)	2.25" (57.2)	1.19" (30.1)	0.91" (23)	0.28" (7.11)	1.37" (34.8)	0.81" (20.6)	0.41" (10.3)	0.09" (2.29)	0.75" (19.1)

### Material Specifications

Material: Stainless steel  
Zinc-plated steel (AAB47)

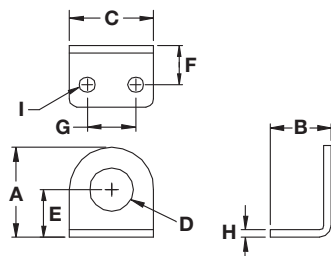

### Angle Brackets

Catalog Number	A	B	C	D	E	F	G	H	I
AB12	1.16" (29.3)	1.0" (25.4)	1.25" (31.8)	0.48" (12.1)	0.53" (13.5)	0.53" (13.5)	0.75" (19.1)	0.12" (3.02)	0.22" (5.6)
AB18	1.47" (37.3)	1.0" (25.4)	1.38" (34.9)	0.48" (12.1)	0.53" (13.5)	0.78" (19.8)	1.0" (25.4)	1.12" (3.02)	0.24" (6.0)
AB30	2.13" (54.0)	1.50" (38.1)	2.00" (50.8)	1.19" (30.1)	1.13" (28.7)	1.13" (28.7)	1.25" (31.8)	0.12" (3.02)	0.31" (7.9)

### Material Specifications

Material: Stainless Steel

Dimensions in Inches (mm)

# Signal-Quick® Sensor Mounting Accessories End Caps and Block Mounts

## End Caps

- Use alone or with Cushioned Sensor Mount.
- Beveled edge deflects lateral impacts.
- Reduces and or eliminates abrasion damage.
- Reduces downtime and sensor replacement expenses.



## Specifications

Material: Delrin (Non-Shielded)  
Glass-filled Nylon (Shielded)  
Polypropylene (EC30)

### Shielded

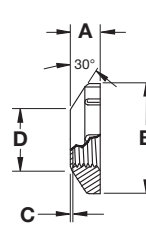

### Non-Shielded

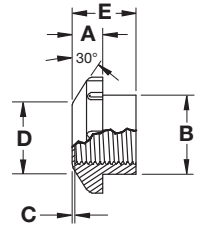

## End Caps

Shielded	Style	A	B	C	D	E	Thread
EC08	8mm	0.21" (5.28)	0.60" (15.2)	0.015" (.38)	0.25" (6.45)	N/A	M8 x 1
EC12	12mm	0.25" (6.35)	0.96" (24.4)	0.015" (.38)	0.45" (11.4)	N/A	M12 x 1
EC18	18mm	0.33" (8.38)	1.23" (31.3)	0.03" (.76)	0.73" (17.5)	N/A	M18 x 1
EC30	30mm	0.30" (7.62)	1.72" (43.7)	0.03" (.76)	1.13" (28.6)	N/A	M30 x 1
Non-Shielded							
EC08N	8mm	0.20" (5.08)	0.57" (14.5)	0.015" (.38)	0.25" (6.45)	0.37" (9.50)	M8 x 2
EC12N	12mm	0.25" (6.35)	0.90" (22.9)	0.03" (.76)	0.45" (11.4)	0.68" (17.3)	M12 x 1
EC18N	18mm	0.33" (8.38)	1.34" (34.0)	0.025" (.64)	0.67" (17.0)	0.70" (17.8)	M18 x 1
EC30N	30mm	0.31" (7.87)	1.75" (44.5)	0.04" (1.02)	1.15" (29.2)	0.90" (22.9)	M30 x 1

Note: The wear surface thickness (Dimension C) does not reduce a sensor's sensing range, but will consume an equal amount of the gap required between the sensor and target.

## Block Mounts

Bond to sensor face with any epoxy.

- Use when threads are inaccessible.
- Reduces and/or eliminates abrasion damage.
- Reduces downtime and sensor replacement expenses.



## Specifications

Material: Glass-filled Nylon  
Anodized aluminum

### Metallic

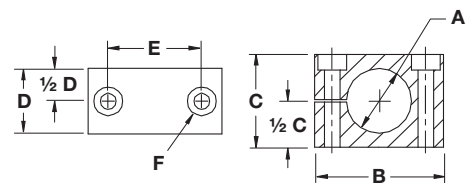

### Nylon

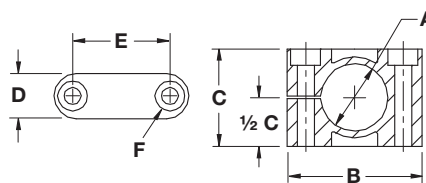

## Block Mounts

Metallic	Style	A	B	C	D	E	F
BM08M	8mm	0.32" (8.05)	0.62" (15.8)	1.0" (25.4)	0.75" (19.0)	0.72" (18.4)	0.14" (3.58)
BM12M	12mm	0.48" (12.1)	1.0" (25.4)	1.5" (38.1)	0.75" (19.0)	0.98" (24.9)	0.20" (5.08)
BM18M	18mm	0.71" (18.1)	1.25" (31.7)	1.5" (38.1)	1.0" (25.4)	1.21" (30.7)	0.18" (4.58)
BM30M	30mm	1.19" (30.1)	2.0" (50.8)	2.5" (63.5)	1.38" (34.9)	2.03" (51.5)	0.26" (6.73)
Nylon							
BM08N	8mm	0.32" (8.05)	1.06" (27)	0.63" (16)	0.47" (12)	0.67" (17)	0.18" (4.5)
BM12N	12mm	0.48" (12.1)	1.26" (32)	0.79" (20)	0.47" (12)	0.87" (22)	0.18" (4.5)
BM16N	16mm	0.63" (16.1)	1.42" (36)	1.02" (26)	0.47" (12)	1.02" (26)	0.18" (4.5)
BM18N	18mm	0.71" (18.1)	1.42" (36)	1.02" (26)	0.47" (12)	1.02" (26)	0.18" (4.5)
BM20N	20mm	0.79" (20.1)	1.77" (45)	1.18" (30)	0.59" (15)	1.26" (32)	0.22" (5.5)
BM22N	22mm	0.87" (22.1)	1.77" (45)	1.18" (30)	0.59" (15)	1.26" (32)	0.22" (5.5)
BM30N	30mm	1.18" (30.1)	2.17" (55)	1.50" (38)	0.71" (18)	1.65" (42)	0.22" (5.5)

Dimensions in Inches (mm)

# Signal-Quick® Sensor Mounting Accessories

## Universal Aiming Brackets



### Universal Aiming Brackets

Attach limit switch style (30mm threaded base) or threaded barrel photoelectric and ultrasonic sensors. Achieve secure mounting quickly and with ease.

- Swivel action for aiming simplicity.
- Durable glass-filled nylon construction.
- Regular or extended base models.
- Sizes for 12, 18 and 30mm threaded sensors.

### Material Specifications

Material: Glass-filled Nylon

### Bracket, Standard

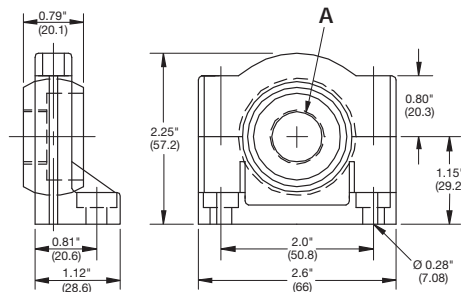

### Bracket, Extended

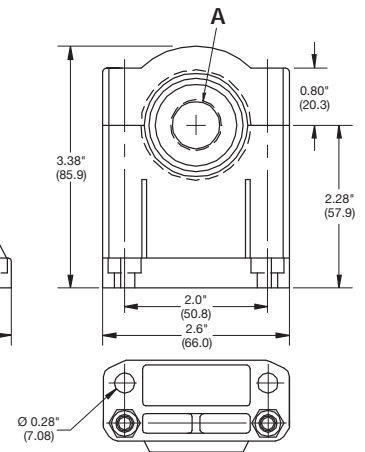

### Universal Aiming Brackets

Catalog Number	Style	Description	Thread
UB12	12mm	Bracket	M12 x 1
UB12E	12mm	Bracket, Extended Base	M12 x 1
UB18	18mm	Bracket	M18 x 1
UB18E	18mm	Bracket, Extended Base	M18 x 1
UB30	30mm	Bracket	M30 x 1.5
UB30E	30mm	Bracket, Extended Base	M30 x 1.5

Dimensions in Inches (mm)



## CableTrak® Hose and Cable Carrier System Assembly and Installation

The design of CableTrak carriers provides easy access to components during installation and repair. The track's flip top design allows the installer to lay cable and hose components directly into the track instead of pulling them through the length of the track. Hubbell CableTrak carriers can be ordered as assembled kits with brackets or by the foot without brackets. The final length of the track is easily customized by adding or removing sections of track or individual links with a flat head screwdriver.

### CableTrak® Installation

1. Unlock Tab.
2. Locking tabs secure the retaining bar into place.  
To unlock tabs, slide a flat head screwdriver under the tab and release it with a twisting motion.

### Access/Install Cables and Hoses

3. Easy access is important, especially for pre-assembled cable/hose sets involving large O.D. plugs, receptacles, and couplings.
4. Lock Tab.
5. To re-secure retaining bars, engage the hinge and snap the locking tab into place.

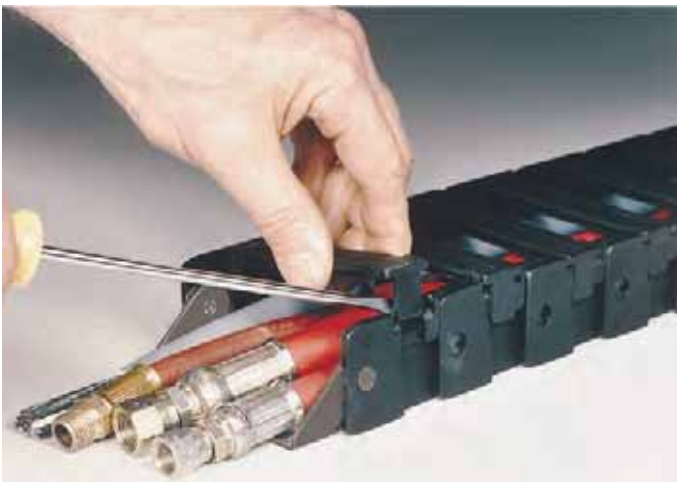

# CableTrak® Hose and Cable Carrier System

## CableTrak® Kit With and Without Brackets

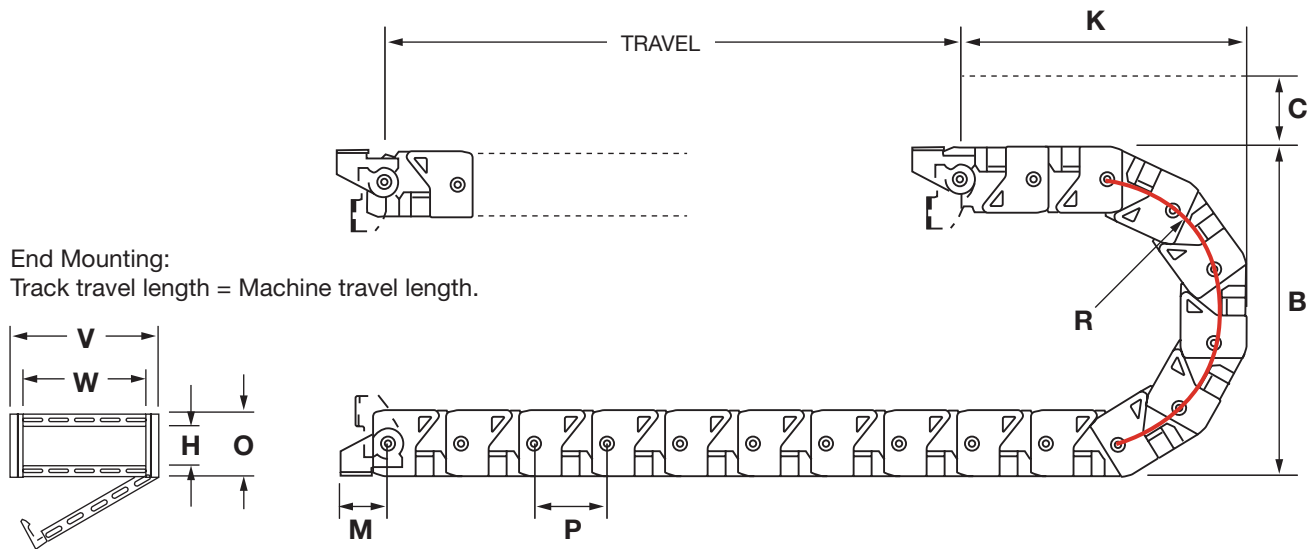

### CableTrak® Kit with Brackets

Catalog Number	Track Length (ft)	W Inner Width	H Inner Height	A Max Hose/Cab O.D.	B Max Component Width	V Outer Width	O Outer Height	R Bend Radius	B Bend Height	C Clearance	K Min Brkt to Bend	M Brkt to Pivot	P Pitch	L* Curve Length (ft)
HCT10114K**	4.0'	0.59"	0.75"	0.286"	0.531"	1.03"	1.00"	1.44"	3.86"	2.00"	5.68"	1.33"	1.250"	1.000'
HCT10219K**	4.0'	1.00"	0.75"	0.382"	0.900"	1.44"	1.00"	1.91"	4.82"	2.00"	5.41"	1.33"	1.250"	1.000'
HCT16119K	4.0'	1.50"	1.00"	0.382"	1.350"	2.12"	1.62"	1.91"	5.44"	3.00"	5.72"	1.19"	1.812"	1.000'
HCT16134K	4.5'	1.50"	1.00"	0.688"	1.350"	2.12"	1.62"	3.44"	8.50"	3.00"	7.85"	1.19"	1.812"	1.500'
HCT16219K	4.0'	2.28"	1.00"	0.328"	2.052"	2.91"	1.62"	1.91"	5.44"	3.00"	5.72"	1.19"	1.812"	1.000'
HCT16234K	4.5'	2.28"	1.00"	0.688"	2.052"	2.91"	1.62"	3.44"	8.50"	3.00"	7.85"	1.19"	1.812"	1.500'
HCT16334K	4.5'	3.08"	1.00"	0.688"	2.772"	3.70"	1.62"	3.44"	8.50"	3.00"	7.85"	1.19"	1.812"	1.500'
HCT16434K	4.5'	4.06"	1.00"	0.688"	3.654"	4.69"	1.62"	3.44"	8.50"	3.00"	7.85"	1.19"	1.812"	1.500'
HCT25134K	4.5'	2.60"	1.75"	0.680"	2.340"	3.70"	2.50"	3.40"	9.30"	3.00"	8.31"	1.75"	2.500"	1.500'
HCT25234K	4.5'	4.25"	1.75"	0.680"	3.825"	5.36"	2.50"	3.40"	9.30"	3.00"	8.31"	1.75"	2.500"	1.500'
HCT25247K	5.0'	4.25"	1.75"	0.956"	3.825"	5.36"	2.50"	4.78"	12.06"	3.00"	10.52"	1.75"	2.500"	2.000'
HCT25347K	5.0'	6.60"	1.75"	0.956"	5.940"	7.70"	2.50"	4.78"	12.06"	3.00"	10.52"	1.75"	2.500"	2.000'

### CableTrak® Kit without Brackets

Catalog Number	Track Length (ft)	W Inner Width	H Inner Height	A Max Hose/Cab O.D.	B Max Component Width	V Outer Width	O Outer Height	R Bend Radius	B Bend Height	C Clearance	P Pitch	L* Curve Length (ft)
HCT101141**	1.0'	0.59"	0.75"	0.286"	0.531"	1.03"	1.00"	1.44"	3.86"	2.00"	1.250"	1.000'
HCT102191**	1.0'	1.00"	0.75"	0.382"	0.900"	1.44"	1.00"	1.91"	4.82"	2.00"	1.250"	1.000'
HCT161191	1.0'	1.50"	1.00"	0.382"	1.350"	2.12"	1.62"	1.91"	5.44"	3.00"	1.812"	1.000'
HCT161341	1.0'	1.50"	1.00"	0.688"	1.350"	2.12"	1.62"	3.44"	8.50"	3.00"	1.812"	1.500'
HCT162191	1.0'	2.28"	1.00"	0.328"	2.052"	2.91"	1.62"	1.91"	5.44"	3.00"	1.812"	1.000'
HCT162341	1.0'	2.28"	1.00"	0.688"	2.052"	2.91"	1.62"	3.44"	8.50"	3.00"	1.812"	1.500'
HCT163341	1.0'	3.08"	1.00"	0.688"	2.772"	3.70"	1.62"	3.44"	8.50"	3.00"	1.812"	1.500'
HCT164341	1.0'	4.06"	1.00"	0.688"	3.654"	4.69"	1.62"	3.44"	8.50"	3.00"	1.812"	1.500'
HCT251341	1.0'	2.60"	1.75"	0.680"	2.340"	3.70"	2.50"	3.40"	9.30"	3.00"	2.500"	1.500'
HCT252341	1.0'	4.25"	1.75"	0.680"	3.825"	5.36"	2.50"	3.40"	9.30"	3.00"	2.500"	1.500'
HCT252471	1.0'	4.25"	1.75"	0.956"	3.825"	5.36"	2.50"	4.78"	12.06"	3.00"	2.500"	2.000'
HCT253471	1.0'	6.60"	1.75"	0.956"	5.940"	7.70"	2.50"	4.78"	12.06"	3.00"	2.500"	2.000'

Note: \*L = Minimum length in feet to form CableTrak curve.

\*\*These models do not have a flip top design and do not accept separators due to their small size.

Dimensions in Inches (mm)

# CableTrak® Hose and Cable Carrier System Accessories

**Center Mounting:** Mounting the fixed track end in the center of the machine travel allows the track to travel beyond the fixed end. Center mounting effectively doubles the travel distance of the track requiring half the track length of an end mounted application.

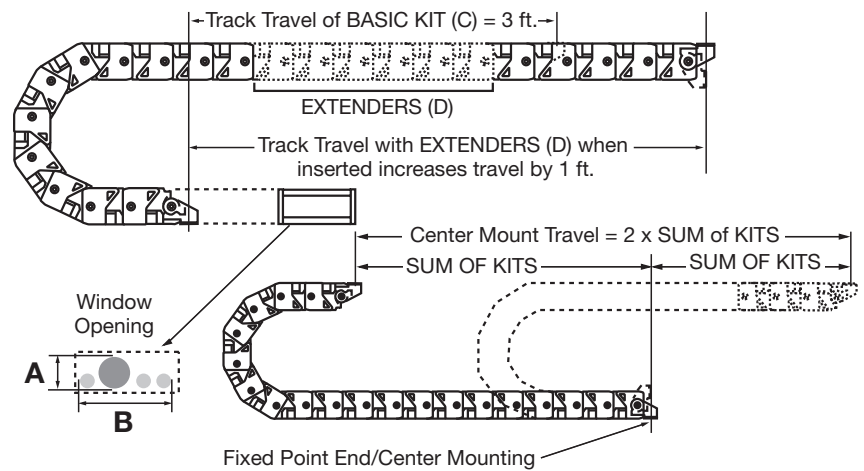

## Calculating

Center Mount (Stationary bracket mounted in center of travel range): Track Length = (MT/2) + L

End Mount (Stationary bracket mounted off center of travel range): Track Length = (MT/2) + L + offset from center in feet

MT = Total machine travel distance in feet

L = Length of track taken up by the bend radius

## Customizing Track Length

Hubbell CableTrak is easily customized by adding or subtracting links to the track. CableTrak kits provide 4 to 5 feet of track with brackets pre-installed. Track length can be increased by installing the required number of extenders to reach the required length. To further tune the length of track, individual links can be added or removed. To determine the number of links to add or remove, divide the length in inches to be added or subtracted by the pitch of the track and round up.

## CableTrak® Accessories

Bracket Kits	For Use With	A	B	C	D	E	F	G	H
HCTBK101	HCT101 Series	.40" (10.2)	.81" (20.6)	.47" (12.0)	.94" (23.9)	–	–	–	–
HCTBK102	HCT102 Series	.44" (11.2)	1.22" (31.0)	.44" (11.2)	1.35" (34.3)	–	–	–	–
HCTBK161	HCT161 Series	.99" (25.2)	1.97" (50.1)	.87" (22.1)	1.84" (46.7)	1.19" (30.2)	.281" (7.1)	.75" (19.1)	.81" (20.6)
HCTBK162	HCT162 Series	1.78" (45.2)	2.75" (69.9)	1.65" (41.9)	2.63" (66.8)	1.19" (30.2)	.281" (7.1)	.75" (19.1)	.81" (20.6)
HCTBK163	HCT163 Series	2.57" (65.3)	3.55" (90.2)	2.44" (62.0)	3.42" (86.9)	1.19" (30.2)	.281" (7.1)	.75" (19.1)	.81" (20.6)
HCTBK164	HCT164 Series	3.56" (90.4)	4.53" (115.1)	3.47" (88.1)	4.41" (112.0)	1.19" (30.2)	.281" (7.1)	.75" (19.1)	.81" (20.6)
HCTBK251	HCT251 Series	2.08" (52.8)	3.21" (81.5)	1.80" (45.7)	3.03" (77.0)	1.75" (44.5)	.344" (8.7)	1.00" (25.4)	1.25" (31.8)
HCTBK252	HCT252 Series	3.74" (95.0)	4.87" (123.7)	3.46" (87.9)	4.69" (119.1)	1.75" (44.5)	.344" (8.7)	1.00" (25.4)	1.25" (31.8)
HCTBK253	HCT253 Series	6.08" (154.4)	7.21" (183.1)	5.80" (147.3)	7.03" (178.6)	1.75" (44.5)	.344" (8.7)	1.00" (25.4)	1.25" (31.8)
Separators	For Use With	A	B	C	D	E	F		
HCTSP16PK12	HCT16 Series	1.24" (31.5)	.82" (20.8)	.94" (23.9)	.27" (6.9)	.14" (3.6)	.50" (12.7)		
HCTSP25PK12	HCT25 Series	2.03" (51.6)	1.00" (25.4)	1.19" (30.2)	.35" (8.9)	.15" (3.8)	.62" (15.8)		

### HCTBK101 – Brackets

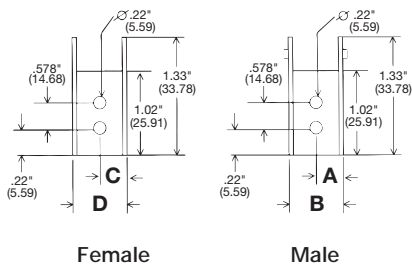

### HCTBK102 – Brackets

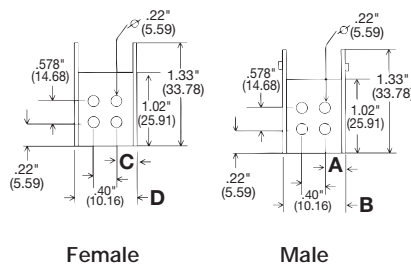

### HCTBK161 – HCTGK253 Brackets

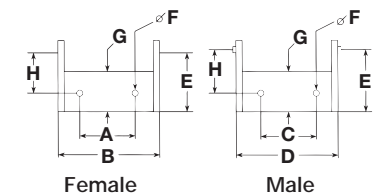

### Separators

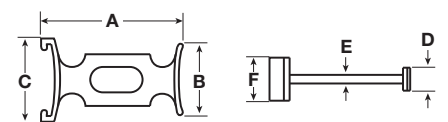

Dimensions in Inches (mm)

# CableTrak® Hose and Cable Carrier System Mounting Options and Specifications

## Horizontal Travel

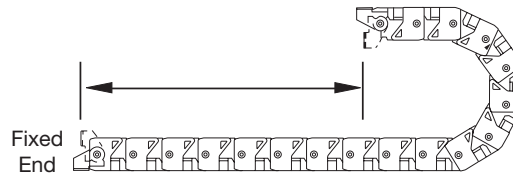
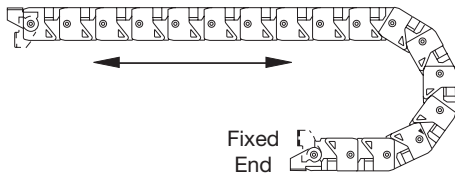

## Combination Horizontal & Vertical Travel

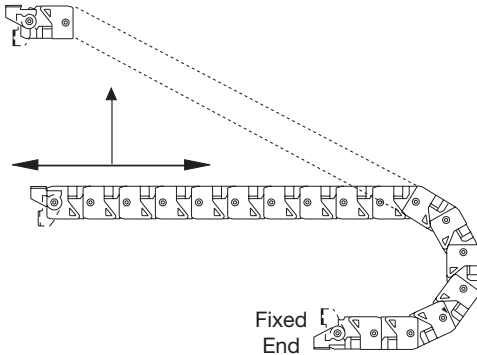

## Opposed Travel

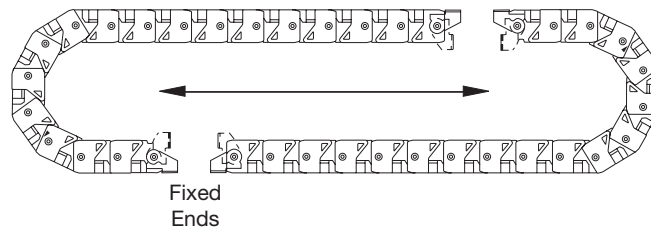

## Vertical Travel

### Curve Up

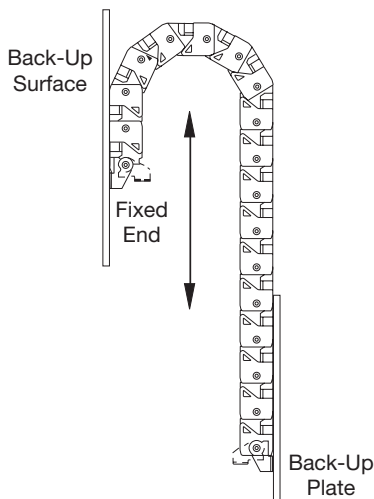

### Curve Down

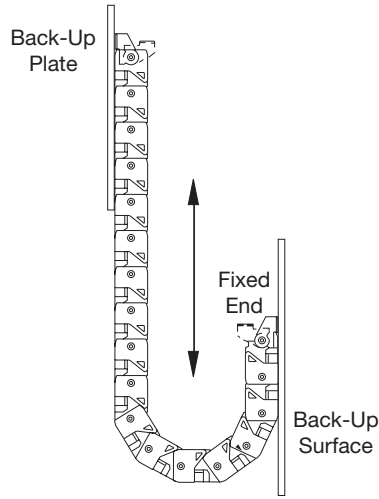

## Specifications

Material	Fiberglass reinforced nylon.
Operating Temperature	Continuous +20°F to +100°F (-7°C to 38°C). Intermittent* -40°F to +220°F (-40°C to 104°C).
Maximum Operating Speed	600 FPM (feet per minute), 180 MPM (meters per minute). Operating speed is based on short lengths that are self supported (up to 9ft.).
Maximum Unsupported Travel Distance	HCT16 Series without sag 9 ft. (2.8 m) with sag 10.5 ft. (3.2 m). HCT25 Series without sag 13.5 ft. (4.1 m) with sag 17 ft. (5.2 m).
Applications	Machine tool, robotic automation, material handling.

*Note: \*Intermittent refers to the operating of the product outside the normal (continuous operating) temperature range momentarily before returning back to the normal range.*

Hubbell's DIN Rail Utility Box offers a labor saving way to provide utility power to any control cabinet. Installing the DIN Rail Utility Box is as easy as snapping the box onto a 35mm DIN Rail and connecting the line, neutral and ground wires to the terminal block. Utility power for fans, lights, laptop computers, testers or any other power requirement. If load limiting is a concern, Hubbell's "CB" version comes with a 5 Amp circuit breaker that provides over-current protection to make sure that large loads are not drawn from the DIN Rail Utility Box. All Hubbell DIN Rail Utility Boxes may be mounted either vertically or horizontally on the DIN Rail; the "H" version comes with the terminal block mounted for easy wiring when the DIN Rail Utility Box is mounted horizontally.



15A 125V  
NEMA 5-15R  
UL CSA  
0.5 HP



20A 125V  
NEMA 5-20R  
UL CSA  
1 HP

### Duplex Receptacles

Description	Color	Catalog Number	
Complete unit.	Gray	<b>DRUB15</b>	<b>DRUB20</b>
Complete unit, horizontal mount.	Gray	<b>DRUB15H</b>	-
Complete unit with 5A circuit breaker.	Gray	<b>DRUB15CB5</b>	-
Complete unit with 5A circuit breaker, horizontal.	Gray	<b>DRUB15HCB5</b>	-
Complete unit with aux.	Gray	-	<b>DRUB20AC</b>
Complete unit with aux and 5A circuit breaker.	Gray	-	<b>DRUB20ACCB5</b>
Complete unit with NEMA® 6-20R duplex (250V).	Gray	-	<b>DRUB5462*</b>

### GFCI Duplex Receptacles

Description	Color	Catalog Number	
Complete unit.	Gray	<b>DRUBGF115</b>	<b>DRUBGF120</b>
Complete unit, horizontal.	Gray	<b>DRUBGF115H</b>	-
Complete unit with 5A circuit breaker.	Gray	<b>DRUBGF115CB5</b>	-
Complete unit with 5A circuit breaker, horizontal.	Gray	<b>DRUBGF115HCB5</b>	-
Complete unit with aux GFCI contacts.	Gray	<b>DRUBGF115AC</b>	<b>DRUBGF120AC</b>
Complete unit, faceless with aux GFCI contacts.	Gray	-	<b>DRUBGF120BFAC</b>

### TVSS Duplex Receptacles

Description	Color	Catalog Number	
Complete unit.	Gray	<b>DRUBTVSS15</b>	-

### Isolated Ground<sup>Δ</sup> Duplex Receptacles

Description	Color	Catalog Number	
Complete unit.	Gray	<b>DRUBIG15</b>	-

### Toggle Switch Unit

Description	Color	Catalog Number
Complete unit with HBL1221.	Gray	<b>DRUB1221AC</b>
Complete unit with 15A 125V SW/REC.	Gray	<b>DRUB6404</b>

### DIN Rail Utility Box Components

Description	Color	Catalog Number
Pre-wired kit without circuit breaker.	Gray	<b>DRUBKIT</b>
Pre-wired kit with circuit breaker.	Gray	<b>DRUBKITCB5</b>
Pre-wired kit with aux.	Gray	<b>DRUBKITAC</b>
Pre-wired kit with circuit breaker and aux.	Gray	<b>DRUBKITACCB5</b>
Communications kit (unloaded).	Gray	<b>HIDRUBCKIT</b>
(For use with Network Wiring frames in section W).		
Switch plate only.	Gray	<b>KP1GY**</b>
Rectangular opening plate only.	Gray	<b>KP26GY**</b>
1.60 in. opening plate only.	Gray	<b>KP720GY**</b>
1.40 in. opening plate only.	Gray	<b>KP7GY**</b>
Duplex receptacle plate only.	Gray	<b>KP8GY**</b>

Note: <sup>Δ</sup> See section M for additional information on isolated ground devices.

\*DRUB5462 configuration not pictured.

\*\*UL Listed, CSA Certified.

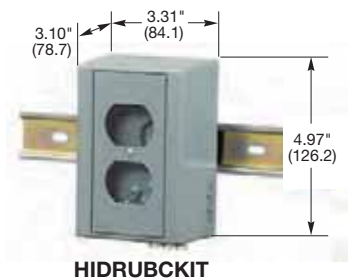
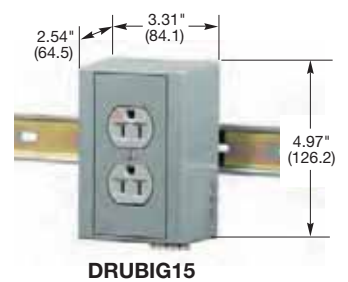
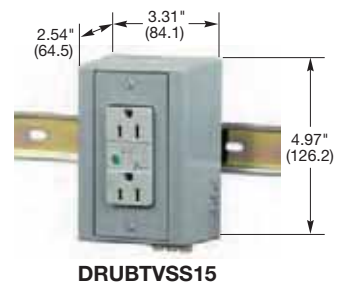
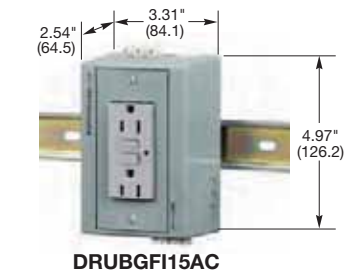
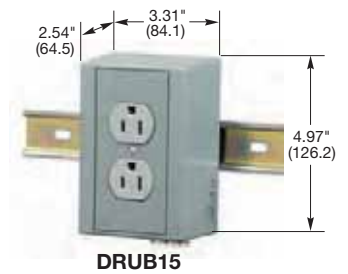

NEMA® is a registered trademark of the National Electrical Manufacturers Association.

Dimensions in Inches (mm)

# PANEL-SAFE® Features and Benefits

NFPA 70E Compliant



Available in  
NEMA TYPE 4, 12 and  
NEMA TYPE 4X Versions!

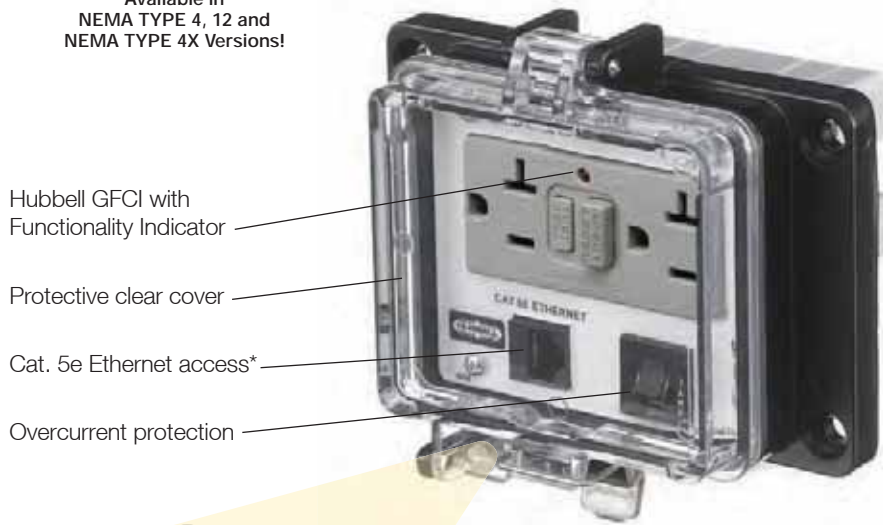

Hubbell GFCI with  
Functionality Indicator

Protective clear cover

Cat. 5e Ethernet access\*

Overcurrent protection



Supplemental "Tool"  
entry screw closure

Locking Hasp  
accepts 5/32" padlock

Additional convenience  
outlet on GFCI versions



Finger-safe contacts

Stainless steel snap latch

## Application



Note: \*Additional computer interfaces and PLC connections available upon request.

## Specifications

Electrical	GFCI - conforms to UL 943 2006 requirement In-Cabinet Receptacle - GFCI protected Data Jack - Cat. 5e Circuit Breaker - 3A	Environmental	Enclosure - NEMA Type 4, 12 and NEMA Type 4X
Mechanical	Cover - Clear Polycarbonate (UV Rated) Housing - Cast Aluminum Finish - Powder Coat Latch - Stainless steel	Certification	UL Recognized CSA Certified

**Power Only**

Description	NEMA TYPE 4, 12	NEMA TYPE 4X
20A 125V GFCI with In-Cabinet Receptacle.	<b>PR20</b>	—



PR20

**Data Only**

Description	NEMA TYPE 4, 12	NEMA TYPE 4X
Cat. 5e Ethernet Access only.	<b>P5E</b>	<b>P4X5E</b>
DB9 Interface Connector only.	<b>PDB9</b>	—
PANEL-SAFE Data Port with DB9 Connector.	<b>PDB9MF</b>	—
DH + Combo (DB9/8M Din) and Cat. 5e Ethernet.	<b>PDH5E</b>	—
PANEL-SAFE Data Port, 2 USBA, 3' Cable.	—	<b>P4XUSBA2C3</b>



P5E

**Power and Data**

Description	NEMA TYPE 4, 12	NEMA TYPE 4X
20A 125V GFCI with In-Cabinet Receptacle and Cat. 5e Ethernet Access.	<b>PR205E</b>	<b>PR4X205E</b>
20A 125V GFCI with In-Cabinet Receptacle, Cat. 5e Ethernet Access and 3A Circuit Breaker.	<b>PR205EB</b>	<b>PR4X205EB</b>
PANEL-SAFE with 20A GFCI and Cat.5E, DB9 and 3A Circuit Breaker.	<b>PR205EDB9B</b>	—
PANEL-SAFE with 20A GFCI and Cat.5E, 1 USB.	<b>PR205EUSBA</b>	—
PANEL-SAFE with 20A GFCI and Cat.5E, 2 USB.	<b>PR205EUSBA2</b>	—
PANEL-SAFE Data Access Port.	<b>PR205EUSBA2VGA</b>	—
20A 125V GFCI Power and Cat. 5e Ethernet, DH + Combo (DB9/8M Din).	<b>P20DH5E</b>	—
PANEL-SAFE with 20A GFCI and Cat.5/DB9.	<b>P205EDB9</b>	—
15A 125V Power and Cat. 5e Ethernet Access.	<b>P155E</b>	<b>P4X155E</b>
15A 125V Power, Cat. 5e Ethernet Access and 3A Circuit Breaker.	<b>P155EB</b>	<b>P4X155EB</b>
15A 125V Power and (2) Cat. 5e Ethernet Access.	<b>P155E2</b>	—
15A 120V AC Power, NEMA 12/4, DB9 M/F, 10' Cable.	<b>P15DB9MFC10</b>	—
15A 125V Power and DH485 Interface (RJ-45F to RJ-45M, 10' Cable).	<b>P15DH485C10</b>	—
15A 125V Power and Micrologix 8M Din/F to 8M Din/M, 10' Cable.	<b>P15ML8F8MC10</b>	—



PR205E



PR205EB



P155E



P155EB

**Additional computer interfaces, PLC connections and configurations available upon request. Consult factory for catalog number and availability.**

Hubbell's Industrial Ethernet System provides leading edge Category 5e and 6 network transmission performance suitable for industrial and other harsh environments. This system incorporates the use of our standard data connectivity jacks which feature our keystone latching mechanism, in a rugged sealed housing providing IP67 rated protection.

Extend your LAN to include automation equipment and manufacturing or process control equipment. Utilize the Hubbell system to provide added protection in harsh environments such as convention centers, food processing plants, outdoor billboards and display screens, medical and other environments which require added protection from moisture, corrosion, dust-debris, vibration and chemicals.

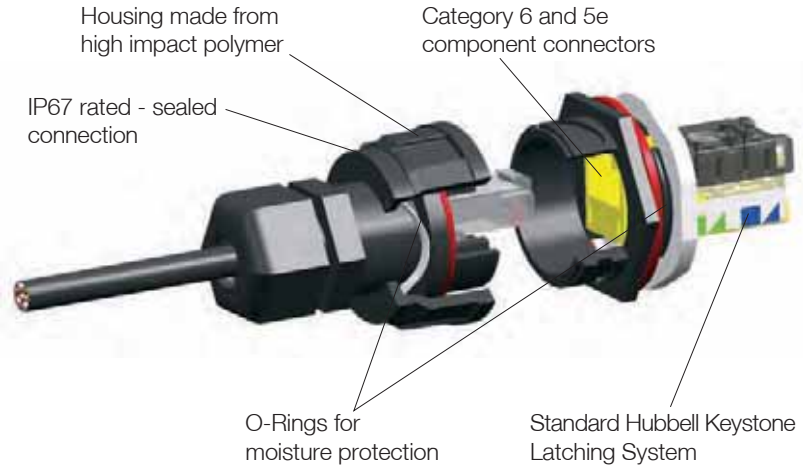

## Industrial Ethernet Connectors

Description	Catalog Number
Cat. 5e Connector	<b>HI5E</b>
Cat. 6 Connector	<b>HI6</b>
Cat. 5e Inline Coupler Connector	<b>HI5EC</b>
Cat. 6 Inline Coupler Connector	<b>HI6C</b>

## Environmental Specifications

Ingress Protection:	NEMA TYPE 4X (connectors). IP67 and IP66 (dust/water). IP55 (plates).
Corrosion:	Resistant to most common chemicals, oils and cleaning agents.
HI-Impact Housing:	UV resistant.
HI-Impact Housing Temperature Range:	TIA/EIA-568-B.2 -25°C to 70°C.

## Material

HI-Impact Housing:	Valox®, UL 94V-0.
Nose Contacts:	Beryllium copper with a minimum of 50 micro-inch gold plating over nickel under plating.

## Mechanical

Vibration	
Frequency Range:	10-500Hz.
Acceleration:	5g (operational).
Mating Cycles:	750 minimum.
UL 1863 compliant:	

## Electrical

ANSI/TIA/EIA-568-B.2-1 (Cat. 6 and 5e). Supports TIA-1005 Industrial Telecommunications Infrastructure.



## Industrial Ethernet Patch Cords and Plugs

Description	Catalog Number
HI-Impact RJ-45 to standard RJ-45.	<b>HI6xxAE</b>
HI-Impact RJ-45 on both ends.	<b>HI6xxEE</b>
Standard RJ-45 on both ends.	<b>HI6xxAA</b>

Note: Substitute "xx" with 03, 05, 07, 10, 15, 20, 25, 30, 35, 40, 45, 50 to indicate length in feet.

## Coupler Housing and Connector Cap

Description	Catalog Number
HI-Impact coupler housing is a perfect solution for temporary and flexible work areas where single port drops are needed. Add any HI-Impact connector to support your application.	<b>HICH</b>
Connector Cap	<b>HIC</b>

## HI-Impact Wallplates

Description	Port Openings	Gang	Catalog Number
Stainless steel wallplate.	1	1	<b>HISF11</b>
Stainless steel wallplate.	2	1	<b>HISF12</b>
Stainless steel wallplate.	2	2	<b>HISF22</b>
Stainless steel wallplate.	4	2	<b>HISF24</b>

Valox® is a trademark of SABIC Innovative Plastics, acquired from General Electric Company.



# Section J Cable, Cord and Hose Reels

## Index

Product	Page
Weatherproof Reels . . . . .	J-2
Industrial Power Cord Reels . . . . .	J-3
Industrial and Commercial Lighted Cord Reels . . . . .	J-4
Commercial Cord Reels . . . . .	J-5
Air/Water Hose Reels and Static Discharge Reels . . . . .	J-6

### Weatherproof Reels



### Industrial Reels



### Commercial Reels



### Air/Water Hose Reels and Static Discharge Reels



Multi-position roller guide can be mounted in four different positions

Ratchet lock can be disengaged in field for constant tension application

Powder coated, solid steel construction



**HBL501242W**

UL Type 4X enclosure protects spring motor, junction box, slip ring assembly and cable entrance from hosedown or corrosion

Optional pivot base allows 340° rotation of reel and increases range of cable to nearly any direction

## Weatherproof Cable Reels, 50 Ft. (15.2m)



**HBL501242W**

Description	Cable Type	Amps	Volts AC	Weight Lbs. (kg)	Catalog Number
14" weatherproof reel.	14/3 SOW-A	15	600	55 (24.9)	<b>HBL501431W*</b>
16" weatherproof reel.	12/3 SOW-A	20	600	80 (36.3)	<b>HBL501232W*</b>
16" weatherproof reel, (white reel housing).	12/3 SOW-A	20	600	80 (36.3)	<b>HBL501232WM1*</b>
16" weatherproof reel.	12/4 SOW-A	16	600	86 (39.0)	<b>HBL501242W*</b>
16" weatherproof reel.	10/3 SOW-A	25	600	86 (39.0)	<b>HBL501032W*</b>
16" weatherproof reel, (white reel housing).	10/3 SOW-A	25	600	86 (39.0)	<b>HBL501032WM1*</b>
16" weatherproof reel.	10/4 SOW-A	20	600	92 (41.7)	<b>HBL501042W*</b>

Note: \*All weatherproof cable reels are supplied with wire leads and 3/4" NPT hub feed. Power supply cable not supplied.

## Accessories



**HBL14PB**

Description	Weight Lbs. (kg)	Description
14" pivot base.	5 (2.3)	<b>HBL14PB</b>
16" pivot base.	13 (5.9)	<b>HBL16PB</b>
Replacement stop.	.2 (.09)	<b>HBLWPBS</b>

## Specifications

Listing/Certification	UL 355 and CSA, C22.2 No. 21.
Environment	Type 4X enclosure, CAN/CSA - C22.2 No. 21. Dry, indoor and wet and damp outdoor non-hazardous location.

## Dimensions

Inch (mm)	A	B	C	D	E	F	G	H	I	J
14" Reel	6.50" (165)	8.12" (206)	16.25" (413)	13.75" (349)	3.00" (76)	12.19" (310)	3.00" (76)	3.00" (76)	3.00" (76)	6.50" (165)
16" Reel	6.50" (165)	9.12" (232)	18.25" (464)	15.75" (400)	3.00" (76)	14.19" (360)	6.00" (152)	6.00" (152)	4.94" (125)	6.50" (165)

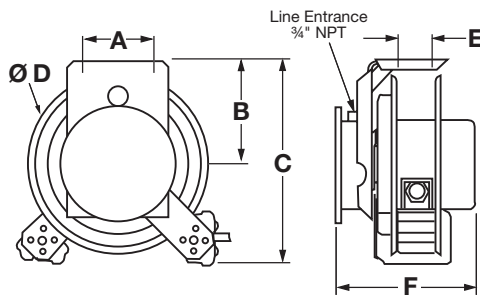

## Pivot Base

### 340° Pivot Base (Optional)

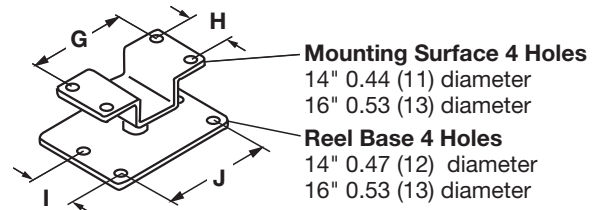

Note: Pivot base for use only with Weatherproof Cable Reel.

Dimensions in Inches (mm)



## Industrial Power Cord Reels

Cord End	Cable Feet (m)	Cable Type	NEMA Style	Amps	Volts AC	Weight Lbs. (kg)	Catalog Number
Without cord ends.	50 (15.2)	16/3 SJEO	—	10	125	20 (9.1)	<b>HBL50163</b>
Without cord ends.	45 (13.7)	12/3 SJEO	—	20	125	21 (9.5)	<b>HBL45123</b>
HBL5269C connector.	45 (13.7)	12/3 SJEO	5-15R	15	125	28 (12.7)	<b>HBL45123C</b>
HBL5369C connector.	45 (13.7)	12/3 SJEO	5-20R	20	125	28 (12.7)	<b>HBL45123C20</b>
HBL5369C connector, (white reel housing).	45 (13.7)	12/3 SJEO	5-20R	20	125	28 (12.7)	<b>HBL45123C20W</b>
HBL2313 connector.	45 (13.7)	12/3 SJEO	L5-20R	20	125	28 (12.7)	<b>HBL45123TL20</b>
HBL2313 connector, (white reel housing).	45 (13.7)	12/3 SJEO	L5-20R	20	125	28 (12.7)	<b>HBL45123TL20W</b>
Portable outlet box with (1) gray duplex receptacle.	45 (13.7)	12/3 SJEO	5-15R	15	125	29 (13.2)	<b>HBL45123R</b>
	45 (13.7)	12/3 SJEO	5-20R	20	125	29 (13.2)	<b>HBL45123R20</b>
Same as above except white.	45 (13.7)	12/3 SJEO	5-20R	20	125	29 (13.2)	<b>HBL45123R20W</b>
Portable outlet box with (2) gray duplex receptacle.	45 (13.7)	12/3 SJEO	5-20R	20	125	29 (13.2)	<b>HBL45123R220</b>
Same as above except white.	45 (13.7)	12/3 SJEO	5-20R	20	125	29 (13.2)	<b>HBL45123R220W</b>
Black portable outlet box with (1) gray duplex receptacle, (white reel housing).	45 (13.7)	12/3 SJEO	5-20R	20	125	29 (13.2)	<b>HBL45123R20WM1</b>
Portable outlet box with (1) ground fault protected gray duplex receptacle.	45 (13.7)	12/3 SJEO	5-15R	15	125	29 (13.2)	<b>HBL45123GF15</b>
	45 (13.7)	12/3 SJEO	5-20R	20	125	29 (13.2)	<b>HBL45123GF20</b>

Note: 15 Amp: Supplied with 5 ft. power supply cord with HBL5266C, 15A straight blade plug. 20 Amp: Supplied with 5 ft. power supply cord with HBL5366C, 20A straight blade plug. Ground fault protected reels supplied with (1) GFM20 and (1) HBLP26FS.



**HBL45123C**



**HBL45123TL20**



**HBL45123R**



**HBL45123R20WM1**



**HBL45123GF15**



**HBL340PB**

## Accessories

Description	Weight Lbs. (kg)	Catalog Number
Pivot base 340° rotation fits all industrial models.	5 (2.3)	<b>HBL340PB</b>
Replacement stop.	.2 (.09)	<b>HBL12BS</b>

## Dimensions

Inch (mm)	A	B	C	D	E	F
	13.00" (330)	12.38" (314)	8.00" (203)	2.50" (64)	9.75" (248)	1.25" (32)

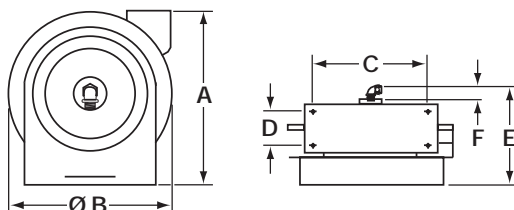

Note: All models have four .625" (15.9) diameter mounting holes.

## Listing/Certification

UL 355  
CSA C22.2 No. 21.

## Environment

Dry, indoor, non-hazardous locations.

## Mounting Positions

Wall mount.  
Ceiling mount.  
Bench mount.

Dimensions in Inches (mm)

# Cable, Cord and Hose Reels Industrial and Commercial Lighted Cord Reels



HBL50162LED



HBL50162FL



HBL50163IN



HBLC25143IN



HBLC40182AFL



HBLC40163FL

## Industrial Lighted Cord Reels, 50 Ft. (15.2m) - 16/3 AWG SJEO Cable



Cord End	Watts (Max)	Amps	Volts AC	Weight Lbs. (kg)	Catalog Number
LED hand lamp, with end light.	8 + 1	0.07	120	21 (9.5)	HBL50162LED
Fluorescent hand lamp.	13	0.3	120	21 (9.5)	HBL50162FL
Incandescent hand lamp.	100	0.8	125	21 (9.5)	HBL50163IN

Note: Supplied with 5 ft. power supply cord with HBL5266C, 15A straight blade plug.

## Accessories

Description	Watts (Max)	Amps	Volts AC	Weight Lbs. (kg)	Catalog Number
Replacement stop.	—	—	—	.2 (.09)	HBL16BS
Replacement LED hand lamp.	8 + 1	0.07	120	1 (.5)	HBL16LEDR*
Replacement fluorescent hand lamp.	13	0.3	120	1 (.5)	HBL16FLR
Replacement incandescent hand lamp.	100	0.8	125	1 (.5)	HBL16INR

Note: \*ETL Listed by INTERTEK.

## Commercial Lighted Cord Reels



Description	Cable Feet (m)	Cable Type	Watts (Max)	Amps	Volts AC	Weight Lbs. (kg)	Catalog Number
Reel with non-metallic incandescent hand lamp and automatic shut off switch, yellow.	25 (7.6)	16/3 SJT	75	0.6	125	9.0 (4.1)	HBLC25163AIN**
Reel with metallic incandescent hand lamp with receptacle, yellow.	25 (7.6)	14/3 SJT	1,625	13	125	9.5 (4.3)	HBLC25143IN
Reel with fluorescent hand lamp and automatic shut off switch, white.	40 (12.2)	18/2 SJTOW	13	0.3	120	8.2 (3.7)	HBLC40182AFL**
Reel with fluorescent hand lamp and inline receptacle, white.	40 (12.2)	16/3 SJT	1,200	10	120	9.0 (4.1)	HBLC40163FL

Note: \*\*Allows the electrical cord reel installation to conform to Article 511 of the National Electric Code concerning installation of electrical devices in commercial garages, repair facilities and storage locations by positioning the switch above the defined area where hazardous fumes may collect.

INTERTEK and the Intertek logo are registered trademarks of Intertek Group plc.

Compact size, flexible mounting options for ceiling, wall or bench

Durable steel construction for commercial and general purpose applications

Automatic ratchet lock holds cord at desired length and provides easy, smooth retraction of cord

Attached plug for power cord requires no wiring



HBLC25163C

Removable bracket allows reel to be dis-engaged from mount providing portability

Durable light weight non-metallic housing

40 Ft. of 12/3 cord for greater current carrying capacity

Triple tap outlet with supplemental over current protection

HBLC40123TT

**Commercial Cord Reels**

Description	Cable Feet (m)	Cable Type	Watts (Max)	Amps	Volts AC	Weight Lbs. (kg)	Catalog Number
Reel with triple tap outlet, black.	40 (12.2)	12/3 SJTW	1,875	15	125	9.0 (4.1)	HBLC40123TT
Reel with wire leads, black.	40 (12.2)	12/3 SJTW	1,875	15	125	9.0 (4.1)	HBLC40123
Reel with triple tap outlet, white.	30 (9.1)	16/3 SJT	1,250	15	125	8.5 (3.9)	HBLC30163TT
Reel with a Hubbell HBL5969VBLK connector, yellow.	25 (7.6)	16/3 SJT	1,250	10	125	8.5 (3.9)	HBLC25163C
Reel with wire leads, yellow.	25 (7.6)	16/3 SJT	1,250	10	125	8.5 (3.9)	HBLC25163*

Note: Reels supplied with 2 ft. power supply cord and molded on straight blade 15A plug.  
\*UL Listed only.



HBLC40123TT

**Specifications**

Listing/Certification	UL 355.
Environment	Dry, indoor, non-hazardous locations.
Incandescent Lamp	75 watt max., auto switch, no receptacle; 100 watt max. bulb, with receptacle.
Fluorescent Lamp	10A/1200W max. with in-line receptacle; 13 watt without receptacle.



HBLC25163C

**Dimensions**

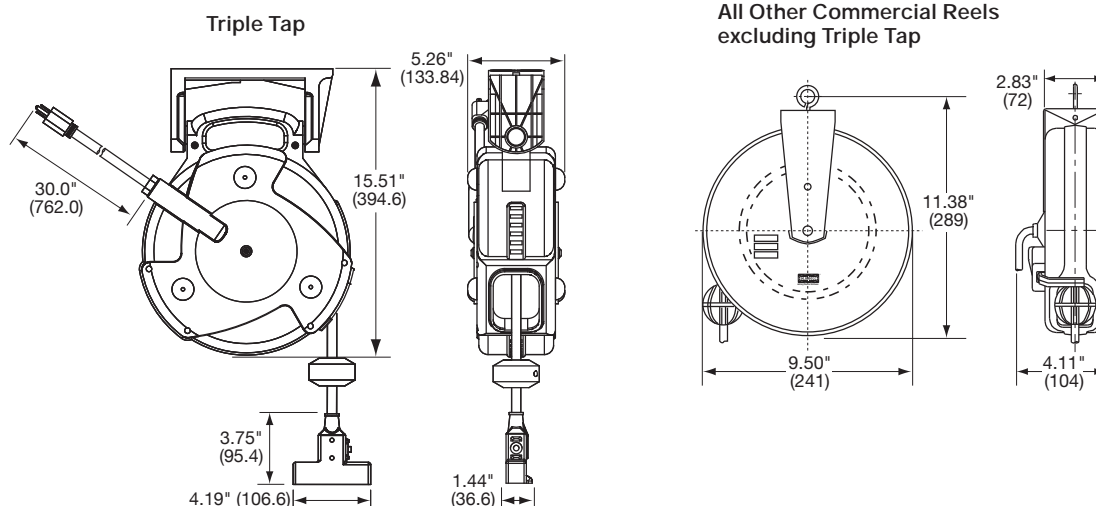

Dimensions in Inches (mm)

# Cable, Cord and Hose Reels

## Air/Water Hose Reels and Static Discharge Reels

Spring rewind and ratchet lock

Multi-position four roller guide and adjustable hose stop

Full flow shafts and swivels assure maximum product delivery

Constructed of rugged steel, baked polyester finish components

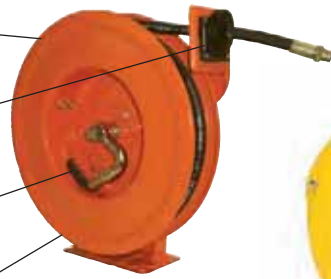

**HBLHR2535**



**HBL50SD**

Steel construction

Compact design minimizes required installation space

Available with steel or nylon coated steel cable

Large grounding jaw clamp provides low resistant ground termination

### Air/Water Hose Reels



**HBLHR2535**

Description	Cable Feet (m)	Max Pressure Psi	Frame Size	Input Hose Fitting (NPTF)	O.D. Inch (mm)	Weight Lbs. (kg)	Catalog Number
Low pressure 1/4" ID.	35 (10.7)	300	A	1/4	0.51 (13.0)	24 (10.9)	<b>HBLHR2535</b>
	50 (15.2)	300	B	1/4	0.51 (13.0)	26 (11.8)	<b>HBLHR2550</b>
Low pressure 3/8" ID.	25 (7.6)	300	A	3/8	0.65 (16.5)	23 (10.4)	<b>HBLHR3825</b>
	50 (15.2)	300	C	3/8	0.65 (16.5)	36 (16.3)	<b>HBLHR3850</b>
	70 (21.3)	300	E	3/8	0.65 (16.5)	50 (22.7)	<b>HBLHR3870</b>
Low pressure 1/2" ID.	35 (10.7)	300	C	3/8	0.77 (19.6)	38 (17.2)	<b>HBLHR5035</b>
	50 (15.2)	300	E	3/8	0.77 (19.6)	44 (20.0)	<b>HBLHR5050</b>

### Static Discharge Reels



**HBL50SD**

Description	Cable Feet (m)	Cable Type	Weight Lbs. (kg)	Catalog Number
Static discharge reel.	50 (15.2)	Single 3/32" Steel	12 (5.4)	<b>HBL50SD</b>
Static discharge reel.	50 (15.2)	Single 3/32" Steel Nylon Coated	13 (5.9)	<b>HBL50SDN</b>
Static discharge reel.	50 (15.2)*	Dual (Y) 3/32" Steel	13 (5.9)	<b>HBL50YSD</b>

Note: \*35 ft. (10.6m) + Dual 15 ft. (4.5m) for "Y".

### Dimensions

Frame size	A	B	C	D	E	F	G	H	J	K	L	M
A	12.88 (327)	11.25 (286)	8.00 (203)	9.88 (250)	12.13 (308)	5.50 (140)	2.50 (64)	2.50 (64)	4.00 (102)	5.09 (132)	8.38 (213)	—
B	14.50 (368)	12.81 (325)	9.75 (248)	11.25 (285)	13.75 (349)	6.19 (157)	3.16 (80)	2.50 (64)	4.00 (102)	5.88 (149)	8.38 (213)	—
C	17.50 (445)	15.63 (286)	9.75 (248)	11.25 (285)	16.50 (419)	6.19 (157)	3.16 (80)	2.50 (64)	4.00 (102)	5.88 (149)	10.25 (260)	—
E	20.38 (518)	18.12 (460)	7.88 (200)	9.45 (240)	19.00 (483)	6.63 (168)	3.35 (85)	3.86 (98)	5.43 (138)	6.10 (155)	11.00 (280)	9.5 (241)

### Air/Water Hose Reels

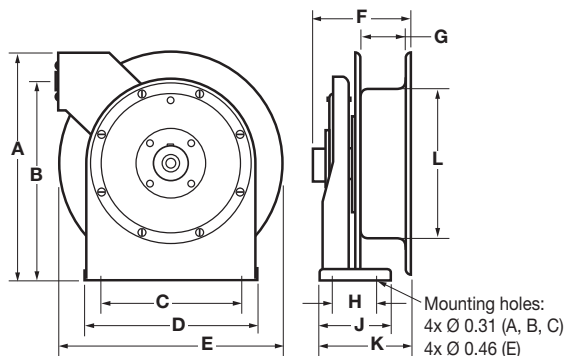

### Static Discharge Reel

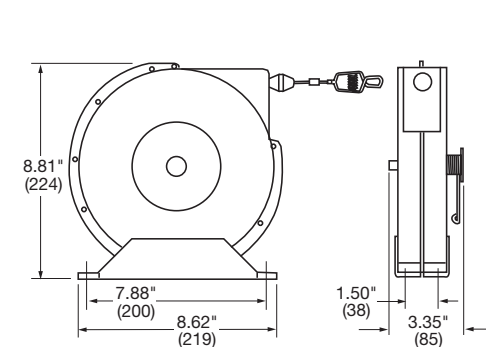

Dimensions in Inches (mm)

# Section K Ground Fault Products

## Index

Product	Page
<b>Extra Heavy Duty Industrial and Hospital Grade GFCI Receptacles</b>	
Tamper-Resistant and Weather Resistant . . . . .	K-2
<b>Heavy Duty Commercial and Hospital Grade GFCI Receptacles</b>	
Tamper-Resistant and Weather Resistant . . . . .	K-3
LED with Auto Grounding. . . . .	K-4
Pre-Wired/Leaded LED . . . . .	K-6
Tamper-Resistant and Weather Resistant Pre-Wired/Leaded LED. . . . .	K-6
<b>Assembled in USA</b>	
LED . . . . .	K-7
Tamper-Resistant and Weather Resistant LED . . . . .	K-7
<b>SNAPConnect® Commercial Grade GFCI Receptacles</b>	
<b>Assembled in USA</b>	
LED with Auto Grounding. . . . .	K-9
Tamper-Resistant and Weather Resistant . . . . .	K-9
<b>GFCI Sensing Module, 50A Maximum Rating - NEMA 4X . . . . .</b>	<b>K-10</b>
<b>Straight Blade Portable GFCI Plugs . . . . .</b>	<b>K-11</b>
<b>Circuit Guard® Plug-In Portable GFCI and GFCI Tester . . . . .</b>	<b>K-12</b>
<b>Portable GFCI Line Cords</b>	
Industrial Grade, Automatic and Manual Set. . . . .	K-14
Commercial Grade, Automatic and Manual Set . . . . .	K-15
Multiple Outlet Portable GFCI and GFCI Module . . . . .	K-16
<b>Hard Wired 30 Ampere GFCI - NEMA 4X . . . . .</b>	<b>K-17</b>
<b>Portable 30 Ampere GFCI - NEMA 4X . . . . .</b>	<b>K-18</b>

### Tamper/Weather Resistant GFCI Receptacles



### Pre-Wired/Leaded and SNAPConnect® GFCI's



### GFCI Sensing Module and Circuit Breaker



### Portable GFCI Products



# Ground Fault Products Extra Heavy Duty Industrial & Hospital Grade GFCI Receptacles Tamper-Resistant and Weather Resistant

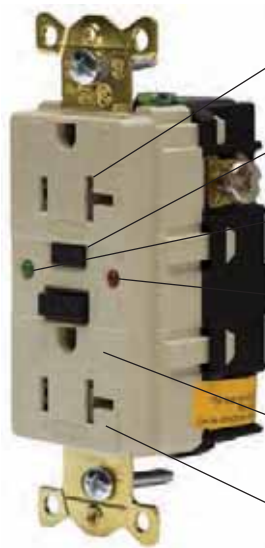

GFR5362SGI



## 10kA Short Circuit Current Rating

- Limits improper access to energized contacts
  - Exclusive patented tamper-resistant protection through switching technology
- Continually tests and monitors for people protection automatically
  - Patented self test diagnostics
- Power indication
  - Steady "ON" GREEN LED provides indication of power
- Ground fault indicator
  - Steady "ON" RED LED provides visual indication of a ground fault condition; flashing red indicates device has lost capability to provide protection
- No power at face if reverse wired
  - Open circuit condition eliminates false assumption of protection at face
- Durable face with V-0 flammability rating
  - Polyester face cover

## AUTOGUARD® Self Test GFCI Receptacles Tamper-Resistant and Weather Resistant





GFR5262SG

Description	Rating	Color	Catalog Number	
 Flush, polyester face, back and side wired, multiple drive screws.	15 and 20A 125V AC	Black	GFR5262SGBK	GFR5362SGBK
		Brown	GFR5262SG	GFR5362SG
		Gray	GFR5262SGGY	GFR5362SGGY
		Ivory	GFR5262SGI	GFR5362SGI
		Red	GFR5262SGR	GFR5362SGR
		White	GFR5262SGW	GFR5362SGW
 Hospital Grade <span style="color: green;">●</span>  Flush, polyester face, back and side wired, multiple drive screws.	15 and 20A 125V AC	Black	GFR8200SGBK	GFR8300SGBK
		Brown	GFR8200SG	GFR8300SG
		Gray	GFR8200SGGY	GFR8300SGGY
		Ivory	GFR8200SGI	GFR8300SGI
		Red	GFR8200SGR	GFR8300SGR
		White	GFR8200SGW	GFR8300SGW

## Circuit Guard® GFCI Receptacles Tamper-Resistant and Weather Resistant



GFR5262GYTR

Description	Rating	Color	Catalog Number	
 Flush, polyester face, back and side wired, multiple drive screws.	15 and 20A 125V AC	Black	GFR5262BKTR	GFR5362BKTR
		Brown	GFR5262TR	GFR5362TR
		Gray	GFR5262GYTR	GFR5362GYTR
		Ivory	GFR5262ITR	GFR5362ITR
		Red	GFR5262RTR	GFR5362RTR
		White	GFR5262WTR	GFR5362WTR
 Hospital Grade <span style="color: green;">●</span>  Flush, polyester face, back and side wired, multiple drive screws.	15 and 20A 125V AC	Black	GFR8200BKTR	GFR8300BKTR
		Brown	GFR8200TR	GFR8300TR
		Gray	GFR8200GYTR	GFR8300GYTR
		Ivory	GFR8200ITR	GFR8300ITR
		Red	GFR8200RTR	GFR8300RTR
		White	GFR8200WTR	GFR8300WTR

Note: GFCI type receptacles should not be used in critical care patient areas or for electrical life support equipment applications because of the possibility of power interruption. All GFCI receptacles listed above are furnished with both a matching color nylon wallplate, and a SS26 302/304 super stainless steel wallplate. 20 amp feed-through capability. See page Tech-10 for Tamper-Resistant and Weather Resistant descriptions.



# Ground Fault Products Heavy Duty Commercial & Hospital Grade GFCI Receptacles Tamper-Resistant and Weather Resistant with Auto Grounding

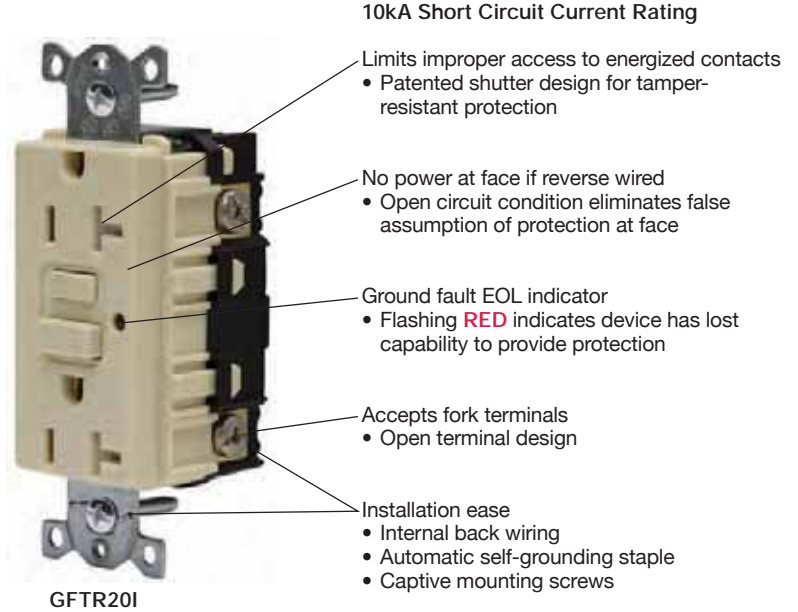

GFTR201



## Circuit Guard® GFCI Receptacles Tamper-Resistant and Weather Resistant

Description	Rating	Color	Catalog Number	
Flush, nylon face, back and side wired, multiple drive screws, self-grounding staple.	15 and 20A 125V AC	Black	GFTR15BK	GFTR20BK
		Brown	GFTR15	GFTR20
	Gray	GFTR15GY	GFTR20GY	
	Ivory	GFTR15I	GFTR20I	
	Light Almond	GFTR15LA	GFTR20LA	
	Red	GFTR15R	GFTR20R	
	White	GFTR15W	GFTR20W	



GFTR15AL

## Circuit Guard® GFCI Receptacles - 3 Pack Tamper-Resistant and Weather Resistant

Description	Rating	Color	Catalog Number	
3 Pack, flush, nylon face, back and side wired, multiple drive screws, self-grounding staple.	15 and 20A 125V AC	Ivory	GFTR15I3	GFTR20I3
		Light Almond	GFTR15LA3	GFTR20LA3
		White	GFTR15W3	GFTR20W3

Note: Consult factory for availability of other colors.



## Circuit Guard® GFCI Receptacles Tamper-Resistant and Weather Resistant

Description	Rating	Color	Catalog Number	
Hospital Grade ● Flush, nylon face, back and side wired, multiple drive screws, self-grounding staple.	15 and 20A 125V AC	Black	GFR8200HBKTR	GFR8300HBKTR
		Brown	GFR8200HTR	GFR8300HTR
	Gray	GFR8200HGYTR	GFR8300HGYTR	
	Ivory	GFR8200HITR	GFR8300HITR	
	Light Almond	GFR8200HLATR	GFR8300HLATR	
	Red	GFR8200HRTR	GFR8300HRTR	
	White	GFR8200HWTR	GFR8300HWTR	



GFR8300HRTR

Note: GFCI type receptacles should not be used in critical care patient areas or for electrical life support equipment applications because of the possibility of power interruption. All GFCI receptacles listed above are furnished with a matching color nylon wallplate. 20 amp feed-through capability.  
See page Tech-10 for Tamper-Resistant and Weather Resistant descriptions.

# Ground Fault Products Heavy Duty Commercial & Hospital Grade GFCI Receptacles LED with Auto Grounding

  
Meets UL Standard 943  
Class A GFCI

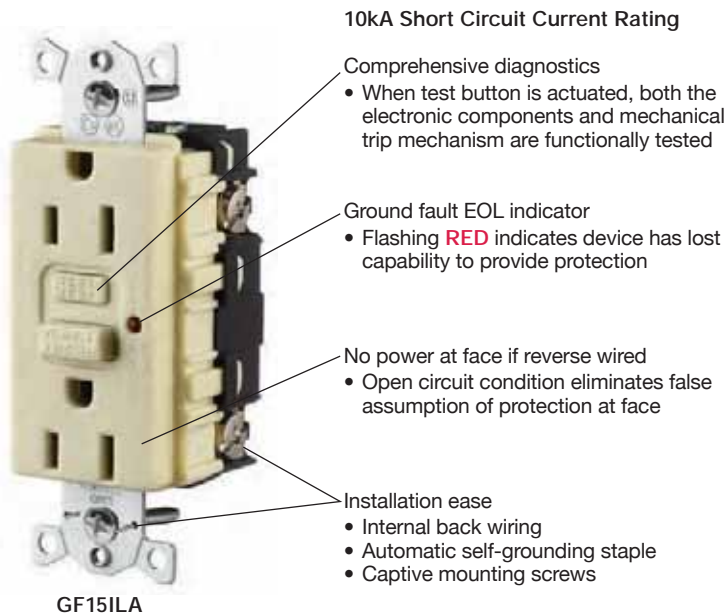

## Circuit Guard® GFCI Receptacles

Description	Rating	Color	Catalog Number	
Flush, nylon face, back and side wired, multiple drive screws, self-grounding staple.	15 and 20A 125V AC	Black	<b>GF15BKLA</b>	<b>GF20BKLA</b>
		Brown	<b>GF15LA</b>	<b>GF20LA</b>
		Gray	<b>GF15GYLA</b>	<b>GF20GYLA</b>
		Ivory	<b>GF15ILA</b>	<b>GF20ILA</b>
		Light Almond	<b>GF15LALA</b>	<b>GF20LALA</b>
		Red	<b>GF15RLA</b>	<b>GF20RLA</b>
		White	<b>GF15WLA</b>	<b>GF20WLA</b>



**GF15ALLA**

## Circuit Guard® GFCI Receptacles - 3 Pack

Description	Rating	Color	Catalog Number	
3 Pack, flush, nylon face, back and side wired, multiple drive screws, self-grounding staple.	15 and 20A 125V AC	Ivory	<b>GF15ILA3</b>	<b>GF20ILA3</b>
		Light Almond	<b>GF15LALA3</b>	<b>GF20LALA3</b>
		White	<b>GF15WLA3</b>	<b>GF20WLA3</b>

*Note: Consult factory for availability of other colors.*



## Hospital Grade ● Circuit Guard® GFCI Receptacles

Description	Rating	Color	Catalog Number	
Flush, nylon face, back and side wired, multiple drive screws, self-grounding staple.	15 and 20A 125V AC	Black	<b>GFR8200HBKLA</b>	<b>GFR8300HBKLA</b>
		Brown	<b>GFR8200HLA</b>	<b>GFR8300HLA</b>
		Gray	<b>GFR8200HGYLA</b>	<b>GFR8300HGYLA</b>
		Ivory	<b>GFR8200HILA</b>	<b>GFR8300HILA</b>
		Light Almond	<b>GFR8200HLAA</b>	<b>GFR8300HLAA</b>
		Red	<b>GFR8200HRLA</b>	<b>GFR8300HRLA</b>
		White	<b>GFR8200HWLA</b>	<b>GFR8300HWLA</b>

*Note: GFCI type receptacles should not be used in critical care patient areas or for electrical life support equipment applications because of the possibility of power interruption. All GFCI receptacles listed above are furnished with a matching color nylon wallplate. 20 amp feed-through capability.*



**GFR8200HRLA**

# Ground Fault Products Heavy Duty Commercial GFCI Receptacles LED with Auto Grounding

  
Meets UL Standard 943  
Class A GFCI

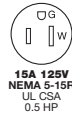

## Circuit Guard® Bulk Pack GFCI Receptacles

Description	Rating	Color	Catalog Number	
Flush, nylon face, back and side wired, multiple drive screws, self-grounding staple. Bulk packed, (50 pieces without wallplate).	15 and 20A 125V AC	Black	GF15BKLABULK	GF20BKLABULK
		Brown	GF15LABULK	GF20LABULK
		Gray	GF15GYLABULK	GF20GYLABULK
		Ivory	GF15ILABULK	GF20ILABULK
		Light Almond	GF15LALABULK	GF20LALABULK
		Red	GF15RLABULK	GF20RLABULK
		White	GF15WLABULK	GF20WLABULK



GF15BKLABULK



GF20GYLABULK



GF15LABULK

## Circuit Guard® Faceless GFCI

Description	Rating	Color	Catalog Number	
Faceless, nylon top, back and side wired, multiple drive screws, self-grounding staple.	20A 125V AC	Black	-	GFBF20BKLA
		Brown	-	GFBF20LA
		Gray	-	GFBF20GYLA
		Ivory	-	GFBF20ILA
		Light Almond	-	GFBF20LALA
		Red	-	GFBF20RLA
		White	-	GFBF20WLA

Note: GFCI type receptacles should not be used in critical care patient areas or for electrical life support equipment applications because of the possibility of power interruption. All GFCI receptacles listed above are furnished with a matching color nylon wallplate.

## Combination Switch/GFCI

Description	Rating	Color	Catalog Number	
Single-pole switch, GFCI grounding receptacle, back and side wired, matching nylon wallplate included.	15A 120V (Switch) 15A 125V (Receptacle)	Ivory	GFSP15IC	-
		Light Almond	GFSP15LAC	-
		White	GFSP15WC	-



GFSP15WC

## GFCI Receptacle Specifications per GFCI Products Listed (Pages K-2 to K-9)

Trip Level	4 to 6 mA.
Trip Time	.025 second nominal.
Frequency	60 Hz.
Voltage	120V AC +10% - 15% (102V to 132V).
Amperage	15A/20A, 20A Feed Thru.
Maximum Interrupting Capacity	10,000A.
Operating Temperature	-35°C to 66°C or -30°F to 150°F.
Maximum Humidity	95%.
Listings and Standards	Meets UL498 for receptacles, UL943 Class A for GFCIs UL File E41978. CSA Certified.
Codes	Meets all NEC® and CEC requirements. NEMA WD-6 ANSI 73.

NEC® is a registered trademark of the National Fire Protection Association (NFPA).

**Applications**



GF15GYLAP1

**GFCI LED Pre-Wired/Leaded,  
 #12 Solid Wire, 8 Inch Leads**

Description	Rating	Color*	Catalog Number	
Impact resistant flush nylon face, LED, self-grounding staple, 8" solid wire leads.	15 and 20A 125V AC	Gray	<b>GF15GYLAP1</b>	 <b>15A 125V</b> NEMA 5-15R UL CSA 0.5 HP
		Ivory	<b>GF15ILAP1</b>	
		White	<b>GF15WLP1</b>	
				 <b>20A 125V</b> NEMA 5-20R UL CSA 1 HP
			<b>GF20GYLAP1</b>	
			<b>GF20ILAP1</b>	
			<b>GF20WLP1</b>	

Note: \*Consult factory for additional colors.



GF20ILAP2

**GFCI LED Pre-Wired/Leaded,  
 #12 Stranded Wire, 8 Inch Leads**

Description	Rating	Color*	Catalog Number	
Impact resistant flush nylon face, LED, self-grounding staple, 8" stranded wire leads.	15 and 20A 125V AC	Gray	<b>GF15GYLAP2</b>	 <b>15A 125V</b> NEMA 5-15R UL CSA 0.5 HP
		Ivory	<b>GF15ILAP2</b>	
		White	<b>GF15WLP2</b>	
				 <b>20A 125V</b> NEMA 5-20R UL CSA 1 HP
			<b>GF20GYLAP2</b>	
			<b>GF20ILAP2</b>	
			<b>GF20WLP2</b>	



Note: \*Consult factory for additional colors.



GFTR15WP1

**GFCI LED Tamper and Weather Resistant  
 Pre-Wired/Leaded, #12 Solid Wire, 8 Inch Leads**



Description	Rating	Color*	Catalog Number	
Tamper and Weather Resistant, impact resistant flush nylon face, LED, self-grounding staple, 8" solid wire leads.	15 and 20A 125V AC	Gray	<b>GFTR15GYP1</b>	 <b>15A 125V</b> NEMA 5-15R UL CSA 0.5 HP
		Ivory	<b>GFTR15IP1</b>	
		White	<b>GFTR15WP1</b>	
				 <b>20A 125V</b> NEMA 5-20R UL CSA 1 HP
			<b>GFTR20GYP1</b>	
			<b>GFTR20IP1</b>	
			<b>GFTR20WP1</b>	



Note: \*Consult factory for additional colors.  
 See page Tech-10 for Tamper-Resistant and Weather Resistant descriptions.



GFTR20GYP2

**GFCI LED Tamper and Weather Resistant  
 Pre-Wired/Leaded, #12 Stranded Wire, 8 Inch Leads**



Description	Rating	Color*	Catalog Number	
Tamper and Weather Resistant, impact resistant flush nylon face, LED, self-grounding staple, 8" stranded wire leads.	15 and 20A 125V AC	Gray	<b>GFTR15GYP2</b>	 <b>15A 125V</b> NEMA 5-15R UL CSA 0.5 HP
		Ivory	<b>GFTR15IP2</b>	
		White	<b>GFTR15WP2</b>	
				 <b>20A 125V</b> NEMA 5-20R UL CSA 1 HP
			<b>GFTR20GYP2</b>	
			<b>GFTR20IP2</b>	
			<b>GFTR20WP2</b>	

Note: \*Consult factory for additional colors.  
 See page Tech-10 for Tamper-Resistant and Weather Resistant descriptions.

# Ground Fault Products Heavy Duty Commercial & Hospital Grade LED GFCI Receptacles Assembled in USA



## Applications



### GFCI LED, Assembled in USA

Description	Rating	Color	Catalog Number	
Impact resistant flush nylon face, back and side wired, LED, self-grounding staple. Assembled in the USA.	15 and 20A 125V AC	Black	<b>GF15BKLU</b>	<b>GF20BKLU</b>
		Brown	<b>GF15LU</b>	<b>GF20LU</b>
		Gray	<b>GF15GYLU</b>	<b>GF20GYLU</b>
		Ivory	<b>GF15ILU</b>	<b>GF20ILU</b>
		Light Almond	<b>GF15LALU</b>	<b>GF20LALU</b>
		Red	<b>GF15RLU</b>	<b>GF20RLU</b>
		White	<b>GF15WLU</b>	<b>GF20WLU</b>

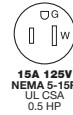

GF15GYLU

### GFCI LED Hospital Grade, Assembled in USA

Description	Rating	Color	Catalog Number	
Hospital Grade ●, impact resistant flush nylon face, back and side wired, LED, self-grounding staple. Assembled in the USA.	15 and 20A 125V AC	Black	<b>GFR8200HBKLU</b>	<b>GFR8300HBKLU</b>
		Brown	<b>GFR8200HLU</b>	<b>GFR8300HLU</b>
		Gray	<b>GFR8200HGYLU</b>	<b>GFR8300HGYLU</b>
		Ivory	<b>GFR8200HILU</b>	<b>GFR8300HILU</b>
		Light Almond	<b>GFR8200HLALU</b>	<b>GFR8300HLALU</b>
		Red	<b>GFR8200HRLU</b>	<b>GFR8300HRLU</b>
		White	<b>GFR8200HWLU</b>	<b>GFR8300HWLU</b>



GFR8300HWLU

### GFCI LED Tamper and Weather Resistant, Assembled in USA

Description	Rating	Color	Catalog Number	
Tamper and Weather Resistant, impact resistant flush nylon face, back and side wired, LED, self-grounding staple. Assembled in the USA.	15 and 20A 125V AC	Black	<b>GFTR15BKU</b>	<b>GFTR20BKU</b>
		Brown	<b>GFTR15U</b>	<b>GFTR20U</b>
		Gray	<b>GFTR15GYU</b>	<b>GFTR20GYU</b>
		Ivory	<b>GFTR15IU</b>	<b>GFTR20IU</b>
		Light Almond	<b>GFTR15LAU</b>	<b>GFTR20LAU</b>
		Red	<b>GFTR15RU</b>	<b>GFTR20RU</b>
		White	<b>GFTR15WU</b>	<b>GFTR20WU</b>



GFTR20IU

### GFCI LED Hospital Grade Tamper and Weather Resistant, Assembled in USA

Description	Rating	Color	Catalog Number	
Hospital Grade ●, Tamper and Weather Resistant, impact resistant flush nylon face, back and side wired, LED, self-grounding staple. Assembled in the USA.	15 and 20A 125V AC	Black	<b>GFR8200HBKTRU</b>	<b>GFR8300HBKTRU</b>
		Brown	<b>GFR8200HTRU</b>	<b>GFR8300HTRU</b>
		Gray	<b>GFR8200HGYTRU</b>	<b>GFR8300HGYTRU</b>
		Ivory	<b>GFR8200HITRU</b>	<b>GFR8300HITRU</b>
		Light Almond	<b>GFR8200HLATRU</b>	<b>GFR8300HLATRU</b>
		Red	<b>GFR8200HRTRU</b>	<b>GFR8300HRTRU</b>
		White	<b>GFR8200HWTRU</b>	<b>GFR8300HWTRU</b>



GFR8300HLATRU

Note: Many of the products listed on this page are assembled in USA and many are Buy American Compliant. Please contact Hubbell for specific certification requirements.  
See page Tech-10 for Tamper-Resistant and Weather Resistant descriptions.

**The products listed on this page are Assembled in USA, and many are Buy American Compliant. Please contact Hubbell with any certification requirements.**

Ground Fault Products  
**SNAPConnect® Commercial Grade GFCI Receptacles**  
**Assembled in USA**



**No Special Tester Required**  
 .085 inch keyhole accepts the probe points found on the most common voltage testers and digital multi-meters

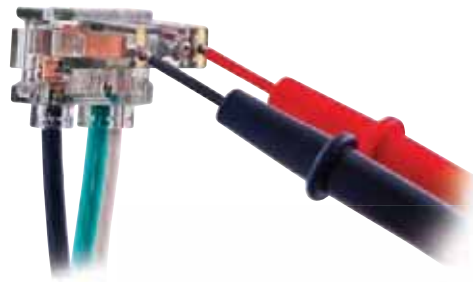

Audible SNAP, indicates solid connection  
 • Secure, easy grip latch

Inspection of power contacts  
 • Clear terminal housing  
 • No exposed metal

Requires minimal box space  
 • Compact size  
 • Clean finished look

Installation ease  
 • Self-grounding staple



SNAP1RNA

GFR20SNAPINA

*Many of these products are Assembled in USA, as indicated, and many are Buy American Compliant. Please contact Hubbell with any certification requirements.*

**Labor Savings Feature!**



**Save one Minute!**  
 Rough-in the SNAPConnect® terminal instead of pigtails.



**Save Over Three Minutes!**  
 Remove protective packaging and SNAPConnect® device to the circuit.



**Complete Trim-Out in Less Than One Minute!**  
 Secure mounting screws, attach wallplate, job complete.

# Ground Fault Products SNAPConnect® Commercial Grade GFCI Receptacles Assembled in USA

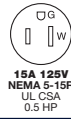

## SNAPConnect® GFCI LED, Assembled in USA

Description	Rating	Color	Commercial Grade 15A GFCI	Commercial Grade 20A GFCI
SNAPConnect GFCI LED, self-grounding staple, requires connector below, sold separately.	15 and 20A 125V AC	Black	GFR15SNAPBKNA	GFR20SNAPBKNA
		Brown	GFR15SNAPNA	GFR20SNAPNA
		Gray	GFR15SNAPGYNA	GFR20SNAPGYNA
		Ivory	GFR15SNAPINA	GFR20SNAPINA
		Light Almond	GFR15SNAPLANA	GFR20SNAPLANA
		Red	GFR15SNAPRNA	GFR20SNAPRNA
		White	GFR15SNAPWNA	GFR20SNAPWNA



GFR15SNAPGYNA

## SNAPConnect® GFCI LED Hospital Grade, Assembled in USA

Description	Rating	Color	Hospital Grade ● 15A GFCI	Hospital Grade ● 20A GFCI
Hospital Grade ●, SNAPConnect GFCI LED, self-grounding staple, requires connector below, sold separately.	15 and 20A 125V AC	Black	GFR8200SNAPBKNA	GFR8300SNAPBKNA
		Brown	GFR8200SNAPNA	GFR8300SNAPNA
		Gray	GFR8200SNAPGYNA	GFR8300SNAPGYNA
		Ivory	GFR8200SNAPINA	GFR8300SNAPINA
		Light Almond	GFR8200SNAPLANA	GFR8300SNAPLANA
		Red	GFR8200SNAPRNA	GFR8300SNAPRNA
		White	GFR8200SNAPWNA	GFR8300SNAPWNA



GFR8300SNAPRNA

## SNAPConnect® GFCI LED Tamper and Weather Resistant, Assembled in USA

Description	Rating	Color	Commercial Grade 15A GFCI	Commercial Grade 20A GFCI
SNAPConnect GFCI TR/WR, self-grounding staple, requires connector below, sold separately.	15 and 20A 125V AC	Black	GFTR15SNAPBKNA	GFTR20SNAPBKNA
		Brown	GFTR15SNAPNA	GFTR20SNAPNA
		Gray	GFTR15SNAPGYNA	GFTR20SNAPGYNA
		Ivory	GFTR15SNAPINA	GFTR20SNAPINA
		Light Almond	GFTR15SNAPLANA	GFTR20SNAPLANA
		Red	GFTR15SNAPRNA	GFTR20SNAPRNA
		White	GFTR15SNAPWNA	GFTR20SNAPWNA



GFTR20SNAPINA

## SNAPConnect® GFCI LED Hospital Grade Tamper and Weather Resistant, Assembled in USA

Description	Rating	Color	Hospital Grade ● 15A GFCI	Hospital Grade ● 20A GFCI
Hospital Grade ●, SNAPConnect GFCI TR/WR, self-grounding staple, requires connector below, sold separately.	15 and 20A 125V AC	Black	GFTR8200SNAPBKNA	GFTR8300SNAPBKNA
		Brown	GFTR8200SNAPNA	GFTR8300SNAPNA
		Gray	GFTR8200SNAPGYNA	GFTR8300SNAPGYNA
		Ivory	GFTR8200SNAPINA	GFTR8300SNAPINA
		Light Almond	GFTR8200SNAPLANA	GFTR8300SNAPLANA
		Red	GFTR8200SNAPRNA	GFTR8300SNAPRNA
		White	GFTR8200SNAPWNA	GFTR8300SNAPWNA



GFTR8300SNAPWNA

## SNAPConnect® Right Angle Pigtailed Terminal

Description	Wire Type	General Use Catalog Number	Assembled in USA Catalog Number
Clear right angle terminal with 6 inch leads, 600V, #12 AWG THHN/THWN-2, Polycarbonate housing material.	Solid	SNAP1RA	SNAP1RNA
	Stranded	SNAP2RA	SNAP2RNA

Note: See page Tech-10 for Tamper-Resistant and Weather Resistant descriptions.



SNAP1RNA

**Many of these products are Assembled in USA, as indicated, and many are Buy American Compliant. Please contact Hubbell with any certification requirements.**



### Typical Applications Include:

Power Generators, Spas, High Pressure Washers, Power Centers, Refineries and Mobile Power.



The sensing module functions interdependently with a magnetic branch circuit breaker. The module monitors the electrical circuit by use of an external differential current transformer. No direct load is present at the module. In the event of a ground fault, the load is interrupted by way of the hydraulic magnetic circuit breaker utilizing a shunt trip coil.

This line of Sensing Modules is rated from 1 to 50 Amps and circuit current-carrying conductors from 1 to 3 poles.

Product is available with an automatic or manual "safe start" reset feature. The enclosure, when mounted with the supplied gasket, achieves a UL NEMA 4X Rating. This module and breaker system is ideal for portable generator integration protecting all outlets on a generator. This system meets the proposed requirements for generators Underwriters Laboratory Standard 2201. UL/cUL 943 Listed, Class A 4-6mA trip level and UL 1053 Compliant.

### GFCI Sensing Module – 50A Maximum

Description	Catalog Number
120V AC Sensing Module Auto	GFSM120A
120V AC Sensing Module Manual	GFSM120M
240V AC Sensing Module Auto	GFSM240A
240V AC Sensing Module Manual	GFSM240M



GFSM120M



GFSMCB120401P

### GFCI Sensing Module Circuit Breakers

Catalog Number Configurator

Ground Fault Sensing Module Circuit Breaker	A/C Voltage	Amperage	Number of Poles	Sensing Module Required
GFSMCB	120	1 to 50	1	GFSM120A or M
	120		2	GFSM120A or M
	240		2	GFSM240A or M
	120/240		2	GFSM120A or M
	120/240		3	GFSM120A or M

Example Catalog Numbers: GFSMCB120401P: 120V, 40A, 1 Pole  
 GFSMCB240502P: 240V, 50A, 2 Pole  
 GFSMCB120240203P: 120/240V, 20A, 3 Pole

### Wiring Schematics

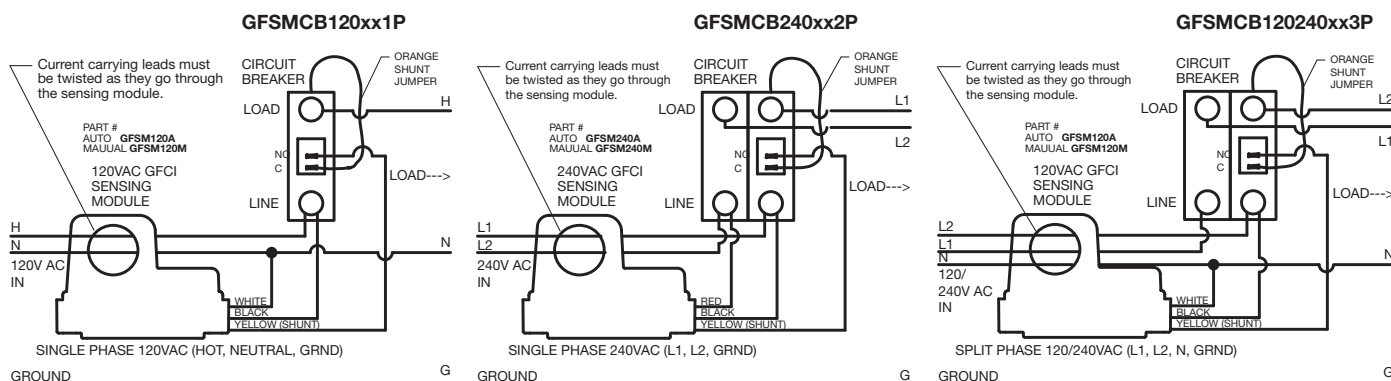



# Ground Fault Products

## Straight Blade Portable GFCI Plugs

15 Ampere, 120 Volts AC, 2 Pole, 3 Wire Grounding



### Circuit Guard® Wired On Industrial Portable GFCI Plug

Description	Rating	Catalog Number
GFCI plug, manual set, black.	2 pole, 3 wire grounding, 15A, 125V, NEMA 5-15P.	GFP5266C
GFCI plug, manual set, yellow.	2 pole, 3 wire grounding, 15A, 125V, NEMA 5-15P.	GFP5266CY
GFCI plug with 1 foot line cord, manual set, yellow, with connector body.	2 pole, 3 wire grounding, 15A, 125V, NEMA 5-15P, NEMA 5-15R.	GFP1C



GFP5266CY

### Circuit Guard® Wired On Commercial Portable GFCI Plug

Description	Rating	Catalog Number
GFCI plug, automatic set field wireable, black.	2 pole, 3 wire grounding, 15A, 125V, NEMA 5-15P.	GFP515A
GFCI plug, manual set field wireable, black.	2 pole, 3 wire grounding, 15A, 125V, NEMA 5-15P.	GFP515M



GFP515A

### Specifications

Trip Level	4 to 6 mA.
Trip Time	.025 sec. nominal.
Frequency	60 Hz.
Voltage	120V AC +10% – 15%. Incorporates no voltage release feature.
Amperage	15A.
Maximum Interrupting Capacity	2000A.
Operating Temperature	-35°C to 66°C or -30°F to 150°F.
Maximum Humidity	95%.
Housing	High-impact, UV stabilized material. UL 94V-0 flammability classification.
Input	NEMA 5-15P.
Cord Range	16/3 – 12/3 Type SJ, 18/3 – 12/3 Type S.
Cord Type: Length (GFP1C)	14/3 Type SJTW-A (UL), SJTW (CSA); 1 foot; NEMA 5-15R.
Power "ON" Indication	Indicator light.
Listings	Meets UL943 Class A Listed, CSA Certified.
Codes	Meets all NEC® and CEC requirements.

### Dimensions

GFP5266C Series

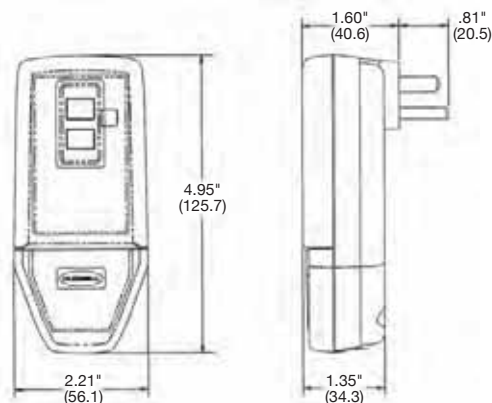

GFP515 Series

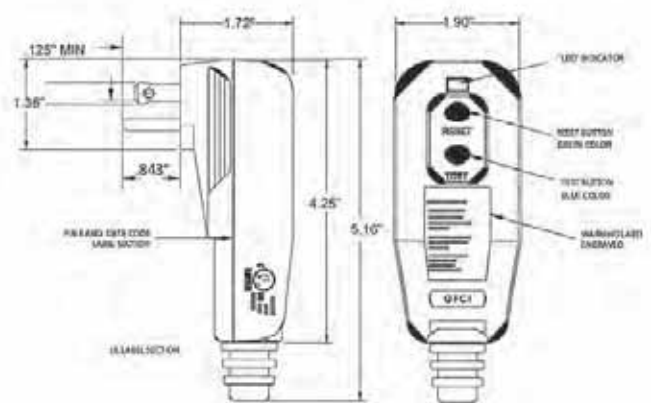

NEC® is a registered trademark of the National Fire Protection Association (NFPA).

Dimensions in Inches (mm)

# Ground Fault Products

## Circuit Guard® Plug-In Portable GFCI and GFCI Tester

15 Ampere, 120 Volts AC, 2 Pole, 3 Wire Grounding



### Circuit Guard® Plug-In Portable GFCI

Description	Rating	Catalog Number
Three outlet plug-in.	15A, 120V AC	GFP315A



GFP315A

### Specifications

GFP315A	
Trip Level	4 to 6 mA.
Trip Time	.025 sec. nominal.
Frequency	60 Hz.
Voltage	120V AC +10% – 15%. Incorporates no voltage release feature.
Amperage	15A.
Maximum Interrupting Capacity	2000A.
Operating Temperature	-35°C to 66°C or -30°F to 150°F.
Maximum Humidity	95%.
Housing	High-impact ABS.
Input	NEMA 5-15P.
Output	3 NEMA 5-15R.
Fault Indication	Indicator light.
Center Screw	For optional permanent mounting.
Listings and Standards	Meets UL498 for receptacles, UL943 Class A for GFCIs UL File E41978, CSA Certified.
Codes	Meets all NEC® and CEC requirements.

### GFCI Tester

Description	Rating	Catalog Number
Ground fault tester.	120V AC	GFT2G



GFT2G

- Designed to measure the trip level of portable or “wired-in” GFCI’s in a range of 2-7mA. Leakage level can be adjusted from 2-7mA.
- Ideal for measuring leakage level of GFCI breakers, GFCI portables and GFCI receptacles.

### Dimensions

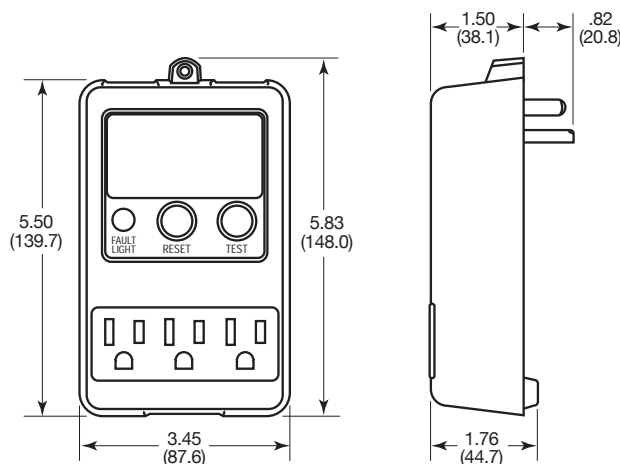

Dimensions in Inches (mm)

NEC® is a registered trademark of the National Fire Protection Association (NFPA).

# Ground Fault Products

## Portable GFCI Line Cords

*Features and Benefits*

### Circuit Guard® Set GFCI Line Cord

Portable GFCI Line Cords provide ground fault protection both indoors and out. They interrupt electrical power for equipment loads when leakage to ground is 4-6 milliamperes. Available in lengths of 18" (45.7 cm), 6' (182.9 cm), and 25' (762 cm). A 15' (457.2 cm) OEM version with stripped leads is also available. They are offered with an Automatic Set or Manual Set feature to meet your application.

Available in Automatic Set with yellow base or Manual Set with black base.

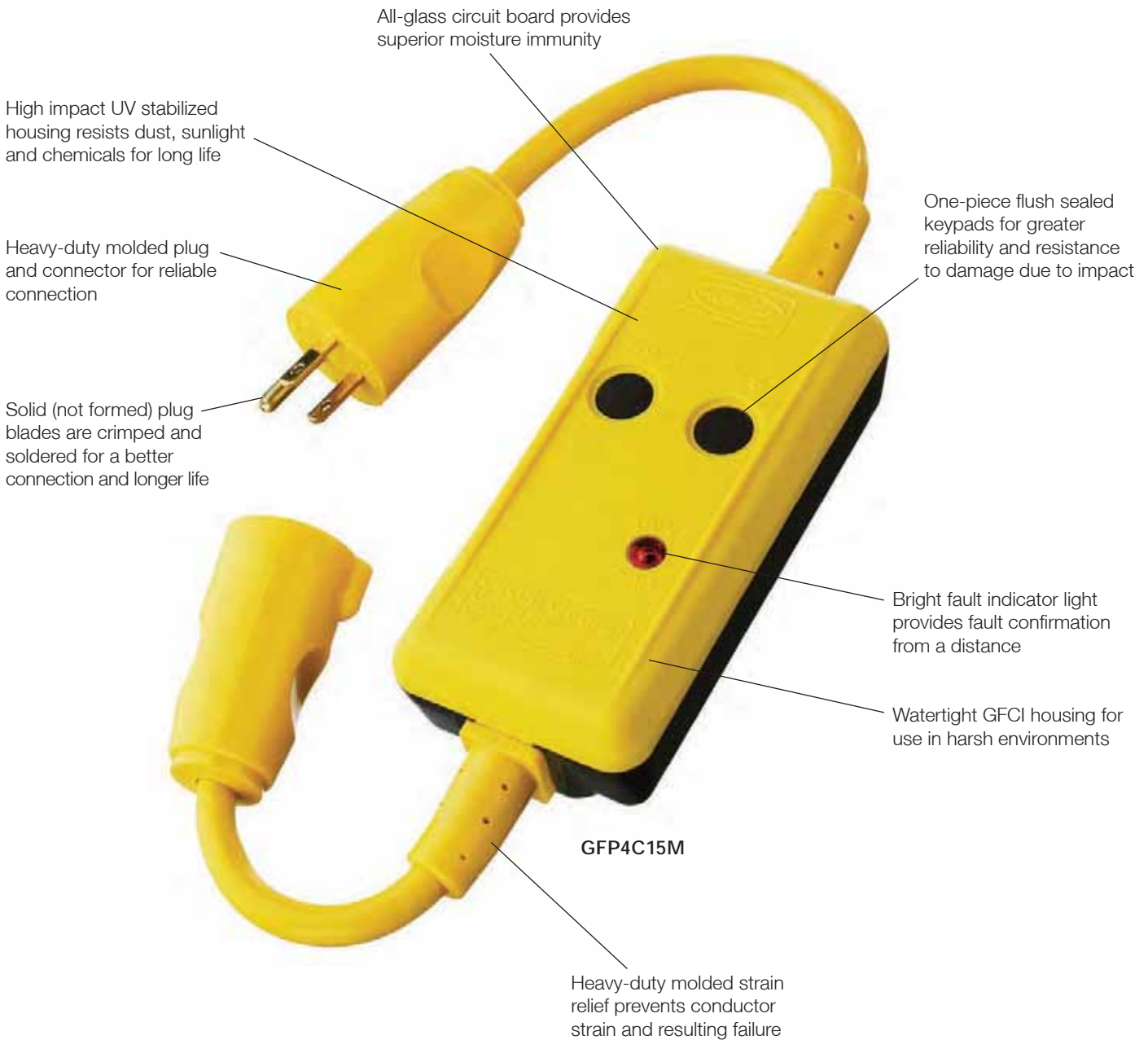



**IP21**  
 SUITABILITY



GFP4C15A

**Circuit Guard® Automatic Set  
 Portable GFCI Line Cords**

**15A 120V AC**

Description	Catalog Number
18" (45.7 cm) GFCI line cord.	GFP4C15A
6' (182.9 cm) GFCI line cord.	GFP6C15A
25' (762.0 cm) GFCI line cord.	GFP25C15A
15' (457.2 cm) GFCI power supply cord with stripped leads.	GFPOEMA*



GFP25C15A

**Circuit Guard® Manual Set  
 Portable GFCI Line Cords**

**15A 120V AC      20A 120V AC**

Description	Catalog Number	
18" (45.7 cm) GFCI line cord.	GFP4C15M	-
3' (91.4 cm) GFCI line cord.	-	GFP3C20M
6' (182.9 cm) GFCI line cord.	GFP6C15M	-
25' (762.0 cm) GFCI line cord.	GFP25C15M	-
15' (457.2 cm) GFCI power supply cord with stripped leads.	GFPOEMM*	-
50' (1524.0 cm) GFCI power supply with Elastogrip® watertight straight blade.	GFP50C15WM	
100' (3048.0 cm) GFCI power supply with Elastogrip® watertight straight blade.	GFP100C15WM	

*Note: \*Total length is 15' 4.5" (468.6 cm) including leads: green 4.5" (114.3), black and white 3.5" (88.9). Each pre-stripped .375" (9.5).*



GFP6C15M

**Circuit Guard® Manual Set  
 Twist-Lock Portable GFCI Line Cords**

**15A 120V AC      20A 120V AC**

Description	Catalog Number	
3' (91.4 cm) GFCI line cord.	GFP3C15MTL	GFP3C20MTL



GFPOEMM

**Automatic Set GFCI**

Automatically energizes or sets the GFCI for use upon plug in and after the loss of primary power (power failure or unplugging the device). After a ground fault condition, unit must be reset by pushing the reset button. This feature eliminates the need for unit to be reset each time it is plugged in or powered up. Ideal for equipment intended for continuous use where a temporary power failure is likely and undesirable. Examples are pumps, pressure washers, portable signs or lighting and engine heaters.

**Manual Set GFCI**

Requires the GFCI to be manually set for use by pressing the reset button upon plug in and after loss of primary power (power failure or unplugging the device). Must be manually reset after a ground fault condition. Ideal for applications where operator injury might occur if equipment were to restart after a power failure. Typical equipment includes power drills, saws, lathes and grinders.

	Straight Blade	Twist-Lock®
Input	15A NEMA 5-15P, 20A NEMA 5-20P.	15A NEMA L5-15P HBL47CM20C, 20A NEMA L5-20P HBL23CM11.
Output	15A NEMA 5-15R (except GFPOEMM), 20A NEMA 5-20R.	15A NEMA L5-15R HBL47CM29C, 20A NEMA L5-20R HBL23CM13.

**Specifications**

**Portable GFCI Line Cords**

Trip Level	4 to 6 mA.
Trip Time	.025 sec. nominal.
Frequency	60 Hz.
Voltage	120V AC +10% – 15%. Incorporates no voltage release feature.
Amperage	15A/20A.
Maximum Interrupting Capacity	2000A.
Operating Temperature	-35°C to 66°C or -30°F to 150°F.
Maximum Humidity	95%.
Housing	High-impact, UV stabilized PVC. UL 94V-0 flammability classification. Meets UL and CSA watertight requirements. Adhesive bonded.
Cord Type	14/3 SJTW-A (UL), SJTW (CSA). Except GFP3C20M, GFP3C15MTL and GFP3C20MTL are 12/3 SJTW.
Visual Fault Indication Light On	Indicates fault.
Listing and Standards	Meets UL943 Class A, UL File E41978, CSA Certified.
Codes	Meets all NEC® and CEC requirements.

*NEC® is a registered trademark of the National Fire Protection Association (NFPA).*



GFP3C20MTL

**Ground Fault Products**  
**Portable GFCI Line Cords**  
 Commercial Grade, Automatic and Manual Set



<b>Circuit Guard® Portable GFCI Single Outlet - 12/3 SJEOW</b>	<b>15A 120V AC</b>
Description	Catalog Number
2' (60.9 cm) GFCI line cord, automatic set.	GFP2CA
2' (60.9 cm) GFCI line cord, manual set.	GFP2CM
25' (762.0 cm) GFCI line cord, automatic set.	GFP25CA
25' (762.0 cm) GFCI line cord, manual set.	GFP25CM



GFP2CA

<b>Circuit Guard® Portable GFCI Triple Tap Outlet - 12/3 SJEOW</b>	<b>15A 120V AC</b>
Description	Catalog Number
2' (60.9 cm) GFCI line cord, automatic set.	GFP2TTA
2' (60.9 cm) GFCI line cord, manual set.	GFP2TTM
25' (762.0 cm) GFCI line cord, automatic set.	GFP25TTA
25' (762.0 cm) GFCI line cord, manual set.	GFP25TTM



GFP2TTA

<b>Circuit Guard® OEM Equipment Integrated Cord Sets - 14/3 SJEOW</b>	<b>15A 120V AC</b>
Description	Catalog Number
15' (457.2 cm) GFCI with flying leads, automatic set.	GFP15LA
15' (457.2 cm) GFCI with flying leads, manual set.	GFP15LM
35' (1066.8 cm) GFCI with flying leads, automatic set.	GFP35LA
35' (1066.8 cm) GFCI with flying leads, manual set.	GFP35LM



GFP15LA

<b>15A GFCI In Line GFCI, Single and Triple Tap - 12/3 SJTW</b>	<b>15A 120V AC</b>
Description	Catalog Number
2' (60.9 cm), 5-15 single tap, automatic set.	GFPI15125A
2' (60.9 cm), 5-15 single tap, manual set.	GFPI15125M
2' (60.9 cm), 5-15 triple tap, automatic set.	GFPI15125TRIA
2' (60.9 cm), 5-15 triple tap, manual set.	GFPI15125TRIM



GFPI15125TRIM

<b>20A GFCI In Line GFCI, Locking - 12/3 SJTW</b>	<b>20A 120V AC</b>
Description	Catalog Number
2' (60.9 cm), L5-20 locking, automatic set.	GFPI120125LKA
2' (60.9 cm), L5-20 locking, manual set.	GFPI120125LKM

<b>20A GFCI In Line GFCI, Locking - 12/3 SJTW</b>	<b>20A 250V AC</b>
Description	Catalog Number
2' (60.9 cm), L6-20 locking, automatic set.	GFPI120250LKA
2' (60.9 cm), L6-20 locking, manual set.	GFPI120250LKM



GFPI120125LKA



GFPI120250LKM

**Specifications**

**Portable GFCI Line Cords**

Trip Level	4 to 6 mA.
Trip Time	.025 sec. nominal.
Frequency	60 Hz.
Voltage	120/250V AC +10% - 15%. Incorporates no voltage release feature.
Amperage	15A/20A.
Maximum Interrupting Capacity	2000A.
Operating Temperature	-35°C to 66°C or -30°F to 150°F.
Maximum Humidity	95%.
Housing	High-impact, UV stabilized PVC. UL 94V-0 flammability classification. Meets UL and CSA watertight requirements. Adhesive bonded.
Visual Fault Indication Light On	Indicates fault.
Listing and Standards	Meets UL943 Class A, UL File E41978, CSA Certified.
Codes	Meets all NEC® and CEC requirements.

NEC® is a registered trademark of the National Fire Protection Association (NFPA).

**IP21**  
SUITABILITY



**GFP15M**

**Multiple Outlet Portable GFCI**

Description	Rating	Receptacles	Plug	Catalog Number
4 outlet, manual set, yellow.	15A, 120V AC	(2) Duplex 5-15R	NEMA 5-15P	<b>GFP15M</b>
4 outlet, manual set, yellow.	20A, 120V AC	(2) Duplex 5-20R	NEMA 5-20P	<b>GFP20M</b>



**GFM20**

**GFCI Module - UL Type 3R Rated**

Description	Rating	Catalog Number
GFCI module, manual set, yellow.	20A, 120V AC, 60 Hz	<b>GFM20</b>
GFCI module, auto set, yellow.	20A, 120V AC, 60 Hz	<b>GFM20A</b>

**Specifications**

	GFP15M / GFP20M	GFM20 / GFM20A
Trip Level	4 to 6 mA.	4 to 6 mA.
Trip Time	.025 sec. nominal.	.025 sec. nominal.
Frequency	60 Hz.	60 Hz.
Voltage	120V AC +10% - 15%. No voltage release feature.	120V AC +10% - 15%. No voltage release feature.
Maximum Interrupting Capacity	5000A.	5000A.
Current	15A / 20A.	20A / 20A Feed-through.
Operating Temperature	-35°C to 66°C or -30°F to 150°F.	-35°C to 66°C or -30°F to 150°F.
Housing Rating	High-impact, yellow Valox® with protective lift covers.	High-impact, UV stabilized, rigid PVC. UL 94V-0 flammability classification. UL Type 3R Rated.
Input	5-15P, 15A / 5-20P, 20A. IP21 Suitability.	#12 AWG stranded conductors (black/white/green).
Output	5-15R(4), 15A / 5-20R(4), 20A.	#12 AWG stranded conductors (red/gray).
Power Supply Cord	6' (182.9 cm) STOW-A (STW FT2 CSA).	N/A.
Mounting Screws	N/A.	Self-tapping, combination, #6-32.
Power "ON" Indication	LED indicator light.	LED indicator light.
Agency Approvals	UL Listed, UL498 for receptacles. Meets UL943 Class A for GFCI's.	UL Listed, CSA Certified. Meets UL943 Class A for GFCI's.
Codes	Meets all NEC® and CEC requirements.	Meets all NEC® and CEC requirements.

Valox® is a trademark of SABIC Innovative Plastics, acquired from General Electric Company.  
 NEC® is a registered trademark of the National Fire Protection Association (NFPA).

# Ground Fault Products

## Hard Wired 30 Ampere GFCI - NEMA 4X



### Applications

Power Generators  
Submersible Pumps  
Textile

Agricultural Equipment  
Cement Cutting Equipment  
Food Processing

Production Assembly Equipment  
Spa and Hot Tubs  
Vending Equipment



Automatic Reset GFCI

### Circuit Guard® Hard Wired 30A GFCI - UL Type 4X Rated

Description	Voltage	Alarm	Manual Set	Automatic Set
Hard wired, manual set and automatic set GFCIs.	120V AC	None	<b>GFHW13005</b>	<b>GFHW13105</b>
	120V AC	Audible	<b>GFHW13015</b>	<b>GFHW13115</b>
	240V AC	None	<b>GFHW23005</b>	<b>GFHW23105</b>
	240V AC	Audible	<b>GFHW23015</b>	<b>GFHW23115</b>
	120/240V AC	Audible	<b>GFHW33015</b>	<b>GFHW33115</b>
	3Ø 250V AC	None	<b>GFHW530</b>	<b>GFHW531</b>
	3Ø 120/208V AC	None	<b>GFHW430</b>	<b>GFHW431</b>

Note: All units above are stock items.



Manual Reset GFCI

### Specifications

Electrical Ratings	
Rated Voltage	120V AC, 240V AC and 120/240V, 3Ø 250V AC, 3Ø 120/208V AC.
Operating Voltage Range	85% to 110%.
Current	Up to 30A or device rating.
Frequency	60 Hz.
Trip Level	4-6 mA.
Phase	Single.
Response Time	.025 sec. Max.
Dielectric Withstand	1500 VRMS across contact, 4000 VRMS between conductors and enclosure.
Surge Withstand	6000V impulse, 0.5 microseconds rise time 100kHz ringing frequency with 40% decay per cycle.
Let Go Line Voltage	60% of rated.
Grounded Neutral Detection	6 Ohms or less.
Power Up	Manual or automatic reset.
Environmental Ratings	
Housing Rating	UL Type 4X.
Construction	Industrial grade design.
Type	Class A GFCI.
Operating Temperature	-35°C to 66°C, -30°F to 150°F.
Leakage Current @ 93% Humidity	Zero.
Features	
Life (Endurance)	10,000 cycles (6000 with load and 4000 without load). Open neutral protection Trips upon loss of neutral.
Grounded Neutral Protection	Trips if ground and neutral touch at load side.
Power On Indicator	Green light on.
Power Off Indicator	Red blinking light plus optional audible alarm.
Wiring Application	3 Wire Single Phase (Hot, Neutral and Ground), 4 Wire Single Phase (Line 1, Line 2, Neutral and Ground).
Switch Interface	Double Insulated.
Latching Mechanism	Electromagnetic.
Physical Specifications	
Wire Leads	#10 AWG, 24" long.
Unit Color	Gray with black cover.
Label Color on Portable and Hard Wired Units	Automatic reset: yellow background with black lettering. Manual reset: black background with yellow lettering.
Weight	1.40 lbs.
Related Code	
Confined Space	OSHA 29 CFR 1926.404 (b) (1) (ii) OSHA 29 CFR 1926.405 (a) (2) (ii) (G)
Construction Sites	NEC 590.6
Commercial Garages	NEC 511.12
Fountains	NEC 680.5B
Spas and Hot Tubs	NEC 680.40
Marinas	NEC 555.3

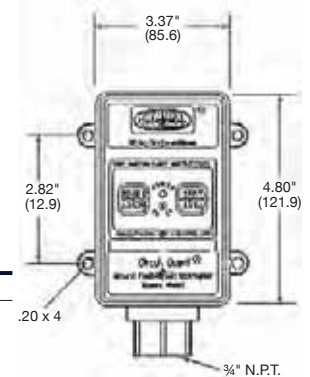

Dimensional Drawing

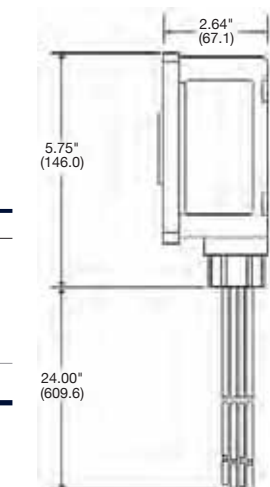

Side View

Dimensions in Inches (mm)

## Applications

Pressure Washers  
De-icing Equipment  
Pipeline Heaters

Portable Electric Heaters  
Material Dryers  
Automotive Garages

Portable Power Tools  
Submersible Pumps  
Outdoor Signage



GFP1311



GFPIL30250LKM

## Circuit Guard® Portable 30A GFCI - UL Type 4X Rated

Description	Cord Length	Voltage	Manual Set	Automatic Set
Portable, manual set and automatic set GFCIs.	2' (60.9 cm)	120V AC	<b>GFP1301</b>	<b>GFP1311</b>
	6' (182.9 cm)	120V AC	<b>GFP1305</b>	<b>GFP1315</b>
	25' (762.0 cm)	120V AC	<b>GFP1302</b>	<b>GFP1312</b>
	50' (1524.0 cm)	120V AC	<b>GFP1303</b>	<b>GFP1313</b>
	2' (60.9 cm)	240V AC	<b>GFP2301</b>	<b>GFP2311</b>
	25' (762.0 cm)	240V AC	<b>GFP2302</b>	<b>GFP2312</b>
	6' (182.9 cm)	120/240V AC	<b>GFP3305</b>	<b>GFP3315</b>
	6' (182.9 cm)	3Ø 250V AC	<b>GFP5305</b>	<b>GFP5315</b>
	6' (182.9 cm)	3Ø 120/208V AC	<b>GFP4305</b>	<b>GFP4315</b>

Note: All units above are stock items.

## Circuit Guard® 30A GFCI In Line GFCI - Locking

Description	Cord Length	Voltage	Manual Set	Automatic Set
L5-30 locking.	2' (60.9 cm)	120V AC	<b>GFPIL30125LKM</b>	<b>GFPIL30125LKA</b>
L6-30 locking.	2' (60.9 cm)	250V AC	<b>GFPIL30250LKM</b>	<b>GFPIL30250LKA</b>

## Plug and Connector Selector Chart (partial listing)

The chart below is a list of possible Hubbell plug and connector body products that can be used with the Hubbell Portable GFCIs.

Family	Style	Amps	Voltage	Hubbell Catalog Number
Insulgrip®	Straight Blade	15	120V AC	<b>HBL5266C &amp; HBL5269C</b>
Insulgrip®	Twist-Lock®	30	240V AC	<b>HBL2621 &amp; HBL2623</b>
Watertight Safety-Shroud®	Twist-Lock®	30	240V AC	<b>HBL2621SW &amp; HBL2623SW</b>
IEC Pin & Sleeve	Watertight Pin & Sleeve	30	240V AC	<b>HBL330P6W &amp; HBL330C6W</b>
Insulgrip® Pin & Sleeve	Insulgrip® Pin & Sleeve	30	240V AC	<b>HBL330PS2W &amp; HBL330CS2W</b>
Hubbellock®	Hubbellock®	20	120V AC	<b>HBL23035B &amp; HBL23032B</b>

## Specifications

### Electrical Ratings

Rated Voltage	120V AC, 240V AC, 120/240V AC, 3Ø 250V AC, 3Ø 120/208V AC.
Operating Voltage Range	85% to 110%.
Current	Up to 30A or device rating.
Frequency	60 Hz.
Trip Level	4-6 mA.
Response Time	25 mS Max.
Dielectric Withstand	1500 VRMS across contact, 4000 VRMS between conductors and enclosure.
Surge Withstand	6000V impulse, 0.5 microseconds rise time 100kHz ringing frequency with 40% decay per cycle.
Let Go Line Voltage	60% of rated.
Power Up	Manual or Automatic reset.

### Environmental Ratings

Housing Rating	UL Type 4X.
Construction Type	Industrial grade design. Meets UL943 Class A GFCI.
Operating Temperature	-35°C to 66°C, -30°F to 150°F.
Leakage Current @ 93% Humidity	Zero.

### Features

Life (Endurance)	10,000 cycles (6000 with load and 4000 without load). Trips upon loss of neutral.
Open Neutral Protection	Trips if ground and neutral touch at load side.
Grounded Neutral Protection	Trips if ground and neutral touch at load side.
Power On Indicator	Green light on.
Power Off Indicator	Red blinking light plus optional audible alarm.
Wiring Application	3 Wire Single Phase (Hot, Neutral and Ground). 4 Wire Single Phase (Line 1, Line 2, Neutral and Ground). Double Insulated.
Switch interface	Double Insulated.
Latching Mechanism	Electromagnetic.

### Physical Specifications

Cord Type	2-50', 10/3 SJGOOW. 100', 8/3 SEOW.
Unit Color	Gray with black cover.
Label Color on Portable and Hard Wired Units	Automatic reset: Yellow background with black lettering. Manual reset: Black background with yellow lettering.
Weight	2 ft. 1.8 lbs., 6 ft. 2.7 lbs., 25 ft. 6.8 lbs., 50 ft. 12.4 lbs., 100 ft. 23.3 lbs.

## Related Code

Confined Space	OSHA 29 CFR 1926.404 (b) (1) (ii) OSHA 29 CFR 1926.405 (a) (2) (ii) (G)
Construction Sites	NEC 590.6
Commercial Garages	NEC 511.12
Outdoor Signs	NEC 600.10
Spas and Hot Tubs	NEC 680.40
Boat Yards	NEC 555.3

Dimensions in Inches (mm)



# Section L Hospital Products

## Index

Product	Page
<b>HBL® Extra Heavy Duty Hospital Grade Duplex Receptacles</b>	
Features and Benefits . . . . .	L-2
Duplex and Style Line® Decorator . . . . .	L-3
SNAPConnect® Receptacles . . . . .	L-4
Hubbell-PRO Receptacles . . . . .	L-6
Single and 4-PLEX® Receptacles . . . . .	L-8
USB Charger Receptacle Tamper-Resistant Duplex. . . . .	L-9
<b>Hospital Grade Plugs, Connector Bodies and Receptacles</b>	
15 and 20A, 125V . . . . .	L-10
15 and 20A, 250V . . . . .	L-11
<b>Hospital Grade GFCI Receptacles</b>	
Extra Heavy Duty Tamper-Resistant GFCI Receptacles . . . . .	L-12
Heavy Duty Tamper-Resistant GFCI Receptacles. . . . .	L-13
GFCI Receptacles with Auto Grounding . . . . .	L-14
Heavy Duty SNAPConnect® GFCI LED Receptacles . . . . .	L-15
<b>Hospital Grade Surge Protection Devices</b> . . . . .	L-16
<b>Hubbellock® Plugs, Connectors and Receptacles.</b> . . . .	L-17
<b>Hubbellock® Mobile X-Ray Devices.</b> . . . .	L-18
<b>Technical Information</b> . . . . .	L-19

### HBL® Extra Heavy Duty Industrial Series



### Industrial and Commercial Series GFCIs



### Surge Protection Devices



### Hubbellock® Receptacles, Plugs and Connectors



## Straight Blade Devices

# HBL® Extra Heavy Duty Hospital Grade Duplex Receptacles

### Features and Benefits

One-piece nickel-plated brass integral ground strap for greater corrosion resistance

Patented ground contact provides redundant grounding

Unique bypass contact design results in greater contact force and reduced heat buildup

Square head, 10-thread bronze center rivet won't rotate, reduces stripping and resists corrosion

I.D. marking surface provides quick, sure circuit identification

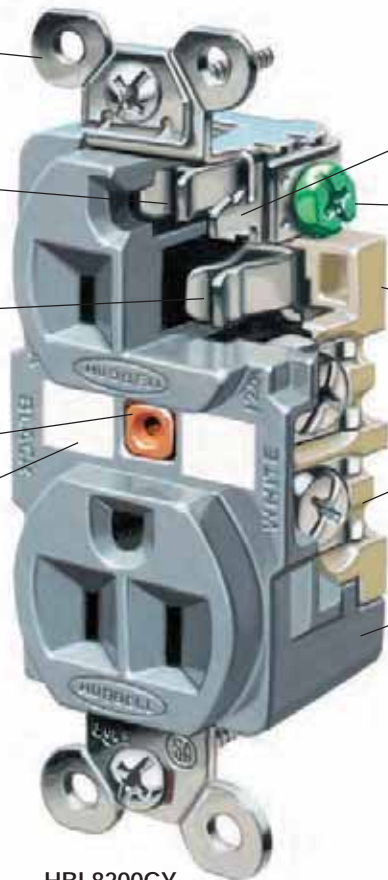

HBL8200GY

Barbed assembly arms reduce possibility of face/base separation

Back wired ground terminal allows faster, easier installation

RTP base offers greater heat resistance, plus contact stability

External bundling terminals contain wire strands and are designed for quick inspection

Deep body design increases impact and chemical resistance

## Hubbell "Hospital Grade" Devices

To qualify for the "Hospital Grade" designation and use of the associated green dot symbol, UL requires that the manufacturer design its devices to perform to specific levels. These levels form an established baseline below which no manufacturer can fall and still carry a green dot.

Hubbell sets their standards high. Each product is built to withstand the severe conditions of abuse that are unique to the hospital environment. Hubbell receptacles have exclusive design features that set them apart from the competition.

- Exclusive nickel-plated bypass contact design increases contact pressure, lowering the operating temperature.
- Four point grounding system provides redundant grounding for low resistance ground continuity in high abuse areas.
- High tech reinforced thermoplastic polyester (RTP) back is tough and heat resistant.

Because of these features and others, the benefit is performance, reliability, and value for any health care facility.



One piece, nickel plated brass mounting strap with integral ground contacts, along with secondary ground contact, provides superior grounding for low resistance flow of fault currents as well as corrosion resistance. Barbed locking arms keep the face locked in place to diminish potential for face/base separation. Back wired ground screw reduces installation time.



Exclusive bypass contacts are made of nickel-plated brass alloy. This design increases blade retention forces, insuring a reliable uninterrupted flow of power.



Reinforced thermoplastic back provides superior thermal, electrical and mechanical properties. By providing contact stability, this high performance material will reduce heat buildup giving you long lasting performance.



External wiring clamps allow for visual inspection of the terminals. A unique strand containment feature on the terminal "bundles" the wire, ensuring 100% clamping of wire strands and reducing heat from the termination.

Straight Blade Devices  
**15 and 20 Ampere, 125 Volts**  
 2 Pole, 3 Wire Grounding



**IP20**  
 SUITABILITY



**15A 125V**  
 NEMA 5-15R  
 UL CSA  
 0.5 HP



**20A 125V**  
 NEMA 5-20R  
 UL CSA  
 1 HP

**HBL® Extra Heavy Duty Hospital Grade Receptacles**

**Duplex**

Description	Color	Catalog Number	
Flush, thermoplastic polyester face, back and side wired.	Black	HBL8200BK	-
	Blue	-	HBL8300BL
	Brown	HBL8200	HBL8300
	Gray	HBL8200GY	HBL8300GY
	Ivory	HBL8200I	HBL8300I
	Light Almond	HBL8200LA	HBL8300LA
	Red	HBL8200RED	HBL8300RED
	White	HBL8200W	HBL8300W
Flush, LED illuminated face, back and side wired.	Gray	HBL8200ILGY	HBL8300ILGY
	Ivory	HBL8200ILI	HBL8300ILI
	Red	HBL8200ILR	HBL8300ILR
	White	HBL8200ILW	HBL8300ILW
Tamper-Resistant receptacle with wire leads. Complies with requirements of NEC® article 517-18(c).	Brown	HBL8200SGA	HBL8300SGA
	Gray	HBL8200SGGYA	HBL8300SGGYA
	Ivory	HBL8200SGIA	HBL8300SGIA
	Light Almond	HBL8200SGLA	HBL8300SGLA
	Red	HBL8200SGRA	HBL8300SGRA
	White	HBL8200SGWA	HBL8300SGWA
Isolated ground <sup>A</sup> .	Orange	IG8200	IG8300
	Red	IG8200R	IG8300R

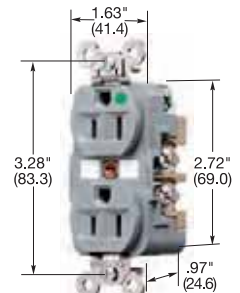

**HBL8200GY**

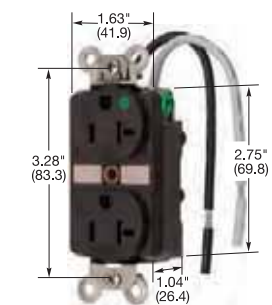

**HBL8300SGA**

**MRI Receptacle, Duplex**

Description	Color	Catalog Number	
MRI receptacle, flush, thermoplastic polyester face, back and side wired.	Ivory	HBL8200IMRI	HBL8300IMRI
	Light Almond	HBL8200LAMRI	HBL8300LAMRI
	Red	HBL8200RMRI	HBL8300RMRI
	White	HBL8200WMRI	HBL8300WMRI

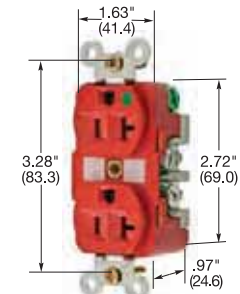

**HBL8300RMRI**

**Slender/Compact, Duplex**

Description	Color	Catalog Number	
Flush, thermoplastic polyester face, back, and side wired. Fed. Spec. verified.	Brown	HBL8200H	HBL8300H
	Gray	HBL8200HG	HBL8300HG
	Green	-	HBL8300HGN
	Ivory	HBL8200HI	HBL8300HI
	Light Almond	HBL8200HLA	HBL8300HLA
	Red	HBL8200HRED	HBL8300HRED
	White	HBL8200HW	HBL8300HW

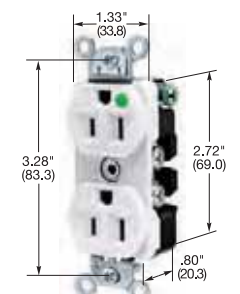

**HBL8200ILW**

**Style Line® Decorator\***

Description	Color	Catalog Number	
Flush, nylon face, back and side wired.	Brown	HBL2172	HBL2182
	Gray	HBL2172GY	HBL2182GY
	Ivory	HBL2172I	HBL2182I
	Office White	-	HBL2182OW
	Red	HBL2172R	HBL2182R
	White	HBL2172WA	HBL2182WA
Isolated ground <sup>A</sup> .	Ivory	-	IG2182I
	Orange	-	IG2182
	White	-	IG2182WA

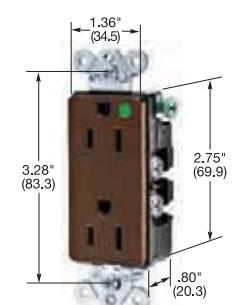

**HBL2172**

Note: <sup>A</sup>See section M for additional information on isolated ground devices.  
 \*Not Fed. Spec. Listed.  
 See page A-46 and A-47 for accessories.  
 See page L-19 for technical information.  
 See page Tech-10 for Tamper-Resistant description.  
 See section N for wallplates.

Dimensions in Inches (mm)

NEC® is a registered trademark of the National Fire Protection Association (NFPA).

**IP20**  
 SUITABILITY



**15A 125V**  
 NEMA 5-15R  
 UL CSA  
 0.5 HP



**20A 125V**  
 NEMA 5-20R  
 UL CSA  
 1 HP

## Extra Heavy Duty Hospital Grade ● SNAPConnect®

### Duplex

Description	Color	Catalog Number	
Hospital grade, finder groove, nylon face, modular receptacle which requires pigtailed connector below. Assembled in USA*.  * For Assembled in USA receptacles drop off the last "A" and add suffix NA. Ex: SNAP8200BKNA.	Black	SNAP8200BKA*	SNAP8300BKA*
	Brown	SNAP8200A*	SNAP8300A*
	Gray	SNAP8200GYA*	SNAP8300GYA*
	Ivory	SNAP8200IA*	SNAP8300IA*
	Light Almond	SNAP8200LAA*	SNAP8300LAA*
	Red	SNAP8200RA*	SNAP8300RA*
	White	SNAP8200WA*	SNAP8300WA*
	Hospital grade, Tamper-Resistant, smooth nylon face, modular receptacle which requires pigtailed connector below. Assembled in USA.	Black	SNAP8200BKTR
Brown		SNAP8200TR	SNAP8300TR
Gray		SNAP8200GYTR	SNAP8300GYTR
Ivory		SNAP8200ITR	SNAP8300ITR
Light Almond		SNAP8200LATR	SNAP8300LATR
Red		SNAP8200RTR	SNAP8300RTR
Isolated ground <sup>A</sup> , Hospital grade, Tamper-Resistant.	Orange	SNAP8200IGTR	SNAP8300IGTR
	Red	SNAP8200RIGTR	SNAP8300RIGTR
Hospital grade, with Power Indicating LED, smooth nylon face, modular receptacle which requires pigtailed connector below. Assembled in USA.	Black	SNAP8200BKL	SNAP8300BKL
	Brown	SNAP8200L	SNAP8300L
	Gray	SNAP8200GYL	SNAP8300GYL
	Ivory	SNAP8200IL	SNAP8300IL
	Light Almond	SNAP8200LAL	SNAP8300LAL
	Red	SNAP8200RL	SNAP8300RL
Isolated ground <sup>A</sup> , Hospital grade, with Power Indicating LED.	Orange	SNAP8200IGL	SNAP8300IGL
	Red	SNAP8200RIGL	SNAP8300RIGL
	Hospital grade, Tamper-Resistant, with Power Indicating LED, smooth nylon face, modular receptacle which requires pigtailed connector below. Assembled in USA.	Black	SNAP8200BKLTR
Brown		SNAP8200LTR	SNAP8300LTR
Gray		SNAP8200GYLTR	SNAP8300GYLTR
Ivory		SNAP8200ILTR	SNAP8300ILTR
Light Almond		SNAP8200LALTR	SNAP8300LALTR
Red		SNAP8200RLTR	SNAP8300RLTR
Isolated ground <sup>A</sup> , Hospital grade, TR with Power Indicating LED.	Orange	SNAP8200IGLTR	SNAP8300IGLTR
	Red	SNAP8200RIGLTR	SNAP8300RIGLTR

Note: <sup>A</sup>See section M additional information on isolated ground devices.  
 See page A-14 for additional information on SNAPConnect® features.  
 See page Tech-10 for additional information and LED Power Indicators description.  
 See pages A-46 and A-47 for accessories.  
 See page L-20 for technical information.  
 See section N for wallplates.  
 Consult factory for available Split-Circuit capable SNAPConnect® devices.

### SNAPConnect® Right Angle Pigtailed Connector

Description	Wire Type	General Use Catalog Number	Assembled in USA Catalog Number
Clear right angle terminal with 6 inch leads #12 AWG THHN/THWN-2; Polycarbonate housing material	Solid	SNAP1RA	SNAP1RNA
	Stranded	SNAP2RA	SNAP2RNA

Note: For Assembled in USA products, must order connector with NA suffix.  
 See page L-20 for technical information.

**Many of these products are Assembled in USA, as indicated, and many are Buy American Compliant. Please contact Hubbell with any certification requirements.**

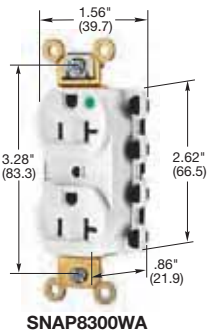

SNAP8300WA

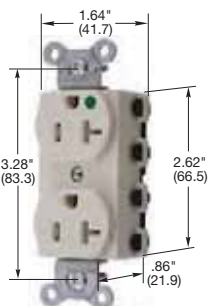

SNAP8300LATR

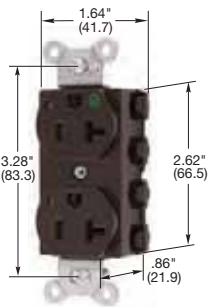

SNAP8300L

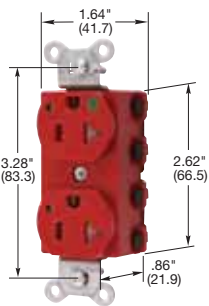

SNAP8300RLTR

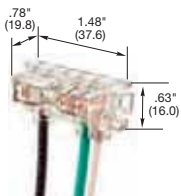

SNAP1RA

Dimensions in Inches (mm)

Straight Blade Devices  
**15 and 20 Ampere, 125 Volts**  
 2 Pole, 3 Wire Grounding



**IP20**  
SUITABILITY

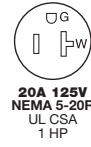
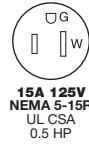

**Extra Heavy Duty**  
**Hospital Grade ● SNAPConnect®**  
**Style Line® Decorator**

Description	Color	Catalog Number	Catalog Number
Hospital grade, Style Line® decorator, flush, nylon face, modular receptacle which requires pigtailed connector below. Assembled in USA*.	Black	SNAP2172BKA*	SNAP2182BKA*
	Brown	SNAP2172A*	SNAP2182A*
	Gray	SNAP2172GYA*	SNAP2182GYA*
	Ivory	SNAP2172IA*	SNAP2182IA*
	Light Almond	SNAP2172LAA*	SNAP2182LAA*
	Red	SNAP2172RA*	SNAP2182RA*
	White	SNAP2172WA*	SNAP2182WA*
Hospital grade, Tamper-Resistant, Style Line® decorator, flush, nylon face, modular receptacle which requires pigtailed connector below. Assembled in USA.	Black	SNAP2172BKTR	SNAP2182BKTR
	Brown	SNAP2172TR	SNAP2182TR
	Gray	SNAP2172GYTR	SNAP2182GYTR
	Ivory	SNAP2172ITR	SNAP2182ITR
	Light Almond	SNAP2172LATR	SNAP2182LATR
	Red	SNAP2172RTR	SNAP2182RTR
	White	SNAP2172WTR	SNAP2182WTR
Isolated ground <sup>A</sup> , Hospital grade, Tamper-Resistant.	Orange	SNAP2172IGTR	SNAP2182IGTR
	Red	SNAP2172RIGTR	SNAP2182RIGTR
Hospital grade, with Power Indicating LED, Style Line® decorator, flush, nylon face, modular receptacle which requires pigtailed connector below. Assembled in USA.	Black	SNAP2172BKL	SNAP2182BKL
	Brown	SNAP2172L	SNAP2182L
	Gray	SNAP2172GYL	SNAP2182GYL
	Ivory	SNAP2172IL	SNAP2182IL
	Light Almond	SNAP2172LAL	SNAP2182LAL
	Red	SNAP2172RL	SNAP2182RL
	White	SNAP2172WL	SNAP2182WL
Isolated ground <sup>A</sup> , Hospital grade, with Power Indicating LED.	Orange	SNAP2172IGL	SNAP2182IGL
	Red	SNAP2172RIGL	SNAP2182RIGL
Hospital grade, Tamper-Resistant, with Power Indicating LED, Style Line® decorator, flush, nylon face, modular receptacle which requires pigtailed connector below. Assembled in USA.	Black	SNAP2172BKLTR	SNAP2182BKLTR
	Brown	SNAP2172LTR	SNAP2182LTR
	Gray	SNAP2172GYLTR	SNAP2182GYLTR
	Ivory	SNAP2172ILTR	SNAP2182ILTR
	Light Almond	SNAP2172LALTR	SNAP2182LALTR
	Red	SNAP2172RLTR	SNAP2182RLTR
	White	SNAP2172WLTR	SNAP2182WLTR
Isolated ground <sup>A</sup> , Hospital grade, TR with Power Indicating LED.	Orange	SNAP2172IGLTR	SNAP2182IGLTR
Red	SNAP2172RIGLTR	SNAP2182RIGLTR	

Note: <sup>A</sup> See section M additional information on isolated ground devices.  
 See page A-14 for additional information on SNAPConnect® features.  
 See page Tech-10 for Tamper-Resistant and LED Power Indicators description.  
 See pages A-46 and A-47 for accessories.  
 See page L-20 for technical information.  
 See section N for wallplates.  
 Consult factory for available Split-Circuit capable SNAPConnect® devices.

**SNAPConnect® Right Angle Pigtailed Connector**

Description	Wire Type	General Use Catalog Number	Assembled in USA Catalog Number
Clear right angle terminal with 6 inch leads #12 AWG THHN/THWN-2; Polycarbonate housing material	Solid	SNAP1RA	SNAP1RNA
	Stranded	SNAP2RA	SNAP2RNA

Note: For Assembled in USA products, must order connector with NA suffix.  
 See page L-20 for technical information.

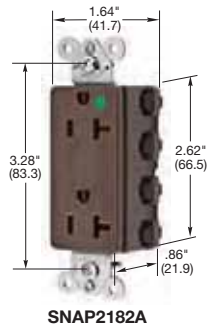

SNAP2182A

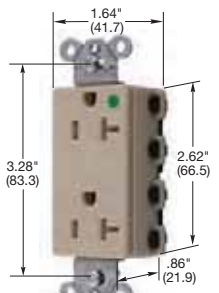

SNAP2182ITR

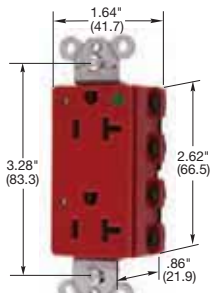

SNAP2182RL

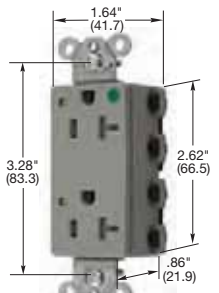

SNAP2182GYLTR

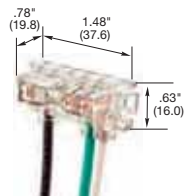

SNAP1RA

Dimensions in Inches (mm)

**Many of these products are Assembled in USA, as indicated, and many are Buy American Compliant. Please contact Hubbell with any certification requirements.**

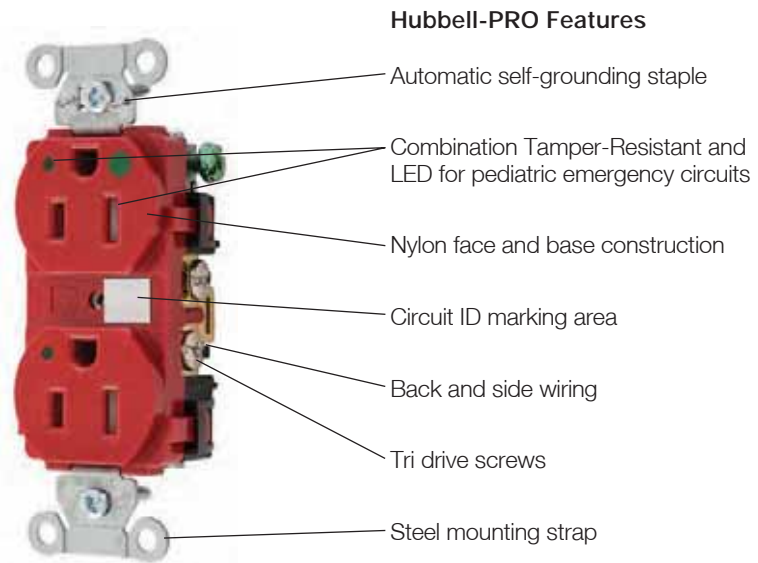

**Hubbell-PRO Features**

- Automatic self-grounding staple
- Combination Tamper-Resistant and LED for pediatric emergency circuits
- Nylon face and base construction
- Circuit ID marking area
- Back and side wiring
- Tri drive screws
- Steel mounting strap

**8200REDLTR**

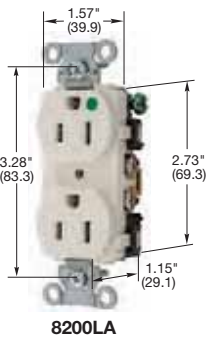

**8200LA**

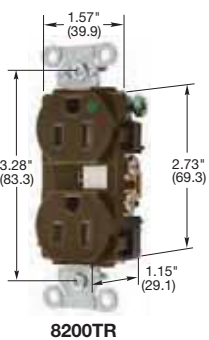

**8200TR**

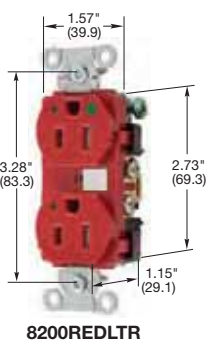

**8200REDLTR**

Dimensions in Inches (mm)

**Hubbell-PRO Heavy Duty Hospital Grade ● Receptacles**

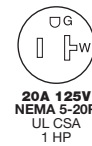
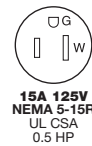

**Duplex**

Description	Color	Catalog Number	
Hospital grade, smooth nylon face, back and side wired. Assembled in USA.	Black	<b>8200BK</b>	<b>8300BK</b>
	Brown	<b>8200</b>	<b>8300</b>
	Gray	<b>8200GY</b>	<b>8300GY</b>
	Ivory	<b>8200IV</b>	<b>8300IV</b>
	Light Almond	<b>8200LA</b>	<b>8300LA</b>
	Red	<b>8200RED</b>	<b>8300RED</b>
	White	<b>8200WHI</b>	<b>8300WHI</b>
Hospital grade, Tamper-Resistant, smooth nylon face, back and side wired. Assembled in USA.	Black	<b>8200BKTR</b>	<b>8300BKTR</b>
	Brown	<b>8200TR</b>	<b>8300TR</b>
	Gray	<b>8200GYTR</b>	<b>8300GYTR</b>
	Ivory	<b>8200IVTR</b>	<b>8300IVTR</b>
	Light Almond	<b>8200LATR</b>	<b>8300LATR</b>
	Red	<b>8200REDTR</b>	<b>8300REDTR</b>
	White	<b>8200WTR</b>	<b>8300WTR</b>
Hospital grade, with Power Indicating LED, smooth nylon face, back and side wired. Assembled in USA.	Black	<b>8200BKL</b>	<b>8300BKL</b>
	Brown	<b>8200L</b>	<b>8300L</b>
	Gray	<b>8200GYL</b>	<b>8300GYL</b>
	Ivory	<b>8200IVL</b>	<b>8300IVL</b>
	Light Almond	<b>8200LAL</b>	<b>8300LALM</b>
	Red	<b>8200REDL</b>	<b>8300REDL</b>
	White	<b>8200WL</b>	<b>8300WL</b>
Hospital grade, Tamper-Resistant, with Power Indicating LED, smooth nylon face, back and side wired. Assembled in USA.	Black	<b>8200BKLTR</b>	<b>8300BKLTR</b>
	Brown	<b>8200LTR</b>	<b>8300LTR</b>
	Gray	<b>8200GYLTR</b>	<b>8300GYLTR</b>
	Ivory	<b>8200IVLTR</b>	<b>8300IVLTR</b>
	Light Almond	<b>8200LALTR</b>	<b>8300LALTR</b>
	Red	<b>8200REDLTR</b>	<b>8300REDLTR</b>
	White	<b>8200WLTR</b>	<b>8300WLTR</b>

*Note: See pages A-46 and A-47 for accessories.  
 See page L-21 for technical information.  
 See page Tech-10 for Tamper-Resistant and LED Power Indicators description.  
 See section N for wallplates.*

**The products listed on this page are Assembled in USA, and many are Buy American Compliant. Please contact Hubbell with any certification requirements.**

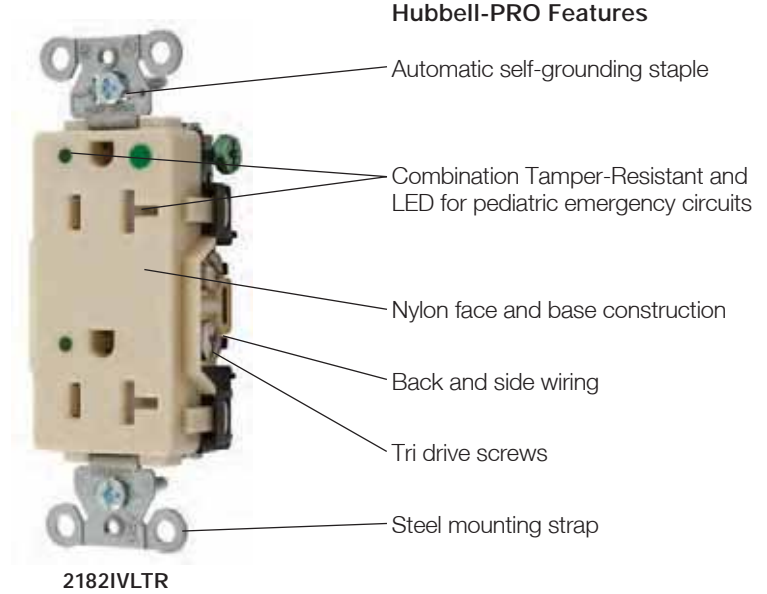

## Hubbell-PRO Heavy Duty Hospital Grade Receptacles

### Style Line® Decorator

Description	Color	Catalog Number	
Hospital grade, Style Line® decorator, flush, nylon face, back and side wired. Assembled in USA.	Black	2172BK	2182BK
	Brown	2172	2182
	Gray	2172GY	2182GY
	Ivory	2172IV	2182IV
	Light Almond	2172LA	2182LA
	Red	2172RED	2182RED
	White	2172W	2182W
Hospital grade, Tamper-Resistant, Style Line® decorator, flush, nylon face, back and side wired. Assembled in USA.	Black	2172BKTR	2182BKTR
	Brown	2172TR	2182TR
	Gray	2172GYTR	2182GYTR
	Ivory	2172IVTR	2182IVTR
	Light Almond	2172LATR	2182LATR
	Red	2172REDTR	2182REDTR
	White	2172WTR	2182WTR
Hospital grade, with Power Indicating LED, Style Line® decorator, flush, nylon face, back and side wired. Assembled in USA.	Black	2172BKL	2182BKL
	Brown	2172L	2182L
	Gray	2172GYL	2182GYL
	Ivory	2172IVL	2182IVL
	Light Almond	2172LAL	2182LAL
	Red	2172REDL	2182REDL
	White	2172WL	2182WL
Hospital grade, Tamper-Resistant, with Power Indicating LED, Style Line® decorator, flush, nylon face, back and side wired. Assembled in USA.	Black	2172BKLTR	2182BKLTR
	Brown	2172LTR	2182LTR
	Gray	2172GYLTR	2182GYLTR
	Ivory	2172IVLTR	2182IVLTR
	Light Almond	2172LALTR	2182LALTR
	Red	2172REDLTR	2182REDLTR
	White	2172WLTR	2182WLTR

Note: See pages A-46 and A-47 for accessories.  
 See page L-21 for technical information.  
 See page Tech-10 for Tamper-Resistant and LED Power Indicators description.  
 See section N for wallplates.

**The products listed on this page are Assembled in USA, and many are Buy American Compliant. Please contact Hubbell with any certification requirements.**

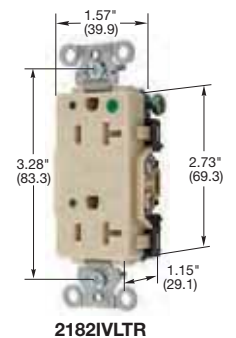
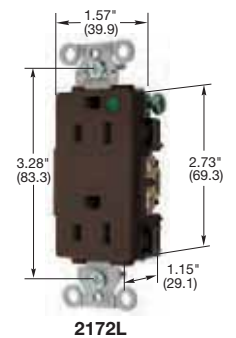
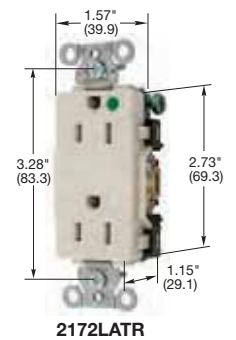

Dimensions in Inches (mm)

Hospital Products  
**15 and 20 Ampere, 125 Volts**  
*2 Pole, 3 Wire Grounding*

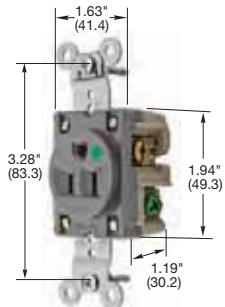

**HBL8210GY**

**HBL® Extra Heavy Duty  
Hospital Grade ●  
Single Receptacles**

**IP20**  
SUITABILITY



**15A 125V**  
**NEMA 5-15R**  
UL CSA  
0.5 HP



**20A 125V**  
**NEMA 5-20R**  
UL CSA  
1 HP

Description	Color	Catalog Number	
Flush, nylon face, back and side wired, Fed. Spec. verified.	Almond	-	HBL8310AL
	Brown	HBL8210	HBL8310
	Gray	HBL8210GY	HBL8310GY
	Ivory	HBL8210I	HBL8310I
	Red	HBL8210R	HBL8310R
	White	HBL8210W	HBL8310W
Panel mount on 1.94 in. (49.2) centers.	Brown	HBL8284	-
	Ivory	HBL8284I	HBL8384I
Isolated ground <sup>A</sup> .	Orange	IG8210	IG8310

Note: <sup>A</sup> See section M for additional information on isolated ground devices.

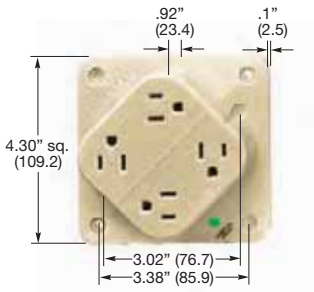

**HBL415HI**

**4-PLEX®  
Hospital Grade ● Receptacles**



**15A 125V**  
**NEMA 5-15R**  
UL CSA  
0.5 HP



**20A 125V**  
**NEMA 5-20R**  
UL CSA  
1 HP

Description	Color	Catalog Number	
4 outlet high impact resistant Polycarbonate construction. Mount to 4 in. square box.	Brown	HBL415H	HBL420H
	Gray	-	HBL420HGY
	Ivory	HBL415HI	HBL420HI
	Red	HBL415HR	HBL420HR
	White	HBL415HW	HBL420HW
4-PLEX adapter plates for 1- and 2-gang, device boxes.	Brown	HBL4AP	HBL4AP
	Gray	HBL4APGY	HBL4APGY
	Ivory	HBL4API	HBL4API
	Red	HBL4APR	HBL4APR
	White	HBL4APW	HBL4APW

Note: See page A-23 for additional information on 4-PLEX devices.  
See page A-60 for technical information.  
4-PLEX devices are not Fed. Spec. Listed.

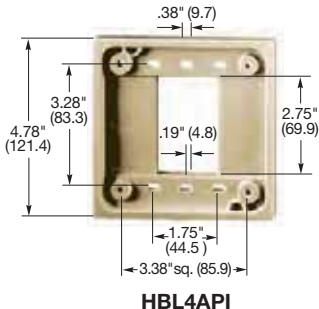

**HBL4API**

Dimensions in Inches (mm)



## USB Charger Tamper-Resistant Duplex Receptacle

Hubbell's USB Charger Receptacle provides both USB and AC electrical power in a standard single gang electrical opening. Designed to provide more charging options for personal electronics.

### Typical Applications

Ideal for use in renovation, new construction and to add capacity for USB charging. Especially suited for use in hotels, hospitals, schools, offices, homes and more.



Hotels



Healthcare



Schools



Offices



Residential

Capability to charge wide range of devices including:

- Tablets
- Smartphones
- MP3 players
- Apple® iPad®
- Apple® iPod®
- Apple® iPhone®

- Complies with battery charging specification USB BC1.2
- Compatible with USB 1.1/2.0/3.0 devices, including Apple® products
- Complies with Part 15 of the FCC rules
- cULus listed to UL498 and UL1310

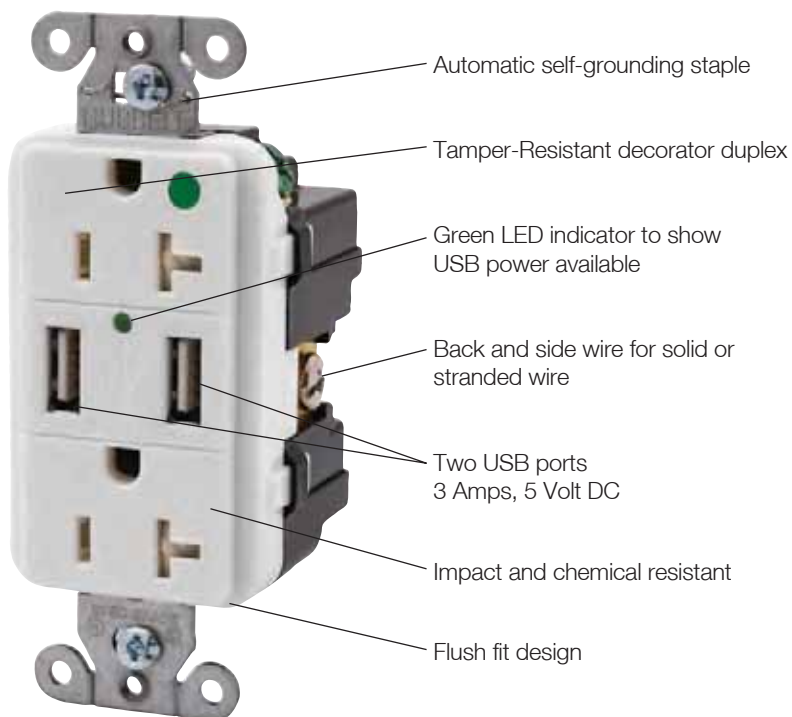

USB8300W

## USB Charger Tamper-Resistant Hospital Grade Receptacles

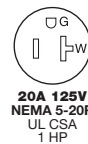
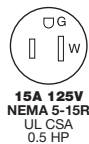

Description	Color	15A 125V AC	20A 125V AC
USB Charger Tamper-Resistant receptacle, Two USB Type 2.0 ports 3 Amp, 5 Volt DC, 15 or 20 Amp, 125 Volt AC decorator duplex.	Black	USB8200BK	USB8300BK
	Brown	USB8200	USB8300
	Gray	USB8200GY	USB8300GY
	Ivory	USB8200I	USB8300I
	Light Almond	USB8200LA	USB8300LA
	Red	USB8200R	USB8300R
	White	USB8200W	USB8300W

Note: See page A-18 for standard USB charger.  
 See page Tech-10 for Tamper-Resistant description.

Apple, iPad, iPod and iPhone are registered trademarks of Apple, inc.

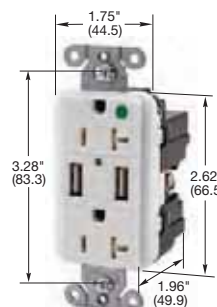

USB8300W

Dimensions in Inches (mm)

**IP20**  
 SUITABILITY



## Hospital Grade ● Plugs

### Insulgrip®

Description	Cord Diameter	Catalog Number	
Black and white nylon.	.230"-.720" (5.8-18.3)	<b>HBL8215C</b>	<b>HBL8315C</b>
Transparent housing.	.230"-.720" (5.8-18.3)	<b>HBL8215CT</b>	<b>HBL8315CT</b>
8 position angle plug, transparent housing.	.250"-.655" (6.4-16.6)	<b>HBL8215CAT*</b>	<b>HBL8315CAT*</b>

### Valise®

Description	Cord Diameter	Catalog Number	
White nylon.	.300"-.660" (7.6-16.8)	<b>HBL8115V</b>	<b>HBL8364V</b>
Insulation displacement, white nylon.	.300"-.360" (7.6-9.1)	<b>HBL8013V*</b>	-

*Note: \*Not Fed. Spec. Listed.  
 See page A-47 for accessories.  
 See pages L-23 and L-24 for technical information.*

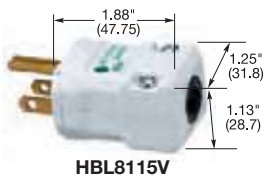
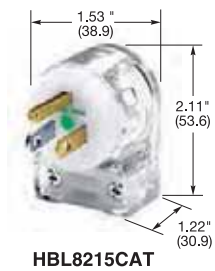

**IP20**  
 SUITABILITY



## Hospital Grade ● Connector Bodies

### Insulgrip®

Description	Cord Diameter	Catalog Number	
Black and white nylon.	.230"-.720" (5.8-18.3)	<b>HBL8219C</b>	<b>HBL8319C</b>
Transparent housing.	.230"-.720" (5.8-18.3)	<b>HBL8219CT</b>	<b>HBL8319CT</b>

### Valise®

Description	Cord Diameter	Catalog Number	
White nylon.	.300"-.660" (7.6-16.8)	<b>HBL8119V</b>	-

*Note: See page A-47 for accessories.  
 See pages L-23 and L-24 for technical information.*

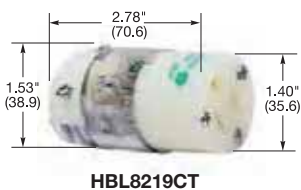

Dimensions in Inches (mm)

Straight Blade Devices  
**15 and 20 Ampere, 250 Volts**  
 2 Pole, 3 Wire Grounding



**IP20**  
SUITABILITY



**15A 250V**  
NEMA 6-15P  
UL CSA  
1.5 HP



**20A 250V**  
NEMA 6-20P  
UL CSA  
2 HP

**Hospital Grade ● Plugs**

**Valise®**

Description	Cord Diameter	Catalog Number	Catalog Number
Valise plug, white nylon.	.300"-.660" (7.6-16.8)	<b>HBL8666V</b>	<b>HBL8464V</b>

*Note: HP ratings listed above are based on 208 to 240V AC only.*

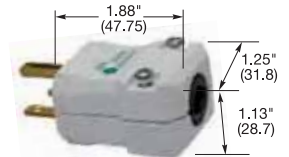

**HBL8666V**

**Hospital Grade ● Receptacles**

**HBL® Extra Heavy Duty, Duplex**

Description	Color	Catalog Number	Catalog Number
Flush, thermoplastic polyester face, back and side wired, multiple drive screws.	Brown Ivory	<b>HBL8600</b> <b>HBL8600I</b>	<b>HBL8400</b> <b>HBL8400I</b>

*Note: See page A-46 for accessories.  
 See section N for wallplates.*



**15A 250V**  
NEMA 6-15R  
UL CSA  
1.5 HP



**20A 250V**  
NEMA 6-20R  
UL CSA  
2 HP

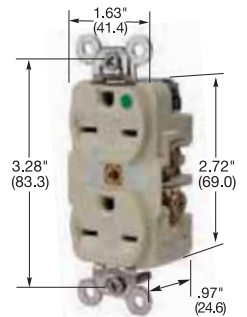

**HBL8600I**

**Hospital Grade ● Connector Bodies**

**Valise®**

Description	Cord Diameter	Catalog Number
White nylon.	.300"-.660" (7.6-16.8)	<b>HBL8469V</b>



**20A 250V**  
NEMA 6-20R  
UL CSA  
2 HP



**HBL8469V**

*Dimensions in Inches (mm)*

# Hospital Products Extra Heavy Duty GFCI Receptacles Tamper-Resistant and Weather Resistant



Fed.Spec.



Meets UL Standard 943  
Class A GFCI

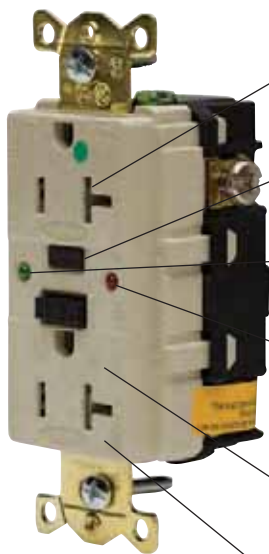

GFR8300SGI

## 10kA Short Circuit Current Rating

- Limits improper access to energized contacts
  - Exclusive patented tamper-resistant protection through switching technology
- Continually tests and monitors for people protection automatically
  - Patented self test diagnostics
- Power indication
  - Steady "ON" GREEN LED provides indication of power
- Ground fault indicator
  - Steady "ON" RED LED provides visual indication of a ground fault condition; flashing red indicates device has lost capability to provide protection
- No power at face if reverse wired
  - Open circuit condition eliminates false assumption of protection at face
- Durable face with V-0 flammability rating
  - Polyester face cover

## Hospital Grade ● AUTOGUARD® Self Test GFCI Receptacles Tamper-Resistant and Weather Resistant



15A 125V  
NEMA 5-15R  
UL CSA  
0.5 HP



20A 125V  
NEMA 5-20R  
UL CSA  
1 HP



Description	Rating	Color	Catalog Number	Catalog Number
Flush, polyester face, back and side wired, multiple drive screws.	15 and 20A 125V AC	Black	GFR8200SGBK	GFR8300SGBK
		Brown	GFR8200SG	GFR8300SG
		Gray	GFR8200SGGY	GFR8300SGGY
		Ivory	GFR8200SGI	GFR8300SGI
		Red	GFR8200SGR	GFR8300SGR
		White	GFR8200SGW	GFR8300SGW



GFR8300SGW

## Hospital Grade ● CircuitGuard® GFCI Receptacles Tamper-Resistant and Weather Resistant



15A 125V  
NEMA 5-15R  
UL CSA  
0.5 HP



20A 125V  
NEMA 5-20R  
UL CSA  
1 HP



Description	Rating	Color	Catalog Number	Catalog Number
Flush, polyester face, back and side wired, multiple drive screws.	15 and 20A 125V AC	Black	GFR8200BKTR	GFR8300BKTR
		Brown	GFR8200TR	GFR8300TR
		Gray	GFR8200GYTR	GFR8300GYTR
		Ivory	GFR8200ITR	GFR8300ITR
		Red	GFR8200RTR	GFR8300RTR
		White	GFR8200WTR	GFR8300WTR



GFR8300RTR

Note: GFCI type receptacles should not be used in critical care patient areas or for electrical life support equipment applications because of the possibility of power interruption. All GFCI receptacles listed above are furnished with both a matching color nylon wallplate, and a SS26 302/304 super stainless steel wallplate. 20 amp feed-through capability. See page Tech-10 for Tamper and Weather Resistant descriptions.

# Hospital Products Heavy Duty GFCI Receptacles Tamper-Resistant and Weather Resistant with Auto Grounding

Meets UL Standard 943  
Class A GFCI

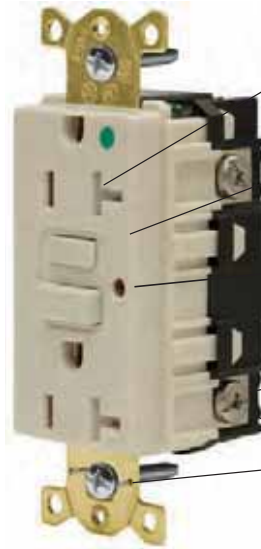

GFR8300HITR

## 10kA Short Circuit Current Rating

- Limits improper access to energized contacts
  - Patented shutter design for tamper-resistant protection
- No power at face if reverse wired
  - Open circuit condition eliminates false assumption of protection at face
- Ground fault EOL indicator
  - Flashing **RED** indicates device has lost capability to provide protection
- Accepts fork terminals
  - Open terminal design
- Installation ease
  - Internal back wiring
  - Automatic self-grounding staple
  - Captive mounting screws

## Hospital Grade ● Circuit Guard® GFCI Receptacles Tamper-Resistant and Weather Resistant



15A 125V  
NEMA 5-15R  
UL CSA  
0.5 HP



20A 125V  
NEMA 5-20R  
UL CSA  
1 HP

Description	Rating	Color	Catalog Number		
Flush, nylon face, back and side wired, multiple drive screws, self-grounding staple.	15 and 20A 125V AC	Black	GFR8200HBKTR	GFR8300HBKTR	
		Brown	GFR8200HTR	GFR8300HTR	
		Gray	GFR8200HGYTR	GFR8300HGYTR	
		Ivory	GFR8200HITR	GFR8300HITR	
		Light Almond	GFR8200HLATR	GFR8300HLATR	
		Red	GFR8200HRTR	GFR8300HRTR	
		White	GFR8200HWTR	GFR8300HWTR	



GFR8200HGYTR

## Hospital Grade ● Tamper-Resistant and Weather Resistant Assembled in USA



15A 125V  
NEMA 5-15R  
UL CSA  
0.5 HP



20A 125V  
NEMA 5-20R  
UL CSA  
1 HP



Description	Rating	Color	Catalog Number		
Flush, nylon face, back and side wired, multiple drive screws, self-grounding staple. Assembled in USA.	15 and 20A 125VAC	Black	GFR8200HBKTRU	GFR8300HBKTRU	
		Brown	GFR8200HTRU	GFR8300HTRU	
		Gray	GFR8200HGYTRU	GFR8300HGYTRU	
		Ivory	GFR8200HITRU	GFR8300HITRU	
		Light Almond	GFR8200HLATRU	GFR8300HLATRU	
		Red	GFR8200HRTRU	GFR8300HRTRU	
		White	GFR8200HWTRU	GFR8300HWTRU	



GFR8300HTRU

Note: GFCI type receptacles should not be used in critical care patient areas or for electrical life support equipment applications because of the possibility of power interruption. All GFCI receptacles listed above are furnished with a matching color nylon wallplate. 20 amp feed-through capability. See page Tech-10 for Tamper and Weather Resistant descriptions.

Many of these products are Assembled in USA, as indicated, and many are Buy American Compliant. Please contact Hubbell with any certification requirements.

# Hospital Products Heavy Duty GFCI Receptacles LED with Auto Grounding and Assembled in USA GFCI LED Receptacles



GFR8200HILA

## 10kA Short Circuit Current Rating

- Comprehensive diagnostics
  - When test button is actuated, both the electronic components and mechanical trip mechanism are functionally tested
- Ground fault EOL indicator
  - Flashing **RED** indicates device has lost capability to provide protection
- No power at face if reverse wired
  - Open circuit condition eliminates false assumption of protection at face
- Installation ease
  - Internal back wiring
  - Automatic self-grounding staple
  - Captive mounting screws



15A 125V  
NEMA 5-15R  
UL CSA  
0.5 HP



20A 125V  
NEMA 5-20R  
UL CSA  
1 HP

## Hospital Grade ● Circuit Guard® GFCI Receptacles

Description	Rating	Color	Catalog Number	
Flush, nylon face, back and side wired, multiple drive screws, self-grounding staple.	15 and 20A 125V AC	Black	GFR8200HBKLA	GFR8300HBKLA
		Brown	GFR8200HLA	GFR8300HLA
		Gray	GFR8200HGYLA	GFR8300HGYLA
		Ivory	GFR8200HILA	GFR8300HILA
		Light Almond	GFR8200HLAA	GFR8300HLAA
		Red	GFR8200HRLA	GFR8300HRLA
		White	GFR8200HWLA	GFR8300HWLA

Note: GFCI type receptacles should not be used in critical care patient areas or for electrical life support equipment applications because of the possibility of power interruption. All GFCI receptacles listed above are furnished with a matching color nylon wallplate. 20 amp feed-through capability.

## Hospital Grade ● GFCI LED Assembled in USA



Description	Rating	Color	Catalog Number	
Hospital Grade ●, impact resistant flush nylon face, back and side wired, self-grounding staple. Assembled in USA.	15 and 20A 125V AC	Black	GFR8200HBKLU	GFR8300HBKLU
		Brown	GFR8200HLU	GFR8300HLU
		Gray	GFR8200HGYLU	GFR8300HGYLU
		Ivory	GFR8200HILU	GFR8300HILU
		Light Almond	GFR8200HLALU	GFR8300HLALU
		Red	GFR8200HRLU	GFR8300HRLU
		White	GFR8200HWLU	GFR8300HWLU

## GFCI Receptacle Specifications per GFCI Products Listed (Pages L-12 to L-15)

Trip Level	4 to 6 mA.
Trip Time	.025 second nominal.
Frequency	60 Hz.
Voltage	120V AC +10% - 15% (102V to 132V).
Amperage	15A/20A, 20A Feed Thru.
Maximum Interrupting Capacity	10,000A.
Operating Temperature	-35°C to 66°C or -30°F to 150°F.
Maximum Humidity	95%.
Listings and Standards	Meets UL498 for receptacles, UL943 Class A for GFCIs UL File E41978. CSA Certified.
Codes	Meets all NEC® and CEC requirements. NEMA WD-6 ANSI 73.

NEC® is a registered trademark of the National Fire Protection Association (NFPA).

**Many of these products are Assembled in USA, as indicated, and many are Buy American Compliant. Please contact Hubbell with any certification requirements.**



GFR8200HWLA



GFR8300HRLU

# Hospital Products SNAPConnect® Heavy Duty GFCI Receptacles Assembled in USA



## SNAPConnect® GFCI Features

- Audible SNAP, indicates solid connection
  - Secure, easy grip latch
- Inspection of power contacts
  - Clear terminal housing
  - No exposed metal
- Ground fault EOL indicator
  - Flashing **RED** indicates device has lost capability to provide protection
- Requires minimal box space
  - Compact size
  - Clean finished look
- Installation ease
  - Automatic self-grounding staple

GFR8300SNAPINA



## Hospital Grade ● SNAPConnect® GFCI LED Assembled in USA

Description	Rating	Color	Catalog Number	
SNAPConnect® GFCI, self-grounding staple. Assembled in USA.	15 and 20A 125V AC	Black	GFR8200SNAPBKNA	GFR8300SNAPBKNA
		Brown	GFR8200SNAPNA	GFR8300SNAPNA
		Gray	GFR8200SNAPGYNA	GFR8300SNAPGYNA
		Ivory	GFR8200SNAPINA	GFR8300SNAPINA
		Light Almond	GFR8200SNAPLANA	GFR8300SNAPLANA
		Red	GFR8200SNAPRNA	GFR8300SNAPRNA
White	GFR8200SNAPWNA	GFR8300SNAPWNA		

Requires connector below, sold separately.



GFR8200SNAPWNA

## Hospital Grade ● SNAPConnect® GFCI LED Tamper and Weather Resistant, Assembled in USA

Description	Rating	Color	Catalog Number	
SNAPConnect® GFCI TR/WR, self-grounding staple. Assembled in USA.	15 and 20A 125V AC	Black	GFTR8200SNAPBKNA	GFTR8300SNAPBKNA
		Brown	GFTR8200SNAPNA	GFTR8300SNAPNA
		Gray	GFTR8200SNAPGYNA	GFTR8300SNAPGYNA
		Ivory	GFTR8200SNAPINA	GFTR8300SNAPINA
		Light Almond	GFTR8200SNAPLANA	GFTR8300SNAPLANA
		Red	GFTR8200SNAPRNA	GFTR8300SNAPRNA
White	GFTR8200SNAPWNA	GFTR8300SNAPWNA		

Requires connector below, sold separately.



GFTR8300SNAPGYNA

## SNAPConnect® Right Angle Pigtailed Connector

Description	Wire Type	General Use Catalog Number	Buy American Catalog Number
Clear right angle terminal with 6 inch leads, 600V, #12 AWG THHN/THWN-2, Polycarbonate housing material.	Solid	SNAP1RA	SNAP1RNA
	Stranded	SNAP2RA	SNAP2RNA

Note: For Assembled in USA products, must order connector with NA suffix.  
See page Tech-10 for Tamper and Weather Resistant descriptions.  
See section N for wallplates.



SNAP1RNA

Many of these products are Assembled in USA, as indicated, and many are Buy American Compliant. Please contact Hubbell with any certification requirements.

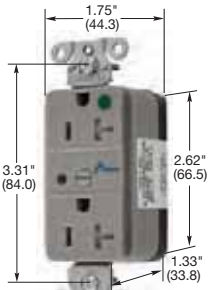

SNAP8362GYS

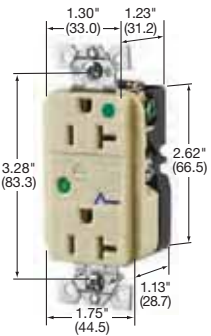

HBL8362ISA

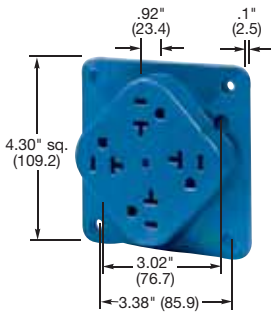

HBL420HS

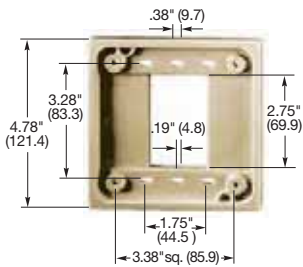

HBL4API



HBL6PSHG

Dimensions in Inches (mm)

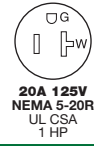
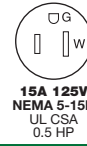

Hospital Grade ● Circuit Guard® Receptacles

Description	Color	Catalog Number	
SNAP Connect® Tamper-Resistant, surge suppression receptacle, smooth face, duplex. Requires connector on page L-15, sold separately.	Blue	SNAP8262S	SNAP8362S
	Gray	SNAP8262GYS	SNAP8362GYS
	Ivory	SNAP8262IS	SNAP8362IS
	Light Almond	SNAP8262LAS	SNAP8362LAS
	Red	SNAP8262RS	SNAP8362RS
	White	SNAP8262WS	SNAP8362WS
Surge suppression receptacles with light and alarm, 240 joules/15000A per mode.	Almond	HBL8262ALSA	HBL8362ALSA
	Blue	HBL8262SA	HBL8362SA
	Gray	HBL8262GYS	HBL8362GYS
	Ivory	HBL8262ISA	HBL8362ISA
	Red	HBL8262RSA	HBL8362RSA
	White	HBL8262WSA	HBL8362WSA
Isolated ground, surge suppression receptacles with light and alarm, 240 joules/15000A per mode.	Blue	IG8262SA	IG8362SA
	Gray	IG8262GYS	IG8362GYS
	Ivory	IG8262ISA	IG8362ISA
	Orange	IG8262OSA	IG8362OSA
	Red	IG8262RSA	IG8362RSA
	White	IG8262WSA	IG8362WSA
4-PLEX® surge suppression receptacles with lights, 80 joules/6500A per mode.	Blue	-	HBL420HS
	Ivory	-	HBL420HIS
	Red	-	HBL420HRS

Note: See page Tech-10 for Tamper-Resistant description.

4-PLEX® Accessories

Description	Color	Catalog Number
4-PLEX Adapter Plates for 1- and 2-gang, and 4 in. (101.6) square device boxes.	Blue	HBL4APBL
	Ivory	HBL4API
	Red	HBL4APR
4-PLEX Portable Box. Portable 4 in. (101.6) square box with cord grip. Accepts up to .66 in. (16.8) diameter cord.	Ivory	HBL4PBI

Note: 4-PLEX Box is not UL Listed.

Metallic Power Strip Surge Protected



Description	Catalog Number
15A 125V power strip with filtering, surge protection, 3 hospital grade duplex receptacles, 6 foot power supply cord and hospital grade plug.	HBL6PSHG

Note: See section M for additional information on surge protection products.

Wallplates (Sold Separately)

Configuration	High-Impact Nylon			Plated Steel		Stainless Steel (S/S) Brass	
	Color	Standard	Mid-Size	Chrome Brass Plated	SCH26 SBP26	Smooth S/S Smooth S/S Smooth Brass	SS26 SSJ26 SB26
1-Gang	Almond	NP26AL	NPJ26AL				
	Blue	-	NPJ26CBL*				
	Blue	-	NPJ26BL				
	Gray	NP26GY	NPJ26GY				
	Ivory	-	NPJ26C*				
	Ivory	NP26I	NPJ26I				
	Off. White	NP26OW	NPJ26OW				
	Orange	NP26OIG**	-				
	Red	NP26R	NPJ26R				
	White	NP26W	NPJ26W				

Note: \*Premarked "COMPUTER ONLY." Lettering is block ¼" high.  
 \*\*Premarked "ISOLATED GROUND." Lettering is block ¼" high.  
 ▲ Jumbo size plate.  
 See page A-60 for technical information on 4-PLEX devices.



# Hospital Products

## Hubbellok® Plugs, Connector Bodies and Receptacles

20 Ampere, 125 Volts AC only, 2 Pole, 3 Wire Grounding

### For Hospital Use Only



### Hubbellok® Plugs and Connector Bodies

Description	Plugs	Connector Bodies
Nylon cover, thermoset interior.	<b>HBL23014HGB</b>	<b>HBL23001HGB</b>
Armored, epoxy filled, rubber cord grip.	<b>HBL23004HG</b>	-

Note: Cord clamp range for plug and connector .300" to .660" (7.6 to 16.8).



20A 125V AC



20A 125V AC



**HBL23014HGB**

### Receptacles

Description	Catalog Number
Black, back wired.	- <b>HBL23000HG</b>



**HBL23001HGB**

### Wallplates

Description	Catalog Number
Stainless steel 302/304, single-gang.	<b>HBL23901HG</b>
Stainless steel 302/304, three-gang for two receptacles.	<b>HBL23909HG</b>

Note: Suffix HG or HGB type for hospital use only.



**IP30**  
SUITABILITY

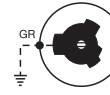

20A 125V AC

### Explosion Proof Plug

Description	Catalog Number
Plug, with, epoxy kit, accepts #12 or #14 type SO cable.	<b>HBL24312</b>

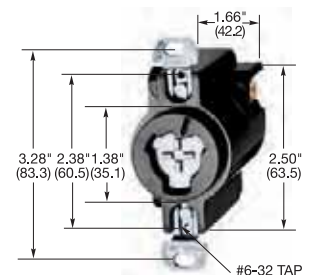

**HBL23000HG**

### Hazardous to Non-hazardous Location Receptacle Conversion Kits

Conversion kits for replacement of explosion proof receptacles listed above, with non-explosion proof receptacles, in the hospital areas formerly classified as hazardous locations and now classified non-hazardous locations due to the change from flammable anesthetizing gases to nonflammable anesthetizing gases.

For Conversion To:	Catalog Number
20A, 125V, duplex receptacle (Hubbell HBL830 Series). Includes adapter ring and stainless steel wall plate for duplex receptacle (receptacle not included).	<b>HBL24300RKD</b>
20A, 125V, Hospital Hubbellok receptacle (Hubbell HBL23000HG) or 20A, 125V, straight blade single receptacle (Hubbell HBL8310 series). Includes adapter ring and stainless wall plate for single receptacle (receptacle not included).	<b>HBL24300RKS</b>

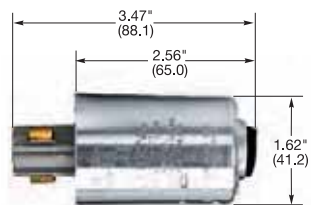

**HBL24312**

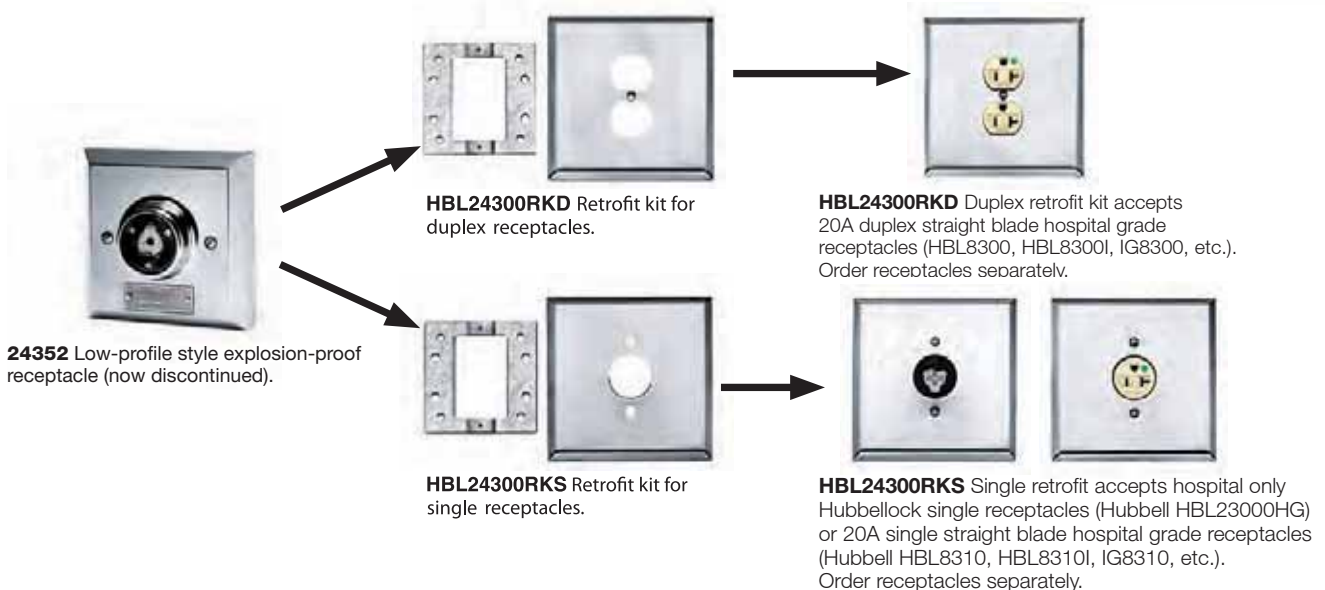

Dimensions in Inches (mm)



**HBL25515**



**HBL25615**

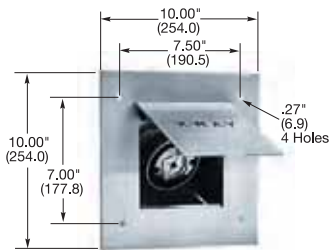

**HBL25605**

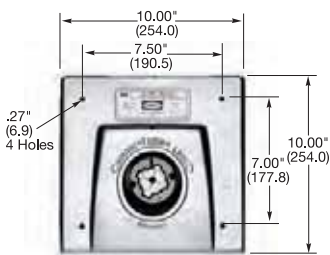

**HBL25603**

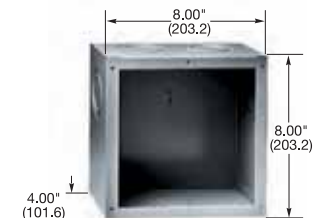

**HBL25509**

**IP30**  
 SUITABILITY



**50A 250V AC**



**60A 250V AC**

### Mobile X-Ray Plugs

Description	Catalog Number	
Plug, with epoxy kit, less cord clamp.	<b>HBL25515</b>	<b>HBL25615</b>
Plug, with cord clamp, less epoxy kit.	<b>HBL25525</b>	<b>HBL25625</b>

*Note: Cord clamp range of plugs with cord clamps .830" to 1.3" (21.1 to 33.0).  
 50A plugs fit 50A or 60A receptacles.*

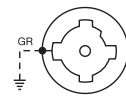

**50A 250V AC**

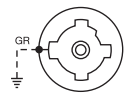

**60A 250V AC**

### Mobile X-Ray Receptacles

Description	Catalog Number	
Receptacle with stainless steel plate assembly.	<b>HBL25505</b>	<b>HBL25605</b>
Receptacle with cast aluminum plate assembly.	<b>HBL25503</b>	<b>HBL25603</b>
Replacement receptacle interior.	-	<b>IN16494</b>

### Accessory

Description	Catalog Number
Box stamped steel 8" x 8" x 4" (203.2 x 203.2 x 101.6), accommodates 50A and 60A mobile X-ray receptacles. Knockout sizes 1/4", 1/2" and 2".	<b>HBL25509</b>

Dimensions in Inches (mm)



HBL8200GY

**HBL® Extra Heavy Duty, Straight Blade  
Hospital Grade Duplex Receptacles**

**Specifications**

Receptacles	Part	Description
Typical Specification – Catalog No. HBL8200	Receptacle	15A
Manufacturer’s Identification – Hubbell HBL8200	Top	PBT*
Description – Hospital Grade, Straight Blade Duplex Receptacle	Base	RTP**
Type – 2 Pole, 3 Wire, Grounding	By-Pass Power Contacts	.037 in. (.9) Brass – Nickel Finish
Rating – 15A, 125V	Clamping Plate	.031 in. (.8) Brass – Nickel Finish
Certification: UL Listed to UL 498 File E2186, Fed. Spec. WC596,	Mounting Strap	.050 in. (1.3) Brass – Nickel Finish
Hospital Grade, NEMA® WD-6 Compliant	Line Terminal Screws	#10-32 Silicone Bronze, Multiple Drive
Certified to CSA, C22.2, No. 42 File 285	Hex Head Grounding Screw	#10-32 (Green) Silicon Bronze, Multiple Drive
	Center Assembly Rivet	Silicon Bronze
	Automatic Self-Grounding Clip	Stainless Steel
	Flat Head Mounting Screws	Stainless Steel

**Performance**

Electrical	
Dielectric Voltage	Withstands 2,000V minimum.
Max. Working Voltage	125V or 250V as rated.
Current Interrupting	Certified for current interrupting at full rated current.
Temperature Rise	Max 30°C temperature rise at full rated current after 50 cycles of overload at 150% of rated current at a power factor of 75%.
Mechanical	
Terminal Identification	Terminals identified in accordance with UL 498 and CSA (Brass, White, Green).
Terminal Accommodation	#14-10 AWG stranded or solid copper conductor only.
Product Identification	Ratings are a permanent part of the device.
Environmental – Material	
Flammability	UL 94V-0 and UL 94-5 VA.
Operating Temperature	Maximum continuous 75°C; minimum -40°C (w/o impact).

Note: \*Polybutylene Terephthalate.

\*\*Reinforced Thermoplastic Polyester.

NEMA® is a registered trademark of the National Electrical Manufacturers Association.

**SNAPConnect® Straight Blade  
 Hospital Grade Duplex Receptacles**



SNAP8200WA



SNAP2182A

**Specifications**

Receptacle	Part	Description
Typical Specification – Catalog No. SNAP8200	Receptacle	15A
Manufacturer's Identification – Hubbell SNAP8200	Top	Nylon
Description – Straight Blade Duplex Receptacle	Base	Nylon
Type – 2 Pole, 3 Wire, Grounding	Triple Wipe Power Contacts	Brass
Rating – 15A, 125V	Mounting Strap	Galvanized Steel; Brass (HG)
Certification – UL Listed to UL 498	Automatic Self-Grounding Clip	Stainless Steel
Fed. Spec. WC596, Certified to CSA 22.2, No. 42	Flat Head Mounting Screws	Steel-Zinc Plated/Self Tapping

  

Connector	Contact	Connector Body	Wire
SNAP1RA	Brass	Clear Polycarbonate	6" Solid copper #12 AWG THHN/THWN-2 600V, T90 Nylon FT-1, PVC 90°C (min).
SNAP2RA	Brass	Clear Polycarbonate	6" Stranded copper #12 AWG THHN/THWN-2 600V, T90 Nylon FT-1, PVC 90°C (min).

**Performance**

Electrical	
Dielectric Voltage	Withstands 2,000V minimum.
Max. Working Voltage	125V as rated.
Current Interrupting	Receptacle certified for current interrupting at full rated current with equivalently rated NEMA® plug.
Temperature Rise	Max 30°C temperature rise at full rated current after 50 cycles of overload at 150% of rated DC current.
Mechanical	
Terminal Wire Leads Identification	Terminal wire leads identified in accordance with UL 498 (Black, White, Green).
Product Identification	Ratings are a permanent part of the device.
Environmental – Material	
Flammability	UL 94V-2.
Operating Temperature	Maximum continuous 75°C; minimum -40°C (without impact).

**Dimensions**

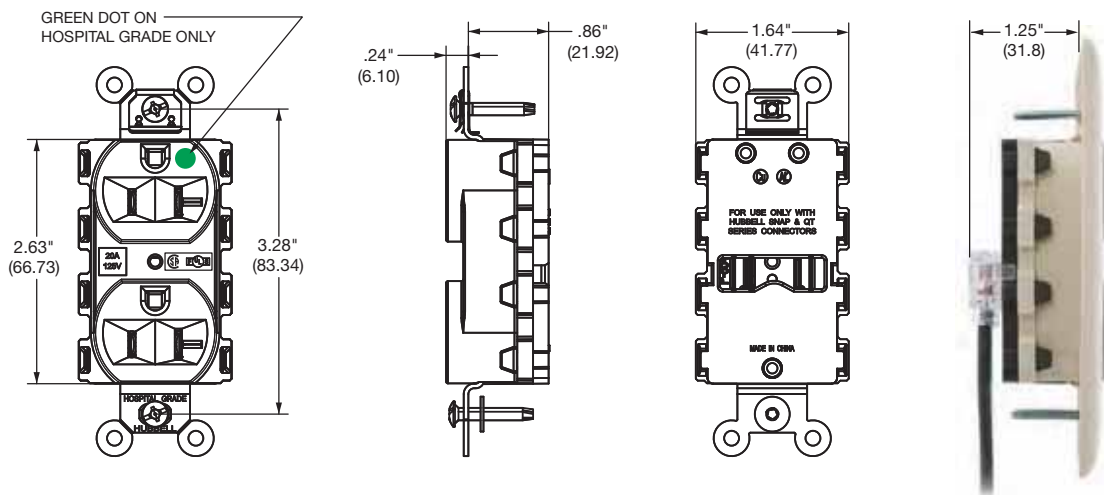

NEMA® is a registered trademark of the National Electrical Manufacturers Association.



**Hubbell-PRO Heavy Duty, Straight Blade  
Hospital Grade Duplex Receptacles**

**Specifications**

Receptacle	Part	Description
Typical Specification - Catalog No. 8200	Receptacle	15A
Manufacturer's Identification - Hubbell-Pro 8200	Top	Nylon
Description - Straight Blade Hospital Grade Duplex Receptacle	Base	Nylon
Type - 2 Pole, 3 Wire, Grounding	Triple Wipe Power Contacts	.0295" Brass
Rating - 15A, 125V	Clamping Plate	Plated Steel
Certification - UL listed to UL 498, Fed Spec WC596	Mounting Strap	.040" Galvanized Steel
Hospital Grade, NEMA® WD-6 Compliant	Terminal Screws	Plated Steel
Certified to CSA	Hex Head Grounding Screw	Plated Steel
	Automatic Self-Grounding Staple	Stainless Steel
	Mounting Screws	Zinc Plated Steel

**Performance**

Electrical	
Dielectric Voltage	Withstands 2,000V minimum.
Max. Working Voltage	125V.
Current Interrupting	Certified for current interrupting at full rated current.
Temperature Rise	Max 30°C temperature rise at full rated current after 50 cycles of overload at 150% of rated current at a power factor of 75%.
Mechanical	
Terminal Identification	Terminals identified in accordance with UL 498 and CSA (Brass, White, Green)
Terminal Accommodation	#14-10 AWG stranded or solid copper conductor only.
Product Identification	Ratings are a permanent part of the device.
Environmental – Material	
Flammability	UL 94V-2.
Operating Temperature	Maximum continuous 75°C; minimum -40°C (w/o impact).



USB8300R

**USB Charger Tamper-Resistant, Straight Blade  
Hospital Grade Duplex Receptacles**

**Specifications**

USB Charger Receptacle	Part	Description
Typical Specification - Catalog No. USB8300	Charger Receptacle	USB 3 Amp 5VDC, Electrical 15A or 20A 125V
Manufacturer's Identification - Hubbell USB8300		
USB Charger	Ports	Type A, 2.0
	LED	Green Indicator
Receptacle	Top	Nylon
Description - Hospital Grade, Straight Blade Duplex Receptacle	Base	Nylon
Type - 2 Pole, 3 Wire, Grounding	Triple Wipe Power Contacts	.030" Cooper Alloy
Rating - 15A, 125V	Clamping Plate	Plated Steel
	Mounting Strap	.040" Galvanized Steel
Certification - cULus listed to UL498 and UL1310	Terminal Screws	Plated Steel
Hospital Grade, NEMA® WD-6 Compliant (USB8200 and 8300 series only)	Hex Head Grounding Screw	Plated Steel
Complies with battery charging specification USB BC 1.2	Automatic Self-Grounding Staple	Stainless Steel
Complies with Part 15 of the FCC rules	Mounting Screws	Zinc Plated Steel
Compatible with SUB 1.1/2.0/3.0 devices, including Apple products		

**Performance**

Electrical	
Dielectric Voltage	Withstands 2,000V minimum.
Max. Working Voltage	125V.
Current Interrupting	Certified for current interrupting at full rated current.
Temperature Rise	Max 30°C temperature rise at full rated current after 50 cycles of overload at 150% of rated current at a power factor of 75%.
Mechanical	
USB Port	Stainless Steel Rated for 10,000 plug insertions and removal
Terminal Identification	Terminals identified in accordance with UL 498 and CSA (Brass, White, Green)
Terminal Accommodation	#14-10 AWG stranded or solid copper conductor only.
Product Identification	Ratings are a permanent part of the device.
Circuit Feed-Through	20 Amp 125 Volt
Environmental - Material	
Flammability	UL 94V-2.
Operating Temperature	Maximum continuous 75°C; minimum -40°C (w/o impact).

NEMA® is a registered trademark of the National Electrical Manufacturers Association.



HBL8215C



HBL8219C

**Insulgrip® Plugs and Connectors  
Hospital Grade**

**Specifications**

Plug	Part	Description
Typical Specification—Catalog No. HBL8215C	Plug	15A
Manufacturer's Identification—Hubbell HBL8215C Plug	Housing	Nylon— Black
Description—Hospital Grade Straight Blade Plug	Blade Holder	Nylon— Natural
Type—2 Pole, 3 Wire Grounding	Retainer	Polycarbonate—Clear
Rating— 15A, 125V	Cord Clamp	Nylon—Natural
Certification—UL Listed, CSA Certified	Contact Blades	.06" (1.5) Brass
UL Verified to Fed. Spec. WC596	Ground Contact Blade	.04" (1.0) Brass
IP Suitability—IP20	Line Terminal Screws	#8-32 Brass, Multiple Drive
	Ground Screw	#8-32 Brass, Multiple Drive (Green)
	Wire Clamps	.08" (2.0) Steel—Nickel Finish
Connector	Part	Description
Typical Specification—Catalog No. HBL8219	Connector	15A
Manufacturer's Identification—Hubbell HBL8219C Connector	Housing	Nylon—Black
Description—Hospital Grade Straight Blade Connector Body	Contact Holder	Nylon— Natural
Type—2 Pole, 3 Wire Grounding	Retainer	Polycarbonate—Clear
Rating—15A, 125V	Cord Clamp	Nylon—Natural
Certification—UL Listed, CSA Certified	Contacts	.04" (1.0) Copper Alloy
UL Verified to Fed. Spec. WC596	Line Terminal Screws	#8-32 Brass, Multiple Drive
IP Suitability—IP20	Ground Screw	#8-32 Brass, Multiple Drive (Green)
	Wire Clamps	.08" (2.0) Steel—Nickel Finish

**Performance**

Electrical	
Dielectric Voltage	Withstands 2000V AC minimum.
Max. Working Voltage	125V or 250V as rated.
Current Interrupting	Certified for current interrupting at full rated current.
Temperature Rise	Max 30°C temperature rise at full rated current after 100 cycles of overload at 150% of rated voltage DC.
Mechanical	
Terminal Identification	Terminals identified in accordance with UL and CSA (Brass, White, and Green).
Terminal Accommodation	#18-10 AWG.
Product Identification	Ratings are a permanent part of the device.
Torque Range	Cord clamp/terminal screws 9 to 12 in-lbs.
Cord Diameter Range	.230"-.720" (5.8-18.3) Integral cord grip.
Environmental-Material	
Flammability	UL 94HB or better.
Operating Temperature	Maximum continuous 75°C, minimum -40°C (w/o impact)

*Note: Please consult the factory for product dimensions and specifications for other products listed in this catalog.*



HBL8115V



HBL8119V

**Valise® Plugs and Connectors  
 Hospital Grade**

**Specifications**

Plug	Part	Description
Typical Specification—Catalog No. HBL8115V	Plug	15A
Manufacturer's Identification—Hubbell HBL8115V Plug	Housing	Nylon
Description—Hospital Grade Straight Body Plug	Contact Blades	Brass
Type—2 Pole, 3 Wire, Grounding	Ground Blade	Brass
Rating—15A, 125V	Terminal Screws	Multiple Drive
Certifications—UL Listed to UL498	Cable Inserts	Polyphenylene Oxide
File E1706, CSA Certified to C22.2	Terminal Clamps	Plated CR Steel
No. 42 File LR280, Fed. Spec. WC596	Body Holding Screws	Multiple Drive
IP Suitability—IP20		
Connector	Part	Description
Typical Specification—Catalog No. HBL8119V	Connector	15A
Manufacturer's Identifications—Hubbell HBL8119V Connector Body	Housing	Nylon
Description—Hospital Grade Straight Connector Body	Contact and Ground Spring	Brass
Type—2 Pole, 3 Wire, Grounding	Terminal Screws	Multiple Drive
Rating—15A, 125V	Cable Inserts	Polyphenylene Oxide
Certifications—UL Listed to UL498	Terminal Clamps	Plated CR Steel
File E1706, CSA Certified to C22.2	Body Holding Screws	Multiple Drive
No. 42 File LR280, Fed. Spec. WC596		
IP Suitability—IP20		

**Performance**

Electrical	
Dielectric Voltage	Withstands 2000V AC minimum.
Max. Working Voltage	125V or 250V as rated.
Current Interrupting	Certified for current Interrupting at full rated current.
Temperature Rise	Max. 30°C temperature rise at full rated current.
Mechanical	
Terminal Identification	Terminals identified in accordance with UL and CSA (Brass, White, and Green)
Terminal Accommodation	#16 to #12 AWG.
Product Identification	Ratings are a permanent part of the device.
Torque	Terminal screws 12 in.-lbs. Cord clamp screws 7 to 10 in.-lbs.
Cord Diameter Range	.300" to .660" (7.6 to 16.8)
Environmental-Material	
Flammability	UL 94HB
Operating Temperature	Maximum continuous 75°C, minimum -40°C (w/o impact).
Standards	
NEMA Configurations WD6.	
Listed to UL Standard UL498 and UL Verified to Ped. Spec. WC596.	
Certified to CSA Standard C22.2 No. 42.	



# Section M SpikeShield® Power Quality Products

## Index

Product	Page
Surge Protection Devices (SPDs) Introduction . . . . .	M-2
<b>Service/Branch Panel Protection</b>	
320kA and 160kA Service/Branch Panel Protection . . . . .	M-4
120kA Service/Branch Panel Protection . . . . .	M-5
Wired-In Branch Panel Protection . . . . .	M-6
Wired-In Surge Arrestors and Protective Devices . . . . .	M-7
Surge Protection Plug Strips . . . . .	M-9
Surge Protection Receptacles . . . . .	M-11
SNAPConnect® Tamper-Resistant Surge Protection Receptacles . . . . .	M-13
Technical Information . . . . .	M-19
Isolated Ground Receptacles	Page
SNAPConnect® Isolated Ground Receptacles . . . . .	M-13
Straight Blade Isolated Ground Receptacles . . . . .	M-15
Isolated Ground Twist-Lock® Receptacles . . . . .	M-18
Technical Information . . . . .	M-20

Surge Protection Panels & Wired-In Branch Panels



SpikeShield® Surge Suppression Plug Strips



SNAPConnect® Surge and Isolated Ground Receptacles



Surge Suppression & Isolated Ground Receptacles



# SpikeShield® Power Quality Products Surge Protection Devices (SPDs) Introduction

## Panel Protection

The SpikeShield® line of panel surge protection devices offers a broad selection of products to meet the various requirements of industrial, commercial, institutional and residential applications. No other surge suppression system can meet the flexibility, safety and performance standards set by Hubbell.

Hubbell offers surge protection products which can handle peak amperage capacities of 50kA to 320kA.

The SpikeShield product line also includes a line of panels with replaceable modules. This series features improved performance through the use of a low impedance bus-bar design and easily replaceable bolt-down modules.

The SpikeShield branch panel protection system includes the complete compact and economical 50, 80, 100 and 120kA series product offering.

These wired-in products can protect branch panels, safety switches and load centers. They can be installed as an appendage or flush mounted to a finished wall next to the panel. The versatility of the wired-in products allows them to be used on branch panels, as well as main panel protection in smaller commercial facilities.



SpikeShield® Power Quality Products  
**320kA, 160kA and 120kA Service/Branch Panel Protection**  
*Features and Benefits*



Features	Benefits
Thermal fusing	Thermal fuse prevents the MOVs from overheating when exposed to high current levels.
Compact design with bus-bar pathways	Allows installation in areas with space restrictions. Minimizes connecting lead length which reduces impedance ensuring improved clamping performance.
Peak amp capacity	Protects equipment under the worst electrical conditions.
Bolt-down modules	Assures positive connection and allows for easy replacement.
Fault-current fusing	Prevents excessive panel damage caused by internal short circuits or component failure.
LED and audible alarm status indicator	Provides visual and audible indication of panel status. Green for operational, red for module failure. Audible alarm for module failure with silencing.
Sine wave tracking	Provides uniform clamping throughout the sine wave.

*Note: All panel products are UL Listed to Standard 1449-3rd edition.*

SpikeShield® Power Quality Products  
**320kA and 160kA Service/Branch Panel Protection**  
*Ordering Information and Specifications*



The SpikeShield® service entrance product line includes a line of panels with replaceable modules. This series features improved performance through the use of a low impedance bus-bar design and easily replaceable bolt-down modules.

They incorporate a modular (replaceable surge suppression modules) design and feature the latest industry approvals and safety ratings. Including UL 1449-3rd edition.



HBL4P320A



HBL8P160DA

**Service/Branch Panel Protection 320,000 Peak Amp Capacity (Type 2 SPD)**

Voltage V AC	Configuration	Catalog Number	With Disconnect	Replacement Module
120/240 Single phase	1Ph. 3-wire +G	HBL3P320A	HBL3P320DA	HBL160M120A
120/208 Wye*	3Ph. Wye 4-wire +G	HBL4P320A	HBL4P320DA	HBL160M120A
240/120 Delta split phase	3Ph. Delta 4-wire +G 'High Leg'	HBL6P320A	HBL6P320DA	HBL160M240A & HBL160M120A
277/480 Wye**	3Ph. Wye 4-wire +G	HBL8P320A	HBL8P320DA	HBL160M480A
347/600 Wye	3Ph. Wye 4-wire +G	HBL10P320A	HBL10P320DA	HBL160M600A

**Service/Branch Panel Protection 160,000 Peak Amp Capacity (Type 2 SPD)**

Voltage V AC	Configuration	Catalog Number	With Disconnect	Replacement Module
120/240 Single phase	1Ph. 3-wire +G	HBL3P160A	HBL3P160DA	HBL160M120A
120/208 Wye*	3Ph. Wye 4-wire +G	HBL4P160A	HBL4P160DA	HBL160M120A
240/120 Delta split phase	3Ph. Delta 4-wire +G 'High Leg'	HBL6P160A	HBL6P160DA	HBL160M240A & HBL160M120A
277/480 Wye**	3Ph. Wye 4-wire +G	HBL8P160A	HBL8P160DA	HBL160M480A
347/600 Wye	3Ph. Wye 4-wire +G	HBL10P160A	HBL10P160DA	HBL160M600A

Note: Units come standard with Surge Counter.

\*120/208 Wye also applies to 127/220 Wye.

\*\*277/480 Wye also applies to 220/380 Wye, 230/400 Wye and 240/415 Wye.

**Electrical Specifications**

Catalog Number	SCCR $\diamond$	$I_n$	MCOV $\dagger$	Voltage Protection Rating (VPR)				
				L-N	L-G	N-G	L-L	
HBL3P320A	HBL3P160A	200kA	20kA	150/300	700	700	700	1200
HBL4P320A	HBL4P160A	200kA	20kA	150/300	700	700	700	1200
HBL6P320A	HBL6P160A	200kA	20kA	270/150	1200/700	1200/700	700	1500/1000
HBL8P320A	HBL8P160A	200kA	20kA	320/640	1200	1200	1200	1200
HBL10P320A	HBL10P160A	200kA	20kA	420/840	1500	1500	1500	2500

Note:  $\diamond$  SCCR - Short Circuit Current Rating.

$\dagger$  MCOV - Maximum Continuous Operating Voltage.

$I_n$  - Nominal discharge current.

**Product Specifications**

Max. Surge Current per Phase:	320kA and 160kA
Max. Operating Temperature:	-40°F to 149°F (-40°C to 65°C)
Diagnostics:	Red & Green LED's, Diagnostic Test Switches, Dry Contacts, Audible Alarm, Surge Counter
Dimensions (Wye):	6.0"D x 20.0"W x 24.0"L (with Disconnect); 6.0"D x 12.0"W x 12.0"L (without Disconnect)
Dimensions (Delta):	6.0"D x 16.0"W x 20.0"L (with Disconnect); 7.0"D x 14.0"W x 16.0"L (without Disconnect),
Weight (320kA):	54 lbs. (without Disconnect), 57.5 lbs. (with Disconnect)
Weight (160kA):	21.9 lbs. (without Disconnect), 21.8lbs. (with Disconnect)
Terminal Accommodation:	#10 AWG to #2 AWG
Frequency:	50/60 Hz
EMI/RFI:	Up to -30dB
NEMA:	3R/12 Metallic
Listing:	cULus UL1449-3rd edition type 2 SPD, UL1283, CSA C22.2 NO. 8-M1986
Warranty:	10 year

The SpikeShield® 120kA branch panel product offering features an economical, compact, modular design.

These wired-in products can protect branch panels, safety switches and load centers. They can be installed as an appendage or flush mounted to a finished wall next to the panel. The versatility of the wired-in products allows them to be used on branch panels, as well as main panel protection found in smaller commercial facilities or residential applications.



HBL8P120B

### Service/Branch Panel Protection 120,000 Peak Amp Capacity (Type 2 SPD)

Voltage V AC	Configuration	Catalog Number	Replacement Module
120/240 Single Phase	1Ph. 3-wire +G	<b>HBL3P120B</b>	<b>HBL3P120BM</b>
120/208 Wye*	3Ph. Wye 4-wire +G	<b>HBL4P120B</b>	<b>HBL4P120BM</b>
240/120 Delta split phase	3Ph. Delta 4-wire +G 'High Leg'	<b>HBL6P120B</b>	<b>HBL6P120BM</b>
277/480 Wye**	3Ph. Wye 4-wire +G	<b>HBL8P120B</b>	<b>HBL8P120BM</b>
347/600 Wye	3Ph. Wye 4-wire +G	<b>HBL10P120B</b>	<b>HBL10P120BM</b>

Note: Units come standard with Surge Counter.

\*120/208 Wye also applies to 127/220 Wye.

\*\*277/480 Wye also applies to 220/380 Wye, 230/400 Wye and 240/415 Wye.

### Electrical Specifications

Catalog Number	SCCR $\diamond$	$I_n$	MCOV $\dagger$	Voltage Protection Rating (VPR)			
				L-N	L-G	N-G	L-L
<b>HBL3P120B</b>	200kA	20kA	150/270	700	700	700	1200
<b>HBL4P120B</b>	200kA	20kA	150/270	700	700	700	1200
<b>HBL6P120B</b>	200kA	20kA	275/150	1000/700	1000/700	700	1500/1200
<b>HBL8P120B</b>	200kA	20kA	320/640	1200	1200	1200	2000
<b>HBL10P120B</b>	200kA	20kA	390/780	1500	1500	1500	2500

Note:  $\diamond$  SCCR - Short Circuit Current Rating.

$\dagger$  MCOV - Maximum Continuous Operating Voltage.

$I_n$  - Nominal discharge current.

### Product Specifications

Max. Surge Current per Phase:	120kA
Max. Operating Temperature:	-40°F to 149°F (-40°C to 65°C)
Diagnostics:	Red & Green LED's, Diagnostic Test Switches, Dry Contacts, Audible Alarm, Surge Counter
Dimensions:	7.0"D x 14.0"W x 16.0"L
Weight:	21.8 lbs.
Terminal Accommodation:	#12 AWG to #2 AWG
Frequency:	50/60 Hz
EMI/RFI:	Up to -30dB
NEMA:	3R/12 Metallic
Listing:	cULus UL1449-3rd edition type 2 SPD, UL1283, CSA C22.2 NO. 8-M1986
Warranty:	10 year

# SpikeShield® Power Quality Products Wired-In Branch Panel Protection

100,000 Peak Amperage Capacity



The wired-in surge protection device brick design is ideal for areas where space is a major consideration. The surge unit can be mounted directly to the panel through a chase nipple connection which will reduce lead length and impedance while increasing protection levels.

The 100kA product features a NEMA 4X housing and a 200kA SCCR rating.

They SpikeShield wired-in surge protective devices are UL 1449-3rd edition listed.



HBL9W100C

## Wired-In Branch Panel Protection 100,000 Peak Amp Capacity (Type 2 SPD)

Service Voltage V AC	Configuration	Catalog Number
120/240 Single Phase	1Ph. 3-wire +G	HBL3W100C
120/208 Wye*	3Ph. Wye 4-wire +G	HBL4W100C
240 Delta	3Ph. Delta 3-wire Corner Gnd <sup>Δ</sup>	HBL5W100C
240/120 Delta split phase	3Ph. Delta 4-wire +G 'High Leg'	HBL6W100C
277/480 Wye**	3Ph. Wye 4-wire +G	HBL8W100C
480 Delta	3Ph. Delta 3-wire Corner Gnd <sup>Δ</sup>	HBL9W100C
347/600 Wye	3Ph. Wye 4-wire +G	HBL10W100C
600 Delta	3Ph. Delta 3-wire Corner Gnd <sup>Δ</sup>	HBL11W100C

Note: \*120/208 Wye also applies to 127/220 Wye.

\*\*277/480 Wye also applies to 220/380 Wye, 230/400 Wye and 240/415 Wye.

<sup>Δ</sup>Also can be used on ungrounded systems.

## Electrical Specifications

Catalog Number	SCCR <sup>◇</sup>	I <sub>n</sub>	MCOV <sup>†</sup>	Voltage Protection Rating (VPR)			
				L-N	L-G	N-G	L-L
HBL3W100C	200kA	20kA	150/270	900	1200	700	1500
HBL4W100C	200kA	20kA	150/270	900	1200	700	1500
HBL5W100C	200kA	20kA	300	N/A	N/A	N/A	1500
HBL6W100C	200kA	20kA	275/150	1000	1200	700	1500
HBL8W100C	200kA	20kA	320/640	1200	2000	1000	2500
HBL9W100C	200kA	20kA	640	N/A	N/A	N/A	3000
HBL10W100C	200kA	20kA	390/780	1500	2500	1500	3000
HBL11W100C	200kA	20kA	780	N/A	N/A	N/A	3000

Note: <sup>◇</sup> SCCR - Short Circuit Current Rating.

<sup>†</sup> MCOV - Maximum Continuous Operating Voltage.

I<sub>n</sub> - Nominal discharge current.

## Product Specifications

Max. Surge Current per Phase:	100kA
Max. Operating Temperature:	-40°F to 140°F (-40°C to 60°C)
Diagnostics:	Green Status LED's, Audible Alarm, Dry Contacts
Dimensions:	3.1"D x 9.9"W x 4.8"H
Weight:	4.78 lbs.
Terminal Accommodation:	#10 AWG 18.0" Wire Leads
Frequency:	50/60 Hz
EMI/RFI:	Up to -30dB
NEMA:	Type 4X
Listing:	cULus UL1449-3rd edition type 2 SPD, UL1283 (Wye prod. only), CSA C22.2 NO. 8-M1986
Warranty:	10 year

Surge Arrestors are a low cost solution that may be installed on the line side or load side of the service entrance. These are also excellent for OEM applications where size is an important variable.

Hubbell's 50kA single phase wired-in surge protective devices feature a compact design, NEMA 4X rating and are UL 1449-3rd edition listed.



**Wired-In Surge Arrestors, Single Phase 36,000 and Three Phase 40,000 (Type 1 / Type 2 SPD)**

Service Voltage V AC	Configuration	Peak Amp Capacity	Mounting Means	Catalog Number
120/240 Single Phase	1Ph. 3-wire	36kA	Back Nipple Mount	<b>HBLSDSA36</b>
347/600V Max Three Phase	3Ph. 4-wire	40kA	Back Nipple Mount	<b>HBLSDSA40</b>

**Wired-In Surge Protective Devices 50,000 Peak Amp Capacity (Type 1 SPD)**

Service Voltage V AC	Configuration	Peak Amp Capacity	Mounting Means	Catalog Number
120/240 Single Phase	1Ph. 3-wire + G	50kA	Side Nipple Mount	<b>HBL3W50</b>

**Electrical Specifications**

Catalog Number	SCCR ◊	I <sub>n</sub>	MCOV †	Voltage Protection Rating (VPR)			
				L-N	L-G	N-G	L-L
<b>HBLSDSA36</b>	25kA	10kA	150	700	N/A	N/A	1200
<b>HBLSDSA40</b>	200kA	10kA	750/1500	2500	N/A	N/A	4000
<b>HBL3W50</b>	25kA	10kA	150	700	800	N/A	1200
<b>HBL3W120</b>	25kA	10kA	150	700	800	N/A	1200

Note: ◊ SCCR - Short Circuit Current Rating.  
 † MCOV - Maximum Continuous Operating Voltage.  
 I<sub>n</sub> - Nominal discharge current.

**Product Specifications**

Max. Surge Current per Phase:	36kA	40kA	50kA
Max. Operating Temperature:	-40°F to 160°F (-40°C to 70°C)	-40°F to 160°F (-40°C to 70°C)	-40°F to 160°F (-40°C to 70°C)
Diagnostics:	Green Status LED per line	Green Status LED per line	Green Status LED per line
Dimensions:	1.9"D x 2.25"W x 2.25"H	2.64"D x 3.6"W x 3.0"H	2.7"D x 3.0"W x 3.6"H
Weight:	.72 lbs.	1.8 lbs.	1.8 lbs.
Terminal Accommodation:	#14 AWG Wire Leads	#12 AWG Wire Leads	#12 AWG Wire Leads
Frequency:	50/60 Hz	50/60 Hz	50/60 Hz
EMI/RFI:	Up to -30dB	Up to -30dB	Up to -30dB
NEMA:	Type 4X	Type 4X	Type 4X
Listing:	UL1449-3rd edition	UL1449-3rd edition	UL1449-3rd edition
Warranty:	2 year	2 year	10 year

# SPIKE SHIELD®

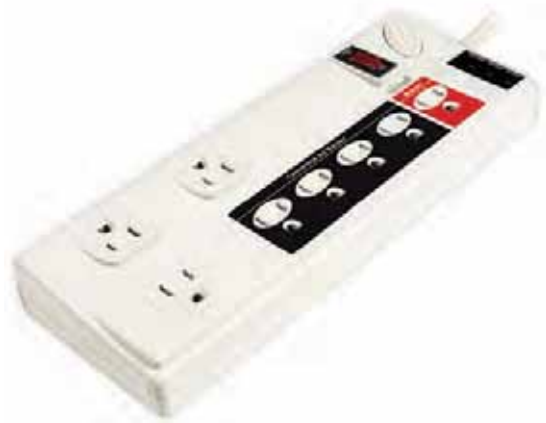

**HBL8ESPS1050M:** 1050 joule, 6 foot cord, energy saving unit with master/slave set up. Turns power off to peripherals when item plugged into master is powered off.



**HBL7PS1050A:** 1050 joule, 6 foot cord, \$5,000 down-line warranty, tamper-resistant shutters.



**HBL4PS1050USB:** Four outlet, 1050 joule SPD features a black housing, 6 foot cord, 90 degree plug, and two USB ports for charging smart phones and other electronic devices.



**HBL8PS350YL:** Yellow, high visibility, robust, metal housing, 350 joules, 6 foot cord, wire management feature, \$2,500 down-line warranty.



# SpikeShield® Power Quality Products Surge Protection Plug Strips

15 Ampere, 125 Volts 50/60Hz



## SpikeShield® Surge Protective Devices

### Plug-in Style Surge Outlets

Description	# of Outlets	Joule Rating	Peak AMP Rating	Cord Length	Color	Warranty	Catalog Number
Single outlet plug-in SPD	1	750	13.5kA	N/A	Off. White	N/A	<b>HBL1PI750</b>
Single outlet plug-in SPD w/phone line protection	1	750	13.5kA	N/A	Off. White	N/A	<b>HBL1PI750M</b>
Single outlet plug-in SPD w/CATV protection	1	750	13.5kA	N/A	Off. White	N/A	<b>HBL1PI750C</b>
Three outlet plug-in SPD	3	750	13.5kA	N/A	Off. White	N/A	<b>HBL3PI750</b>



## SpikeShield® Surge Protection Plug Strips



### Metallic Strips

Description	# of Outlets	Joule Rating	Peak AMP Rating	Cord Length	Color	Down Line Warranty	Catalog Number
Metal Power Strip (No surge protection)	6	N/A	N/A	6'	Off. White	N/A	<b>HBL6MPS</b>
Metal SPD	6	1050	19.5kA	6'	Off. White	\$2,500	<b>HBL6MPS1050</b>
SPD w/Wire Management	6	350	6.5kA	6'	Yellow	\$2,500	<b>HBL6PS350YL</b>
SPD w/Wire Management	8	350	6.5kA	6'	Yellow	\$2,500	<b>HBL8PS350YL</b>
Heavy Duty SPD w/HBL5252BK Receptacles	6	900	30kA	6'	Black	N/A	<b>HBL6PS</b>
Heavy Duty SPD w/HBL8200HW Receptacles	6	900	30kA	6'	Black	N/A	<b>HBL6PSHG</b>



### Tamper-Resistant Non-Metallic Strips



Description	# of Outlets	Joule Rating	Peak AMP Rating	Cord Length	Color	Down Line Warranty	Catalog Number
Power Strip (No surge protection)	6	N/A	N/A	6'	Off. White	N/A	<b>HBL6PPS</b>
SPD	6	350	6.5kA	6'	Off. White	\$2,500	<b>HBL6PS350A</b>
SPD	6	350	6.5kA	15'	Off. White	\$2,500	<b>HBL6PS35015A</b>
SPD	6	350	6.5kA	25'	Off. White	\$2,500	<b>HBL6PS35025A</b>
SPD w/Fax/Modem	6	1050	19.5kA	6'	Off. White	\$2,500	<b>HBL6PS1050MA</b>
SPD	7	1050	19.5kA	6'	Off. White	\$10,000	<b>HBL7PS1050A</b>
SPD w/Fax/Modem	7	1050	19.5kA	6'	Off. White	\$10,000	<b>HBL7PS1050MA</b>
SPD	7	1050	19.5kA	15'	Off. White	\$10,000	<b>HBL7PS105015A</b>
SPD w/Fax/Modem/CATV	8	2100	39kA	6'	Off. White	\$25,000	<b>HBL8PS2100MA</b>
SPD w/Fax/Modem/CATV/DSS	8	2100	39kA	6'	Off. White	\$25,000	<b>HBL8PS2100DA</b>



### Specialty Non-Metallic Surge Strips

Description	# of Outlets	Joule Rating	Peak AMP Rating	Cord Length	Color	Down Line Warranty	Catalog Number
SPD w/Two USB Ports	4	1050	19.5kA	6'	Black	\$10,000	<b>HBL4PS1050USB*</b>
Remote Switch SPD w/One Keychain Ring Control	6	2100	39kA	6'	Off. White	\$25,000	<b>HBL6RSPS2100</b>
Energy Saving SPD w/Master/Controlled Design w/Fax/Modem	8	1050	19.5kA	6'	Off. White	\$10,000	<b>HBL8ESPS1050M</b>
Energy Saving SPD Master/Controlled Design w/CATV Protection	8	1050	19.5kA	6'	Off. White	\$10,000	<b>HBL8ESPS1050C</b>

Note: See page Tech-10 for Tamper-Resistant description.  
\*With 90 Angle Plug.



# SpikeShield® Power Quality Products

## Surge Protection Receptacles

Features and Benefits

Meets UL Standards 1449 3rd Edition and 498; CSA Certified

Damage-alert alarm sounds when surge protection is no longer functioning and keeps sounding until the receptacle is replaced or muting screw is utilized

Muting screw allows damage-alert alarm to be silenced until device is replaced

Power-on indicator light verifies instantly that power is available at the receptacle and the suppression circuit is fully functional; light off means power has been interrupted; flashing light indicates surge protection circuitry has been damaged



Distinctive surge symbol provides quick visual identification of surge suppression receptacle. High-impact nylon face resists breakage

Fits standard wall box

Automatic self-grounding staple attached to bridge meets NEC® requirements

IG8362SA

*Note: The effectiveness of SPD devices diminishes with the increase in distance between the device and the equipment to be protected.*

### Surge Protection Receptacles

Hubbell has the broadest offering of SPD receptacles in the industry with technology that is unsurpassed. Inside Hubbell SPD receptacles are two 22mm square MOVs providing 240 joules of surge protection for each mode. The nylon component shield protects the printed circuit

board from moisture and contaminants. An all-glass PC board provides superior moisture immunity for longer life in humid environments. Conformal coating is provided on the printed circuit board for additional moisture immunity.

*NEC® is a registered trademark of the National Fire Protection Association (NFPA).*



15A 125V  
NEMA 5-15R  
UL CSA



20A 125V  
NEMA 5-20R  
UL CSA

### Circuit Guard®, Specification Grade Duplex Receptacles

Description	Color	Catalog Number	
Surge suppression receptacles with light, 240 joules/15000A per mode.	Blue	HBL5260SA	HBL5360SA
	Ivory	HBL5260ISA	HBL5360ISA
	Office White	HBL5260WSA	HBL5360WSA
	White	HBL5260WSA	HBL5360WSA
Surge suppression receptacles with light and alarm, 240 joules/15000A per mode.	Almond	HBL5262ALSA	HBL5362ALSA
	Blue	HBL5262SA	HBL5362SA
	Gray	HBL5262GYSA	HBL5362GYSA
	Ivory	HBL5262ISA	HBL5362ISA
	Office White	HBL5262WSA	HBL5362WSA
	White	HBL5262WSA	HBL5362WSA
Isolated ground, surge suppression receptacles with light and alarm, 240 joules/15000A per mode.	Blue	IG5262SA	IG5362SA
	Gray	IG5262GYSA	IG5362GYSA
	Ivory	IG5262ISA	IG5362ISA
	Office White	IG5262WSA	IG5362WSA
	Orange	IG5262OSA	IG5362OSA
	White	IG5262WSA	IG5362WSA
4-PLEX® surge suppression receptacles with lights. 80 joules/6500A per mode.	Blue	HBL415S	HBL420S
	Ivory	HBL415IS	HBL420IS

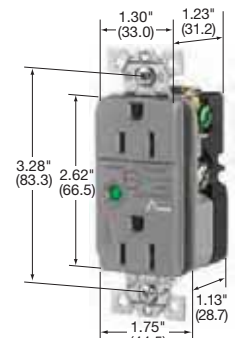

HBL5262GYSA

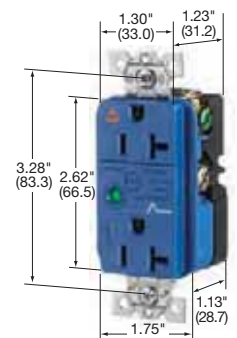

IG5362SA

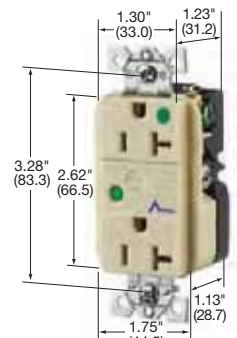

HBL8362ISA

### Circuit Guard®, Hospital Grade Duplex Receptacles

Description	Color	Catalog Number	
Surge suppression receptacles with light and alarm, 240 joules/15000A per mode.	Almond	HBL8262ALSA	HBL8362ALSA
	Blue	HBL8262SA	HBL8362SA
	Gray	HBL8262GYSA	HBL8362GYSA
	Ivory	HBL8262ISA	HBL8362ISA
	Red	HBL8262RSA	HBL8362RSA
	White	HBL8262WSA	HBL8362WSA
Isolated ground, surge suppression receptacles with light and alarm, 240 joules/15000A per mode.	Blue	IG8262SA	IG8362SA
	Gray	IG8262GYSA	IG8362GYSA
	Ivory	IG8262ISA	IG8362ISA
	Orange	IG8262OSA	IG8362OSA
	Red	IG8262RSA	IG8362RSA
	White	IG8262WSA	IG8362WSA
4-PLEX surge suppression receptacles with lights, 80 joules/6500A per mode.	Blue	—	HBL420HS
	Ivory	—	HBL420HIS
	Red	—	HBL420HRS

### 4-PLEX® Accessories

Description	Color	Catalog Number
4-PLEX adapter plates for 1- and 2-gang (4-PLEX mount directly to 4" (101.6) square device boxes).	Blue	HBL4APBL
	Ivory	HBL4API
	Red	HBL4APR
4-PLEX portable box. Portable 4" (101.6) square box with one cord grip. Accepts up to .66" (16.8) dia. cord.	Ivory	HBL4PBI

Note: 4-PLEX box is not UL Listed.

### Wallplates (Sold Separately)

Configuration	High-Impact Nylon			Plated Steel		Stainless Steel (S/S) Brass	
	Color	Standard	Mid-Size				
 1-Gang	Almond	NP26AL	NPJ26AL	Chrome Brass Plated	SCH26 SBP26	Smooth S/S Smooth S/S Smooth Brass	SS26 SSJ26 ▲ SB26
	Blue	—	NPJ26CBL*				
	Blue	—	NPJ26BL				
	Gray	NP26GY	NPJ26GY				
	Ivory	—	NPJ26C*				
	Ivory	NP26I	NPJ26I				
	Off. White	NP26OW	NPJ26OW				
	Orange	NP26OIG**	—				
	Red	NP26R	NPJ26R				
	White	NP26W	NPJ26W				

Note: \*Premarked "COMPUTER ONLY." Lettering is block ¼" high.  
\*\*Premarked "ISOLATED GROUND." Lettering is block ¼" high.  
▲ Jumbo size plate.  
See section N for additional wallplates.  
See page M-19 for technical information.

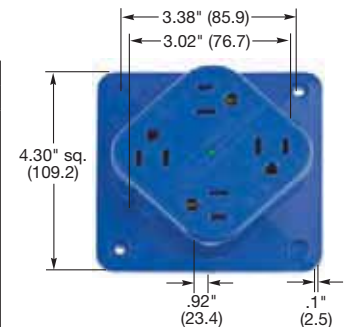

HBL415S

Dimensions in Inches (mm)

SpikeShield® Power Quality Products  
SNAPConnect® Surge Protection and Isolated Ground Receptacles  
Heavy Duty Specification Grade



**Surge Suppression Receptacles**

SpikeShield® SNAPConnect® tamper-resistant surge receptacles provide excellent point of use protection for sensitive electronic loads from every day power spikes and surges.



**Isolated Ground Receptacles**

SNAPConnect® Isolated Ground devices provide a clean ground path for sensitive equipment. Devices come with power indication, tamper-resistant or a combination of both.

**Immediate Benefits!**

**Project Timing**

- Save Time and Money
- Consistent Installation
- Meet Job Deadlines

**Installation Efficiency**

- No Stripping
- No Looping/No Tape
- No Exposed Terminals

**In-Use**

- Flush Appearance
- Simple Replacement
- Shallow Box Depth

# SpikeShield® Power Quality Products SNAPConnect® Surge Protection and Isolated Ground Receptacles Heavy Duty Specification Grade



## SNAPConnect® Tamper-Resistant Surge Protection Receptacle with Power Indicating LED

Description	Color	Catalog Number	
Hospital Grade ● SNAPConnect® Tamper-Resistant, surge suppression receptacle, smooth face, duplex.	Blue	SNAP8262S	SNAP8362S
	Gray	SNAP8262GYS	SNAP8362GYS
	Ivory	SNAP8262IS	SNAP8362IS
	Light Almond	SNAP8262LAS	SNAP8362LAS
	Red	SNAP8262RS	SNAP8362RS
	White	SNAP8262WS	SNAP8362WS
Commercial Grade SNAPConnect® Tamper-Resistant, surge suppression receptacle, smooth face, duplex.	Blue	SNAP5262S	SNAP5362S
	Gray	SNAP5262GYS	SNAP5362GYS
	Ivory	SNAP5262IS	SNAP5362IS
	Light Almond	SNAP5262LAS	SNAP5362LAS
	White	SNAP5262WS	SNAP5362WS

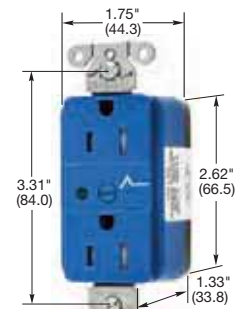

SNAP5262S

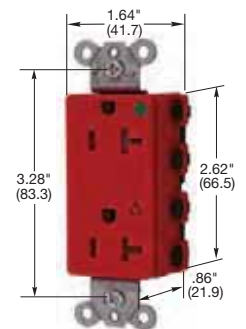

SNAP2182RIGTR

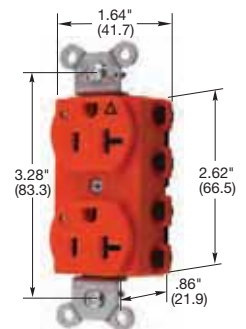

SNAP5362IGL

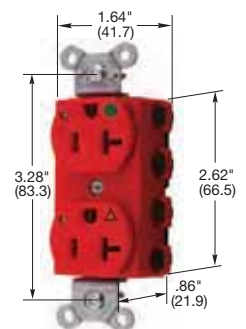

SNAP8300RIGLTR

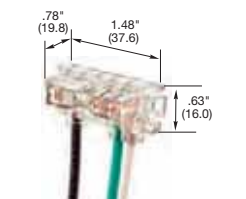

SNAP1RA

Dimensions in Inches (mm)

## SNAPConnect® Tamper-Resistant Isolated Ground Receptacle

Description	Color	Catalog Number	
Hospital Grade ● SNAPConnect® Tamper-Resistant, isolated ground, smooth face, duplex.	Orange	SNAP8200IGTR	SNAP8300IGTR
	Red	SNAP8200RIGTR	SNAP8300RIGTR
Hospital Grade ● Style Line® decorator SNAPConnect® Tamper-Resistant, isolated ground, smooth face, duplex.	Orange	SNAP2172IGTR	SNAP2182IGTR
	Red	SNAP2172RIGTR	SNAP2182RIGTR
Commercial Grade, isolated ground	Orange	SNAP5262IGTR	SNAP5362IGTR
Style Line® Decorator	Orange	SNAP2152IGTR	SNAP2162IGTR



## SNAPConnect® Isolated Ground Receptacle with Power Indicating LED

Description	Color	Catalog Number	
Hospital Grade ● SNAPConnect® Tamper-Resistant, isolated ground, smooth face, duplex.	Orange	SNAP8200IGL	SNAP8300IGL
	Red	SNAP8200RIGL	SNAP8300RIGL
Hospital Grade ● Style Line® decorator SNAPConnect® Tamper-Resistant, isolated ground, smooth face, duplex.	Orange	SNAP2172IGL	SNAP2182IGL
	Red	SNAP2172RIGL	SNAP2182RIGL
Commercial Grade, isolated ground	Orange	SNAP5262IGL	SNAP5362IGL
Style Line® Decorator	Orange	SNAP2152IGL	SNAP2162IGL



## SNAPConnect® Tamper-Resistant Isolated Ground Receptacle with Power Indicating LED

Description	Color	Catalog Number	
Hospital Grade ● SNAPConnect® Tamper-Resistant, isolated ground, smooth face, duplex.	Orange	SNAP8200IGLTR	SNAP8300IGLTR
	Red	SNAP8200RIGLTR	SNAP8300RIGLTR
Commercial Grade Style Line® decorator	Orange	SNAP2172IGLTR	SNAP2182IGLTR
	Red	SNAP2172RIGLTR	SNAP2182RIGLTR
Commercial Grade, isolated ground	Orange	SNAP5262IGLTR	SNAP5362IGLTR
Style Line® decorator	Orange	SNAP2152IGLTR	SNAP2162IGLTR



## SNAPConnect® Right Angle Pigtailed Connector for General Use

Description	Solid Wire	Stranded Wire
Clear right angle terminal with 6 inch leads #12 AWG THHN/THWN-2, 600V, Polycarbonate housing material	SNAP1RA	SNAP2RA

Note: See page Tech-10 for Power Indicating and Tamper-Resistant descriptions.  
See page M-19 for SNAPConnect® technical information.

# SpikeShield® Power Quality Products Straight Blade Isolated Ground Receptacles

Features and Benefits

Wrap-around, locked on brass mounting strap provides additional support strength for receptacle assembly

Green grounding screw connected directly to the grounding contacts

Insulation barrier construction — first patented by Hubbell — isolates ground contacts from the mounting strap

Back and side wiring capability provides easy installation with stranded or solid wire

Dimensionally stable, reinforced thermoplastic polyester provides impact strength in addition to heat and flame resistance

Automatic self-grounding clip assures ground continuity between mounting strap and metal wall box

Straight blade 15A and 20A, 125V duplex receptacles are available in a variety of colors

Amperage and voltage clearly indicated

Impact-resistant nylon face

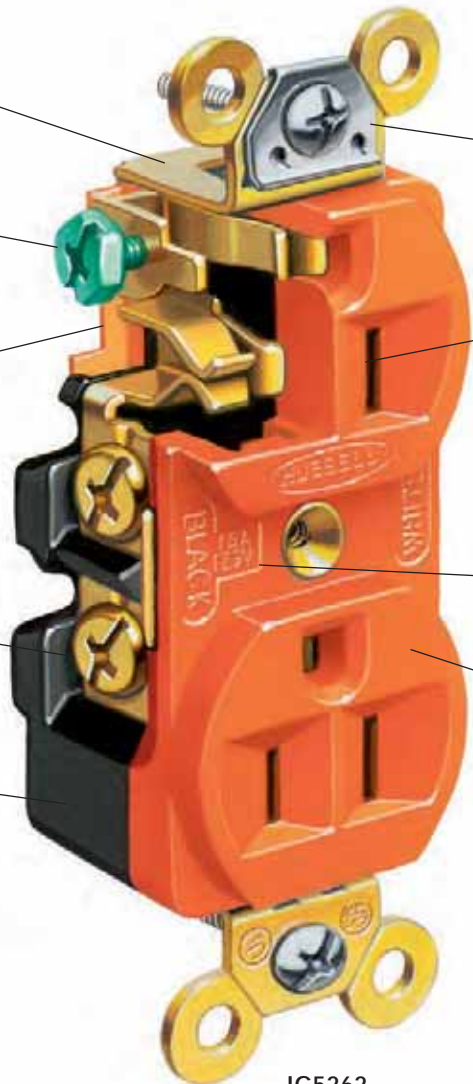

IG5262

## Isolated Ground Receptacles, A "Clean" Path Provides A "Clean" Ground For Sensitive Equipment

In February 1968, Hubbell patented the first isolated ground receptacle. Today — when a clean, noise-free ground is more important than ever — Hubbell is still setting the standard.

Hubbell uses insulation barrier construction on many models to isolate the ground contacts from the mounting strap. The green grounding screw is connected directly to the grounding contacts. In this way, ground contacts are separated from the mounting strap and also from the conventional grounding system. The isolated ground circuit is completed by running a dedicated insulated ground wire from the system ground buss to the green grounding screw.

And there's more to the Hubbell line:

- Available in 19 NEMA configurations and a total of 60 different type receptacles.
- Versatility and mobility: With Hubbell's grounding method, Hubbell's IG devices can be mounted in boxes, on metal panels...almost anywhere.
- Hubbell quality: Every Hubbell IG device meets and exceeds all applicable codes and standards, plus the toughest standard of all...the Hubbell standard of excellence.

IG triangle on the face of the receptacle clearly indicates isolated ground device.



SpikeShield® Power Quality Products  
**Straight Blade Isolated Ground Receptacles**  
 Ordering Information



**Hospital Grade**,  
**HBL® Extra Heavy Duty,**  
**Isolated Ground Receptacles**



**15A 125V**  
 NEMA 5-15R  
 UL CSA  
 0.5 HP



**20A 125V**  
 NEMA 5-20R  
 UL CSA  
 1 HP

Description	Color	Catalog Number	
Flush, thermoplastic polyester face, duplex, back and side wired, multiple drive screws.	Orange	<b>IG8200</b>	<b>IG8300</b>
	Red	<b>IG8200R</b>	<b>IG8300R</b>
Style Line® decorator.	Orange	—	<b>IG2182</b>
	Ivory	—	<b>IG2182I</b>
	White	—	<b>IG2182WA</b>
Flush, thermoplastic polyester face, single.	Orange	<b>IG8210</b>	<b>IG8310</b>

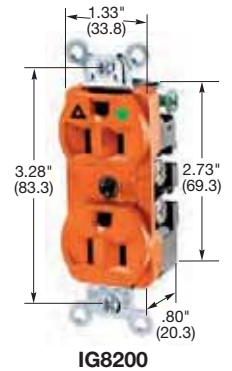

**15A and 20A, 125V**  
**HBL® Extra Heavy Duty,**  
**Specification Grade,**  
**Isolated Ground Receptacles**



**15A 125V**  
 NEMA 5-15R  
 UL CSA  
 0.5 HP



**20A 125V**  
 NEMA 5-20R  
 UL CSA  
 1 HP

Description	Color	Catalog Number	
Flush, nylon face, duplex, back and side wired, multiple drive screws.	Orange	<b>IG5262</b>	<b>IG5362</b>
	Gray	<b>IG5262GY</b>	<b>IG5362GY</b>
	Ivory	<b>IG5262I</b>	<b>IG5362I</b>
	Red	<b>IG5262R</b>	<b>IG5362R</b>
	White	—	<b>IG5362W</b>
Weather Resistant, duplex, isolated ground.	Orange	<b>IG5262WR</b>	<b>IG5362WR</b>
	Gray	<b>IG5262GYWR</b>	<b>IG5362GYWR</b>
	Ivory	<b>IG5262IWR</b>	<b>IG5362IWR</b>
	Red	<b>IG5262RWR</b>	<b>IG5362RWR</b>
	White	—	<b>IG5362WWR</b>
Finder groove, nylon face, duplex, back and side wired.	Orange	<b>CR5252IG</b>	<b>CR5352IG</b>
	Black	<b>CR5252IGBK</b>	<b>CR5352IGBK</b>
	Blue	—	<b>CR5352IGBL</b>
	Gray	<b>CR5252IGGY</b>	<b>CR5352IGGY</b>
	Ivory	<b>CR5252IGI</b>	<b>CR5352IGI</b>
	Office White	<b>CR5252IGOW</b>	<b>CR5352IGOW</b>
	White	<b>CR5252IGW</b>	<b>CR5352IGW</b>
Style Line® decorator, flush, nylon face, back and side wired.	Orange	<b>IG2152</b>	<b>IG2162</b>
	Gray	—	<b>IG2162GY</b>
4-PLEX® receptacle.	Orange	<b>IG415</b>	<b>IG420*</b>
Flush, nylon face, single, back and side wired.	Orange	<b>IG5261</b>	<b>IG5361</b>
Weather Resistant, single, isolated ground.	Orange	<b>IG5261WR</b>	<b>IG5361WR</b>

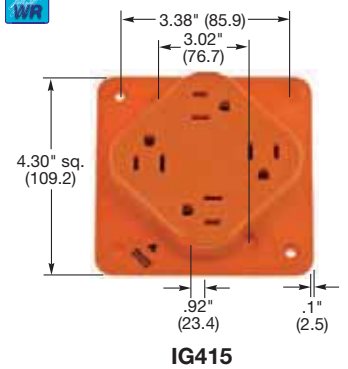
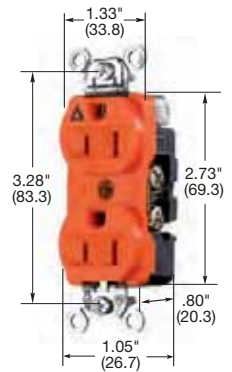
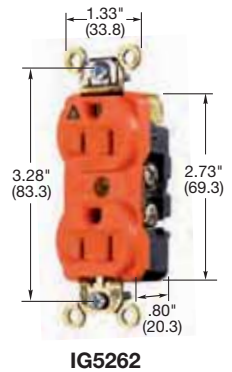

Dimensions in Inches (mm)

Note: \*Not Fed. Spec. Listed.  
 See page Tech-10 for Weather Resistant description.  
 See page M-20 for isolated ground technical information.  
 See page A-46 and A-47 for accessories.  
 See page A-23 for 4-PLEX accessories.

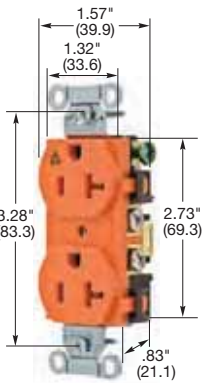

**IG5352**



**Hubbell-PRO Heavy Duty Specification Grade**

Description	Color	Catalog Number	
Smooth face, duplex, back and side wired.	Orange	<b>IG5252</b>	<b>IG5352</b>
	Almond	<b>IG5252AL</b>	<b>IG5352AL</b>
	Gray	<b>IG5252GY</b>	<b>IG5352GY</b>
	Ivory	<b>IG5252I</b>	<b>IG5352I</b>
	Light Almond	<b>IG5252LA</b>	<b>IG5352LA</b>
	White	<b>IG5252W</b>	<b>IG5352W</b>
Tamper-Resistant, smooth face, duplex, back and side wired.	Orange	<b>IG5252TR</b>	<b>IG5352TR</b>
	Ivory	<b>IG5252ITR</b>	<b>IG5352ITR</b>
	White	<b>IG5252WTR</b>	<b>IG5352WTR</b>



**15A 125V**  
**NEMA 5-15R**  
 UL CSA  
 0.5 HP



**20A 125V**  
**NEMA 5-20R**  
 UL CSA  
 1 HP

Note: See page Tech-10 for Tamper-Resistant description.

**Commercial Specification Grade**

Description	Color	Catalog Number	
Smooth face, duplex, side wired.	Orange	<b>IG15CR</b>	<b>IG20CR</b>
	Almond	<b>IG15CRAL</b>	<b>IG20CRAL</b>
	Gray	<b>IG15CRGRY</b>	<b>IG20CRGRY</b>
	Ivory	<b>IG15CRI</b>	<b>IG20CRI</b>
	Light Almond	<b>IG15CRLA</b>	<b>IG20CRLA</b>
	White	<b>IG15CRWHI</b>	<b>IG20CRWHI</b>
Style Line® decorator; smooth face; back and side wired.	Orange	<b>IG15DR</b>	<b>IG20DR</b>
	Almond	<b>IG15DRAL</b>	<b>IG20DRAL</b>
	Gray	<b>IG15DRGRY</b>	<b>IG20DRGRY</b>
	Ivory	<b>IG15DRI</b>	<b>IG20DRI</b>
	Light Almond	<b>IG15DRLA</b>	<b>IG20DRLA</b>
	White	<b>IG15DRWHI</b>	<b>IG20DRWHI</b>

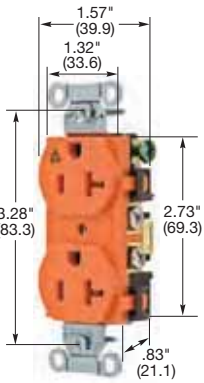

**IG20CR**

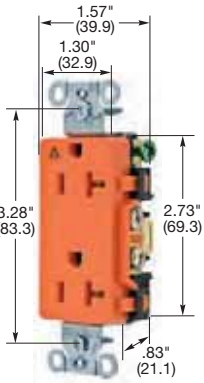

**IG20DR**

**15A and 20A, 250V HBL® Extra Heavy Duty, Specification Grade, Isolated Ground Receptacles**

Description	Color	Catalog Number	
Flush, nylon face, duplex, back and side wired, multiple drive screws.	Orange	<b>IG5662</b>	<b>IG5462</b>
Flush, nylon face, single.	Orange	<b>IG5661</b>	<b>IG5461</b>



**15A 250V**  
**NEMA 6-15R**  
 UL CSA  
 1.5 HP



**20A 250V**  
**NEMA 6-20R**  
 UL CSA  
 2 HP

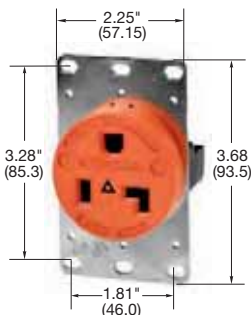

**IG9308**

**IP20**  
 SUITABILITY

**30A, 125V and 250V Isolated Ground Receptacles**

Description	Color	Catalog Number	
Single receptacle, 2 pole, 3 wire grounding.	Orange	<b>IG9308</b>	<b>IG9330</b>



**30A 125V**  
**NEMA 5-30R**  
 UL CSA  
 2 HP



**30A 250V**  
**NEMA 6-30R**  
 UL CSA  
 2 HP

Note: See page M-20 for isolated ground technical information.



# SpikeShield® Power Quality Products Isolated Ground Twist-Lock® Receptacles

Features and Benefits

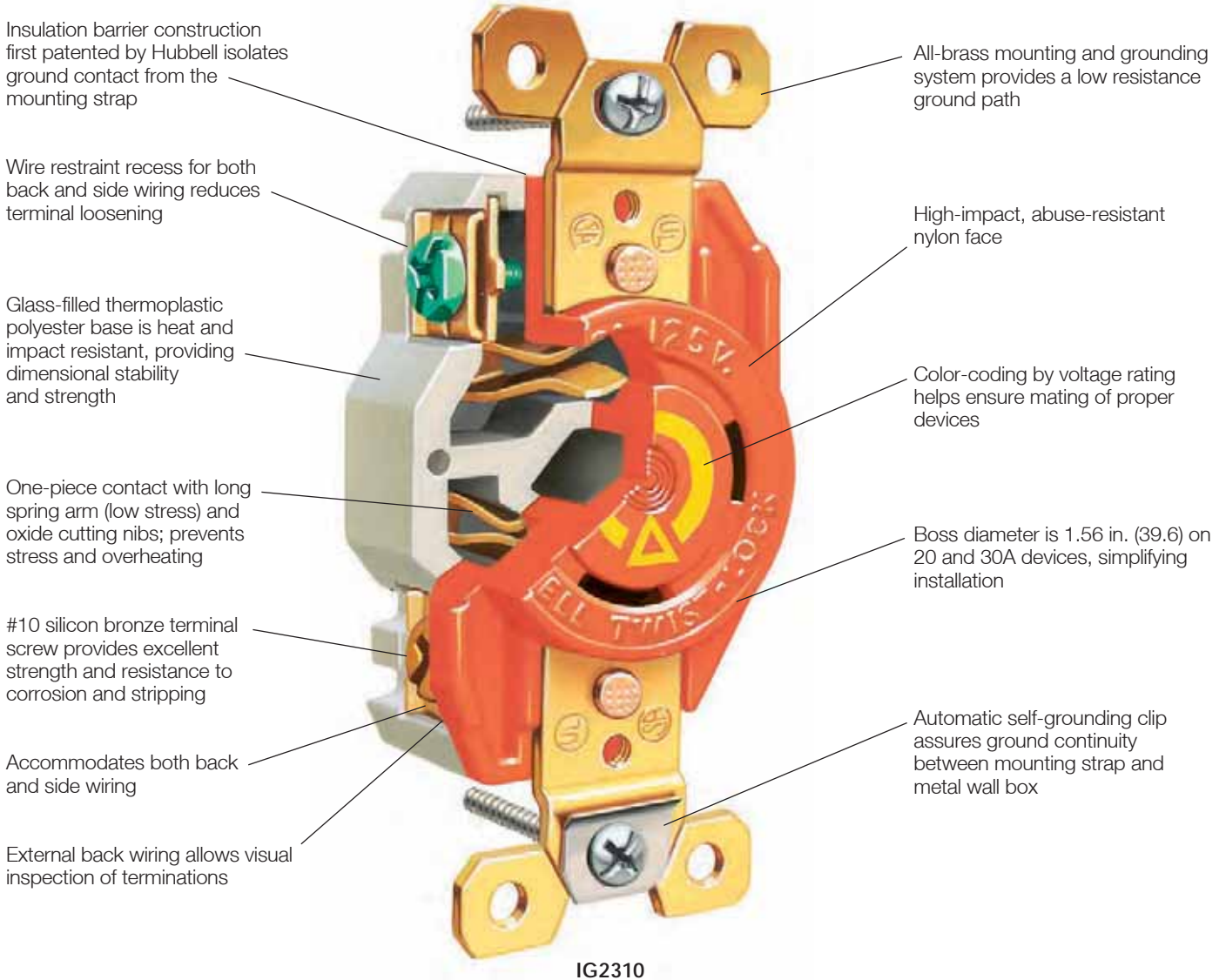

Face color-coding by voltage facilitates locating and mating of proper devices.



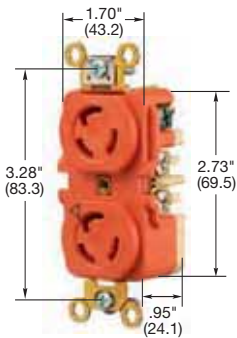

**IG4700A**

**15A, 125V and 250V  
 Back and Side Wired**



Description	Poles/Wires	Color	Catalog Number
Flush, RTP face, duplex.	2 pole, 3 wire	Orange	<b>IG4700A*</b> <b>IG4550A*</b>
Flush, RTP face, single.	2 pole, 3 wire	Orange	<b>IG4710</b> <b>IG4560</b>

*Note: RTP is an abbreviation for reinforced thermoplastic polyester.  
 \*Supplied with break-off tabs for split circuit wiring.*

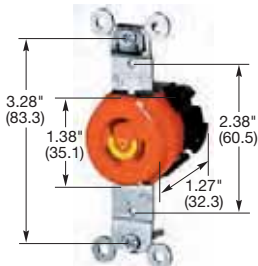

**IG4710**

**20A, 125V, 250V and 480V AC  
 Back and Side Wired**



Description	Poles/Wires	Color	Catalog Number
Flush, nylon face, single.	2 pole, 3 wire	Orange	<b>IG2310</b> <b>IG2320</b> <b>IG2340</b>

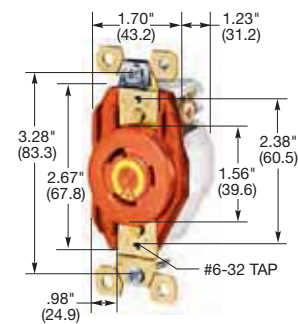

**IG2310**

**30A, 125V and 250V  
 Back and Side Wired**



Description	Poles/Wires	Color	Catalog Number
Flush, nylon face, single.	2 pole, 3 wire	Orange	<b>IG2610</b> <b>IG2620</b>

**20A, 125V/250V and 3Ø 250V AC  
 Back and Side Wired**



Description	Poles/Wires	Color	Catalog Number
Flush, nylon face, single.	3 pole, 4 wire	Orange	<b>IG2410</b> <b>IG2420</b>

**30A, 125V/250V and 3Ø 250V AC  
 Back and Side Wired**



Description	Poles/Wires	Color	Catalog Number
Flush, nylon face, single.	3 pole, 4 wire	Orange	<b>IG2710</b> <b>IG2720</b>

**20A and 30A, 3ØY 120/208V AC  
 Back and Side Wired**



Description	Poles/Wires	Color	Catalog Number
Flush, nylon face, single.	4 pole, 5 wire	Orange	<b>IG2510</b> <b>IG2810</b>

*Note: See page M-20 for isolated ground technical information.*

# SpikeShield® Power Quality Products

## Surge Protection Device Specifications

Technical Information

### SpikeShield® Surge Protection Plug Strips

	PS350 Series	MPS1050 Series	PS350YL Series	PS1050 Series	PS2100 Series	6PS Series	HBLCATC
<b>Operating Specifications</b>							
Max. Cont. Operating Voltage	130	130	130	130	130	130	24Vpk
Operating Frequency	50/60Hz	50/60Hz	50/60Hz	50/60Hz	50/60Hz	50/60Hz	50/60Hz
Max Surge Current	6.5kA	19.5kA	6.5kA	19.5kA	39.0kA	30.0kA	200
Operating Temperature	----- -40°F to 160°F (-40°C to 70°C) -----						
<b>Performance</b>							
UL Voltage Protection Rating	400V	400V	400V	400V	400V	500V	45V
EMI/RFI Noise Rejection	n/a	n/a	n/a	-20dB	-20dB	-20dB	n/a
<b>Warranty</b>							
Downline Warranty	\$2,500	\$2,500	\$2,500	\$2,500 (6PS1050) \$10,000 (all others)	\$25,000	None	None
<b>Physical Specifications</b>							
Housing Type	ABS	Metal	Metal	ABS	ABS	Metal	ABS
Color	Off. White	Off. White	Yellow	Off. White "USB" version is Black	Off. White	Black	Off. White

### Dimensions

	Length	Width	Height
HBL6PS350/1050 Series & HBL6PPS	11.2" (284.5)	2.36" (59.9)	1.85" (47.0)
HBL7PS1050 Series	14.75" (374.7)	2.36" (59.9)	1.85" (47.0)
HBL6MPS Series	12.25" (311.2)	2.5" (63.5)	1.5" (38.1)
HBL6PS350YL	14.75" (374.7)	2.5" (63.5)	1.85" (47.0)
HBL8PS350YL	10.0" (254.0)	6.0" (152.4)	1.85" (47.0)
HBL8ESPS Series	10.4" (264.2)	3.8" (96.5)	1.44" (36.6)
HBL6RSPS Series	9.12" (231.6)	4.4" (111.8)	1.68" (42.7)
HBL4PS1050USB	10.38" (263.7)	3.81" (96.8)	1.44" (36.6)

### Surge Protection Receptacles

Description	Part	Duplex / SNAPConnect®	4-PLEX®
Type – 2 Pole, 3 Wire, Grounding	Receptacle	15A/20A	15A/20A
	Top	Nylon	Lexan®
	Base	Nylon	Lexan®
	Power Contact	.031" (.8) Brass	.032" (.8) Brass
	Contact Design	Tandem Modified Bypass	Triple Wipe
Rating – 15A, 125V AC/20A, 125V AC	Mounting Strap	.050" (1.3) Steel-Zinc Coated	–
Certification – UL Listed File E2186	Clamping Plate	.031" (.8) Brass	.031" (.8) Brass-Line Terminal Plate
Listed to UL Standards 498 Receptacles			.031" (.8) Brass-Neutral-Terminal Plate
Meets UL1449-2.5	Terminal Screws	Brass #8-32 (Duplex only)	Brass #8-32
	Grounding Screw	Steel (Green) (Duplex only)	Brass (Green)
CSA Certified to Specification C22.2 No. 42	Automatic Self-Grounding Clip	Stainless Steel	.050" (1.3) Ground Plate
ANSI/IEEE C62.41 (IEEE 587)	Mounting Screws	Steel-Zinc Plated	Brass
Installation Categories "A" (Ring Wave)	LED	Green	Green
"B" (Unidirectional Impulse)	Alarm Muting Screw	Nylon	–

### Performance

Electrical	Duplex / SNAPConnect®		4-PLEX®	
Frequency	60Hz		60Hz	
Voltage	120V AC + 10%–15%		20V AC + 10%–15%	
Response Time	Approximately 5 ns		Approximately 5 ns	
Protection Modes	Normal and Common Modes		Normal and Common Modes	
Transient Suppression	Peak Energy (10 X 100 µs)	Peak Current (8 X 20 µs)	Peak Energy (10 X 100 µs)	Peak Current (8 X 20 µs)
Normal Mode (L-N)	240 joules	15000A	80 joules	6500A
Common Mode (L-G), (N-G)	240 joules	15000A	80 joules	6500A
UL Voltage Protection Rating	600 L-N, 600 L-G	1000 N-G	600 L-N, 600 L-G	900 N-G
EMI/RFI Attenuation at 50 Ohms Normal Mode	-40 dB			
Operating Temperature	32°F to 140°F (0°C to 60°C)		-40°F to 140°F (-40°C to 60°C)	
Flammability	UL 94V-2		UL 94V-2	

# SpikeShield® Power Quality Products Isolated Ground Device Specifications

Technical Information



## Specifications

Receptacle	Part	Description
Typical Specification – Catalog Number IG5262	Receptacle	15A
Manufacturer's Identification – Hubbell IG5262	Top	Nylon
Description – Isolated Ground, Straight Blade, Duplex Receptacle	Base	PET*
Type – 2 Pole, 3 Wire, Grounding	Triple Wipe Power Contacts	0.31" (8) Phosphor Bronze
Rating – 15A, 125V	Wire Clamp	0.062" (1.6) Steel Nickel Plated
Certification – UL Listed, CSA Certified, Fed. Spec.	Mounting Strap	0.050" (1.3) Brass
	Insulator	Nylon
	Terminal Screws	Brass #8-32
	Grounding Screw	Brass (Green)
	Center Assembly-Rivet	Brass
	Automatic Self-Grounding Clip	Stainless Steel
	Flat. Hd. Mtg. Screws	Steel Zinc Plated

Note: \*Polyethylene Terephthalate Polyester.

## Performance

Electrical	
Dielectric Voltage	Withstands 2,000V minimum.
Max. Working Voltage	125V or as rated.
Current Interrupting	Certified for current interrupting at full rated current.
Temperature Rise	Max 30°C temperature rise at full rated current after 50 cycles of overload at 150% of rated direct current.
Mechanical	
Terminal Identification	Terminals identified in accordance with UL 498 and CSA C22.2 No. 42 (Brass, White, Green).
Terminal Accommodation	#14-10 AWG standard or solid copper conductor only.
Product Identification	Ratings are permanent part of device.
Environmental – Material	
Flammability	Top: UL 94V-2, Base: UL 94V-0 and UL 94-5 VA.
Operating Temperatures	Maximum continuous 75°C; minimum -40°C/F (w/o impact) maximum (167°F, 75°C).

## Specifications

Receptacle	Part	Description
Catalog Number – IG5352, IG15CR, IG15DR	Receptacle	15A
Description – Isolated Ground, Straight Blade Duplex, Receptacle	Top	Nylon
Type – 2 Pole, 3 Wire, Grounding	Base	Nylon
Rating – 15A, 125V	Power Contacts	.030" (.8) Brass
Certification – UL Listed, CSA Certified	Terminal Clamp	.062" (1.6) Nickel Plated Steel
	Grounding Screw	#8-32 Plated Steel, TriDrive
	Mounting Strap	.040" (1) Galvanized Steel
	Auto Ground	Stainless Steel
	Mounting Screws	Zinc Plated Steel, Self-Tapping

## Performance

Electrical	
Dielectric Voltage	Withstands 2000V Minimum.
Maximum Working Voltage	125V.
Current Interrupting	Certified for current interrupting at full rated current.
Temperature Rise	Max 30°C temperature rise at full rated current after 50 cycles of overload at 150% of rated direct current.
Mechanical	
Terminal Identification	Terminals identified in accordance with UL 498 and CSA C22.2 No. 42 (Brass, White, Green).
Terminal Accommodation	#14-10 AWG stranded or solid copper conductors only.
Product Identification	Ratings are a permanent part of the device.
Environmental – Material	
Flammability	UL 94V-2.
Operating Temperatures	Max. continuous: 75°C; Min. continuous: -40°C w/o impact.

# Section N Wallplates and Covers

## Index

Product	Page
Features and Benefits	N-2
Snap-On Wallplates	N-4
Toggle Switch Wallplates	N-5
Duplex and Single Receptacle Wallplates	N-6
Single Receptacle Wallplates	N-7
Blank Wallplates	N-8
347 Volt Wallplates	N-9
Decorator Wallplates	N-10
Combination Wallplates, 2-Gang	N-11
Combination Wallplates, 3-Gang	N-13
Combination Wallplates, 4- and 5-Gang	N-14
Telephone and Coaxial Outlet Plates	N-15
Jumbo, Metal Wallplates	N-16
Pre-Marked "EMERGENCY" and Barrel Key Switch Wallplates	N-17
Pre-Marked "ISOLATED GROUND" or "COMPUTER ONLY" Wallplates	N-18
Security Wallplates	N-19
Accessories and Selection Charts	N-20
Weatherproof Plates for Receptacles	N-21
Weatherproof Plates for Receptacles and Switches	N-22
Weatherproof Covers for Flanged Devices	N-23
Weatherproof Switch Plates, Covers and Locking Covers	N-24
Heavy Duty Weatherproof Covers	N-25
Weatherproof Covers	N-26
Extra Duty Metallic While-In-Use Covers	N-27
While-In-Use Weatherproof Covers	N-28
Screws and Accessories	N-29
Technical Information	N-30
Wallplate Dimensions	N-31
Custom Metal Wallplates	N-32

### Features and Benefits



### Nylon Wallplates



### Metal Wallplates



### Weatherproof Covers



# Wallplates

## Nylon Wallplates

Features and Benefits



### Nylon Wallplates

Our line of nylon wallplates features larger standard sized wallplates to provide extra coverage to hide rough box opening, improved aesthetics, greater strength, impact resistance, along with excellent cleanability in all different types of environments.

- Standard size is 1/8 inch larger to give you extra coverage to hide rough box openings. Also available in mid-size and pre-marked.
- Curved corners for improved aesthetics, for use in any application.
- Reinforcement ribs for extra strength.
- Captive screw feature holds mounting screw in place for quick and easy installation.
- High-impact, self-extinguishing nylon material, which is virtually unbreakable.
- Smooth, easy to clean finish is highly resistant to solvents and cleaning solutions, providing long life in the harshest environments.

Hubbell's standard sized wallplates are 1/8 inch larger to provide you that extra coverage to hide rough box openings. The depth is 1/4 inch so that it will comfortably fit over the device even on imperfect installations or on retrofit work.

### Nylon Wallplates



### Nylon Pre-Marked Wallplates



### Metal Wallplates



### Pre-Marked



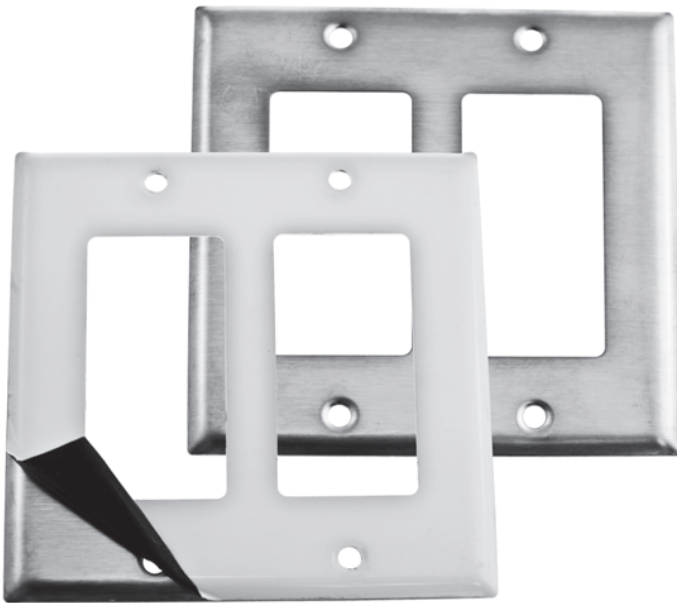

Protective plastic film helps to prevent scratches and damage.

#### Stainless Steel

Provide solutions for a variety of industrial and commercial applications.

- Environments subjected to heavy abuse.
- The 302/304 type stainless steel wallplates are ideal for highly corrosive environments such as food processing, hospitals, static free requirements and more.

Non-magnetic: 18.0% Chromium  
8.0% Nickel

- Standard commercial use.
- The 430 type stainless steel wallplates are aesthetically identical to the 302/304 type stainless steel wallplates and are best suited for environments where corrosion resistance is less critical.

Magnetic: 17.0% Chromium  
Less than 0.5% Nickel

#### Smooth Solid Brass

- Provides a push appearance with the durability of metal.
- Finish is lacquer coated to inhibit oxidation.

#### Anodized Aluminum

- Non-magnetic and corrosion resistance for a wide range of applications.
- Finish is lacquer coated to inhibit oxidation.

#### Extra-Duty Metallic While-in-Use Covers

These covers are designed for use whenever protection is required while an outlet is in use. Covers meet or exceed the extra-duty rating per UL 514D, and are NEMA 3R rated.

- Die-cast aluminum construction
- Powder coated “chip resistant” paint corrosion protection
- Unique plug management provision for securing device and cord



#### 2014 National Electrical Code (NEC®) Requirement

##### 406.9 Receptacles in Damp or Wet Locations.

406.9 Receptacles in Damp or Wet Locations.

(B) Wet Locations.

(1) 15 and 20 Ampere Receptacles in a Wet Location. 15 and 20 ampere, 125 and 250 volt receptacles installed in a wet location shall have an enclosure that is weatherproof whether or not the attachment plug cap is inserted. An outlet box hood installed for this purpose shall be listed, and shall be identified as “extra-duty.” All 15 and 20 ampere, 125 and 250 volt nonlocking-type receptacles shall be listed weather-resistant type.

Exception: 15 and 20 ampere, 125 through 250 volt receptacles installed in a wet location and subject to routine high-pressure spray washing shall be permitted to have an enclosure that is weatherproof when the attachment plug is removed.

(2) Other Receptacles. All other receptacles installed in a wet location shall comply with (B)(2)(a) or (B)(2)(b).

(a) A receptacle installed in a wet location, where the product intended to be plugged into it is not attended while in use, shall have an enclosure that is weatherproof with the attachment plug cap inserted or removed.

(b) A receptacle installed in a wet location where the product intended to be plugged into it will be attended while in use (e.g., portable tools) shall have an enclosure that is weatherproof when the attachment plug is removed.





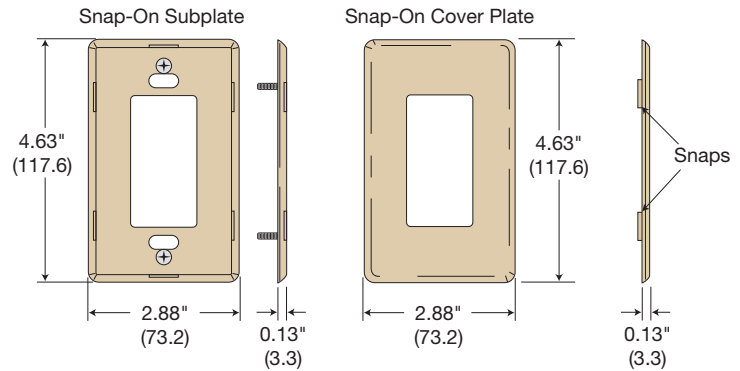

### More Style In a Snap

Snap-on wallplates offer a clean, elegant look that can be installed in seconds. Screw the mounting plate onto the device and press the snap-on cover into place.











### Snap-On Wallplates

Description	Color	Decorator Catalog Number	Toggle Catalog Number
1-Gang, 1-Decorator 	Ivory Light Almond White	<b>RCW1I</b> <b>RCW1LA</b> <b>RCW1W</b>	<b>RFW1I</b> - <b>RFW1W</b>
1-Gang, 1-Toggle Style 			
2-Gang, 2-Decorator 	Ivory Light Almond White	<b>RCW2I</b> <b>RCW2LA</b> <b>RCW2W</b>	<b>RFW2I</b> - <b>RFW2W</b>
2-Gang, 2-Toggle Style 			
3-Gang, 3-Decorator 	Ivory Light Almond White	<b>RCW3I</b> <b>RCW3LA</b> <b>RCW3W</b>	<b>RFW3I</b> - <b>RFW3W</b>
3-Gang, 3-Toggle Style 			
4-Gang, 4-Decorator 	Ivory Light Almond White	<b>RCW4I</b> <b>RCW4LA</b> <b>RCW4W</b>	- - -
4-Gang, 4-Toggle Style 			
5-Gang, 5-Decorator 	Ivory Light Almond White	<b>RCW5I</b> <b>RCW5LA</b> <b>RCW5W</b>	- - -
5-Gang, 5-Toggle Style 			
6-Gang, 6-Decorator 	Ivory Light Almond White	<b>RCW6I</b> <b>RCW6LA</b> <b>RCW6W</b>	- - -
6-Gang, 6-Toggle Style 			

Dimensions in Inches (mm)



**Toggle Switch Wallplates**





Description	Color	Nylon Standard	Nylon Mid-Size	Material	Metal Catalog Number
 1-Gang, 1-Toggle	Almond	NP1AL	NPJ1AL	Aluminum	SA1
	Black	NP1BK	NPJ1BK	Brass	SB1
	Brown	NP1	NPJ1	Brass Plated	SBP1
	Gray	NP1GY	NPJ1GY	Chrome	SCH1
	Ivory	NP1I	NPJ1I	S/S 302/304	SS1
	Light Almond	NP1LA	NPJ1LA	S/S 430	SS1L
	Office White	NP1OW	NPJ1OW	Steel, Almond	SP1AL*
	Red	NP1R	NPJ1R	Steel, Gray	SP1G*
	White	NP1W	NPJ1W		
	 2-Gang, 2-Toggle	Almond	NP2AL	NPJ2AL	Aluminum
Black		NP2BK	NPJ2BK	Brass	SB2
Brown		NP2	NPJ2	Brass Plated	SBP2
Gray		NP2GY	NPJ2GY	Chrome	SCH2
Ivory		NP2I	NPJ2I	S/S 302/304	SS2
Light Almond		NP2LA	NPJ2LA	S/S 430	SS2L
Office White		NP2OW	NPJ2OW	Steel, Almond	SP2AL*
Red		NP2R	NPJ2R	Steel, Gray	SP2G*
White		NP2W	NPJ2W		
 3-Gang, 3-Toggle		Almond	NP3AL	NPJ3AL	Aluminum
	Black	NP3BK	NPJ3BK	Brass	SB3
	Brown	NP3	NPJ3	Brass Plated	SBP3
	Gray	NP3GY	NPJ3GY	Chrome	SCH3
	Ivory	NP3I	NPJ3I	S/S 302/304	SS3
	Light Almond	NP3LA	NPJ3LA	S/S 430	SS3L
	Office White	NP3OW	NPJ3OW	Steel, Almond	SP3AL*
	Red	-	NPJ3R		
	White	NP3W	NPJ3W		
	 4-Gang, 4-Toggle	Black	NP4BK	NPJ4BK	Aluminum
Brown		NP4	NPJ4	Brass	SB4
Gray		NP4GY	NPJ4GY	Brass Plated	SBP4
Ivory		NP4I	NPJ4I	Chrome	①
Light Almond		NP4LA	NPJ4LA	S/S 302/304	SS4
Office White		NP4OW	NPJ4OW	S/S 430	SS4L
White		NP4W	NPJ4W	Steel, Almond	SP4AL*
 5-Gang, 5-Toggle	Black	NP5BK	-	Aluminum	①
	Brown	NP5	-	Brass	SB5
	Gray	NP5GY	-	Brass Plated	①
	Ivory	NP5I	-	Chrome	①
	Light Almond	NP5LA	-	S/S 302/304	SS5
	White	NP5W	-	S/S 430	-
 6-Gang, 6-Toggle	Brown	NP6	-	Aluminum	①
	Gray	NP6GY	-	Brass	SB6
	Ivory	NP6I	-	Brass Plated	①
	Light Almond	NP6LA	-	Chrome	①
	White	NP6W	-	S/S 302/304	SS6
				S/S 430	-
 7-Gang, 7-Toggle	Almond	-	-	Aluminum	①
	Brown	-	-	Brass	①
	Gray	-	-	Brass Plated	①
	Ivory	-	-	Chrome	①
	White	-	-	S/S 302/304	SS607
				S/S 430	-
 8-Gang, 8-Toggle	Almond	-	-	Aluminum	①
	Brown	-	-	Brass	①
	Gray	-	-	Brass Plated	①
	Ivory	-	-	Chrome	①
	White	-	-	S/S 302/304	SS608
				S/S 430	-
 2-Gang, 1-Toggle	Almond	-	-	Aluminum	-
	Brown	-	-	Brass	-
	Gray	-	-	Brass Plated	-
	Ivory	-	-	Chrome	-
	White	-	-	S/S 302/304	SS740
				S/S 430	-

Note: All standard and mid-size nylon wallplates feature pre-inserted captive screws for faster assembly, up to 6-gang.  
 ①Available as a custom wallplate, see pages N-32 to N-36. Consult custom wallplates section for additional openings and combinations.  
 \*Powder coat paint finish.



# Wallplates Duplex and Single Receptacle Wallplates



## Duplex Receptacle Wallplates

Description	Color	Nylon Standard	Nylon Mid-Size	Material	Metal Catalog Number
 1-Gang, 1-Duplex	Almond	<b>NP8AL</b>	<b>NPJ8AL</b>	Aluminum	<b>SA8</b>
	Black	<b>NP8BK</b>	<b>NPJ8BK</b>	Brass	<b>SB8</b>
	Blue	-	<b>NPJ8BL</b>	Brass Plated	<b>SBP8</b>
	Brown	<b>NP8</b>	<b>NPJ8</b>	Chrome	<b>SCH8</b>
	Gray	<b>NP8GY</b>	<b>NPJ8GY</b>	S/S 302/304	<b>SS8</b>
	Ivory	<b>NP8I</b>	<b>NPJ8I</b>	S/S 430	<b>SS8L</b>
	Light Almond	<b>NP8LA</b>	<b>NPJ8LA</b>	Steel, Almond	<b>SP8AL*</b>
	Office White	<b>NP8OW</b>	<b>NPJ8OW</b>	Steel, Gray	<b>SP8G*</b>
	Orange	<b>NP8OR</b>	-		
	Red	<b>NP8R</b>	<b>NPJ8R</b>		
	White	<b>NP8W</b>	<b>NPJ8W</b>		
	 2-Gang, 2-Duplex	Black	<b>NP82BK</b>	<b>NPJ82BK</b>	Aluminum
Brown		<b>NP82</b>	<b>NPJ82</b>	Brass	<b>SB82</b>
Gray		<b>NP82GY</b>	<b>NPJ82GY</b>	Brass Plated	<b>SBP82</b>
Ivory		<b>NP82I</b>	<b>NPJ82I</b>	Chrome	<b>SCH82</b>
Light Almond		<b>NP82LA</b>	<b>NPJ82LA</b>	S/S 302/304	<b>SS82</b>
Office White		<b>NP82OW</b>	<b>NPJ82OW</b>	S/S 430	<b>SS82L</b>
Orange		<b>NP82OR</b>	-	Steel, Almond	<b>SP82AL*</b>
Red		<b>NP82R</b>	<b>NPJ82R</b>	Steel, Gray	<b>SP82G*</b>
White		<b>NP82W</b>	<b>NPJ82W</b>		
 3-Gang, 3-Duplex	Brown	<b>NP83</b>	-	Aluminum	①
	Ivory	<b>NP83I</b>	-	Brass	①
	White	<b>NP83W</b>	-	Brass Plated	①
				Chrome	①
				S/S 302/304	<b>SS83</b>
 4-Gang, 4-Duplex	Brown	<b>NP84</b>	-	Aluminum	①
	Ivory	<b>NP84I</b>	-	Brass	①
	White	<b>NP84W</b>	-	Brass Plated	①
				Chrome	①
				S/S 302/304	<b>SS84</b>
 2-Gang, 1-Duplex	-	-	-	Brass	-
	-	-	-	Brass Plated	-
	-	-	-	Chrome	-
	-	-	-	S/S 302/304	<b>SS748</b>
	-	-	-	S/S 430	-

## Single 15/20A Straight Blade or 15A Twist-Lock® Receptacle Wallplates





Description	Color	Nylon Standard	Nylon Mid-Size	Material	Metal Catalog Number
 1-Gang, 1-Single 1.40 in. (35.6) Dia. Hole	Black	<b>NP7BK</b>	<b>NPJ7BK</b>	Aluminum	<b>SA7</b>
	Brown	<b>NP7</b>	<b>NPJ7</b>	Brass	<b>SB7</b>
	Gray	<b>NP7GY</b>	<b>NPJ7GY</b>	Brass Plated	<b>SBP7</b>
	Ivory	<b>NP7I</b>	<b>NPJ7I</b>	Chrome	<b>SCH7</b>
	Light Almond	<b>NP7LA</b>	<b>NPJ7LA</b>	S/S 302/304	<b>SS7</b>
	Office White	<b>NP7OW</b>	<b>NPJ7OW</b>	S/S 430	<b>SS7L</b>
	Red	<b>NP7R</b>	<b>NPJ7R</b>	Steel, Almond	<b>SP7AL*</b>
	White	<b>NP7W</b>	<b>NPJ7W</b>	Steel, Gray	<b>SP7G*</b>
 2-Gang, 1-Single 1.40 in. (35.6) Dia. Hole	-	-	-	Aluminum	-
	-	-	-	Brass	-
	-	-	-	Brass Plated	-
	-	-	-	Chrome	-
	-	-	-	S/S 302/304	<b>SS747</b>
 2-Gang, 2-Single 1.40 in. (35.6) Dia. Hole	-	-	-	Aluminum	①
	-	-	-	Brass	①
	-	-	-	Brass Plated	①
	-	-	-	Chrome	①
	-	-	-	S/S 302/304	<b>SS72</b>
			S/S 430	-	

Note: All standard and mid-size nylon wallplates feature pre-inserted captive screws for faster assembly, up to 6-gang.







① Available as a custom wallplate, see pages N-32 to N-36. Consult custom wallplates section for additional openings and combinations.

\*Powder coat paint finish.

**Single 20/30A Twist-Lock® Receptacle Wallplates**











Description	Color	Nylon Standard	Nylon Mid-Size	Material	Metal Catalog Number
 1-Gang, 1-Single 1.60 in. (40.6) Dia. Hole	Black	<b>NP720BK</b>	-	Aluminum	<b>SA720</b>
	Brown	<b>NP720</b>	-	Brass	<b>SB720</b>
	Gray	<b>NP720GY</b>	-	Brass Plated	①
	Ivory	<b>NP720I</b>	-	Chrome	①
	Office White	<b>NP720OW</b>	-	S/S 302/304	<b>SS720</b>
	Red	<b>NP720R</b>	-	S/S 430	-
	White	<b>NP720W</b>	-	-	-
 1-Gang, 1-Single 1.74 in. (44.2) Dia. Hole	-	-	-	Aluminum	-
	-	-	-	Brass	-
	-	-	-	Brass Plated	-
	-	-	-	Chrome	-
	-	-	-	S/S 302/304	<b>SS725</b>
 2-Gang, 1-Single 1.60 in. (40.6) Dia. Hole	-	-	-	Aluminum	-
	-	-	-	Brass	-
	-	-	-	Brass Plated	-
	-	-	-	Chrome	-
	-	-	-	S/S 302/304	<b>SS749</b>
 3-Gang, 2-Single 1.60 in. (40.6) Dia. Hole	-	-	-	Aluminum	①
	-	-	-	Brass	①
	-	-	-	Brass Plated	①
	-	-	-	Chrome	①
	-	-	-	S/S 302/304	<b>SS320</b>
 3-Gang, 2-Single 1.74 in. (44.2) Dia. Hole	-	-	-	Aluminum	-
	-	-	-	Brass	-
	-	-	-	Brass Plated	-
	-	-	-	Chrome	-
	-	-	-	S/S 302/304	<b>SS330</b>

**Single Receptacle Wallplates**

Description	Color	Nylon Standard	Nylon Mid-Size	Material	Metal Catalog Number
 1-Gang, 1-Single 1.97 in. (50.0) Dia. Hole	-	-	-	Aluminum	-
	-	-	-	Brass	-
	-	-	-	Chrome	-
	-	-	-	S/S 302/304	<b>SS737</b>
	-	-	-	S/S 430	-
 1-Gang, 1-Single 2.16 in. (54.9) Dia. Hole	Black	<b>NP724BK</b>	<b>NPJ724BK</b>	Aluminum	<b>SA723</b>
	Brown	<b>NP724</b>	<b>NPJ724</b>	Brass	①
	Gray	<b>NP724GY</b>	<b>NPJ724GY</b>	Brass Plated	①
	Ivory	<b>NP724I</b>	<b>NPJ724I</b>	Chrome	<b>SCH723</b>
	White	<b>NP724W</b>	<b>NPJ724W</b>	S/S 302/304	<b>SS723</b>
	-	-	-	S/S 430	<b>SS723L</b>
 2-Gang, 1-Single 2.16 in. (54.9) Dia. Hole	-	-	-	Aluminum	-
	-	-	-	Brass	-
	-	-	-	Chrome	<b>SCH702</b>
	-	-	-	S/S 302/304	<b>SS702</b>
	-	-	-	S/S 430	-
 2-Gang, 1-Single 2.16 in. (54.9) Dia. Hole	Black	<b>NP703BK</b>	<b>NPJ703BK</b>	Aluminum	-
	Brown	<b>NP703</b>	<b>NPJ703</b>	Brass	-
	Gray	<b>NP703GY</b>	<b>NPJ703GY</b>	Brass Plated	-
	Ivory	<b>NP703I</b>	<b>NPJ703I</b>	Chrome	-
	White	<b>NP703W</b>	<b>NPJ703W</b>	S/S 302/304	<b>SS703</b>
	-	-	-	S/S 430	<b>SS703L</b>
 2-Gang, 1-Single 2.48 in. (63.0) Dia. Hole	-	-	-	Aluminum	-
	-	-	-	Brass	-
	-	-	-	Chrome	-
	-	-	-	S/S 302/304	<b>SS701</b>
	-	-	-	S/S 430	-
 2-Gang, 1-Single 2.66 in. (67.6) Dia. Hole	-	-	-	Aluminum	-
	-	-	-	Brass	-
	-	-	-	Chrome	-
	-	-	-	S/S 302/304	<b>SS716</b>
	-	-	-	S/S 430	-

Note: All standard and mid-size nylon wallplates feature pre-inserted captive screws for faster assembly, up to 6-gang.  
① Available as a custom wallplate, see pages N-32 to N-36. Consult custom wallplates section for additional openings and combinations.

**Blank Wallplates, Box Mount and Strap Mount**







Description	Color	Nylon Standard	Nylon Mid-Size	Material	Metal Catalog Number	
 1-Gang, 1-Blank, Box Mount	Almond	NP13AL	NPJ13AL	Aluminum	SA13A	
	Black	NP13BK	NPJ13BK	Brass	SB13	
	Brown	NP13	NPJ13	Brass Plated	SBP13	
	Gray	NP13GY	NPJ13GY	Chrome	SCH13	
	Ivory	NP13I	NPJ13I	S/S 302/304	SS13	
	Light Almond	NP13LA	NPJ13LA	S/S 430	SS13L	
	Office White	NP13OW	NPJ13OW	Steel, Almond	SP14BAL*	
	White	NP13W	NPJ13W	Steel, Gray	SP14BG*	
	 2-Gang, 2-Blank, Box Mount	Almond	NP23AL	NPJ23AL	Aluminum	SA23
Black		NP23BK	-	Brass	SB23	
Brown		NP23	NPJ23	Brass Plated	⓪	
Gray		NP23GY	-	Chrome	SCH23	
Ivory		NP23I	NPJ23I	S/S 302/304	SS23	
Light Almond		NP23LA	NPJ23LA	S/S 430	SS23L	
White		NP23W	NPJ23W	Steel, Almond	SP24BAL*	
Steel, Gray		-	-	Steel, Gray	SP24BG*	
 3-Gang, 3-Blank, Box Mount	Brown	NP33	-	Aluminum	⓪	
	Ivory	NP33I	-	Brass	⓪	
	White	NP33W	-	Brass Plated	⓪	
	-	-	-	Chrome	⓪	
 3-Gang, 3-Blank, Box Mount	-	-	-	S/S 302/304	SS33	
	-	-	-	S/S 430	-	
	-	-	-	Steel, Almond	SP34BAL*	
	 4-Gang, 4-Blank, Box Mount	Brown	NP43	-	Aluminum	⓪
		Ivory	NP43I	-	Brass	⓪
		White	NP43W	-	Brass Plated	⓪
-		-	-	Chrome	⓪	
-		-	-	S/S 302/304	SS43	
S/S 430	-	-	S/S 430	-		
 1-Gang, 1-Blank, Strap Mount	Black	NP14BK	-	Aluminum	⓪	
	Brown	NP14	-	Brass	SB14	
	Gray	NP14GY	-	Brass Plated	⓪	
	Ivory	NP14I	-	Chrome	⓪	
	Office White	NP14OW	-	S/S 302/304	SS14	
	Red	NP14R	-	S/S 430	SS14L	
	White	NP14W	-	Steel, Almond	SP14AL*	
	Steel, Gray	-	-	Steel, Gray	SP14G*	
 2-Gang, 2-Blank, Strap Mount	Black	NP24BK	-	Aluminum	⓪	
	Brown	NP24	-	Brass	⓪	
	Gray	NP24GY	-	Brass Plated	⓪	
	Ivory	NP24I	-	Chrome	⓪	
	Office White	NP24OW	-	S/S 302/304	SS24	
	Red	NP24R	-	S/S 430	SS24L	
	White	NP24W	-	Steel, Almond	SP24AL*	
	Steel, Gray	-	-	Steel, Gray	SP24G*	
 3-Gang, 3-Blank, Strap Mount	Brown	NP34	-	Aluminum	⓪	
	Ivory	NP34I	-	Brass	⓪	
	White	NP34W	-	Brass Plated	⓪	
	-	-	-	Chrome	⓪	
 3-Gang, 3-Blank, Strap Mount	-	-	-	S/S 302/304	SS34	
	-	-	-	S/S 430	-	
	-	-	-	Steel, Almond	SP34AL*	
	 4-Gang, 4-Blank, Strap Mount	Brown	NP44	-	Aluminum	⓪
		Ivory	NP44I	-	Brass	⓪
		White	NP44W	-	Brass Plated	⓪
-		-	-	Chrome	⓪	
 4-Gang, 4-Blank, Strap Mount	-	-	-	S/S 302/304	SS44	
	-	-	-	S/S 430	-	
	-	-	-	-	-	

Note: All standard and mid-size nylon wallplates feature pre-inserted captive screws for faster assembly, up to 6-gang.



⓪ Available as a custom wallplate, see pages N-32 to N-36. Consult custom wallplates section for additional openings and combinations.

\*Powder coat paint finish.

**347 Volt Toggle Wallplates with 2.25" (57.2) Spacing Between Gangs, Stamped "347V"**



Description	Color	Nylon Catalog Number	Material	Metal Catalog Number
1-Gang, 1-Toggle 2.25 in. (57.2) Spacing 	-	-	Aluminum	-
	-	-	Brass	-
	-	-	Brass Plated	-
	-	-	Chrome	-
	-	-	S/S 302/304 S/S 430	<b>SS1C</b> -
2-Gang, 2-Toggle 2.25 in. (57.2) Spacing 	-	-	Aluminum	-
	-	-	Brass	-
	-	-	Brass Plated	-
	-	-	Chrome	-
	-	-	S/S 302/304 S/S 430	<b>SS2C</b> -
3-Gang, 3-Toggle 2.25 in. (57.2) Spacing 	-	-	Aluminum	-
	-	-	Brass	-
	-	-	Brass Plated	-
	-	-	Chrome	-
	-	-	S/S 302/304 S/S 430	<b>SS3C</b> -
4-Gang, 4-Toggle 2.25 in. (57.2) Spacing 	-	-	Aluminum	-
	-	-	Brass	-
	-	-	Brass Plated	-
	-	-	Chrome	-
	-	-	S/S 302/304 S/S 430	<b>SS4C</b> -
5-Gang, 5-Toggle 2.25 in. (57.2) Spacing 	-	-	Aluminum	-
	-	-	Brass	-
	-	-	Brass Plated	-
	-	-	Chrome	-
	-	-	S/S 302/304 S/S 430	<b>SS5C</b> -
6-Gang, 6-Toggle 2.25 in. (57.2) Spacing 	-	-	Aluminum	-
	-	-	Brass	-
	-	-	Brass Plated	-
	-	-	Chrome	-
	-	-	S/S 302/304 S/S 430	<b>SS6C</b> -

**347 Volt Decorator Wallplates**

Description	Color	Nylon Catalog Number	Material	Metal Catalog Number
1-Gang, 1-Decorator 	Black	<b>HPS1347BK</b>	Aluminum	-
	Gray	<b>HPS1347GY</b>	Brass	-
	Ivory	<b>HPS1347I</b>	Brass Plated	-
	White	<b>HPS1347W</b>	Chrome	-
	-	-	S/S 302/304 S/S 430	- -
2-Gang, 2-Decorator 	Black	<b>HPS2347BK</b>	Aluminum	-
	Gray	<b>HPS2347GY</b>	Brass	-
	Ivory	<b>HPS2347I</b>	Brass Plated	-
	White	<b>HPS2347W</b>	Chrome	-
	-	-	S/S 302/304 S/S 430	- -
3-Gang, 3-Decorator 	Ivory	<b>HPS3347I</b>	Aluminum	-
	White	<b>HPS3347W</b>	Brass	-
	-	-	Brass Plated	-
	-	-	Chrome	-
	-	-	S/S 302/304 S/S 430	- -





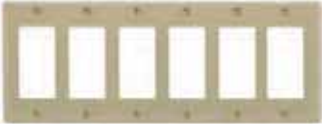



Note: All standard and mid-size nylon wallplates feature pre-inserted captive screws for faster assembly, up to 6-gang.

**GFCI, Surge Receptacles and Style Line® Device Wallplates**

Description	Color	Nylon Standard	Nylon Mid-Size	Material	Metal Catalog Number	
 1-Gang, 1-Decorator	Almond	NP26AL	NPJ26AL	Aluminum	①	
	Black	NP26BK	NPJ26BK	Brass	SB26	
	Blue	-	NPJ26BL	Brass Plated	SBP26	
	Brown	NP26	NPJ26	Chrome	SCH26	
	Gray	NP26GY	NPJ26GY	S/S 302/304	SS26	
	Ivory	NP26I	NPJ26I	S/S 430	SS26L	
	Light Almond	NP26LA	NPJ26LA	Steel, Almond	PHPS1AL*	
	Office White	NP26OW	NPJ26OW	Steel, Gray	PHPS1G*	
	Red	NP26R	NPJ26R			
	White	NP26W	NPJ26W			
	 2-Gang, 2-Decorator	Almond	NP262AL	NPJ262AL	Aluminum	①
Black		NP262BK	NPJ262BK	Brass	SB262	
Brown		NP262	NPJ262	Brass Plated	SBP262	
Gray		NP262GY	NPJ262GY	Chrome	SCH262	
Ivory		NP262I	NPJ262I	S/S 302/304	SS262	
Light Almond		NP262LA	NPJ262LA	S/S 430	SS262L	
Office White		NP262OW	NPJ262OW	Steel, Almond	PHPS2AL*	
Red		NP262R	NPJ262R	Steel, Gray	PHPS2G*	
White		NP262W	NPJ262W			
 3-Gang, 3-Decorator		Almond	NP263AL	NPJ263AL	Aluminum	①
		Black	NP263BK	NPJ263BK	Brass	①
	Brown	NP263	NPJ263	Brass Plated	SBP263	
	Gray	NP263GY	NPJ263GY	Chrome	①	
	Ivory	NP263I	NPJ263I	S/S 302/304	SS263	
	Light Almond	NP263LA	NPJ263LA	S/S 430	-	
	Office White	NP263OW	NPJ263OW	Steel, Almond	PHPS3AL*	
	Red	NP263R	NPJ263R			
	White	NP263W	NPJ263W			
	 4-Gang, 4-Decorator	Almond	NP264AL	NPJ264AL	Aluminum	①
		Black	NP264BK	NPJ264BK	Brass	①
Brown		NP264	NPJ264	Brass Plated	①	
Gray		NP264GY	NPJ264GY	Chrome	①	
Ivory		NP264I	NPJ264I	S/S 302/304	SS264	
Light Almond		NP264LA	NPJ264LA	S/S 430	-	
Office White		NP264OW	NPJ264OW	Steel, Almond	PHPS4AL*	
White		NP264W	NPJ264W			
 5-Gang, 5-Decorator		Black	NP265BK	-	Aluminum	①
		Brown	NP265	-	Brass	①
		Gray	NP265GY	-	Brass Plated	①
	Ivory	NP265I	-	Chrome	①	
	Light Almond	NP265LA	-	S/S 302/304	SS265	
	White	NP265W	-	S/S 430	-	
				Steel, Almond	PHPS5AL*	
 6-Gang, 6-Decorator	Black	NP266BK	-	Aluminum	①	
	Brown	NP266	-	Brass	①	
	Gray	NP266GY	-	Brass Plated	①	
	Ivory	NP266I	-	Chrome	①	
	Light Almond	NP266LA	-	S/S 302/304	SS266	
	White	NP266W	-	S/S 430	-	
				Steel, Almond	PHPS6AL*	

Note: All standard and mid-size nylon wallplates feature pre-inserted captive screws for faster assembly, up to 6-gang.  
 ①Available as a custom wallplate, see pages N-32 to N-36. Consult custom wallplates section for additional openings and combinations.  
 \*Powder coat paint finish.

**Combination Wallplates, 2-Gang**

Description	Color	Nylon Standard	Nylon Mid-Size	Material	Metal Catalog Number
 2-Gang, 1-Toggle, 1-Duplex	Almond	<b>NP18AL</b>	<b>NPJ18AL</b>	Aluminum	①
	Black	<b>NP18BK</b>	<b>NPJ18BK</b>	Brass	①
	Brown	<b>NP18</b>	<b>NPJ18</b>	Brass Plated	<b>SBP18</b>
	Gray	<b>NP18GY</b>	<b>NPJ18GY</b>	Chrome	<b>SCH18</b>
	Ivory	<b>NP18I</b>	<b>NPJ18I</b>	S/S 302/304	<b>SS18</b>
	Light Almond	<b>NP18LA</b>	<b>NPJ18LA</b>	S/S 430	<b>SS18L</b>
	Office White	<b>NP18OW</b>	<b>NPJ18OW</b>	Steel, Almond	<b>SP18AL*</b>
	Red	<b>NP18R</b>	<b>NPJ18R</b>	Steel, Gray	<b>SP18G*</b>
	White	<b>NP18W</b>	<b>NPJ18W</b>		
	 2-Gang, 1-Duplex, 1-Decorator	Almond	<b>NP826AL</b>	<b>NPJ826AL</b>	Aluminum
Black		<b>NP826BK</b>	<b>NPJ826BK</b>	Brass	<b>SB826</b>
Brown		<b>NP826</b>	<b>NPJ826</b>	Brass Plated	①
Gray		<b>NP826GY</b>	<b>NPJ826GY</b>	Chrome	①
Ivory		<b>NP826I</b>	<b>NPJ826I</b>	S/S 302/304	<b>SS826</b>
Light Almond		<b>NP826LA</b>	<b>NPJ826LA</b>	S/S 430	-
Office White		<b>NP826OW</b>	-		
White		<b>NP826W</b>	<b>NPJ826W</b>		
 2-Gang, 1-Toggle, 1-Decorator	Almond	<b>NP126AL</b>	<b>NPJ126AL</b>	Aluminum	①
	Black	<b>NP126BK</b>	<b>NPJ126BK</b>	Brass	<b>SB126</b>
	Brown	<b>NP126</b>	<b>NPJ126</b>	Brass Plated	<b>SBP126</b>
	Gray	<b>NP126GY</b>	<b>NPJ126GY</b>	Chrome	①
	Ivory	<b>NP126I</b>	<b>NPJ126I</b>	S/S 302/304	<b>SS126</b>
	Light Almond	<b>NP126LA</b>	<b>NPJ126LA</b>	S/S 430	<b>SS126L</b>
	White	<b>NP126W</b>	<b>NPJ126W</b>	Steel, Almond	<b>PJS126AL*</b>
				Steel, Gray	<b>PJS126G*</b>
 2-Gang, 1-Duplex, 1-Telephone .406 in. (10.3) Hole Strap Mount	Black	<b>NP128BK</b>	-	Aluminum	-
	Brown	<b>NP128</b>	-	Brass	-
	Gray	<b>NP128GY</b>	-	Brass Plated	-
	Ivory	<b>NP128I</b>	-	Chrome	-
	White	<b>NP128W</b>	-	S/S 302/304	-
				S/S 430	-
 2-Gang, 1-Toggle, 1-Telephone .406 in. (10.3) Hole Strap Mount	Black	<b>NP112BK</b>	-	Aluminum	-
	Brown	<b>NP112</b>	-	Brass	-
	Gray	<b>NP112GY</b>	-	Brass Plated	-
	Ivory	<b>NP112I</b>	-	Chrome	-
	Office White	<b>NP112OW</b>	-	S/S 302/304	-
	White	<b>NP112W</b>	-	S/S 430	-
 2-Gang, 1-Decorator, 1-Telephone .406 in. (10.3) Hole Strap Mount	Black	<b>NP1226BK</b>	-	Aluminum	-
	Brown	<b>NP1226</b>	-	Brass	-
	Gray	<b>NP1226GY</b>	-	Brass Plated	-
	Ivory	<b>NP1226I</b>	-	Chrome	-
	White	<b>NP1226W</b>	-	S/S 302/304	-
				S/S 430	-
 2-Gang, 1-Single Receptacle 1.40 in. (35.6) Hole, 1-Duplex	Almond	<b>NP78AL</b>	-	Aluminum	①
	Brown	<b>NP78</b>	-	Brass	①
	Gray	<b>NP78GY</b>	-	Brass Plated	①
	Ivory	<b>NP78I</b>	-	Chrome	①
	White	<b>NP78W</b>	-	S/S 302/304	<b>SS78</b>
				S/S 430	-
 2-Gang, 1-Single Recept. 1.60 in. (40.6) Hole, 1-Duplex	Almond	-	-	Aluminum	①
	Brown	-	-	Brass	①
	Ivory	-	-	Brass Plated	①
	White	-	-	Chrome	①
				S/S 302/304	<b>SS8720</b>
				S/S 430	-

Note: All standard and mid-size nylon wallplates feature pre-inserted captive screws for faster assembly, up to 6-gang.  
 ①Available as a custom wallplate, see pages N-32 to N-36. Consult custom wallplates section for additional openings and combinations.  
 \*Powder coat paint finish.

**Combination Wallplates, 2-Gang**

Description	Color	Nylon Standard	Nylon Mid-Size	Material	Metal Catalog Number
 <p>2-Gang, 1-Toggle, 1-Single Receptacle 1.40 in. (35.6) Hole</p>	Black	<b>NP17BK</b>	-	Aluminum	⓪
	Brown	<b>NP17</b>	-	Brass	⓪
	Gray	<b>NP17GY</b>	-	Brass Plated	⓪
	Ivory	<b>NP17I</b>	-	Chrome	⓪
	White	<b>NP17W</b>	-	S/S 302/304 S/S 430	<b>SS17</b> -
 <p>2-Gang, 1-Toggle, 1-Blank, Box Mount</p>	Black	<b>NP113BK</b>	-	Aluminum	⓪
	Brown	<b>NP113</b>	<b>NPJ113</b>	Brass	⓪
	Gray	<b>NP113GY</b>	-	Brass Plated	⓪
	Ivory	<b>NP113I</b>	<b>NPJ113I</b>	Chrome	⓪
	Light Almond White	<b>NP113LA</b> <b>NP113W</b>	- -	S/S 302/304 S/S 430	<b>SS113</b> -
 <p>2-Gang, 1-Toggle, 1-Blank, Strap Mount</p>	Black	-	-	Aluminum	⓪
	Brown	-	-	Brass	⓪
	Gray	-	-	Brass Plated	⓪
	Ivory	-	-	Chrome	⓪
	Light Almond White	- -	- -	S/S 302/304 S/S 430	<b>SS114</b> -
 <p>2-Gang, 1-Blank, 1-Duplex, Box Mount</p>	Black	<b>NP138BK</b>	-	Aluminum	⓪
	Brown	<b>NP138</b>	<b>NPJ138</b>	Brass	⓪
	Gray	<b>NP138GY</b>	-	Brass Plated	⓪
	Ivory	<b>NP138I</b>	<b>NPJ138I</b>	Chrome	⓪
	Light Almond White	<b>NP138LA</b> <b>NP138W</b>	- <b>NPJ138W</b>	S/S 302/304 S/S 430	<b>SS138</b> -
 <p>2-Gang, 1-Blank, 1-Duplex, Strap Mount</p>	Black	-	-	Aluminum	⓪
	Brown	-	-	Brass	⓪
	Gray	-	-	Brass Plated	⓪
	Ivory	-	-	Chrome	⓪
	Light Almond White	- -	- -	S/S 302/304 S/S 430	<b>SS148</b> -
 <p>2-Gang, 1-Blank, 1-Decorator, Box Mount</p>	Black	<b>NP1326BK</b>	<b>NPJ1326BK</b>	Aluminum	⓪
	Brown	<b>NP1326</b>	<b>NPJ1326</b>	Brass	⓪
	Gray	<b>NP1326GY</b>	<b>NPJ1326GY</b>	Brass Plated	⓪
	Ivory	<b>NP1326I</b>	<b>NPJ1326I</b>	Chrome	⓪
	Light Almond White	<b>NP1326LA</b> <b>NP1326W</b>	<b>NPJ1326LA</b> <b>NPJ1326W</b>	S/S 302/304 S/S 430	<b>SS1426*</b> -
 <p>2-Gang, 1-Telephone, .406 in. (10.3) Hole, 1-Blank, Strap Mount</p>	Black	<b>NP1214BK</b>	-	Aluminum	-
	Brown	<b>NP1214</b>	-	Brass	-
	Gray	<b>NP1214GY</b>	-	Brass Plated	-
	Ivory	<b>NP1214I</b>	-	Chrome	-
	White	<b>NP1214W</b>	-	S/S 302/304 S/S 430	- -
 <p>2-Gang, 1-Single Receptacle 1.40 in. (35.6) Hole 1-Blank, Strap Mount</p>	Black	<b>NP147BK</b>	-	Aluminum	⓪
	Brown	<b>NP147</b>	-	Brass	⓪
	Gray	<b>NP147GY</b>	-	Brass Plated	⓪
	Ivory	<b>NP147I</b>	-	Chrome	⓪
	White	<b>NP147W</b>	-	S/S 302/304 S/S 430	⓪ -



Note: All standard and mid-size nylon wallplates feature pre-inserted captive screws for faster assembly, up to 6-gang.

⓪ Available as a custom wallplate, see pages N-32 to N-36. Consult custom wallplates section for additional openings and combinations.

\*Strap Mount.







**Combination Wallplates, 3-Gang**

Description	Color	Nylon Standard	Nylon Mid-Size	Material	Metal Catalog Number
 3-Gang, 2-Toggle, 1-Duplex	Brown	<b>NP28</b>	<b>NPJ28</b>	Aluminum	①
	Gray	<b>NP28GY</b>	-	Brass	①
	Ivory	<b>NP28I</b>	<b>NPJ28I</b>	Brass Plated	<b>SBP28</b>
	Light Almond	<b>NP28LA</b>	<b>NPJ28LA</b>	Chrome	①
	White	<b>NP28W</b>	<b>NPJ28W</b>	S/S 302/304	<b>SS28</b>
				S/S 430	-
				Steel, Almond	<b>SP28AL*</b>
				Steel, Gray	<b>SP28G*</b>
 3-Gang, 1-Toggle, 2-Duplex	Black	<b>NP182BK</b>	-	Aluminum	①
	Brown	<b>NP182</b>	-	Brass	①
	Gray	<b>NP182GY</b>	-	Brass Plated	①
	Ivory	<b>NP182I</b>	-	Chrome	①
	White	<b>NP182W</b>	-	S/S 302/304	<b>SS182</b>
				S/S 430	-
 3-Gang, 2-Toggle, 1-Decorator	Black	<b>NP226BK</b>	<b>NPJ226BK</b>	Aluminum	①
	Brown	<b>NP226</b>	<b>NPJ226</b>	Brass	①
	Gray	<b>NP226GY</b>	<b>NPJ226GY</b>	Brass Plated	①
	Ivory	<b>NP226I</b>	<b>NPJ226I</b>	Chrome	①
	Light Almond	<b>NP226LA</b>	<b>NPJ226LA</b>	S/S 302/304	<b>SS226</b>
				S/S 430	-
				Steel, Gray	<b>PJS226G*</b>
 3-Gang, 1-Toggle, 2-Decorator	Black	<b>NP1262BK</b>	-	Aluminum	①
	Brown	<b>NP1262</b>	-	Brass	①
	Gray	<b>NP1262GY</b>	-	Brass Plated	①
	Ivory	<b>NP1262I</b>	-	Chrome	①
	Light Almond	<b>NP1262LA</b>	-	S/S 302/304	①
				S/S 430	-
 3-Gang, 2-Duplex, 1-Blank	Black	-	-	Aluminum	①
	Brown	-	-	Brass	①
	Gray	-	-	Brass Plated	①
	Ivory	-	-	Chrome	①
	Light Almond	-	-	S/S 302/304	<b>SS211</b>
				S/S 430	-
 3-Gang, 1-Duplex, 1-Blank, 1-Duplex	Black	-	-	Aluminum	①
	Brown	-	-	Brass	①
	Gray	-	-	Brass Plated	①
	Ivory	-	-	Chrome	①
	Light Almond	-	-	S/S 302/304	<b>SS8147</b>
				S/S 430	-
 3-Gang, 2-Toggle, 1-Blank	Black	-	-	Aluminum	①
	Brown	-	-	Brass	①
	Gray	-	-	Brass Plated	①
	Ivory	-	-	Chrome	①
	Light Almond	-	-	S/S 302/304	<b>SS213</b>
				S/S 430	-

Note: All standard and mid-size nylon wallplates feature pre-inserted captive screws for faster assembly, up to 6-gang.  
 ①Available as a custom wallplate, see pages N-32 to N-36. Consult custom wallplates section for additional openings and combinations.  
 \*Powder coat paint finish.

**Combination Plates, 4- and 5-Gang**

Description	Color	Nylon Standard	Nylon Mid-Size	Material	Metal Catalog Number
	Brown	<b>NP38</b>	-	Aluminum	①
	Ivory	<b>NP38I</b>	-	Brass	①
	Light Almond	<b>NP38LA</b>	-	Brass Plated	①
	White	<b>NP38W</b>	-	Chrome	①
				S/S 302/304	<b>SS38</b>
			S/S 430	-	
	Black	<b>NP326BK</b>	-	Aluminum	①
	Brown	<b>NP326</b>	-	Brass	①
	Gray	<b>NP326GY</b>	-	Brass Plated	①
	Ivory	<b>NP326I</b>	-	Chrome	①
	Light Almond	<b>NP326LA</b>	-	S/S 302/304	<b>SS326</b>
	White	<b>NP326W</b>	-	S/S 430	-
	Black	<b>NP2262BK</b>	-	Aluminum	①
	Brown	<b>NP2262</b>	-	Brass	①
	Gray	<b>NP2262GY</b>	-	Brass Plated	①
	Ivory	<b>NP2262I</b>	-	Chrome	①
	Light Almond	<b>NP2262LA</b>	-	S/S 302/304	①
	White	<b>NP2262W</b>	-	S/S 430	-
	Brown	<b>NP48</b>	-	Aluminum	①
	Ivory	<b>NP48I</b>	-	Brass	①
	White	<b>NP48W</b>	-	Brass Plated	①
				Chrome	①
				S/S 302/304	①
			S/S 430	-	













Note: All standard and mid-size nylon wallplates feature pre-inserted captive screws for faster assembly, up to 6-gang.  
①Available as a custom wallplate, see pages N-32 to N-36. Consult custom wallplates section for additional openings and combinations.

**Telephone and Coaxial Outlet Plates**

Description	Color	Nylon Standard	Nylon Mid-Size	Material	Metal Catalog Number
 <p>1-Gang, 1-Tel Nylon .406 in. (10.3) Hole, Metal .640 in. (16.3) Hole, Box Mount</p>	Almond	<b>NP11AL</b>	<b>NPJ11AL</b>	Aluminum	①
	Black	<b>NP11BK</b>	-	Brass	①
	Brown	<b>NP11</b>	<b>NPJ11</b>	Brass Plated	①
	Gray	<b>NP11GY</b>	-	Chrome	①
	Ivory	<b>NP11I</b>	<b>NPJ11I</b>	S/S 302/304	<b>SS11*</b>
	Light Almond	<b>NP11LA</b>	<b>NPJ11LA</b>	S/S 430	<b>SS11L*</b>
	Red	<b>NP11R</b>	-		
White	<b>NP11W</b>	<b>NPJ11W</b>			
 <p>1-Gang, 1-Tel Nylon .406 in. (10.3) Hole, Metal .640 in. (16.3) Hole, Strap Mount</p>	Almond	<b>NP12AL</b>	-	Aluminum	①
	Black	<b>NP12BK</b>	-	Brass	<b>SB12*</b>
	Brown	<b>NP12</b>	-	Brass Plated	<b>SBP12*</b>
	Gray	<b>NP12GY</b>	-	Chrome	<b>SCH12*</b>
	Ivory	<b>NP12I</b>	-	S/S 302/304	<b>SS12*</b>
	White	<b>NP12W</b>	-	S/S 430	<b>SS12L*</b>
 <p>1-Gang, 1-Tel .625 in. (15.9) Hole, Box Mount</p>	Almond	<b>NP737AL</b>	-	Aluminum	-
	Brown	<b>NP737</b>	-	Brass	-
	Ivory	<b>NP737I</b>	-	Brass Plated	-
	White	<b>NP737W</b>	-	Chrome	-
				S/S 302/304	-
S/S 430			S/S 430	-	
 <p>1-Gang, 1-Tel .625 in. (15.9) Hole, Strap Mount</p>	Brown	<b>NP730</b>	-	Aluminum	-
	Ivory	<b>NP730I</b>	-	Brass	-
	White	<b>NP730W</b>	-	Brass Plated	-
				Chrome	-
				S/S 302/304	-
S/S 430			S/S 430	-	
 <p>1-Gang, 1-Tel .380 in. (9.7) Hole, Box Mount or Strap Mount</p>	Almond	-	-	Aluminum	①
	Brown	-	-	Brass	①
	Ivory	-	-	Brass Plated	①
	White	-	-	Chrome	①
				S/S 302/304	<b>SS739</b>
				S/S 302/304, Strap Mount	<b>SS738</b>
S/S 430			S/S 430	-	
 <p>2-Gang, 2-Tel Nylon .406 in. (10.3) Hole, Metal .640 in. (16.3) Hole, Box Mount</p>	Black	<b>NP21BK</b>	-	Aluminum	①
	Brown	<b>NP21</b>	-	Brass	①
	Gray	<b>NP21GY</b>	-	Brass Plated	①
	Ivory	<b>NP21I</b>	-	Chrome	①
	White	<b>NP21W</b>	-	S/S 302/304, Strap Mount	<b>SS22*</b>
				S/S 430	-
 <p>2-Gang, 1-Tel .640 in. (16.3) Hole, Box Mount</p>	Almond	-	-	Aluminum	-
	Brown	-	-	Brass	-
	Ivory	-	-	Brass Plated	-
	White	-	-	Chrome	-
				S/S 302/304	<b>SS741*</b>
S/S 430			S/S 430	-	

Note: All standard and mid-size nylon wallplates feature pre-inserted captive screws for faster assembly, up to 6-gang.  
 ①Available as a custom wallplate, see pages N-32 to N-36. Consult custom wallplates section for additional openings and combinations.  
 \*.50" (12.7) I.D. nylon bushing provided.

**Jumbo, Smooth, Stainless Steel Type 302/304 Wallplates**

Configuration	Catalog Number	Configuration	Catalog Number
1-Gang, 1-Toggle 	<b>SSJ1</b>	1-Gang, 1-Single Receptacle for 2.09–2.13 in. (53.1–54.1) Dia. Face 	<b>SSJ723</b>
2-Gang, 2-Toggle 	<b>SSJ2</b>	1-Gang, 1-Blank, Box Mount 	<b>SSJ13</b>
1-Gang, 1-Duplex 	<b>SSJ8</b>	1-Gang, 1-Telephone Opening, .640 in. (16.3) Box Mount 	<b>SSJ11*</b>
2-Gang, 2-Duplex 	<b>SSJ82</b>	2-Gang, 1-Toggle, 1-Duplex 	<b>SSJ18</b>
1-Gang, 1-Decorator 	<b>SSJ26</b>	2-Gang, 1-Toggle, 1-Decorator 	<b>SSJ126</b>
2-Gang, 2-Decorator 	<b>SSJ262</b>		
1-Gang, 1-Single Receptacle for 1.36–1.39 in. (34.5–35.3) Dia. Face 	<b>SSJ7</b>		

Note: \*.50 in. (12.7) I.D. nylon bushing provided.  
Specifications are subject to change without notice.

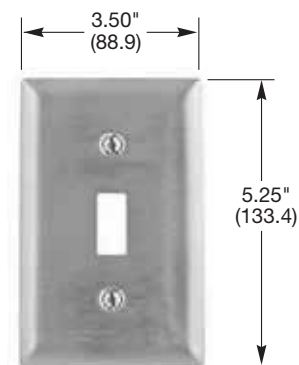



**Jumbo Wallplate**

Oversize dimensions (see page N-31 for more details).  
1-Gang, 5.25 in. x 3.50 in. (133.4 x 88.9).  
2-Gang, 5.25 in. x 5.31 in. (133.4 x 134.9).  
3-Gang, 5.25 in. x 7.12 in. (133.4 x 180.8).

Dimensions in Inches (mm)

**Pre-Marked "EMERGENCY" Wallplates**

Description	Color	Nylon Standard	Nylon Mid-Size	Material	Metal Catalog Number
1-Gang, 1-Duplex, paint filled white lettering 	Red	-	<b>NPJ8RMEV</b>	Aluminum Brass Brass Plated Chrome S/S 302/304 S/S 430	- - - - <b>SS8MEV</b> -
1-Gang, 1-Toggle, paint filled white lettering 	Red	-	<b>NPJ1RME</b>	Aluminum Brass Brass Plated Chrome S/S 302/304 S/S 430	- - - - <b>SS1ME</b> -
2-Gang, 2 Duplex, paint filled red lettering 	-	-	-	Aluminum Brass Brass Plated Chrome S/S 302/304 S/S 430	- - - - <b>SS82MEV</b> -

Note: See page N-31 for mid-size plate dimensions.  
All lettering .25 in. (6.3) high.



**Stainless Steel Barrel Key Switch Wallplates**

Description	1-Gang, with on/off markings	1-Gang, with position markings	2-Gang, with on/off markings	2-Gang, with position markings
Stainless steel, 302/304, smooth.	<b>SS12RKL</b> 	<b>SS12RKLM</b> 	<b>SS22RKL</b> 	<b>SS22RKLM</b> 





Note: See page D-6 for barrel key switch selection.

**Single Count Screws and Accessories**



Description	Catalog Number
Stainless steel screw, standard slot, .38 in. (9.7) long.	<b>HBL7341SS</b>
Security spanner head screws, 6-32 thread, 100 count.	<b>HBL7342RKL</b>
Screwdriver with spanner head security bit.	<b>HBL7372RKL</b>



**Pre-Marked "ISOLATED GROUND" Wallplates**

Description	Color	Nylon Standard	Nylon No Marking	Material	Metal Catalog Number
1-Gang, 1-Duplex, paint filled black 	Orange	<b>NP8OIG</b>	<b>NP8OR</b>	Aluminum Brass Brass Plated Chrome S/S 302/304 S/S 430	- - - - - -
1-Gang, 1-Decorator, paint filled black 	Orange	<b>NP26OIG</b>	-	Aluminum Brass Brass Plated Chrome S/S 302/304 S/S 430	- - - - - -
1-Gang, 1-Single Recept. 1.40 in. (35.6) Hole for 1.36–1.39 in. (34.5–35.3) Dia. face, paint filled black 	Orange	<b>NP7OIG</b>	-	Aluminum Brass Brass Plated Chrome S/S 302/304 S/S 430	- - - - - -
1-Gang, 1-Single Recept. 1.60 in. (40.6) Hole for 20 and 30A Twist-Lock® with 1.55–1.58 in. (39.4–40.1) Dia. face, paint filled black 	Orange	<b>NP720OIG</b>	-	Aluminum Brass Brass Plated Chrome S/S 302/304 S/S 430	- - - - - -

**Pre-Marked "COMPUTER ONLY" Wallplates**

Description	Color	Nylon Standard	Nylon Mid-Size	Material	Metal Catalog Number
1-Gang, 1-Duplex, paint filled black 	Orange Ivory	- -	<b>NPJ8CO</b> <b>NPJ8C</b>	Aluminum Brass Brass Plated Chrome S/S 302/304 S/S 430	- - - - - -
2-Gang, 2-Duplex, paint filled black 	Orange	-	<b>NPJ82CO</b>	Aluminum Brass Brass Plated Chrome S/S 302/304 S/S 430	- - - - - -
1-Gang, 1-Decorator, paint filled black 	Blue Ivory	- -	<b>NPJ26CBL</b> <b>NPJ26C</b>	Aluminum Brass Brass Plated Chrome S/S 302/304 S/S 430	- - - - - -

**Louver Plate, 1-Gang, Box Mount**

Description	Color	Nylon Standard	Nylon Mid-Size	Material	Metal Catalog Number
1-Gang, Vertical Mounted Louver 	- - - -	- - - -	- - - -	Aluminum Brass Brass Plated Chrome S/S 302/304 S/S 430	⓪ <b>SB771</b> <b>SBP771</b> ⓪ <b>SS771</b> -

Note: \*See page N-31 for mid-size plate dimensions.

⓪Available as a custom wallplate, see pages N-32 to N-36. Consult custom wallplates section for additional openings and combinations.

### 1-Gang, White

Description	Catalog Number
1-Toggle switch	SWP1
1-Duplex receptacle	SWP8
1-GFCI/Style Line® opening	SWP26
1-Telephone or TV opening .640 in. (16.3)	SWP12
1-Blank	SWP13



SWP1



SWP8

### 2-Gang, White

Description	Catalog Number
2-Toggle switches	SWP2
2-Duplex receptacles	SWP82
1-Toggle switch, 1-Duplex receptacle	SWP18
2-GFCI/Style Line® openings	SWP262
1-Toggle switch, 1-GFCI/Style Line® opening	SWP126
1-Duplex receptacle, 1-Telephone or TV	SWP812
1-Duplex receptacle, 1-Blank	SWP813
2-Blank	SWP23



SWP82



SWP18



SWP28

### 3-Gang, White

Description	Catalog Number
2-Toggle switches, 1-Duplex receptacle	SWP28

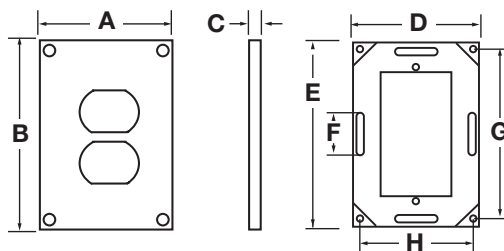

### Dimensions

	A	B	C	D	E	F	G	H
1-Gang	3.77"	5.52"	.55"	3.37"	5.13"	1.00"	4.63"	2.88"
in. (mm)	(95.8)	(140.2)	(14.0)	(85.6)	(130.3)	(25.4)	(117.6)	(73.2)
2-Gang	5.52"	5.52"	.55"	5.13"	5.13"	1.00"	4.63"	4.63"
in. (mm)	(140.2)	(140.2)	(14.0)	(130.3)	(130.3)	(25.4)	(117.6)	(117.6)
3-Gang	7.39"	5.52"	.55"	7.00"	5.13"	1.00"	4.63"	6.50"
in. (mm)	(187.71)	(140.21)	(14.0)	(177.8)	(130.3)	(25.4)	(117.6)	(165.1)

### Specifications

Tamper resistant wallplate 1-gang duplex receptacle shall be of the following construction:

Cover plate: One piece #14 cold rolled zinc plated steel. Plate shall have a five stage baked white polyester powder enamel finish. Gloss: 85%; reflectance: 93%; hardness minimum: 2H and pass 600 hour salt spray test.

Back plate: #10 cold rolled galvanized steel. Plate assembly shall use four (4) #8-32 X 1/2 inch stainless steel T-15 TORX® head screws with center pin reject. Plate must be UL listed to UL 514D and comply with the NEC®.

TORX® is a registered trademark of Textron Inc.  
NEC® is a registered trademark of the The National Electrical Code.

Dimensions in Inches (mm)



**HBL96067**  
Shown with receptacle  
(sold separately)



**HBL6187**  
Shown with receptacle  
and back box  
(sold separately)

### Brass Locking Cover Plate

Description	Catalog Number
Locking cover plate for single 15 and 20A straight blade receptacles and 15A Twist-Lock® receptacles. Straight cylinder type lock. All cylinder locks keyed alike.	<b>HBL96067</b>

### Weather Shield Plate

Description	Catalog Number
20° angle plate for duplex receptacles.	<b>HBL6187</b>

### Catalog Number of Receptacles in Groups A through E below

Group A		Group B			Group C	Group D	Group E
Boss diameter 1.36" to 1.39" (34.5 to 35.3)		Boss diameter 1.55" to 1.58" (39.4 to 40.1)			Boss diameter 1.68" to 1.72" (42.7 to 43.7)	Boss diameter 2.09" to 2.13" (53.1 to 54.1)	Boss diameter 2.28" to 2.44" (57.9 to 62.0)
HBL23000HG	HBL5661	HBL23CM10	HBL2530	HBL2770	HBL45105	HBL7962	HBL7301A
HBL23030	HBL6810	HBL2310	HBL26CM10	HBL2810	HBL45205	HBL9350	HBL8330A
HBL4560	HBL7210B	HBL2320	HBL2610	HBL2820	HBL45305	HBL9308	HBL8350A
HBL4710	HBL7250	HBL2330	HBL2620	HBL2830	HBL45905	HBL9315	HBL8430A
HBL4760	HBL7310B	HBL2340	HBL2630	HBL3330		HBL9330	HBL8450A
HBL5251	HBL7310BG	HBL2410	HBL2640	HBL3330G		<b>HBL9360•</b>	HBL8460A
HBL52CM61	HBL7535	HBL2420	HBL2650	HBL3430		<b>HBL9365•</b>	HBL9430A
HBL5261	HBL7582	HBL2430	HBL2710	HBL3430G		<b>HBL9367•</b>	HBL9450A
HBL53CM61	HBL8210	HBL2440	HBL2720	HBL3520			HBL9460A
HBL5361	HBL8310	HBL2450	HBL2730	HBL7410B			
HBL5461	HBL8410	HBL2460	HBL2740	HBL7410BG			
HBL5552B	HBL8420	HBL2510	HBL2750				
		HBL2520	HBL2760				

Note: •50A 2P 3W.

### Wallplates for Single Receptacles

Description	Group A		Group B		Group C		Group D		Group E
	Boss diameter 1.36" to 1.39" (34.5 to 35.3)		Boss diameter 1.55" to 1.58" (39.4 to 40.1)		Boss diameter 1.68" to 1.72" (42.7 to 43.7)		Boss diameter 2.09" to 2.13" (53.1 to 54.1)		Boss diameter 2.28" to 2.44" (57.9 to 62.0)
	1-Gang	2-Gang	1-Gang	2-Gang	1-Gang	2-Gang	1-Gang	2-Gang	2-Gang
Smooth nylon, brown.	NP7*	-	NP720*	-	-	-	NP724*	NP703*	-
Cast aluminum.	HBL7320	-	HBL7320	-	HBL3394	-	HBL9419	-	-
Stainless steel, 302/304, smooth.	SS7**	SS72	SS720	-	SS725	-	SS723	SS703	SS701

Note: See pages N-6 and N-7 for complete plate descriptions.

\*Catalog number indicated is Brown, add with the following to designate color: "AL" (Almond), "BK" (Black), "GY" (Gray), "I" (Ivory), and "W" (white).

\*\*Catalog number indicated is Stainless Steel, replace "SS" with the following prefix to designate material: "SA" for Anodized Aluminum, "SB" for Solid Brass.

### Weatherproof Lift Covers for WDL "Closed" and WDL "Open", Wet Locations, 1-Gang

Description	Group A	Group B	Group C	Group D	50A Twist-Lock® Receptacles	30A 4W Hubbell® Receptacles
	Boss diameter 1.36" to 1.39" (34.5 to 35.3)	Boss diameter 1.55" to 1.58" (39.4 to 40.1)	Boss diameter 1.68" to 1.72" (42.7 to 43.7)	Boss diameter 2.09" to 2.13" (53.1 to 54.1)		
Thermoplastic, with cover "open", gray.	HBL7423WO	HBL7425WOA	HBL7424WO	-	HBL7774WO▲	-
Thermoplastic, with cover "open", yellow.	HBL74CM23WO	HBL74CM25WOA	HBL74CM24WO	-	HBL77CM74WO▲	-
Cast aluminum, with cover "closed".	HBL7420	HBL7420	HBL3393	HBL9420 HBL9425•	HBL7770	HBL20405† HBL20446†

Note: •50A 2P 3W.

▲The "CS" versions of 50A Twist-Lock® receptacles will only fit these thermoplastic plates.

†HBL20446 plate painted red for use with HBL20443 only. HBL20405 plate is for use with HBL20403 only. See page B-65 for devices.



**IP44**  
SUITABILITY

**For Receptacles with Face Diameters of 2.28–2.44 in. (57.9–62.0)**

Description	Catalog Number
Thermoplastic, 2-gang, wet and damp locations with cover "closed", gray.	<b>HBL7777A<sup>▲</sup></b>
Thermoplastic, 2-gang, wet and damp locations with cover "closed", yellow.	<b>HBL77CM77A<sup>▲</sup></b>
Thermoplastic, 2-gang, wet and damp locations with cover "closed", gray.	<b>HBL7777<sup>▽</sup></b>



HBL7777A

**For Receptacles with Face Diameters of 2.09–2.13 in. (53.1–54.1)**

Description	Catalog Number
Cast aluminum, wet locations only when cover "closed" and damp locations.	<b>HBL9420</b>
Cast aluminum, no lift cover. NOT weatherproof.	<b>HBL9419</b>



HBL9420

**For 50A Twist-Lock<sup>®</sup> Single Receptacles**

Description	Catalog Number
Thermoplastic, wet and damp locations with cover "open", gray.	<b>HBL7774WO*</b>
Thermoplastic, wet and damp locations with cover "open", yellow.	<b>HBL77CM74WO*</b>
Cast aluminum, wet locations only when cover "closed" and damp locations.	<b>HBL7770</b>
Galvanized Steel, fits 4" square or 2-gang box.	<b>HBL50SC**</b>
Stainless steel, single gang, wallplate. NOT weatherproof.	<b>SS750<sup>▲</sup></b>



HBL7774WO

**For 30A, 4 Wire Hubbellock<sup>®</sup> Receptacles**

Description	Catalog Number
Thermoplastic, wet and damp locations with cover "open", gray.	<b>HBL7428WOG*</b>
Thermoplastic, wet and damp locations with cover "open", yellow.	<b>HBL7428WOY*</b>
Thermoplastic, wet and damp locations with cover "open", red.	<b>HBL7428WOR*</b>
Cast aluminum, wet locations only when cover "closed" and damp locations, lift cover plate.	<b>HBL20405</b>
Cast aluminum, wet locations only when cover "closed" and damp locations, red finish.	<b>HBL20446</b>
Cast aluminum, no lift cover. NOT weatherproof.	<b>HBL20406</b>



HBL7770

Note: <sup>▲</sup>Will fit FS/FD boxes having plate mounting holes on 3.25 in. x 3.75 in. (82.6 x 95.3) centers.  
<sup>▽</sup>Will only fit old style porcelain face devices.  
 \*The "CS" versions of 50A Twist-Lock<sup>®</sup> will only fit these plates.  
 \*\*IP20 Suitability.

**Weatherproof Covers for Single Receptacles for Use on FS/FD Boxes**

Note: All weatherproof plates are UL Listed for WET LOCATIONS WITH COVER CLOSED, for intermittent use in wet locations or use in damp locations. Those with suffix "WO" are listed for WET LOCATIONS with cover open in continuous use. All plates are gasketed and self-closing.

**Accessories**

Description	Catalog Number
Sub-plate for mounting and weatherproofing flanged devices with mounting centers of 1.76", 1.94" or 2.13" such as HBL7556, HBL4716, etc. when used with a HBL7420 or HBL7425WOA type weatherproof plate.	<b>7452<sup>•</sup></b>
Adapter plate for mounting HBL7423WO, HBL7424WO, HBL7425WOA or HBL7420 plates to standard boxes.	<b>HBL7349<sup>•</sup></b>

Note: <sup>•</sup>Not UL Listed.



HBL20405



HBL7349

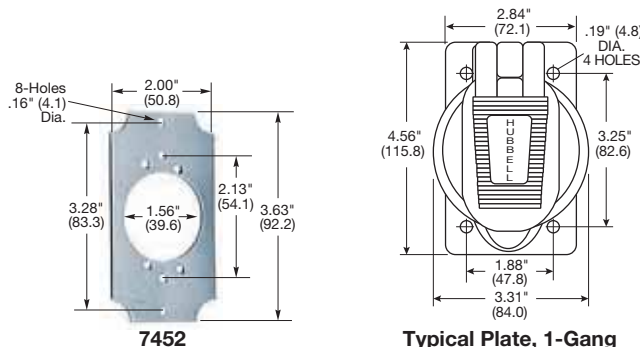

# Wallplates Weatherproof Covers for Receptacles and Switches

Vertical, for FS/FD box mounting



HBL7423WO



HBL7425WOA



HBL7420



HBL7320



HBL7424WO



HBL3393

## For Receptacles with Face Diameters of 1.36–1.39 in. (34.5–35.3)

**IP44**  
SUITABILITY

Description	Catalog Number
Thermoplastic, wet and damp locations with cover "open", gray.	HBL7423WO
Thermoplastic, wet and damp locations with cover "open", yellow.	HBL74CM23WO
Cast aluminum, wet location only when cover "closed" and damp locations.	HBL7420
Cast aluminum, no lift cover, NOT weatherproof.	HBL7320*

## For Switches and Receptacles with Face Diameters of 1.55–1.58 in. (39.4–40.1)

Description	Catalog Number
Thermoplastic, wet and damp locations with cover "open", gray.	HBL7425WOA
Thermoplastic, wet and damp locations with cover "open", yellow.	HBL74CM25WOA
Thermoplastic, wet and damp locations with cover "open", white.	HBL74CM25WOAW
Cast aluminum, wet and damp locations with cover "closed."	HBL7420*
Cast aluminum, no lift cover, NOT weatherproof.	HBL7320*
Thermoplastic, wet and damp locations with cover "open", gray.	HBL7428WOG**
Thermoplastic, wet and damp locations with cover "open", yellow.	HBL7428WOY**
Thermoplastic, wet and damp locations with cover "open", red.	HBL7428WOR**

## For Receptacles with Face Diameters of 1.68–1.72 in. (42.7–43.7)

Description	Catalog Number
Thermoplastic, wet and damp locations with cover "open", gray.	HBL7424WO
Thermoplastic, wet and damp locations with cover "open", yellow.	HBL74CM24WO
Cast aluminum, wet location only when cover "closed" and damp locations.	HBL3393
Cast aluminum, no lift cover, NOT weatherproof.	HBL3394*

Note: \*Cast aluminum lift cover with fibershield for standard toggle and PresSwitch® Switches.

\*\*Features two #6-32 threaded inserts to back mount device to cover.

\*IP20 SUITABILITY.

All weatherproof lift cover plates on this page are UL Listed as "WDL Closed" for use in wet locations with cover closed and in damp locations.

## Weatherproof Covers for Single Receptacles on FS/FD Boxes

Note: All weatherproof plates are UL Listed for WET LOCATIONS WITH COVER CLOSED for intermittent use in wet locations or use in damp locations. Those with suffix "WO" are listed for WET LOCATIONS with cover open in continuous use. All plates are gasketed and self-closing.

## 2011 National Electrical Code (NEC®)

### 406.9 Receptacles in Damp or Wet Locations.

(A) Damp Locations. A receptacle installed outdoors in a location protected from the weather or in other damp locations shall have an enclosure for the receptacle that is weatherproof when the receptacle is covered (attachment plug cap not inserted and receptacle covers closed). An installation suitable for wet locations shall also be considered suitable for damp locations. A receptacle shall be considered to be in a location protected from the weather where located under roofed open porches, canopies, marquees, and the like, and will not be subjected to a beating rain or water runoff. All 15 and 20A, 125 and 250V nonlocking receptacles shall be listed weather-resistant type. FPN: The types of receptacles covered by this requirement are identified as 5-15, 5-20, 6-15 and 6-20 in ANSI/NEMA WD 6-2002, National Electrical Manufacturers Association Standard for Dimensions of Attachment Plugs and Receptacles.

(B) Wet Locations. 15 and 20A, 125 and 250V receptacles installed in a wet location shall have an enclosure that is weatherproof whether or not the attachment plug cap is inserted. For other one or two family dwellings, an outlet box hood installed for this purpose shall be listed, and where installed on an enclosure supported from grade as described in 314.23(B) or as described in 314.23(F) shall be identified as "extra-duty". All 15 and 20A, 125 and 250V nonlocking type receptacles shall be listed weather resistant type.

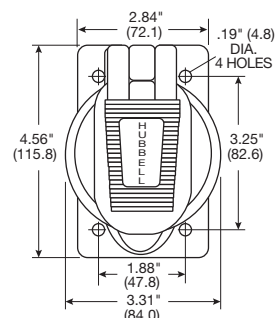

Typical Plate, 1-Gang

NEC® is a registered trademark of the The National Electrical Code.

Wallplates  
**Weatherproof Covers for Flanged Devices**  
*For Flanged Inlets and Flanged Receptacles*



**Weatherproof Thermoplastic Cover  
 For Flanged Inlets and Flanged Receptacles**

**IP44**  
 SUITABILITY

Description	Catalog Number
For use with 15 and 20A, 2 pole, 2 wire and 2 pole, 3 wire Insulgrip® flanged inlets and flanged receptacles below.	WP1



**Straight Blade, 2 pole, 3 wire  
 Flanged Inlets**

**Flanged Receptacles**

	HBL5278C HBL5378C HBL5478C HBL5678C		HBL5279C HBL5379C HBL5479C HBL5679C
---	--	---	--

**Twist-Lock®, 2 pole, 2 wire and 2 pole, 3 wire  
 Flanged Inlets**

**Flanged Receptacles**

	HBL8815C HBL7524C HBL4716C HBL4586C HBL4786C		HBL8809C HBL7526C HBL4715C HBL4585C HBL4785C
---	--	---	--



**Weatherproof Thermoplastic Cover  
 For Flanged Inlets and Flanged Receptacles**

Description	Catalog Number
For 20 and 30A, 3, 4, and 5 wire Insulgrip flanged inlets and flanged receptacles below.	WP2

**Twist-Lock®, 2 pole, 3 wire; 3 pole, 4 wire; 4 pole, 4 wire; 4 pole, 5 wire  
 Flanged Inlets**

	HBL2315 HBL2325 HBL2335 HBL2345 HBL2355 HBL2415 HBL2425 HBL2435	HBL2445 HBL2455 HBL2465 HBL2515 HBL2525 HBL2535 HBL2615 HBL2625	HBL2635 HBL2645 HBL2655 HBL2715 HBL2725 HBL2735 HBL2745 HBL2755	HBL2765 HBL2775 HBL2815 HBL2825 HBL2835 HBL3325C HBL3334C HBL7408C
---	--	--	--	---

**Flanged Receptacles**

	HBL2316 HBL2326 HBL2336 HBL2346 HBL2356 HBL2416 HBL2426 HBL2436	HBL2446 HBL2456 HBL2466 HBL2516 HBL2526 HBL2536 HBL2616 HBL2626	HBL2636 HBL2646 HBL2656 HBL2716 HBL2726 HBL2736 HBL2746 HBL2756	HBL2766 HBL2776 HBL2816 HBL2826 HBL2836 HBL3326C HBL3335C HBL7409C
---	--	--	--	---



WP1



WP2

**Weatherproof Thermoplastic Cover  
 For Flanged Inlets 50 Amp CS Series**

Description	Catalog Number
For 50A, 2 pole, 3 wire and 3 pole, 4 wire flanged inlets below.	HBL7780

**Twist-Lock®, 2 pole, 3 wire; 3 pole, 4 wire  
 Flanged Inlets**

	CS6377 CS8275 CS8475	CS6375 CS8375 CS8175	HBL3777 HBL3775 HBL7958
---	----------------------------	----------------------------	-------------------------------



HBL7780



HBL1795



HBL1750



HBL1785



HBL7420



HBL96061  
shown with wallplate and  
switch (sold separately)



HBLWLC

**IP44**  
SUITABILITY

### Weatherproof Plates

Description	Catalog Number
Clear bubble plate, silicone rubber for use with all general purpose AC toggle and PresSwitch® Switches. Fits both FS/FD and standard boxes.	HBL1795

### Weatherproof Plates

Description	Catalog Number
Gray neoprene PresSwitch® Plate. Fits FS/FD and standard boxes.	HBL1750*
Same as above except yellow.	HBL17CM50*

Note: \*Not UL Listed.

### Weatherproof Plates

Description	Catalog Number
Gray neoprene PresSwitch® Plate with 125V red pilot light. Fits only FS/FD boxes.	HBL1785*
Same as above except yellow.	HBL17CM85*

Note: \*Not UL Listed.

### Weatherproof Covers

Description	Catalog Number
Cast aluminum lift cover plate with fiber shield. For standard toggle and PresSwitch® Switches. Fits only FS/FD boxes.	HBL7420

### Brass Locking Covers Attachment for Switches

Description	Catalog Number
Straight keying (all locks alike) appropriate for most applications. Straight cylinder type lock, each HBL96061 ordered operates on the same key—all locks are keyed alike.	HBL96061*
Same as above except in dull chrome finish to match stainless steel plates.	HBL96061DCH*
Straight keying (individual). Straight cylinder type lock, each HBL96062 ordered operates on a different key. All locks are keyed differently and individually. This type cannot be master keyed.	HBL96062*

Note: \*Not UL Listed.

### Locking Device

Description	Catalog Number
Locking device for weatherproof covers.	HBLWLC

# Wallplates Heavy Duty Weatherproof Covers for Duplex, GFCI, Surge Receptacles and Style Line® Devices



**IP44**  
SUITABILITY

## Duplex Covers For Vertical Mounting

Description	Dimensions		Catalog Number
	Height x Width x Depth		
Thermoplastic, gray, for FS/FD box mounting.	4.56" x 2.89" x 1.08" (115.8 x 73.4 x 27.4)		<b>HBL5221</b>
Thermoplastic, yellow, for FS/FD box mounting.	4.56" x 2.89" x 1.08" (115.8 x 73.4 x 27.4)		<b>HBL52CM21</b>
Thermoplastic, white, for FS/FD box mounting.	4.56" x 2.89" x 1.08" (115.8 x 73.4 x 27.4)		<b>HBL52CM21W</b>
Thermoplastic, gray, for device mounting.	4.56" x 2.89" x 1.08" (115.8 x 73.4 x 27.4)		<b>HBL5222</b>
Thermoplastic, yellow, for device mounting.	4.56" x 2.89" x 1.08" (115.8 x 73.4 x 27.4)		<b>HBL52CM22</b>
Die cast aluminum, gray, commercial grade, vertical position, device mount.	4.56" x 2.81" x 0.75" (115.8 x 71.4 x 19.1)		<b>WP8V</b>



HBL5221



WP8V

## Duplex Covers For Horizontal Mounting

Description	Dimensions		Catalog Number
	Height x Width x Depth		
Cast aluminum, for device mounting.	2.88" x 4.56" x 0.79" (73.2 x 115.8 x 20.1)		<b>HBL5205WO</b>
Cast aluminum, for FS/FD box mounting.	2.88" x 4.56" x 0.79" (73.2 x 115.8 x 20.1)		<b>HBL5206WO</b>
Die cast aluminum, gray, commercial grade, horizontal position, device mount.	2.90" x 4.60" x 0.75" (73.7 x 116.8 x 19.1)		<b>WP8H</b>



HBL5206WO



WP8H

## GFCI, Surge and Style Line® Covers

Description	Dimensions		Catalog Number
	Height x Width x Depth		
Die cast aluminum, gray, commercial grade, vertical position, device mount.	4.56" x 2.81" x 0.75" (115.8 x 71.4 x 19.1)		<b>WP26V</b>
Die cast aluminum, gray, commercial grade, horizontal position, device mount.	2.30" x 4.75" x 0.73" (58.4 x 120.7 x 18.5)		<b>WP26H</b>



WP26V



WP26H

## Toggle Cover

Description	Dimensions		Catalog Number
	Height x Width x Depth		
Thermoplastic, gray, for FS/FD box mounting.	4.56" x 2.89" x 1.08" (115.8 x 73.4 x 27.4)		<b>HBL5201</b>

*Note: All weatherproof plates are UL Listed for WET LOCATIONS WITH COVER CLOSED, for intermittent use in wet locations or use in damp locations. Those with Suffix "WO" are listed for WET LOCATIONS with cover open in continuous use. All plates are gasketed and self-closing.*

### 1-Gang Weatherproof Covers for Vertical Mounting

Description	Dimensions		Catalog Number
	Height	Width x Depth	
Zinc die cast, gray, duplex cover for box mounting.	4.58"	2.82" x 0.57"	<b>RW51470</b>
Zinc die cast, gray, 1.40 in. (35.6) cover for single receptacle or toggle switch for device mounting.	4.56"	2.81" x 0.88"	<b>RW51550*</b>
Zinc die cast, gray, GFCI, Surge and Style Line® cover for device mounting.	4.58"	2.81" x 0.57"	<b>RW51040</b>

### 1-Gang Weatherproof Covers for Horizontal Mounting

Description	Dimensions		Catalog Number
	Height	Width x Depth	
Zinc die cast, gray, duplex cover for device mounting.	2.82"	4.57" x 0.79"	<b>RW51810</b>
Zinc die cast, gray, 1.40 in. (35.6) cover for single receptacle or toggle switch for device mounting.	2.81"	4.56" x 0.99"	<b>RW51520*</b>
Zinc die cast, gray, GFCI, Surge and Style Line® cover for device mounting.	2.82"	4.56" x 0.52"	<b>RW51020</b>

### 2-Gang Weatherproof Covers for Vertical Mounting

Description	Dimensions		Catalog Number
	Height	Width x Depth	
Zinc die cast, gray, duplex cover for device mounting.	4.54"	4.54" x 0.75"	<b>RW51320</b>
Zinc die cast, gray, one duplex/one GFCI, Surge and Style Line® cover for box mounting.	4.54"	4.54" x 0.77"	<b>RW51330</b>
Zinc die cast, gray, 1.40 in. (35.6) cover for single receptacle or toggle switch for device mounting.	4.54"	4.54" x 0.77"	<b>RW51380</b>
Zinc die cast, gray, two GFCI, Surge and Style Line® cover for box mounting.	4.54"	4.56" x 0.73"	<b>RW51450</b>

*Note: All weatherproof plates are UL Listed for WET LOCATIONS WITH COVER CLOSED, for intermittent use in wet locations or use in damp locations. All plates are gasketed and self-closing.  
\*cULus Listed.*



**RW51470**

**RW51550**



**RW51040**



**RW51810**



**RW51520**



**RW51020**



**RW51320**



**RW51330**



**RW51380**



**RW51450**

**Features**

Extra-Duty Metallic While-in-Use Covers are designed for use whenever protection is required while an outlet is in use. Covers meet or exceed the extra-duty rating per UL 514D, and are NEMA 3R rated.

- Superior commercial quality die-cast aluminum construction
- Meets or exceeds Extra-Duty rating in UL 514D
- Unique lid design allows larger plugs and provides more room for bend radius of electrical cords

- Provision on each side for holding cords – Reduces pull-outs
- Padlockable – Accepts standard size padlocks
- Includes gasket and hardware
- Powder coated for corrosion protection
- Device or box mounting
- NEMA 3R rated
- Can be installed to comply with 2011 NEC 406.9(B) (See page N-22).

**1-Gang Extra-Duty Metallic While-In-Use Covers for Vertical Mounting**

Description	Dimensions Height x Width x Depth	Catalog Number
While-in-Use cover, gray, 1-gang, duplex cover for vertical mounting.	6.5" x 3.1" x 3.3" (165.1 x 78.7 x 83.2)	<b>WP8E</b>
While-in-Use cover, gray, 1-gang, round hole 1.55" or 2.10" cover, for vertical mounting.	6.5" x 4.5" x 3.3" (165.1 x 114.3 x 83.2)	<b>WP700E</b>
While-in-Use cover, gray, 1-gang, GFCI cover for vertical mounting.	6.5" x 3.1" x 3.3" (165.1 x 78.7 x 83.2)	<b>WP26E</b>



**1-Gang Extra-Duty Metallic While-In-Use Covers for Horizontal Mounting**

Description	Dimensions Height x Width x Depth	Catalog Number
While-in-Use cover, gray, 1-gang, duplex cover for horizontal mounting.	4.7" x 5.1" x 3.3" (119.4 x 129.5 x 83.2)	<b>WP8EH</b>
While-in-Use cover, gray, 1-gang, GFCI cover for horizontal mounting.	4.7" x 5.1" x 3.3" (119.4 x 129.5 x 83.2)	<b>WP26EH</b>



**2-Gang Extra-Duty Metallic While-In-Use Covers for Vertical Mounting**

Description	Dimensions Height x Width x Depth	Catalog Number
While-in-Use cover, gray, 2-gang, double duplex cover for vertical mounting.	6.5" x 5.1" x 3.3" (165.1 x 129.5 x 83.2)	<b>WP82E</b>
While-in-Use cover, gray, 2-gang, GFCI and duplex cover for vertical mounting.	6.5" x 5.1" x 3.3" (165.1 x 129.5 x 83.2)	<b>WP268E</b>
While-in-Use cover, gray, 2-gang, double GFCI cover for vertical mounting.	6.5" x 5.1" x 3.3" (165.1 x 129.5 x 83.2)	<b>WP262E</b>



**IP66**  
 SUITABILITY



RW57300

**1-Gang Weatherproof Covers for Vertical Mounting**

Description	Dimensions		Catalog Number
	Height	Width x Depth	
Thermoplastic, gray, duplex, GFCI, toggle and single receptacles, diameter 1.34", 1.40", 1.60", 1.72", 2.03" and 2.15"	5.8"	3.5" x 2.8" (147.3 x 88.9 x 71.1)	<b>RW57300</b>



RW57350

Thermoplastic, gray, extra deep, duplex, GFCI, toggle and single receptacles, diameter 1.34", 1.40", 1.60", 1.72", 2.03" and 2.15"	5.8"	3.5" x 4.8" (147.3 x 88.9 x 121.9)	<b>RW57350</b>
--	------	---------------------------------------	----------------



**1-Gang Weatherproof Covers for Horizontal Mounting**

Description	Dimensions		Catalog Number
	Height	Width x Depth	
Thermoplastic, gray, duplex, GFCI, toggle and single receptacles, diameter 1.34", 1.40", 1.60", 1.72", 2.03" and 2.15"	4.0"	5.2" x 2.8" (101.6 x 132.1 x 71.1)	<b>RW57400</b>



RW57400



RW57750

**2-Gang Weatherproof Covers for Vertical Mounting**

Description	Dimensions		Catalog Number
	Height	Width x Depth	
Thermoplastic, gray, duplex, GFCI, toggle and single receptacles, diameter 1.34", 1.40", 1.60", 1.72", 2.03" and 2.15"	5.8"	5.3" x 2.8" (147.3 x 134.6 x 71.1)	<b>RW57750</b>



RW57900

Thermoplastic, gray, duplex, GFCI, toggle and single receptacles, diameter 1.34", 1.40", 1.60", 1.72", 2.03" and 2.15"	5.8"	5.3" x 4.8" (147.3 x 134.6 x 121.9)	<b>RW57900</b>
--	------	--	----------------



RW57950

Thermoplastic, gray, single receptacles, diameter 1.34", 1.40", 1.60", 1.72", 2.03" and 2.15"	5.8"	5.3" x 4.8" (147.3 x 134.6 x 121.9)	<b>RW57950</b>
---	------	--	----------------



Note: Required by the NEC® for while-in-use outdoor power distribution. Thermoplastic covers provide protection for use in wet locations with the cover closed, NEMA® 3R rated. Meets NEC 406.8 – receptacles in damp or wet locations. Holes for padlocks are .40 inch.

NEC® is a registered trademark of the The National Electrical Code.  
 NEMA® is a registered trademark of The National Electrical Manufacturers Association.



# Wallplates Screws and Accessories

## Screws, 6-32 Thread, 100 Count

Description	Color/Material	Catalog Number
Decorator Wallplate Screws, Oval Head Milled Slot, 3/8 in. Long – 6-32 Thread, 100 per Box (Order 1 to receive a box of 100)	Almond	<b>RA38ALPK100</b>
	Black	<b>RA38BKPK100</b>
	Brown	<b>RA38PK100</b>
	Gray	<b>RA38GYPK100</b>
	Ivory	<b>RA38IPK100</b>
	Light Almond	<b>RA38LAPK100</b>
	White	<b>RA38WPK100</b>
Standard Wallplate Screws, Oval Head Milled Slot, 1/2 in. Long – 6-32 Thread, 100 per Box (Order 1 to receive a box of 100)	Almond	<b>RA12ALPK100</b>
	Black	<b>RA12BKPK100</b>
	Brown	<b>RA12PK100</b>
	Gray	<b>RA12GYPK100</b>
	Ivory	<b>RA12IPK100</b>
	Light Almond	<b>RA12LAPK100</b>
	White	<b>RA12WPK100</b>
Standard Wallplate Screws, Oval Head Milled Slot, 5/8 in. Long – 6-32 Thread, 100 per Box (Order 1 to receive a box of 100)	Ivory	-
	White	-
	Stainless Steel	<b>RA58SSPK100</b>
Standard Wallplate Screws, Oval Head Milled Slot, 1.0 in. Long – 6-32 Thread, 100 per Box (Order 1 to receive a box of 100)	Ivory	<b>RA88IPK100</b>
	White	<b>RA88WPK100</b>
	Stainless Steel	<b>RA88SSPK100</b>



## Single Count Screws and Accessories

Description	Color	Catalog Number
Blank adapter, to fill a toggle opening.	Brown	<b>RA756</b>
	Ivory	<b>RA756I</b>
	White	<b>RA756W</b>
Blank adapter, to fill a decorator opening.	Ivory	<b>NS620I</b>
	Light Almond	<b>NS620LA</b>
	White	<b>NS620W</b>
Blank adapter, .406" (10.30) dia. hole, to fill a decorator opening.	Ivory	<b>NS621I</b>
	Light Almond	<b>NS621LA</b>
	White	<b>NS621W</b>
Mounting strap, with screws.	Steel	<b>RA40</b>
Brass plated screw, standard slot, .38 in. (.97) long.	Brass	<b>HBL7341</b>



# Wallplates Technical Information

## Specifications

### Listings

Non-Metallic Plates	UL Standard 514D.
Metallic Plates	UL Standard 514D.
Certification	UL Files #E31999, E92074. CSA Standard C22.2 No. 42.1. CSA File 1733174.

### Nylon Plate

Thickness	.06 in. (1.5).
Mounting Screw(s)	Steel (painted slotted screw head).
Feature	Captive mounting screw hole.
Operating Temperature	-40°C to 85°C.
Appearance	Smooth.

### 302/304 Stainless Steel (18% Chromium, 8% Nickel) Plate

Thickness	.035 in. (0.9) nominal.
Mounting Screw(s)	302/304 stainless steel (18% chromium, 8% nickel). Slotted screw head.
Appearance	Horizontal brushed finish.

### 430 Stainless Steel (17% Chromium, less than 0.5% Nickel) Plate

Thickness	.035 in. (0.9) nominal.
Mounting Screw(s)	302/304 stainless steel (17% chromium, less than 0.5% nickel). Slotted screw head.
Appearance	Horizontal brushed finish.

### Brass (70% Copper, 30% Zinc) Plate

Thickness	.04 in. (1.0).
Mounting Screw(s)	Brass (70% Copper, 30% Zinc). Slotted screw head.
Appearance	Horizontal brushed finish.

### Aluminum Plate

Thickness	.05 in. (1.3).
Mounting Screw(s)	302/304 stainless steel (17% chromium, less than 0.5% nickel). Slotted screw head.
Appearance	Horizontal brushed finish.

### Brass Plated Steel Plate

Thickness	.03 in. (0.8) nominal.
Mounting Screw(s)	Brass slotted head.
Appearance	Polished, coated to inhibit oxidation.

### Chrome Plated Steel Plate

Thickness	.03 in. (0.8) nominal.
Mounting Screw(s)	302/304 stainless steel (17% chromium, less than 0.5% nickel). Slotted screw head.
Appearance	Polished, coated to inhibit oxidation.

### Steel Painted Plate

Thickness	.03 in. (0.8) nominal.
Mounting Screw(s)	Steel (painted slotted screw head).
Appearance	Powder coat paint.

# Wallplates

## Wallplate Dimensions

### Product Dimensions

Size	Standard Metal		Painted Metal		Size	Jumbo Metal	
	Height	Width	Width	Width		Height	Width
1-Gang	4.50" (114.3)	2.87" (72.9)	2.75" (69.8)		1-Gang	5.25" (133.4)	3.50" (88.9)
2-Gang	4.50" (114.3)	4.60" (116.8)	4.56" (115.8)		2-Gang	5.25" (133.4)	5.31" (134.9)
3-Gang	4.50" (114.3)	6.41" (162.8)	6.38" (162.1)		3-Gang	5.25" (133.4)	7.12" (180.8)
4-Gang	4.50" (114.3)	8.22" (208.8)	8.18" (207.8)				
5-Gang	4.50" (114.3)	10.03" (254.8)	10.00" (254.0)				
6-Gang	4.50" (114.3)	11.81" (300.0)	11.81" (300.0)				
7-Gang	4.50" (114.3)	13.68" (347.5)					
8-Gang	4.50" (114.3)	15.44" (392.1)					

Size	Standard Nylon		Size	Mid-Size Nylon	
	Height	Width		Height	Width
1-Gang	4.63" (117.6)	2.88" (73.2)	1-Gang	4.88" (124.0)	3.13" (79.5)
2-Gang	4.63" (117.6)	4.69" (119.1)	2-Gang	4.88" (124.0)	4.94" (125.4)
3-Gang	4.63" (117.6)	6.50" (165.1)	3-Gang	4.88" (124.0)	6.75" (171.5)
4-Gang	4.63" (117.6)	8.31" (211.1)	4-Gang	4.88" (124.0)	8.56" (217.4)
5-Gang	4.63" (117.6)	10.12" (256.1)			
6-Gang	4.63" (117.6)	11.93" (303.0)			

Size	Snap-On Nylon	
	Height	Width
1-Gang	4.68" (118.9)	2.94" (74.7)
2-Gang	4.68" (118.9)	4.75" (120.7)
3-Gang	4.68" (118.9)	6.56" (166.6)
4-Gang	4.68" (118.9)	8.37" (212.6)
5-Gang	4.68" (118.9)	10.18" (258.6)
6-Gang	4.68" (118.9)	11.99" (304.5)

### Wallplate Openings and Mounting Dimensions

#6-32 Oval Head Screws Typical

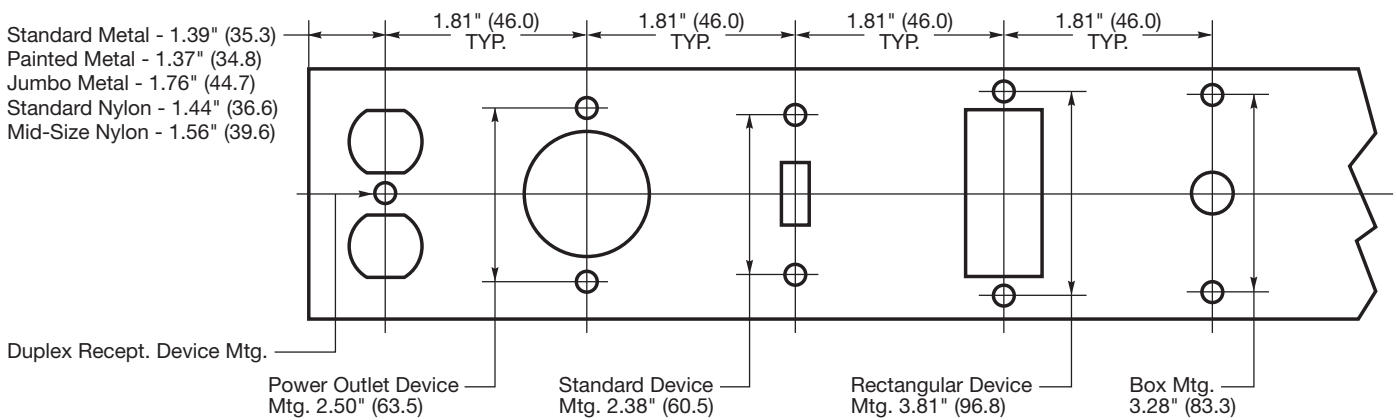

Note: Specifications are subject to change without notice.

# Wallplates

## Custom Metal Wallplates

How To Select A Custom Metal Wallplate

**Step 1:**  
Determine wallplate material and enter in box marked "Catalog Number"

Smooth Metal Material	Code
Anodized Aluminum	AL
Brass plated steel	BP
Solid brass	BR
Chrome plated steel	CH
Stainless steel 302/304	SS

Determine number of gangs required and enter in box marked "Catalog Number" next to material.

Number of Gangs	Code
1-gang	1
2-gang	2
3-gang	3
4-gang	4
5-gang	5
6-gang	6
7-gang	7
8-gang	8

Enter Catalog Number

◆ WC\* SS 4

**Step 2:**  
Enter quantity.

**Step 3:**  
Select the custom metal wallplate configuration.

Refer to the custom wallplate configuration chart to select a configuration for each gang in the wallplate. Each configuration has a specific 3-digit code located in the right hand side of the chart on pages N-33 to N-36. Enter this 3-digit configuration code in the corresponding box on the order form grid to match the position required on the finished custom wallplate.

Item No.	Catalog Number	Quantity	Code	Position 1	Position 2	Position 3	Position 4
1	WCSS4		H*	001	149	008	026
2							

Note: \*WC and H are preprinted on the distributor order form. Number to use for pricing.



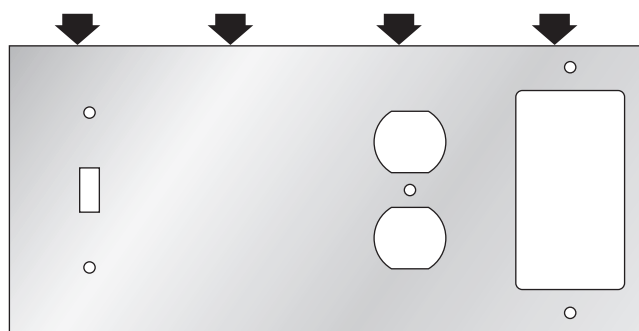







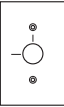

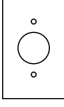
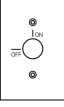

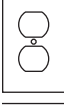
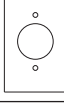
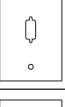
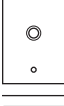
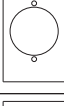
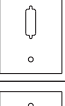
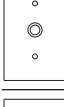

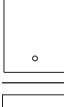



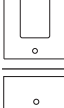



The 3-digit numbers listed at the upper right of the Sample Order Form (001, 149, etc.) represent the custom metal wallplate selected on the right. See Configuration Chart and Hubbell Configuration Selector Guide on pages N-33 to N-36 for additional configuration choices.

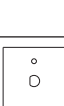
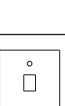
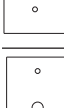

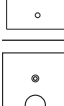
# Wallplates

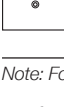
## Custom Metal Wallplates

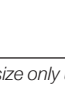
Configuration Chart

	<b>001</b> Switch.		<b>079</b> Barrel Key Switch with hash marks.		<b>456</b> .375" (9.5) Dia. Round Box Mounted.
	<b>007</b> Single Receptacle. 1.40" ID (35.6) Hole.		<b>080</b> Barrel Key Switch with On/Off and hash marks.		<b>458</b> .500" (12.7) Dia. Round Box Mounted.
	<b>008</b> Duplex Receptacle.		<b>091</b> Single Receptacle. 1.60" ID (40.5) Hole.		<b>435</b> 9-Pin Vertical Box Mounted.
	<b>011</b> 1-gang .635" ID (16.1) Hole Box Mounted with .50" ID (12.7) Nylon Bushing.		<b>098</b> Single Receptacle. 2.16" ID (54.7) Hole.		<b>438</b> 15-Pin Vertical Box Mounted.
	<b>012</b> 1-gang .635" ID (16.1) Hole Strap Mtd. incl. Strap with .50" ID (12.7) Nylon Bushing.		<b>135</b> Vertical Mounted Louver.		<b>295</b> 25-Pin Vertical Box Mounted.
	<b>013</b> Blank Box Mounted.		<b>149</b> Totally Blank (no mounting holes).		<b>314</b> IBM® Type Opening Box Mounted.
	<b>014</b> Blank Strap Mounted incl. Strap.	<b>Coax/Twinax and Modular Jack Openings</b>			<b>415</b> IBM® Type Opening with One .586" x .762" (14.9 x 19.3).
	<b>026</b> Rectangular Opening.		<b>422</b> .51" (12.8) Dia. "D" Box Mounted.	<b>Voice/Data Opening</b>	
	<b>055</b> 1-gang .375" ID (9.5) Hole Strap Mounted incl. Strap.		<b>425</b> .51" (12.8) Dia. "D" Box Mounted.		<b>470</b> .542" x .750" (13.8 x 19.0) Vertical Box Mounted.
	<b>056</b> 1-gang .375" ID (9.5) Hole Box Mounted.		<b>428</b> .47" (12) Flat Dia. "D" Box Mounted.		<b>473</b> .586" x .762" (14.9 x 19.4) Vertical Box Mounted.
	<b>057</b> 1-gang .50" ID (12.7) Hole Strap Mounted incl. Strap.		<b>429</b> .58" (14.7) Dia. "D" Box Mounted.		<b>476</b> .586" x .815" (14.9 x 20.7) Vertical Box Mounted.
	<b>058</b> 1-gang .50" ID (12.7) Hole Box Mounted.		<b>430</b> .55" (14) Flat Dia. "D" Box Mounted.		<b>479</b> .575" x .783" (14.6 x 19.9) Vertical Box Mounted.
	<b>078</b> Barrel Key Switch.		<b>431</b> .76" (19.2) Dia. "D" Box Mounted.		<b>477</b> .586" x .815" (14.9 x 20.7) Vertical Box Mounted.
			<b>432</b> .73" (18.6) Flat Dia.		<b>480</b> .575" x .783" (14.6 x 19.9) Vertical Box Mounted.

Note: For detailed dimensions of the above configurations, see pages N-34 to N-36. Available in smooth metal, standard size only up to and including 8-gang type.

IBM® is a registered trademark of International Business Machines Corporation.

# Wallplates

## Custom Metal Wallplates

Configuration Selector Guide

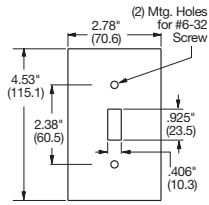

Configuration  
001

Toggle Switch Plate.

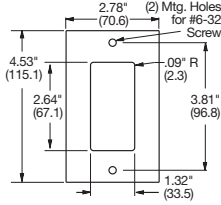

Configuration  
026

GFI/Rectangular Opening.

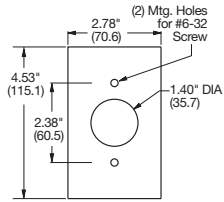

Configuration  
007

Single 15 or 20A Straight  
Blade Receptacle.  
15A Twist-Lock® Receptacle.

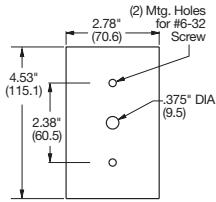

Configuration  
056

Single, .375" (9.5)  
Telephone (Strap Mount).

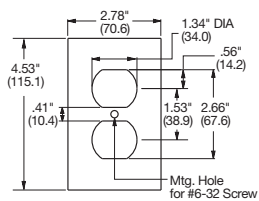

Configuration  
008

Duplex Receptacle.

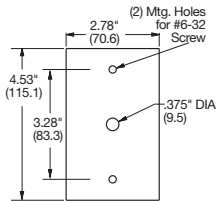

Configuration  
056

Single, .375" (9.5)  
Telephone (Box Mount).

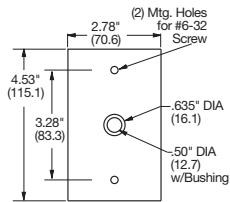

Configuration  
011

Single, .635" (16.1)  
Telephone (Box Mount).

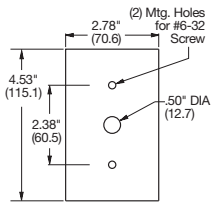

Configuration  
057

Single, .50" (12.7)  
Telephone (Strap Mount).

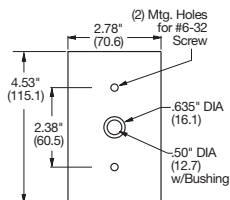

Configuration  
012

Single, .635" (16.1)  
Telephone (Strap Mount).

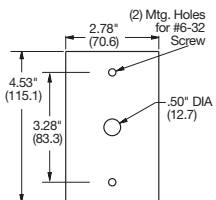

Configuration  
058

Single, .50" (12.7)  
Telephone (Box Mount).

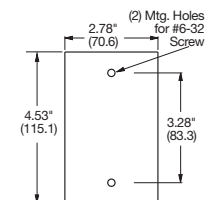

Configuration  
013

Blank Plate (Box Mount).

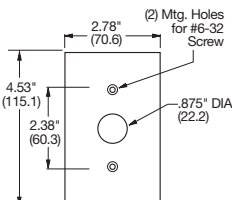

Configuration  
078

Barrel Key Switch.

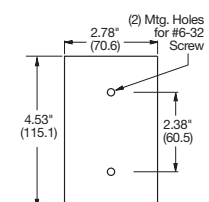

Configuration  
014

Blank Plate (Strap Mount).

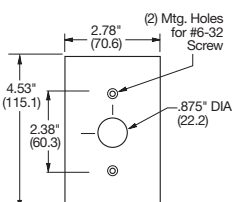

Configuration  
079

Barrel Key Switch  
with hash marks.

Note: Specifications are subject to change without notice.

# Wallplates

## Custom Metal Wallplates

Configuration Selector Guide

	<p><b>Configuration 080</b></p> <p>Barrel Key Switch with On/Off and hash marks.</p>		<p><b>Configuration 411</b></p> <p>Dual .635" (16.1) Holes (Box Mount).</p>
	<p><b>Configuration 091</b></p> <p>Single 20 or 30A Twist-Lock® Receptacle.</p>		<p><b>Configuration 415</b></p> <p>IBM® Type and Modular Jack (Box Mount).</p>
	<p><b>Configuration 098</b></p> <p>Single Receptacle, 30 or 50A Straight Blade, 3 Wire Power Outlet.</p>		<p><b>Configuration 422</b></p> <p>Single .505" (12.8) D-Hole (Box Mount).</p>
	<p><b>Configuration 135</b></p> <p>Louvered Plate (Strap Mount).</p>		<p><b>Configuration 423</b></p> <p>Dual .505" (12.8) D-Holes (Box Mount).</p>
	<p><b>Configuration 149</b></p> <p>Totally Blank Plate.</p>		<p><b>Configuration 425</b></p> <p>Single .505" (12.8) D-Hole (Box Mount).</p>
	<p><b>Configuration 295</b></p> <p>RS232 Port Single 25-Pin (Box Mount).</p>		<p><b>Configuration 426</b></p> <p>Dual .505" (12.8) D-Holes (Box Mount).</p>
	<p><b>Configuration 314</b></p> <p>IBM® Type (Box Mount).</p>		<p><b>Configuration 428</b></p> <p>Single .580" (14.7) D-Hole (Box Mount).</p>

Note: Specifications are subject to change without notice.

IBM® is a registered trademark of International Business Machines Corporation.

# Wallplates

## Custom Metal Wallplates

Configuration Selector Guide

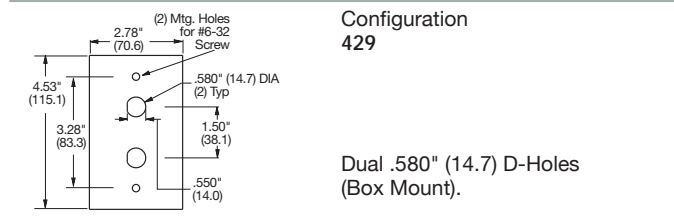

Configuration  
429

Dual .580" (14.7) D-Holes  
(Box Mount).

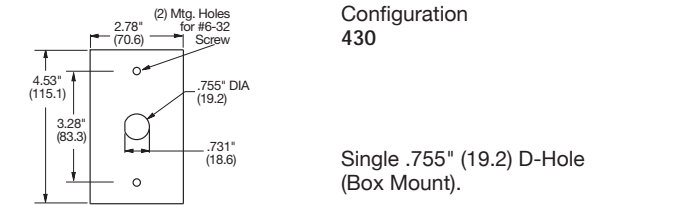

Configuration  
430

Single .755" (19.2) D-Hole  
(Box Mount).

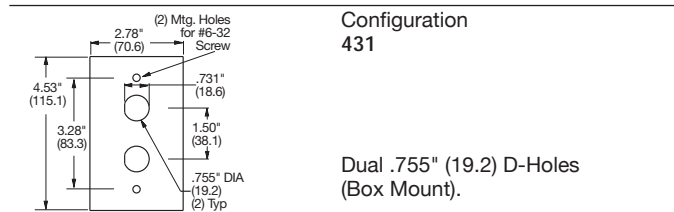

Configuration  
431

Dual .755" (19.2) D-Holes  
(Box Mount).

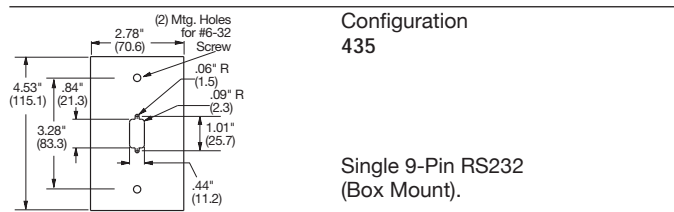

Configuration  
435

Single 9-Pin RS232  
(Box Mount).

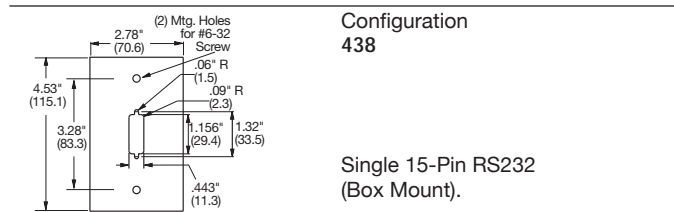

Configuration  
438

Single 15-Pin RS232  
(Box Mount).

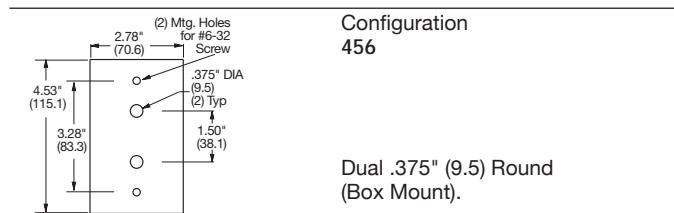

Configuration  
456

Dual .375" (9.5) Round  
(Box Mount).

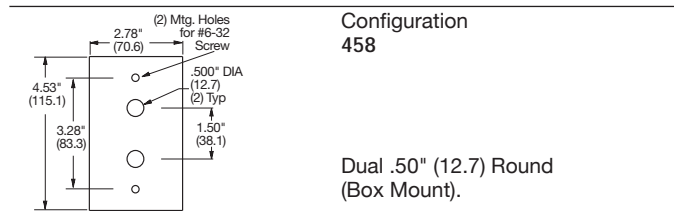

Configuration  
458

Dual .50" (12.7) Round  
(Box Mount).

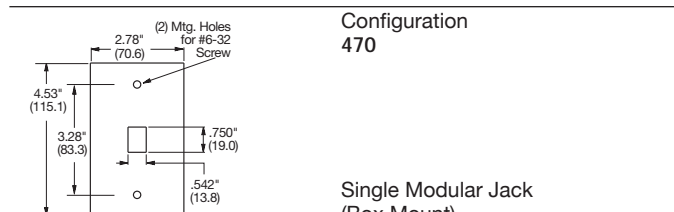

Configuration  
470

Single Modular Jack  
(Box Mount).

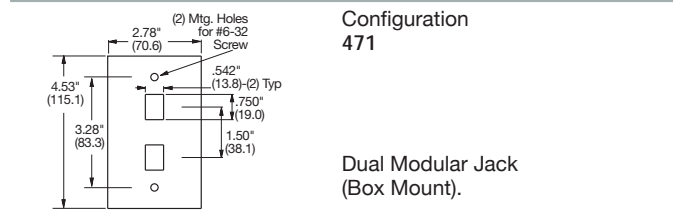

Configuration  
471

Dual Modular Jack  
(Box Mount).

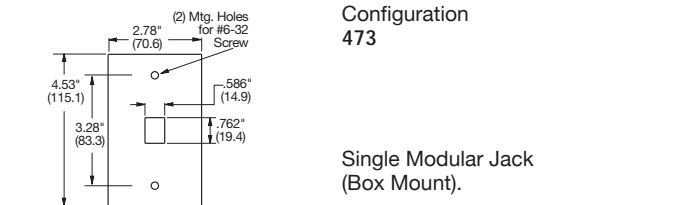

Configuration  
473

Single Modular Jack  
(Box Mount).

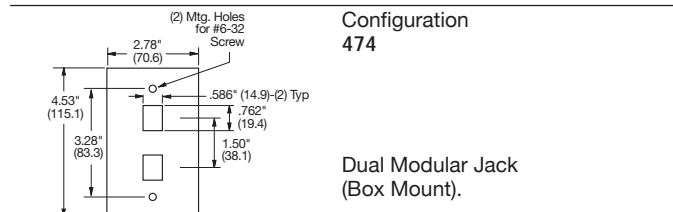

Configuration  
474

Dual Modular Jack  
(Box Mount).

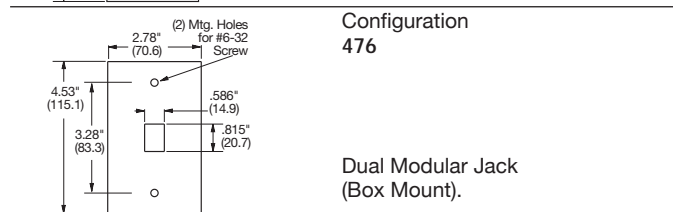

Configuration  
476

Dual Modular Jack  
(Box Mount).

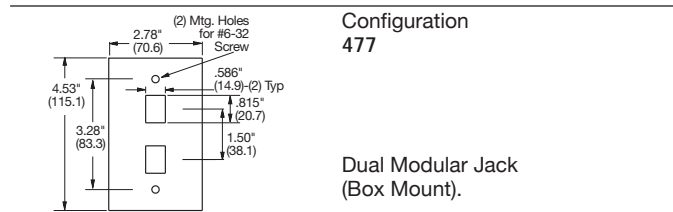

Configuration  
477

Dual Modular Jack  
(Box Mount).

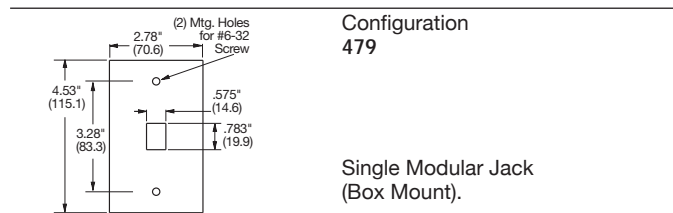

Configuration  
479

Single Modular Jack  
(Box Mount).

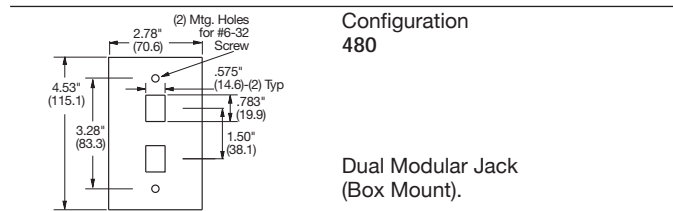

Configuration  
480

Dual Modular Jack  
(Box Mount).

Note: Specifications are subject to change without notice.



# Section O Floor Boxes

## Index

Product	Page
Hubbell Floor Box Applications . . . . .	O-2
<b>Hubbell SystemOne</b>	
Floor Boxes . . . . .	O-3
Covers and Sub-Plates . . . . .	O-4
Configuration Chart . . . . .	O-5
Metal and Non-Metallic Concrete Floor Boxes . . . . .	O-6
Sub-Plates . . . . .	O-7
<b>Flush Concrete Floor Boxes and Covers</b>	
Round Non-Metallic, Single or Multi-Service . . . . .	O-8
Round Metal, Single Service . . . . .	O-9
Rectangular Non-Metallic, 1-, 2-, and 3-Gang . . . . .	O-10
Rectangular Cast Iron, 1-, 2-, and 3-Gang . . . . .	O-12
Rectangular Stamped Steel, 1-, 2-, and 3-Gang . . . . .	O-13
<b>Recessed Concrete Floor Boxes and Covers</b>	
2-Gang Stamped Steel and Cast Iron . . . . .	O-14
4- and 8-Gang Stamped Steel and Cast Iron . . . . .	O-15
6-Gang Stamped Steel and Cast Iron . . . . .	O-16
Large Capacity Concrete Floor Boxes with Round Cover . . . . .	O-17
7- and 11-Gang . . . . .	O-18
Ballroom Series . . . . .	O-19
<b>Flush Floor Boxes for Wooden Floors</b> . . . . .	O-20
<b>Above-Floor Service Fittings (Single Service)</b> . . . . .	O-21
<b>Residential Delivery Systems</b> . . . . .	O-22
<b>Accessories</b> . . . . .	O-24
<b>Hubbell Floor Box Cover to Receptacle Compatibility Chart</b> . . . . .	O-26
<b>CONNEXION Modular Wiring Zone System</b>	
System Components . . . . .	O-29
Unloaded Raised Access Floor Boxes and Face Plates . . . . .	O-30
Custom Pre-Wired Access Floor Boxes . . . . .	O-31
<b>Convention Center Utility Box</b>	
Metallic Series . . . . .	O-32
Dimensional Information . . . . .	O-33
<b>Furniture and Work Surface Connectivity Boxes and Table Top Boxes</b>	
Furniture and Work Surface Connectivity Boxes . . . . .	O-35
Pre-Wired Work Surface Series . . . . .	O-36
Pre-Wired Work Surface Elite Series . . . . .	O-37
<b>Recessed Wall Boxes</b>	
AV In-Wall and Ceiling Enclosures . . . . .	O-38
Large Capacity Wall Boxes . . . . .	O-39
Multi-Connect – Dimensional Information and Face Plates . . . . .	O-40

**Hubbell SystemOne  
Floor Boxes**



**Recessed Multi-Service  
Concrete Floor Boxes**



**CONNEXION Zone  
Distribution System**

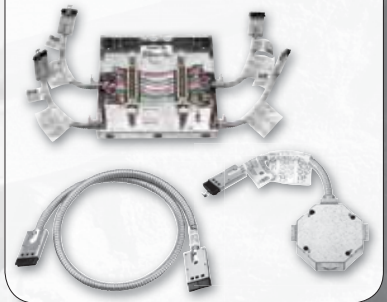

**Furniture and Work  
Surface Boxes**



## Floor Boxes

### Hubbell Floor Boxes

Applications

Featuring the unique capabilities of Hubbell's SystemOne universal cover and sub-plate design, Hubbell has expanded its floor box offering to provide industry leading flexibility while accommodating an extensive range of applications. Hubbell SystemOne is constructed to give customers the ability to create personal solutions for their most demanding, power, data and audio/video requirements.

### Hubbell SystemOne Floor Box Applications...



#### Multi-Service Applications

This Hubbell SystemOne sub-plate incorporates a standard Style Line® decorator opening, which can be used for an active multimedia device. In addition, a 20A outlet is supplied for power and two keystone openings for voice/data services.



#### Multimedia Applications

Other Hubbell SystemOne sub-plates are designed to meet the growing needs of the audio/video market. Some sub-plates provide power outlets with Hubbell's AV products including 15-pin SVGA, RCA, S-Video, 3.5mm stereo, HDMI and XLR microphone jacks. Other sub-plates can accommodate Extron® Electronics MAAP and AAP series AV modules, as well as FSR IPS plates.



#### 4X4 Applications

Provides maximum power capacity for flush, multi-service applications. This sub-plate features a pre-wired four outlet 20A, 125V receptacle and four openings for flush mount Hubbell modular jacks and audio/video Snap Fit connectors. Receptacle wiring permits dual-circuit, as well as isolated ground applications.

### Traditional Floor Boxes...

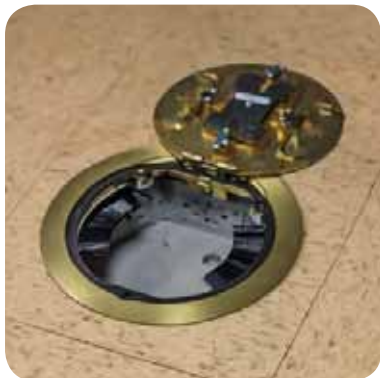

#### Recessed Applications

For applications where recessed connections are desired, Hubbell has a complete line of recessed stamped steel and cast iron floor boxes, from two to eleven gangs. A variety of modular face plates are available to meet a wide array of power, data, voice and audio/video requirements. Carpet and tile cover assemblies are offered in a variety of finishes and styles.

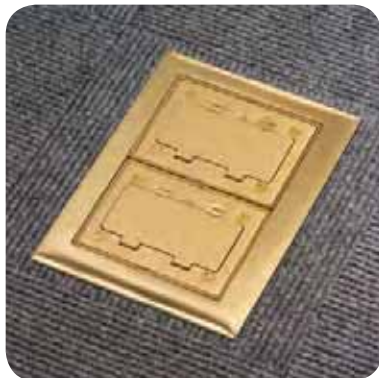

#### Flush Applications

Hubbell offers a wide variety of traditional solutions including single and multi-gang cast iron, stamped steel and non-metallic floor boxes in both round and rectangular designs. These boxes can be finished with either brass or aluminum covers and flanges to match any office décor. All Hubbell floor box assemblies exceed UL scrub water exclusion requirements.

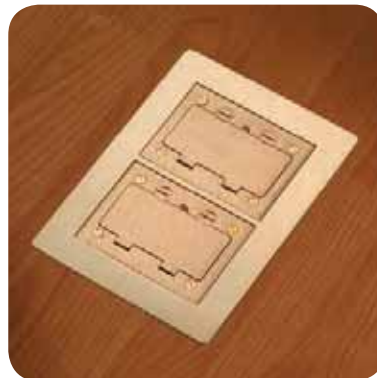

#### Wooden Floor Applications

Hubbell offers round, single service and rectangular, multi-service floor boxes for wooden floor applications. The rectangular boxes are available in one, two and three-gang options and feature removable barriers for maximum capacity while maintaining separation of power and low voltage. A variety of covers and flanges are available in brushed aluminum or brass to meet aesthetic requirements.

*Extron® is a registered trademark of Extron Electronics.*

### Cast Iron



S1CFB

- Corrosion resistant for on-grade applications
- Oversized 1½" NPT threaded conduit access holes for low voltage
- 1" NPT threaded conduit access holes for power

### Steel



S1SFB

- Stamped steel construction
- Economical and light weight for above-grade applications
- Concentric knockouts permit various conduit sizes for both power and data services

### Steel AV



S1SFBAV

- Accommodates high-capacity multimedia applications in a 3½" minimum depth of pour
- Oversized 1½" NPT threaded data hub
- ¾", 1" concentric knockouts for power services

### Features

- Easily installed, aesthetic and configurable floor box solution, for open floor plans that require both power and data services
- The Hubbell SystemOne Universal Cover mounts directly to the floor box riser, eliminating the need for an additional adapter collar
- The Hubbell SystemOne Universal Cover features ScrubShield® technology that exceeds UL514 scrub water exclusion requirements
- Convenient cubic inch capacity (cm<sup>3</sup>) markings on interior of box
- Leveling feet provide before pour adjustability
- Non-metallic riser allows a simple saw cut for adjustment after pour
- Supplied with concrete cover and closure plugs (where applicable)
- Designed to accommodate multi-service applications with the wide offering of Hubbell SystemOne sub-plates
- Hubbell SystemOne Metal Floor Boxes are approved for use in the City of Chicago

### Non-Metallic



S1PFB

- Non-corrosive plastic construction
- Oversized 1½" data conduit hub for increased cable capacity and bend radius
- Parallel conduit hubs reduce labor and material cost, facilitating easier wire pull

### Features

- Economical, easy to install, in-floor delivery system for open plan spaces
- The Hubbell SystemOne Universal Cover mounts directly to the floor box riser, eliminating the need for an additional adapter collar
- Concrete cover, conduit reducers and conduit hub plugs included

### Universal Flange and Cover Assembly

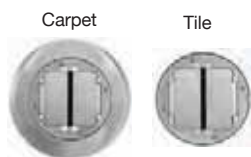

- Hinged doors open 180 degrees flush to the carpet flange or tile
- Locking studs allow each door to be secured independently
- The universal carpet or tile flange can be used for Hubbell SystemOne Floor Boxes and Fire-Rated Poke-Throughs
- Finishes and colors available:



### Features

- Durable cast aluminum construction available in black, gray, brass, aluminum and ivory powder coat finishes
- Features ScrubShield® technology that exceeds UL514 scrub water exclusion requirements
- Provides consistent look and maximum functionality throughout the installed life
- Meets ADA standards for accessible design, section 4.3.8

### Hubbell SystemOne Sub-Plates

Hubbell's modular sub-plate design allows users to economically upgrade Hubbell SystemOne FRPT and Floor Boxes to accommodate future moves, adds and changes. See page O-7 for additional information.



4x4 Sub-Plate



Datacom and Power Sub-Plate



Extron® AAP/MAAP and Power Sub-Plate



Dual Style Line® Decorator Sub-Plate



Twist-Lock® Sub-Plate



Furniture Feed Cover, Carpet

### Features

- Durable cast aluminum construction, powder coat finish
- Hubbell 4X4: four 20A, 125V receptacles, four keystone openings for voice/data jacks and flush multimedia connectors
- Hubbell X-END and Hubbell iSTATION modular connectivity
- Accommodates Extron® Electronics Architectural Series audio/video system integration products
- Accommodates GFCI, surge and standard Style Line® Decorator receptacles
- Twist-Lock® receptacle with two flush keystone openings
- Large capacity and multi-service furniture feed applications
- Open system sub-plates permit maximum data flexibility

### Power Devices and Connectivity



Hubbell-PRO Receptacles



Hubbell iSTATION



Hubbell X-END

### Features

- Choose from Hubbell's industry leading selection of wiring devices for power services
- Hubbell iSTATION connectivity modules integrate with SystemOne to provide comprehensive multimedia solutions
- Hubbell X-END application cables and tails allow for more connectivity in a smaller footprint

*Extron® is a registered trademark of Extron Electronics.*

# Floor Boxes Hubbell SystemOne Configuration Chart

		Floor Boxes*				4" Core Hole Fire-Rated Poke-Throughs		
		Non-Metallic	Metal					
Sub-Plates								
S1SP	Style Line® Decorator/GFCI 					✓+	✗	✓
S1SPDU	Duplex/Duplex 					✓+	✗	✓
S1SPDUSL	Duplex/Style Line® Decorator 					✓+	✗	✓
S1SP4X4 S1SP4X4PA S1SP4X4SYS	Hubbell 4 X 4 Panduit Mini-Com® 4 X 4 SYSTIMAX® 4 X 4 					✗	✓+	✗
S1SPTL	Twist-Lock® Receptacle + Data 					✗	✓+	✗
S1SP3IM	Hubbell DataCom + Power 					✓	✗	✓+
S1SP4IM	Hubbell DataCom 					✓	✗	✓+
S1SPDU2IM	Hubbell DataCom + Duplex 					✓	✗	✓+
S1SPSL2IM	Hubbell DataCom + Style Line® Decorator 					✓	✗	✓+
S1SPFFxx (Carpet) S1SPFFTxx (Tile)	Furniture Feed Cover/Flange (Replace "x" with BRS (brass finish), AL (aluminum finish), BL (black) or GY (gray). 					✓	✗	✓+
S1SPEXT1	Extron® or FSR + Power 					✓	✗	✓+
S1SPEXT2	Extron® or FSR + Power 					✓	✗	✓+
S1SPEXT3	Extron® or FSR Single-Service 					✓	✗	✓+
S1SPEXT4	Extron® or FSR + Power 					✓	✗	✓+
S1SPORT	Ortronics Series II® + Power 					✓	✗	✓+
S1SPTRAC	Ortronics TracJack® + Power 					✓	✗	✓+
S1SPMAX	Siemon MAX® + Power 					✓	✗	✓+
S1SPAMM20	Active Multimedia + Flush Keystone + Power 					✓	✗	✓+
S1FCxx SystemOne Carpet Cover S1TFCxx SystemOne Tile Cover	SystemOne Floor Boxes and FRPTs use SystemOne Universal Covers (Replace "x" with BRS (brass finish), AL (aluminum finish), BL (black), GY (gray) or I (ivory). 		Signifies minimum depth of concrete pour in inches for Hubbell SystemOne Floor Boxes.			✓+	✓	✗
Note: *Fire-Rated Poke-Throughs available with integral power junction box. Add "J" suffix to catalog numbers listed above (Example: S1PTFITJ). See section P for additional information.						Recommended Floor Fitting	Alternative Floor Fitting	Not Compatible
Extron® is a registered trademark of Extron Electronics. MAX® is a registered trademark of The Siemon Company. Mini-Com® and Panduit® are registered trademarks of Panduit Corp. SYSTIMAX® is a registered trademark of CommScope, Inc. TracJack®, Series II® & Ortronics® are registered trademarks of Ortronics/Legrand.								

**Dimensions Inches (mm)**

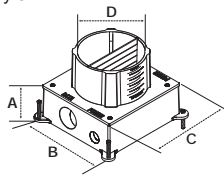
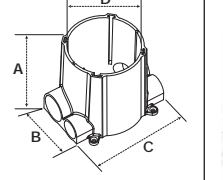
Style			Cast Iron	Steel	Steel AV	Non-Metallic
	Metal	Non-Metallic	<b>S1CFB*</b>	<b>S1SFB*</b>	<b>S1SFBV*</b>	<b>S1PFB</b>
Min. Depth of Pour			3.50" (88.9)	3.50" (88.9)	3.50" (88.9)	3.00" (76.2)
Adjustability			Fully	Fully	Fully	Fully
Cubic Inch (cm3) Capacity			156.0 cu. in. (2556.4 cm3)	175.7 cu. in. (2879.2 cm3)	177.5 cu. in. (2909.7 cm3)	100 cu. in. (1638.7 cm3)
Dimensions – A			3.00" (76.2)	3.00" (76.2)	3.00" (76.2)	6.00" (152.4)
Dimensions – B			7.26" (184.4)	7.50" (190.5)	7.50" (190.5)	5.58" (141.7)
Dimensions – C			7.45" (189.2)	7.38" (187.4)	7.38" (187.4)	7.08" (179.8)
Dimensions – D (Inside Diameter)			5.00" (127.0)	5.00" (127.0)	5.00" (127.0)	5.00" (127.0)
Power Entries			1" NPT Access Holes	¾", 1" Concentric KO	¾", 1" Concentric KO	1" Conduit Hub
Data Entries			1½" NPT Access Holes	¾", 1", 1¼" Concentric KO	1½" Threaded Hub (included)	1½" Conduit Hub
Concrete Cover Included			✓	✓	✓	✓
Closure Plugs Included			✓	–	✓	✓
Reducers			–	–	–	(see below)
Accepts Hubbell SystemOne Universal Cover			✓	✓	✓	✓
Cover Mounting Clips Included			✓	✓	✓	✓
Non-Metallic Low Voltage Divider Included (S1DIV1)			✓	✓	✓	✓

Note: UL File Number E92074.  
CSA File Number LR18416.  
\*S1CFB, S1SFB, S1SFBV are approved for use in the City of Chicago.

S1PFB reducers included: Qty (2) combo plug/reducers 1" to ¾"  
Qty (2) reducers 1½" to 1"  
Qty (2) reducers 1½" to ¾"  
Qty (2) plugs 1½"

**Hubbell SystemOne Universal Covers**





- Cast aluminum construction
- Durable powder coat finish























Color	Carpet	Tile
Aluminum Finish	<b>S1CFCAL</b>	<b>S1TFCAL</b>
Brass Finish	<b>S1CFCBRS</b>	<b>S1TFCBRS</b>
Black	<b>S1CFCBL</b>	<b>S1TFCBL</b>
Gray	<b>S1CFCGY</b>	<b>S1TFCGY</b>
Ivory	<b>S1CFCI</b>	<b>S1TFCI</b>



**Floor Box Accessories**

Description	Catalog Number
<b>Abandonment Plates</b> Used to cover abandoned SystemOne Fire-Rated Poke-Throughs or Floor Boxes. Black Gray	 <b>S1AP4BL</b> <b>S1AP4GY</b>
<b>Replacement Side by Side Divider</b> Used to isolate compartments in S1SP, S1SPFFx, S1SPFFTx, S1SPDU, S1SPDUSL, S1SPDU2IM and S1SPSL2IM sub-plates. Included with all SystemOne Floor Boxes.	 <b>S1DIV1</b>
<b>1½" Threaded Hub</b> For use with S1SFBV ONLY. Permits feed-through applications. S1SFBV floor box includes one (1) threaded hub.	 <b>S1AVHUB15</b>
<b>Replacement Universal Cover Mounting Clips</b> Used to mount SystemOne Universal Cover to SystemOne metal and non-metallic floor boxes (S1CFB, S1SFB, S1SFBV, S1PFB). Includes clips and ground leads for (5) floor boxes. All SystemOne Floor Boxes include mounting clips.	 <b>S1FBCLIP5PK</b>

Dimensions in Inches (mm)





Description	Catalog Number	Description	Catalog Number	Description	Catalog Number
<b>Style Line® Decorator/GFCI</b> (2) Style Line® decorator openings for power and/or datacom applications.	 S1SP	<b>Duplex/Duplex</b> (2) Duplex openings for power and/or datacom applications.	 S1SPDU	<b>Duplex/Style Line® Decorator</b> (1) Duplex and (1) Style Line® decorator opening for power and/or datacom applications.	 S1SPDUSL
③ Non-Metallic ③ Metal		③ Non-Metallic ③ Metal		③ Non-Metallic ③ Metal	
<b>Hubbell 4 X 4</b> (4) 20A, 125V receptacles. (4) Keystone openings for Hubbell jacks or flush AV connectors. Power can be wired as single or two circuit with isolated ground capability.	 S1SP4X4	<b>Carpet Furniture Feed Cover/Flange*</b> (1) 3/4" and (1) 1 1/2" NPT access holes for power and/or datacom applications. Universal Cover not required. Includes carpet flange.	 S1SPFFAL	<b>Tile Furniture Feed Cover/Flange*</b> (1) 3/4" and (1) 1 1/2" NPT access holes for power and/or datacom applications. Universal Cover not required. Includes tile flange.	 S1SPFFTL
④	S1SP4X415 S1SP4X430	③ Non-Metallic Aluminum Fin. ③ Metal Black Gray	S1SPFFBR5 S1SPFFBL S1SPFFGY	③ Non-Metallic Aluminum Fin. ④ Metal Black Gray	S1SPFFTB5 S1SPFFTBL S1SPFFTGY
Provided with 15 ft. wire leads Provided with 30 ft. wire leads					
<b>Single Receptacle + Data</b> Opening for 20 or 30A Twist-Lock® receptacle (1.56" OD) and (2) Keystone openings for Hubbell jacks or flush AV connectors.	 S1SPTL	<b>Hubbell DataCom + Power</b> (1) 20A, 125V receptacle and 3-unit recessed Hubbell iSTATION opening for data, voice, and AV applications.	 S1SP3IM	<b>Hubbell DataCom + Duplex</b> (1) Duplex opening, (2) flush Keystone openings and 1.5 unit recessed Hubbell iSTATION opening for data, voice and AV applications.	 S1SPDU2IM
④		⑤		⑤	
<b>Hubbell DataCom + Style Line® Decorator</b> (1) Style Line® decorator opening, (2) flush Keystone openings and 1.5 unit recessed Hubbell iSTATION opening for data, voice and AV applications.	 S1SPSL2IM	<b>Hubbell DataCom</b> 1 unit flush Hubbell iSTATION opening and 3-unit recessed Hubbell iSTATION opening for data, voice, and AV applications.	 S1SP4IM	<b>Active Multimedia + Power</b> Single 20A, 125V receptacle; (2) flush Keystone openings; (1) rectangular Style Line® decorator opening to accommodate active multimedia modules or low voltage outlet frames.	 S1SPAMM20
⑤		③		⑤	
<b>Extron® or FSR + Power</b> (1) 20A, 125V receptacle. Recessed opening for (3) single Extron® MAAP series adapter plates or FSR IPS plates.	 S1SPEXT1	<b>Extron® or FSR + Power</b> (1) 20A, 125V receptacle. Recessed opening for (1) single Extron® MAAP and (2) single AAP series adapter plates or FSR IPS plates.	 S1SPEXT2	<b>Extron® or FSR Single-Service</b> Recessed opening for (2) single Extron® MAAP and (2) single AAP series adapter plates or FSR IPS plates.	 S1SPEXT3
④		④		④	
<b>Extron® AAP + Power</b> (1) 20A, 125V receptacle. (2) flush Keystone and recessed opening for (2) single Extron® AAP Series adapter plates.	 S1SPEXT4	<b>Ortronics Series II® + Power</b> (1) 20A, 125V receptacle. Recessed opening for (3) 1 unit Ortronics Series II® modules.	 S1SPORT	<b>Ortronics TracJack® + Power</b> (1) 20A, 125V receptacle. Recessed bezel for (6) Ortronics TracJack® modules.	 S1SPTRAC
④		⑤		⑤	
<b>Panduit Mini Com® 4 X 4</b> (4) 20A, 125V receptacles. (4) Openings for Panduit Mini-Com Connectivity.	 S1SP4X4PA	<b>SYSTIMAX® 4 X 4</b> (4) 20A, 125V receptacles. (4) Openings for SYSTIMAX® Connectivity.	 S1SP4X4SYS	<b>Siemon MAX® + Power</b> (1) 20A, 125V receptacle. Recessed bezel for (6) Siemon MAX® modules.	 S1SPMAX
④		④		⑤	

④ Signifies minimum depth of concrete pour in inches for Metal Floor Boxes (S1CFB, S1SFB and S1SFBV) and Non-Metallic Floor Box (S1PFB).

Note: \*Furnished with two screw-in flexible metal conduit connectors.

See section W for datacom accessories.



### Sub-Plate Accessories

Description	Catalog Number
<b>Replacement Threaded Conduit Plugs</b> Used with S1SPFFx and S1SPFFTx ONLY. Sub-plate is supplied with plugs.	
	
	
Color	1 1/2" Plug 3/4" Plug
Aluminum Finish	S1FP15AL S1FP34AL
Brass Finish	S1FP15BRS S1FP34BRS
Black	S1FP15BL S1FP34BL
Gray	S1FP15GY S1FP34GY
<b>6-Port Replacement Data Frames</b> Used with open systems sub-plates. Sub-plate is supplied with data frame. Siemon MAX® for use with S1SPMAX sub-plate.	 S1DFMAX
Ortronics TracJack® for use with S1SPTRAC sub-plate.	 S1DFTRAC
Black Style Line® decorator blank frame.	 2100BK

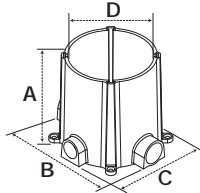

Extron® is a registered trademark of Extron Electronics. MAX® is a registered trademark of The Siemon Company. Mini-Com® and Panduit® are registered trademarks of Panduit Corp. SYSTIMAX® is a registered trademark of CommScope, Inc. TracJack®, Series II® and Ortronics® are registered trademarks of Ortronics/Legrand.

# Floor Boxes Flush Round Single or Multi-Service Non-Metallic Concrete Floor Box

## Dimensions Inches (mm)

	
	<b>PFB1</b>
Min. Depth of Pour	3.00" (76.2)
Capacity	100 cubic inches prior to cutting level to floor (19.5 cubic inches per inch of depth).
Dimensions – A	6.00" (152.4)
Dimensions – B	7.08" (179.8)
Dimensions – C	6.69" (169.9)
Dimensions – D	5.38" (136.5)
Hubs	(2) 1.0" and (2) 3/4" conduit hubs
Concrete Cover Included	✓
Closure/Reducer Plugs	(2) 1" plugs close off 1" hubs or reduce 1" to 3/4" (2) 3/4" plugs close off 3/4" hubs or reduce 3/4" to 1/2"

Note: UL File Number E92074. CSA File Number LR18416.

Description	Catalog Number
<b>Adapter</b> Required for all applications.	 <b>PFBA1A</b>
<b>Low Voltage Divider</b> Required for use with catalog number <b>PFB1</b> when used in multi-service applications. Accepts Hubbell standard duplex receptacles or 15A Twist-Lock® duplex receptacles (HBL4700 series).	 <b>PFBT1A</b>
<b>"Y" Adapter</b> 3/4 in. "Y" adapter to feed parallel runs of 3/4 in. conduit.	 <b>PFBYA1</b>

## Flush Round Covers and Flanges

### Multi-Service Cover and Flange Assemblies

Includes floor box cover with duplex flaps, (2) 1/2 in. dia. low voltage feed through holes and matching carpet flange. 6.25 in. Diameter

SF39253A	PFBCBRA	PFBCBLA	PFBCGYA	PFBCIA
				
Brass	Brown Non-Metallic	Black Non-Metallic	Gray Non-Metallic	Ivory Non-Metallic

### Single Service Covers

Brass  
Aluminum  
3.88 in. Dia.

S3925 SA3925	S3725 SA3725	S2525 SA2525	S2725 SA2725	S2925 SA2925	S3525 —	S3325 —
						
Duplex Flap	Duplex Screw	2 1/8" x 3/4" Combination	2 1/8" x 1" Combination	2 1/8" Single Receptacle	2 3/8" Single Receptacle	2 1/8" Single Receptacle (Terrazzo Floor)

### Metal Carpet Flange

Use with single service covers for carpet applications. 6.25 in. Diameter

### Adapter Ring

Use with single service covers for tile applications.

### Furniture Feed Plate

Unpainted plate with 1 in. threaded opening.

S3082	SA3082
	
Brass	Brushed Aluminum

S5016	SA5016
	
Brass	Aluminum

PFBP1

Steel

## One Piece Brass Cover and Carpet Flange

6.25 in. Dia.

SF3925	SF2525	SF2725	SF2925
			
Duplex Flap	2 1/8" x 3/4" Combination	2 1/8" x 1" Combination	2 1/8" Single Receptacle

Note: Adapter ring S5016 is required for mounting SF series covers onto PFBA1A.



Dimensions Inches (mm)

Style	Cast Iron						Stamped Steel	
	B2536 B253641		B2503	B2506 B2506415	B2537 BA2537	B2527 BA2527	B2529 BA2529	
Min. Depth of Pour	3.75" (95.3)	3.75" (95.3)	4.75" (120.7)	3.00" (76.2)	4.00" (101.6)	3.00" (76.2)		
Adjustability	Fully	Fully	Fully	Fully	Fully	Fully		
Before Pour External Height Adjustment	1.25" (31.8)	-	-	-	1.25" (31.8)	1.25" (31.8)		
After Pour Internal Height Adjustment	.38" (9.5)	.63" (15.9)	.63" (15.9)	.38" (9.5)	.38" (9.5)	.38" (9.5)		
Cubic Inch (cm3) Capacity	33.0 cu. in. (540.7 cm3)	36.0 cu. in. (590.0 cm3)	50.8 cu. in. (832.5 cm3)	30.0 cu. in. (491.6 cm3)	54.0 cu. in. (884.9 cm3)	37.3 cu. in. (611.2 cm3)		
Dimensions – A	3.05" (77.5)	3.75" (95.3)	4.75" (120.7)	2.87" (72.9)	3.88" (98.6)	2.91" (73.9)		
Dimensions – B	4.84" (122.9)	5.00" (127.0)	5.00" (127.0)	4.84" (122.9)	6.00" (152.4)	6.00" (152.4)		
Dimensions – C	4.84" (122.9)	4.63" (117.6)	4.66" (118.4)	4.84" (122.9)	4.81" (122.2)	4.81" (122.2)		
Dimensions – D	4.19" (106.4)	4.19" (106.4)	4.19" (106.4)	4.19" (106.4)	4.19" (106.4)	4.19" (106.4)		
Threaded Access Holes	(4) 3/4" (4) 1"	(4) 3/4"	(4) 1 1/4" (4) 1 1/2"	(4) 3/4"	-	-		
Knockouts – Sides	-	-	-	-	(1) 1" & (1) 3/4"	(2) 1/2" & (1) 3/4"		
Knockouts – Ends	-	-	-	-	(1) 1 1/4" & (1) 1/2"	(1) 1/2" & (1) 3/4"		
Knockouts – Bottom	-	-	-	-	(3) 1/2" & (2) 3/4"	(3) 1/2" & (2) 3/4"		
Concrete Cover Included	✓	✓	✓	✓	✓	✓		
Closure Plugs Included	✓	✓	✓	✓	-	-		

Note: UL File Number E31999.  
CSA File Number LR18416.  
Suitable for single service applications only.

Single Service Covers

Material	S3925 SA3925	S3725 SA3725	S2525 SA2525	S2725 SA2725	S2925 SA2925	S3525	S3325
Brass	✓	✓	✓	✓	✓	✓	✓
Aluminum	✓	✓	✓	✓	✓	✓	✓
3.88 in. Dia.	✓	✓	✓	✓	✓	✓	✓
	Duplex Flap	Duplex Screw	2 1/8" x 3/4" Combination	2 1/8" x 1" Combination	2 1/8" Single Receptacle	2 3/8" Single Receptacle	2 1/8" Single Receptacle (Terrazzo Floor)

Carpet Flanges

5.25 in. Dia.	S3182	SA3182	S3079	6.25 in. Dia.	S3082	SA3082
	Brass	Brushed Aluminum	Clear Polycarbonate	Brass	Brushed Aluminum	

One Piece Brass Cover and Carpet Flange

6.25 in. Dia.	SF3925	SF2525	SF2725	SF2925
	Duplex Flap	2 1/8" x 3/4" Combination	2 1/8" x 1" Combination	2 1/8" Single Receptacle

# Floor Boxes Flush Rectangular Non-Metallic Concrete Floor Boxes with Non-Metallic Covers

## Dimensions Inches (mm)

Style	1-Gang	2-Gang	3-Gang
	 <b>PFBRG1*</b>	 <b>PFBRG2</b>	 <b>PFBRG3</b>
Min. Depth of Pour	3.00" (76.2)	3.00" (76.2)	3.00" (76.2)
Adjustability	Fully	Fully	Fully
Cubic Inch (cm <sup>3</sup> ) Capacity Per Gang	14.3 cu. in. (234.3 cm <sup>3</sup> ) per 1" depth	14.3 cu. in. (234.3 cm <sup>3</sup> ) per 1" depth	14.3 cu. in. (234.3 cm <sup>3</sup> ) per 1" depth
Dimensions – A	6.00" (152.4)	6.00" (152.4)	6.00" (152.4)
Dimensions – B	3.60" (91.4)	6.82" (173.2)	10.04" (255.0)
Dimensions – C	5.42" (137.7)	5.42" (137.7)	5.42" (137.7)
Dimensions – D	6.90" (175.3)	6.90" (175.3)	6.90" (175.3)
Dimensions – E	5.44" (138.2)	8.66" (220.0)	11.87" (301.5)
Hubs	(4) 1¼"	(6) 1¼"	(8) 1¼"
Reducers	(4) 1" to ¾" and (4) 1¼" to 1"	(6) 1" to ¾" and (6) 1¼" to 1"	(8) 1" to ¾" and (8) 1¼" to 1"
Concrete Cover Included	✓	✓	✓
Closure Plugs Included	✓	✓	✓
Removable LV Barrier	–	✓	✓

Note: UL File Number E92074.

\*Suitable for single service applications only.

## Flush Rectangular Non-Metallic Covers and Flanges

### Required Components for Carpet Applications

Carpet Flanges	Cover with Duplex and Style Line® decorator inserts included			
Number of Gangs	1-Gang	2-Gang	3-Gang	One Required per Gang
Dimensions	6.00" x 4.88"	6.00" x 8.13"	6.00" x 11.35"	4.15" x 2.97"
Black	PFBRFBL1	PFBRFBL2	PFBRFBL3	PFBR826BLA
Brown	PFBRFBR1	PFBRFBR2	PFBRFBR3	PFBR826BRA
Gray	PFBRFGY1	PFBRFGY2	PFBRFGY3	PFBR826GYA
Ivory	PFBRFI1	PFBRFI2	PFBRFI3	PFBR826IA
				

### Required Components for Tile Applications

Mounting Collar	Cover Frame	Cover with Duplex and Style Line® decorator inserts included		
One Required per Gang	One Required per Gang	One Required per Gang		
	Dim. 4.47" x 3.25"	4.15" x 2.97"		
PFBRMC	PFBRFRA	PFBR826GYA		
				

Dimensions Inches (mm)

Style	1-Gang	2-Gang	3-Gang
	<p>PFBRG1*</p>	<p>PFBRG2</p>	<p>PFBRG3</p>
Min. Depth of Pour	3.00" (76.2)	3.00" (76.2)	3.00" (76.2)
Adjustability	Fully	Fully	Fully
Cubic Inch (cm3) Capacity Per Gang	14.3 cu. in. (234.3 cm3) per 1" depth	14.3 cu. in. (234.3 cm3) per 1" depth	14.3 cu. in. (234.3 cm3) per 1" depth
Dimensions – A	6.00" (152.4)	6.00" (152.4)	6.00" (152.4)
Dimensions – B	3.60" (91.4)	6.82" (173.2)	10.04" (255.0)
Dimensions – C	5.42" (137.7)	5.42" (137.7)	5.42" (137.7)
Dimensions – D	6.90" (175.3)	6.90" (175.3)	6.90" (175.3)
Dimensions – E	5.44" (138.2)	8.66" (220.0)	11.87" (301.5)
Hubs	(4) 1¼"	(6) 1¼"	(8) 1¼"
Reducers	(4) 1" to ¾" and (4) 1¼" to 1"	(6) 1" to ¾" and (6) 1¼" to 1"	(8) 1" to ¾" and (8) 1¼" to 1"
Concrete Cover Included	✓	✓	✓
Closure Plugs Included	✓	✓	✓
Removable LV Barrier	–	✓	✓

Note: UL File Number E92074.

\*Suitable for single service applications only.

Flush Rectangular Metal Covers and Flanges

Required Components for Carpet and Tile Applications

Adapter Collar (One required per gang)	Adapter Frame with Grounding Lug (One required per gang) Dim. 4.36" x 3.20"
Gray PFBRAC	Brass S5017G Aluminum SA5017G

Flush Rectangular Metal Covers and Flanges

Required Components for Carpet and Tile Applications

Adapter Collar (One required per gang)	Adapter Frame with Grounding Lug (One required per gang) Dim. 4.36" x 3.20"
Gray PFBRAC	Brass S5017G Aluminum SA5017G

Carpet Flanges (Not Required for Tile Applications)

Tapered Flange	1-Gang	2-Gang	3-Gang
Number of Gangs	1-Gang	2-Gang	3-Gang
Dimensions	6.00" x 4.85"	6.00" x 8.13"	6.00" x 11.34"
Brass	SB3083	SB3084	SB3085
Aluminum	SA3083	SA3084	SA3085



Rectangular Flanges (Required)

Rectangular Flange	1-Gang	2-Gang	3-Gang
Number of Gangs	1-Gang	2-Gang	3-Gang
Dimensions	6.00" x 4.85"	6.00" x 8.13"	6.00" x 11.34"
Brass	SB3083W	SB3084W	SB3085W
Aluminum	SA3083W	SA3084W	SA3085W







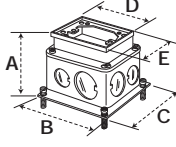

Covers – One Required per Gang

Cover	S3825	S3625	S3826	S2425	S2625	S2825	S3813
Brass	S3825	S3625	S3826	S2425	S2625	S2825	S3813
Aluminum	SA3825	SA3625	SA3826	SA2425	SA2625	—	SA3813
Dimensions	4.15" x 2.99"						
	Duplex Flap	Duplex Screw	Style Line® Decorator Opening	2 1/8" x 3/4" Combination	2 1/8" x 1" Combination	2 1/8" Single Receptacle	Blank

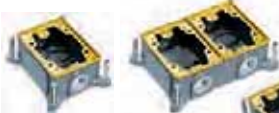

# Floor Boxes Flush Rectangular Cast Iron Concrete Floor Boxes

## Dimensions Inches (mm)







Style	Cast Iron											
	1-Gang Deep		2-Gang Deep		3-Gang Deep		1-Gang Shallow		2-Gang Shallow		3-Gang Shallow	
												
Collar Material: Brass Aluminum	B2436* BA2436*	B243641* -	B4233 BA4233	B423341 -	B4333 BA4333	B433361 -	B2437* -	B2414* BA2414*	B4214 BA4214	B4314 -		
Min. Depth of Pour	3.75" (95.3)		3.75" (95.3)		3.75" (95.3)		3.00" (76.2)	2.00" (50.8)	2.00" (50.8)	2.00" (50.8)		
Adjustability	Fully		Fully		Fully		Fully	Semi	Semi	Semi		
Before Pour External Height Adjustment	1.25" (31.8)		1.25" (31.8)		1.25" (31.8)		1.25" (31.8)	1.25" (31.8)	1.25" (31.8)	1.25" (31.8)		
After Pour Internal Height Adjustment	.38" (9.5)		.63" (15.9)		.63" (15.9)		.38" (9.5)	-	-	-		
Cubic Inch (cm3) Capacity Per Gang	33.0 cu. in. (540.7 cm <sup>3</sup> )		36.5 cu. in. (598.1 cm <sup>3</sup> )		34.8 cu. in. (570.3 cm <sup>3</sup> )		30.0 cu. in. (491.7 cm <sup>3</sup> )	16.0 cu. in. (262.2 cm <sup>3</sup> )	16.0 cu. in. (262.2 cm <sup>3</sup> )	16.0 cu. in. (262.2 cm <sup>3</sup> )		
Dimensions – A	3.20" (81.3)		3.38" (85.9)		3.38" (85.9)		2.90" (73.7)	2.00" (50.8)	2.00" (50.8)	2.00" (50.8)		
Dimensions – B	4.69" (119.1)		4.84" (122.9)		4.90" (122.5)		4.69" (119.1)	5.46" (138.7)	5.46" (138.7)	5.46" (138.7)		
Dimensions – C	4.69" (119.1)		8.06" (204.7)		11.41" (289.8)		4.69" (119.1)	4.19" (106.4)	7.49" (190.2)	10.7" (271.8)		
Dimensions – D	4.36" (110.7)		4.36" (110.7)		4.36" (110.7)		4.36" (110.8)	4.38" (111.3)	4.38" (111.3)	4.38" (111.3)		
Dimensions – E	3.19" (81.0)		6.42" (163.1)		9.64" (244.9)		3.20" (81.3)	3.19" (81.0)	6.38" (162.1)	9.56" (242.8)		
Threaded Access Holes	(4) 3/4" (4) 1"		(6) 3/4" (4) 1" & (2) 3/4"		(8) 3/4" (6) 1" & (2) 3/4"		(4) 3/4"	(2) 3/4"	(4) 3/4"	(6) 3/4"		
Concrete Cover Included	✓		✓		✓		✓	✓	✓	✓		
Closure Plugs Included	✓		✓		✓		✓	✓	✓	✓		
Removable LV Barrier	-		✓		✓		-	-	-	-		

Note: UL File Number E92074.  
CSA File Number LR18416.  
\*Suitable for single service applications only.

## Carpet Flanges

Tapered Flange			
Number of Gangs	1-Gang	2-Gang	3-Gang
Dimensions	6.00" x 4.85"	6.00" x 8.13"	6.00" x 11.34"
Brass	SB3083	SB3084	SB3085
Aluminum	SA3083	SA3084	SA3085
Clear Polycarbonate	S3083	S3084	S3085
			

## Covers – One Required per Gang

Brass	S3825	S3625	S3826	S2425	S2625	S2825	S3813
Aluminum	SA3825	SA3625	SA3826	SA2425	SA2625	-	SA3813
Dimensions	4.15" x 2.99"						
							
	Duplex Flap	Duplex Screw	Style Line® Decorator Opening	2 1/8" x 3/4" Combination	2 1/8" x 1" Combination	2 1/8" Single Receptacle	Blank

Dimensions in Inches (mm)



# Floor Boxes Flush Rectangular Stamped Steel Concrete Floor Boxes

## Dimensions Inches (mm)

Style	Stamped Steel							
	1-Gang Deep	2-Gang Deep	3-Gang Deep	1-Gang Shallow	2-Gang Shallow	3-Gang Shallow	1-Gang Deep	1-Gang Shallow
 <p>Collar Material: Brass Aluminum</p>								
	<b>B2431*</b> <b>BA2431*</b>	<b>B2432</b> <b>BA2432</b>	<b>B2433</b> <b>BA2433</b>	<b>B2421*</b> <b>BA2421*</b>	<b>B2422</b> <b>BA2422</b>	<b>B2423</b> <b>BA2423</b>	<b>B2427*</b> -	<b>B2429*</b> -
Min. Depth of Pour	3.75" (95.3)	3.75" (95.3)	3.75" (95.3)	2.75" (69.9)	2.75" (69.9)	2.75" (69.9)	4.00" (101.6)	3.00" (76.2)
Adjustability	Fully	Fully	Fully	Fully	Fully	Fully	Fully	Fully
Before Pour External Height Adjustment	1.25" (31.8)	1.25" (31.8)	1.25" (31.8)	1.25" (31.8)	1.25" (31.8)	1.25" (31.8)	1.25" (31.8)	1.25" (31.8)
After Pour Internal Height Adjustment	.50" (12.7)	.50" (12.7)	.50" (12.7)	.50" (12.7)	.50" (12.7)	.50" (12.7)	.38" (9.5)	.38" (9.5)
Cubic Inch (cm3) Capacity Per Gang	60.0 cu. in. (983.2 cm3)	52.8 cu. in. (865.2 cm3)	50.8 cu. in. (832.5 cm3)	39.5 cu. in. (647.3 cm3)	35.0 cu. in. (573.5 cm3)	34.0 cu. in. (557.2 cm3)	54.0 cu. in. (884.9 cm3)	37.3 cu. in. (611.2 cm3)
Dimensions – A	3.72" (94.5)	3.72" (94.5)	3.72" (94.5)	2.74" (69.6)	2.74" (69.6)	2.74" (69.6)	3.90" (99.1)	2.81" (71.4)
Dimensions – B	4.81" (122.2)	4.81" (122.2)	4.81" (122.2)	4.81" (122.2)	4.81" (122.2)	4.81" (122.2)	4.81" (122.2)	4.81" (122.2)
Dimensions – C	6.00" (152.4)	9.25" (235.0)	12.50" (317.5)	6.00" (152.4)	9.25" (235.0)	12.50" (317.5)	6.00" (152.4)	6.00" (152.4)
Dimensions – D	4.38" (111.3)	4.38" (111.3)	4.38" (111.3)	4.38" (111.3)	4.38" (111.3)	4.38" (111.3)	4.38" (111.2)	4.38" (111.2)
Dimensions – E	3.19" (81.0)	6.44" (163.6)	9.67" (245.6)	3.19" (81.0)	6.44" (163.6)	9.67" (245.6)	3.19" (81.0)	3.19" (81.0)
Knockouts – Sides	(1) ¾",1",1¼"	(2) ¾",1",1¼"	(3) ¾",1",1¼"	(2) ½",(1) ¾"	(4) ½",(1) ¾"	(6) ½",(1) ¾"	(1) ½",(1) 1¼"	(2) ½",(1) ¾"
Knockouts – Ends	(1) ¾",1",1¼"	(1) ¾",1",1¼"	(1) ¾",1",1¼"	(1) ½",(1) ¾"	(2) ½",(1) ¾"	(2) ½",(1) ¾"	(1) ¾",(1) 1"	(1) ½",(1) ¾"
Knockouts – Bottom	(2) ¾",1",1¼"	(4) ¾",1",1¼"	(6) ¾",1",1¼"	(2) ¾",1",1¼"	(4) ¾",1",1¼"	(6) ¾",1",1¼"	(3) ½",(2) ¾"	(3) ½",(2) ¾"
Concrete Cover Included	✓	✓	✓	✓	✓	✓	✓	✓
Closure Plugs Included	-	-	-	-	-	-	-	-
Removable LV Barrier	-	✓	✓	-	✓	✓	-	-

Note: UL File Number E92074.  
CSA File Number LR18416.  
\*Suitable for single service applications only.

## Carpet Flanges



Tapered Flange	1-Gang	2-Gang	3-Gang
Number of Gangs	1-Gang	2-Gang	3-Gang
Dimensions	6.00" x 4.85"	6.00" x 8.13"	6.00" x 11.34"
Brass	<b>SB3083</b>	<b>SB3084</b>	<b>SB3085</b>
Aluminum	<b>SA3083</b>	<b>SA3084</b>	<b>SA3085</b>
Clear Polycarbonate	<b>S3083</b>	<b>S3084</b>	<b>S3085</b>
			

## Covers – One Required per Gang

Brass	<b>S3825</b>	<b>S3625</b>	<b>S3826</b>	<b>S2425</b>	<b>S2625</b>	<b>S2825</b>	<b>S3813</b>
Aluminum	<b>SA3825</b>	<b>SA3625</b>	<b>SA3826</b>	<b>SA2425</b>	<b>SA2625</b>	—	<b>SA3813</b>
Dimensions	4.15" x 2.99"						
							
	Duplex Flap	Duplex Screw	Style Line® Decorator Opening	2 1/8" x 3/4" Combination	2 1/8" x 1" Combination	2 1/8" Single Receptacle	Blank

Dimensions in Inches (mm)

## Dimensions Inches (mm)

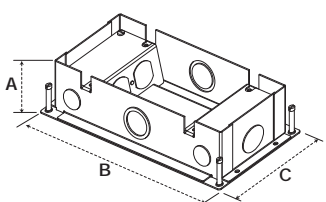
Style	Stamped Steel	Cast Iron
	2-Gang  3SFBS	2-Gang  3SFBC
		
Min. Depth of Pour	3.00" (76.2)	3.00" (76.2)
Adjustability	Before pour	Before pour
Cubic Inch (cm <sup>3</sup> ) Capacity Per Chamber	22.4 cu. in. (367.1 cm <sup>3</sup> )	21.6 cu. in. (354.0 cm <sup>3</sup> )
Dimensions – A	2.88" (73.2)	3.00" (76.2)
Dimensions – B	12.20" (309.9)	12.88" (327.2)
Dimensions – C	5.52" (140.2)	6.00" (152.4)
Threaded Access Holes	–	Sides (2) 3/4" Ends (1) 1/4" Center Area (1) 1/4" (each side)
Knockouts	Sides (2) 3/4" Ends (1) 1" Center Area (1) Concentric 1", 1/4" (each side)	–
Concrete Cover Included	✓	✓
Closure Plugs Included	–	✓
Face Plates Included	(1) 3SFBRP and (1) 3SFBTTP	(1) 3SFBRP and (1) 3SFBTTP

Note: UL File Number E31999.  
CSA File Number LR18416.

## Accessories

### On-grade Barrier

The on-grade barrier is intended for use on installations at grade level. This accessory is installed prior to the concrete pour and provides a barrier between the soil. The on-grade barrier comes with leveling feet and anchor points.

CFBOGPAN4

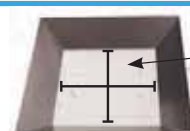

Pour Pan Dimensions:  
15.75 in. sq.  
4 in. depth

## Floor Box Covers with Carpet Recess

### Reinforced Non-Metallic Cover

Dimensions  
11.88" x 5.20"

3SFBCBRA



Brown

3SFBCBKA



Black

3SFBCGYA



Gray

3SFBCIA



Ivory

## Face Plates

3SFBRP



Duplex  
Knockout

3SFBDS



Style Line®  
Decorator Opening

3SFBS



Single Receptacle  
Opening  
(1.39" boss dia.)

3SFBB



Blank

3SFBTTP



Voice/Data  
(2) Jack Knockouts  
(.6" x .75")





3SFBIM

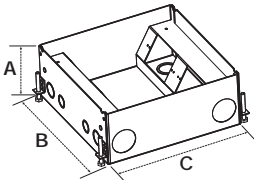

3-Unit iSTATION Opening  
(See Network Wiring section  
for module options)

Dimensions in Inches (mm)

**Dimensions Inches (mm)**

Style	Stamped Steel			Cast Iron
	4-Gang Deep	4-Gang Shallow	8-Gang Deep	4-Gang Shallow
	 <b>HBLCFB301BASE</b>	 <b>HBLCFB401BASE</b>	 <b>HBLCFB501BASE</b>	 <b>HBLCFB401CB</b>
Min. Depth of Pour	4.25" (107.6)	3.00" (76.2)	5.25" (133.4)	3.25" (82.6)
Adjustability	Before pour	Before pour	Before pour	Before pour
Cubic Inch (cm3) Capacity Per Chamber	29.5 cu. in. (483.4 cm3)	25.5 cu. in. (417.9 cm3)	49.5 cu. in. (811.2 cm3)	25.5 cu. in. (417.9 cm3)
Dimensions – A	4.0" (101.6)	2.63" (66.8)	5.13" (130.3)	3.13" (79.5)
Dimensions – B	10.0" (254.0)	10.0" (254.0)	10.0" (254.0)	10.0" (254.0)
Dimensions – C	10.0" (254.0)	10.0" (254.0)	10.0" (254.0)	10.0" (254.0)
Threaded Access Holes – Per Chamber	–	–	–	(2) 1"
Knockouts – Per Chamber	(1) Concentric ½", ¾" (1) Concentric ¾", 1" (1) 1¼"	(3) Concentric ½", ¾"	(1) Concentric ½", ¾" (1) Concentric ¾", 1" (1) 1¼"	–
Concrete Cover Included	✓	✓	✓	✓
Closure Plugs Included	–	–	–	✓

Note: UL File Number E197203.  
CSA File Number LR702145.

**Floor Box Covers with Carpet Recess**

Die Cast Metal Cover and Flange Assembly  
Dimensions 10.69" x 10.69"

**HBLTCGNTSW**



Granite

**HBLTCGNTBKS**



Black

**Accessories**

**On-grade Barrier**





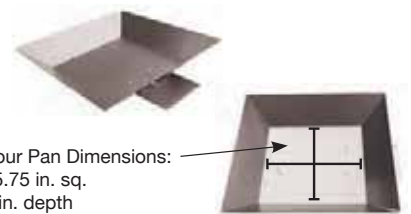

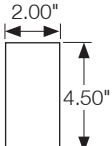

The on-grade barrier is intended for use on installations at grade level. This accessory is installed prior to the concrete pour and provides a barrier between the soil. The on-grade barrier comes with leveling feet and anchor points.

**CFBOGPAN4**













Pour Pan Dimensions:  
15.75 in. sq.  
4 in. depth

**Hubbell – Screw Type Face Plates\***

Typical	HBLST302SGY	HBLDE301SGY	HBLT0310SGY	HBLTL318SGY	HBLTL319SGY	HBLBL300SGY	HBLMIFSGY	HBL317SGY
								
	Duplex	Style Line® Decorator	Toggle	Single Receptacle (1.56" Boss Dia.)	Single Receptacle (1.39" Boss Dia.)	Blank	3-Unit Hubbell iSTATION (See Network Wiring section for module options)	Hubbell 6-Port

**Open Systems – Screw Type Face Plates\***

HBLAM303SGY	HBLAMP313SGY	HBLKR314SGY	HBLLT309SGY	HBLPA308SGY	HBLN0309SGY	HBLSI305SGY	HBLSI315SGY	HBLOR306SGY	HBLORT322SGY
									
AMP-ACO	AMP 6-Port	Krone®/Leviton®	SYSTIMAX®	Panduit Mini-Com®	NORDX® 6-Port (Cat. 5e jacks only)	Siemon CT® Series	Siemon MAX® Series	Ortronics Series II®	Ortronics TracJack®

Note: \*Catalog numbers indicated are gray, replace "GY" with the following to designate color: "BK" for Black, "I" for Ivory and "WA" for White.

AMP is a registered trademark of Tyco Electronics Corp. Krone® is a registered trademark of Krone, Inc. Leviton® is a registered trademark of Leviton. SYSTIMAX® is a registered trademark of CommScope, Inc. Mini-Com® and Panduit® are registered trademarks of Panduit Corp. NORDX® is a registered trademark of Belden/CDT, Inc. MAX® and CT® Series are registered trademarks of The Siemon Company. TracJack®, Series II® and Ortronics® are registered trademarks of Ortronics/Legrand.

## Dimensions Inches (mm)

Style	Stamped Steel	Cast Iron
	6-Gang  LCFBSSA	6-Gang  LCFBCA
Min. Depth of Pour	3.50" (88.9)	3.65" (92.7)
Adjustability	Fully	Fully
Cubic Inch (cm <sup>3</sup> ) Capacity Per Chamber	(4) at 38.2 cu. in. (626.0 cm <sup>3</sup> ) (2) at 25.4 cu. in. (416.2 cm <sup>3</sup> )	(4) at 36.8 cu. in. (603.0 cm <sup>3</sup> ) (2) at 25.4 cu. in. (416.2 cm <sup>3</sup> )
Dimensions – A	6.18" (157.0)	6.35" (161.3)
Dimensions – B	12.95" (328.9)	13.11" (333.0)
Dimensions – C	12.95" (328.9)	13.11" (333.0)
Threaded Access Holes – Per Chamber	–	(1) ¼" & (1) 1¼"
Knockouts – Per Chamber	(1) Concentric 1", 1¼" (1) ¾"	–
Concrete Cover Included	✓	✓
Closure Plugs Included	–	✓
Cover Mounting Brackets Included*	✓	✓

Note: \*Replacements Mounting Brackets available, (1 pair) LCFBBRACKET.  
UL File Number E31999. CSA File Number LR18416.

## Accessories

### On-grade Barrier

The on-grade barrier is intended for use on installations at grade level. This accessory is installed prior to the concrete pour and provides a barrier between the soil. The on-grade barrier comes with leveling feet and anchor points.

### CFBOGPAN4

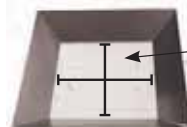

Pour Pan Dimensions:  
15.75 in. sq.  
4 in. depth

## Recessed Floor Box Covers

Smooth Metallic Cover, Flange and Cable Doors for Carpet Applications	Cover Dimensions 10.30" x 10.30"	Aluminum Finish Brass Finish Black Gray	LCFBCALTC LCFBCBRSTC LCFBCBKTC LCFBCGYTC	
Metallic Cover, Flange and Cable Doors for Carpet Applications – Carpet Insert Required	Cover Dimensions 10.30" x 10.30"	Aluminum Finish Brass Finish Black Gray	LCFBCALC LCFBCBRSC LCFBCBKC LCFBCGYC	
Reinforced Non-Metallic Cover, Flange and Cable Doors for Carpet Applications – Carpet Insert Required	Cover Dimensions 10.30" x 10.30"	Black Brown Gray Ivory	LCFBCBKA LCFBCBRA LCFBCGYA LCFBCIA	
Smooth Metallic Cover and Cable Doors for Tile Applications	Cover Dimensions 8.31" x 7.70"	Aluminum Finish Brass Finish Black Gray	LCFBCALT LCFBCBRST LCFBCBKT LCFBCGYT	

## Face Plates

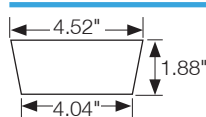

Typical

Dimensions in Inches (mm)

### LCFBP8



Duplex

### LCFBP26



Style Line®  
Decorator Opening

### LCFBP720



Single Receptacle  
(for 1.56" boss dia.)

### LCFBIM



3-Unit Hubbell iSTATION  
(See Network Wiring section  
for module options)

### LCFBP14



Blank



# Floor Boxes

## Large Capacity Concrete Floor Boxes with Round Cover

Hubbell's LCFB Adapter System allows users to integrate Hubbell's SystemOne Round Covers with Hubbell's Six-Gang Large Capacity Floor Box. This combination provides greater capacity, durability, flexibility with an attractive finish. Covers are available in a variety of architectural finishes including brass, nickel and aluminum. These covers provide a common round look and finish between Hubbell SystemOne Recessed Fire-Rated Poke-Throughs and the Six-Gang Large Capacity Floor Box (with the use of the LCFB adapter) — enhancing building decor.

The round shape of the SystemOne cover allows for the products to be installed in any location or orientation without having concern for parallel lines in the building floor while the device capacity of the Large Capacity Floor Box allows for power, data and audio visual to be combined into a common floor box.

- Round cover to match Fire-Rated Poke-Through installations
- Eight distinct mounting directions
- Drop down cable access doors to reduce trip hazards
- Post pour adjustability
- Egress door brushes reduce ingress of dirt
- Five aesthetically pleasing finishes

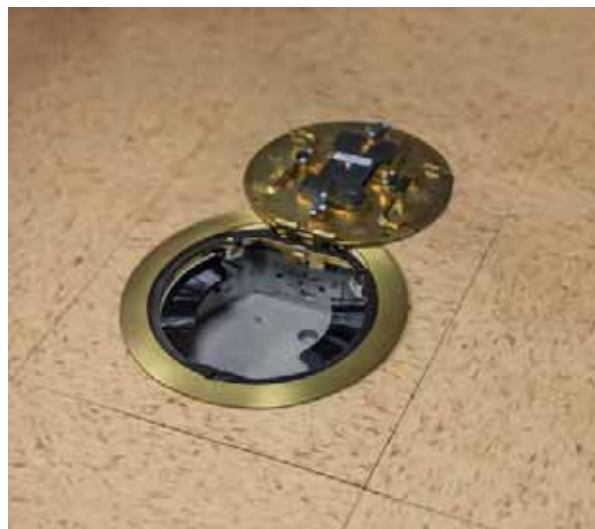

### Dimensions Inches (mm)

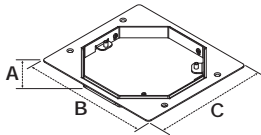
Style	6-Gang  LCFBS1R8ADAPT
Adjustability	Post pour
Vertical Adjustability Range	1/8" minimum to 3/8" maximum finished floor height
Dimensions – A	.89" (22.6)
Dimensions – B	10.13" (257.3)
Dimensions – C	9.25" (235.0)
Cover Orientation Positions	Eight (8); every 45°
Material	Galvanized sheet metal
Compatible Floor Boxes	LCFBSSA, LCFBCA

*Note: "Will sit approximately 1/8" above level of concrete floor after installation. Concrete will need to be graded after initial pour to remove potential ridges.*

### Compatible SystemOne Recessed 8" Covers





Finish	Catalog Number
Brushed Aluminum	<b>S1R8CVRALU</b>
Black Powder Coat	<b>S1R8CVRBLK</b>
Brushed Brass Plated	<b>S1R8CVRBRS</b>
Bronze Plated Finish	<b>S1R8CVRBRZ</b>
Satin Nickel Plated	<b>S1R8CVRNKL</b>

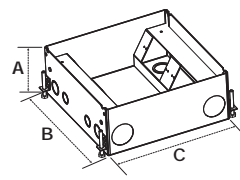

*Note: Must order adapter LCFBS1R8ADAPT when using S1R8CVRxxx covers on LCFBxx floor boxes.*

*Dimensions in Inches (mm)*

## Dimensions Inches (mm)

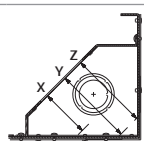
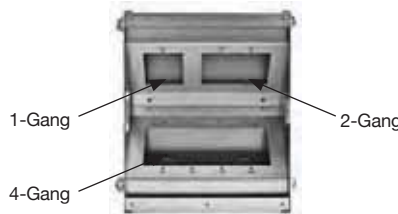
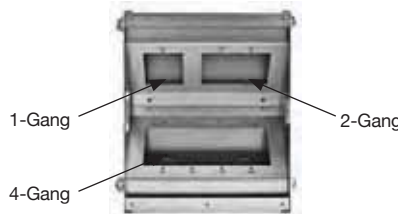
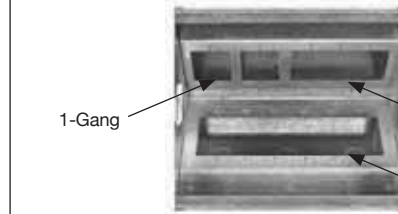
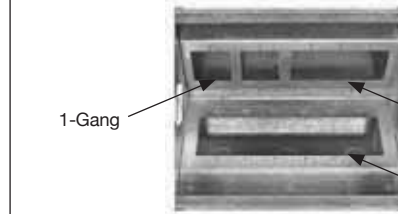
Style	CFB7G Series		CFB11G Series	
	7-Gang		11-Gang	
				
	<b>CFB7G4</b>	<b>CFB7G6</b>	<b>CFB11G4</b>	<b>CFB11G6</b>
Min. Depth of Pour	4.08" (103.5)	6.08" (154.3)	4.08" (103.5)	6.08" (154.3)
Adjustability	Before Pour	Before Pour	Before Pour	Before Pour
Dimensions:	A	B	C	
	4.08" (103.5)	10.0" (254.0)	12.2" (309.9)	4.08" (103.5)
	10.0" (254.0)	12.2" (309.9)	13.5" (342.9)	13.5" (342.9)
	12.2" (309.9)	12.2" (309.9)	12.2" (309.9)	12.2" (309.9)
Trade Size Knockouts:				
Sidewalls	(4) x 1", 1/4" Concentric	(4) x 1", 1/4", 1/2" Concentric	(4) x 1", 1/4" Concentric	(4) x 1", 1/4", 1/2" Concentric
Back	(3) x 1", 1/4", 1/2" Concentric; (1) x 2"	(3) x 1", 1/4", 1/2" Concentric; (1) x 2"	(2) 3/4", 1" Concentric; (4) 1", 1/4", 1/2" Concentric, (1) 2"	(2) 3/4", 1" Concentric; (4) 1", 1/4", 1/2" Concentric, (1) 2"
Bottom	(4) x 1", 1/4", 1/2" Concentric	(4) x 1", 1/4", 1/2" Concentric	(5) 1", 1/4", 1/2" Concentric; (2) 3/4", 1" Concentric	(5) 1", 1/4", 1/2" Concentric; (2) 3/4", 1" Concentric
Side View Depth behind mounting plate		X - 1.01" Y - 2.41" Z - 3.51"	X - 2.37" Y - 3.77" Z - 3.65"	X - 1.02" Y - 2.42" Z - 3.50"
Accepts industry standard size wallplates (sold separately)	(1) 1-Gang (1) 2-Gang (1) 4-Gang	(1) 1-Gang (1) 2-Gang (1) 4-Gang	(2) 1-Gang (1) 3-Gang (1) 6-Gang	(2) 1-Gang (1) 3-Gang (1) 6-Gang
Interior Configuration				

Note: UL File Number E31999.  
CSA File Number LR18416.

## Accessories

### On-grade Barrier

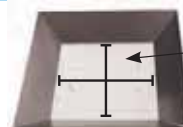

The on-grade barrier is intended for use on installations at grade level. This accessory is installed prior to the concrete pour and provides a barrier between the soil. The on-grade barrier comes with leveling feet and anchor points.

### CFBOGPAN4



Pour Pan Dimensions:  
15.75 in. sq.  
4 in. depth

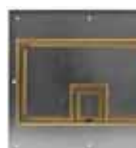
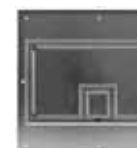

## Floor Box Covers

	CFB7G Series		CFB11G Series	
				
	Brass	Aluminum	Brass	Aluminum
Flange and cover; Beveled edge for carpet	1/4" Edging		1/4" Edging	
	<b>CFB7CVRBRS</b>	<b>CFB7CVRALU</b>	<b>CFB11CVRBRS</b>	<b>CFB11CVRALU</b>
Flange and cover; Square edge for tile	1/2" Edging		1/4" Edging	
	<b>CFB7TBRS</b>	<b>CFB7TALU</b>	<b>CFB11TBRS</b>	<b>CFB11TALU</b>

Note: Covers provide a recessed area, allowing floor covering to be inserted.

Dimensions in Inches (mm)

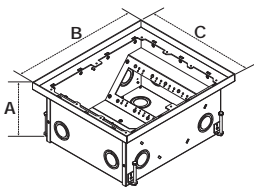
**Dimensions Inches (mm)**

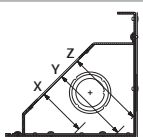
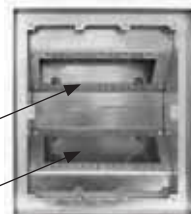
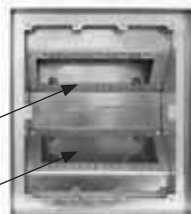
Style	CFB8FC Series	
	8-Gang	8-Gang
	 <b>CFB8FC1</b>	 <b>CFB8FC2</b>
Application	Carpet	Tile, Finished Concrete
Min. Depth of Pour	6.95" [177mm]	7.15" [182mm]
Adjustability	Before Pour	Before Pour
Dimensions:		
A	6.95" (176.5)	7.15" (181.6)
B	15.00" (176.5)	14.75" (374.7)
C	13.00" (330.2)	12.75" (323.9)
Trade Size Knockouts:	Sidewalls Back Bottom	
	(4) x 1.5", 1.25", 1" concentric (4) x 1.5", 1.25", 1" concentric (4) x 1.5", 1.25", 1" concentric	(4) x 1.5", 1.25", 1" concentric (4) x 1.5", 1.25", 1" concentric (4) x 1.5", 1.25", 1" concentric
Side View Depth behind mounting plate		
	X = 2.27" (57.7) Y = 4.01" (101.9) Z = 3.13" (79.5)	X = 2.27" (57.7) Y = 4.01" (101.9) Z = 3.13" (79.5)
Accepts industry standard size wallplates (sold separately) 4.63" Maximum Cover Height	One, two, three and four gang plates. Customer configuration dependant.	One, two, three and four gang plates. Customer configuration dependant.
		

**Accessories**

**On-grade Barrier**

The on-grade barrier is intended for use on installations at grade level. This accessory is installed prior to the concrete pour and provides a barrier between the soil. The on-grade barrier comes with leveling feet and anchor points.

**CFBOGPAN4**

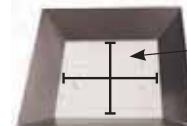

Pour Pan Dimensions:  
 15.75 in. sq.  
 4 in. depth

**Covers**







All ballroom floor box covers are machined from Aluminum and have no additional finish options

	CFB8FC1 Covers		CFB8FC2 Covers	
				
Carpet Cover, with 2 egress doors (0.20" depth)	<b>CFB8CVRALU1</b>	-	-	-
Flush cover, with 2 egress doors	-	-	<b>CFB8CVRALU2</b>	-
Blank box cover	-	<b>CFB8JBC1</b>	-	<b>CFB8JBC2</b>
Cover Load Ratings*:				
Recommended Loading	20,000 lb	20,000 lb	20,000 lb	20,000 lb
Maximum Load	40,000 lb	40,000 lb	40,000 lb	40,000 lb

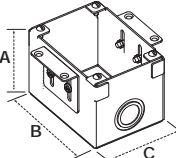
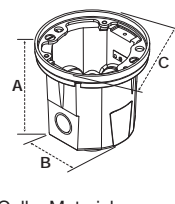
Note: \*Load applied through 3" (76mm) mandrel in center of cover. Loads are static and don't apply to rolling loads.

Dimensions in Inches (mm)

Dimensions Inches (mm)

Style	  Collar Material Brass	Rectangular Stamped Steel			Round Cast Iron	
		1-Gang	2-Gang	3-Gang	1-Gang	1-Gang
		 <b>B2481*</b>	 <b>B2482</b>	 <b>B2483</b>	 <b>B2588*</b>	 <b>B2588275*</b>
Adjustability		Semi	Semi	Semi	Non	Non
Cubic Inch (cm <sup>3</sup> ) Capacity Per Gang		42.0 cu. in. (658.3 cm <sup>3</sup> )	42.5 cu. in. (696.5 cm <sup>3</sup> )	42.5 cu. in. (696.5 cm <sup>3</sup> )	18.5 cu. in. (303.2 cm <sup>3</sup> )	18.5 cu. in. (303.2 cm <sup>3</sup> )
Dimensions – A		3.13" (79.5)	3.13" (79.5)	3.13" (79.5)	3.65" (92.7)	3.65" (92.7)
Dimensions – B		4.50" (114.3)	4.50" (114.3)	4.50" (114.3)	3.22" (81.8)	3.22" (81.8)
Dimensions – C		3.20" (81.3)	6.42" (163.1)	9.64" (244.9)	4.09" (103.9)	4.09" (103.9)
Threaded Access Holes		–	–	–	Bottom (2) ½"	Sides (2) ¾" Bottom (2) ½"
Knockouts – Sides		(1) ½", ¾", 1"	(2) ½", ¾", 1"	(3) ½", ¾", 1"	–	–
Knockouts – Ends		–	–	–	–	–
Knockouts – Bottom		(1) ½" - 1¼"	(2) ½" - 1¼"	(3) ½" - 1¼"	–	–
Debris Cover Included		✓	✓	✓	–	–
Closure Plugs Included		–	–	–	✓	✓
Removable LV Barrier		–	✓	✓	–	–

Note: UL File Number E31999. CSA File Number LR18416.  
\*Suitable for single service applications only.

Rectangular Flanges (Required)

	SB3083W	SB3084W	SB3085W
Brass	SB3083W	SB3084W	SB3085W
Aluminum	SA3083W	SA3084W	SA3085W
			
No. of Gangs	1-Gang	2-Gang	3-Gang
Dimensions	6.00" x 4.85"	6.00" x 8.13"	6.00" x 11.34"

Round Flanges

S3182	S3082
S3182	SA3082
	
5.25" Dia.	6.25" Dia.

Round Covers (3.88" Dia.)

S3925	S3725	S2525
S3925	SA3725	SA2525
		
Duplex Flap	Duplex Screw	2 1/8" x 3/4" Comb.

Covers – One Required per Gang

	S3825	S3625	S3826	S2425
Brass	S3825	S3625	S3826	S2425
Aluminum	SA3825	SA3625	SA3826	SA2425
Dimensions				
4.15" x 2.99"	Duplex Flap	Duplex Screw	Style Line® Decorator Opening	2 1/8" x 3/4" Combination
	S2625	S2825	S3425	S3813
Brass	S2625	S2825	S3425	S3813
Aluminum	SA2625	–	–	SA3813
Dimensions				
4.15" x 2.99"	2 1/8" x 1" Combination	2 1/8" Single Receptacle	2 3/8" Single Receptacle	Blank

Round Covers

	S2725	S2925	S3525	S3325
Brass	S2725	S2925	S3525	S3325
Aluminum	SA2725	SA2925	–	–
3.88" Dia.				
	2 1/8" x 1" Comb.	2 1/8" Single Receptacle	2 3/8" Single Receptacle	2 1/8" Single Rec. (Terrazzo Floor)

One Piece Brass Cover and Carpet Flange

	SF3925	SF2525	SF2725	SF2925
Brass	SF3925	SF2525	SF2725	SF2925
6.25" Dia.				
	Duplex Flap	2 1/8" x 3/4" Combination	2 1/8" x 1" Combination	2 1/8" Single Receptacle

Dimensions in Inches (mm)

# Floor Boxes

## Above-Floor Service Fittings (Single Service)

Hubbell offers a variety of above-floor service pedestals to satisfy just about any requirement. Large capacity enables a choice of services—you can even create your own unique pedestal to satisfy specific requirements. Above floor service fittings are ideal for furniture feed applications.

### Pedestals – Metallic – LO-CON (single service only)

Traditional metallic pedestals with die-cast aluminum frame, brushed aluminum housing and stainless steel faceplates. These pedestals are offered as component parts. They mount on floor box covers or floor deck/duct systems with 3/4-inch or 1-inch threaded openings.

### Create Pedestal – Create your own pedestal to meet specific service requirements. Order housing, face plates and devices separately.



Description	Catalog Number
Frame, housing, 3/4 in. chase nipple, without plates.	SC3098A
Frame, housing, 1 in. chase nipple, without plates.	SC3099A
Blank plate.	SS309B
Telephone bushing with 1 in. I.D. and (2) 3/8 in. KO for coax.	SS309T
Single receptacle plate with 1.39 in. (35.3) opening.	SS309S
Duplex receptacle plate.	SS309D
Style Line® decorator plate.	SS309DS



### Furniture Feed Plates – Use with SC3098A or SC3099A housings to feed furniture systems in office settings or display cases in retail applications.

Description	Catalog Number
Aluminum plate with 3/4 in. trade size knockout.	SS309SF
Aluminum plate, blank.	SS309BF

Note: When using SS309SF on Hubbell's LO-CON pedestals, SS309BF must be used on the opposite side.

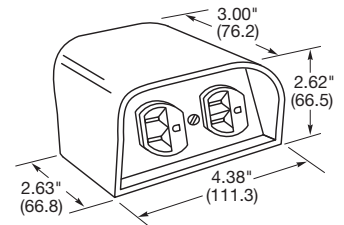

### Pedestals – Specialized Service – Large Capacity Pedestals (single service only)

Designed to accommodate receptacles up to 50A (4-gang only). These brushed aluminum pedestals are furnished with either a 3/4-inch or 1-inch hub and are designed for mounting to floor box covers with 3/4-inch or 1-inch threaded openings. Create your own unique pedestal with a wide choice of stainless steel plates and devices.

Description (2-Gang Housing)	Catalog Number
2-gang (front and back) with 3/4 in. hub.	SA6685
2-gang (front and back) with 1 in. hub.	SA6686

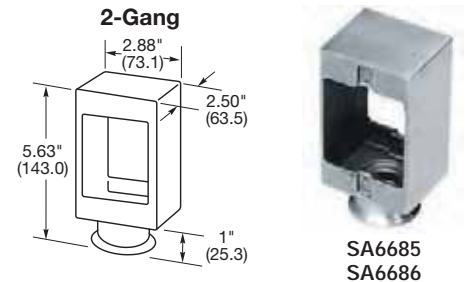

### Plate Option – 1-Gang

Description	Catalog Number
Duplex opening.	SS8
Style Line® decorator opening.	SS26
Single receptacle opening – boss diameter 1.36 to 1.39 in. (34.5 to 35.3).	SS7
Single receptacle opening – boss diameter 1.55 to 1.58 in. (39.4 to 40.1).	SS720
Blank plate.	SS13



Description (4-Gang Housing)	Catalog Number
4-gang (2 front and 2 back), with 3/4 in. hub.	SA6687
4-gang (2 front and 2 back), with 1 in. hub.	SA6688

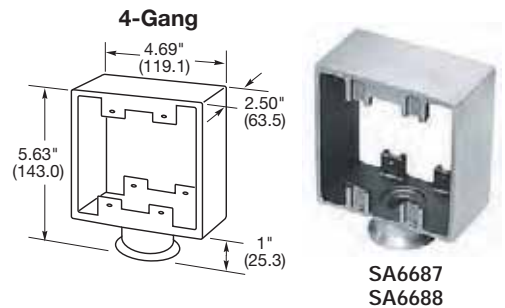

### Plate Option – 2-Gang

Description	Catalog Number
Two duplex openings.	SS82
Two Style Line® decorator openings.	SS262
Two single receptacle openings – boss diameter 1.36 to 1.39 in. (34.5 to 35.3).	SS72
Single receptacle opening – boss diameter 2.41 to 2.44 in. (61.2 to 62.0).	SS701
Single receptacle opening – boss diameter 2.09 to 2.13 in. (53.1 to 54.1).	SS703
Blank plate.	SS23



Dimensions in Inches (mm)

# Floor Boxes

## Flush Non-Metallic Floor Box For Concrete Floors

### Residential Delivery Systems



The Hubbell Round Non-Metallic Floor Box offers an economical solution for electrical power or a combination of power and voice/data applications. Designed specifically for slab-on-grade installation. Quick and easy installation is assured using a push in place leveling system.



### The Right Choice for that Perfect Finishing Touch!



Note: Not all configurations are available in all colors. See below for details.



RF406BK



RF400



RF407BK



RF408

### Floor Box for Structural Concrete Floors

Description	Material	Color	Catalog Number
Flange and hinged door cover assembly; includes tamper-resistant duplex receptacle 15A 125V; gasket; floor leveling PVC ring; high impact and chemically resistant nylon; factory pre-assembled for easy drop-in installation.	Solid Brass	—	<b>RF406BR</b>
	Thermoplastic	Almond	<b>RF406AL</b>
	Thermoplastic	Black	<b>RF406BK</b>
	Thermoplastic	Chestnut Brown	<b>RF406BN</b>
	Thermoplastic	Gray	<b>RF406GY</b>
Flush fit for hardwood and tile floors (same as above).	Solid Brass	—	<b>RF409BR</b>
Floor box with concrete protective cover; accepts 3/4 in. and 1 in. schedule 40 and schedule 80 PVC conduit; includes round box (4 7/8 in. dia. x 6.0 in. deep); four reducers; closure plugs; and concrete cover with locator flag.	PVC	Gray	<b>RF400</b>
Hinged nylon replacement door cover; includes neoprene gasket to seal plug openings; replacement cover for RF406 series.	Solid Brass	—	<b>RF407BR</b>
	Thermoplastic	Almond	<b>RF407AL</b>
	Thermoplastic	Black	<b>RF407BK</b>
	Thermoplastic	Chestnut Brown	<b>RF407BN</b>
	Thermoplastic	Gray	<b>RF407GY</b>
Low voltage divider; for use in PVC box RF400; when JLOAD® multimedia outlet is used.	Thermoplastic	Gray	<b>RF408</b>

### Dimensions Inches (mm)

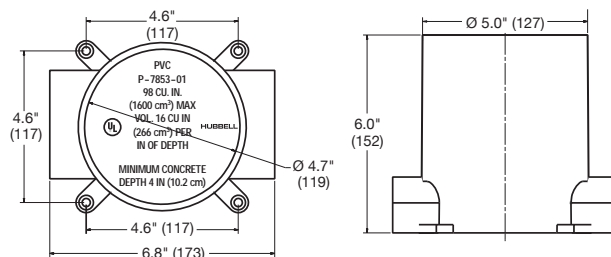

Dimensions in Inches (mm)

# Floor Boxes

## Flush Floor Boxes for Wooden Floors

Residential Delivery Systems



Note: Template cutout provided with instructions for proper installation.

### Drop-In Floor Box

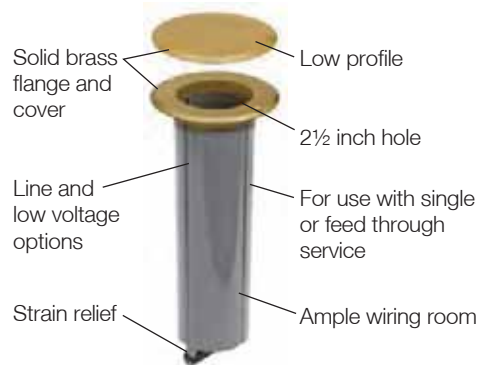

### The Right Choice for that Perfect Finishing Touch!



Note: Not all configurations are available in all colors. See below for details.

### Floor Boxes for Structural Wood Floors

Description	Material	Finish	Cat. Number	Material	Finish	Cat. Number
Decorator duplex receptacle floor box kit; includes steel box, flange and hinged door cover assembly with 15A 125V tamper-resistant duplex receptacle; designed for installation in wood floors; mounts to sub-floor or joists.	Solid Brass	Clear Lacquer	<b>RF515BR</b>	Aluminum	Brass Plated	<b>RF515BP</b>
	Aluminum	Stainless Paint	<b>RF515SS</b>	Aluminum	Chrome Plated	<b>RF515CH</b>
	Aluminum	Almond Paint	<b>RF515AL</b>	Aluminum	Copper Plated	<b>RF515CU</b>
	Aluminum	Black Paint	<b>RF515BK</b>	Aluminum	Nickel Plated	<b>RF515NI</b>
	Aluminum	Chestnut Brown Paint	<b>RF515BN</b>			
Flush fit for hardwood and tile floors (same as above).	Solid Brass	Clear Lacquer	<b>RF509BR</b>			
Flange and hinged door cover assembly; includes tamper-resistant duplex receptacle; neoprene gaskets; for use with steel box RF500.	Solid Brass	Clear Lacquer	<b>RF506BR</b>	Aluminum	Brass Plated	<b>RF506BP</b>
	Aluminum	Stainless Paint	<b>RF506SS</b>	Aluminum	Chrome Plated	<b>RF506CH</b>
	Aluminum	Almond Paint	<b>RF506AL</b>	Aluminum	Copper Plated	<b>RF506CU</b>
	Aluminum	Black Paint	<b>RF506BK</b>	Aluminum	Nickel Plated	<b>RF506NI</b>
	Aluminum	Chestnut Brown Paint	<b>RF506BN</b>			
Adjustable floor box; 3 inch deep; three (3) 1/2 inch knockouts: one on bottom; one on each side; non-metallic sheathed cable clamps on each side.				Steel	-	<b>RF500</b>



RF515BR



RF506BR

### Drop-In Floor Box for Structural Wood Floors

Description	Material	Rating	Cat. Number
Drop-in floor box; mounts in 2.50 inch hole opening; includes solid brass cover; single 125V tamper-resistant receptacle; optional device mounts for two voice/data video ports; suitable for feed through circuitry; impact resistant box.	Solid Brass	15 Amp	<b>RF151R</b>
	Solid Brass	20 Amp	<b>RF201R</b>



RF500

### Dimensions Inches (mm)

#### Wood Floor Boxes

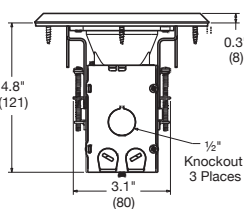
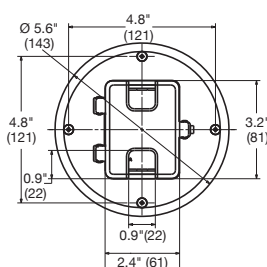

#### Drop-In Floor Box

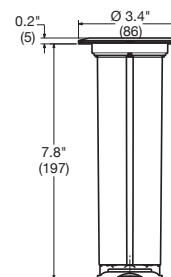
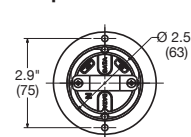

RF151R

Dimensions in Inches (mm)

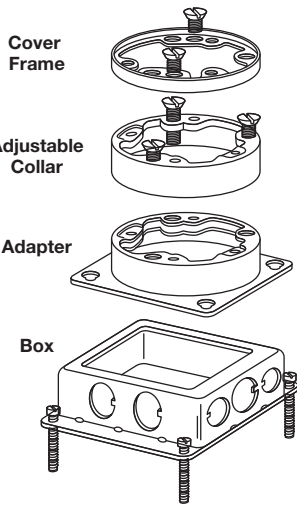

Replacement Adjustable Collar



Replacement Cover Frames



Crown Plugs



Flush Cap Rings



Flush Plugs



Experiencing a problem? Let Hubbell accessories help solve it. Hubbell stacking (adjustable) collars are the answer if the box is set too low. Need a replacement? Choose from a full line of replacement covers and fittings. Hubbell accessories also help you with the protection you need for plugs and receptacles.

## Problem Solvers and Replacement Components Stacking (Adjustable) Collars and Frames

Designed to be used if floor box is set too low beneath the floor surface or the adjustable collar and/or adapter on the box is damaged.

If the box number is...	Extension Value	Use Collar Number
B2429, B2427, B2436 or B2437	.81" (20.5)	<b>C2400*</b>
B2503, B2506	1.06" (26.9)	<b>C2504*</b>
B2529, B2536, B2527 or B2537	1.06" (26.9)	<b>C2500*</b>
B4233	1.03" (26.2)	<b>C4200*</b>
B4333	1.03" (26.2)	<b>C4300*</b>

*Note: \*Only available as sets (collars and adapters). In cases where the adapter on the floor box is not damaged, and only stacking is required, discard the adapter and use only the collar. The adjustable collars listed above can be stacked as required to reach the floor surface. Longer screws will be required if more than one collar is stacked (screws not provided). These screws are commercially available. Flat head #12-24 UNC machine screw x (approx. length). Minor Upward Adjustments: Round or Rectangular cover frames (trim rings) may be stacked if the floor box is only slightly recessed below the floor surface.*

## Replacement Components for Floor Box Covers and Fittings

Box Type	Dimension	Extension Value	Catalog Number	
			Brass	Aluminum
Round	4.19" (106.4) diameter	.31" (7.9)	<b>S5016</b>	<b>SA5016</b>
Rectangular	3.19" (81.0) x 4.38" (111.2)	.31" (7.9)	<b>S5017A</b>	<b>SA5017A</b>
Rectangular, grounding	3.19" (81.0) x 4.38" (111.2)	.31" (7.9)	<b>S5017G</b>	<b>SA5017G</b>

## Crown Plugs

Description	Used in the following covers	Catalog Number	
		Brass	Aluminum
3/4" thread size.	S2525, SA2525, S881, S2555, S2530, S2425, SA2425, SF2525	<b>S5012</b>	<b>SA5012</b>
1" thread size.	S2725, SA2725, S2755, S2730, S2625, SA2625, SF2725	<b>S5013</b>	<b>SA5013</b>

## Flush Cap Rings

Description	Used in the following covers	Catalog Number	
		Brass	Aluminum
2 1/8" threaded plug with 3/4" thread size opening.	S2525, SA2525, S881, S2555, S2530, S2425, SA2425, SF2525	<b>S5010</b>	<b>SA5010</b>
2 1/8" threaded plug with 1" thread size opening.	S2725, SA2725, S2755, S2730, S2625, SA2625, SF2725	<b>S5025</b>	<b>SA5025</b>

## Flush Plugs

Description	Used in the following covers	Catalog Number	
		Brass	Aluminum
3/4" I.P.S. thread size.	F1339, F1340	<b>S5002</b>	-
1" I.P.S. thread size.	F1539	<b>S5003</b>	-
1 1/2" fine thread size.	S3725, SA3725, S3625, SA3625	<b>S5007</b>	<b>SA5007</b>
2 1/8" fine thread size.	S2925, SA2925, S88, S2930, S2955, SF2925, S2825	<b>S5020</b>	<b>SA5020</b>
2 3/8" fine thread size.	S3525, S3425	<b>S5030</b>	-

Dimensions in Inches (mm)



## Problem Solvers and Replacement Components Protective Ring for 2½ Inch Threaded Covers

Description	Catalog Number
Provides mechanical and wet mop protection for plugs and receptacles (brass).	<b>S3061</b>

Protective Ring for 2½" Threaded Covers



S3061

## Theater Seating Floor Box

Description	Catalog Number
The theater seating floor box is nonadjustable and provides a ¼ in. threaded hub for conduit connection to theater aisle lights. It permits opening of the enclosure for wiring without disturbing above floor connections. Other features include a cast iron box with a corrosion-resistant finish and a blank steel cover. Knockouts: (¾ in. surface, ¾ in. sides, ¾ in. bottom) 18.80 cu. in. (380 cubic cm).	<b>F3185</b>

Theater Seating Floor Box



F3185

## Adjustable Tops (Brass) Brass Outlet Fittings for Conduit Systems

Future requirements for floor outlets may be accommodated by systematically studding the floor with these fittings, all radiating from one or more floor boxes, from which any changes or additions may be subsequently made by the pulling of wires from box to the outlet. Adjustment tops are male connections to be mounted on elbow or tee fittings. They provide a pre-pour adjustment and an available connection for above-floor service heads.

Description	A	B	Catalog Number
¾ in. threaded conduit size (male).	1.25" (31.8)	1.44" (36.6)	<b>F1339</b>
1 in. threaded conduit size (male).	1.31" (33.3)	1.75" (44.5)	<b>F1539</b>

Note: Adjustment: ¾ in. and 1 in. fittings permit ½ in. vertical adjustment.

Adjustable Tops (Brass)



F1339

F1539

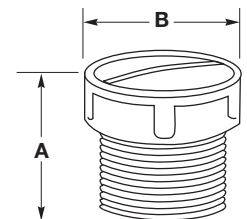

Adjustable Tops

## Coupling (Brass)

Couplings are utilized for straight conduit connections when a floor box is not required. The conduit stub is brought to within approximately 1¼ in. of the planned surface, and the coupling is mounted and adjusted prior to the concrete pour. Standard service heads may be mounted to the couplings as required.

Description	A	B	Catalog Number
¾ in. threaded conduit size (female).	1.44" (36.6)	1.25" (31.8)	<b>F1340</b>

Coupling (Brass)



F1340

Dimensions in Inches (mm)

Floor Boxes  
Hubbell Floor Box Cover to Receptacle  
Compatibility Chart

Cover Style		Terazzo (2 1/8")	2 3/8"	2 1/8"	Duplex Flap	Duplex Plug	Style Line®
Round		S3325 	S3525 	S(A)2925 S(A)2725 S(A)2525 	S(A)3925 	S(A)3725 	
Rectangular			S3425 	S2825 S(A)2625 S(A)2425 	S(A)3825 	S(A)3625 	S(A)3826 
Rating	NEMA Config.						
2P, 3W 15A, 125V	5-15R 	HBL5251 HBL5261 IG5261	HBL5251 HBL5261 IG5261	HBL5251 HBL5261 IG5261	5252AB 5262B CR5252IG HBL5252 HBL5262 IG5262	5252AB 5262B CR5252IG HBL5252 HBL5262 IG5262	HBL2152 IG2152 GF15LA HBL5260SA HBL5262SA
2P, 3W 15A, 125V	L5-15R 	HBL4710 IG4710	HBL4710 IG4710	HBL4710 IG4710	HBL4700 IG4700A HBL4792 HBL4794 HBL4795	HBL4700 IG4700A HBL4792 HBL4794 HBL4795	
2P, 3W 15A, 250V	6-15R 	HBL5661 IG5661	HBL5661 IG5661	HBL5661 IG5661	HBL5652 HBL5662 IG5662	HBL5652 HBL5662 IG5662	
2P, 3W 15A, 250V	L6-15R 	HBL4560 IG4560	HBL4560 IG4560	HBL4560 IG4560	HBL4550 IG4550A	HBL4550 IG4550A	
2P, 3W 15A, 277V	7-15R 				HBL5302	HBL5302	
2P, 3W 15A, 277V	L7-15R 	HBL4760	HBL4760	HBL4760	HBL4750	HBL4750	
2P, 3W 20A, 125V	5-20R 	HBL5361 IG5361	HBL5361 IG5361	HBL5361 IG5361	5352AB 5362B CR5352IG HBL5352 HBL5362 IG5362	5352AB 5362B CR5352IG HBL5352 HBL5362 IG5362	HBL2162 IG2162 GF20LA HBL5360SA HBL5362SA
2P, 3W 20A, 125V	5-20R 				HBL5392	HBL5392	
2P, 3W 20A, 125V	L5-20R 	HBL2310 IG2310	HBL2310 IG2310	HBL2310 IG2310			
2P, 3W 20A, 250V	6-20R 	HBL5461 IG5461	HBL5461 IG5461	HBL5461 IG5461	HBL5462 IG5462	HBL5462 IG5462	
2P, 3W 20A, 250V	L6-20R 	HBL2320 IG2320	HBL2320 IG2320	HBL2320 IG2320			
2P, 3W 30A, 125V	L5-30R 	HBL2610 IG2610	HBL2610 IG2610	HBL2610 IG2610			
2P, 3W 30A, 250V	L6-30R 	HBL2620 IG2620	HBL2620 IG2620	HBL2620 IG2620			
3P, 4W, 20A 125/250V	14-20R 	HBL8410	HBL8410	HBL8410			
	L14-20R 	HBL2410 IG2410	HBL2410 IG2410	HBL2410 IG2410			
3P, 4W, 20A 3Ø 250V	15-20R 	HBL8420	HBL8420	HBL8420			
	L15-20R 	HBL2420 IG2420	HBL2420 IG2420	HBL2420 IG2420			
3P, 4W, 30A 125/250V	L14-30R 	HBL2710 IG2710	HBL2710 IG2710	HBL2710 IG2710			
3P, 4W, 30A 3Ø 250V	L15-30R 	HBL2720 IG2720	HBL2720 IG2720	HBL2720 IG2720			
3P, 4W, 30A 3Ø 600V	L17-30R 	HBL2740	HBL2740	HBL2740			
4P, 5W, 20A 3ØY 120/208V	L21-20R 	HBL2510 IG2510	HBL2510 IG2510	HBL2510 IG2510			
4P, 5W, 20A 3ØY 347/600V	L23-20R 	HBL2530	HBL2530	HBL2530			
4P, 5W, 30A 3ØY 120/208V	L21-30R 	HBL2810 IG2810	HBL2810 IG2810	HBL2810 IG2810			
4P, 5W, 30A 3ØY 347/600V	L23-30R 	HBL2830	HBL2830	HBL2830			

# Floor Boxes CONNEXION Modular Wiring Zone System

## System Planning

The Hubbell CONNEXION Zone Distribution System is a factory assembled, flexible, modular system that delivers power and data in raised floor installations. This unique system increases the value of the infrastructure and meets the challenges posed by new construction and renovation in commercial offices, retail outlets and educational facilities. By improving cable management, enhancing flexibility, and reducing administration expense, the CONNEXION Zone Distribution System allows for power and communications to be located where needed for efficient relocations and upgrades.

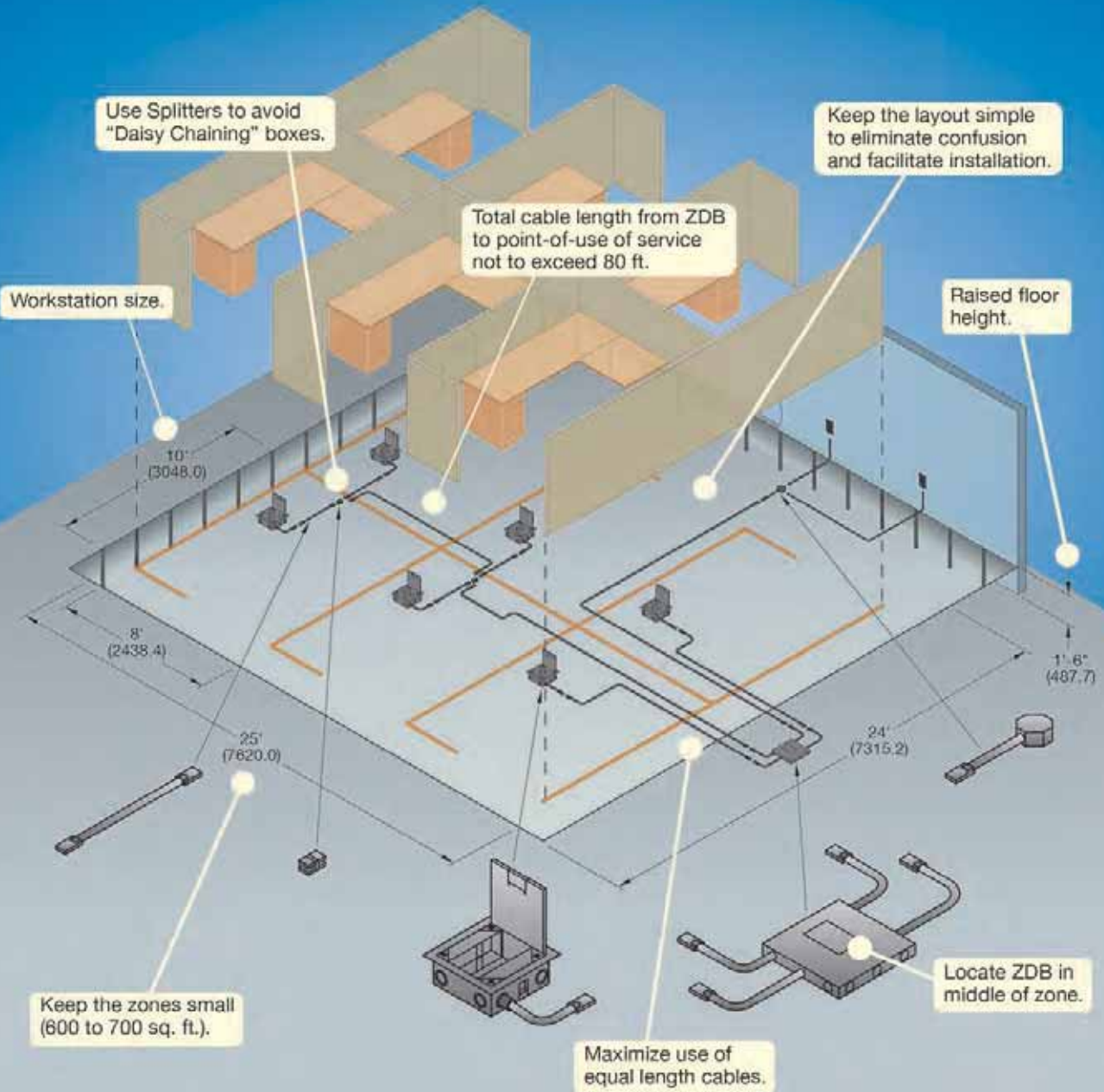

Extender cables



Splitter



Zone Distribution Box

## Floor Boxes CONNEXION – Wiring Schematics

The CONNEXION System is offered in three common 20A per circuit wiring configurations to support the unique requirements of a building infrastructure. The basic system design to deliver all eight wires throughout the Network, consisting of hots, neutrals, grounds, and isolated grounds.

### 4/2/2 System Configuration (4-Hots, 2-Neutrals, 2-Grounds)

#### 3 + 1 Wiring Configuration

Appropriate in areas where moderate amounts of sensitive equipment are used, and where separation from other circuits and isolated grounding are required.

- Three circuits share #10 AWG neutral to manage harmonics for general purpose.
- One circuit on dedicated #10 AWG neutral for sensitive equipment.
- Isolated ground capability for sensitive equipment.
- Component Rating: 20 amperes at 120/208 or 120/240 volt.
- 8-Wires (4 hots, 2 neutrals, 2 grounds).

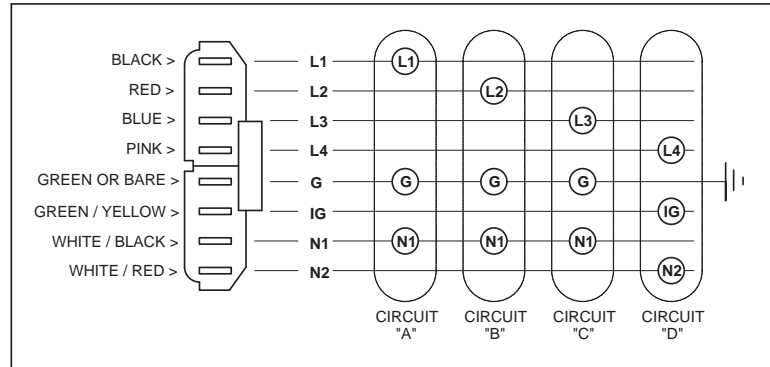

### 4/2/2 System Configuration (4-Hots, 2-Neutrals, 2-Grounds)

#### 2 + 2 Wiring Configuration

Appropriate in areas where a high concentration of sensitive equipment (computers, printers) is needed and minimal amounts of conventional equipment exist.

- Two circuits share one #10 AWG neutral to manage harmonics for general purpose.
- Two additional circuits share one #10 AWG neutral to manage harmonics for general purpose.
- Isolated ground capability for sensitive equipment.
- Component Rating: 20 amperes at 120/208 or 120/240 volt.
- 8-Wires (4 hots, 2 neutrals, 2 grounds).

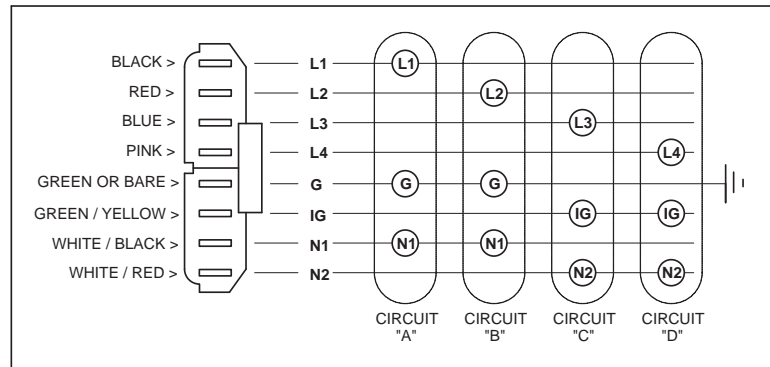

### 3/3/2 System Configuration (3-Hots, 3-Neutrals, 2-Grounds)

#### 2 + 1 Wiring Configuration

Appropriate where either a 120/240 volt or 120/208 volt 3ØY power distribution system exists and separate neutral conductors are desired.

- Three circuit capacity.
- Isolated ground capability for sensitive equipment.
- Each circuit has its own #12 AWG neutral to manage harmonics.
- Component Rating: 20 amperes at 120/208 or 120/240 volt.
- 8-Wires (3 hots, 3 neutrals, 2 grounds).

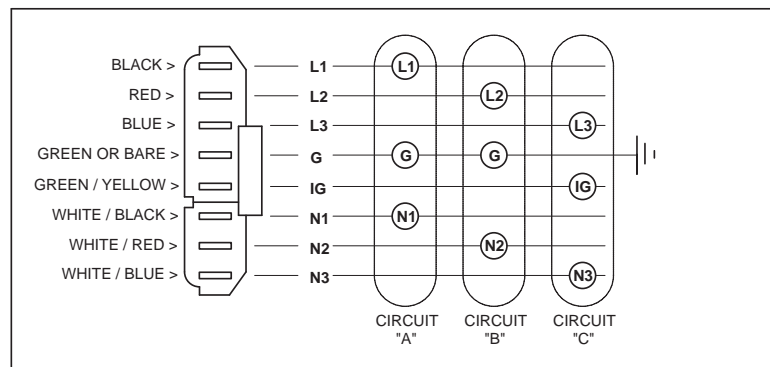

Note: Contact factory for custom wiring configurations.



Expandable Zone Distribution Boxes	Catalog Number
4/2/2 System (2+2)	<b>PDCS42222</b>
4/2/2 System (3+1)	<b>PDCS42231</b>
3/3/2 System	<b>PDCS332</b>

Splitter Modules	Catalog Number
4/2/2 System	<b>SPLITTER422</b>
3/3/2 System	<b>SPLITTER332</b>



Extender Cable Female To Female	Catalog Number
4/2/2 System	<b>EXT422xxFF8W*</b>
3/3/2 System	<b>EXT332xxFF8W*</b>

Note: \*Replace **xx** with \*05\* for 5 ft., \*10\* for 10 ft., \*15\* for 15 ft., \*20\* for 20 ft., \*25\* for 25 ft. and \*30\* for 30 ft. Custom lengths are available upon request.

Furniture Feed	Catalog Number
4/2/2 System	<b>FIJB422</b>
3/2/2 System	<b>FIJB332</b>



Cable Whip Male To Open	Catalog Number
4/2/2 System, 15 in.	<b>EXT42201MO8W</b>
3/3/2 System, 15 in.	<b>EXT33201MO8W</b>
4/2/2 System, 5 ft.	<b>EXT42205MO8W</b>
3/3/2 System, 5 ft.	<b>EXT33205MO8W</b>
4/2/2 System, 15 ft.	<b>EXT42215MO8W</b>
3/3/2 System, 15 ft.	<b>EXT33215MO8W</b>

Cable Whip Female To Open	Catalog Number
4/2/2 System, 15 in.	<b>EXT42201FO8W</b>
3/3/2 System, 15 in.	<b>EXT33201FO8W</b>
4/2/2 System, 5 ft.	<b>EXT42205FO8W</b>
3/3/2 System, 5 ft.	<b>EXT33205FO8W</b>
4/2/2 System, 15 ft.	<b>EXT42215FO8W</b>
3/3/2 System, 15 ft.	<b>EXT33215FO8W</b>



## Pre-Wired Raised Access Floor Box Configuration

### Step 1 – Select a Raised Floor Box Series

Box Series	Description	Dimensions (Including Cover)	Conduit Knockouts
<b>AFB101</b>	4-Gang Deep with Non-Metallic Cover	8.94"L x 6.94"W x 5.18"H	1/2", 3/4", 1"
<b>AFB301</b>	4-Gang Deep with Metal Cover	10.00"L x 10.00"W x 4.30"H	1/2", 3/4", 1", 1 1/4"
<b>AFB401</b>	4-Gang Shallow with Metal Cover	10.00"L x 10.00"W x 2.81"H	1/2", 3/4", 1"
<b>AFB501</b>	8-Gang Deep with Metal Cover	10.00"L x 10.00"W x 5.31"H	1/2", 3/4", 1", 1 1/4"
<b>AFB801</b>	4-Gang Deep, Round with Metal Cover	8.37" Diameter x 5.68"H	1/2", 3/4", 1"

### Step 2 – Use Device Selection Chart to Configure Gangs

Step	Description	(Configured Catalog Number)
Step 2A	If customer needs the 4-gang deep box:	<b>AFB301</b>
Step 2B	Choose 4/2/2 or 3/3/2 System {4 = 4/2/2, 3 = 3/3/2}	<b>AFB3014</b>
Step 2C	Gang 1 - Configure using selection chart	<b>AFB3014A</b>
Step 2D	Gang 2 - Configure using selection chart	<b>AFB3014AE</b>
Step 2E	Gang 3 - Configure using selection chart	<b>AFB3014AEH</b>
Step 2F	Gang 4 - Configure using selection chart	<b>AFB3014AEHZ</b>

Device Selection Chart	
Catalog Letter	Description
<b>A</b>	Line 1, 20A Duplex (5352G)
<b>B</b>	Line 1, 20A, IG Duplex (CR5352IG)
<b>E</b>	Line 2, 20A Duplex (5352G)
<b>F</b>	Line 2, 20A, IG Duplex (CR5352IG)
<b>I</b>	Line 3, 20A Duplex (5352G)
<b>H</b>	Line 3, 20A, IG Duplex (CR5352IG)
<b>O</b>	Line 4, 20A Duplex (5352G)
<b>P</b>	Line 4, 20A, IG Duplex (CR5352IG)
<b>Z</b>	Unpopulated gang, empty for install of tel/data.

Dimensions in Inches (mm)



## Dimensions Inches (mm)

Style	Metallic Cover			Non-Metallic Cover	Metallic Cover
	4-Gang Deep	4-Gang Shallow	8-Gang Deep	4-Gang Deep	3-Gang Power and 1-Gang Low Voltage
 Cover Color Black Gray	 <b>AFB301BK*</b> <b>AFB301GNT*</b>	 <b>AFB401BK*</b> <b>AFB401GNT*</b>	 <b>AFB501BK*</b> <b>AFB501GNT*</b>	 <b>HBLAFB101BK*</b> <b>HBLAFB101GNT*</b>	 <b>AFB801BK†</b> <b>AFB801GNT†</b>
Max. Floor Thickness	2.75" (69.9)	1.88" (47.8)	3.75" (95.3)	2.00" (50.8)	2.62" (66.5)
Cubic Inch (cm3) Capacity Per Gang	31.3 cu. in. (513 cm3)	25.3 cu. in. (414 cm3)	55.6 cu. in. (911 cm3)	(2) 22.5 cu. in. (368.7 cm3) (2) 20.5 cu. in. (335.9 cm3)	(2) 17.1 cu. in. (280 cm3) (1) 15.9 cu. in. (260 cm3)
Dimensions – A	4.00" (101.6)	2.62" (66.5)	5.12" (130.0)	5.18" (131.6)	6.12" (155.4)
Dimensions – B	10.00" (254.0)	10.00" (254.0)	10.00" (254.0)	9.00" (228.6)	–
Dimensions – C	10.00" (254.0)	10.00" (254.0)	10.00" (254.0)	7.00" (177.8)	–
Cover Flange Dim.	12.00" x 12.00"	12.00" x 12.00"	12.00" x 12.00"	10.62" x 8.62"	10.0" Diameter
Knockouts – Sides	(1) 1/2", (2) 1/2" & 3/4", (4) 1 1/4" trade size	(1) 1/2", (6) 1/2" & 3/4" trade size	(1) 1/2", (2) 1/2" & 3/4", (4) 1 1/4" trade size	(4) 1/2" & (4) 3/4", (4) 3/4" & 1" trade size	(1) 1/2", (2) 3/4" & 1" trade size
Knockouts – Bottom	(4) 3/4" & 1" trade size	(4) 3/4" & 1" trade size	(4) 3/4" & 1" trade size	(4) 3/4" & 1" trade size	(3) 1/2" & 3/4" trade size
Cover & Flange Included (Carpet or tile application)	✓	✓	✓	✓	✓
Floor Tile Cut-Out	10.38" x 10.38"	10.38" x 10.38"	10.38" x 10.38"	9.00" x 7.00"	8.375" Diameter



HBLTCGNT



HBLAFB101TCBK\*

### Replacement Metallic Cover and Flange

Description	Dimensions	Color	Catalog Number
Cover and Flange	12"W x 12"L	Gray	HBLTCGNT
Cover and Flange	12"W x 12"L	Black	HBLTCGNTBK

### Replacement Non-Metallic Cover and Flange

Description	Dimensions	Color	Catalog Number
Cover and Flange	7"W x 9"L	Gray	HBLAFB101TCGNT*
Cover and Flange	7"W x 9"L	Black	HBLAFB101TCBK*







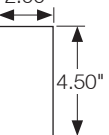

Note: UL File Number E31999. CSA File Number LR702145.

\*For City of Chicago approved versions, use following part numbers: HBLAFB301BASEC, HBLAFB401BASEC and HBLAFB501BASEC. Cover must be ordered separately (i.e., HBLTCGNT and HBLTCGNTBK). These versions do not include knockouts and meet construction requirements for CCEA-2000. AFB covers are reversible for both carpet recess and flush tile applications.











†Insert for flush tile applications included. Remove insert for carpet recess.

\*One faceplate required for data gang only. Cut-out for duplex receptacles included with AFB801.

## Hubbell – Screw Type Face Plates\*\*

2.00"	HBLST302SGY	HBLDE301SGY	HBLT0310SGY	HBLTL318SGY	HBLTL319SGY	HBLBL300SGY	HBLIMFSGY	HBL317SGY
 Typical	 Duplex	 Style Line® Decorator	 Toggle	 Single Receptacle (1.56" Boss Dia.)	 Single Receptacle (1.39" Boss Dia.)	 Blank	 3-Unit Hubbell iSTATION (See Network Wiring section for module options)	 Hubbell 6-Port

## Open Systems – Screw Type Face Plates\*\*

HBLAM303SGY	HBLAMP313SGY	HBLKR314SGY	HBLLT309SGY	HBLPA308SGY	HBLN0309SGY	HBLSI305SGY	HBLSI315SGY	HBLOR306SGY	HBLORT322SGY
 AMP-ACO	 AMP 6-Port	 Krone®/Leviton®	 SYSTIMAX®	 Panduit Mini-Com®	 NORDX® 6-Port (Cat. 5e jacks only)	 Siemon CT® Series	 Siemon MAX® Series	 Ortronics Series II®	 Ortronics TracJack®

Note: \*\*Catalog numbers indicated are gray, replace "GY" with the following to designate color: "BK" for Black, "I" for Ivory and "WA" for White.

AMP is a registered trademark of Tyco Electronics Corp. Krone is a registered trademark of Krone, Inc. Leviton is a registered trademark of Leviton. SYSTIMAX is a registered trademark of CommScope, Inc. Mini-Com and Panduit are registered trademarks of Panduit Corp. NORDX is a registered trademark of Belden/CDT, Inc. MAX and CT Series are registered trademarks of The Siemon Company. TracJack, Series II and Ortronics are registered trademarks of Ortronics/Legrand.

Dimensions in Inches (mm)



### Features and Benefits

- Reduce job site fabrication time and installation labor.
- Reduce job site waste.
- Access Floor Box (AFBPW) pre-wired to your specifications.
  - Choose from Hubbell quality devices.
  - Single or multiple circuit wiring configurations.
  - Various cable lengths.
- AFB installs easily; no disassembly of the box and cover required.
- Pigtail terminates beneath raised floor.
- Box covers available in black or granite powder coat finish.
- Contact Hubbell Wiring Systems for ordering information.
- UL Listed Wiring Assembly, file number E305156.

### Pre-Wired Raised Access Floor Box Options

Box Series	Description	Dimensions (Including Cover)	Conduit Knockouts
<b>AFBPW101</b>	4-Gang Deep with Non-Metallic Cover	8.94"L x 6.94"W x 5.18"H	1/2", 3/4", 1"
<b>AFBPW301</b>	4-Gang Deep with Metal Cover	10.00"L x 10.00"W x 4.30"H	1/2", 3/4", 1", 1 1/4"
<b>AFBPW401</b>	4-Gang Shallow with Metal Cover	10.00"L x 10.00"W x 2.81"H	1/2", 3/4", 1"
<b>AFBPW501</b>	8-Gang Deep with Metal Cover	10.00"L x 10.00"W x 5.31"H	1/2", 3/4", 1", 1 1/4"
<b>AFBPW801</b>	4-Gang Deep with Round Metal Cover	8.37" Diameter x 5.68"H	1/2", 3/4", 1"

**Painted Galvanized Steel Box (14 Gauge G90)**

Cost effective, corrosion resistant paint. Suitable for both on and above-grade applications

**Stainless Steel Box (14 Gauge 304)**

Corrosion resistant enclosure suitable for both on and above-grade applications.

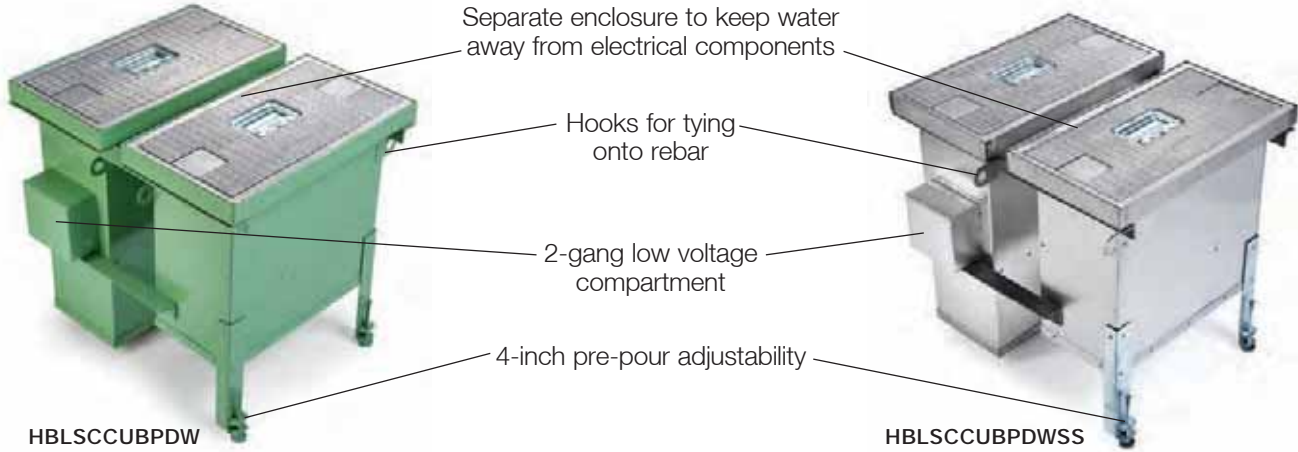

**Features**

- UL Listed and CSA Certified
- Heavy Duty Covers
- Scrub Water
- Custom Built Panels
- Separate Enclosure for Compressed Air and Water Utilities

**Benefits**

- Third party approved and certified.
- 32,000 lb. load capacity with 2x safety factor.
- Meets UL514 requirements for scrub water and prevents water, dirt and debris from entering the electrical devices.
- Accepts a wide variety of electrical configurations including 100A pin and sleeve, 30A Twist-Lock®, straight blade devices and circuit breakers available.
- Prevents air and water utilities from coming in contact with electrical services.

**Metallic Convention Center Utility Boxes\***

Painted Galvanized Steel Box Description	Catalog Number
Steel Convention Center Utility Box with Cover for Power and Data/Communications.	<b>HBLSCCUBPD</b>
Steel Convention Center Utility Box with Cover for Power, Data/Communications and Air/Water Box.	<b>HBLSCCUBPDW</b>
Steel Convention Center Utility Box with Cover for Air/Water Only.	<b>HBLSCCUBW</b>
Stainless Steel Box Description	
Steel Convention Center Utility Box with Cover for Power and Data/Communications in Stainless Steel.	<b>HBLSCCUBPDSS</b>
Steel Convention Center Utility Box with Cover for Power, Data/Communications and Air/Water Box in Stainless Steel.	<b>HBLSCCUBPDWSS</b>
Steel Convention Center Utility Box with Cover for Air/Water Only in Stainless Steel.	<b>HBLSCCUBWSS</b>

*Note: \*All boxes provided with temporary galvanized steel concrete covers.*

**Power and Data Panels\*\***

Custom manufactured and pre-wired to your project specifications. Panel options include 60A pin and sleeve, 20A and 30A Twist-Lock®, 20A GFCI, isolated ground or industrial straight blade devices. Optional circuit breaker protection is available. Up to two-gangs available for audio/video/data communication requirements. Both power and data panels are shipped separately after the boxes have been set in concrete.

*Note: \*\*Contact Hubbell for available configurations of power and data panels.*

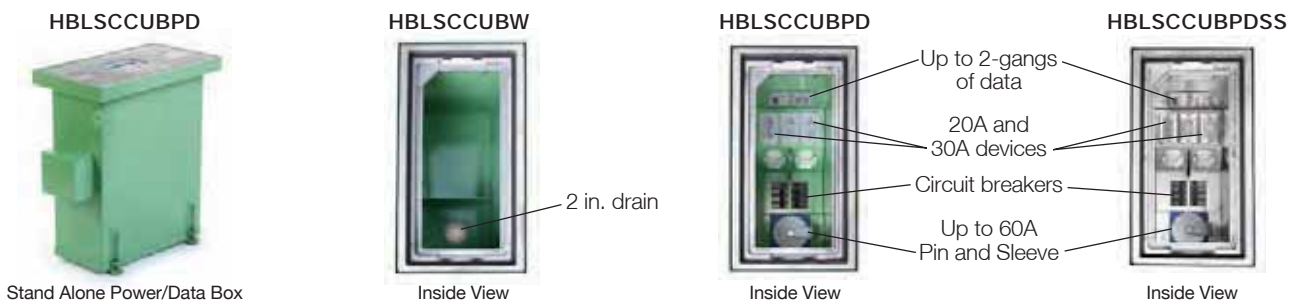



**Painted Galvanized or Stainless Steel Metallic Box**

Stand Alone Power/Data  
 HBLSCCUBPD (Painted Galvanized)  
 HBLSCCUBPDSS (Stainless Steel)

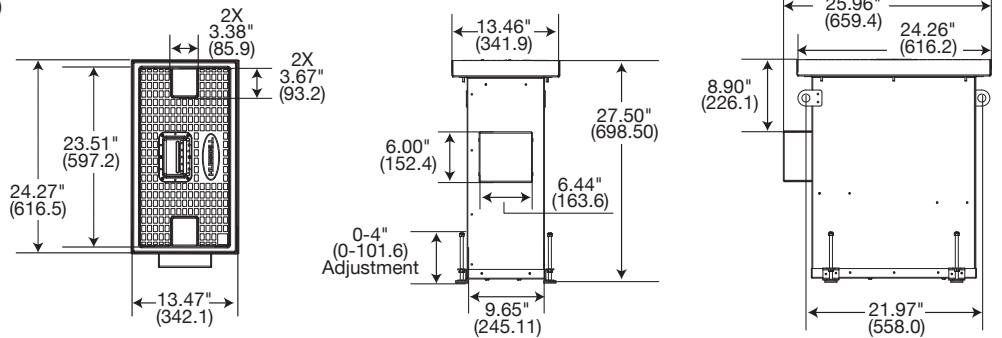

Combination Power/Data/Water  
 HBLSCCUBPDW (Painted Galvanized)  
 HBLSCCUBPDWSS (Stainless Steel)

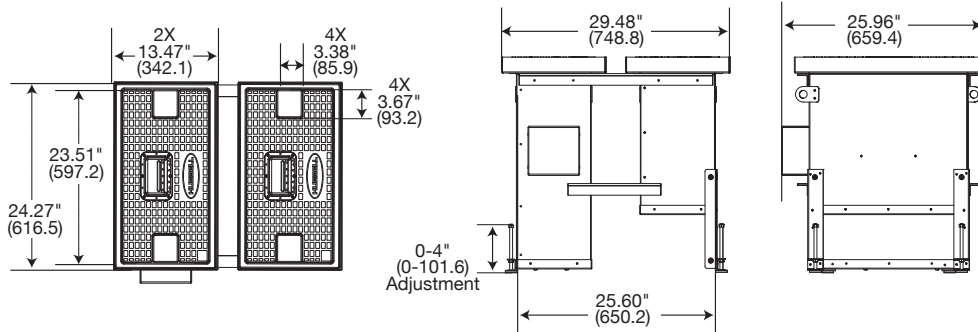

Stand Alone Water/Air Box  
 HBLSCCUBW (Painted Galvanized)  
 HBLSCCUBWSS (Stainless Steel)

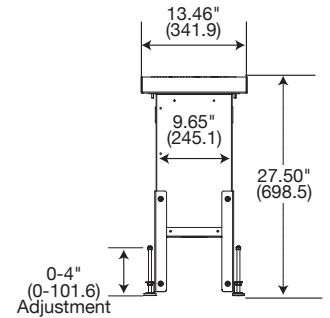

**Pre-Wired Power Panels**

Convention Center Power Panels are custom built to order and pre-wired in the factory to make installation quick and easy. Please contact the factory to configure a power panel for your specific needs.

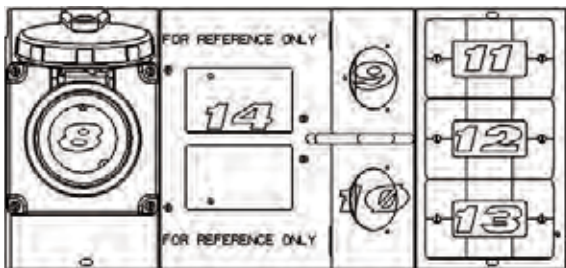

Position	Device Options
8	Qty. (1) Pin and Sleeve Receptacle 60A.
9 & 10	Qty. (2) Twist-Lock® Receptacles (20A or 30A).
11,12,13	Qty. (3) Duplex Receptacles (20A Standard, GFCI or Isolated Ground).
14	Load Center for Circuit Breakers, 8-Pole Positions Max.

Dimensions in Inches (mm)

# Floor Boxes

## Furniture and Work Surface Connectivity Boxes

Applications

This family of furniture and work surface connectivity boxes installs into conference tables and workstations to bring power, voice, data, and multimedia directly to the point of use. In addition, they offer an aesthetic design with improved cable management. Now, users can plug in laptops, projectors and other equipment at the desktop level - no more crawling under the table or moving obstacles to get to the electrical outlet and network connectivity.

### Furniture and Work Surface Connectivity Boxes



#### Flush Mount Boxes

Hubbell offers square and rectangular flush mount boxes in a variety of configurations. These boxes are available in stainless steel, anodized aluminum or painted finishes to match any décor. Boxes are designed for easy installation and are available pre-wired or empty for field wiring.



#### Lift-up Style Boxes

Offering a convenient and attractive method for work surface power and data connections, these boxes are available in several finishes. When not in use, services are concealed by flipping the unit down.



#### Table Mount Boxes

The table mount series can be mounted on any work surface to provide power and data activation. Choose from a variety of mounting brackets that allow temporary or permanent mounting. Units are pre-wired for easy installation.

### Table Top Boxes



#### Pre-Wired Boxes

Round dual-service boxes easily install into a 3½-inch diameter core hole. Power is pre-wired and keystone openings accommodate data or multi-media activation.



#### Pre-Wired Boxes

Configured with 15A power outlet, 15-pin feed through and 3.5mm audio jack. This unit allows for further customization by populating two keystone openings.



#### Low Voltage Boxes

Low voltage only units are available pre-loaded with XLR microphone jack or with keystone opening for Hubbell snap-fit modules.

# Floor Boxes Furniture and Work Surface Connectivity Boxes



## Square Flush Mount Boxes

Description	Finish	Dimensions	Catalog Number
2-Gang Square Flush Mount Box with Cover.	Black	6.5"L x 6.5"W x 3.75"H	<b>HBLSHA2</b>
2-Gang Square Flush Mount Box with Cover.	Stainless Steel	6.5"L x 6.5"W x 3.75"H	<b>HBLSHA2BSS</b>



HBLSHA2

## Rectangular Flush Mount Boxes

Description	Finish	Dimensions	Catalog Number
2-Gang Rectangular Flush Mount with Cover.	Black	10.75"L x 4.06"W x 3.5"H	<b>HBLPHA2</b>
2-Gang Rectangular Flush Mount with Cover.	Stainless Steel	10.75"L x 4.06"W x 3.5"H	<b>HBLPHA2BSS</b>
4-Gang Rectangular Flush Mount with Cover.	Black	10.75"L x 6.5"W x 3.5"H	<b>HBLPHA4</b>
4-Gang Rectangular Flush Mount with Cover.	Stainless Steel	10.75"L x 6.5"W x 3.5"H	<b>HBLPHA4BSS</b>



HBLPHA2

## Surface Mount Boxes

Description	Finish	Dimensions	Catalog Number
2-Gang Surface Mount Box.	Black	4.19"L x 4.81"W x 2.44"H	<b>HBLCON2</b>
3-Gang Surface Mount Box.	Black	6.19"L x 4.81"W x 2.44"H	<b>HBLCON3</b>



HBLCON2

## Recessed Mount Boxes

Description	Finish	Dimensions	Catalog Number
2-Gang Recessed Mount.	Black	10.25"L x 7.0"W x 5.88"H	<b>HBLMIR2</b>
4-Gang Recessed Mount.	Black	31.0"L x 10.25"W x 5.88"H	<b>HBLMIR4</b>



HBLMIR2

## Under Desk Mount Boxes

Description	Finish	Dimensions	Catalog Number
2-Gang Under Desk Mount.	Black	9.19"L x 3.0"W x 2.88"H	<b>HBLMAR2</b>
3-Gang Under Desk Mount.	Black	13.69"L x 3.0"W x 2.88"H	<b>HBLMAR3</b>



HBLMAR2

## Hubbell – Screw Type Face Plates

Dimensions	Product Name	Product Name	Product Name	Product Name	Product Name
2.00" x 4.50"	HBLST302SBK	HBLDE301SBK	HBLBL300SBK	HBLIMFSBK	HBL317SBK
Typical	Duplex	Style Line® Decorator Opening	Blank	3-Unit Hubbell iSTATION (See Network Wiring section for module options)	Hubbell 6-Port

Note: See page O-30 for open systems screw type face plates.

## Table Top Boxes

### Low Voltage Only

Description	Finish	Dimensions	Catalog Number
Table Top box; 2 inch diameter hole; (1) keystone opening; Keystone modules sold separately.	Black Anod. Alum. Clear Anod. Alum. Solid Brass	2.19" Diameter	<b>TTBKSBK</b> <b>TTBKSAL</b> <b>TTBKSBK</b>
Table Top box; 2 inch diameter hole; (1) XLR microphone jack installed.	Black Anod. Alum. Clear Anod. Alum. Solid Brass	2.19" Diameter	<b>TTBXLRBK</b> <b>TTBXLRAL</b> <b>TTBXLRBR</b>



TTBKSBK



TTBXLRBK

### Pre-Wired Dual-Service

Description	Finish	Dimensions	Catalog Number
Table Top box; 3.5 inch diameter hole; (1) pre-wired 15A outlet with 9 foot power supply cord; (1) 3.5mm screw terminal audio jack; (1) 15-pin gender changer F/F; (2) keystone openings; Keystone modules sold separately.	Black Anod. Alum. Clear Anod. Alum. Solid Brass	3.88" Diameter	<b>TTBDS1BK</b> <b>TTBDS1AL</b> <b>TTBDS1BR</b>
Table Top box; 3.5 inch diameter hole; (2) pre-wired 15A outlets with 9 foot power supply cord; (2) keystone openings; Keystone modules sold separately.	Black Anod. Alum. Clear Anod. Alum. Solid Brass	3.88" Diameter	<b>TTBDS2BK</b> <b>TTBDS2AL</b> <b>TTBDS2BR</b>



TTBDS1BK



TTBDS2BK

Dimensions in Inches (mm)



### Square Lift-Up Style

Description	Finish	Dimensions	Catalog Number
Two (2) pre-wired 15A outlets with 6-ft. power supply cord; 1-Unit opening for Hubbell iSTATION modules. Unit rotates up when in use and down to conceal services when not in use.	Black Silver	5.75"L x 5.39"W x 4.25"H	<b>WSBC21UBK</b> <b>WSBC21USV</b>



WSBC21UBK

### Square Mini Lift-Up Style

Description	Finish	Dimensions	Catalog Number
One (1) pre-wired 15A outlet with 9-ft. power supply cord; One (1) RJ-45 jack installed with 6-ft. patch cord.	Black Brushed Stainless Steel	3.7"L x 3.7"W x 2.93"H	<b>WSBA11BK</b> <b>WSBA11BSS</b>
Two (2) pre-wired 15A outlets with 9-ft. power supply cord (power only).	Black Brushed Stainless Steel	3.7"L x 3.7"W x 2.93"H	<b>WSBA2BK</b> <b>WSBA2BSS</b>



WSBA11BK

### Under Table Mount

Description	Finish	Dimensions	Catalog Number
Two (2) pre-wired 15A outlets with 9-ft. power supply cord; One (1) Low Voltage Plate included with 1-Unit opening for Hubbell iSTATION modules.	Black	6.50"L x 1.75"W x 2.25"H	<b>WSBD21UBK</b>



WSBD21UBK

### Work Surface Mount

Description	Finish	Dimensions	Catalog Number
One (1) pre-wired 15A outlet with 9-ft. power supply cord; One (1) Hubbell Keystone opening.	Black Silver	3.57"L x 2.19"W x 2.50"H	<b>WSBE11BK</b> <b>WSBE11SV</b>
Two (2) pre-wired 15A outlets with 9-ft. power supply cord; Two (2) Hubbell Keystone openings.	Black Silver	6.32"L x 2.19"W x 2.50"H	<b>WSBE22BK</b> <b>WSBE22SV</b>
Three (3) pre-wired 15A outlets with 9-ft. power supply cord; One (1) Low Voltage Plate included with 1-Unit opening for Hubbell iSTATION modules.	Black Silver	8.25"L x 2.19"W x 2.50"H	<b>WSBE31UBK</b> <b>WSBE31USV</b>
Mounting bracket with thumb screw (optional).	n/a	n/a	<b>WSBECLAMP</b>



WSBE22SV

### Recessed Concealed Services

Description	Finish	Dimensions	Catalog Number
Two (2) pre-wired 15A outlets with 6-ft. power supply cord; One (1) Low Voltage Plate included with 1-Unit opening for Hubbell iSTATION modules; Two (2) additional 1-Unit openings provided in base of unit.	Black Brushed Anod. Alum. Brushed Stainless Steel	8.98"L x 5.47"W x 2.97"H	<b>WSBB23UBK</b> <b>WSBB23UBAL</b> <b>WSBB23UBSS</b>
Four (4) pre-wired 15A outlets with 6-ft. power supply cord; Two (2) 1-Unit opening for Hubbell iSTATION modules provided in base of unit.	Black Brushed Anod. Alum. Brushed Stainless Steel	8.98"L x 5.47"W x 2.97"H	<b>WSBB43UBK</b> <b>WSBB43UBAL</b> <b>WSBB43UBSS</b>
Empty Enclosure with one (1) duplex opening, One (1) Low Voltage Plate included with 1-Unit opening for Hubbell iSTATION modules; Two (2) additional 1-Unit openings provided in base of unit; intended for field wiring.	Black	8.98"L x 5.47"W x 2.97"H	<b>WSBBHWBK</b>



WSBB23UBK



### Grommet Style

Description	Finish	Dimensions	Catalog Number
Two (2) pre-wired 15A outlets with 6-ft. power supply cord; Two (2) Hubbell Keystone openings.	Black Silver	8.62"L x 3.0"W x 2.25"H	<b>WSBF22BK</b> <b>WSBF22SV</b>
Flush Grommet Cover with dust shield.	Black Silver Brushed Aluminum Brushed Stainless Steel	5.68"L x 3.39"W x 0.96"H	<b>WSBFGROMBK</b> <b>WSBFGROMSV</b> <b>WSBFGROMBAL</b> <b>WSBFGROMBSS</b>



WSBF22BK



WSBFGROMSV



WSBFGROMBK



WSBFGROMSV



WSBFGROMBAL



WSBFGROMBSS

### Pre-Wired Work Surface Elite Series

#### Recessed Concealed Services

Description	Finish	Dimensions	Catalog Number
Four (4) pre-wired 15A outlets with 6-ft. power supply cord; Three (3) Low Voltage Plates included with 1-Unit opening for Hubbell iSTATION modules.	Black Silver Clear Anodized Black Anodized	15.0"L x 9.0"W x 6.25"H	<b>WSBG43UBK</b> <b>WSBG43USV</b> <b>WSBG43UBAL</b> <b>WSBG43UBBA</b>



WSBG43USV  
(cover doors shown open)

#### Pop-Up Style\*

Description	Finish	Dimensions	Catalog Number
Base Unit with Four (4) pre-wired 15A outlets with 6-ft. power supply cord; Two (2) Low Voltage plates included with 1-Unit opening for Hubbell iSTATION modules.	—	8.90"L x 8.90"W x 13.9"H	<b>WSBH42U*</b>
Trim Ring and Decorative Round Top.	Black	5.25" Diameter	<b>WSBHTRBK</b>
Trim Ring and Decorative Round Top.	Brushed Stainless Steel	5.25" Diameter	<b>WSBHTRBSS</b>

Note: \*WSBH42U is CSA Certified only.



WSBH42U with  
WSBHTRBK

#### Replacement Low Voltage Data Plates

Description	Finish	Dimensions	Catalog Number
Non-metallic low voltage plate, blank.	Black	3.18"L x 1.88"W	<b>WSBPLATE1</b>
Non-metallic low voltage plate, 1-Unit Hubbell iSTATION cut-out.	Black	3.18"L x 1.88"W	<b>WSBPLATE2</b>



WSBPLATE1



WSBPLATE2

# Floor Boxes

## Recessed Wall Boxes

AV In-Wall and Ceiling Enclosures



### AV In-Wall Enclosure

Hubbell's netSELECT® Flat Panel Television (FPTV) connection enclosure delivers high-density connectivity and power in the wall. This allows flat panel displays and interactive "smart" boards to sit flush against walls with no dangling cords. It quickly installs to studs or sheetrock without additional components or hardware.

- Optional screw on cover reduces tampering
- cULus 1863 Listed

Accepts Standard Electrical Boxes

Sheet Metal Base White Powder Coat Finish

Integrated Cable Management

Multiple Device Mounting Options

1½" and 1¼" Conduit Knockouts

Easily Mounts to Studs or Sheetrock

Trim Ring Covers Rough-In

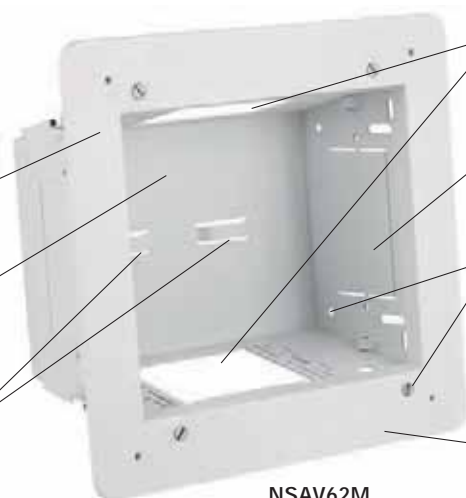

NSAV62M

### FPTV Connection Enclosure

Description	Color	Catalog Number
2-Gang In-Wall Enclosure	White	NSAV62M
Steel Cover for NSAV6 series	White	NSAV6C

### Power Kits (For use with NSAV62M only)

Description	Color	Catalog Number
Standard Power Kit	White	NSOKPTR
Surge Protected Power Kit	Blue	NSOKPS

### AV Connectors and Plates

Description	Color	Catalog Number
1-Gang Blank Plate	White	NP14W
1-Gang Decorator Plate	White	NP26W
1-Gang iSTATION Plate	White	IMF1W
1-Gang 4-Port Keystone Plate	White	NSP14W
1-Port HDMI Frame	White	NS801W
2-Port HDMI Frame	White	NS802W
HDMI Snap Fit	White	SFHC14W
F-Connector Snap Fit	White	NSF70W
USB A-to-B Snap Fit	White	SFUSBABW
Cat 6 Snap Fit Jack	White	NSJ6W

Note: See Network Wiring section for other connector options.



NSAV6C



NSOKPS



NS801W



NSJ6W



SFHC14W

### AV Ceiling Enclosure

The AV Ceiling Enclosure is designed to work with active AV devices to integrate AV distribution, data connections and power in one location, providing a direct connection to a projector or a display device. An additional AV/data kit can be added or customized to address all connector, mounting and patching needs, reducing multiple pieces on site.

- Manage multiple applications inside one enclosure
- Flush mounted, white enclosure for consistent look when mounted in the ceiling
- Loaded with two Hubbell 20A duplex receptacles and a 2-gang back box
- All steel rugged construction provides the ultimate strength for installation



AVCE1H

### AV Ceiling Enclosure

Description	Enclosure Dimensions	Color	Plenum	Non-Plenum
AV Ceiling Enclosure	24" (610) x 12" (305) x 8" (203)	White	AVCE1P	AVCE1H

### Large Capacity 113.3 Cubic Inch Wall Box

Description	Dimensions	Knockouts Sides	Knockouts Back	Catalog Number
Square 2- or 3-gang wall box	4 <sup>11/16</sup> "H x 7 <sup>3/4</sup> "W x 3 <sup>1/4</sup> "D	(4) 1/2" – 3/4" TKO, (4) 3/4" – 1" TKO, (1) 1" – 1 <sup>1/4</sup> " TKO, (2) 3/4" – 2" conc. KO	(2) 1/2" – 3/4" TKO; (2) 3/4" – 1" TKO, (2) 1" – 1 <sup>1/4</sup> " TKO	<b>HBL263</b>



HBL263

### 3-Gang Cover/Mud Rings

Description	Compatible with	Capacity (cu. in.)	Catalog Number
1/2" height	HBL263	10.3	<b>HBL792</b>
3/4" height		12.7	<b>HBL793</b>
1 <sup>1/4</sup> " height		24.2	<b>HBL794</b>



HBL792



HBL793



HBL794

### Low Voltage Partition

Description	Compatible with	Compatible Mud Ring Depth	Packing Quantity	Catalog Number
Low voltage partition	HBL260 and HBL263	1/2", 3/4" and 1 <sup>1/4</sup> "	1	<b>HBL981</b>

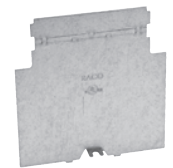

HBL981

### Large Capacity 66.7 Cubic Inch Wall Box

Description	Dimensions	Knockouts Sides	Knockouts Back	Catalog Number
Square 2-gang wall box	4 <sup>11/16</sup> "H x 4 <sup>11/16</sup> "W x 3 <sup>1/4</sup> "D	(2) 3/4" – 1" TKO; (2) 1" – 1 <sup>1/4</sup> " TKO; (2) 3/4" – 2" conc. KO	(2) 3/4" – 1" TKO	<b>HBL260</b>



HBL260

### Low Voltage Partition

Description	Compatible with	Compatible Mud Ring Depth	Packing Quantity	Catalog Number
Low voltage partition	HBL260 and HBL263	1/2", 3/4" and 1 <sup>1/4</sup> "	1	<b>HBL981</b>



HBL981

# Floor Boxes

## Recessed Wall Boxes

Multi-Connect Boxes and Face Plates



1-Gang      2-Gang



3-Gang



4-Gang



6-Gang

### Multi-Service Recessed Wall Boxes for Drywall Applications

Description	Catalog Number
Multi-service recessed wall box, 1-gang, for drywall applications.	HBLWSCS1
Multi-service recessed wall box, 2-gang, for drywall applications.	HBLWSCS2A
Multi-service recessed wall box, 3-gang, for drywall applications.	HBLWSCS3A
Multi-service recessed wall box, 4-gang, for drywall applications.	HBLWSCS4A
Multi-service recessed wall box, 6-gang, for drywall applications.	HBLWSCS6A
Barrier for use with above boxes when used in multi-service applications.	HBLSCSBW

### Wall Box Flanges – Trim Rings

Color	For 1-Gang Box	For 2-Gang Box	For 3-Gang Box	For 4-Gang Box	For 6-Gang Box
Black	HBLTRIM1WBK	HBLTRIM2WBK	HBLTRIM3WBK	HBLTRIM4WBK	HBLTRIM6WBK
Gray	HBLTRIM1WGY	HBLTRIM2WGY	HBLTRIM3WGY	HBLTRIM4WGY	HBLTRIM6WGY
Ivory	HBLTRIM1WI	HBLTRIM2WI	HBLTRIM3WI	HBLTRIM4WI	HBLTRIM6WI
White	HBLTRIM1WWA	HBLTRIM2WWA	HBLTRIM3WWA	HBLTRIM4WWA	HBLTRIM6WWA

Note: See table below for dimensional information.

### Multi-Connect – Dimensional Information

Catalog Number	Height	Width	Depth	Gangs
HBLWSCS1	4.44" (112.8)	2.56" (65.0)	2.75" (69.8)	1
HBLWSCS2A	4.44" (112.8)	4.56" (115.8)	2.75" (69.8)	2
HBLWSCS3A	4.44" (112.8)	6.56" (166.6)	2.75" (69.8)	3
HBLWSCS4A	4.44" (112.8)	8.56" (217.4)	2.75" (69.8)	4
HBLWSCS6A	4.44" (112.8)	12.56" (319.0)	2.75" (69.8)	6
HBLTRIM1W	6.75" (171.4)	4.25" (107.9)	.25" (6.3)	1
HBLTRIM2W	6.75" (171.4)	6.25" (158.7)	.25" (6.3)	2
HBLTRIM3W	6.75" (171.4)	8.25" (209.5)	.25" (6.3)	3
HBLTRIM4W	6.75" (171.4)	10.25" (260.3)	.25" (6.3)	4
HBLTRIM6W	6.75" (171.4)	13.25" (336.5)	.25" (6.3)	6

### Top and Bottom Knockouts

Quantity	Size
1	1/2", 3/4"
1	1/2", 3/4"
2	1/2", 3/4"
1	1/2", 3/4"
3	1/2", 3/4"
—	—
—	—
—	—
—	—
—	—

### Hubbell – Screw Type Face Plates\*

2.00"      4.50"

Typical

HBLST302SGY	HBLDE301SGY	HBLT0310SGY	HBLTL318SGY	HBLTL319SGY	HBLBL300SGY	HBLIMFSGY	HBL317SGY
Duplex	Style Line® Decorator	Toggle	Single Receptacle (1.56" Boss Dia.)	Single Receptacle (1.39" Boss Dia.)	Blank	3-Unit Hubbell iSTATION (See Network Wiring section for module options)	Hubbell 6-Port

### Open Systems – Screw Type Face Plates\*

HBLAM303SGY	HBLAMP313SGY	HBLKR314SGY	HBLLT309SGY	HBLPA308SGY	HBLNO309SGY	HBLSI305SGY	HBLSI315SGY	HBLOR306SGY	HBLORT322SGY
AMP-ACO	AMP 6-Port	Krone®/Leviton®	SYSTIMAX®	Panduit Mini-Com®	NORDX® 6-Port (Cat. 5e jacks only)	Siemon CT® Series	Siemon MAX® Series	Ortronics Series II®	Ortronics TracJack®

Note: \*Catalog numbers indicated are gray, replace "GY" with the following to designate color: "BK" for Black, "I" for Ivory and "WA" for White.

AMP is a registered trademark of Tyco Electronics Corp. Krone® is a registered trademark of Krone, Inc. Leviton® is a registered trademark of Leviton. SYSTIMAX® is a registered trademark of CommScope, Inc. Mini-Com® and Panduit® are registered trademarks of Panduit Corp. NORDX® is a registered trademark of Belden/CDT, Inc. MAX® and CT® Series are registered trademarks of The Siemon Company. TracJack®, Series II® and Ortronics® are registered trademarks of Ortronics/Legrand.



# Section P Fire-Rated Poke-Throughs for Concrete Floors

## Index

Product	Page
Fire-Rated Poke-Throughs (FRPT) Applications . . . . .	P-2
Hubbell SystemOne Recessed Systems . . . . .	P-4
8 Inch Fittings and Sub-Plates . . . . .	P-6
6 Inch Fittings and Sub-Plates . . . . .	P-8
8 Inch Core Hole, One-Piece Units . . . . .	P-10
6 Inch Core Hole, One-Piece Units . . . . .	P-11
Hubbell SystemOne FRPT	
4 Inch Core Hole . . . . .	P-12
4 Inch One-Piece Units . . . . .	P-13
4 Inch Through Floor Fittings . . . . .	P-14
Sub-Plates . . . . .	P-15
Configuration Chart . . . . .	P-16
2X2 Flush FRPT	
3 Inch Core Hole Units . . . . .	P-17
Flush Duplex FRPT	
3 Inch Core Hole Units . . . . .	P-18
Flush Furniture Feed FRPT	
3 Inch Core Hole Units . . . . .	P-19
Painted Pedestal FRPT	
2 and 3 Inch Core Hole Units . . . . .	P-20
Brushed Aluminum Pedestal FRPT	
3 Inch Core Hole Two-Piece Units . . . . .	P-21
Technical Information . . . . .	P-22

Hubbell SystemOne  
Recessed 8 Inch



Hubbell SystemOne  
Recessed 6 Inch



Hubbell SystemOne  
Multi-Service Application



Hubbell SystemOne  
4x4 Application



# Fire-Rated Poke-Throughs for Concrete Floors

## Hubbell Fire-Rated Poke-Throughs

### Features and Benefits

Hubbell's SystemOne Recessed Fire-Rated Poke-Throughs (FRPT) enhances functionality providing increased power, data and audio visual capacity. Safety is improved with recessed connectivity, a low profile flange, and egress doors that hinge inwards. Building value is enhanced with plated finishes to match and blend with modern building décor.

## Hubbell SystemOne FRPTs for 8" Core Hole Applications...



**High Capacity Multimedia Applications**  
Sub-plate layout for the center three gangs of the eight inch FRPT allows for maximum audio visual capacity. The NEMA spacing allows the product flexibility to easily accept 3rd party products.



**High Capacity Multimedia Applications**  
Perimeter sub plates for the eight inch FRPT help compliment the audio visual or data in the center three gangs. Additionally these plates can be exchange for other low voltage compatible plates.

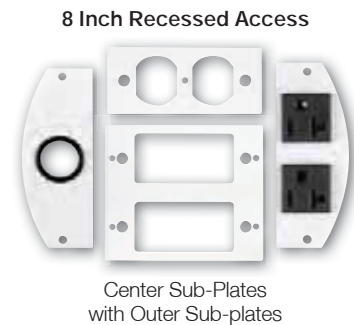

## Hubbell SystemOne FRPTs for 6" Core Hole Applications...



**60/40 6" Sub-Plate Split**  
An industry first, the 60/40 sub-plate layout allows for unmatched capacity with up to 12 keystone jacks and one 20A duplex.



**50/50 6" Sub-Plate Split**  
Two duplexes with ample audio/video and data are achieved by using the 50/50 sub-plate layout. Additionally this layout will accommodate two Style Line® devices for GFCI, surge, etc. applications.

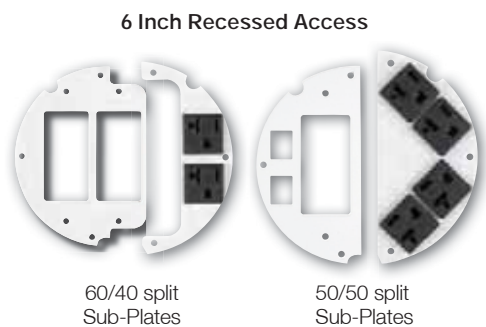

# Fire-Rated Poke-Throughs for Concrete Floors

## Hubbell Fire-Rated Poke-Throughs

### Features and Benefits

Featuring the innovative SystemOne product line, Hubbell's offering of Fire-Rated Poke-Throughs (FRPT) products provide installers with a broad range of options to support a wide array of connections. Hubbell SystemOne flush FRPTs install in a 4" core hole and provide users the flexibility to create personal solutions for their most demanding applications.

## Hubbell SystemOne FRPTs for 4" Core Hole Applications...

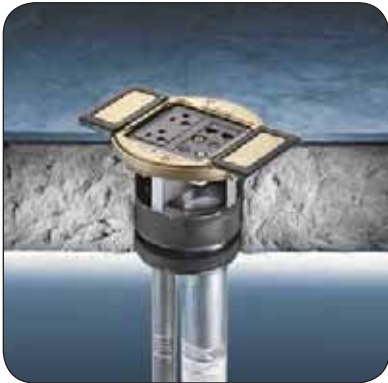

### Multi-Service Applications

This Hubbell SystemOne sub-plate incorporates two Style Line® rectangular openings. These can be used for a variety of power and/or data applications. It will accommodate 15 or 20 amp, standard, isolated ground, GFCI or surge protected receptacles. Using communication frames it can provide up to a 6-port multi-service or a 12-port all communication solution.



### Multimedia Applications

Other Hubbell SystemOne sub-plates are designed to meet the growing needs of the audio and video markets. Some sub-plates provide power outlets with Hubbell's audio/video products including 15-pin SVGA, RCA, S-Video, 3.5mm stereo, and XLR microphone jacks. Other sub-plates can accommodate Extron® Electronics MAAP and AAP series audio/video modules.



### 4X4 Applications

Provides maximum power capacity for flush, multi-service applications. This sub-plate features a pre-wired four outlet 20A, 125V receptacle and four openings for Hubbell's Snap Fit, flush mount modular jacks and audio/video connectors.

## Traditional FRPTs for 3" and 2" Core Hole Applications...



### Flush Applications

Hubbell offers a variety of single and multi-service flush fire-rated poke-through products. It incorporates a Hubbell Style Line®, 20 amp, duplex receptacle and two Hubbell Category 5e data jacks. The jacks mount flush to the cover for an unobtrusive appearance. Various colors and all brass versions are available.



### Pedestal Applications

Hubbell offers single and multi-service pedestal style FRPTs for those applications requiring above-the-floor connections. Available in 2-, 4- or 6-gang sizes, pedestal FRPTs provide more power and low voltage connections to the desktop than most flush configurations in a 3 inch core hole.



### Furniture Feed Applications

Hubbell offers single and multiple service flush and pedestal style FRPTs that deliver power and voice/data cabling to feed furniture systems. Various models can feed up to 2 inch conduit and can accommodate up to 36 Category 5e data cables.

*Extron® is a registered trademark of Extron Electronics.*

# Fire-Rated Poke-Throughs for Concrete Floors Hubbell SystemOne Recessed Systems Features and Benefits

## Safety

- Low profile flange, 0.150", is better than ADA requirements
- Hide-away egress doors fold under cover while in use
- 180° opening of main door

## Functionality

- Cables and connections are protected by recessed functionality
- Open architecture sub-plate design
- Dirt ingress reduced by egress door brushes
- Exceeds UL 514A Scrub Requirements with ScrubShield technology
- Easy selection with common flange for all floor types



## Value

- Enhance building décor with numerous finishes
- Increase durability and longevity with cast aluminum covers

## 6 Inch Sub-Plate Features

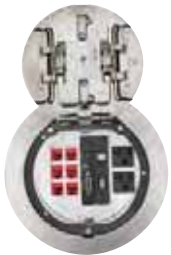

### 60/40 Device Plate Combination

- Allows for a wide array of data and audio visual connectivity with a 20A duplex receptacle
- The two plates can be independently wired



### 50/50 Device Plate Combination

- Accommodates up to two 20A duplex receptacles with eight data or audio visual connections
- The two plates can be independently wired

## 8 Inch Sub-Plate Features



### Center Plate Configurations

- Allows for three duplex receptacles or up to 18 data and or audio visual jacks
- Open architecture sub-plate design accommodates FSR®, Extron®, Crestron®, etc.
- NEMA spacing between devices
- All plates can be independently wired

### Outer Plate Configurations

- Available in pre-wired 20A duplex receptacles or data/AV plates
- Multiple 20A duplex receptacles can be wired to a common circuit or independently

## On-line Resources

- BIM models, customer drawings and technical specifications are available on [www.hubbell-wiring.com](http://www.hubbell-wiring.com)

Extron® is a registered trademark of Extron Electronics.  
Crestron® is a registered trademark of Crestron Electronics, Inc.  
FSR® is a registered trademark of FSR Inc.

**STEP 1: Select Poke Through**

8 Inch Recessed Access



6 Inch Recessed Access



6 Inch Furniture Feed



**STEP 2: Select Sub-Plates**

8 Inch Recessed Access



Center Sub-Plates  
with Outer Sub-plates

6 Inch Recessed Access

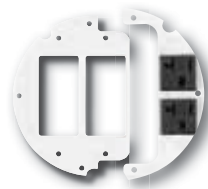

60/40 split  
Sub-Plates

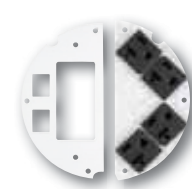

50/50 split  
Sub-Plates

*Note: Furniture feed model does not use sub-plates.*

**STEP 3: Select Cover Finishes**



Black  
Powder Coat



Bronze  
Plated Finish

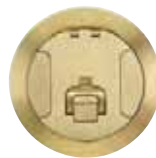

Brushed  
Brass Plated



Satin  
Nickel Plated



Brushed  
Aluminum

**Recommended Fire-Rated Poke-Through Size Chart**

To avoid over or under utilizing the capacity of the fire-rated poke-through, first determine how many gangs of power, data and AV are required for the application. The matrix below will guide you to the correct poke-through size.

		Recommended Fire-Rated Poke-Through Size					
<b>POWER GANGS</b>	5	8"	Exceeds capacity				
	4	8"	8"	of Hubbell recessed			
	3	6"	8"	8"	poke-throughs		
	2	6"	6"	8"	8"		
	1	6"	6"	6"	8"	8"	
	0	—	6"	6"	8"	8"	8"
		0	1	2	3	4	5
		<b>DATA AND AV GANGS</b>					

Example: 2 gangs of power, 1 gang of AV and 1-gang of data is required.  
 Find the intersection for 2 power gangs with 2 data/AV gangs.  
 The highlighted intersection defines the recommended FRPT.

# Fire-Rated Poke-Throughs for Concrete Floors Hubbell SystemOne Recessed Systems 8 Inch Fire-Rated Poke-Through Fittings

- Step down installation
- Maintains concrete floor fire rating up to two hours
- Junction box standard
- For use in the City of Chicago applications, junction box is NOT included
- Features ScrubShield<sup>®</sup> technology that exceeds UL514A scrub water exclusion requirements

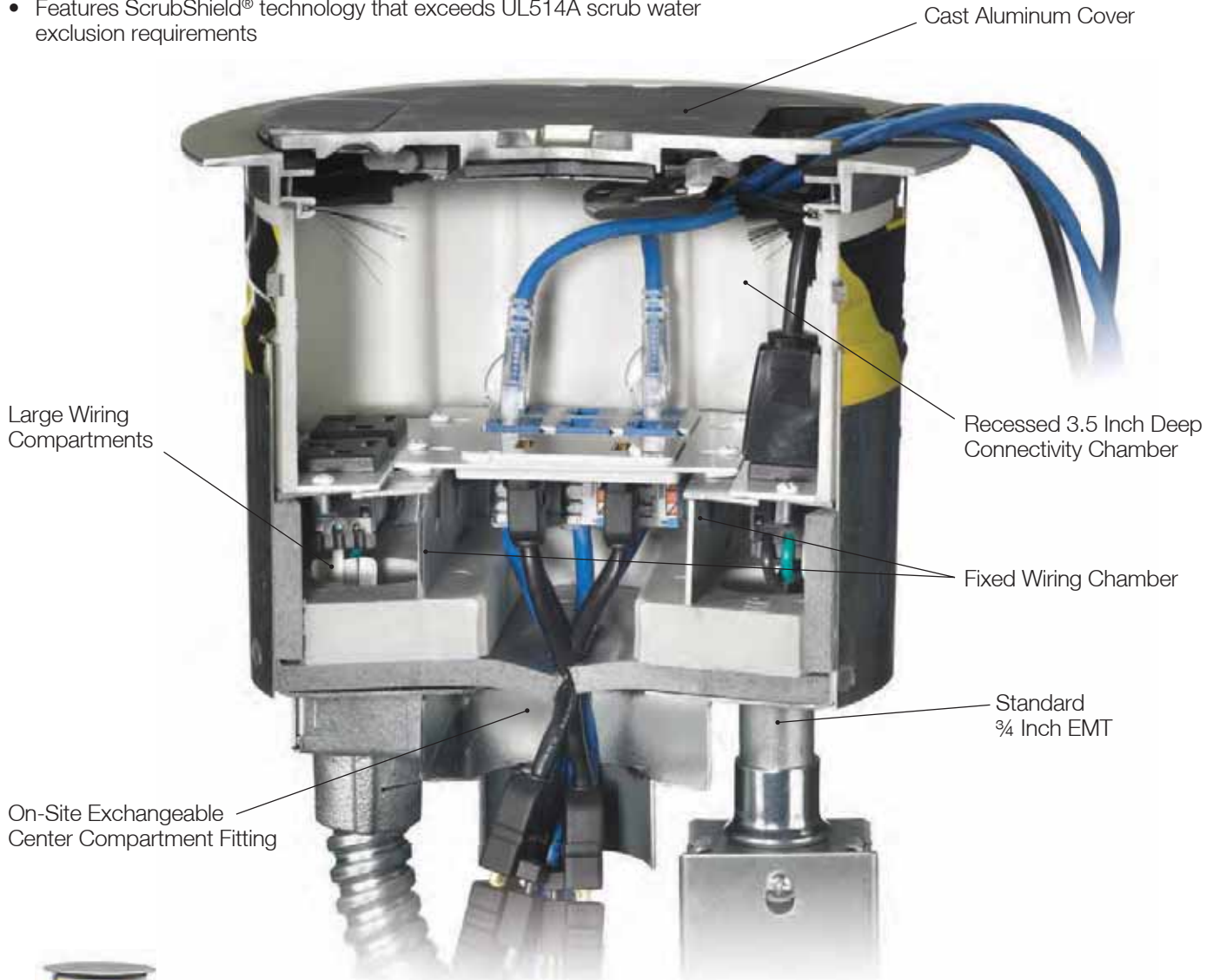

## 8 Inch Fire-Rated Poke-Through

Description	Catalog Number
8 Inch Fire-Rated Poke-Through includes: (1) 3/4 inch power EMT plus (1) S1R8JNC1 with (1) 1 inch EMT and (1) 1 1/2 inch EMT.	<b>S1R8PTFIT1</b>
8 Inch Fire-Rated Poke-Through includes: (1) 3/4 inch power EMT plus (1) S1R8JNC2 with (2) 1 inch EMT.	<b>S1R8PTFIT2</b>
8 Inch Fire-Rated Poke-Through includes: (1) 3/4 inch power EMT plus (1) S1R8JNC3 with (1) 2 inch EMT.	<b>S1R8PTFIT3</b>
8 Inch Fire-Rated Poke-Through includes: (1) 3/4 inch power EMT plus (1) S1R8JNC1 with (2) 1inch EMT and (1) 1 1/2 inch EMT. No Junction box or flexible metal conduit.	<b>S1R8PTFIT1CHI</b>
8 Inch Fire-Rated Poke-Through includes: (1) 3/4 inch power EMT plus (1) S1R8JNC2 with (2) 1 inch EMT. No Junction box or flexible metal conduit.	<b>S1R8PTFIT2CHI</b>
8 Inch Fire-Rated Poke-Through includes: (1) 3/4 inch power EMT plus (1) S1R8JNC3 with (1) 2 inch EMT. No Junction box or flexible metal conduit.	<b>S1R8PTFIT3CHI</b>

*Note: See page P-22 for technical information.*



# Fire-Rated Poke-Throughs for Concrete Floors Hubbell SystemOne Recessed Systems 8 Inch Sub-Plates

## Center Plate Configurations

- Allows for 3 duplexes or up to 18 data/AV jacks. Other combinations possible
- Accepts third party AV devices (i.e. FSR®, Crestron®, Extron®)
- Standard NEMA spacing between devices











## Outer Plate Configurations







- Available in pre-wired duplexes or openings to accommodate third party AV Devices
- Multiple duplexes can be wired in the supplied junction box or independently







## Center Sub-Plates - Single Gang

Description	Catalog Number	Description	Catalog Number
Blank cover plate	 <b>S1R8CSPB</b>	(2) Extron® MAAP openings	 <b>S1R8CSPC</b>
(1) 1 unit Hubbell iSTATION opening	 <b>S1R8CSPD</b>	(1) 1.5 unit Hubbell iSTATION opening (See section W for modules)	 <b>S1R8CSPE</b>
(1) 1.60" opening for 20A & 30A Twist-Lock®	 <b>S1R8CSPG</b>	(1) Duplex opening	 <b>S1R8CSPI</b>
(1) 1.40" opening for simplex or 15A Twist-Lock®	 <b>S1R8CSPJ</b>	(1) Style Line® Decorator opening	 <b>S1R8CSPK</b>

## Outer Sub-Plates

Description	Catalog Number	Description	Catalog Number
Blank cover plate	 <b>S1R8PSPU</b>	Single Extron® MAAP opening	 <b>S1R8PSPV</b>
Pull through with 1" bushing opening	 <b>S1R8PSPW</b>	Single Extron® MAAP opening	 <b>S1R8PSPX</b>
(1) 1 unit Hubbell iSTATION opening (See section W for modules)	 <b>S1R8PSPY</b>	Dual 20A pre-wired power cubes; one circuit (Supplied with isolated ground sticker)	 <b>S1R8PSPZ</b>

## Center Sub-Plates - Two and Three Gang

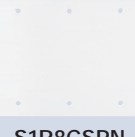
Two gang; (4) Extron® AAP openings	 <b>S1R8CSPA</b>	Two gang; 3 unit Hubbell iSTATION opening (See section W for modules)	 <b>S1R8CSPL</b>
Two gang; (2) Style Line® Decorator openings	 <b>S1R8CSPM</b>	Two gang; device depth extension collar (for use with 3rd party data up to 2.5" depth or two power receptacles)	 <b>S1R8CSPEXT</b>
Three gang; blank cover plate	 <b>S1R8CSPN</b>		

Note: Rectangle sub-plates are for center compartment, crescent sub-plates are for outer compartments and are not inter-changeable

Extron® is a registered trademark of Extron Electronics.  
Crestron® is a registered trademark of Crestron Electronics, Inc.  
FSR® is a registered trademark of FSR Inc.

## Recessed 8 Inch Cover

Single Piece 8 Inch FRPT Cover Assembly unit includes solid cast aluminum construction, carpet gasket and mounting hardware.



Finish	Catalog Number
Brushed Aluminum	<b>S1R8CVRALU</b>
Black Powder Coat	<b>S1R8CVRBLK</b>
Brushed Brass Plated	<b>S1R8CVRBRS</b>
Bronze Plated Finish	<b>S1R8CVRBRZ</b>
Satin Nickel Plated	<b>S1R8CVRNKL</b>



**S1R8PPT**

## 8 Inch Accessories

Description	Catalog Number
Pre-pour tube, includes hardware	<b>S1R8PPT*</b>
Abandonment plate, black finish	<b>S1R8ADMTBK</b>
Low voltage replacement divider	<b>S1R8DIV</b>
Power junction box, 27.0 cubic inches; (1) ¾ inch and (1) 1 inch EMT connector	<b>S1FRPTJB</b>

**S1FRPTJB**



**S1R8JNC1**



**S1R8JNC2**



**S1R8JNC3**

## Replacement Fitting Box

Description	Catalog Number
(1) 1 inch & (1) 1½ inch EMTs	<b>S1R8JNC1</b>
(2) 1 inch EMTs	<b>S1R8JNC2</b>
(1) 2 inch EMT	<b>S1R8JNC3</b>

Note: \*Not UL Listed.

# Fire-Rated Poke-Throughs for Concrete Floors Hubbell SystemOne Recessed Systems 6 Inch Fire-Rated Poke-Through Fittings

**ScrubShield®**    
Complies with UL514A

- Step down installation
- Maintains concrete floor fire rating up to two hours
- Junction box standard
- Includes (1) 2 inch data/AV EMT and (1) ¼ inch power EMT
- For use in the City of Chicago applications, junction box is NOT included
- Features ScrubShield® technology that exceeds UL514A scrub water exclusion requirements

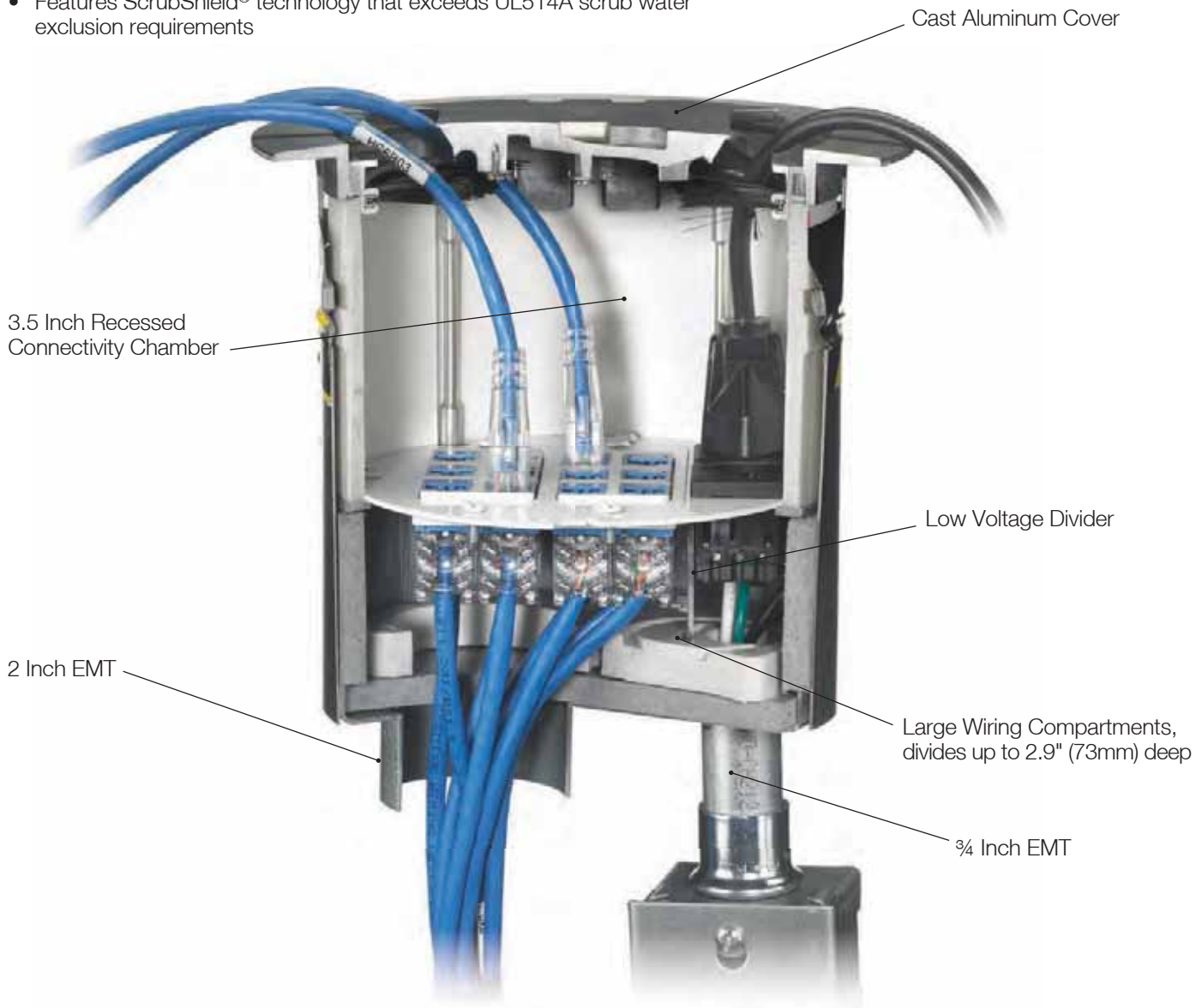

S1R6PTFIT



S1R6PTFITCHI

## 6 Inch Fire-Rated Poke-Through

Description	Catalog Number
6 Inch Fire-Rated Poke-Through	<b>S1R6PTFIT</b>
6 Inch Fire-Rated Poke-Through; for use in the City of Chicago	<b>S1R6PTFITCHI</b>

*Note: See page P-23 for technical information.*







# Fire-Rated Poke-Throughs for Concrete Floors Hubbell SystemOne Recessed Systems 6 Inch Sub-Plates

## 60/40 Device Plate Combination



- Allows for up to twelve data/AV jacks plus a 20A duplex receptacle
- Two plates which can be wired independently



### Left 60% Sub-Plates

Description	Catalog Number	Description	Catalog Number
(1) Style Line® Decorator and (2) Extron® MAAP openings, left side only	 <b>S1R6SPV</b>	(1) Style Line® Decorator and (2) Extron® AAP openings, left side only	 <b>S1R6SPX</b>
(2) Style Line® Decorator openings, left side only	 <b>S1R6SPW</b>	(1) Style Line® Decorator and (2) 1.5 unit Hubbell iSTATION openings, left side only (See section W for modules)	 <b>S1R6SPY</b>

### Right 40% Sub-Plates

(2) 20A pre-wired receptacles; 16 inch lead; one circuit, right side only (Supplied with isolated ground sticker)	 <b>S1R6SPZ</b>	(2) 20A pre-wired receptacles; 25 foot lead; one circuit, right side only (Supplied with isolated ground sticker)	 <b>S1R6SPZ25</b>
---	--	---	--

### Recessed 6 Inch Cover

6 Inch Fire-Rated Poke-Through cover assembled unit includes solid cast aluminum construction, carpet gasket and mounting hardware.



Finish	Catalog Number	Furniture Feed Option
Brushed Aluminum	<b>S1R6CVRALU</b>	<b>S1R6FFCVRALU</b>
Black Powder Coat	<b>S1R6CVRBLK</b>	<b>S1R6FFCVRBLK</b>
Brushed Brass Plated	<b>S1R6CVRBRS</b>	<b>S1R6FFCVRBRS</b>
Bronze Plated Finish	<b>S1R6CVRBRZ</b>	<b>S1R6FFCVRBRZ</b>
Satin Nickel Plated	<b>S1R6CVRNKL</b>	<b>S1R6FFCVRNKL</b>

### 6 Inch Accessories

Description	Catalog Number
Pre-pour tube, including hardware	<b>S1R6PPT*</b>
Abandonment plate, black finish	<b>S1R6ADMTBK</b>
Low voltage replacement divider	<b>S1R6DIV</b>
Power junction box, 27.0 cubic inches; (1) 3/4 inch and (1) 1 inch EMT connector	<b>S1FRPTJB</b>
Replacement furniture feed fitting	2 Inch <b>S1RFFFIT2</b> 3/4 Inch <b>S1RFFFIT075</b>
Replacement plugs	2 Inch Aluminum <b>S1RPLUG2ALU</b> 3/4 Inch Aluminum <b>S1RPLUG075ALU</b> Black <b>S1RPLUG2BLK</b> Black <b>S1RPLUG075BLK</b> Brass <b>S1RPLUG2BRS</b> Brass <b>S1RPLUG075BRS</b> Bronze <b>S1RPLUG2BRZ</b> Bronze <b>S1RPLUG075BRZ</b> Nickel <b>S1RPLUG2NKL</b> Nickel <b>S1RPLUG075NKL</b>









Note: \*Not UL Listed.

## 50/50 Device Plate Combination





- Allows for up to eight Hubbell data jacks plus two 20A duplex receptacles
- Two plates which can be wired independently



### Left 50% Sub-Plates

Description	Catalog Number	Description	Catalog Number
(3) Extron® MAAP plate openings, left side only	 <b>S1R6SPA</b>	Blank cover plate, left side only	 <b>S1R6SPB</b>
(5) Extron® MAAP plate openings, left side only	 <b>S1R6SPC</b>	(4) 1 unit Hubbell iSTATION openings, left side only (See section W for modules)	 <b>S1R6SPD</b>
(1) Style Line® Decorator and (2) Hubbell keystone jack openings, left side only	 <b>S1R6SPE</b>	(2) 1.5 unit Hubbell iSTATION openings, left side only (See section W for modules)	 <b>S1R6SPF</b>
(3) Extron® MAAP openings and (2) Hubbell keystone jack openings, left side only	 <b>S1R6SPL</b>	(1) Style Line® Decorator opening, left side only	 <b>S1R6SPM</b>

### Right 50% Sub-Plates

(1) 1.60 inch opening for 20A and 30A Twist-Lock®, right side only	 <b>S1R6SPG</b>	(4) 20A pre-wired receptacles; 16 Inch leads; one or two circuits, right side only (Supplied with isolated ground sticker)	 <b>S1R6SPH</b>
(1) Duplex device opening, right side only	 <b>S1R6SPI</b>	(1) 1.40 inch opening for simplex or 15A Twist-Lock®, right side only	 <b>S1R6SPJ</b>
(1) Style Line® Decorator device opening, right side only	 <b>S1R6SPK</b>		

Note: Sub-plates can not be rotated to create additional layouts. When assembled, sub-plates can not overlap.  
Custom Plates available upon request and may be subject to minimum order quantity.

Extron® is a registered trademark of Extron Electronics.

# Fire-Rated Poke-Throughs for Concrete Floors Hubbell SystemOne Recessed Systems 8 Inch Core Hole, One-Piece Units



## One-Piece Pre-Wired 8 Inch Fire-Rated Poke-Through

Assembled unit includes:

- (1) Hubbell SystemOne 8 inch floor fitting (S1R8PTFIT1)
  - (4) 20A, prewired receptacles, 18 inch wire lead, two pieces (S1R8PSPZ)
  - (1) Fitting connection box with 1 inch and 1½ inch EMT stubs (S1R8JNC1)
  - (1) 8 inch flange and universal cover assembly (S1R8CVRxx)
- Receptacles feature single circuit wiring



Finish	Catalog Number
Brushed Aluminum	S1R8PTZZ1ALU
Black Powder Coat	S1R8PTZZ1BLK
Brass Plated	S1R8PTZZ1BRS
Bronze Plated Finish	S1R8PTZZ1BRZ
Nickel Plated	S1R8PTZZ1NKL

## One-Piece 8 Inch Fire-Rated Poke-Through

Assembled unit includes:

- (1) Hubbell SystemOne 8 inch floor fitting (S1R8PTFIT1)
- (1) Fitting connection box with 1 inch and 1½ inch EMT stubs (S1R8JNC1)
- (1) 8 inch flange and universal cover assembly (S1R8CVRxx)



Finish	Catalog Number
Brushed Aluminum	S1R8PT1ALU
Black Powder Coat	S1R8PT1BLK
Brass Plated	S1R8PT1BRS
Bronze Plated Finish	S1R8PT1BRZ
Nickel Plated	S1R8PT1NKL



## One-Piece Pre-Wired 8 Inch Fire-Rated Poke-Through

Assembled unit includes:

- (1) Hubbell SystemOne 8 inch floor fitting (S1R8PTFIT2)
  - (4) 20A, pre-wired receptacles, 18 inch wire lead, two pieces (S1R8PSPZ)
  - (1) Fitting connection box with (2) 1 inch EMT stubs (S1R8JNC2)
  - (1) 8 inch flange and universal cover assembly (S1R8CVRxx)
- Receptacles feature single circuit wiring

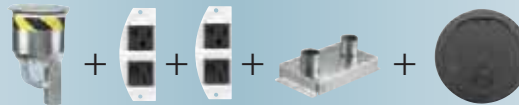

Finish	Catalog Number
Brushed Aluminum	S1R8PTZZ2ALU
Black Powder Coat	S1R8PTZZ2BLK
Brass Plated	S1R8PTZZ2BRS
Bronze Plated Finish	S1R8PTZZ2BRZ
Nickel Plated	S1R8PTZZ2NKL

## One-Piece 8 Inch Fire-Rated Poke-Through

Assembled unit includes:

- (1) Hubbell SystemOne 8 inch floor fitting (S1R8PTFIT2)
- (1) Fitting connection box with (2) 1 inch EMT stubs (S1R8JNC2)
- (1) 8 inch flange and universal cover assembly (S1R8CVRxx)

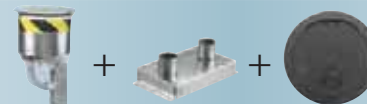

Finish	Catalog Number
Brushed Aluminum	S1R8PT2ALU
Black Powder Coat	S1R8PT2BLK
Brass Plated	S1R8PT2BRS
Bronze Plated Finish	S1R8PT2BRZ
Nickel Plated	S1R8PT2NKL



## One-Piece Pre-Wired 8 Inch Fire-Rated Poke-Through for Data AV

Assembled unit includes:

- (1) Hubbell SystemOne 8 inch floor fitting (S1R8PTFIT3)
  - (4) 20A, prewired receptacles, 18 inch wire lead, two pieces (S1R8PSPZ)
  - (1) Fitting connection box with one 2 inch EMT stubs (S1R8JNC3)
  - (1) 8 inch flange and universal cover assembly (S1R8CVRxx)
- Receptacles feature single circuit wiring

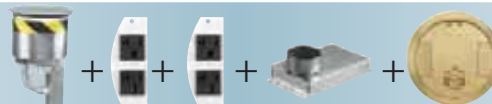

Finish	Catalog Number
Brushed Aluminum	S1R8PTZZ3ALU
Black Powder Coat	S1R8PTZZ3BLK
Brass Plated	S1R8PTZZ3BRS
Bronze Plated Finish	S1R8PTZZ3BRZ
Nickel Plated	S1R8PTZZ3NKL

## One-Piece 8 Inch Fire-Rated Poke-Through

Assembled unit includes:

- (1) Hubbell SystemOne 8 inch floor fitting (S1R8PTFIT3)
- (1) Fitting connection box with (1) 2 inch EMT stubs (S1R8JNC3)
- (1) 8 inch flange and universal cover assembly (S1R8CVRxx)

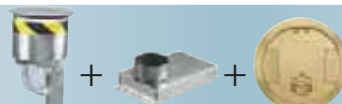

Finish	Catalog Number
Brushed Aluminum	S1R8PT3ALU
Black Powder Coat	S1R8PT3BLK
Brass Plated	S1R8PT3BRS
Bronze Plated Finish	S1R8PT3BRZ
Nickel Plated	S1R8PT3NKL

Note: xx indicates finish options.

# Fire-Rated Poke-Throughs for Concrete Floors Hubbell SystemOne Recessed Systems 6 Inch Core Hole, One-Piece Units

## One-Piece Pre-Wired 60/40 Split 6 Inch Fire-Rated Poke-Through for Data AV

Assembled unit includes:

- (1) Hubbell SystemOne 6 inch floor fitting (S1R6PTFIT)
- (2) Decorator opening sub-plate (S1R6SPW)
- (2) 20A, pre-wired receptacle with 18 inch wire leads (S1R6SPZ)
- (1) 6 inch flange and universal cover assembly (S1R6CVRxx)

Receptacles feature single circuit wiring.

Finish

- Brushed Aluminum
- Black Powder Coat
- Brass Plated
- Bronze Plated Finish
- Nickel Plated

Catalog Number

- S1R6PTWZALU**
- S1R6PTWZBLK**
- S1R6PTWZBRS**
- S1R6PTWZBRZ**
- S1R6PTWZNKL**

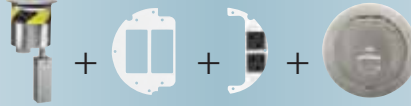

## One-Piece Pre-Wired 50/50 Split 6 Inch Fire-Rated Poke-Through for Data AV

Assembled unit includes:

- (1) Hubbell SystemOne 6 inch floor fitting (S1R6PTFIT)
- (4) 1 Unit Hubbell iSTATION openings (S1R6SPD)
- (1) Decorator opening and (2) keystone openings (S1R6SPE)
- (4) 20A pre-wired receptacles (S1R6SPH)
- (1) 6 inch flange and universal cover assembly (S1R6CVRxx)

Opening architecture Keystone openings accept Hubbell modular jacks and many others.

Receptacles feature single or two circuit wiring and isolated ground capability.

Finish

- Brushed Aluminum
- Black Powder Coat
- Brass Plated
- Bronze Plated Finish
- Nickel Plated

Catalog Number

- S1R6PTDEHALU**
- S1R6PTDEHBLK**
- S1R6PTDEHBRS**
- S1R6PTDEHBRZ**
- S1R6PTDEHNKL**



## One-Piece Pre-Wired 50/50 Split 6 Inch Fire-Rated Poke-Through for Third Party Devices

Assembled unit includes:

- (1) Hubbell SystemOne 6 inch floor fitting (S1R6PTFIT)
- (3) Extron® AAP openings (S1R6SPA)
- (5) Extron® MAPP openings (S1R6SPC)
- (1) Decorator opening and (2) Hubbell keystone openings (S1R6SPE)
- (4) 20A pre-wired receptacles (S1R6SPH)
- (1) 6 inch flange and universal cover assembly (S1R6CVRxx)

Opening architecture Keystone openings accept Hubbell modular jacks and many others.

Receptacles feature single or two circuit wiring and isolated ground capability.

Finish

- Brushed Aluminum
- Black Powder Coat
- Brass Plated
- Bronze Plated Finish
- Nickel Plated

Catalog Number

- S1R6PTACEHALU**
- S1R6PTACEHBLK**
- S1R6PTACEHBRS**
- S1R6PTACEHBRZ**
- S1R6PTACEGNKL**

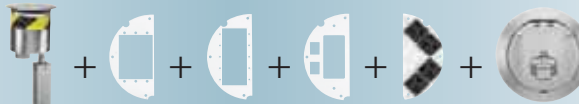

## One-Piece 6 Inch Fire-Rated Poke-Through with Finished Cover

Assembled unit includes:

- (1) Hubbell SystemOne 6 inch floor fitting (S1R6PTFIT)
- (1) 6 inch flange and universal cover assembly (S1R6CVRxx)

Finish

- Brushed Aluminum
- Black Powder Coat
- Brass Plated
- Bronze Plated Finish
- Nickel Plated

Catalog Number

- S1R6PTALU**
- S1R6PTBLK**
- S1R6PTBRS**
- S1R6PTBRZ**
- S1R6PTNKL**



## One-Piece 6 Inch Fire-Rated Poke-Through for Furniture Feed Applications

Assembled unit includes:

- (1) Hubbell SystemOne 6 inch floor fitting (S1R6PTFIT)
- (1) 6 inch furniture feed flange and cover assembly (S1R6FFCVRxx)
- (1) 2 inch conduit fitting (S1R6FFIT2)
- (1) ¼ inch conduit fitting (S1R6FFIT075)

Finish

- Brushed Aluminum
- Black Powder Coat
- Brass Plated
- Bronze Plated Finish
- Nickel Plated

Catalog Number

- S1R6PTFFALU**
- S1R6PTFFBLK**
- S1R6PTFFBRS**
- S1R6PTFFBRZ**
- S1R6PTFFNKL**

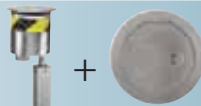

Note: xx indicates finish options.

Extron® is a registered trademark of Extron Electronics.

# Fire-Rated Poke-Throughs for Concrete Floors Hubbell SystemOne Flush Systems 4 Inch Core Hole



## 4 Inch Core Through Floor Fittings



- Step down installation clips allow the fitting to be installed or removed from the floor above
- Fire barrier expands during fire conditions to maintain the floor's fire rating
- Adjustable lower fire barrier accommodates concrete floor thicknesses from 2¼ to 7 in.
- Oversized EMT conduit tubes for increased cable capacity

## Features



- Accepts all Hubbell SystemOne covers and sub-plates
- Excellent solution for retrofit and new construction
- Delivers power, voice, data and multimedia
- UL listed for use in 1 – 4 hour fire rated floors at 100% rated fill
- Available with integral power junction box
- SystemOne Fire-Rated Poke-Throughs are approved for use in the City of Chicago
- UL installation spacing - minimum 2 feet on center, not more than one per 65 square feet of floor area in each span

## Universal Flange and Cover Assembly

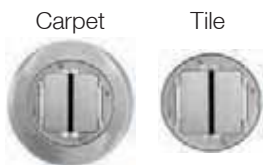

- Hinged doors open 180 degrees flush to the carpet flange or tile
- Locking studs allow each door to be secured independently
- The universal carpet or tile flange can be used for Hubbell SystemOne Fire-Rated Poke-Throughs and Floor Boxes
- Finishes and colors available:

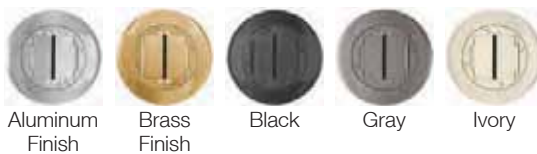

## Features

- Durable cast aluminum construction available in black, gray, brass, aluminum and ivory powder coat finishes
- Features ScrubShield® technology that exceeds UL514A scrub water exclusion requirements
- Provides consistent look and maximum functionality throughout the installed life
- Meets ADA standards for accessible design, section 4.3.8

## Hubbell SystemOne Sub-Plates

Hubbell's modular sub-plate design allows users to economically upgrade Hubbell SystemOne FRPT and Floor Boxes to accommodate future moves, additions and changes. See page P-15 for additional information.



4x4 Sub-Plate



Datacom and Power Sub-Plate



Extron® APP/MAPP and Power Sub-Plate



Dual Style Line® Decorator Sub-Plate



Twist-Lock® Sub-Plate



Furniture Feed Cover, Carpet

## Features

- Durable cast aluminum construction, powder coat finish
- Hubbell 4X4: four 20A, 125V receptacles, four keystone openings for voice/data jacks and flush multimedia connectors
- Hubbell X-END and Hubbell iSTATION modular connectivity
- Accommodates Extron® Electronics Architectural Series audio/video system integration products
- Accommodates GFCI, surge and standard Style Line® Decorator receptacles
- Twist-Lock® receptacle with two flush keystone openings
- Large capacity and multi-service furniture feed applications
- Open system sub-plates permit maximum data flexibility

Extron® is a registered trademark of Extron Electronics. Siemon™ is a trademark of The Siemon Company. Panduit® is a registered trademark of Panduit Corp. SYSTIMAX® is a registered trademark of CommScope, Inc. Ortronics® is a registered trademark of Ortronics/Legrand.









# Fire-Rated Poke-Throughs for Concrete Floors Hubbell SystemOne Flush Systems 4 Inch Core Hole, One-Piece Units



## Hubbell SystemOne 4 Inch Core Hole, One-Piece Units

All Hubbell SystemOne 4 Inch core, one-piece units include the sub-plate and cover to simplify your order and reduce installation time. Units are also available with a power junction box installed. The junction box is also available for purchase separately.



Description	Color	Catalog Number without Junction Box	Catalog Number with Junction Box*
<p><b>One-Piece 4X4 Poke-Through</b></p> <p>Assembled-unit includes:</p> <ul style="list-style-type: none"> <li>Hubbell SystemOne 4X4 floor fitting (S1PT4X4FIT)</li> <li>4x4 sub-plate (S1SP4X4)</li> <li>Finish flange and universal carpet cover assembly (S1CFCxx)</li> <li>4-hour fire classification</li> </ul> <p>Keystone openings accept Hubbell modular jacks, X-END connectors and flush multimedia snap fit connectors. Receptacles feature single or two circuit wiring and isolated ground capability.</p>	<p>Aluminum Finish Brass Finish Black/Brass Finish Black Gray</p> 	<p>S1PT4X4AL S1PT4X4BRS S1PT4X4BRS3 S1PT4X4BL S1PT4X4GY</p>	<p>S1PT4X4ALJ S1PT4X4BRSJ S1PT4X4BRS3J S1PT4X4BLJ S1PT4X4GYJ</p> 
<p><b>One-Piece Dual Style Line® Decorator Poke-Through</b></p> <p>Assembled-unit includes:</p> <ul style="list-style-type: none"> <li>Hubbell SystemOne dual channel floor fitting (S1PTFIT)</li> <li>Dual Style Line® decorator opening sub-plate (S1SP)</li> <li>Finish flange and universal carpet cover assembly (S1CFCxx)</li> <li>4-hour fire classification</li> </ul> <p>Style Line® decorator openings accept two Style Line® decorators or one surge or GFCI receptacle and one Style Line® decorator receptacle. Outlet frames can be used to convert the application to a 6-port multi-service or a 12-port all communication solution. Fitting is 4-hr rated at 100% fill to accommodate (12) Cat. 6A cables (0.330" diameter).</p>	<p>Aluminum Finish Brass Finish Black Gray</p> 	<p>S1PTAL S1PTBRS S1PTBL S1PTGY</p>	<p>S1PTALJ S1PTBRSJ S1PTBLJ S1PTGYJ</p> 
<p><b>One-Piece Modular AV Poke-Through</b></p> <p>Assembled-unit includes:</p> <ul style="list-style-type: none"> <li>Hubbell SystemOne AV floor fitting (S1PTAVFIT)</li> <li>20A, 125V power and 3-unit Hubbell iSTATION sub-plate (S1SP3IM)</li> <li>Finish flange and universal carpet cover assembly (S1CFCxx)</li> <li>4-hour fire classification</li> </ul> <p>The Hubbell iSTATION's recessed opening can accommodate data/voice/audio and video solutions including 15-pin VGA, RCA, S-Video, 3.5mm stereo, X-END, HDMI and XLR microphone jacks.</p>	<p>Aluminum Finish Brass Finish Black Gray</p> 	<p>S1PT3IMAL S1PT3IMBRS S1PT3IMBL S1PT3IMGY</p>	<p>S1PT3IMALJ S1PT3IMBRSJ S1PT3IMBLJ S1PT3IMGYJ</p> 
<p><b>One-Piece Furniture Feed Poke-Through</b></p> <p>Assembled-unit includes:</p> <ul style="list-style-type: none"> <li>Hubbell SystemOne AV floor fitting (S1PTAVFIT)</li> <li>Hubbell SystemOne furniture feed cover plate (S1SPFFxx)</li> <li>4-hour fire classification</li> </ul> <p>This solution provides one ¾ in. conduit for power and one 1½ in. conduit for low-voltage. Furnished with two screw-in flexible metal conduit connectors.</p>	<p>Aluminum Finish Brass Finish Black Gray</p> 	<p>S1PTFFAL S1PTFFBRS S1PTFFBL S1PTFFGY</p>	<p>S1PTFFALJ S1PTFFBRSJ S1PTFFBLJ S1PTFFGYJ</p> 

Note: \*Junction box factory installed on through floor fitting. See pages P-24 and P-25 for technical information.

**Hubbell SystemOne 4 Inch Core, Three-Piece Units**



**Description**

**4X4 Through Floor Fitting**

Through floor fitting with two 3/4 in. EMT for communications and one 3/4 in. EMT for power. For use with Hubbell SystemOne universal covers and S1SP4X4 and S1SPTL series sub-plates only. Universal cover and sub-plate ordered separately. 4-hour fire classification.

Catalog Number  
without Junction Box

**S1PT4X4FIT**

Catalog Number  
with Junction Box\*

**S1PT4X4FITJ**



**Dual Channel Through Floor Fitting**

Through floor fitting with two 1 in. EMT conduit stems to feed power and/or communication services. For use with Hubbell SystemOne universal covers and all Hubbell sub-plates except S1SP4X4 and S1SPTL series. Universal cover and sub-plate ordered separately. 4-hour fire classification.

**S1PTFIT**

**S1PTFITJ**



**AV Through Floor Fitting**

Through floor fitting with one 3/4 in. EMT conduit stem for power and one 1 1/2 in. EMT conduit stem for communication services. Ideal for demanding, high capacity audio/video and data requirements. For use with Hubbell SystemOne universal covers and all Hubbell sub-plates except S1SP4X4 and S1SPTL series. Universal cover and sub-plate ordered separately. 4-hour fire classification.

**S1PTAVFIT**

**S1PTAVFITJ**

*Note: \*Junction box factory installed on through floor fitting. See pages P-24 and P-25 for technical information.*

**Hubbell SystemOne Universal Cover**



- Cast aluminum construction
- Durable powder coat finish



Color	Carpet	Tile
Aluminum Finish	<b>S1CFCAL</b>	<b>S1TFCAL</b>
Brass Finish	<b>S1CFCBRS</b>	<b>S1TFCBRS</b>
Black	<b>S1CFCBL</b>	<b>S1TFCBL</b>
Gray	<b>S1CFCGY</b>	<b>S1TFCGY</b>
Ivory	<b>S1CFCI</b>	<b>S1TFCI</b>























**Poke Through Accessories**

Description	Catalog Number
<b>Abandonment Plates</b> Used to cover abandoned SystemOne Fire-Rated Poke-Throughs or Floor Boxes.	 Black Gray <b>S1AP4BL</b> <b>S1AP4GY</b>
<b>Fire-Rated Closure Plug</b> Used to seal a 4 Inch core hole when the FRPT is no longer required and the through-floor fitting is removed. Maintains the floor's 1-4 hour fire rating.	 Black Gray <b>S1FRP4BL</b> <b>S1FRP4GY</b>
<b>Power Junction Box</b> For use with SystemOne Fire-Rated Poke-Throughs. Provides 27.0 cubic inches. (1) 3/4 and (1) 1" EMT connector supplied. Trade size knockouts: Top (1) 1 inch Bottom (1) 3/4 inch Sides (2) 1/2 inch (1) 3/4 inch	 <b>S1FRPTJB</b>





# Fire-Rated Poke-Throughs for Concrete Floors Hubbell SystemOne Flush Systems Sub-Plates



Description	Catalog Number	Description	Catalog Number	Description	Catalog Number
<b>Style Line® Decorator/GFCI</b> (2) Style Line® decorator openings for power and/or datacom applications.	 S1SP	<b>Duplex/Duplex</b> (2) Duplex openings for power and/or datacom applications.	 S1SPDU	<b>Duplex/Style Line® Decorator</b> (1) Duplex and (1) Style Line® decorator opening for power and/or datacom applications.	 S1SPDUSL
<b>Hubbell 4 X 4</b> (4) 20A, 125V receptacles. (4) Keystone openings for Hubbell jacks or flush AV connectors. Power can be wired as single or two circuit with isolated ground capability. 24" wire leads.	 S1SP4X4	<b>Carpet Furniture Feed Cover/Flange*</b> (1) ¾" and (1) 1½" NPT access holes for power and/or datacom applications. Universal cover not required. Includes carpet flange.		<b>Tile Furniture Feed Cover/Flange*</b> (1) ¾" and (1) 1½" NPT access holes for power and/or datacom applications. Universal cover not required. Includes tile flange.	
Provided with 15 ft. wire leads Provided with 30 ft. wire leads	S1SP4X415 S1SP4X430	Aluminum Fin. Brass Fin. Black Gray	S1SPFFAL S1SPFFBRS S1SPFFBL S1SPFFGY	Aluminum Fin. Brass Fin. Black Gray	S1SPFFTL S1SPFFTBRS S1SPFFTBL S1SPFFTGY
<b>Single Receptacle + Data</b> Opening for 20 or 30A Twist-Lock® receptacle (1.56" OD) and (2) Keystone openings for Hubbell jacks or flush AV connectors.	 S1SPTL	<b>Hubbell DataCom + Power</b> (1) 20A, 125V receptacle and 3-unit recessed Hubbell iSTATION opening for data, voice, and AV applications.	 S1SP3IM	<b>Hubbell DataCom + Duplex</b> (1) Duplex opening, (2) flush Keystone openings and 1.5 unit recessed Hubbell iSTATION opening for data, voice and AV applications.	 S1SPDU2IM
<b>Hubbell DataCom + Style Line® Decorator</b> (1) Style Line® decorator opening, (2) flush Keystone openings and 1.5 unit recessed Hubbell iSTATION opening for data, voice and AV applications.	 S1SPSL2IM	<b>Hubbell DataCom</b> 1 unit flush Hubbell iSTATION opening and 3-unit recessed Hubbell iSTATION opening for data, voice, and AV applications.	 S1SP4IM	<b>Active Multimedia + Power</b> Single 20A, 125V receptacle; (2) flush Keystone openings; (1) rectangular Style Line® decorator opening to accommodate active multimedia modules or low voltage outlet frames.	 S1SPAMM20
<b>Extron® or FSR + Power</b> (1) 20A, 125V receptacle. Recessed opening for (3) single Extron® MAAP series adapter plates or FSR IPS plates.	 S1SPEXT1	<b>Extron® or FSR + Power</b> (1) 20A, 125V receptacle. Recessed opening for (1) single Extron® MAAP and (2) single AAP series adapter plates or FSR IPS plates.	 S1SPEXT2	<b>Extron® or FSR Single-Service</b> Recessed opening for (2) single Extron® MAAP and (2) single AAP series adapter plates or FSR IPS plates.	 S1SPEXT3
<b>Extron® AAP + Power</b> (1) 20A, 125V receptacle. (2) flush Keystone and recessed opening for (2) single Extron® AAP Series adapter plates.	 S1SPEXT4	<b>Ortronics Series II® + Power</b> (1) 20A, 125V receptacle. Recessed opening for (3) 1 unit Ortronics Series II® modules.	 S1SPORT	<b>Ortronics TracJack® + Power</b> (1) 20A, 125V receptacle. Recessed bezel for (6) Ortronics TracJack® modules.	 S1SPTRAC
<b>Panduit Mini Com® 4 X 4</b> (4) 20A, 125V receptacles. (4) Openings for Panduit Mini-Com Connectivity.	 S1SP4X4PA	<b>SYSTIMAX® 4 X 4</b> (4) 20A, 125V receptacles. (4) Openings for SYSTIMAX® Connectivity.	 S1SP4X4SYS	<b>Siemon MAX® + Power</b> (1) 20A, 125V receptacle. Recessed bezel for (6) Siemon MAX® modules.	 S1SPMAX

Note: \*Furnished with two screw-in flexible metal conduit connectors. See Network Wiring section for complete offering of Hubbell jacks and frames.  
See page P-16 for FRPT Configuration Chart.  
See section W for datacom accessories.

## Sub-Plate Accessories

Description	Description	Catalog Number
<b>Replacement Threaded Conduit Plugs</b> Used with S1SPFFx and S1SPFFTx only. Sub-plate is supplied with plugs.	 	
Color	1½" Plug	¾" Plug
Aluminum Finish	S1FP15AL	S1FP34AL
Brass Finish	S1FP15BRS	S1FP34BRS
Black	S1FP15BL	S1FP34BL
Gray	S1FP15GY	S1FP34GY
	<b>6-Port Replacement Data Frames</b> Used with open systems sub-plates. Sub-plate is supplied with data frame. Siemon MAX® for use with S1SPMAX sub-plate. Ortronics TracJack® for use with S1SPTRAC sub-plate.	 S1DFMAX  S1DFTRAC
	Black Style Line® decorator blank frame.	 2100BK

Extron® is a registered trademark of Extron Electronics. MAX® is a registered trademark of The Siemon Company. Mini-Com® and Panduit® are registered trademarks of Panduit Corp. SYSTIMAX® is a registered trademark of CommScope, Inc. TracJack®, Series II® & Ortronics® are registered trademarks of Ortronics/Legrand.

# Fire-Rated Poke-Throughs for Concrete Floors Hubbell SystemOne Flush Systems Configuration Chart

Approved for use in the City of Chicago. (except S1PFB)			Floor Boxes*				4" Core Hole Fire-Rated Poke-Throughs		
			Non-Metallic	Metal					
Sub-Plates									
S1SP	Style Line® Decorator/GFCI						✓+	✗	✓
S1SPDU	Duplex/Duplex						✓+	✗	✓
S1SPDUSL	Duplex/Style Line® Decorator						✓+	✗	✓
S1SP4X4 S1SP4X4PA S1SP4X4SYS	Hubbell 4 X 4 Panduit Mini-Com® 4 X 4 SYSTIMAX® 4 X 4						✗	✓+	✗
S1SPTL	Twist-Lock® Receptacle + Data						✗	✓+	✗
S1SP3IM	Hubbell DataCom + Power						✓	✗	✓+
S1SP4IM	Hubbell DataCom						✓	✗	✓+
S1SPDU2IM	Hubbell DataCom + Duplex						✓	✗	✓+
S1SPSL2IM	Hubbell DataCom + Style Line® Decorator						✓	✗	✓+
S1SPFFxx (Carpet) S1SPFFTxx (Tile)	Furniture Feed Cover/Flange (Replace "x" with BRS (brass finish), AL (aluminum finish), BL (black) or GY (gray).						✓	✗	✓+
S1SPEXT1	Extron® or FSR + Power						✓	✗	✓+
S1SPEXT2	Extron® or FSR + Power						✓	✗	✓+
S1SPEXT3	Extron® or FSR Single-Service						✓	✗	✓+
S1SPEXT4	Extron® or FSR + Power						✓	✗	✓+
S1SPORT	Ortronics Series II® + Power						✓	✗	✓+
S1SPTRAC	Ortronics TracJack® + Power						✓	✗	✓+
S1SPMAX	Siemon MAX® + Power						✓	✗	✓+
S1SPAMM20	Active Multimedia + Flush Keystone + Power						✓	✗	✓+
S1FCxx SystemOne Carpet Cover S1TFCxx SystemOne Tile Cover	SystemOne Floor Boxes and FRPTs use SystemOne Universal Covers (Replace "x" with BRS (brass finish), AL (aluminum finish), BL (black), GY (gray) or I (ivory).	 	 Signifies minimum depth of concrete pour in inches for Hubbell SystemOne Floor Boxes.				 Recommended Floor Fitting	 Alternative Floor Fitting	 Not Compatible
<p>Note: *See section O for additional information on Floor Boxes.</p> <p>Extron® is a registered trademark of Extron Electronics. MAX® is a registered trademark of The Siemon Company. Mini-Com® and Panduit® are registered trademarks of Panduit Corp. SYSTIMAX® is a registered trademark of CommScope, Inc. TracJack®, Series II® and Ortronics® are registered trademarks of Ortronics/Legrand.</p>									



# Fire-Rated Poke-Throughs for Concrete Floors

## 2X2 Flush FRPT

### 3 Inch Core Hole Units

#### 2X2 Flush FRPT, One-Piece Units (PT2X2FIT)

Description	Color	Catalog Number	Description	Color/Material	Catalog Number
2X2 Poke-Through Non-metallic Cover	Black Gray Black Gray	<b>PT2X2BL</b> <b>PT2X2GY</b> <b>PT2X2IGBL*</b> <b>PT2X2IGGY*</b>	2X2 Poke-Through	Black/Brass Brass Finish/Brass Black/Brass Brass Finish/Brass	<b>PT2X2BRS3</b> <b>PT2X2BRS</b> <b>PT2X2IGBRS3*</b> <b>PT2X2IGBRS*</b>

- Pre-wired 20A Style Line® decorator receptacle and (2) Category 5e data jacks
- Painted aluminum flange
- Approved for use in the City of Chicago



- Pre-wired 20A Style Line® decorator receptacle and (2) Category 5e data jacks
- Solid brass flange
- Approved for use in the City of Chicago



Note: \*Includes pre-wired 20A isolated ground duplex Style Line® receptacle.

#### 2X2 Flush FRPT, Two-Piece Units

Description	Catalog Number
Multi-Channel Through-Floor Fitting with (1) ¼ in. EMT stem with junction box for power and (2) ½ in. EMT stems for low voltage.	<b>PT2X2FIT</b>



Specifications:

- 1 – 4 hour fire rating (1 – 3 hour for steel floor units and concrete topping, D900 Series Design)
- For 2¼ in. to 7 in. floor thickness
- UL installation spacing – minimum 2 ft. on center and not more than one per 65 sq. ft. of floor area
- Approved for use in the City of Chicago

#### Service Fittings

Description	Color	Catalog Number	Description	Color/Material	Catalog Number
2X2 Service Fitting Non-metallic Cover/ Aluminum Flange	Black Gray	<b>PT2X2SFBL</b> <b>PT2X2SFGY</b>	2X2 Service Fitting Non-metallic Cover Brass Flange	Black/Brass Brass Finish/Brass	<b>PT2X2SFBR3</b> <b>PT2X2SFBR5</b>

- Pre-wired 20A Style Line® decorator receptacle and (2) Category 5e data jacks
- Painted aluminum flange



- Pre-wired 20A Style Line® decorator receptacle and (2) Category 5e data jacks
- Solid brass flange



#### Accessories

Description	Color/Material	Catalog Number	Description	Color/Material	Catalog Number
Non-metallic Replacement Covers	Brass Finish Black Gray	<b>PT2X2CBRS</b> <b>PT2X2CBL</b> <b>PT2X2CGY</b>	<b>Closure Plug</b> Textured aluminum plug seals 3 in. core hole when FRPT is no longer required and is removed. Maintains the floor's 1 – 4 hour fire rating. UL Listed and CSA Certified.	Gray	<b>FRP250</b>





Note: See page P-27 for technical information.

# Fire-Rated Poke-Throughs for Concrete Floors

## Flush Duplex FRPT

### 3 Inch Core Hole Units

#### Flush Duplex FRPT, One-Piece Units



Description	Color	Catalog Number	Description	Color/Material	Catalog Number
Flush Poke-Through	Black Brown Gray Ivory Gray Ivory	<b>PT7FSDBLA</b> <b>PT7FSDBRA</b> <b>PT7FSDGYA</b> <b>PT7FSDIA</b> <b>PT7IGFSDGYA*</b> <b>PT7IGFSDIA*</b>	Flush Brass Poke-Through	All Brass Black/Brass All Brass	<b>PT7FSDBRS2A</b> <b>PT7FSDBRS3A</b> <b>PT7IGFSDBRSA*</b>
Complete assembled unit includes:			Complete assembled unit includes:		
<ul style="list-style-type: none"> <li>• Pre-wired 20A duplex receptacle</li> <li>• Non-metallic flip lid cover with (2) ½ in. diameter low voltage feed-through holes</li> <li>• Painted aluminum flange</li> </ul>			<ul style="list-style-type: none"> <li>• Pre-wired 20A duplex receptacle</li> <li>• All brass or black non-metallic cover option</li> <li>• Flip lid cover with (2) ½ in. diameter low voltage feed-through holes</li> <li>• Solid brass flange</li> </ul>		

Note: \*Includes pre-wired 20A isolated ground duplex receptacle.



#### Flush FRPT, Two-Piece Units

Description	Catalog Number
Multi-Channel Through-Floor Fitting with (1) ¼ in. EMT stem for power and (2) ½ in. low voltage feed-through holes.	<b>PT7FSD</b> (with Junction Box) <b>PT73SD</b> (without Junction Box)
	Specifications:
	<ul style="list-style-type: none"> <li>• 1 – 4 hour fire rating (1 – 3 hour for steel floor units and concrete topping, D900 Series Design)</li> <li>• For 2¼ in. to 7 in. floor thickness</li> <li>• UL installation spacing – minimum 2 ft. on center and not more than one per 65 sq. ft. of floor area</li> </ul>

#### Service Fittings

Description	Color	Catalog Number	Description	Color/Material	Catalog Number
Flush Aluminum Service Fitting	Black Brown Gray Ivory	<b>FRFBLA</b> <b>FRFBRA</b> <b>FRFGYA</b> <b>FRFIA</b>	Flush Brass Service Fitting	Solid Brass	<b>FRFBRS2A</b>
Complete assembled unit includes:			Complete assembled unit includes:		
<ul style="list-style-type: none"> <li>• Pre-wired 20A duplex receptacle</li> <li>• Non-metallic flip lid cover with (2) ½ in. diameter low voltage feed-through holes</li> <li>• Painted aluminum flange</li> </ul>			<ul style="list-style-type: none"> <li>• Pre-wired 20A duplex receptacle</li> <li>• Solid brass flip lid cover with (2) ½ in. diameter low voltage feed-through holes</li> <li>• Solid brass flange</li> </ul>		

#### Accessories

Description	Color	Catalog Number	Description	Color/Material	Catalog Number
Non-metallic Replacement Covers	Black Brown Gray Ivory	<b>PFBRCBLA</b> <b>PFBRCBRA</b> <b>PFBRCGYA</b> <b>PFBRCIA</b>	All Brass Replacement Covers	Solid Brass	<b>BRS2RCA</b>
					

Note: See page P-21 for 3 Inch FRPT accessories.  
See page P-27 for technical information.

# Fire-Rated Poke-Throughs for Concrete Floors Flush Furniture Feed FRPT 3 Inch Core Hole Units

## Large Capacity, Single-Service Flush Furniture Feed FRPT, Two-Piece Units

Description	Catalog Number	Description	Color/Material	Catalog Number
Large Capacity, Single-Service Through Floor Fitting with (1) 2 in. EMT stem. Will accommodate up to 36 Category 5e cables. Specifications: <ul style="list-style-type: none"> <li>• 1- to 2-hour fire rating</li> <li>• Single-Service, Power or Data</li> <li>• For 2¼ to 7 in. floor thickness</li> <li>• UL installation spacing – minimum 2 ft. on center and not more than 1 per 65 sq. ft. of floor area</li> <li>• Approved for use in the City of Chicago</li> </ul>	<b>PT2FIT</b>	Large Capacity Cover/Flange  Specifications: <ul style="list-style-type: none"> <li>• Cover/flange with 1¼ in. and 2 in. trade size combination knockout</li> <li>• Painted aluminum cover and flange</li> <li>• Approved for use in the City of Chicago</li> </ul>	Brass Finish Black Gray	<b>FF2BRS</b> <b>FF2BK</b> <b>FF2GY</b>



Note: \*Includes pre-wired 20A Isolated ground duplex Style Line® receptacle.  
See page P-28 for technical information.

## Flush Furniture Feed FRPT, One-Piece Units

Description	Color	Catalog Number	Description	Color	Catalog Number
3-Service Furniture Feed Poke-Through  Complete assembled unit includes: <ul style="list-style-type: none"> <li>• PT73SD floor fitting</li> <li>• Aluminum cover with (2) ½ in. threaded hubs for low voltage and (1) ¾ in. threaded hub for power</li> <li>• Painted aluminum flange</li> </ul>	Black Gray Ivory	<b>PT73FFSDBK</b> <b>PT73FFSDGY</b> <b>PT73FFSDI</b>	Single-Service Furniture Feed Poke-Through  Complete assembled unit includes: <ul style="list-style-type: none"> <li>• PT71SD floor fitting</li> <li>• Aluminum cover with (1) KO to accept a ¾ in. connector</li> <li>• Painted aluminum flange</li> </ul>	Gray Ivory	<b>PT7FFSDGY</b> <b>PT7FFSDI</b>



Note: See page P-28 for technical information.

## Flush Furniture Feed FRPT, Two-Piece Units

Description	Catalog Number	Description	Catalog Number
3-Service Furniture Feed Through-Floor Fitting with (1) ¾ in. EMT stem for power and (2) ½ in. low voltage conduit holes. Specifications: <ul style="list-style-type: none"> <li>• 1 – 4 hour fire rating (1 – 3 hour for steel floor units and concrete topping, D900 Series Design)</li> </ul>	<b>PT73SD</b>	Single-Service Furniture Feed Through-Floor Fitting with (1) ¾ in. EMT stem for power or low voltage applications. Specifications: <ul style="list-style-type: none"> <li>• For 2¼ to 7 in. floor thickness</li> <li>• UL installation spacing – minimum 2 ft. on center and not more than 1 per 65 sq. ft. of floor area</li> </ul>	<b>PT71SD</b>



## Service Fittings

Description	Color	Catalog Number	Description	Color	Catalog Number
3-Service Furniture Feed Service Fitting  Complete assembled unit includes: <ul style="list-style-type: none"> <li>• Aluminum cover with (2) ½ in. threaded hubs for low voltage and (1) ¾ in. threaded hub for power</li> <li>• Painted aluminum flange</li> </ul>	Black Gray Ivory	<b>FRF3BK</b> <b>FRF3GY</b> <b>FRF3I</b>	Single-Service Furniture Feed Service Fitting  Complete assembled unit includes: <ul style="list-style-type: none"> <li>• Aluminum cover with (1) KO to accept a ¾ in. connector</li> <li>• Painted aluminum flange</li> </ul>	Brass Finish Black Gray	<b>FRF1BRS</b> <b>FRF1BK</b> <b>FRF1GY</b>



Note: See page P-21 for 3 Inch FRPT accessories.  
See page P-28 for technical information.

# Fire-Rated Poke-Throughs for Concrete Floors Painted Pedestal FRPT 2 and 3 Inch Core Hole Two-Piece Units

## 3 Inch Core Hole, Two-Piece Unit

Description	Catalog Number
Large Capacity Multi-Service Pedestal Through-Floor Fitting with (1) 1 1/4 in. EMT stem for low voltage and (1) 1/2 in. EMT stem for power applications.	<b>PT7XC</b>
Specifications:	
<ul style="list-style-type: none"> <li>• 1 – 4 hour fire rating (1 – 3 hour for steel floor units and concrete topping, D900 Series Design)</li> <li>• For 2 1/4 in. to 7 in. floor thickness</li> <li>• Approved for use in the City of Chicago</li> </ul>	



## 2 Inch Core Hole, Two-Piece Unit

Description	Catalog Number
Multi-Service Pedestal Through-Floor Fitting with (1) 1 1/4 in. EMT stem for low voltage and (1) 1/2 in. EMT stem for power applications.	<b>PT27A</b>
Specifications:	
<ul style="list-style-type: none"> <li>• 1 – 4 hour fire rating (1 – 3 hour for steel floor units and concrete topping, D900 Series Design)</li> <li>• For 2 1/4 in. to 7 in. floor thickness</li> <li>• Approved for use in the City of Chicago</li> </ul>	



Note: \*Includes pre-wired 20A isolated ground duplex receptacle.  
See page P-29 for technical information.

## Pedestal Service Fittings (Order 1 plate per gang)

Description	Color/Material	Catalog Number	Description	Color	Catalog Number	Description	Color	Catalog Number
2-Gang	Alum. Finish Black Gray	<b>FR280ALA</b> <b>FR280BKA</b> <b>FR280GYA</b>	4-Gang	Black Gray	<b>FR480BKA</b> <b>FR480GYA</b>	6-Gang	Black Gray	<b>FR680BKA</b> <b>FR680GYA</b>
Use with PT27A only.			Use with PT27A or PT7XC.			Use with PT27A or PT7XC.		
								
<b>FR280BKA</b>			<b>FR480GYA</b>			<b>FR680BKA</b>		

- Painted aluminum housing with low voltage barrier(s); plates and devices sold separately
- For additional barriers, use FRBR1, see page P-21.
- UL Listed and CSA Certified

Note: See page P-30 for technical information.

## Pedestal Face Plates (Order 1 plate per gang)

Description	Color/Material	Catalog Number	Description	Color/Material	Catalog Number
Duplex	Black Gray	<b>SS2309DBKA</b> <b>SS2309DGYA</b>	Furniture feed (3/4 in. KO)	Alum. Finish Black Gray	<b>SS2309FALA</b> <b>SS2309FBKA</b> <b>SS2309FGYA</b>
Style Line®/ GFCI	Black Gray	<b>SS2309SLBKA</b> <b>SS2309SLGYA</b>	Furniture feed (1 in. KO)	Black Gray	<b>SS2309F1BKA</b> <b>SS2309F1GYA</b>
Single receptacle (1.39 in. OD)	Black Gray	<b>SS2309SBKA</b> <b>SS2309SGYA</b>	Bushed data opening (1 in. ID)	Black Gray	<b>SS2309TBKA</b> <b>SS2309TGYA</b>
Blank	Alum. Finish Black Gray	<b>SS2309BALA</b> <b>SS2309BBKA</b> <b>SS2309BGYA</b>			

- Painted aluminum plates
- UL Listed and CSA Certified

# Fire-Rated Poke-Throughs for Concrete Floors Brushed Aluminum Pedestal FRPT 3 Inch Core Hole Two-Piece Units

## Through-Floor Fitting

Description	Catalog Number
Large Capacity Multi-Service Pedestal Through-Floor Fitting with (1) 1¼ in. EMT stem for low voltage and (1) ½ in. EMT stem for power applications.	<b>PT7XC</b>
Specifications:	
<ul style="list-style-type: none"> <li>• 1 – 4 hour fire rating (1 – 3 hour for steel floor units and concrete topping, D900 Series Design).</li> <li>• For 2¼ in. to 7 in. floor thickness.</li> <li>• Approved for use in the City of Chicago.</li> </ul>	



## Pedestal Service Fitting

Description	Color/Material	Catalog Number
2-Gang Pedestal Service Fitting For use with PT7XC only.	Brushed Aluminum	<b>FR80AL</b>
Specifications:		
<ul style="list-style-type: none"> <li>• Brushed aluminum housing with low voltage barrier. Plates and devices sold separately.</li> </ul>		



Note: See pages P-29 and P-30 for technical information.

## Plates

Description	Catalog Number	Description	Catalog Number
Duplex	<b>SS309D</b>	Furniture feed (¾ in. KO)	<b>SS309SF*</b>
Style Line®/GFCI	<b>SS309DS</b>	Furniture feed, blank	<b>SS309BF*</b>
Single receptacle (1.39 in. OD)	<b>SS309S</b>	Bushed data opening (1 in. ID)	<b>SS309T</b>
Blank	<b>SS309B</b>	<ul style="list-style-type: none"> <li>• 302/304 stainless steel plates (SS309SF &amp; SS309BF are aluminum).</li> <li>• UL Listed and CSA Certified.</li> </ul>	

Note: \*For furniture feed applications using **SS309SF**, a **SS309BF** blank must be used for second plate.

## 3 Inch Core Hole FRPT Accessories

Description	Color	Catalog Number	Description	Color/Gang	Catalog Number
<b>Flush FRPT Abandonment Plate</b> Use with PT7FSD, PT73SD or PT71SD only. Covers the opening when FRPT is abandoned. Service fitting is removed and through-floor fitting remains.	Gray Ivory	<b>AP2GY</b> <b>AP2I</b>	<b>PT7XC Extension Kit</b> Extends PT7XC FRPT to accommodate between 7 in. and 13 in. floor thickness.	—	<b>EXT13</b>
<b>Multi-Service Furniture Feed Replacement Inserts</b> Use as a replacement cover for PT73FFSD series, or to convert installed PT7FSD series into furniture feed FRPTs. Includes (2) ½ in. threaded hubs for low voltage and (1) ¾ in. threaded hub for power. (UL Listed only.)	Gray Ivory	<b>FF3GY</b> <b>FF3I</b>	<b>Pedestal FRPT Abandonment Plate</b> Use with PT27A or PT7XC only. Covers the opening when FRPT is abandoned. Service fitting is removed and through-floor fitting remains.	Gray/ 2-gang  Gray/ 4-gang	<b>AP22</b>  <b>AP42</b>
<b>Replacement Low Voltage Barrier</b> Use with FR280, FR480, and FR680 pedestal service fittings only when additional power/low voltage separation is required.		<b>FRBR1</b>			

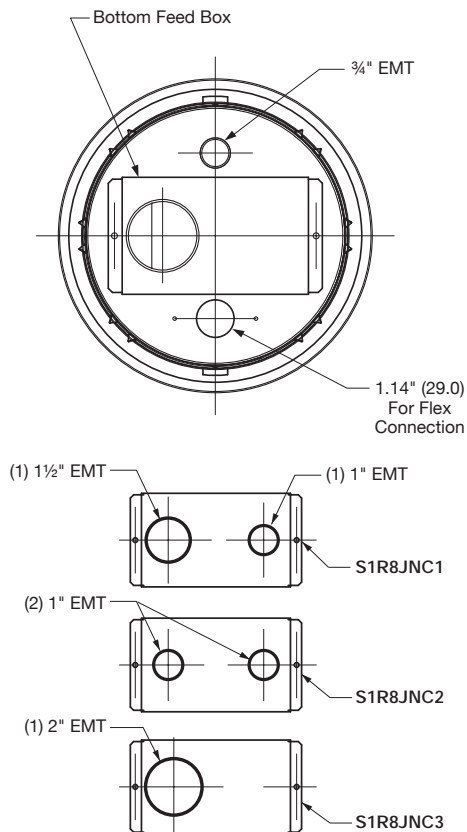
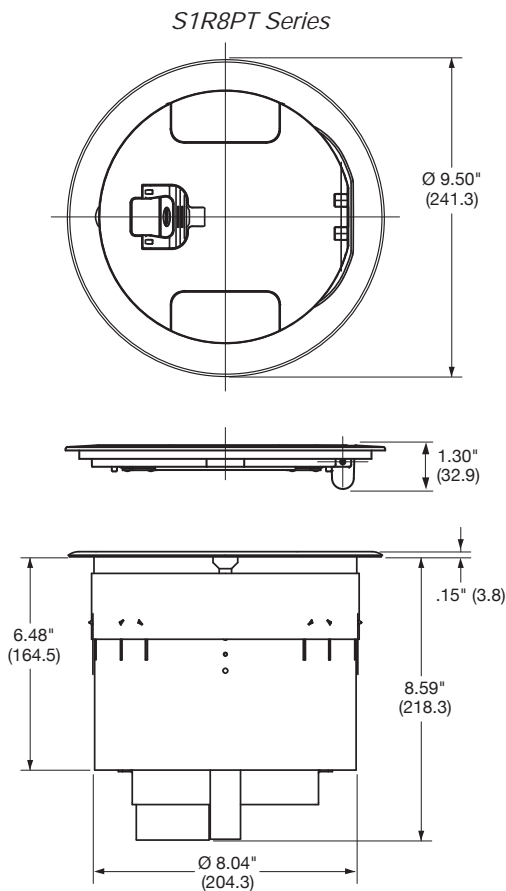

## Product Information

- Plated cast aluminum covers available in brass, nickel or bronze finishes. Additionally available in brushed aluminum or black powder coat.
- S1R8SPZ sub-plate supplied with pre-wired dual 20A receptacle. Wired with three #12 AWG solid conductors.
- Meets ADA standards for accessible design, section 4.3.8, "changes in level."
- Meets UL 514A scrub water exclusion requirements.

## Application Data

- Cover mounts to recessed 8 Inch FRPTs and LCFB series floor box with applicable adapter (LCFBS1R8ADAPT), see page O-17 for additional information.
- Mounted in 8 in. (203.2) cored concrete diameter through hole.
- Minimum floor thickness: 2 1/4 in. (57.2).
- UL Listed for fire resistance in 1 – 2 hour rated D900 series floors.
- Approved for use in the City of Chicago.

Wire Size (AWG)	Copper Cross Sectional Area for Solid or Stranded Conductors
#24	.00032 sq. in. (.206mm <sup>2</sup> )
#23	.00040 sq. in. (.258mm <sup>2</sup> )
#22	.00050 sq. in. (.322mm <sup>2</sup> )
#14	.00323 sq. in. (2.083mm <sup>2</sup> )
#12	.00512 sq. in. (3.303mm <sup>2</sup> )
#10	.00815 sq. in. (5.258mm <sup>2</sup> )
# 8	.01296 sq. in. (8.361mm <sup>2</sup> )

## UL Listed Wiring Capacity

	S1R6PT Series	
Fire Resistance Rating	2-Hrs. (D900)	
Max. Copper Cross Section	Outer Chambers (each) .0154 sq. in.	Center Chamber .0633 sq. in.

## UL Characteristics

Listing	UL File Number	ULC File Number
Outlet Box	E31999	CEYYC
Fire Resistance	R8429	R8429

For use in 1, 1 1/2 or 2 hour rated unprotected reinforced floors or in 1 or 2 hour rated floors employing steel floor units and concrete topping (D900 Series designs).

UL Spacing Restrictions - Minimum of 2 ft. on center and not more than one unit per each 65 square feet of floor area in each span.

Note: The above product data pertains to both one-piece units, three-piece units and through-floor fittings.  
 When connection conduit sweeps to through-floor fittings, ensure compliance with NEC fill tables.

Dimensions in Inches (mm)

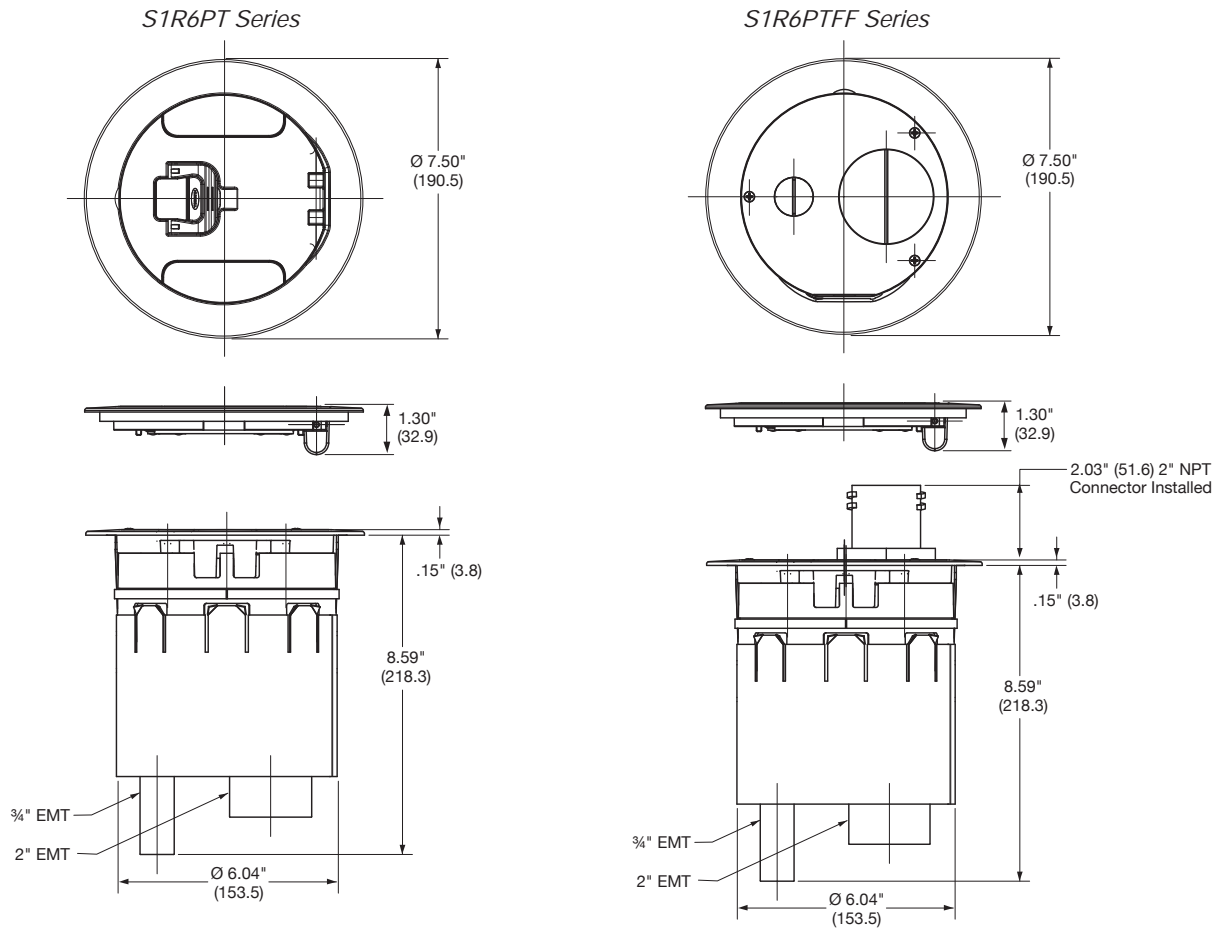

### Product Information

- Plated cast aluminum covers available in brass, nickel or bronze finishes. Additionally available in brushed aluminum or black powder coat.
- S1R6SPZ sub-plate supplied with pre-wired dual 20A receptacle. Wired with three #12 AWG solid conductors.
- S1R6SPH sub-plate supplied with pre-wired quad 20A receptacle. Wired with six #12 AWG solid conductors. Receptacle can be wired as dual circuit and isolated ground.
- S1R6PTFF series furnished with one (1) ¼ in. and one (1) 2 in. screw-in flexible metal conduit connectors.
- Meets ADA standards for accessible design, section 4.3.8, "changes in level."
- Meets UL 514A scrub water exclusion requirements.

### Application Data

- Mounted in 6 in. (152.4) cored concrete diameter through hole.
- Minimum floor thickness: 2¼ in. (57.2).
- UL Listed for fire resistance in 1 – 2 hour rated D900 series floors.
- Approved for use in the City of Chicago.

Wire Size (AWG)	Copper Cross Sectional Area for Solid or Stranded Conductors
#24	.00032 sq. in. (.206mm <sup>2</sup> )
#23	.00040 sq. in. (.258mm <sup>2</sup> )
#22	.00050 sq. in. (.322mm <sup>2</sup> )
#14	.00323 sq. in. (2.083mm <sup>2</sup> )
#12	.00512 sq. in. (3.303mm <sup>2</sup> )
#10	.00815 sq. in. (5.258mm <sup>2</sup> )
# 8	.01296 sq. in. (8.361mm <sup>2</sup> )

### UL Listed Wiring Capacity

	S1R6PT Series		S1R6PTFF Series	
Fire Resistance Rating	2-Hrs. (D900)		2-Hrs. (D900)	
Max. Copper Cross Section	¼ in. Power EMT .0307 sq. in.	2 in. Low Voltage EMT .0348 sq. in.	¼ in. Power EMT .0815 sq. in.	2 in. Low Voltage EMT .0962 sq. in.

### UL Characteristics

Listing	UL File Number	ULC File Number
Outlet Box	E31999	CEYYC
Fire Resistance	R8429	R8429

For use in 1, 1½ or 2 hour rated unprotected reinforced floors or in 1 or 2 hour rated floors employing steel floor units and concrete topping (D900 Series designs).

UL Spacing Restrictions - Minimum of 2 ft. on center and not more than one unit per each 65 square feet of floor area in each span.

Note: The above product data pertains to both one-piece units, three-piece units and through-floor fittings. When connection conduit sweeps to through-floor fittings, ensure compliance with NEC fill tables.

Dimensions in Inches (mm)

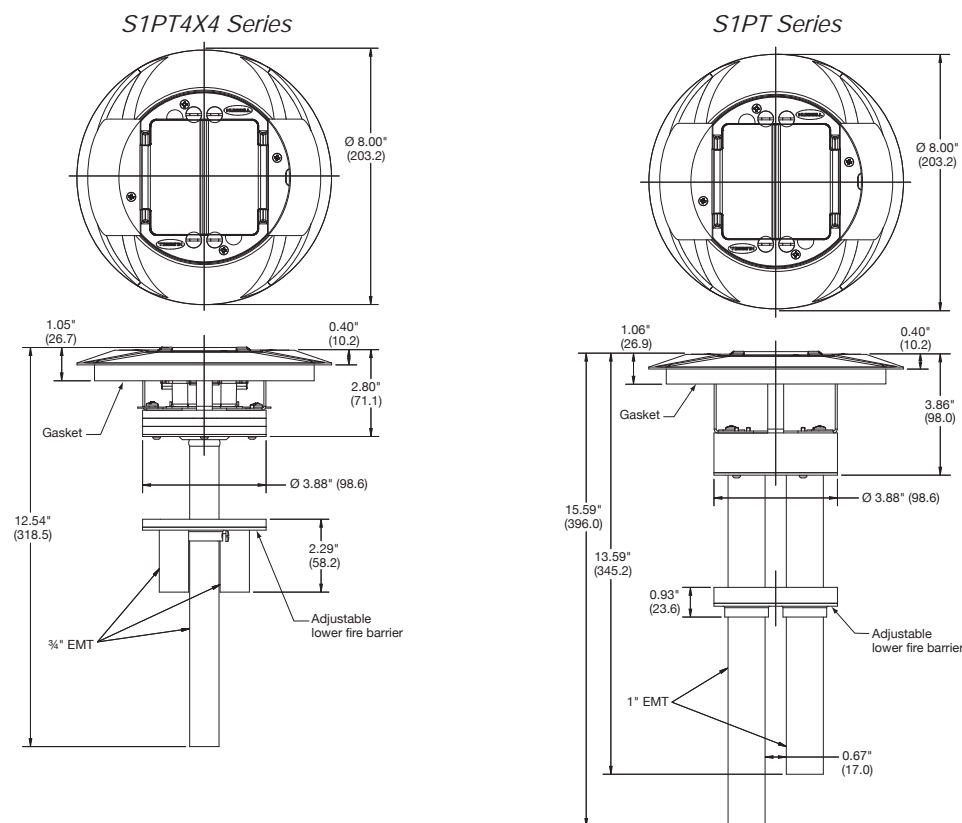

## Product Information

- Powder coat cast aluminum cover and flange (color finish options: aluminum, brass, black, gray and ivory).
- Hubbell SystemOne universal cover meets ADA standards for accessible design, section 4.3.8, "changes in level."
- S1SP4X4 sub-plate supplied with pre-wired, molded, four position 20A, 125V, black receptacle, NEMA 5-20R.
- S1SP4X4 wired with six thermally protected #14 AWG THHN stranded copper conductors, receptacle can be wired as dual-circuit and isolated ground.
- S1SP4X4 accepts four (4) Hubbell HXJ6, HXJ5E, HXJU; category 6A, 6, 5e, and USOC, and flush series jacks.
- S1SP sub-plate accepts two (2) 15A or 20A Style Line® decorator receptacles, Style Line® data frames, and/or one (1) GFCI or surge receptacle.

## Application Data

- Mounted in 4 in. (101.6) cored concrete diameter through hole.
- Minimum floor thickness: 2¼ in. (57.2).
- UL Listed for fire resistance in 1 – 4 hour rated D900 series floors.
- Approved for use in the City of Chicago.

Wire Size (AWG)	Copper Cross Sectional Area for Solid or Stranded Conductors
#24	.00032 sq. in. (.206mm <sup>2</sup> )
#23	.00040 sq. in. (.258mm <sup>2</sup> )
#22	.00050 sq. in. (.322mm <sup>2</sup> )
#14	.00323 sq. in. (2.083mm <sup>2</sup> )
#12	.00512 sq. in. (3.303mm <sup>2</sup> )
#10	.00815 sq. in. (5.258mm <sup>2</sup> )
#8	.01296 sq. in. (8.361mm <sup>2</sup> )

## UL Listed Wiring Capacity

	S1PT4X4 Series	S1PT Series
Fire Resistance Rating	4-Hrs. (D900)	4-Hrs. (D900)
Max. Copper Cross Section	¾ in. Power EMT .0307 sq. in.	1 in. Power EMT .0307 sq. in.
	¾ in. Low Voltage EMT .016 sq. in.	1 in. Low Voltage EMT .024 sq. in.

## UL Characteristics

Listing	UL File Number	ULC File Number
Outlet Box	E31999	CEYYC
Fire Resistance	R8429	R8429

For use in 1, 1½ or 2 hour rated unprotected reinforced floors or in 1 or 2 hour rated floors employing steel floor units and concrete topping (D900 Series designs).  
 UL Spacing Restrictions - Minimum of 2 ft. on center and not more than one unit per each 65 square feet of floor area in each span.

Note: The above product data pertains to both one-piece units, three-piece units and through-floor fittings.  
 When connection conduit sweeps to through-floor fittings, ensure compliance with NEC fill tables.

Dimensions in Inches (mm)



*S1PTAVFIT and S1PT3IM Series*

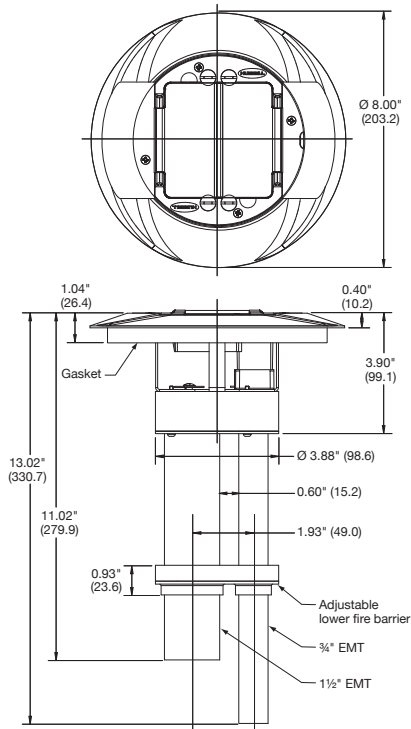

*S1PTFF Series*

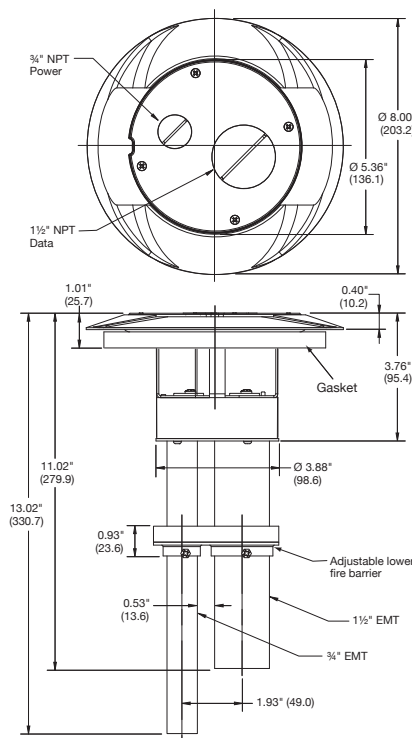

**Product Information**

- Powder coat cast aluminum cover and flange (color finish options: aluminum, brass, black, gray and ivory).
- Hubbell SystemOne universal cover meets ADA standards for accessible design, section 4.3.8, "changes in level."
- S1PTFF series aluminum conduit insert cover with one (1) 3/4 in. and one (1) 1 1/2 in. die-cast threaded plugs.
- S1PTFF series furnished with one (1) 3/4 in. and one (1) 1 1/2 in. screw-in flexible metal conduit connectors.
- S1PT3IM series sub-plate supplied with pre-wired single 20A 125V black receptacle, NEMA 5-20R.
- S1PT3IM wired with three #12 AWG THHN stranded copper conductors.
- S1PT3IM sub-plate also accepts three unit recessed Hubbell iSTATION; 15-Pin VGA, RCA, S-Video, 3.5 mm stereo and XLR microphone jacks.
- Meets UL 514A scrub water exclusion requirements.

**Application Data**

- Mounted in 4 in. (101.6) cored concrete diameter through hole.
- Minimum floor thickness: 2 1/4 in. (57.2).
- UL Listed for fire resistance in 1 – 4 hour rated D900 series floors.
- Approved for use in the City of Chicago.

Wire Size (AWG)	Copper Cross Sectional Area for Solid or Stranded Conductors
#24	.00032 sq. in. (.206mm <sup>2</sup> )
#23	.00040 sq. in. (.258mm <sup>2</sup> )
#22	.00050 sq. in. (.322mm <sup>2</sup> )
#14	.00323 sq. in. (2.083mm <sup>2</sup> )
#12	.00512 sq. in. (3.303mm <sup>2</sup> )
#10	.00815 sq. in. (5.258mm <sup>2</sup> )
# 8	.01296 sq. in. (8.361mm <sup>2</sup> )

**UL Listed Wiring Capacity**

	S1PTAVFIT and S1PT3IM Series	S1PTFF Series
Fire Resistance Rating	4-Hrs. (D900)	4-Hrs. (D900)
Max. Copper Cross Section	3/4 in. Power EMT .0307 sq. in.	3/4 in. Power EMT .072 sq. in.
	1 1/2 in. Low Voltage EMT .048 sq. in.	1 1/2 in. Low Voltage EMT .100 sq. in.

**UL Characteristics**

Listing	UL File Number	ULC File Number
Outlet Box	E31999	CEYYC
Fire Resistance	R8429	R8429

For use in 1, 1 1/2 or 2 hour rated unprotected reinforced floors or in 1 or 2 hour rated floors employing steel floor units and concrete topping (D900 Series designs).  
 UL Spacing Restrictions - Minimum of 2 ft. on center and not more than one unit per each 65 square feet of floor area in each span.

*Note: The above product data pertains to both one-piece units, three-piece units and through-floor fittings.  
 When connection conduit sweeps to through-floor fittings, ensure compliance with NEC fill tables.*

*Dimensions in Inches (mm)*

*S1CFC and S1TFC Series*

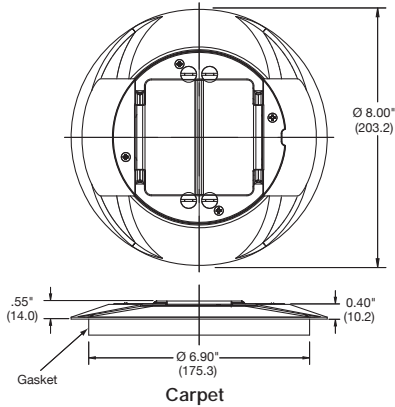

*S1SPFF and S1SPFFT Series*

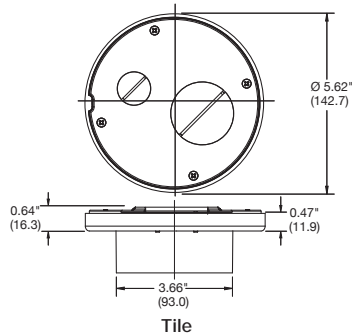
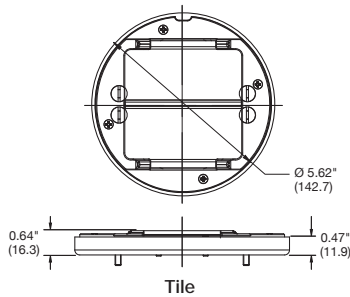
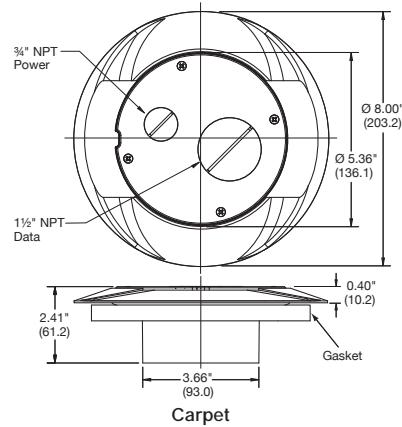

## Product Information

- Powder coat cast aluminum cover and flange (color finish options: aluminum, brass, black, gray and ivory).
- Hubbell SystemOne universal cover meets ADA standards for accessible design, section 4.3.8, "changes in level."
- S1SPFF and S1SPFFT series aluminum conduit insert cover with one (1) 3/4 in. and one (1) 1 1/2 in. die-cast threaded plugs.
- S1SPFF and S1SPFFT series furnished with one (1) 3/4 in. and one (1) 1 1/2 in. screw-in flexible metal conduit connectors.
- Meets UL 514A scrub water exclusion requirements.

Dimensions in Inches (mm)

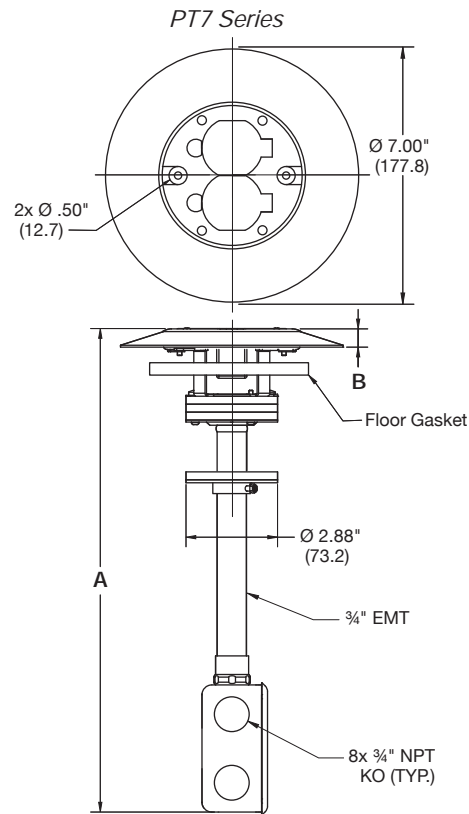
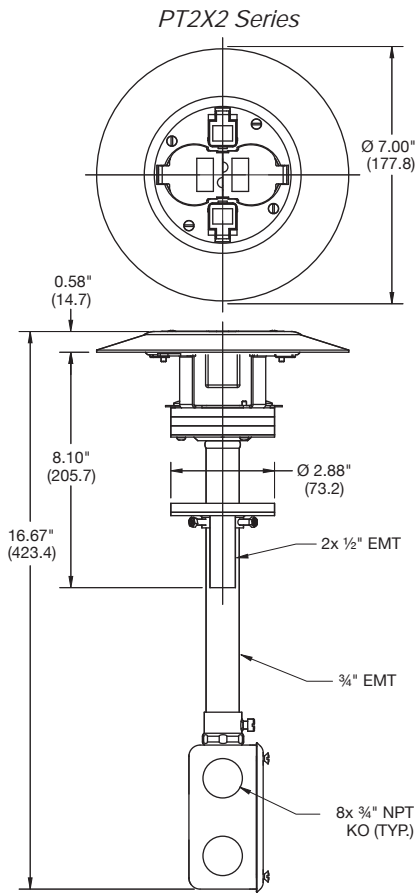

Series	Dimension A	Dimension B
Thermoplastic cover with aluminum flange.	13.24 in. [336.2]	.51 in. [13.0]
Brass cover and flange.	13.20 in. [335.2]	.49 in. [12.4]

### Product Information

- Flush thermoplastic cover with matching painted aluminum flange (black, brown, gray, ivory) or solid brass cover and flange.
- PT2X2 series supplied with Hubbell pre-wired HBL2162BK; black Styel Line® or IG2162 (isolated ground) receptacle, NEMA 5-20R, 20A, 125V.
- PT2X2 series supplied with two (2) Hubbell HXJ5EBK black jacks; category 5e, UL Listed, 110 type contacts.
- PT7 series supplied with Hubbell pre-wired HBL5352 or IG5362 (isolated ground) series receptacle, NEMA 5-20R, 20A, 125V.
- PT7 series supplied with two (2) 1/2 in. low voltage feed through holes. Two (2) feed through bushings supplied (cover will not accept data jacks).
- Wired with three (3) #12 AWG THHN stranded copper conductors.
- Supplied with 13.0 cu. in. junction box having eight (8) 3/4 in. knockouts.

### Application Data

- Mounted in 3 in. (76.2) cored concrete diameter through hole.
- Floor thickness range: 2 1/4 to 7 in. (57.2 to 177.8).
- UL Listed for fire resistance in 1 – 4 hour rated floors.
- Approved for use in the City of Chicago (PT2X2 series).

Wire Size (AWG)	Copper Cross Sectional Area for Solid or Stranded Conductors
#24	.00032 sq. in. (.206mm <sup>2</sup> )
#23	.00040 sq. in. (.258mm <sup>2</sup> )
#22	.00050 sq. in. (.322mm <sup>2</sup> )
#14	.00323 sq. in. (2.083mm <sup>2</sup> )
#12	.00512 sq. in. (3.303mm <sup>2</sup> )
#10	.00815 sq. in. (5.258mm <sup>2</sup> )
# 8	.01296 sq. in. (8.361mm <sup>2</sup> )

### UL Listed Wiring Capacity

	PT2X2 Series		PT7 Series	
Fire Resistance Rating	4-Hrs. (D900)		4-Hrs. (D900)	
Max. Copper Cross Section	3/4 in. Power EMT .0155 sq. in.	1/2 in. Data EMT .0026 sq. in.	3/4 in. Power EMT .0155 sq. in.	Low Voltage EMT .0250 sq. in.

### UL Characteristics

Listing	UL File Number	ULC File Number
Outlet Box	E31999	CEYYC
Fire Resistance	R8429	R8429

For use in 1, 1 1/2, 2, 3 or 4 hour rated unprotected reinforced floors or in 1, 2, or 3 hour rated floors employing steel floor units and concrete topping (D900 Series designs).  
 UL Spacing Restrictions - Minimum of 2 ft. on center and not more than one unit per each 65 square feet of floor area in each span.

Note: When connecting conduit sweeps to through-floor fittings, ensure compliance with NEC fill tables.  
 The above product data pertains to both one-piece units and through-floor fittings.

Dimensions in Inches (mm)

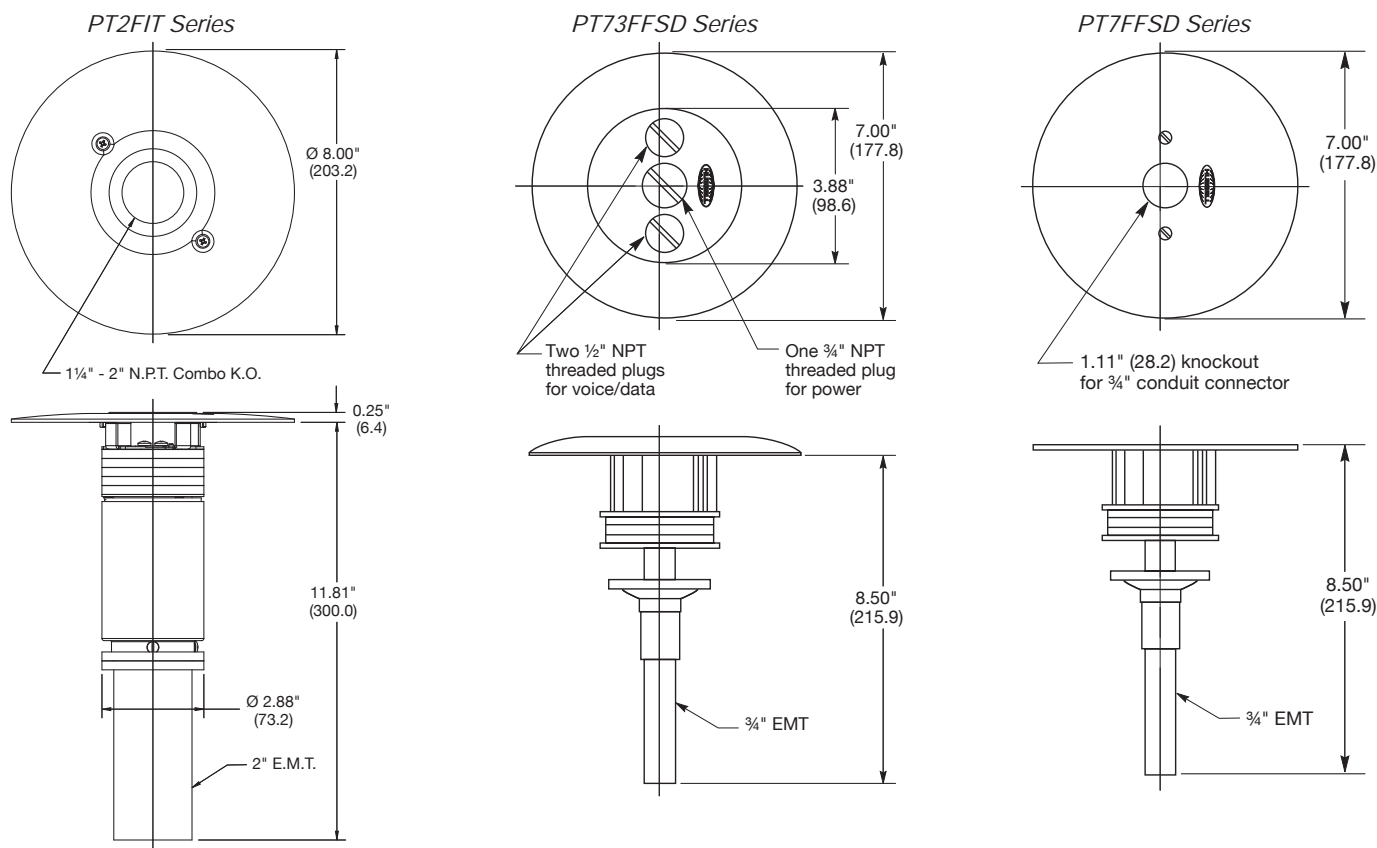

**Product Information**

**PT2FIT series**

- Flush aluminum service fitting with epoxy paint finish (gray, black and brass finish).
- Aluminum conduit cover with 2.47 in. (62.7) and 1.74 in. (44.2) combination knockouts to accept a 2 in. or 1 1/4 in. NPT flexible metal conduit connector.

**PT73FFSD series**

- Flush painted aluminum service fitting and carpet flange (color finish options: black, gray and ivory).
- Aluminum conduit insert cover with one (1) 3/4 in. and two (2) 1/2 in. die-cast threaded plugs.
- Supplied with one (1) 3/4 in. and two (2) 1/2 in. screw-in flexible metal conduit connectors.

**PT7FFSD series**

- Flush aluminum service fitting with epoxy paint finish (color finish options: gray, ivory and brass finish).
- Aluminum conduit cover with 1.11 in. (28.2) knockout to accept a 3/4 in. NPT flexible metal conduit connector.

**Application Data**

- Mounted in 3 in. (76.2) cored concrete diameter through hole.
- Floor thickness range: 2 1/4 in. to 7 in. (57.2 to 177.8).
- PT2FIT series has single-service, power or data.
- UL Listed for fire resistance in 1 – 2 hour (PT2FIT series) rated floors.
- UL Listed for fire resistance in 1 – 4 hour (PT73FFSD and PT7FFSD series) rated floors.
- Approved for use in the City of Chicago (PT2FIT series).

Wire Size (AWG)	Copper Cross Sectional Area for Solid or Stranded Conductors
#24	.00032 sq. in. (.206mm <sup>2</sup> )
#23	.00040 sq. in. (.258mm <sup>2</sup> )
#22	.00050 sq. in. (.322mm <sup>2</sup> )
#14	.00323 sq. in. (2.083mm <sup>2</sup> )
#12	.00512 sq. in. (3.303mm <sup>2</sup> )
#10	.00815 sq. in. (5.258mm <sup>2</sup> )
# 8	.01296 sq. in. (8.361mm <sup>2</sup> )

**UL Listed Wiring Capacity**

	PT2FIT Series	PT73FFSD Series	PT7FFSD Series
Fire Resistance Rating	2-Hrs. (D900)	4-Hrs. (D900)	4-Hrs. (D900)
Max. Copper Cross Section	2 in. EMT .0922 sq. in.	3/4 in. EMT .0470 sq. in.	1/2 in. Feed Through .0250 sq. in.
			3/4 in. EMT .0500 sq. in.

**UL Characteristics**

Listing	UL File Number	ULC File Number
Outlet Box	E31999	CEYYC
Fire Resistance	R8429	R8429

For use in 1, 1 1/2, or 2 hour unprotected reinforced floors or in 1 or 2 hour rated floors employing steel floor units and concrete topping (D900 Series designs).  
 UL Spacing Restrictions - Minimum of 2 ft. on center and not more than one unit per each 65 square feet of floor area in each span.

Note: The above product data pertains to both one-piece units and through-floor fittings.

When connection conduit sweeps to through-floor fittings, ensure compliance with NEC fill tables.

Dimensions in Inches (mm)

Pedestal Fitting Series

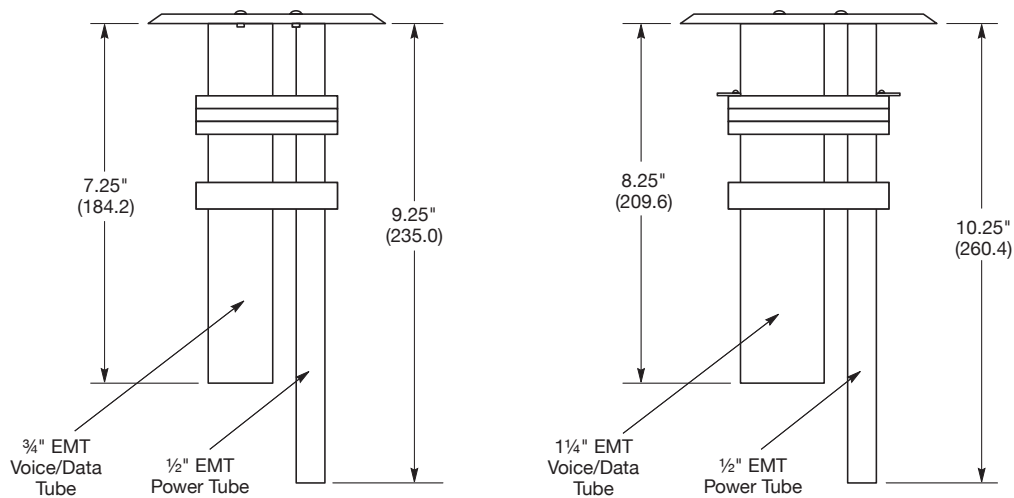

**Applications**

	<b>PT27A</b>	<b>PT7XC</b>
Mounting	2 in. (50.8) diameter hole.	3 in. (76.2) diameter hole.
Floor Thickness Range	2 1/4 in. to 7 in. (57.2 to 177.8)	2 1/4 in. to 7 in. (57.2 to 177.8)
Fire Rating	For use in 1, 1 1/2, 2, 3 or 4 hour rated unprotected reinforced concrete floors or in 1, 2 or 3 hour rated employing steel floor units and concrete topping (D900 series design). (D900 series design).	For use in 1, 1 1/2, 2, 3 or 4 hour rated unprotected reinforced concrete floors or in 1, 2 or 3 hour rated floors employing steel floor units and concrete topping
Service Pedestal Options	FR280, FR480, FR680 Series.	FR480 and FR680 Series.

**UL Listed Wiring Capacity**

Power Wiring Capacity	1/2 in. inch EMT power tube Handles: Up to ten #12 AWG type THHN wires, or Up to six #12 AWG and two #10 AWG type THHN wires.	1/2 in. inch EMT power tube Handles: Up to ten #12 AWG type THHN wires, or Up to six #12 AWG and two #10 AWG type THHN wires.		
Voice/Data Wiring Capacity	3/4 in. inch EMT low-voltage tube Handles: Up to two 25 pair tel./data cables (100 #22 AWG tel./data conductors), or Up to two IBM Type 2 data cables.	1 1/4 in. inch EMT low-voltage tube Handles: Up to four 25 pair tel./data cables (200 #22 AWG tel./data conductors), or Up to five IBM Type 2 data cables and four 8-conductor tel./data cables.		
Total Allowable Copper Cross-Sectional Area	1/2" Power EMT .0461 sq. in.	3/4" Low Voltage EMT .0500 sq. in.	1/2" Power EMT .0461 sq. in.	1 1/2" Low Voltage EMT .1000 sq. in.

When conductors larger than #22 AWG are used, the total cross-sectional area of the copper conductors shall not exceed the total cross-sectional area of the #22 AWG conductors permitted in the low voltage compartment.

*Note: When connecting conduit sweeps to through-floor fittings, ensure compliance with NEC fill tables.*

**UL Characteristics**

Listing	UL File Number	UL File Number
Outlet Box	E31999	E31999
Fire Resistance	R8429	R8429

For use in 1, 1 1/2, 2, 3, or 4 hour rated unprotected reinforced concrete floors or in 1, 2 or 3 hour rated floors employing steel floor units and concrete topping (D900 Series designs).

UL Spacing Restrictions - Minimum of 2 ft. O.C. and not more than one unit per each 65 sq. ft. of floor area in each span.

**Chicago Approved**

Catalog Number	City of Chicago File Number
<b>PT27A, PT7XC</b>	5587E

These through-floor fittings are approved for the City of Chicago. Installation requires a plenum-rated 1900 series box or a handy box with gasketed cover. These boxes are to be affixed with compression gland-type connectors.

*Dimensions in Inches (mm)*

*Painted and Brushed Aluminum Series*

**Dimensions**

**2-Gang – FR280 series**

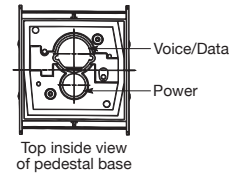
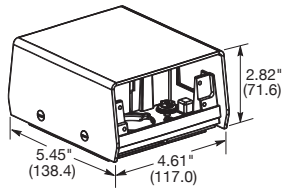

Total Cubic Inch Capacity (Single-Service)	39.00 in. (638.8cm <sup>3</sup> )	
Cubic Inch Capacity	Power	19.5 in. (319.4cm <sup>3</sup> )
(when divided for multi-service)	Voice/Data	19.5 in. (319.4cm <sup>3</sup> )
Service Pedestal Construction	Heavy gauge galvanized steel frame with aluminum housing and face plates.	
Pedestal Finish	Textured black or gray epoxy paint.	

**4-Gang – FR480**

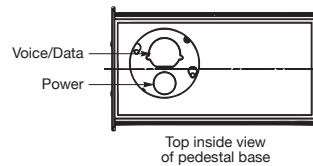
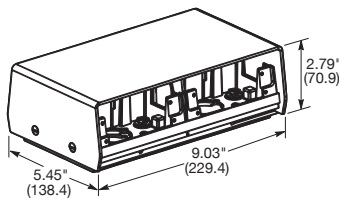

Total Cubic Inch Capacity (Single-Service)	78.00 in. (1277.6cm <sup>3</sup> )	
Cubic Inch Capacity	Power	39.00 in. (638.8cm <sup>3</sup> )
(when divided for multi-service)	Voice/Data	39.00 in. (638.8cm <sup>3</sup> )
Service Pedestal Construction	Heavy gauge galvanized steel frame with aluminum housing and face plates.	
Pedestal Finish	Textured black or gray epoxy paint.	

**6-Gang – FR680**

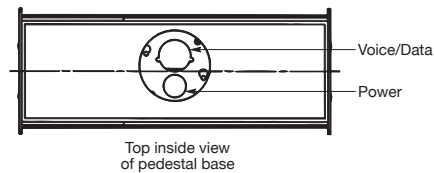
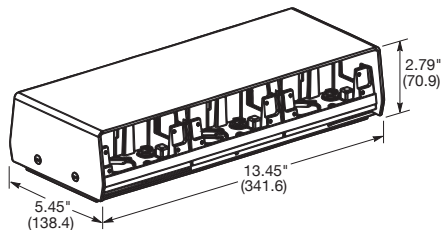

Total Cubic Inch Capacity (Single-Service)	117.00 in. (1916.4cm <sup>3</sup> )	
Cubic Inch Capacity	Power	58.5 in. (958.2cm <sup>3</sup> )
(when divided for multi-service)	Voice/Data	58.5 in. (958.2cm <sup>3</sup> )
Service Pedestal Construction	Heavy gauge galvanized steel frame with aluminum housing and face plates.	
Pedestal Finish	Textured black or gray epoxy paint.	

**2-Gang – FR80AL**

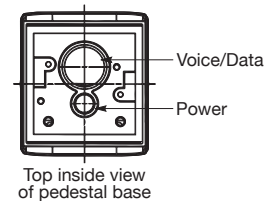
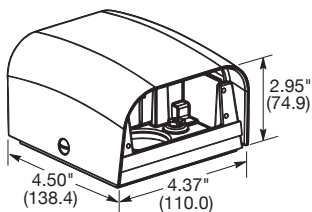

Total Cubic Inch Capacity (single service)	33.00 in. (540.9 cu cm <sup>3</sup> )	
Cubic Inch Capacity	Power	8.80 in. (144.2cm <sup>3</sup> )
(when divided for multi-service)	Voice/Data	26.70 in. (437.6cm <sup>3</sup> )
Service Pedestal Construction	Heavy gauge aluminum frame with satin anodized aluminum housing with 302/304 stainless steel face plates.	
Pedestal Finish	Brushed.	

*Dimensions in Inches (mm)*

# Section Q Aluminum Service Poles

## Index

Product	Page
Ordering Information, Specifications and Dimensions . . . . .	Q-2
Custom Pole Configurations . . . . .	Q-3
Division 16 Specifications . . . . .	Q-4



photo courtesy of  
constructionphotographs.com



# Aluminum Service Poles

## Ordering Information, Specifications and Dimensions



HBLPP10AI



HBLPP10IGA



HBLPP10SAI



ATB

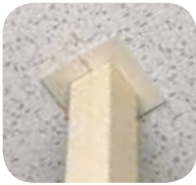

PPTRIM1

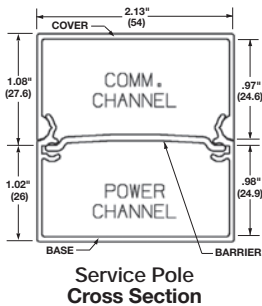

### Aluminum Series Offering

Hubbell offers a line of gray, ivory and clear anodized aluminum service poles. These attractive and durable poles effectively distribute power and telecommunications wiring from above the ceiling to workstations below. They are offered in lengths of 10' 2", 12' 2", and 15' 2" with a variety of electrical wiring devices. Poles with three service capability have a divider to separate power and low voltage wiring.

A blank pole with knockouts is also offered which does not have devices or wiring. In addition to a standard pole, which has two 20 amp duplex receptacles, an isolated ground or surge suppression version is also available. All poles, except the blank versions, are factory wired with Hubbell Style Line® decorator receptacles. Two Style Line® knockouts are also provided on the same side as the power receptacles for communication outlets.

### Ordering Information

Aluminum service poles; gray or ivory painted and clear anodized aluminum; Style Line® decorator duplex receptacles and two Style Line® knockouts for communications; includes ceiling trim mounting plate and scuff boot.

Description	Height Feet (m)	Catalog Number		
		Gray	Ivory	Clear Anodized Aluminum
Three service; two 20A 125V Style Line® duplex receptacles; one circuit.	10' 2" (3.10m)	HBLPP10A	HBLPP10AI	HBLPP10AAL
	12' 2" (3.71m)	HBLPP12A	HBLPP12AI	HBLPP12AAL
	15' 2" (4.62m)	HBLPP15A	HBLPP15AI	HBLPP15AAL
Three service; one orange isolated ground 20A 125V Style Line® duplex receptacle; one 20A 125V Style Line® duplex receptacle; two circuits.	10' 2" (3.10m)	HBLPP10IGA	HBLPP10IGA I	—
	10' 2" (3.10m)	HBLPP10SA	HBLPP10SA I	—
Three service; two orange isolated ground 20A 125V Style Line® duplex receptacles; one isolated ground surge suppression 20A 125V duplex receptacle; one circuit.	10' 2" (3.10m)	HBLPPOA	HBLPPOAI	HBLPPOAAL
	12' 2" (3.71m)	HBLPPO12A	HBLPPO12AI	HBLPPO12AAL
	15' 2" (4.62m)	HBLPPO15A	HBLPPO15AI	HBLPPO15AAL
Adjustable T-bar assembly for mounting poles in the middle of ceiling tile.		ATB	ATB	ATB
Replacement service pole trim kit (office white).		PPTRIM1	PPTRIM1	PPTRIM1

Note: See section W for additional information on datacom products.

### Specifications

Material: Extruded aluminum; .05" thick (1.27mm)  
 Finish: gray, ivory or clear anodized aluminum  
 Conductors: #12 AWG stranded copper  
 Receptacles: (see drawings below)  
 Listing: UL Listed

Wiring Capacity (@40% fill)	Voice Data Channel*			Power Channel**
	Cat. 5e	Cat. 6	Cat. 6A	
HBLPP10A; HBLPP12A; HBLPP15A; HBLPP10IGA	26	11	9	41
HBLPP10SA; HBLPP10SAI	8	6	3	41
HBLPPOA, HBLPPO12A, HBLPPO15A (with barrier)	26	11	9	41

Note: \*Pole wiring capacity (telephone fill): Cat. 5 UTP (1.96 sq. ft.).  
 \*\*#12 THHN stranded.

### Dimensions

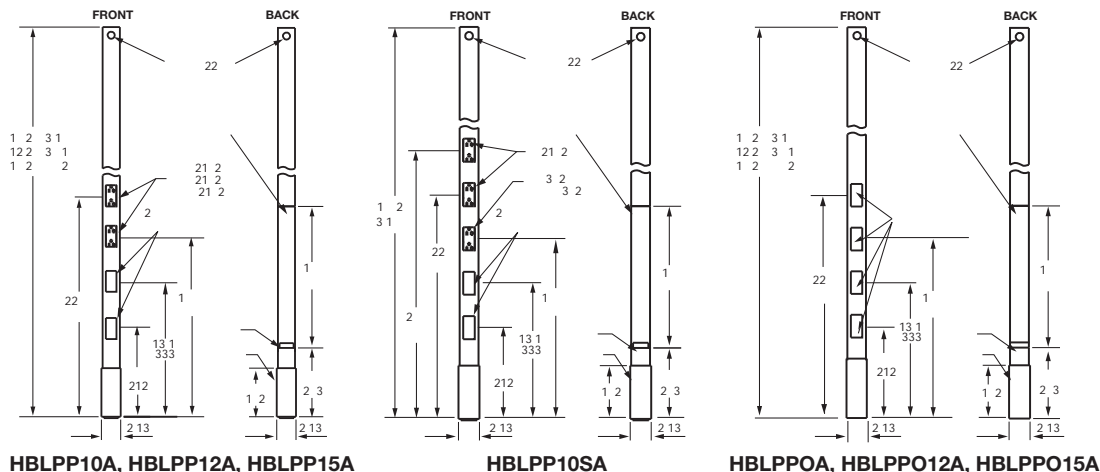



# Aluminum Service Poles

## Custom Pole Configurations

### Custom Poles

Using the chart below, you can create a custom service pole. For configurations that require additional customization, please consult Hubbell Technical Service at (475) 882-4800.

Position		1	2	3	4	5	6	7	8	9	10	11	12	13	14
Selections	S P	1	0	0	2	1	1	B	B	B	X	X	X	C	I

**Example: SP100211BBBXXCI**

10 Feet 02 Inches, (2) Rectangular Style Line® Knockouts for Data, (3) HBL2162 Duplex Receptacles, (2) Circuits (First 2 Receptacles on Circuit #1, Remaining Receptacles on Circuit #2), Ivory.

### Worksheet

Position		1	2	3	4	5	6	7	8	9	10	11	12	13	14
Selections	S P														

Position 1 & 2: Height to the nearest foot.	08-22 Feet.
Position 3 & 4: Height in inches up to 11".	00-11 Inches.
Position 5, 6, 7, 8, 9, 10, 11, 12: Starting at Position 5 Select Datacom Knockouts/Device Frames followed by Power Receptacle/Power Knockout options. If the service pole is power only, select receptacle options starting at Position 5. Empty Positions should be filled with an "X" to designate an empty field.	<p><b>Data Selections</b></p> <p>1 - Rectangular Style Line® Knockout.                  2 - ½" NPT Knockout (0.875" diameter).                  3 - ¾" NPT Knockout (1.109" diameter).                  4 - 2-Port Style Line® Data Frame, 1-Gang, 2 Port Voice/Data Frame.                  5 - 3-Port Style Line® Data Frame, 1-Gang, 3 Port Voice/Data Frame.</p> <p><b>Power Selections</b></p> <p>6 - Rectangular Style Line® Knockout (for blank poles only).                  7 - ½" NPT Knockout (0.875" diameter, for blank poles only).                  8 - ¾" NPT Knockout (1.109" diameter, for blank poles only).                  A - 5362, 20A, 125V AC, Duplex.                  B - HBL2162, 20A, 125V AC, Style Line® Decorator Duplex.                  C - IG5362, 20A, 125V AC, I.G. Duplex.                  D - IG2162, 20A, 125V AC, I.G. Style Line® Decorator Duplex.                  G - HBL4700, 15A, 125V AC, Twist-Lock® Duplex.                  H - IG4700A, 15A, 125V AC, I.G. Twist-Lock® Duplex.                  I - IG2310, 20A, 125V AC, I.G. Twist-Lock® Single.                  J - IG5361, 20A, 125V AC, I.G. Single.                  K - HBL5361, 20A, 125V AC, Single.                  L - HBL2310, 20A, 125V AC, Twist-Lock® Single.                  M - HBL2610, 30A, 125V AC, Twist-Lock® Single.                  N - HBL2320, 20A, 250V AC, Twist-Lock® Single.                  O - HBL2620, 30A, 250V AC, Twist-Lock® Single.                  Q - IG4710, 15A, 125V AC, I.G. Twist-Lock® Single.                  R - HBL4710, 15A, 125V AC, Twist-Lock® Single.                  S - HBL5662, 15A, 250V AC, Duplex.                  T - IG5662, 15A, 250V AC, I.G. Duplex.                  U - HBL5661, 15A, 250V AC, Single.                  V - IG5661, 15A, 250V AC, I.G. Single.                  W - HBL5462, 20A, 250V AC, Duplex.</p>
Note: If power receptacles are chosen, then power knockouts may not be chosen in the same service pole.	
Position 13: Power Circuits	<p>Z - No Circuits (Should only be selected when the service poles has ONLY Data and/or Power knockouts).</p> <p>A - All devices on a single circuit.                  B - 2 Circuits, First Receptacle on Circuit #1, Remaining Receptacles on Circuit #2.                  C - 2 Circuits, First 2 Receptacles on Circuit #1, Remaining Receptacles on Circuit #2.                  D - 2 Circuits, First 3 Receptacles on Circuit #1, Remaining Receptacles on Circuit #2.                  E - 2 Circuits, First 4 Receptacles on Circuit #1, Remaining Receptacles on Circuit #2.                  F - 2 Circuits, First 5 Receptacles on Circuit #1, Remaining Receptacles on Circuit #2.                  G - 2 Circuits, First 6 Receptacles on Circuit #1, Remaining Receptacles on Circuit #2.                  H - 2 Circuits, First 7 Receptacles on Circuit #1, Remaining Receptacles on Circuit #2.</p>
Position 14: Color	<p>I - Ivory.                  G - Gray.                  W - White.                  K - Black.                  A - Aluminum with clear anodized finish.</p>

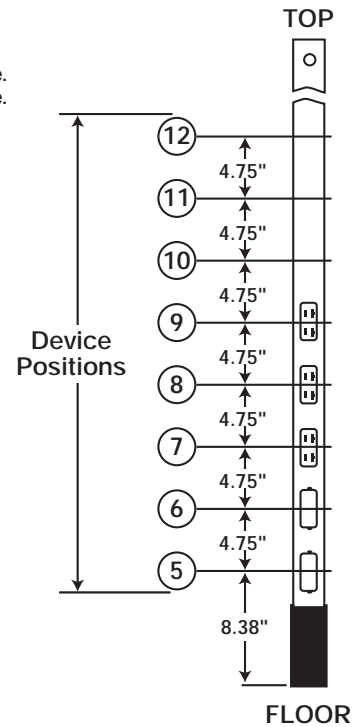

Dimensions in Inches (mm)

# Aluminum Service Poles

## Division 16 Specifications

### Section 16110 Raceways

## Part 2: Products

### 2.01 Manufacturer

A. The power poles specified herein for branch circuit wiring shall be Hubbell Service Poles as manufactured by Hubbell Inc., Wiring Device-Kellems® or approved equal. Other manufacturers may be considered equal if they meet the performance requirements of this specification and have received prior written approval.

### 2.02 Components/Accessories

A. The hardware for mounting Service Poles in the middle of a ceiling tile shall be Hubbell adjustable T-Bar type ATB with trim plate kit type PPTRIM1.

### 2.03 Materials

## A. Standard and Custom Aluminum Service Poles

### 1. *Standard Style Line® Decorator Duplex*

These Service Poles shall be extruded aluminum with a heavy gauge body (.050 ±.005 inches thick) to resist denting. These poles shall be two-channel to accommodate both power and low voltage services on the same side of the pole. Service poles shall be pre-wired with #12 AWG wire and equipped with two specification grade Style Line® decorator receptacles (20A, 125V). These receptacles shall be Hubbell type HBL2162GY/HBL2162I or an approved equal. The low voltage (back) channel of the service pole shall incorporate an access panel that provides a passageway to two Style Line® communication knockouts located on the front of the pole.

#### *Finish*

Service Poles will include a painted or clear anodized finish.

Custom poles are available in Gray, Ivory, White, Black and Clear Anodized Aluminum.

#### *Heights*

Standard Service Poles shall be available in three sizes to accommodate various ceiling heights: 10 ft. 2 in. (3.10m), 12 ft. 2 in. (3.71m) and 15 ft. 2 in. (4.62m). Custom Poles shall be available in a range of sizes, a configurator pole is 8 through 22 ft.

Other custom poles can be as short as 6 in. through 22 ft.

10 ft. 2 in. (3.10m): Hubbell type HBLPP10A, HBLPP10AI, HBLPP10AAL.

10 ft. 2 in. (3.10m): With Surge; Hubbell Type HBLPP10SA, HBLPP10SAI.

10 ft. 2 in. (3.10m): Isolated Ground; Hubbell Type HBLPP10IGA, HBLPP10IGAI.

12 ft. 2 in. (3.71m): Hubbell type HBLPP12A, HBLPP12AI, HBLPP12AAL.

15 ft. 2 in. (4.62m): Hubbell type HBLPP15A, HBLPP15AI, HBLPP15AAL.

8-22 feet: Hubbell Custom Poles.

### 2. *Isolated Ground*

The following Service Poles contain one Hubbell isolated ground receptacle Hubbell #IG2162 and one #HBL2162GY/HBL2162I, both 20A, 125V Style Line® decorator receptacles (wired on separate circuits). Gray aluminum painted poles shall be Hubbell type HBLPP10IGA. Ivory pole shall be Hubbell type HBLPP10IGAI. Custom poles with a variety of receptacles may also include isolated ground type devices.

### 3. *Surge Suppression/Isolated Ground*

The following Service Poles contain one Hubbell #IG5362GYSA/IG5362ISA (20A, 125V Surge/IG Style Line® decorator duplex) and two #IG2162 (20A, 125V IG Style Line® decorator duplex) receptacles. All receptacles are wired on the same circuit, therefore providing surge protection at each outlet. Gray aluminum painted pole shall be Hubbell type HBLPP10SA. Ivory pole shall be Hubbell type HBLPP10SAI. Custom poles with a variety of receptacle options may also include surge suppression.

### 4. *Blank*

The following poles are two-channel and do not include receptacles or wiring. All poles include a barrier which starts between the second and third knockout positions from the bottom of the pole. Custom poles with or without a barrier are available as well.

10 ft. 2 in. (3.10m): Hubbell type HBLPPOA, HBLPPOAI, HBLPPOAAL.

12 ft. 2 in. (3.71m): Hubbell type HBLPPO12A, HBLPPO12AI, HBLPPO12AAL.

15 ft. 2 in. (4.62m): Hubbell type HBLPPO15A, HBLPPO15AI, HBLPPO15AAL.

## B. Voice/Data Interface

All Service Poles must allow for acceptance of Hubbell Style Line® communication outlets.

# Section R Metal and Non-Metallic Raceway

## Index

Metal Raceway	Page
Raceway Profiles - Quick Reference Guide . . . . .	R-2
HBL500 and HBL750 Series . . . . .	R-3
HBL2000 and HBL2000A Series . . . . .	R-9
Metal PlugTrak® . . . . .	R-12
HBL2400 and HBL2400D Series . . . . .	R-13
HBL3000 Series . . . . .	R-17
HBL4750 Series . . . . .	R-21
HBL6750 Series . . . . .	R-27
HBLALU2000 Series . . . . .	R-33
Aluminum PlugTrak® . . . . .	R-36
HBLALU3800 and HBLALU4800 Series . . . . .	R-37
HBLALU5000 and HBLALU7620 Series . . . . .	R-41
Plates and Outlets . . . . .	R-45
Technical Information and Wire Fill Capacity Chart . . . . .	R-47
Cross Reference . . . . .	R-48
<hr/>	
Non-Metallic Raceway	Page
PolyTrak® Non-Metallic Raceway . . . . .	R-53
PT1 PremiseTrak® (Non-Latching) Series . . . . .	R-54
PP1 PremiseTrak® (Latching) Series . . . . .	R-55
PL1 LANTrak® Series . . . . .	R-56
PW1 WallTrak® Low Profile Series . . . . .	R-57
PW2 2 Channel WallTrak® Series . . . . .	R-58
PB2 2 Channel BaseTrak® Series . . . . .	R-59
PB3 3 Channel BaseTrak® Series . . . . .	R-60
PS3 3 Channel Super BaseTrak® . . . . .	R-61
Non-Metallic PlugTrak® and Portable PlugTrak® . . . . .	R-62
Plates and Outlets . . . . .	R-63
Technical Information and Wire Capacity Fill Chart . . . . .	R-64
<hr/>	
Pre-Wired Raceway	Page
Introduction . . . . .	R-65
Features and Benefits . . . . .	R-66
Aluminum, Steel and Non-Metallic Raceways . . . . .	R-67
Hubbell Pre-Wired Raceway with LINKOSITY® . . . . .	R-68

Metal Raceway



Innovative Box Design



Non-Metallic Raceway



Pre-Wired Raceway



# Metal Raceway

## Raceway Profiles - Quick Reference Guide

Dimensions

\* Available in **PRE-WIRED**

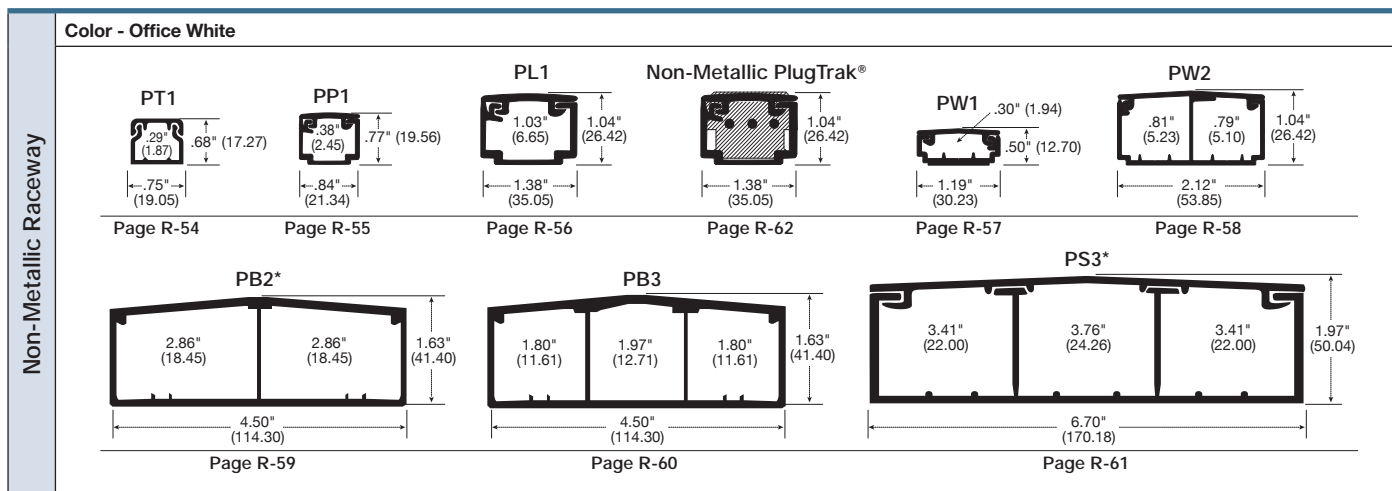
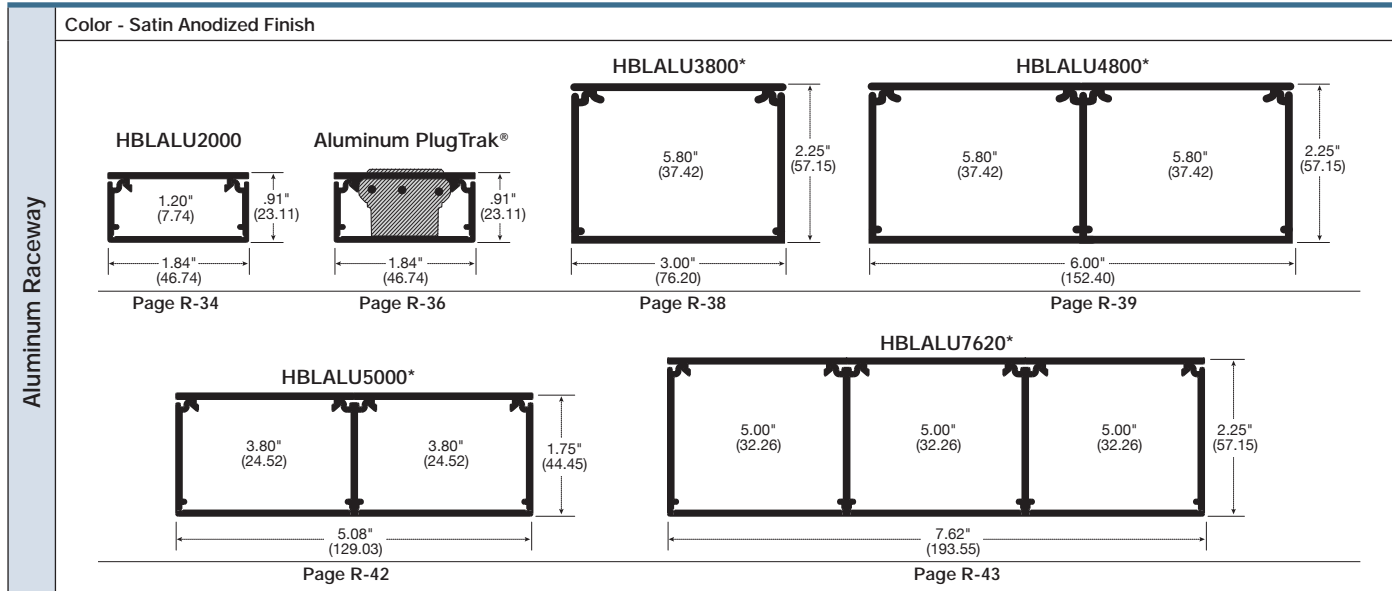
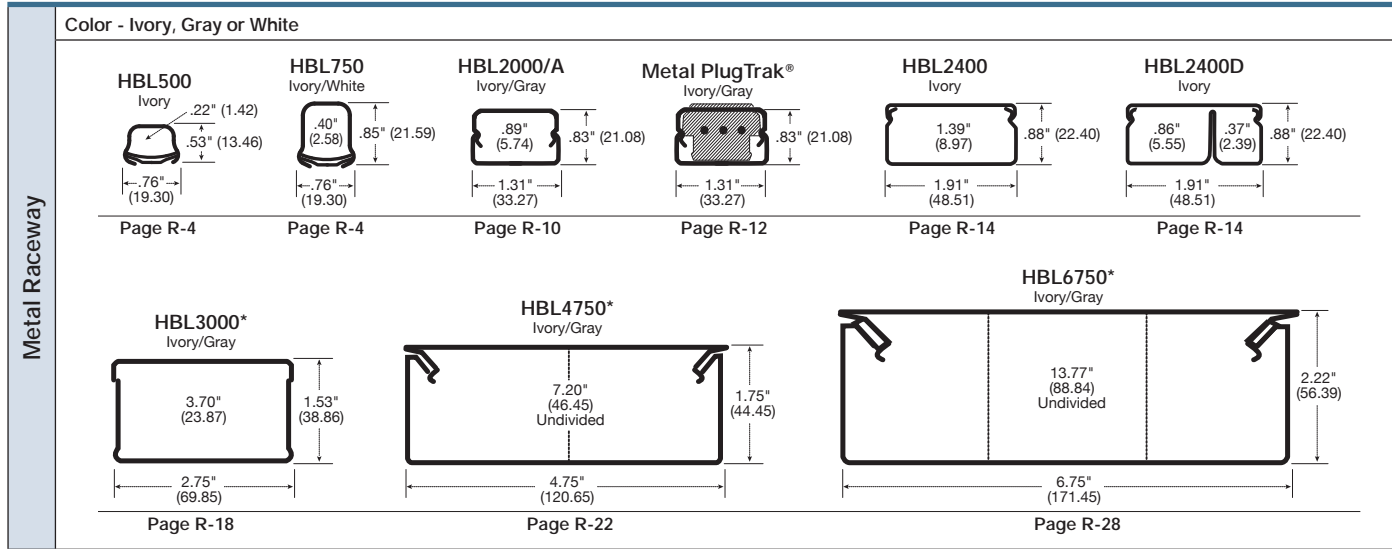

Note: \*Available in PRE-WIRED.  
 Channel Area in Square Inches (square centimeters).

# Metal Raceway HBL500 and HBL750 Series

Features and Benefits



## Innovative Box Design

- Hubbell Handi-Screw® eliminates difficult to install long screws for easier installation.
- Rounded corners eliminate sharp edges.
- One seam construction provides “clean” look.
- Box design allows standard wallplates to be mounted flush with virtually no perimeter profile exposed.
- Full line of metal wallplates available. See page R-45 for selection.



## Enhanced Datacom Capabilities

- Allows up to five Category 5e, three Category 6, or two Category 6A cables.
- Available with 1½ in. (38.10) Category 6 and 6A bend radius fittings.
- Largest single channel low profile raceway available in its class.
- Ideal for datacom and oversized neutral applications.
- HBL750 Series exclusive to Hubbell.



## White Metal Raceway

- HBL750 Series available in white.
- Full line of product.
- More color options available for architects and interior designers.



## Retrofit Box for Fire Alarm Detectors

- Fits most manufactures of audible alarm systems.
- Hubbell Handi-Screw® eliminates difficult to install long screws for easier installation.
- Compatible with both HBL500 and HBL750 Series Metal Raceway.
- Available in white and ivory.



Metal Raceway  
**HBL500 and HBL750 Series**  
*Specialty Boxes, Round Boxes and Covers*



	1-Gang Specialty Boxes			2-Gang Specialty Boxes		
	Description	Color	1-Gang	Description	Color	2-Gang
1-Gang Specialty Boxes	<b>Low Profile Switch/Receptacle</b> Base has 1/2" trade size KOs.	Ivory White	<b>HBL5748SIV</b> <b>HBL5748SW</b> A: 4.54" (115.32) B: 2.82" (71.63) C: 1.13" (28.70)	<b>Alarm Device Box</b> Surface mounting of alarm devices and safety signals.	Ivory Red	<b>HBL5752IV</b> <b>HBL5752R</b> A: 4.54" (115.32) B: 4.64" (117.86) C: 1.38" (35.05)
	<b>Combination Switch/Recept.</b> Connects surface runs of 1/2" trade size conduit, one raceway twistout each side and three raceway twistouts top and bottom.	Ivory White	<b>HBL5745IV</b> <b>HBL5745W</b> A: 4.54" (115.32) B: 2.82" (71.63) C: 1.75" (44.45)	<b>Extra Deep Alarm Device Box</b> For surface mounting of alarm devices and safety signals. Cover is 2.75" (69.85) deep.	Ivory Red	<b>HBL5753IV</b> <b>HBL5753R</b> A: 4.54" (115.32) B: 4.64" (117.86) C: 2.75" (69.85)
	<b>Utility Box*</b> For use as a tee, cross, pull box, junction box or blank box. Base has 1/2" trade size KOs.	Ivory	<b>HBL57242IV</b> <b>HBL57242W</b> A: 4.12" (104.78) B: 2.00" (50.80) C: 1.39" (35.31)	<b>Distribution Box</b> Twistouts permit three parallel raceway runs on each side. Cover takes devices with mounting screw centers of 2.75" (69.85), 3.5" (89.00), 4.0625" (103.00) and canopy fixture not larger than 4.625" (117.00). Can be used with HBL5736IV (blank cover) to create junction box.	Ivory	<b>HBL5735IV</b> A: 4.54" (115.32) B: 4.64" (117.86) C: 1.38" (35.05)

Note: \*Use catalog number HBL5791 for connecting 1/2 in. EMT to HBL5745 and HBL57242 boxes.



	Description	Color	Round Boxes		
			4.75 inches O.D.	5.50 inches O.D.	6.38 inches O.D.
Round Boxes	<b>Extension Box (Open Base)</b> For mounting on 3.25" (83.00) or 4" (102.00) round or square conduit boxes or other recessed outlets. Cover takes any device with mounting screw centers of 2.75" (69.85), 3.5" (89.00) and 4.06" (103.00).	Ivory White	<b>HBL5737IV</b> <b>HBL5737W</b> A: 1.02" (26.00) B: 4.75" (120.65)	<b>HBL5737AIV</b> <b>HBL5737AW</b> A: 1.02" (26.00) B: 5.50" (140.00)	<b>HBL5739AIV</b> — A: 1.02" (26.00) B: 6.38" (162.01)
	<b>Fixture Box (Solid Base)</b> To hang fixtures. Cover takes any device with mounting screw centers of 2.75" (69.85), 3.5" (89.00) and 4.06" (103.00). Both boxes can be used as a pull or junction box when used with HBL5736IV (blank cover).	Ivory White	<b>HBL5738IV</b> <b>HBL5738W</b> A: 1.02" (26.00) B: 4.75" (120.65)	<b>HBL5738AIV</b> <b>HBL5738AW</b> A: 1.02" (26.00) B: 5.50" (140.00)	<b>HBL5739IV</b> <b>HBL5739W</b> A: 1.02" (26.00) B: 6.38" (162.01)

	Specialty Round Boxes			Round Covers		
	Description	Color	Catalog Number	Description	Color	Catalog Number
Specialty Round Boxes	<b>Outlet Box</b> For devices with mounting screw centers of 1.47" (37.00), 1.63" (41.00), 1.69" (44.00) or 1.84" (46.00).	Ivory	<b>HBL5733IV</b> A: 1.02" (26.00) B: 3.00" (76.00)	<b>Blank Cover</b> For use with HBL5733IV. Has 1/2" trade size KO in center.	Ivory	<b>HBL5731IV</b> A: .24" (6.10) B: 2.40" (60.96)
	<b>Fanbox with Solid Base</b> Cover accepts fan bracket with mounting centers of 3.2" (81.00). Rated for fans and fixtures up to 50 lbs.	Ivory White	<b>HBL5738AFIV</b> <b>HBL5738AFW</b> A: .38" (9.75) B: 4.19" (106.30)	<b>Blank Cover</b> For use with HBL5735IV, HBL5737IV/W, HBL5737AIV/W, HBL5739AIV, HBL5738IV/W, HBL5738AIV/W and HBL5739IV/W. Has 1/2" trade size KO in center.	Ivory White	<b>HBL5736IV</b> <b>HBL5736W</b> A: .38" (9.75) B: 4.19" (106.30)
	<b>Retrofit Box for Fire Alarm Detectors</b> For installing round alarm sensors.	Ivory White	<b>HBL5739AABIV</b> <b>HBL5739AABW</b> A: 1.62" (41.15) B: 6.50" (165.10)			

Dimensions in Inches (mm)

Metal Raceway  
HBL500 and HBL750 Series  
Elbow and Tee Fittings











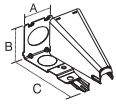

	Elbows				Tees			
	Description	Color	HBL500 Series	HBL750 Series	Description	Color	HBL500 and HBL750 Series	HBL500 and HBL750 Series
Elbows	<b>Internal Elbow</b> For inside surfaces at right angles.	Ivory White	<b>HBL517IV</b> <b>HBL517W</b> A: 3.33" (84.51) B: .58" (14.73) C: 3.33" (84.51)	<b>HBL717IV</b> <b>HBL717W</b> A: 3.33" (84.51) B: .90" (22.86) C: 3.33" (84.51)	<b>Internal Elbow Bend Radius</b> For inside surface at right angles requiring a 1.5" (38.10) bend radius. Suitable for Category 5, 5e, 6 and 6A applications.	Ivory White	<b>HBL5717BRIV</b> — A: 3.33" (84.51) B: .91" (23.11) C: 3.33" (84.51)	
	<b>External Elbow</b> For outside surfaces at right angles.	Ivory White	<b>HBL518IV</b> <b>HBL518W</b> A: 2.59" (65.71) B: .58" (14.73) C: 2.59" (65.71)	<b>HBL718IV</b> <b>HBL718W</b> A: 2.59" (65.71) B: .90" (22.86) C: 2.59" (65.71)	<b>External Elbow Bend Radius</b> For outside surfaces at right angles requiring a 1.5 in. (38.10) bend radius. Suitable for Category 5, 5e, 6 and 6A applications.	Ivory White	<b>HBL5718BRIV</b> — A: 4.86" (123.43) B: .78" (19.80) C: 1.35" (34.28)	
	<b>90° Flat Elbow</b> For right angle turns on same surface.	Ivory White	<b>HBL511IV</b> <b>HBL511W</b> A: 2.68" (68.13) B: .61" (15.50) C: 2.68" (68.13)	<b>HBL711IV</b> <b>HBL711W</b> A: 2.68" (68.13) B: .90" (22.86) C: 2.68" (68.13)	<b>Flat Elbow Bend Radius</b> For right angle turns requiring a 1.5 in. (38.10) bend radius. Suitable for Category 5, 5e, 6 and 6A applications.	Ivory White	<b>HBL5711BRIV</b> — A: 3.16" (80.34) B: .91" (23.11) C: 3.16" (80.34)	
	<b>45° Flat Elbow</b> For diagonal 45° turns on same surface.	Ivory White	<b>HBL512IV</b> — A: 2.46" (62.61) B: .58" (14.73) C: 2.46" (62.61)	<b>HBL712IV</b> — A: 2.70" (68.49) B: .91" (23.06) C: 2.70" (68.49)	<b>Internal Twisted Elbows</b> For 90° twist with 90° turn. For double turn at right angles from one to another. From a flat run on a side wall to a flat run on a ceiling, edge of door or window trim.	Ivory White  Ivory White	Right Elbow <b>HBL5711RHIV</b> <b>HBL5711RHW</b>  Left Elbow <b>HBL5711LHIV</b> <b>HBL5711LHW</b> A: 2.98" (75.72) B: .94" (23.75) C: 3.00" (76.20)	
Tees	<b>Tee Fitting</b> For branches at right angles.	Ivory White	<b>HBL5715IV</b> <b>HBL5715W</b> A: 3.06" (77.67) B: 1.14" (28.86) C: 3.03" (76.96)	<b>HBL5715BRIV</b> — A: 5.55" (140.88) B: .90" (22.86) C: 3.16" (80.34)	<b>Tee Fitting Bend Radius</b> For branches at right angles requiring a 1.5 in. (38.10) bend radius. Suitable for Category 5, 5e, 6 and 6A applications.	Ivory White		

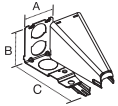



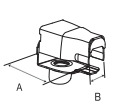

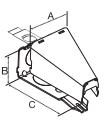

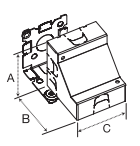

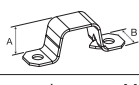
Dimensions in Inches (mm)

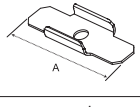

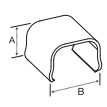
# Metal Raceway HBL500 and HBL750 Series Fittings

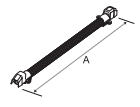

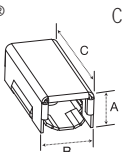
End Fittings	Description	Color	HBL500 and HBL750 Series	Description	Color	HBL500 and HBL750 Series		
	<b>Entrance Connector</b> One ¼ in. KO for panel or conduit connection. One ¾ in. chase nipple and locknut furnished.	Ivory White	<b>HBL5786AIV</b> <b>HBL5786AW</b>	A: 1.50" (38.10) B: 1.84" (46.74) C: 3.89" (98.87)	<b>Adjustable Offset Connector</b> Two ½ in. KOs for panel or conduit connection. Eliminates offsetting raceway when connecting to surface type panel boxes. One ½ in. chase nipple and locknut furnished.	Ivory White	<b>HBL5786IV</b> <b>HBL5786W</b>	A: 1.50" (38.10) B: 1.84" (46.74) C: 3.89" (98.87)
	 				 			
	<b>Elbow Box Connector</b> For connecting raceway at right angles to conduit boxes, panel boxes, etc. having ½ in. nipple for trade size conduit.	Ivory	<b>HBL5783IV</b>	A: 2.13" (54.05) B: 1.24" (31.50)	<b>Elbow Conduit Connector</b> For connecting raceway at right angles to ½ in. trade size conduit or armored cable connectors	Ivory	<b>HBL5784IV</b>	A: 2.13" (54.05) B: 1.24" (31.50)
 				 				
<b>Combination Connector</b> For connecting raceway without offsetting to any 3.25 in. (83.00) or 4 in. (102.00) outlet box mounted on the surface with a KO for ½ in. trade size conduit. Spring steel bushing eliminates need for conduit nipple and locknut.	Ivory White	<b>HBL5785IV</b> <b>HBL5785W</b>	A: 1.50" (38.10) B: 1.84" (46.74) C: 3.89" (98.87)	<b>Corner Box</b> For connecting HBL500 or HBL750 Raceway from ceiling or corner. Each leg of base has ½ in. trade size KO.	Ivory White	<b>HBL5719IV</b> <b>HBL5719W</b>	A: 2.50" (63.50) B: 2.50" (63.50) C: 2.40" (60.96)	
 				 				

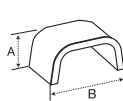
Fittings	Description	Color	HBL500 Series	HBL750 Series	Description	Color	HBL500 and HBL750 Series		
	<b>Mounting Strap (one- or two-hole)</b> For mounting HBL500 or HBL750 Raceway to surface. Convert to one-hole by breaking off at score.	Ivory White	<b>HBL504IV</b> <b>HBL504W</b>	A: .58" (14.73) B: .50" (12.70)	<b>HBL704IV</b> <b>HBL704W</b>	A: .90" (22.86) B: .50" (12.70)	Ivory White	<b>HBL5703IV</b> <b>HBL5703W</b>	A: 2.51" (63.75)
	 				 				
	<b>Connection Cover</b> To cover potential openings where two lengths of HBL500 or HBL750 Raceway come together.	Ivory White	<b>HBL506IV</b> <b>HBL506W</b>	A: .60" (15.24) B: .80" (20.31)	<b>HBL706IV</b> <b>HBL706W</b>	A: .91" (23.10) B: .80" (20.31)	Ivory	<b>HBL5700FIV</b>	A: 18.00" (457.20)
	 				 				
<b>Transition Fitting</b> For transitioning from either Wiremold® V500 to Hubbell HBL500 Raceway or Wiremold® V700 to Hubbell HBL750 Raceway.	Ivory	<b>HBL500TFIV</b>	A: .65" (16.51) B: .89" (22.61) C: 2.15" (54.61)	<b>HBL750TFIV</b>	A: .98" (24.89) B: .89" (22.61) C: 2.15" (54.61)				
 									
<b>Bushing</b> Protect wires from potential abrasion. Fits into end of HBL500 or HBL750 Raceway.	Steel*	<b>HBL502B</b>	A: .35" (8.83) B: .70" (17.68)	<b>HBL702B</b>	A: .60" (15.24) B: .70" (17.68)				
 									

Note: \*Zinc Plated Steel.



Wiremold® is a registered trademark of the Wiremold Company.

Dimensions in Inches (mm)

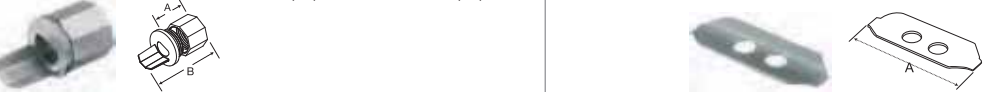

# Metal Raceway HBL500 and HBL750 Series

Fittings and Tools

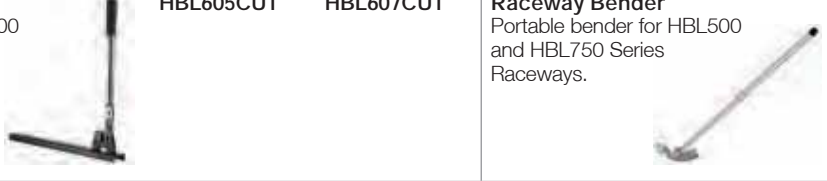

Fittings	Description	Material	HBL500 and HBL750 Series		Description	Material	HBL500 and HBL750 Series	
	<b>Box Connector</b> For connecting raceway to conduit boxes or panel boxes having KO for conduit. May also be used for conduit type fittings.	Steel*	<b>HBL5781</b> ½" NPT (13) Male A: .75" (19.1) B: 1.24" (31.62)	<b>HBL5781A</b> ¾" NPT (19) Male A: .75" (19.1) B: 1.24" (31.62)		<b>½ in. EMT Connector</b> For connecting raceway to conduit boxes or panel boxes having KO for conduit.	Steel*	<b>HBL5791</b> A: 1.20" (30.48) B: 1.09" (27.70)
								
	<b>Conduit Connector</b> For connecting raceway to conduit.	Steel*	<b>HBL5782C</b> ½" NPT (13) Male A: .75" (19.1) B: 1.75" (44)	<b>HBL5782A</b> ¾" (19.1) Female A: .75" (19.1) B: 1.75" (44)		<b>Coupling</b> For joining and supporting lengths of HBL500 or HBL750 Raceway.	Steel**	<b>HBL5701C</b> A: 2.00" (50.80)
								
<b>Grounding Clamp</b> Provides grounding means for ½ in. trade size conduit using locknut.	Steel**	<b>HBL5709GC</b> A: 1.04" (26.03) B: 1.18" (29.84)			<b>Ground Clamp</b> Used to provide additional grounding of raceway or to ground remotely located devices. Attach ground wire to screw as required by National Electrical Code.	Steel**	<b>HBL5709</b> A: 2.00" (50.80)	
								
<b>Special Nipple</b> For hanging or connecting either .375 in. (9.5) or .5 in. (12.7) fixtures to Hubbell fittings with ½ in. trade size KOs.	Steel*	<b>HBL5780</b> A: .63" (16.00)			<b>Armored Cable Connector</b> For connecting 14/2, 14/3, 12/2 and 12/3 "MC" and armored cable to Hubbell fittings. A short piece of HBL500 or HBL750 Series Raceway must be used between this connector and the Hubbell fitting. Not for connection to ½ in. (12.7) flex conduit.	Steel**	<b>HBL5790B</b> A: 2.00" (50.80) B: .99" (25.25)	
								

Note: \*Zinc Plated Steel.  
\*\*Galvanized Steel.

Tools	Description	HBL500 Series	HBL750 Series	Description	Color	HBL500 and HBL750 Series	
	<b>Cutter</b> Portable cutter for HBL500 and HBL750 Series Raceways.	<b>HBL605CUT</b>	<b>HBL607CUT</b>		<b>Raceway Bender</b> Portable bender for HBL500 and HBL750 Series Raceways.		<b>HBL600B</b>
							
<b>Cutter Replacement Blade</b>	<b>HBL605K</b>	<b>HBL607K</b>		<b>Touch-Up Paint Pen</b>	Ivory White	<b>HBLIWEP</b> <b>HBLWWEPE</b>	
							

Dimensions in Inches (mm)

## Metal Raceway HBL2000 and HBL2000A Series and Metal PlugTrak® *Features and Benefits*



### HBL2000A Raceway

- Cover is 0.040" (1.016) thick which allows up to 600V AC.
- Higher capacity power applications (up to 26 #12AWG wires).
- Available in cover only or base and cover options.



### Innovative Box Design

- Hubbell Handy-Screw® eliminates difficult to install long screws for easier installation.
- Rounded corners eliminate sharp edges.
- One seam construction provides "clean" look.
- Box design allows standard wallplates to be mounted flush with virtually no perimeter profile exposed.
- Full line of metal wallplates available. See page R-45 for selection.



### Bend Radius Fittings

- 1½ in. (38.10) bend radius.
- Ideal for high speed data cables including Category 5, 5e, 6 and 6A applications.



### Metal PlugTrak® Featuring Exclusive Receptacle Design

- Gray or ivory scratch resistant finish.
- Multiple spacing configurations.
- Hubbell designed and manufactured single receptacle.
- Insulation displacement wiring provides superior wire retention.
- Mates with HBL2000 Series Metal Raceway.
- Available in 3 ft. (0.9m), 5 ft. (1.5m) and 6 ft. (1.8m) lengths.
- Tamper-Resistant versions available.

# Metal Raceway

## HBL2000 and HBL2000A Series

Metal Raceway, Device Boxes, Elbows and Tees



	Description	Color	Catalog Number		Description	Color	Catalog Number
HBL2000 Series	<b>Base and Cover (300V Rated)</b> Cover is 0.025 in. (0.635) thick up to 300V AC applications. Packed 50 ft. (15m) per carton, 5 ft. (1.5m) lengths.	Ivory Gray	<b>HBL2000BCIV</b> <b>HBL2000BCGY</b> A: 60.00" (1,524.00) B: 1.31" (33.27) C: .83" (21.08)	HBL2000A Series	<b>Base and Cover (600V Rated)</b> Cover is 0.040 in. (1.016) thick up to 600V AC or higher capacity power applications (up to 26 #12AWG wires). Packed 50 ft. (15m) per carton, 5 ft. (1.5m) lengths.	Ivory Gray	<b>HBL2000BCAIV</b> <b>HBL2000BCAGY</b> A: 60.00" (1,524.00) B: 1.31" (33.27) C: .83" (21.08)

	Description	Color	Catalog Number		Description	Color	Catalog Number
Base and Cover	<b>5 Ft. Base Only</b> For use with HBL2000 and HBL2000A raceway. Packed 50 ft. (15m) per carton, 5 ft. (1.5m) lengths.	Ivory Gray	<b>HBL2000B5IV</b> <b>HBL2000B5GY</b> A: 60.00" (1,524.00) B: 1.31" (33.27)	Base and Cover	<b>5 Ft. Cover Only (300V Rated)</b> Cover is 0.025 in. (0.635) thick. Packed 50 ft. (15m) per carton, 5 ft. (1.5m) lengths.	Ivory Gray	<b>HBL2000CIV</b> <b>HBL2000CGY</b> A: 60.00" (1,524.00) B: 1.31" (33.27)
			<b>5 Ft. Cover Only (600V Rated)</b> Cover is 0.040 in. (1.016) thick up to 600V AC or higher capacity power applications (up to 26 #12AWG wires). Packed 50 ft. (15m) per carton, 5 ft. (1.5m) lengths.		Ivory Gray	<b>HBL2000CAIV</b> <b>HBL2000CAGY</b> A: 60.00" (1,524.00) B: 1.31" (33.27)	

	Description	Color	Catalog Number		Description	Color	Catalog Number
Device Boxes	<b>1-Gang Device Box</b> For deep switches and receptacles. Base has one ½ in. trade size KO and rectangular KO for extension to wall box.	Ivory Gray	<b>HBL2048IV</b> <b>HBL2048GY</b> A: 4.54" (115.32) B: 2.82" (71.63) C: 1.75" (44.45)	Device Boxes	<b>2-Gang Device Box</b> For deep switches and receptacles. Base has one ½ in. trade size KO and rectangular KO for extension to wall box.	Ivory Gray	<b>HBL20482IV</b> <b>HBL20482GY</b> A: 4.54" (115.32) B: 4.64" (117.86) C: 1.75" (44.45)
Elbows	<b>Internal Corner Coupling</b> For surfaces at right angles, or for use as a straight-through fitting. Furnished with one fiber bushing.	Steel**	<b>HBL2017TC</b> A: 1.30" (32.98) B: 1.40" (35.56)	Elbows	<b>Internal Elbow Bend Radius</b> For inside surface at right angles requiring a 1.5 in. (38.10) bend radius. Suitable for Category 5, 5e, 6 and 6A applications.	Ivory Gray	<b>HBL2017BRIV*</b> <b>HBL2017BRGY*</b> A: .85" (21.56) B: 3.47" (88.11)
			<b>External Elbow Coupling</b> For right angle turns around external corners.		Ivory Gray	<b>HBL2018BRIV*</b> <b>HBL2018BRGY*</b> A: 5.11" (129.72)	
			<b>90° Flat Elbow</b> For right angle turns on same surface.		Ivory Gray	<b>HBL2011BRIV*</b> <b>HBL2011BRGY*</b> A: 4.29" (109.03)	
Tees			<b>HBL2015IV*</b> <b>HBL2015GY*</b> A: 2.56" (65.02)	Tees	<b>Flat Elbow Bend Radius</b> For branches at right angles requiring a 1.5 in. (38.10) bend radius. Suitable for Category 5, 5e, 6 and 6A applications.	Ivory Gray	<b>HBL2011BRIV*</b> <b>HBL2011BRGY*</b> A: 4.29" (109.03)
			<b>Tee Fitting</b> For branches at right angles. Couplings furnished.		Ivory Gray	<b>HBL2015BRIV*</b> <b>HBL2015BRGY*</b> A: 7.35" (186.78) B: 4.33" (110.00)	

Note: \*HBL2001C couplings included.  
\*\*Galvanized Steel.

Dimensions in Inches (mm)

# Metal Raceway HBL2000 and HBL2000A Series Fittings and Tools



	Description	Color	Catalog Number	Description	Color	Catalog Number
End Fittings	<b>Transition Fitting</b> For transitioning from Wiremold® 2000 Raceway to Hubbell HBL2000 Raceway.	Ivory Gray	<b>HBL2000TFIV</b> <b>HBL2000TFGY</b> A: .82" (20.71) B: 1.38" (35.12) C: 2.04" (51.82)	<b>Entrance End Fitting</b> For connecting HBL2000 Raceway with one ½ in. conduit and armored cable connectors.	Ivory Gray	<b>HBL2010A2IV</b> <b>HBL2010A2GY</b> A: 3.01" (76.45) B: 1.30" (33.02) C: 1.49" (37.85)
	<b>Blank End Fitting</b> For closing open end of HBL2000 Raceway.	Ivory Gray	<b>HBL2010BIV</b> <b>HBL2010BGY</b> A: .78" (19.94)	<b>Large Capacity Entrance End Fitting</b> Offers larger capacity than HBL2010A2IV/GY. One ½ in. trade size KO on each side, ½ in. and ¾ in. concentric KOs on end and bottom.	Ivory Gray	<b>HBL2010A3IV</b> <b>HBL2010A3GY</b> A: 3.69" (93.80) B: 2.02" (51.18) C: 1.79" (45.36)
	<b>End Reducing Connector</b> For connecting HBL2000 Raceway to HBL500 Raceway through end of HBL2000 Raceway.	Ivory	<b>HBL2089EIV</b> A: .78" (19.81)	<b>Side Reducing Connector</b> For connecting HBL2000 Raceway to HBL500 Raceway through side of HBL2000 Raceway.	Ivory	<b>HBL2089IV*</b> A: 6.00" (152.40) B: 3.25" (82.55)
Fittings	<b>Cover Clip</b> Use to cover potential openings where two pieces of HBL2000 Raceway cover come together.	Ivory Gray	<b>HBL2006IV</b> <b>HBL2006GY</b> A: .75" (19.05)	<b>Flush Plate Adaptor</b> For feeding HBL2000 Raceway from an existing wall outlet. ½ in. threaded stud with steel locknut for grounding.	Ivory Gray	<b>HBL2051HIV</b> <b>HBL2051HGY</b> A: 4.50" (114.30)
	<b>Wire Clip</b> For holding conductors in place in the raceway base. For use when using the HBL2000CIV/GY cover only.	Steel**	<b>HBL2000WC</b> A: .44" (11.18) B: .24" (6.03) C: 1.24" (31.50)	<b>Wire Clip</b> For holding conductors in place in the raceway base. For use when using the HBL2000CAIV/GY cover only.	Steel**	<b>HBL2000WCA</b> A: .44" (11.18) B: .60" (15.17) C: 1.24" (31.50)
	<b>Coupling</b> For joining lengths of HBL2000 Raceway.	Steel**	<b>HBL2001C</b> A: 2.00" (50.80)	<b>Supporting Clip</b> For temporarily supporting lengths of HBL2000 Raceway at any point. Mount with #6 flat head fastener. Has set screw for locking to raceway. Raceway must be screwed to the wall for secure fastening.	Steel**	<b>HBL2003SC</b> A: 2.00" (50.80)
	<b>Ground Clamp</b> For connection of equipment grounding conductor to provide an additional ground to raceway. Galvanized steel.	Steel**	<b>HBL2009GC</b> A: 1.00" (25.64)			

Note: \*HBL2001C couplings included.  
\*\*Galvanized Steel.

	Description	Catalog Number	Description	Color	Catalog Number
Tools	<b>Cutter</b> Portable cutter for HBL2000 Series Raceway. (Not for use with HBL2000A series).	HBL620C	<b>Touch-Up Paint Pen</b>	Ivory Gray	<b>HBLIWEP</b> <b>HBLGWEP</b>
	<b>Cutter Replacement Blade Set</b>	HBL620BCK			

Wiremold® is a registered trademark of the Wiremold Company.

Dimensions in Inches (mm)

# Metal Raceway Metal PlugTrak®

Metal PlugTrak®, Portable Metal PlugTrak®, Boxes and Fittings



Available in Standard, Isolated Ground (IG) and Tamper-Resistant (TR) versions.

Tamper-Resistant



	Amp	Circuits	# Single Recept.	Receptacle Spacing (in.)	Color	
					Ivory	Gray
3 Foot	15	Single	6	6	HBL20GB306IV	HBL20GB306GY
	15	IG/Single	6	6	HBL20IG306IV	HBL20IG306GY
	15	TR/Single	6	6	HBL20GB306IVTR	HBL20GB306GYTR
	20	Single	6	6	HBL24GB306IV	HBL24GB306GY
	20	TR/Single	6	6	HBL24GB306IVTR	HBL24GB306GYTR
5 Foot	15	Single	10	6	HBL20GB506IV	HBL20GB506GY
	15	Single	5	12	HBL20GB512IV	HBL20GB512GY
	15	Two	5	12	HBL20GBA512IV	HBL20GBA512GY
	15	IG/Single	5	12	HBL20IG512IV	HBL20IG512GY
	15	TR/Single	5	12	HBL20GB512IVTR	HBL20GB512GYTR
	20	Single	10	6	HBL24GB506IV	HBL24GB506GY
	20	Single	5	12	HBL24GB512IV	HBL24GB512GY
	20	Two	5	12	HBL24GBA512IV	HBL24GBA512GY
6 Foot	15	Single	12	6	HBL20GB606IV	HBL20GB606GY
	15	Single	8	9	HBL20GB609IV	HBL20GB609GY
	15	Single	6	12	HBL20GB612IV	HBL20GB612GY
	15	Single	4	18	HBL20GB618IV	HBL20GB618GY
	15	Two	8	9	HBL20GBA609IV	HBL20GBA609GY
	15	Two	6	12	HBL20GBA612IV	HBL20GBA612GY
	15	Two	4	18	HBL20GBA618IV	HBL20GBA618GY
	15	IG/Single	12	6	HBL20IG606IV	HBL20IG606GY
	20	Single	12	6	HBL24GB606IV	HBL24GB606GY
	20	Single	6	12	HBL24GB612IV	HBL24GB612GY
	20	Single	4	18	HBL24GB618IV	HBL24GB618GY
	20	Two	6	12	HBL24GBA612IV	HBL24GBA612GY
	20	Two	4	18	HBL24GBA618IV	HBL24GBA618GY



Portable	Amp	Circuits	Length (in.)	Cord Length (ft.)	# Single Recept.	Color	
						Ivory	Gray
	15	Single	40	6	6	HBL20C215IV	HBL20C215GY
	15	Single	64	6	10	HBL20C315IV	HBL20C315GY

Note: IG = Isolated Ground and TR = Tamper-Resistant.  
Hubbell Metal PlugTrak is supplied with two HBL2010BIV/GY blank end fittings and one HBL2001C coupling. Catalog number suffix "IV" for ivory finish and "GY" for gray finish. Outlets match raceway color. "IG" Isolated ground receptacles are orange color. Portable PlugTrak includes 15A circuit breaker.

	Description	Color	Catalog Number
Boxes	1-Gang Device Box	Ivory Gray	HBL2048IV HBL2048GY
	2-Gang Device Box	Ivory Gray	HBL20482IV HBL20482GY
Elbows and Tees	External Elbow	Ivory Gray	HBL2018CIV HBL2018CGY
	Flat Elbow	Ivory Gray	HBL2011IV HBL2011GY
	Tee	Ivory Gray	HBL2015IV HBL2015GY
End Fittings	Entrance End Fitting	Ivory Gray	HBL2010A2IV HBL2010A2GY
	Large Entrance End Fitting	Ivory Gray	HBL2010A3IV HBL2010A3GY
	Blank End Fitting	Ivory Gray	HBL2010BIV HBL2010BGY
	Cover Clip	Ivory Gray	HBL2006IV HBL2006GY
Fittings	Supporting Clip	Steel**	HBL2003SC*
	Coupling	Steel**	HBL2001C
	Internal Corner Coupling	Steel**	HBL2017TC

Note: \*Support clip HBL2003SC for supporting Portable Metal PlugTrak only.  
\*\*Galvanized Steel.  
See pages R-10 and R-11 for additional information.

## Metal Raceway HBL2400 and HBL2400D Series *Features and Benefits*



### HBL2400 and HBL2400D Raceway

- Increased capacity, more than the HBL2000 Series Raceway.
- Divided base allows for dual services within one raceway profile.



### Bend Radius Fittings

- 1½ in. (38.10) bend radius.
- Ideal for high speed data cables including Category 5, 5e, 6 and 6A applications.



### Innovative Box Design

- Hubbell Handi-Screw® eliminates difficult to install long screws for easier installation.
- Rounded corners eliminate sharp edges.
- One seam construction provides “clean” look.
- Box design allows standard wallplates to be mounted flush with virtually no perimeter profile exposed.
- Full line of metal wallplates available. See page R-45 for selection.

# Metal Raceway

## HBL2400 and HBL2400D Series

Metal Raceway, Device Boxes, Elbows and Tees



HBL2400 Series	<b>Description</b>	<b>Color</b>	<b>Catalog Number</b>
	<b>Undivided Base and Cover</b> Packed 50 ft. (15m) per carton, 5 ft. (1.5m) lengths.	Ivory	<b>HBL2400BCIV</b> A: 60.00" (1,524.00) B: 1.91" (48.51) C: .88" (22.40)

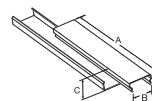

HBL2400 Series Base and Cover	<b>Description</b>	<b>Color</b>	<b>Catalog Number</b>	<b>Description</b>	<b>Color</b>	<b>Catalog Number</b>
	<b>10 Ft. Base, Undivided</b> Packed 100 ft. (30.5m) per carton, 10 ft. (3m) lengths.	Ivory	<b>HBL2400B10IV</b> A: 120.00" (3,048.00) B: 1.91" (48.51)			

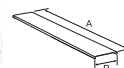
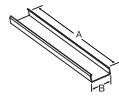

HBL2400D Series Base and Cover	<b>Description</b>	<b>Color</b>	<b>Catalog Number</b>
	<b>10 Ft. Base, Divided</b> Packed 100 ft. (30.5m) per carton, 10 ft. (3m) lengths.	Ivory	<b>HBL2400BDIV</b> A: 120.00" (3,048.00) B: 1.91" (48.51)

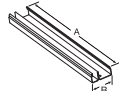

Standard	<b>Description</b>	<b>Color</b>	<b>Type</b>	<b>1-Gang</b>	<b>2-Gang</b>
	<b>Device Box</b> For deep switches and receptacles. Base has one ½ in. trade size KO and rectangular KO for extension to wall box.	Ivory Ivory	Divided Undivided	— <b>HBL2448IV</b> A: 4.54" (115.32) B: 2.82" (71.63) C: 1.75" (44.45)	— <b>HBL24482IV</b> A: 4.54" (115.32) B: 4.64" (117.86) C: 1.75" (44.45)

Extra Deep	<b>Description</b>	<b>Color</b>	<b>Type</b>	<b>1-Gang</b>	<b>2-Gang</b>
	<b>Device Box</b> For deep switches and receptacles. Base has one ½ in. trade size KO and rectangular KO for extension to wall box (undivided box pictured).	Ivory Ivory	Divided Undivided	<b>HBL2444DIV</b> <b>HBL2444IV</b> A: 4.54" (115.32) B: 2.82" (71.63) C: 2.75" (69.85)	<b>HBL2444D2AIV</b> <b>HBL24442IV</b> A: 4.54" (115.32) B: 4.64" (117.86) C: 2.75" (69.85)

Elbows and Tees	<b>Description</b>	<b>Color</b>	<b>Type</b>	<b>Catalog Number</b>	<b>Description</b>	<b>Color</b>	<b>Type</b>	<b>Catalog Number</b>
	<b>Internal Elbow Bend Radius</b> For inside surfaces at right angles, requiring a 1.5 in. (38.10) bend radius. Suitable for Category 5, 5e, 6 and 6A applications.	Ivory	Divided	<b>HBL2417DFOIV*</b>	<b>External Elbow Bend Radius</b> For right angle turns around external corners. Suitable for Category 5, 5e, 6 and 6A applications.	Ivory	Divided	<b>HBL2418DFOIV*</b>
		Ivory	Undivided	<b>HBL2417IV**</b> A: 1.91" (48.51) B: 3.60" (91.30)		Ivory	Undivided	<b>HBL2418IV**</b> A: 1.91" (48.51) B: 3.83" (97.28)
	<b>90° Flat Elbow Bend Radius</b> For right angle turns on same surface. Suitable for Category 5, 5e, 6 and 6A applications.	Ivory	Divided	<b>HBL2411DFOIV*</b>	<b>Tee Fitting Bend Radius</b> For branches at right angles. Suitable for Category 5, 5e, 6 and 6A applications.	Ivory	Divided	<b>HBL2415DFOIV*</b>
Ivory		Undivided	<b>HBL2411IV**</b> A: 6.00" (152.40) B: 5.00" (127.00) C: .90" (22.86)	Ivory		Undivided	<b>HBL2415IV**</b> A: 7.30" (185.42) B: 4.99" (126.75) C: 1.44" (36.58)	

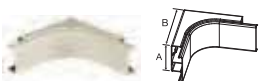







Note: \*HBL2401DC couplings included.  
\*\*HBL2401C couplings included.



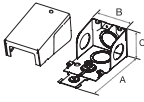

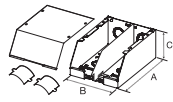





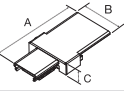

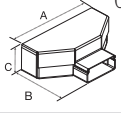

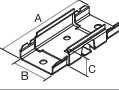

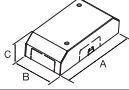

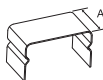
Dimensions in Inches (mm)

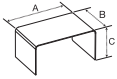

# Metal Raceway HBL2400 and HBL2400D Series Fittings









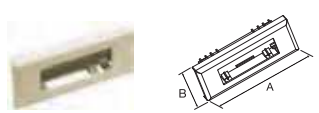
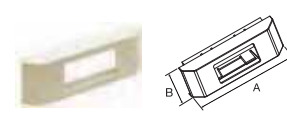

	Description	Color	Type	Catalog Number	Description	Color	Type	Catalog Number	
End Fittings	<b>Entrance End Fitting</b> End fitting with ½ in. and ¾ in. concentric trade size KO's on end and bottom. Additional ½ in. trade size KO's on sides.	Ivory Ivory	Divided Undivided	— <b>HBL2410CIV</b> A: 3.69" (93.8) B: 2.02" (51.2) C: 1.79" (45.4)	<b>Entrance End Fitting Bend Radius</b> Divided, bend radius end fitting to feed HBL2400 and HBL2400D Series Raceway. Includes 1 in. and ¾ in. trade size KO's on back and end. Removable divider and bend radius inserts included.	Ivory Ivory	Divided Undivided	<b>HBL2410DFOIV</b> — A: 7.08" (179.83) B: 4.72" (119.89) C: 2.76" (70.10)	
	 	<b>Entrance End Fitting</b> For connecting HBL2400 Raceway with one ½ in. conduit and armored cable connectors.	Ivory Ivory	Divided Undivided	— <b>HBL2410AIV</b> A: 1.16" (29.50) B: 1.89" (49.00) C: 1.66" (42.20)	<b>Entrance End Fitting Full Capacity</b> Full capacity entrance end to feed HBL2400 Series Raceway. Includes three 1 in. and ¾ in. concentric trade size KO's.	Ivory Ivory	Divided Undivided	— <b>HBL2410FCIV</b> A: 3.04" (77.23) B: 2.61" (66.29) C: 2.23" (56.64)
	 	<b>Transition Fitting</b> For transitioning from Wiremold® 2400D/2400 Raceway to Hubbell HBL2400/HBL2400D Raceway.	Ivory Ivory	Divided Undivided	<b>HBL2400DTFIV</b> <b>HBL2400TFIV</b> A: 2.02" (51.31) B: 1.06" (26.92)	<b>Blank End Fitting</b> For closing open end of HBL2400 Raceway.	Ivory Ivory	Divided Undivided	<b>HBL2410BDIV</b> <b>HBL2410BIV</b> A: 1.17" (29.72) B: 1.96" (49.78) C: .84" (21.34)
 	 								

	Description	Color	Catalog Number	Description	Color	Catalog Number		
Fittings	<b>End Reducing Connector</b> For connecting HBL2400 Raceway to HBL2000 Raceway through end of HBL2400 Raceway.	Ivory	<b>HBL2420REDIV*</b> A: 3.81" (96.77) B: 2.07" (52.58) C: .90" (22.86)	<b>End Reducing Connector</b> For connecting HBL4750 Raceway to HBL2400 Raceway through end of HBL4750 Raceway. Includes HBL2401DC coupling (HBL4751AC not included).	Ivory	<b>HBL4724REDIV</b> A: 4.75" (120.65) B: 3.00" (76.20) C: 1.55" (39.37)		
	 	 	<b>Side Reducing Connector</b> For connecting HBL2400 Raceway to HBL500 Raceway through side of HBL2400 Raceway.	Ivory	<b>HBL2489IV*</b> A: 3.75" (95.25) B: 1.91" (48.51) C: .82" (20.83)	<b>Bridge Fitting</b> For allowing HBL2400 Series Raceway to bridge over existing installations of HBL2400, HBL750 and HBL500 Series Raceways.	Ivory	<b>HBL2475DBRIV</b> A: 5.60" (142.24) B: 2.92" (74.17) C: 1.63" (41.40)
	 	 	<b>Cover Clip</b> Use to cover potential openings where two pieces of HBL2400 Raceway cover come together.	Ivory	<b>HBL2406IV</b> A: 1.50" (38.10)	<b>Flush Plate Adaptor</b> For feeding HBL2400 Raceway from an existing wall outlet box ½ in. trade size male nipple. Provided with locknut for grounding.	Ivory	<b>HBL2451HIV*</b> A: 4.50" (114.30)
	 	 	<b>Wire Clip (Plated)</b> For holding conductors in place.	Steel**	<b>HBL2400WC</b> A: 1.69" (42.93) B: 1.00" (25.40) C: .79" (20.00)	<b>Ground Clamp (Plated)</b> For connection of equipment grounding conductor to provide an additional ground to raceway.	Steel**	<b>HBL2409GC</b> A: .41" (10.41)
	 	 	<b>Coupling (Plated), Divided</b> For joining lengths of HBL2400 Raceway.	Steel**	<b>HBL2401DC</b> A: 2.00" (50.80) B: 1.86" (47.24)	<b>Coupling (Plated), Undivided</b> For joining lengths of HBL2400 Raceway.	Steel**	<b>HBL2401C</b> A: 2.00" (50.80) B: 1.86" (47.24)
	 	 						

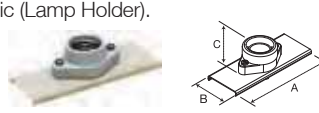

Note: \*Only used on HBL2400 Series Undivided Raceway.  
\*\*Galvanized Steel.

Wiremold® is a registered trademark of the Wiremold Company.

Dimensions in Inches (mm)

Devices and Frames	Description	Color	Catalog Number	Description	Color	Catalog Number	
	<b>Duplex Receptacle Frame</b> Use this frame in conjunction with duplex receptacles below.	Ivory	<b>HBL24DRK*</b> A: 5.26" (133.60) B: 2.00" (50.80)		<b>Duplex Bracket and Frame</b> Use in low voltage applications with BR106AL and Q106AL frames found on page R-45.	Ivory	<b>HBL24106DRK*</b> A: 6.00" (152.40) B: 2.02" (51.31)
	<b>Receptacle Bracket and Frame</b> Use in low voltage applications with ISFxxAL frames found on page R-45.	Ivory	<b>HBL24106RRK*</b> A: 6.00" (152.40) B: 2.02" (51.31)		<b>Single Receptacle Frame</b> Use this frame in conjunction with single receptacles below.	Ivory	<b>HBL24SRK*</b> A: 3.26" (82.80) B: 2.00" (50.80)
	<b>Duplex Receptacle</b> 15A, 125V 15A, 125V Isolated Ground 20A, 125V 20A, 125V Isolated Ground #12 AWG THHN stranded copper wires with 20 in. leads on each end.	Ivory Orange Ivory Orange	<b>PT2RC*</b> <b>PT2RCIG*</b> <b>PT2R*</b> <b>PT2RIG*</b> A: 4.00" (101.60) B: 1.24" (31.50) C: .84" (21.34)		<b>Single Receptacle</b> 15A, 125V 15A, 125V Isolated Ground 15A, 125V Tamper-Resistant 15A, 125V Tamper-Resistant 20A, 125V 20A, 125V Isolated Ground 20A, 125V Tamper-Resistant 20A, 125V Tamper-Resistant #12 AWG THHN stranded copper wires with 21 in. leads on each end.	Ivory Orange Ivory Gray Ivory Orange Ivory Gray	<b>PT1RCIV*</b> <b>PT1RCIG*</b> <b>PT15RIVTR*</b>  <b>PT15RGYTR*</b>  <b>PT1RIV*</b> <b>PT1RIG*</b> <b>PT20RIVTR*</b>  <b>PT20RGYTR*</b>  A: 2.00" (50.80) B: 1.20" (30.48) C: .87" (22.10)
	<b>Lamp Holder</b> Medium base lamp holder 660W 250V ceramic. Ivory (Cover) White Ceramic (Lamp Holder).	Ivory	<b>HBL2426IV*</b> A: 5.00" (127.00) B: 1.89" (48.01) C: 1.03" (26.16)				

Note: \*Only used on HBL2400 Series Undivided Raceway.

Tools	Description	Catalog Number	Description	Color	Catalog Number
	<b>Cutter</b> Portable cutter for HBL2400/ HBL2400D Series Raceway.		<b>HBL624CUT</b>	<b>Touch-Up Paint Pen</b> 	Ivory
<b>Cutter Replacement Blade Set</b>		<b>HBL624BCK</b>			

Dimensions in Inches (mm)

# Metal Raceway HBL3000 Series

Features and Benefits



## Extensive Line

- Full line of large, single channel, two piece metal raceway.
- Easily mounts on walls or bench tops.
- Large single channel base for power or datacom cables.
- UL Listed and CSA Certified.
- Available in ivory or gray powder coat finish.



## Plates and Covers

- Wide range of covers and cover plates accommodate the most demanding applications.
- Removable cover and cover plates provide easy access to wiring compartment.
- Precut covers and plates provide quick installation and are available in common configurations.

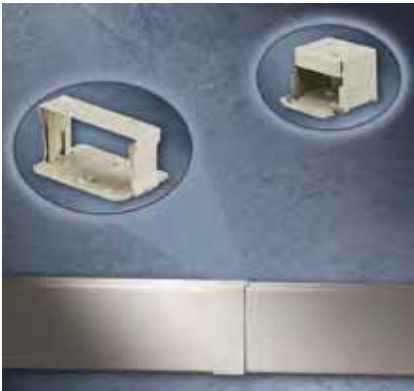

## Transition Fittings

- UL Classified to transition from Wiremold® 3000 Series Metal Raceway to Hubbell HBL3000 Series Metal Raceway.
- Reducer fitting provides transition from Hubbell HBL3000 Series to Hubbell HBL2000 Series Raceway.

*Wiremold® 3000 Series to Hubbell HBL3000 Series utilizing Hubbell transition fitting.*



## Boxes

- Hubbell Handi-Screw® eliminates “difficult-to-install” long screws for faster mounting.
- Rounded corners eliminate sharp edges.
- One seam construction provides “clean” look.
- Large capacity allows for the installation of 30, 50 or 60A receptacles.
- Utility box can be used as a tee, cross, junction box or as a branch circuit extension.

*Wiremold® is a registered trademark of the Wiremold Company.*

# Metal Raceway HBL3000 Series

Metal Raceway, Device Boxes, Elbows and Tees



Available in  
**PRE-WIRED**

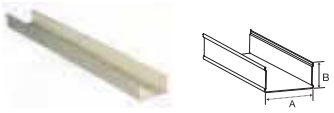



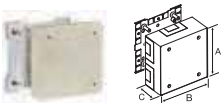



HBL3000 Series	Description	Color	Catalog Number	Description	Color	Catalog Number
	<b>Single Channel Base</b> Packed 100 ft. (30.5m) per carton, 10 ft. (3m) lengths.  Assembled cover and base dimensions. W: 2.75" (69.85) H: 1.53" (38.86)	Ivory Gray	<b>HBL3000BIV</b> <b>HBL3000BGY</b> A: 2.73" (69.34) B: 1.47" (37.34)		<b>5 Ft. Cover</b> Packed 100 ft. (30.5m) per carton, 5 ft. (1.5m) lengths.  <b>19.5 In. Precut Cover*</b> For mounting devices on 24 in. (610.00) centers.  <b>7.5 In. Precut Cover*</b> For mounting devices on 12 in. (305.00) centers.	Ivory Gray







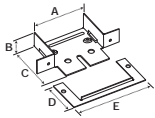







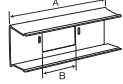

Note: \*Packed 10 pieces per carton. Device centers vary based on cover selection. Consult factory for details.

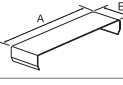
Boxes	Description	Color	Catalog Number	Description	Color	Catalog Number
	<b>Utility Box</b> Cover has twistouts on all sides, allows for box to be used as tee, cross, junction box or for branch circuit extensions.	Ivory Gray	<b>HBL3028IV</b> <b>HBL3028GY</b> A: 6.41" (162.89) B: 6.41" (162.89) C: 1.90" (48.26)		<b>2-Gang Extra Deep Switch and Receptacle Box</b> For standard 30, 50 and 60A straight blade receptacles.	Ivory Gray

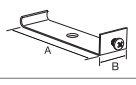
Elbows and Tees	Description	Color	Catalog Number	Description	Color	Catalog Number
	<b>Internal Corner Coupling</b> For surfaces at right angles or for use as a straight-through fitting.	Ivory Gray	<b>HBL3017TCEIV</b> <b>HBL3017TCEGY</b> A: 2.61" (66.29)		<b>External Corner Coupling</b> For right angle turns around external corners.	Ivory Gray
<b>90° Flat Elbow</b> For right angle turns on same surface.	Ivory Gray	<b>HBL3011EIV</b> <b>HBL3011EGY</b> A: 6.40" (162.40) B: 6.00" (152.40)		<b>Tee Fitting</b> For branches at right angles. Couplings furnished.	Ivory Gray	<b>HBL3015EIV</b> <b>HBL3015EGY</b> A: 10.31" (261.94) B: 8.00" (203.20)

Dimensions in Inches (mm)

End Fittings	Description	Color	Catalog Number	Description	Color	Catalog Number		
	<b>Entrance End Fitting</b> For connecting HBL3000 Raceway with ½ in. conduit and armored cable connectors.	Ivory Gray	<b>HBL3010AEIV</b> <b>HBL3010AEGY</b>	A: 2.75" (69.85) B: 3.42" (86.87)	<b>Entrance End Fitting</b> For connecting HBL3000 Raceway with rigid or flexible conduit. Concentric ½ in., ¾ in. and 1 in. trade size KOs on end and each side.	Ivory Gray	<b>HBL3010CIV</b> <b>HBL3010CGY</b>	A: 2.75" (69.85) B: 3.25" (82.55) C: 2.00" (50.80)
	 				 			
	<b>Blank End Fitting</b> For closing open end of HBL3000 Raceway. Has concentric ½ in. and ¾ in. trade size KOs.	Ivory Gray	<b>HBL3010BIV</b> <b>HBL3010BGY</b>	A: 2.71" (68.92) B: 1.79" (45.36) C: 1.41" (35.84)	<b>Panel Connector</b> To connect HBL3000 Raceway with surface type boxes.	Ivory Gray	<b>HBL3086IV</b> <b>HBL3086GY</b>	A: 4.60" (116.71) B: 1.19" (30.16) C: 3.00" (76.20) D: 1.94" (49.40) E: 3.76" (95.50)
 				 				
<b>Conduit Connector</b> To connect end of HBL3000 Raceway to 1½ in. trade size conduit or connector.	Gray	<b>HBL3082GY</b>	A: 2.91" (74.00) B: 2.75" (69.85)					
 								

Fittings	Description	Color	Catalog Number	Description	Color	Catalog Number		
	<b>Transition Fitting</b> For transitioning from Wiremold® 3000 Raceway to Hubbell HBL3000 Raceway.	Ivory Gray	<b>HBL3000TFIV</b> <b>HBL3000TFGY</b>	A: 2.85" (72.39) B: 2.15" (54.61) C: 1.50" (38.04)	<b>Take-Off Connector (Reducer)</b> Transition Hubbell HBL3000 Raceway to Hubbell HBL2000 Raceway.	Ivory Gray	<b>HBL3200REDIV</b> <b>HBL3200REDGY</b>	A: 2.75" (69.85) B: 2.25" (57.15)
	 				 			
	<b>Wall Box Connector</b> For connecting to HBL3000 Raceway from a flush mounted wall box.	Ivory Gray	<b>HBL3014CIV</b> <b>HBL3014CGY</b>	A: 8.00" (203.20) B: 3.28" (83.31)	<b>Tap-Off Fitting</b> Has concentric ½ in. and ¾ in. trade size KOs and twistout for communication cables.	Ivory Gray	<b>HBL3046H2IV</b> <b>HBL3046H2GY</b>	A: 4.75" (120.65)
	 				 			
	<b>Cover Clip</b> Use to cover potential openings where two pieces of HBL3000 Raceway come together.	Ivory Gray	<b>HBL3006EIV</b> <b>HBL3006EGY</b>	A: 2.78" (70.60) B: .75" (19.05)	<b>Supporting Clip</b> For supporting lengths of HBL3000 Raceway at any point. Mount with #8 flat head fastener. Has set screw for locking to raceway.	Ivory Gray	<b>HBL3003IV</b> <b>HBL3003GY</b>	A: 2.81" (71.33) B: .75" (19.05)
	 				 			
	<b>Wire Clip (Plated)</b> For holding conductors in place.	Steel*	<b>HBL3000WCGY</b>	A: 1.00" (25.40)	<b>Rigid Inside Coupling (Plated)</b> For joining lengths of HBL3000 Raceway when added rigidity is required, i.e. raceway suspended overhead.	Steel*	<b>HBL3001AGY</b>	A: 6.00" (152.40)
 				 				
<b>Coupling (Plated)</b> For joining lengths of HBL3000 Raceway.	Steel*	<b>HBL3001GY</b>	A: 2.20" (55.75)					
 								

Note: \*Galvanized Steel.

Wiremold® is a registered trademark of the Wiremold Company.

Dimensions in Inches (mm)

Device Bracket and Cover Plates	Description	Color	Catalog Number	Description	Color	Catalog Number		
	<b>Switch Cover</b> For installing single pole, two pole, three way or four way switches. Includes HBL3007CGY device bracket.	Ivory Gray	<b>HBL3040CEIV</b> <b>HBL3040CEGY</b>	A: 4.50" (114.30)	<b>Rectangular Style Line® Recept. Cover</b> For installing 15A and 20A rectangular duplex receptacles, GFCI, surge devices, and rectangular communication frames shown on page R-45. Includes HBL3007CGY device bracket.	Ivory Gray	<b>HBL3048RIV</b> <b>HBL3048RGY</b>	A: 4.50" (114.30)
	<b>Duplex Receptacle Cover</b> For installing 15A and 20A duplex receptacles and duplex communication frames shown on page R-45. Includes HBL3007CGY device bracket.	Ivory Gray	<b>HBL3043BEIV</b> <b>HBL3043BEGY</b>	A: 4.50" (114.30)	<b>Duplex Receptacle Cover</b> For high strain/vibration. For installing 15A and 20A duplex receptacles and duplex communication frames shown on page R-45. Includes device brackets.	Ivory Gray	<b>HBL3046BEIV</b> <b>HBL3046BEGY</b>	A: 5.38" (136.65)
	<b>Single Receptacle Cover</b> For installing straight blade and locking single receptacles with face diameters of 1.38 in. to 1.39 in. (35.05 to 35.31). Includes HBL3007CGY device bracket.	Ivory Gray	<b>HBL3027AEIV</b> <b>HBL3027AEGY</b>	A: 4.50" (114.30)	<b>Single Receptacle Cover</b> For installing straight blade and locking single receptacles with face diameters of 1.56 in. to 1.57 in. (39.62 to 39.88). Includes HBL3007CGY device bracket.	Ivory Gray	<b>HBL3033JEIV</b> <b>HBL3033JEGY</b>	A: 4.50" (114.30)
	<b>Blank Cover</b> Has one ½ in. trade size KO in center. Includes HBL3007CGY bracket.	Ivory Gray	<b>HBL3036HEIV</b> <b>HBL3036HEGY</b>	A: 4.50" (114.30)	<b>Extension Cover</b> Cover accepts 3-wire 30A and 50A devices and standard commercially available flush plates. Includes HBL3007CGY device bracket. See page R-45 for plate options.	Ivory Gray	<b>HBL3051LEIV</b> <b>HBL3051LEGY</b>	A: 4.50" (114.30)
	<b>Device Bracket</b> For mounting standard devices in HBL3000 Raceway. Use with commercially available flush plate (not furnished).	Steel*	<b>HBL3007CGY</b>	A: 4.50" (114.30) B: 3.28" (83.31)				

Note: \*Galvanized Steel.

Tools	Description	Color	Catalog Number	Description	Catalog Number	
	<b>Base Cutter</b> Portable cutter for HBL3000 Raceway Base.			<b>HBL630B</b>	<b>Cover Cutter</b> Portable cutter for HBL3000 Raceway Cover.	<b>HBL630C</b>
	<b>Replacement Blade Cutter and Die Set</b> Base blade set.			<b>HBL630BDK</b>	<b>Replacement Blade Cutter and Die Set</b> Cover blade set.	<b>HBL630CDK</b>
<b>Touch-Up Paint Pen</b>	Ivory Gray	<b>HBLIWEP</b> <b>HBLGWEP</b>				

Dimensions in Inches (mm)

## Metal Raceway HBL4750 Series *Features and Benefits*



### HBL4750 Device Bracket

- HBL4750 Device Bracket Plate provides excellent solution for power, data, voice, audio and video applications.
- For use with Hubbell KP plates and Hubbell iSTATION modules and bezels.
- Provides flush finish with overlap feature to hide potential miscuts.



### Application Capacity and Flexibility

- Flexible channel divider provides industry leading data capacity in the same profile with a 2/3 datacom split.
- By-Pass Divider opening accepts GFCI or surge devices to be mounted in 70/30 divided channel.
- Greater capacity offers more room for moves, adds and changes.
- 50/50 split available by utilizing standard divider and divider clips.
- Raceway channel can also be used with no divider for maximum cable fill in single service applications.





### End Reducing Connector

- Connects HBL4750 Raceway to HBL2400 Raceway through the end of HBL4750 Raceway.
- Used to connect two different sized raceway profiles.





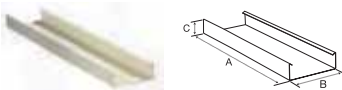

### Extensive Line

- 1¼ in. (31.75mm) bend radius fittings meet TIA/EIA requirements.
- Integral bend radius offers a fixed solution that does not have to be installed as an option.
- Large cross sectional area provides for maximum cable capacity throughout entire system.
- Available external, internal, flat, tee and entrance end fittings.
- UL Listed, CSA Certified.
- Available in ivory or gray powder coat finish.

HBL4750 Series	Description	Color	Catalog Number	Description	Color	Catalog Number
	<p><b>Single Channel Base</b>                      Packed 50 ft. (15.24m) per carton, 10 ft. (3m) lengths.</p> <p>Assembled cover and base dimensions.                      W: 4.75" (120.65)                      H: 1.75" (44.45)</p> 	Ivory Gray	<b>HBL4750B10IV</b> <b>HBL4750B10GY</b> A: 120.00" (3048.00) B: 4.75" (120.65) C: 1.62" (41.20)	<p><b>5 Ft. Cover</b>                      Packed 50 ft. (15.24m) per carton, 5 ft. (1.5m) lengths.</p> <p><b>31.5 In. Precut Cover*</b>                      For 36 in. (915.00) centers with HBL4747 and HBL4750 Plates.</p> <p><b>19.5 In. Precut Cover*</b>                      For 24 in. (610.00) centers with HBL4747 and HBL4750 Plates.</p> <p><b>13.5 In. Precut Cover*</b>                      For 18 in. (457.00) centers with HBL4747 and HBL4750 Plates.</p> <p><b>7.5 In. Precut Cover*</b>                      For 12 in. (305.00) centers with HBL4747 and HBL4750 Plates.</p> 	Ivory Gray	<b>HBL4750CIV</b> <b>HBL4750CGY</b> A: 60.00" (1,524.0) B: 4.75" (120.65)
						<b>HBL4750C315IV</b> <b>HBL4750C315GY</b> A: 31.50" (800.10) B: 4.75" (120.65)
						<b>HBL4750C195IV</b> <b>HBL4750C195GY</b> A: 19.50" (495.30) B: 4.75" (120.65)
						<b>HBL4750C135IV</b> <b>HBL4750C135GY</b> A: 13.50" (342.90) B: 4.75" (120.65)
						<b>HBL4750C075IV</b> <b>HBL4750C075GY</b> A: 7.50" (190.50) B: 4.75" (120.65)

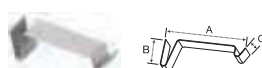
Note: \*Packed 10 pieces per carton. Device centers vary based on cover selection. Consult factory for details.

Fittings	Description	Color	Catalog Number	Description	Color	Catalog Number
	<p><b>Divider</b>                      Divides HBL4750 Raceway into two channels. Packed 50 ft. (15.24m) per carton, 5 ft. (1.5m) lengths. HBL4751DA Divider Clips are required to hold divider in place.</p> 	Painted Steel	<b>HBL4750DGY</b> A: 60.00" (1,524.0) B: 1.51" (38.46)	<p><b>By-Pass Divider</b>                      Divides HBL4750 Raceway into two channels with a 70/30 split. Allows for a larger power or datacom wire fill. HBL4751DA Divider Clips are required to hold divider in place.</p> 	Painted Steel	<b>HBL4750BP</b> A: 7.12" (180.74) B: .89" (22.54)
	<p><b>Divider Clip</b>                      Required for holding HBL4750DGY in place. Use one every 2.5 ft. (.762m).</p> 	Steel**	<b>HBL4751DA</b> A: 4.64" (117.77) B: 1.46" (37.07)	<p><b>Wire Clip (Plated)</b>                      For holding conductors in place.</p> 	Steel**	<b>HBL4750WCGY</b> A: 4.60" (116.74) B: 1.58" (40.13) C: 1.00" (25.40)
	<p><b>Internal Corner Coupling (Plated)</b>                      Concealed fitting for making an internal corner while continuing original run in a straight line.</p> 	Steel**	<b>HBL4717TCAGY</b> A: 4.59" (116.59) B: 2.71" (68.73) C: 1.47" (37.34)	<p><b>Coupling (Plated)</b>                      For joining lengths of HBL4750 Raceway. Sold in pairs.</p> 	Steel**	<b>HBL4751AC</b> A: 1.47" (37.30) B: .42" (10.59)

Note: \*\*Galvanized Steel.

Dimensions in Inches (mm)









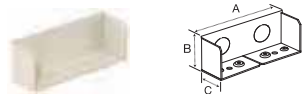

Elbows	Description	Color	Catalog Number	Description	Color	Catalog Number
	<b>Internal Elbow, Divided</b> For inside surfaces at right angles. Full capacity 1¼ in. bend radius internal elbow.	Ivory Gray	<b>HBL4717DFOIV*</b> <b>HBL4717DFOGY*</b> A: 4.74" (120.47) B: 4.75" (120.65)	<b>Internal Elbow, Undivided</b> For inside surfaces at right angles.	Ivory Gray	<b>HBL4717IV*</b> <b>HBL4717GY*</b> A: 4.74" (120.47) B: 4.75" (120.65)
	<b>External Elbow, Divided</b> For right angle turns around external corners. Full capacity 1¼ in. bend radius external elbow.	Ivory Gray	<b>HBL4718DFOIV*</b> <b>HBL4718DFOGY*</b> A: 4.88" (123.90) B: 4.75" (120.65)	<b>External Elbow, Undivided</b> For right angle turns around external corners.	Ivory Gray	<b>HBL4718IV*</b> <b>HBL4718GY*</b> A: 4.88" (123.90) B: 4.75" (120.65)
	<b>Flat Elbow, Divided</b> For right angle turns on same surface. Full capacity 1¼ in. bend radius flat elbow.	Ivory Gray	<b>HBL4711DFOIV*</b> <b>HBL4711DFOGY*</b> A: 7.23" (183.76) B: 1.62" (41.15)	<b>Flat Elbow, Undivided</b> For right angle turns on same surface.	Ivory Gray	<b>HBL4711IV*</b> <b>HBL4711GY*</b> A: 7.23" (183.76) B: 1.62" (41.15)
<b>Internal or External 45° Elbow</b> For making internal or external turns in a run of HBL4750 Raceway.	Ivory Gray	<b>HBL4712TXIV</b> <b>HBL4712TXGY</b> A: 6.04" (153.45) B: 4.59" (116.59)	<b>Inverted Internal Elbow</b> For connecting a vertical run of HBL4750 Raceway with a horizontal run.	Ivory Gray	<b>HBL4717NIV</b> <b>HBL4717NGY</b> A: 4.60" (116.84) B: 1.66" (42.29)	

Tees	Description	Color	Catalog Number	Description	Color	Catalog Number
	<b>Tee Fitting, Divided</b> For branches at right angles. Full capacity 1¼ in. bend radius tee fitting.	Ivory Gray	<b>HBL4715DFOIV*</b> <b>HBL4715DFOGY*</b> A: 10.93" (277.63) B: 7.27" (184.54) C: 1.62" (41.15)	<b>Tee Fitting, Undivided</b> For branches at right angles.	Ivory Gray	<b>HBL4715IV*</b> <b>HBL4715GY*</b> A: 10.93" (277.63) B: 7.27" (184.54) C: 1.62" (41.15)

Note: \*HBL4751AC couplings included.

Dimensions in Inches (mm)

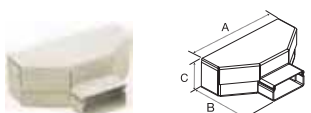
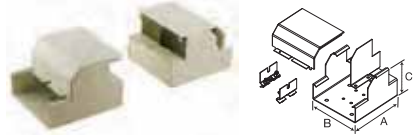
End Fittings	Description	Color	Catalog Number	Description	Color	Catalog Number	
	<p><b>Entrance End Fitting, Divided</b> For connecting HBL4750 Raceway with rigid or flexible conduit. Concentric ¼ in., 1 in. and 1¼ in. trade size KOs on back and end. Full capacity 1¼ in. bend radius entrance end fitting. Includes ¾ in., 1 in., 1¼ in. KO and removable divider.</p> 	Ivory Gray	<b>HBL4710DFOIV*</b> <b>HBL4710DFOGY*</b>	A: 6.76" (171.70) B: 4.75" (120.65) C: 2.66" (67.50)	<p><b>Entrance End Fitting, Undivided</b> For connecting HBL4750 Raceway with rigid or flexible conduit. Concentric ¼ in., 1 in. and 1¼ in. trade size KOs on back and end.</p> 	Ivory Gray	<b>HBL4710IV*</b> <b>HBL4710GY*</b>
<p><b>Blank End Fitting</b> For closing open end of HBL4750 Raceway. Has two ½ in. trade size KOs.</p> 	Ivory Gray	<b>HBL4710BIV</b> <b>HBL4710BGY</b>	A: 4.59" (116.50) B: 1.64" (41.60) C: 1.31" (33.37)	<p><b>Panel Connector</b> To connect HBL4750 Raceway with surface type panel boxes.</p> 	Ivory Gray	<b>HBL4786AIV</b> <b>HBL4786AGY</b>	A: 7.50" (190.50)

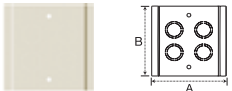
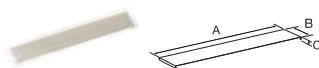
Fittings	Description	Color	Catalog Number	Description	Color	Catalog Number		
	<p><b>Transition Fitting</b> For transitioning Wiremold® 4000 Raceway to Hubbell HBL4750 Raceway.</p> 	Ivory Gray	<b>HBL4750TFIV</b> <b>HBL4750TFGY</b>	A: 4.02" (127.53) B: 2.79" (70.78)	<p><b>Wall Box Connector</b> For back feeding HBL4750 Raceway.</p> 	Ivory Gray	<b>HBL4714AIV</b> <b>HBL4714AGY</b>	A: 12.00" (304.80) B: 4.75" (120.65) C: 1.62" (41.15)
	<p><b>End Reducing Connector</b> For connecting HBL4750 Raceway to HBL2400 Raceway through the end of HBL4750 Raceway. Includes HBL2401DC coupling (HBL4751AC not included).</p> 	Ivory Gray	<b>HBL4724REDIV</b>	A: 4.75" (120.65) B: 3.00" (76.20) C: 1.55" (39.37)	<p><b>Bridge Fitting</b> To bridge HBL4750 series raceway over perpendicular run of raceway or other obstruction. Use standard raceway base and cover, cut in field to required length. Consists of two bridge pieces.</p> 	Ivory Gray	<b>HBL4775DKITIV</b> <b>HBL4775DKITGY</b>	A: 4.76" (120.90) B: 5.00" (127.00) C: 3.38" (85.85)
	<p><b>Take-Off Connector (HBL4750 To HBL3000)</b> For 90° tee connection of HBL3000 Raceway from HBL4750 Raceway.</p> 	Ivory Gray	<b>HBL4774AIV</b> <b>HBL4774AGY</b>	A: 11.31" (287.38) B: 4.88" (124.00) C: 3.14" (79.78)	<p><b>2-Gang Tap-Off Fitting</b> Has four concentric ½ in. and ¾ in. trade size KOs.</p> 	Ivory Gray	<b>HBL4746H2IV</b> <b>HBL4746H2GY</b>	A: 4.75" (120.65) B: 4.75" (120.65)
	<p><b>Connection Cover</b> For covering potential openings where two covers come together.</p> 	Ivory Gray	<b>HBL4756AIV</b> <b>HBL4756AGY</b>	A: 4.77" (121.16) B: .75" (19.05) C: .13" (3.36)				

Note: \*HBL4751AC couplings included.











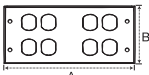

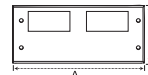
Wiremold® is a registered trademark of the Wiremold Company.

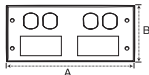

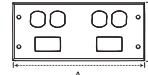
Dimensions in Inches (mm)

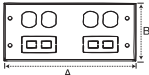
	Description	Color	Catalog Number	Description	Color	Catalog Number
Device Plates and Mounting Bracket	<b>1-Gang Commercial Device Plate Vertical Mount</b> Use with commercially available 1-gang flush plates. See page R-45 for plate options. For single service applications only.	Ivory Gray	<b>HBL4747CVMIV</b> <b>HBL4747CVMGY</b> A: 2.50" (63.50) B: 4.75" (120.65)	<b>2-Gang Commercial Device Plate Vertical Mount</b> Use with commercially available 2-gang flush plates. See page R-45 for plate options. For single service applications only.	Ivory Gray	<b>HBL4747CVM2IV</b> <b>HBL4747CVM2GY</b> A: 4.32" (109.86) B: 4.75" (120.65)
	<b>2-Gang, One Opening for 1-Gang Comm. Device Plate, One Blank</b> Use with commercially available 1-gang flush plates. See page R-45 for plate options.	Ivory Gray	<b>HBL4747C1IV</b> <b>HBL4747C1GY</b> A: 5.12" (130.18) B: 4.75" (120.65)	<b>2-Gang, One Opening for 2-Gang Commercial Device Plate</b> Use with commercially available 2-gang flush plates. See page R-45 for plate options.	Ivory Gray	<b>HBL4747C2IV</b> <b>HBL4747C2GY</b> A: 5.12" (130.18) B: 4.75" (120.65)
	<b>Device Mounting Bracket</b> Mounting bracket for mounting Hubbell KP Plates, iSTATION Modules and Bezels. See pages R-45 and R-46 for datacom product selection.	Ivory Gray	<b>HBL4750IV</b> <b>HBL4750GY</b> A: 5.25" (133.35) B: 4.76" (120.90)			
2-Gang Cover Plates (Include Mounting Bracket)	<b>2-Gang Cover, Single Round Opening, One Blank</b> For single receptacle with face diameter of 1.38 in. to 1.39 in. (35.00 to 36.00).	Ivory Gray	<b>HBL4747AXIV</b> <b>HBL4747AXGY</b> A: 5.43" (137.97) B: 4.75" (120.65)	<b>2-Gang, Single Round Opening, One Blank</b> For single receptacle with face diameter of 1.56 in. to 1.58 in. (39.62 to 40.13).	Ivory Gray	<b>HBL4747JXIV</b> <b>HBL4747JXGY</b> A: 5.43" (137.97) B: 4.75" (120.65)
	<b>2-Gang, One Duplex Opening, One Blank</b> For 15A and 20A duplex receptacles and duplex communication frames shown on page R-45.	Ivory Gray	<b>HBL4747BXIV</b> <b>HBL4747BXGY</b> A: 5.43" (137.97) B: 4.75" (120.65)	<b>2-Gang, One Style Line® Opening, One Blank</b> For Style Line rectangular receptacles, GFCI and surge devices and rectangular communication frames shown on page R-45.	Ivory Gray	<b>HBL4747RXIV</b> <b>HBL4747RXGY</b> A: 5.43" (137.97) B: 4.75" (120.65)
	<b>2-Gang, Two Duplex Openings</b> For 15A and 20A duplex receptacles and duplex communication frames shown on page R-45.	Ivory Gray	<b>HBL4747BBIV</b> <b>HBL4747BBGY</b> A: 5.43" (137.97) B: 4.75" (120.65)	<b>2-Gang, One Style Line® Opening, One Modular Furniture</b> For Style Line rectangular receptacles, GFCI, surge devices and rectangular communication frames shown on page R-45. Includes modular furniture with two keystone twistouts.	Ivory Gray	<b>HBL4747RFIV</b> <b>HBL4747RFGY</b> A: 5.43" (137.97) B: 4.75" (120.65)
	<b>2-Gang, One Duplex Opening, One Modular Furniture</b> For 15A and 20A duplex receptacles and duplex communication frames shown on page R-45. Includes modular furniture with two keystone twistouts.	Ivory Gray	<b>HBL4747BFIV</b> <b>HBL4747BFGY</b> A: 5.43" (137.97) B: 4.75" (120.65)	<b>2-Gang, One Duplex Opening, One Style Line® Opening</b> For 15A and 20A duplex receptacles and Style Line rectangular receptacles, GFCI, surge devices and rectangular communication frames shown on page R-45.	Ivory Gray	<b>HBL4747BRIV</b> <b>HBL4747BRGY</b> A: 5.43" (137.97) B: 4.75" (120.65)
	<b>2-Gang, One Duplex Opening, One Ortronics® Series II® Mini Adapter Bezel</b> For 15A and 20A duplex recept. and duplex communication plates. Includes Ortronics® Series II® Mini Adapter Bezel.	Ivory Gray	<b>HBL4747BSIV</b> <b>HBL4747BSGY</b> A: 5.43" (137.97) B: 4.75" (120.65)	<b>2-Gang, One Duplex Opening, One Ortronics® TracJack® Mini Adapter Bezel</b> For 15A and 20A duplex recept. and duplex communication plates. Includes Ortronics® TracJack® Mini Adapter Bezel.	Ivory Gray	<b>HBL4747BTIV</b> <b>HBL4747BTGY</b> A: 5.43" (137.97) B: 4.75" (120.65)

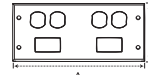
Ortronics®, Series II® and TracJack® are registered trademarks of The Ortronics Company.

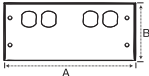
Dimensions in Inches (mm)

4-Gang Cover Plates (Include Mounting Bracket)	Description	Color	Catalog Number	Description	Color	Catalog Number
	<b>4-Gang, Four Duplex Openings</b> For 15A and 20A duplex receptacles and duplex communication frames shown on page R-45.	Ivory Gray	<b>HBL47472BBBBIV</b> <b>HBL47472BBBBGY</b> A: 10.22" (259.56) B: 4.75" (120.65)	<b>4-Gang, Two Style Line® Openings, Two Blanks</b> For Style Line rectangular receptacles, GFCI, surge devices and rectangular communication frames shown on page R-45. Includes two blanks.	Ivory Gray	<b>HBL47472RRXXIV</b> <b>HBL47472RRXXGY</b> A: 10.22" (259.56) B: 4.75" (120.65)
						
	<b>4-Gang, Two Duplex Openings, Two Style Line® Openings</b> For 15A and 20A duplex receptacles. Includes Style Line openings for rectangular receptacles, GFCI, surge devices and rectangular communication frames shown on page R-45.	Ivory Gray	<b>HBL47472BBRRIV</b> <b>HBL47472BBRRGY</b> A: 10.22" (259.56) B: 4.75" (120.65)	<b>4-Gang, Two Duplex Openings, Two Ortronics® Series II® Mini Adapter Bezels</b> For 15A and 20A duplex receptacles and duplex communication plates. Includes two Ortronics® Series II® Mini Adapter Bezels.	Ivory Gray	<b>HBL47472BBSSIV</b> <b>HBL47472BBSSGY</b> A: 10.22" (259.56) B: 4.75" (120.65)
						
	<b>4-Gang, Two Duplex Openings, Two Modular Furniture</b> For 15A and 20A duplex receptacles and duplex communication frames shown on page R-45. Includes two modular furniture with two keystone twistouts.	Ivory Gray	<b>HBL47472BBFFIV</b> <b>HBL47472BBFFGY</b> A: 10.22" (259.56) B: 4.75" (120.65)	<b>4-Gang, Two Duplex Openings, Two Ortronics® TracJack® Mini Adapter Bezels</b> For 15A and 20A duplex receptacles and duplex communication plates. Includes two Ortronics® TracJack® Mini Adapter Bezels.	Ivory Gray	<b>HBL47472BBTTIV</b> <b>HBL47472BBTTGY</b> A: 10.22" (259.56) B: 4.75" (120.65)
						
<b>4-Gang, Two Duplex Openings, Two Blanks</b> For 15A and 20A duplex receptacles and duplex communication frames shown on page R-45. Includes two blanks.	Ivory Gray	<b>HBL47472BBXXIV</b> <b>HBL47472BBXXGY</b> A: 10.22" (259.56) B: 4.75" (120.65)				
						

Tools	Description	Color	Catalog Number	Description	Catalog Number	
	<b>Base Cutter</b> Cutter for cutting base of HBL4750 Raceway.			<b>HBL640B</b>	<b>Cover Cutter</b> Cutter for cutting cover of HBL4750 Raceway.	<b>HBL640C</b>
	<b>Replacement Blade Cutter and Die Set</b> Base blade set.			<b>HBL640BDK</b>	<b>Replacement Blade Cutter and Die Set</b> Cover blade set.	<b>HBL640CDK</b>
<b>Touch-Up Paint Pen</b>	Ivory Gray	<b>HBLIWEP</b> <b>HBLGWEP</b>				
						

Ortronics®, Series II® and TracJack® are registered trademarks of The Ortronics Company.

Dimensions in Inches (mm)

## Metal Raceway HBL6750 Series *Features and Benefits*



### Bracket and Devices

- HBL6750 Device Bracket Plate provides excellent solution for three channel power, data, voice, audio and video applications.
- For use with Hubbell KP plates and Hubbell iSTATION Modules and Bezels.
- Provides flush finish with overlap feature to hide potential miscuts.

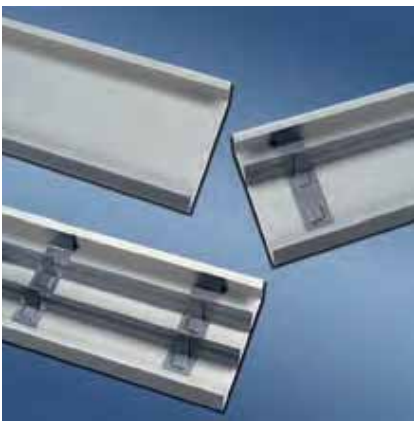

### Maximum Capacity

- HBL6750 Series options include single channel (no divider), two channel (1/3, 2/3 divider) or three channel (1/3, 1/3, 1/3 divider).
- HBL6750 Series offers maximum capacity in a low profile raceway.
- HBL6750, two channel version, features industry leading capacity equivalent to a HBL4750 single channel profile with an additional channel.
- Low profile raceway provides a less conspicuous profile than competitive versions.
- Available in 10 ft. (3m) lengths.





### Unique Line of Fittings

- 1¼ in. (31.75mm) bend radius fittings meet TIA/EIA requirements.
- Integral bend radius offers a fixed solution that does not have to be field installed.
- Large cross sectional area provides for maximum cable capacity throughout entire system.
- Available external, internal, flat, tee and entrance end fittings.
- UL Listed, CSA Certified.
- Available in ivory or gray powder coat finish.



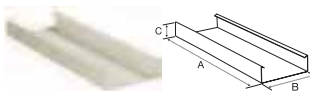

### Plates and Covers

- Wide variety of overlapping cover plates provide flexibility for power, data, voice, audio and video applications.
- Available in both three and six-gang options.
- Cover plates accept wide selection of Hubbell iSTATION Modules and Bezels.
- Cover plates help to conceal unsightly gaps caused by miscuts.
- Precut cover options allow for 12 in. (304.80mm), 18 in. (457.20mm), 24 in. (609.60mm) and 36 in. (914.40mm) "on-center" mounting.
- Open System architecture available.



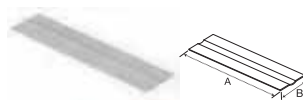
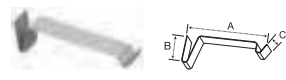

HBL6750 Series	Description	Color	Catalog Number	Description	Color	Catalog Number
	<p><b>Single Channel Base</b>                      Packed 20 ft. (6.1m) per carton, 10 ft. (3m) lengths.                      Assembled cover and base dimensions.                      W: 6.75" (171.45)                      H: 2.22" (56.39)</p> 	Ivory Gray	<b>HBL6750B10IV</b> <b>HBL6750B10GY</b> A: 120.00" (3048.00) B: 6.75" (171.45) C: 2.12" (53.85)	<p><b>5 Ft. Cover</b>                      Packed 20 ft. (6.1m) per carton, 5 ft. (1.5m) lengths.</p> <p><b>31.5 In. Precut Cover*</b>                      For 36 in. (915.00) centers with HBL6747 and HBL6750 Plates.</p> <p><b>19.5 In. Precut Cover*</b>                      For 24 in. (610.00) centers with HBL6747 and HBL6750 Plates.</p> <p><b>13.5 In. Precut Cover*</b>                      For 18 in. (457.00) centers with HBL6747 and HBL6750 Plates.</p> <p><b>7.5 In. Precut Cover*</b>                      For 12 in. (305.00) centers with HBL6747 and HBL6750 Plates.</p> 	Ivory Gray  Ivory Gray  Ivory Gray  Ivory Gray	<b>HBL6750CIV</b> <b>HBL6750CGY</b> A: 60.00" (1,524.0) B: 6.75" (171.45)  <b>HBL6750C315IV</b> <b>HBL6750C315GY</b> A: 31.50" (800.10) B: 6.75" (171.45)  <b>HBL6750C195IV</b> <b>HBL6750C195GY</b> A: 19.50" (495.30) B: 6.75" (171.45)  <b>HBL6750C135IV</b> <b>HBL6750C135GY</b> A: 13.50" (342.90) B: 6.75" (171.45)  <b>HBL6750C075IV</b> <b>HBL6750C075GY</b> A: 7.50" (190.50) B: 6.75" (171.45)

Note: \*Packed 10 pieces per carton. Device centers vary based on cover selection. Consult factory for details.

Fittings	Description	Color	Catalog Number	Description	Color	Catalog Number
	<p><b>Divider</b>                      Divides HBL6750 Raceway into two or three channels. Packed 50 ft. (15.24m) per carton, 5 ft. (1.5m) lengths. HBL6751DAGY Divider Clips are required to hold divider in place.</p> 	Painted Steel	<b>HBL6750DAGY</b> A: 60.00" (1524.00) B: 2.03" (51.56)	<p><b>Wire Clip (Plated)</b>                      For holding conductors in place.</p> 	Steel**	<b>HBL6750WCGY</b> A: 6.61" (167.80) B: 2.09" (53.05)
	<p><b>Divider Clip (Plated)</b>                      Required for holding HBL6750DAGY in place. Use one every 2.5 ft. (.762m).</p> 	Steel**	<b>HBL6751DAGY</b> A: 6.60" (167.67) B: 1.97" (50.10)	<p><b>Coupling (Plated)</b>                      For joining lengths of HBL6750 Raceway. Sold in pairs.</p> 	Steel**	<b>HBL6751A</b> A: 2.00" (50.71) B: .42" (10.59)
	<p><b>Internal Corner Coupling (Plated)</b>                      Concealed fitting for making an internal corner while continuing original run in a straight line.</p> 	Steel**	<b>HBL6717TCAGY</b> A: 6.56" (166.62) B: 1.94" (49.28)			

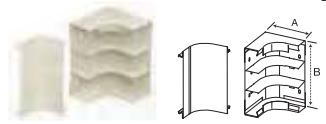
Note: \*\*Galvanized Steel.

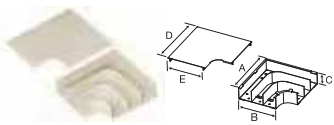

Dimensions in Inches (mm)

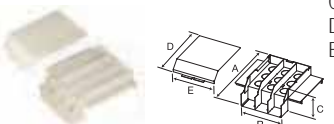
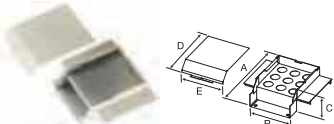

Elbows	Description	Color	Catalog Number	Description	Color	Catalog Number	
	<b>Internal Elbow, Divided</b> For inside surface at right angles. Full capacity 1¼ in. bend radius internal elbow.	Ivory Gray	<b>HBL6717DFOIV*</b> <b>HBL6717DFOGY*</b> A: 4.74" (120.47) B: 6.75" (171.45)	<b>Internal Elbow, Undivided</b> For inside surface at right angles.	Ivory Gray	<b>HBL6717IV*</b> <b>HBL6717GY*</b> A: 4.74" (120.47) B: 6.75" (171.45)	
		<b>External Elbow, Divided</b> For right angle turns around external corners. Full capacity 1¼ in. bend radius external elbow.	Ivory Gray	<b>HBL6718DFOIV*</b> <b>HBL6718DFOGY*</b> A: 5.83" (148.21) B: 6.75" (171.45)	<b>External Elbow, Undivided</b> For right angle turns around external corners.	Ivory Gray	<b>HBL6718IV*</b> <b>HBL6718GY*</b> A: 5.83" (148.21) B: 6.75" (171.45)
		<b>Flat Elbow, Divided</b> For right angle turns on same surface. Full capacity 1¼ in. bend radius flat elbow.	Ivory Gray	<b>HBL6711DFOIV*</b> <b>HBL6711DFOGY*</b> A: 9.23" (234.45) B: 6.75" (171.45) C: 2.14" (54.23) D: 9.83" (249.69) E: 6.75" (171.45)	<b>Flat Elbow, Undivided</b> For right angle turns on same surface.	Ivory Gray	<b>HBL6711IV*</b> <b>HBL6711GY*</b> A: 9.23" (234.45) B: 6.75" (171.45) C: 2.14" (54.23) D: 9.83" (249.69) E: 6.75" (171.45)
		<b>Internal or External 45° Elbow</b> For making internal or external turns in a run of HBL6750 Raceway.	Ivory Gray	<b>HBL6712TXIV</b> <b>HBL6712TXGY</b> A: 6.53" (165.93) B: 6.56" (166.62)	<b>Inverted Internal Elbow</b> For connecting a vertical run of HBL6750 Raceway with a horizontal run.	Ivory Gray	<b>HBL6717NIV</b> <b>HBL6717NGY</b> A: 6.56" (166.62) B: 5.13" (130.30)
							

Tees	Description	Color	Catalog Number	Description	Color	Catalog Number
	<b>Tee Fitting, Divided</b> For branches at right angles. Full capacity 1¼ in. bend radius tee fitting.	Ivory Gray	<b>HBL6715DFOIV*</b> <b>HBL6715DFOGY*</b> A: 8.75" (222.25) B: 6.63" (168.40) C: 3.56" (90.48) D: 7.92" (201.07) E: 6.75" (171.45)	<b>Tee Fitting, Undivided</b> For branches at right angles.	Ivory Gray	<b>HBL6715IV*</b> <b>HBL6715GY*</b> A: 8.75" (222.25) B: 6.63" (168.40) C: 3.56" (90.48) D: 7.92" (201.07) E: 6.75" (171.45)
						

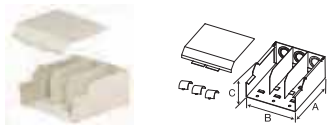
Note: \*HBL6751A couplings included.

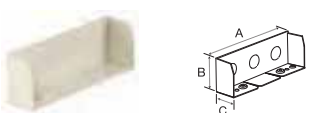
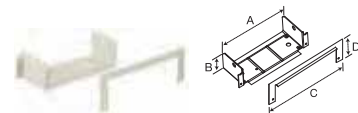
Dimensions in Inches (mm)

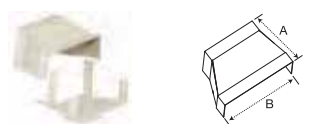
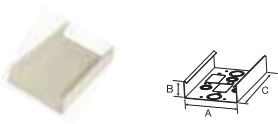
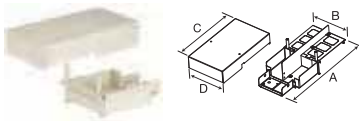
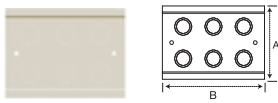
End Fittings	Description	Color	Catalog Number	Description	Color	Catalog Number
	<p><b>Entrance End Fitting, Divided</b> For connecting HBL6750 Raceway with rigid or flexible conduit. Concentric 3/4 in., 1 in. and 1 1/4 in. trade size KO's on back and end. Full capacity 1 1/4 in. bend radius entrance end fitting. Includes 3/4 in., 1 in. and 1 1/4 in. KO and removable dividers.</p> 	Ivory Gray	<b>HBL6710DFOIV*</b> <b>HBL6710DFOGY*</b> A: 6.75" (171.45) B: 6.75" (171.45) C: 3.18" (80.71)	<p><b>Entrance End Fitting, Undivided</b> For connecting HBL6750 Raceway with rigid or flexible conduit. Concentric 3/4 in., 1 in. and 1 1/4 in. trade size KO's on back and end.</p> 	Ivory Gray	<b>HBL6710IV*</b> <b>HBL6710GY*</b> A: 6.75" (171.45) B: 6.75" (171.45) C: 3.18" (80.71)
<p><b>Blank End Fitting</b> For closing open end of HBL6750 Raceway. Has three 1/2 in. trade size KO's.</p> 	Ivory Gray	<b>HBL6710BIV</b> <b>HBL6710BGY</b> A: 6.56" (166.62) B: 1.98" (50.41) C: 1.33" (33.90)	<p><b>Panel Connector</b> To connect HBL6750 Raceway with surface type panel boxes.</p> 	Ivory Gray	<b>HBL6786IV</b> <b>HBL6786GY</b> A: 7.51" (190.86) B: 2.00" (50.83) C: 7.89" (200.37) D: 2.38" (60.34)	

Fittings	Description	Color	Catalog Number	Description	Color	Catalog Number
	<p><b>Transition Fitting</b> For transitioning from Wiremold® 6000 Raceway to Hubbell HBL6750 Raceway.</p> 	Ivory Gray	<b>HBL6750TFIV</b> <b>HBL6750TFGY</b> A: 4.35" (110.42) B: 6.96" (176.87)	<p><b>Wall Box Connector</b> For back feeding HBL6750 Raceway.</p> 	Ivory Gray	<b>HBL6714AIV</b> <b>HBL6714AGY</b> A: 6.75" (171.45) B: 2.14" (54.28) C: 9.90" (251.46)
<p><b>Take-Off Connector (HBL6750-HBL4750)</b> For 90° tee connection of HBL4750 Raceway from HBL6750 Raceway.</p> 	Ivory Gray	<b>HBL6774AIV</b> <b>HBL6774AGY</b> A: 14.36" (364.76) B: 6.75" (171.45) C: 11.47" (291.29) D: 6.72" (170.69)	<p><b>3-Gang Tap-Off Fitting</b> Has six concentric 1/2 in. and 3/4 in. trade size KO's.</p> 	Ivory Gray	<b>HBL6746HHIV</b> <b>HBL6746HHGY</b> A: 4.35" (110.42) B: 6.96" (176.87)	
<p><b>Connection Cover</b> For covering potential openings where two covers come together.</p> 	Ivory Gray	<b>HBL6756AIV</b> <b>HBL6756AGY</b> A: 6.75" (171.45) B: .59" (14.89)				

Note: \*HBL4751AC couplings included.







Wiremold® is a registered trademark of the Wiremold Company.  
Dimensions in Inches (mm)



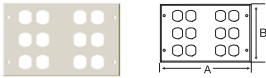

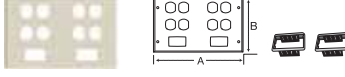

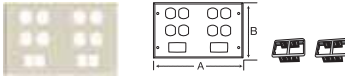
	Description	Color	Catalog Number	Description	Color	Catalog Number
Device Plates & Mounting Bracket	<b>3-Gang, One Opening for 1-Gang Commercial Device Plate, Two Blanks</b> Use with commercially available 1-gang flush plates. See page R-45 for plate options.	Ivory Gray	<b>HBL6747C1IV</b> <b>HBL6747C1GY</b> A: 5.43" (137.97) B: 6.75" (171.45)	<b>3-Gang, One Opening for 2-Gang Commercial Device Plate, One Blank</b> Use with commercially available 2-gang flush plates. See page R-45 for plate options.	Ivory Gray	<b>HBL6747C2IV</b> <b>HBL6747C2GY</b> A: 5.43" (137.97) B: 6.75" (171.45)
	<b>Device Mounting Bracket</b> Mounting bracket for mounting Hubbell KP Plates, iSTATION Modules and Bezels. See pages R-45 and R-46 for datacom product selection.	Ivory Gray	<b>HBL6750IV</b> <b>HBL6750GY</b> A: 5.25" (133.35) B: 6.75" (171.45)			
3-Gang Cover Plates (Include Mounting Bracket)	<b>3-Gang, One Duplex Opening, Two Blanks</b> For 15A and 20A duplex receptacles and duplex communication plates.	Ivory Gray	<b>HBL6747BXXIV</b> <b>HBL6747BXXGY</b> A: 5.43" (137.97) B: 6.75" (171.45)	<b>3-Gang, One Single Round Opening, Two Blanks</b> For single receptacle with face diameter of 1.38 in. to 1.39 in. (35.05 to 35.31).	Ivory Gray	<b>HBL6747AXXIV</b> <b>HBL6747AXXGY</b> A: 5.43" (137.97) B: 6.75" (171.45)
	<b>3-Gang, Three Duplex Openings</b> For 15A and 20A duplex receptacles and duplex communication plates.	Ivory Gray	<b>HBL6747BBBIV</b> <b>HBL6747BBBGY</b> A: 5.43" (137.97) B: 6.75" (171.45)	<b>3-Gang, One Single Round Opening, Two Blanks</b> For single receptacle with face diameter of 1.56 in. to 1.58 in. (39.62 to 40.13).	Ivory Gray	<b>HBL6747JXXIV</b> <b>HBL6747JXXGY</b> A: 5.43" (137.97) B: 6.75" (171.45)
	<b>3-Gang, One Duplex Opening, Two Style Line® Openings</b> For 15A and 20A duplex receptacles and duplex communication plates. Includes Style Line openings for rectangular receptacles, GFCI, surge devices and rectangular communication frames shown on page R-45.	Ivory Gray	<b>HBL6747BRRIV</b> <b>HBL6747BRRGY</b> A: 5.43" (137.97) B: 6.75" (171.45)	<b>3-Gang, One Style Line® Opening, Two Blanks</b> For one Style Line rectangular receptacle, GFCI, surge device or rectangular communication device.	Ivory Gray	<b>HBL6747RXXIV</b> <b>HBL6747RXXGY</b> A: 5.43" (137.97) B: 6.75" (171.45)
	<b>3-Gang, Two Duplex Openings, One Modular Furniture</b> For 15A and 20A duplex receptacles and duplex communication frames shown on page R-45. Includes modular furniture with two keystone twistouts.	Ivory Gray	<b>HBL6747BBFIV</b> <b>HBL6747BBFGY</b> A: 5.43" (137.97) B: 6.75" (171.45)	<b>3-Gang, Two Style Line® Openings, One Modular Furniture</b> For two Style Line rectangular receptacles, GFCI, surge devices and rectangular communication frames shown on page R-45. Includes modular furniture with two keystone twistouts.	Ivory Gray	<b>HBL6747RRFIV</b> <b>HBL6747RRFGY</b> A: 5.43" (137.97) B: 6.75" (171.45)
	<b>3-Gang, Two Duplex Openings, One Ortronics® Series II® Mini Adapter Bezel</b> For two 15A and 20A duplex receptacles and duplex communication frames shown on page R-45. Includes Ortronics® Series II® Mini Adapter Bezel.	Ivory Gray	<b>HBL6747BBSIV</b> <b>HBL6747BBSGY</b> A: 5.43" (137.97) B: 6.75" (171.45)	<b>3-Gang, Two Duplex Openings, One Ortronics® TracJack® Mini Adapter Bezel</b> For 15A and 20A duplex receptacles and duplex communication frames shown on page R-45. Includes Ortronics® TracJack® Mini Adapter Bezel.	Ivory Gray	<b>HBL6747BBTIV</b> <b>HBL6747BBTGY</b> A: 5.43" (137.97) B: 6.75" (171.45)

Ortronics®, Series II® and TracJack® are registered trademarks of The Ortronics Company.

Dimensions in Inches (mm)

6-Gang Cover Plates (Include Mounting Bracket)	Description	Color	Catalog Number	Description	Color	Catalog Number		
	<b>6-Gang, Six Duplex Openings</b> For 15A and 20A duplex receptacles and duplex communication frames shown on page R-45.	Ivory Gray	<b>HBL67473BBBBBBIV</b> <b>HBL67473BBBBBBGY</b> A: 10.22" (259.56) B: 6.75" (171.45)		<b>6-Gang, Four Style Line® Openings, Two Blanks</b> For four Style Line rectangular receptacles, GFCI, surge devices and rectangular communication frames shown on page R-45.	Ivory Gray	<b>HBL67473RRRRXXIV</b> <b>HBL67473RRRRXXGY</b> A: 10.22" (259.56) B: 6.75" (171.45)	
	<b>6-Gang, Two Duplex Openings, Four Style Line® Openings</b> For 15A and 20A duplex receptacles and duplex communication frames shown on page R-45. Includes Style Line openings for rectangular receptacles, GFCI, surge devices and rectangular communication devices.	Ivory Gray	<b>HBL67473BBRRRRIV</b> <b>HBL67473BBRRRRGY</b> A: 10.22" (259.56) B: 6.75" (171.45)		<b>6-Gang, Four Duplex Openings, Two Ortronics® Series II® Mini Adapter Bezels</b> For 15A and 20A duplex receptacles and duplex communication frames shown on page R-45. Includes two Ortronics® Series II® Mini Adapter Bezels.	Ivory Gray	<b>HBL67473BBBBSSIV</b> <b>HBL67473BBBBSSGY</b> A: 10.22" (259.56) B: 6.75" (171.45)	
	<b>6-Gang, Four Duplex Openings, Two Modular Furniture</b> For 15A and 20A duplex receptacles and duplex communication frames shown on page R-45. Includes two modular furniture with two keystone twistouts.	Ivory Gray	<b>HBL67473BBBBFFIV</b> <b>HBL67473BBBBFFGY</b> A: 10.22" (259.56) B: 6.75" (171.45)		<b>6-Gang, Four Duplex Openings, Two Ortronics® TracJack® Mini Adapter Bezels</b> For 15A and 20A duplex receptacles and duplex communication frames shown on page R-45. Includes two Ortronics® TracJack® Mini Adapter Bezels.	Ivory Gray	<b>HBL67473BBBBTTIV</b> <b>HBL67473BBBBTTGY</b> A: 10.22" (259.56) B: 6.75" (171.45)	
	<b>6-Gang, Four Duplex Openings, Two Blanks</b> For four 15A and 20A duplex receptacles and duplex communication frames shown on page R-45.	Ivory Gray	<b>HBL67473BBBBXXIV</b> <b>HBL67473BBBBXXGY</b> A: 10.22" (259.56) B: 6.75" (171.45)					

Tools	Description	Color	Catalog Number	Description	Catalog Number	
	<b>Base Cutter</b> Cutter for cutting base of HBL6750 Raceway.			<b>HBL660B</b>	<b>Cover Cutter</b> Cutter for cutting cover of HBL6750 Raceway.	<b>HBL660C</b>
						
<b>Replacement Blade Cutter and Die Set</b> Base blade set.			<b>HBL660BDK</b>	<b>Replacement Blade Cutter and Die Set</b> Cover blade set.	<b>HBL660CDK</b>	
						
<b>Touch-Up Paint Pen</b>	Ivory Gray	<b>HBLIWEP</b> <b>HBLGWEP</b>				
						

Ortronics®, Series II® and TracJack® are registered trademarks of The Ortronics Company.  
 Dimensions in Inches (mm)

# Aluminum Raceway HBLALU2000 and Aluminum PlugTrak® Series

Features and Benefits



## Single Channel

- Single channel aluminum raceway.
- Satin anodized finish.
- Resists oxidation, corrosion and fading.
- Can be installed as recessed or surface mounted.
- UL Listed and CSA Certified.



## Wide Selection of Fittings

- Elbows (external, internal, flat) and tee fitting available to accommodate all types of applications.
- HBLALU2001 Coupling included with elbows and tee fitting.



## Aluminum Boxes

- Both in-line and standard boxes available.
- Hubbell Handi-Screw® eliminates difficult to install long screws for easier installation.
- Rounded corners eliminate sharp edges.
- One seam construction provides “clean” look.
- Box design allows standard wallplates to be mounted flush with virtually no perimeter profile exposed.
- Full line of metal wallplates available. See section N for selection.



## Aluminum PlugTrak® Featuring Exclusive Receptacle Design

- Satin anodized scratch resistant finish.
- Multiple spacing configurations.
- Hubbell designed and manufactured single receptacle.
- Insulation displacement wiring provides superior wire retention.
- Mates with HBLALU2000 Aluminum Raceway.
- Available in 3 ft. (0.9m), 5 ft. (1.5m) and 6 ft. (1.8m) lengths.
- Tamper-Resistant versions available.

# Aluminum Raceway HBLALU2000 Series

Aluminum Raceway, Device Boxes, Elbows and Tees



HBLALU2000 Series	Description	Material	Catalog Number	Description	Material	Catalog Number
	<b>5 Ft. Base</b> Satin anodized finish. Packed 60 ft. (18.3m) per carton, 5 ft. (1.5m) lengths.	Anodized Aluminum	<b>HBLALU2000B5</b>	A: .82" (21.00) B: 1.84" (46.74)	<b>Cover</b> Satin anodized finish. Packed 60 ft. (18.3m) per carton, 5 ft. (1.5m) lengths.	Anodized Aluminum
<b>10 Ft. Base</b> Satin anodized finish. Packed 60 ft. (18.3m) per carton, 10 ft. (3m) lengths. Assembled cover and base dimensions. W: 1.84" (46.74) H: .91" (23.11)	Anodized Aluminum	<b>HBLALU2000B10</b>	A: .82" (21.00) B: 1.84" (46.74)			



Standard	Description	Material	1-Gang	2-Gang	Description	Material	Round Box
	<b>Device Box</b> For standard switches and receptacles.	Anodized Aluminum	<b>HBLALU2047</b>	A: 4.54" (115.32) B: 2.82" (71.63) C: 1.38" (35.05)	<b>HBLALU20472</b>	A: 4.54" (115.32) B: 4.64" (117.86) C: 1.38" (35.05)	Anodized Aluminum
<b>Deep</b> For deep switches and receptacles.	Anodized Aluminum	<b>HBLALU2044</b>	A: 4.54" (115.32) B: 2.82" (71.63) C: 2.25" (57.15)	<b>HBLALU20442</b>	A: 4.54" (115.32) B: 4.64" (117.86) C: 2.75" (69.85)		

Base Trade Size KOs  
 1 - 1/2", 3/4" Concentric 1 - 1/2"  
 1 - Rectangular 1 - Rectangular



Elbows and Tees	Description	Material	Catalog Number	Description	Material	Catalog Number
	<b>Internal Elbow</b> For making a 90° internal turn in a raceway run.	Anodized Aluminum	<b>HBLALU2017*</b>	A: 3.00" (76.20) B: 3.00" (76.20)	<b>External Elbow</b> For making a 90° external turn in a raceway run.	Anodized Aluminum
<b>Flat Elbow</b> For making a 90° flat turn in a raceway run.	Anodized Aluminum	<b>HBLALU2011*</b>	A: 3.00" (76.20) B: 3.00" (76.20)	A: 2.91" (74.04) B: 2.91" (74.04)		
				<b>Tee Fitting</b> For branch connections of right angles.	Anodized Aluminum	<b>HBLALU2015*</b>
						A: 4.00" (101.60) B: 3.40" (86.36)

Note: \*HBLALU2001 couplings included.

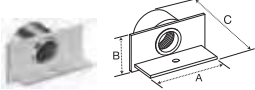
Dimensions in Inches (mm)

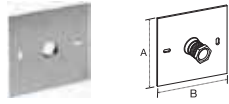
End Fittings	Description	Material	Catalog Number	Description	Material	Catalog Number
	<b>Entrance End Fitting</b> ½ in. NPT steel fitting.	Anodized Aluminum Plate	<b>HBLALU2010A</b> A: 1.84" (47.74) B: .91" (23.11) C: 1.51" (38.35)		<b>Blank End Fitting</b> For closing end of raceway.	Anodized Aluminum

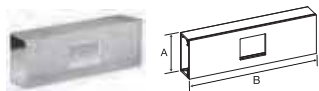
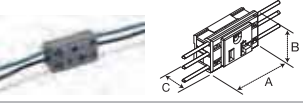
Fittings	Description	Material	Catalog Number	Description	Material	Catalog Number
	<b>Cover Clip</b> Use to cover potential openings where two pieces of HBLALU2000 Raceway cover come together.	Stainless Steel	<b>HBLALU2006</b> A: 1.00" (25.40)		<b>Wire Clip</b> For holding conductors in place.	Anodized Aluminum
<b>Flush Plate Adaptor</b> For feeding HBL2000 Raceway from an existing wall outlet. Locknut included.	Anodized Aluminum	<b>HBLALU2051H</b> A: 4.50" (114.3) B: 4.50" (114.3)		<b>Coupling (Pair)</b> For joining lengths of HBLALU2000 Raceway.	Aluminum	<b>HBLALU2001</b> A: 1.67" (42.42) B: 1.67" (42.42)

Devices and In-Line Fittings	Description	Material	Catalog Number	Description	Material	Catalog Number	
	<b>In-Line Receptacle Fitting</b> Use this fitting with single receptacle below.	Anodized Aluminum	<b>HBLALU2043*</b> A: 1.84" (46.74) B: 6.00" (152.40)		<b>In-Line Switch Fitting</b> (Switch sold separately).	Anodized Aluminum	<b>HBLALU2040A</b> A: 4.12" (104.65) B: 1.84" (46.74)
	<b>Single Recept. - 15A 125V</b> <b>Single Recept. - 15A 125V, Iso. Grnd</b> <b>Single Recept. - 20A 125V</b> <b>Single Recept. - 20A 125V, Iso. Grnd</b> #12 AWG THHN stranded copper wires with 21 in. leads on each end.	Gray Orange Gray Orange	<b>PT1RCGY</b> <b>PT1RCIG</b> <b>PT1RGY</b> <b>PT1RIG</b> A: 2.00" (50.7) B: 1.20" (30.4) C: .87" (22.2)		<b>Supporting Clip</b> For mounting lengths of HBLALU2000 Raceway at any point. Mount with #6 flat head fastener. Has set screw for locking to raceway. Raceway must be screwed to the wall for secure fastening.	Stainless Steel	<b>HBLALU2003</b> A: 2.00" (50.80)
<b>Ground Adapter (Plated)</b> For connection of equipment grounding conductor to provide an additional ground to raceway. Screws included.	Steel**	<b>HBLALU2009</b> A: 2.35" (59.8) B: 1.18" (30.0)					

Note: \*HBLALU2001 couplings included.  
 \*\*Galvanized Steel.

Dimensions in Inches (mm)





Aluminum Raceway  
**Aluminum PlugTrak® Series**  
 Aluminum PlugTrak®, Device Boxes and Fittings

















Available in Standard, Isolated Ground (IG) and Tamper-Resistant (TR) versions.

 Tamper-Resistant



	Amp	Circuits	# Single Recept.	Receptacle Spacing (in.)	Catalog Number	
3 Foot	15	Single	6	6	HBLALU20GB306	
	15	IG/Single	6	6	HBLALU20IG306	
	15	TR/Single	6	6	HBLALU20GB306TR	
	20	Single	6	6	HBLALU24GB306	
	20	IG/Single	6	6	HBLALU24IG306	
	20	TR/Single	6	6	HBLALU24GB306TR	
5 Foot	15	Single	10	6	HBLALU20GB506	
	15	Single	5	12	HBLALU20GB512	
	15	IG/Single	10	6	HBLALU20IG506	
	15	TR/Single	5	12	HBLALU20GB512TR	
	20	Single	10	6	HBLALU24GB506	
	20	Single	5	12	HBLALU24GB512	
	20	IG/Single	10	6	HBLALU24IG506	
	20	TR/Single	5	12	HBLALU24GB512TR	
6 Foot	15	Single	12	6	HBLALU20GB606	
	15	Single	6	12	HBLALU20GB612	
	15	Single	4	18	HBLALU20GB618	
	15	Two	12	6	HBLALU20GBA606	
	15	Two	6	12	HBLALU20GBA612	
	15	Two	4	18	HBLALU20GBA618	
	15	IG/Single	12	6	HBLALU20IG606	
	20	Single	12	6	HBLALU24GB606	
	20	Single	6	12	HBLALU24GB612	
	20	Single	4	18	HBLALU24GB618	
	20	Two	12	6	HBLALU24GBA606	
	20	Two	6	12	HBLALU24GBA612	
	20	Two	4	18	HBLALU24GBA618	
	20	IG/Single	12	6	HBLALU24IG606	

Note: IG = Isolated Ground and TR = Tamper-Resistant.  
 Hubbell Aluminum PlugTrak is supplied with two HBLALU2010B blank end fittings and one HBLALU2001 coupling.

	Description	Catalog Number
Device Boxes	Standard 1-Gang Device Box 	HBLALU2047
	Deep 1-Gang Device Box 	HBLALU2044
	Standard 2-Gang Device Box 	HBLALU20472
	Deep 2-Gang Device Box 	HBLALU20442
	Round Box 	HBLALU2038
	Elbows and Tees	External Elbow 
Internal Elbow 		HBLALU2017
Flat Elbow 		HBLALU2011
Tee 		HBLALU2015
Fittings		Cover Clip 
	Supporting Clip 	HBLALU2003
	Coupling 	HBLALU2001
	Entrance End Fitting 	HBLALU2010A
	In-Line Switch Fitting 	HBLALU2040A
	Blank End Fitting 	HBLALU2010B

Note: See pages R-34 and R-35 for additional information.

# Aluminum Raceway HBLALU3800 and HBLALU4800 Series

*Features and Benefits*



## Single and Two Channel

- Single and two channel aluminum raceways.
- Satin anodized finish.
- Resists oxidation, corrosion and fading.
- Can be installed as recessed or surface mounted.
- UL Listed and CSA Certified.



## Wide Selection of Fittings

- External, internal, flat and tee fittings available to accommodate all types of applications.
- Available in both single and two channel versions.



## Split Covers

- Single and two channel raceways utilize common cover.
- Split covers allow access to one service at a time.
- Common aesthetics throughout line.



## Device Cover Plates

- Cover plates can be used for both HBLALU3800 and HBLALU4800 Raceways.
- Cover plates offer option for most common power device applications.
- Low profile bezel cover accommodates Hubbell iSTATION Modules.
- Open System data option available.
- Base mounted cover plates available for added strength.



HBLALU3800 Series	Description	Color	Catalog Number	Description	Color	Catalog Number
	<b>Single Channel Base</b> Satin anodized finish. Packed 40 ft. (12.19m) per carton, 10 ft. (3m) lengths.  Assembled cover and base dimensions. W: 3.00" (76.20) H: 2.25" (57.15)	Anodized Aluminum	<b>HBLALU3800B10</b> A: 2.10" (53.34) B: 3.00" (76.20)	<b>Cover</b> Satin anodized finish. Packed 40 ft. (12.19m) per carton, 5 ft. (1.5m) lengths.	Anodized Aluminum	<b>HBLALUC5</b> A: 3.00" (76.20)







	Description	Color	Catalog Number	Description	Color	Catalog Number
Elbows and Tees	<b>Internal Elbow</b> For making a 90° internal turn in a raceway run.	Anodized Aluminum	<b>HBLALU3817*</b> A: 6.00" (152.40) B: 6.00" (152.40)	<b>Inverted Internal Elbow</b> For connecting a vertical run of HBLALU3800 with a horizontal run with its cover facing up.	Anodized Aluminum	<b>HBLALU3817N*</b> A: 6.00" (152.40) B: 5.98" (151.89)
	<b>External Elbow</b> For making a 90° external turn in a raceway run.	Anodized Aluminum	<b>HBLALU3818*</b> A: 6.00" (152.40) B: 6.00" (152.40)	<b>Tee</b> For branch connections of two runs of HBLALU3800 Raceway.	Anodized Aluminum	<b>HBLALU3815*</b> A: 6.00" (152.40) B: 6.00" (152.40)
	<b>Flat Elbow</b> For making a 90° flat turn in a raceway run.	Anodized Aluminum	<b>HBLALU3811*</b> A: 6.00" (152.40) B: 6.00" (152.40)			
End Fittings	<b>Entrance End Fitting</b> For feeding raceway, has concentric ½ in. and ¾ in. trade size KOs.	Anodized Aluminum	<b>HBLALU3810B1</b> A: 3.00" (76.20) B: 2.31" (58.74)	<b>Blank End Fitting</b> For closing end of raceway.	Anodized Aluminum	<b>HBLALU3810B</b> A: 3.00" (76.20) B: 2.31" (58.74)
	Fittings	<b>Cover Clip</b> To cover seam where lengths of HBLALU3800 Raceway come together.	Stainless Steel	<b>HBLALU3806</b> A: 1.38" (34.92)	<b>Wire Clip</b> For holding conductors in place. Can be used for either HBLALU3800 or HBLALU4800 Raceway.	Anodized Aluminum
<b>Internal Corner Coupling</b> For butting two raceway sections to form an internal 90° turn in a raceway run.		Anodized Aluminum	<b>HBLALU17A</b> A: 4.00" (101.80) B: 2.00" (50.83)	<b>Grounding Adapter</b> For connection of equipment grounding. #10-32 Locking screws included.	Galvanized Steel	<b>HBLALU09</b> A: 4.00" (101.80) B: 2.00" (50.83)
<b>Couplings (Pair)</b> To join lengths of HBLALU3800 or HBLALU4800 base.		Aluminum	<b>HBLALU01</b> A: 2.85" (72.39) B: 4.00" (101.80)			

Note: \*HBLALU01 couplings included.  
 See page R-40 for cover plates.

Dimensions in Inches (mm)



HBLALU4800 Series	Description	Color	Catalog Number	Description	Color	Catalog Number
	<b>Two Channel Base</b> Satin anodized finish. Packed 40 ft. (12.19m) per carton, 10 ft. (3m) lengths.  Assembled cover and base dimensions. W: 6.00" (152.40) H: 2.25" (57.15)	Anodized Aluminum	<b>HBLALU4800B10</b> A: 2.10" (53.34) B: 6.00" (152.40)	<b>Cover</b> Satin anodized finish. Packed 40 ft. (12.19m) per carton, 5 ft. (1.5m) lengths.	Anodized Aluminum	<b>HBLALUC5</b> A: 3.00" (76.20)
						

	Description	Color	Catalog Number	Description	Color	Catalog Number
Elbows and Tees	<b>Internal Elbow (Two Channel)</b> For making a 90° internal turn in a raceway run.	Anodized Aluminum	<b>HBLALU4817*</b> A: 6.00" (152.40) B: 6.00" (152.40)	<b>Inverted Internal Elbow (Two Channel)</b> For connecting a vertical run of HBLALU4800 with a horizontal run with its cover facing up.	Anodized Aluminum	<b>HBLALU4817N*</b> A: 6.00" (152.40) B: 5.98" (151.89)
						
	<b>External Elbow (Two Channel)</b> For making a 90° external turn in a raceway run.	Anodized Aluminum	<b>HBLALU4818*</b> A: 6.00" (152.40) B: 6.00" (152.40)	<b>Tee (Two Channel)</b> For branch connections of two runs of HBLALU4800 Raceway.	Anodized Aluminum	<b>HBLALU4815*</b> A: 9.00" (228.60) B: 9.00" (228.60)
						
	<b>Flat Elbow (Two Channel)</b> For making a 90° flat turn in a raceway run.	Anodized Aluminum	<b>HBLALU4811*</b> A: 9.00" (228.60) B: 9.00" (228.60)			
						
End Fittings	<b>Entrance End Fitting (Two Channel)</b> For feeding raceway, has two concentric 1/2 in. and 3/4 in. trade size KOs.	Anodized Aluminum	<b>HBLALU4810B2</b> A: 6.00" (152.40) B: 2.31" (58.74)	<b>Blank End Fitting (Two Channel)</b> For closing end of raceway.	Anodized Aluminum	<b>HBLALU4810B</b> A: 6.00" (152.40) B: 2.31" (58.74)
						
Fittings	<b>Cover Clip</b> To cover seam where lengths of HBLALU4800 Raceway come together.	Stainless Steel	<b>HBLALU4806</b> A: 1.38" (34.92)	<b>Wire Clip</b> Used for holding conductors in place on raceway. Can be used for either HBLALU3800 or HBLALU4800 Raceway.	Anodized Aluminum	<b>HBLALUWC</b> A: 1.00" (25.40)
						
	<b>Internal Corner Coupling</b> For butting two raceway sections to form an internal 90° turn in a raceway run.	Anodized Aluminum	<b>HBLALU17A</b> A: 4.00" (101.80) B: 2.00" (50.83)	<b>Grounding Adapter</b> For connection of equipment grounding. #10-32 Locking screws included.	Galvanized Steel	<b>HBLALU09</b> A: 4.00" (101.80) B: 2.00" (50.83)
						
	<b>Couplings (Pair)</b> To join lengths of HBLALU3800 or HBLALU4800 base.	Aluminum	<b>HBLALU01</b> A: 2.85" (72.39) B: 4.00" (101.80)			
						

Note: \*HBLALU01 couplings included.  
 See page R-40 for cover plates.

Dimensions in Inches (mm)

Aluminum Raceway  
**HBLALU3800 and HBL4800 Series**  
 Cover Plates and Base Mount Cover Design



	Description	Color	Catalog Number	Description	Color	Catalog Number
Cover Plates	<b>Duplex Receptacle Cover</b> For duplex receptacles and duplex communication frames shown on page R-45.	Anodized Aluminum	<b>HBLALUDR</b> A: 3.00" (76.20) B: 12.00" (304.80) <b>HBLALU34DRBM</b> (Base Mounted Device) A: 3.00" (76.20) B: 12.00" (304.80)	<b>Toggle Switch Cover</b> For single pole, two pole, three way or four way switches.	Anodized Aluminum	<b>HBLALUN</b> A: 3.00" (76.20) B: 12.00" (304.80) <b>HBLALU34NBM</b> (Base Mounted Device) A: 3.00" (76.20) B: 12.00" (304.80)
	<b>Rectangular Style Line® Cover</b> For Style Line rectangular duplex receptacle, GFCI, surge device or rectangular communication frames shown on page R-45.	Anodized Aluminum	<b>HBLALUG</b> A: 3.00" (76.20) B: 12.00" (304.80) <b>HBLALU34GBM</b> (Base Mounted Device) A: 3.00" (76.20) B: 12.00" (304.80)	<b>Single Receptacle Cover</b> For single receptacle with face diameters of 1.38 in. to 1.39 in. (35.05 to 35.31).	Anodized Aluminum	<b>HBLALUE</b> A: 3.00" (76.20) B: 12.00" (304.80) <b>HBLALU34EBM</b> (Base Mounted Device) A: 3.00" (76.20) B: 12.00" (304.80)
	<b>Single Receptacle Cover</b> For single receptacle with face diameters of 1.56 in. to 1.59 in. (39.62 to 40.39).	Anodized Aluminum	<b>HBLALUF</b> A: 3.00" (76.20) B: 12.00" (304.80) <b>HBLALU34FBM</b> (Base Mounted Device) A: 3.00" (76.20) B: 12.00" (304.80)	<b>Single Receptacle Cover</b> For single receptacle with face diameter of 2.13 in. (54.10).	Anodized Aluminum	<b>HBLALUJ</b> A: 3.00" (76.20) B: 12.00" (304.80) <b>HBLALU34JBM</b> (Base Mounted Device) A: 3.00" (76.20) B: 12.00" (304.80)
	<b>Blank Cover</b> To cover 12 in. (305.00) section of raceway.	Anodized Aluminum	<b>HBLALUBL</b> A: 3.00" (76.20) B: 12.00" (304.80)	<b>Ortronics® Cover Plate</b> For two Ortronics TracJack® or one Series II® datacom insert. Both bezels included.	Anodized Aluminum	<b>HBLALUABRT</b> A: 3.00" (76.20) B: 12.00" (304.80)
	<b>Hubbell iSTATION Cover</b> For mounting Hubbell iSTATION Modules. For the HBLALUPB use the KPIMBZGY on page R-45 with modules from page R-46. For the HBLALULPBA use the IMF1GY on page R-46 or any IFPxxGY plates on page R-45.	Anodized Aluminum	<b>HBLALULPB</b> A: 3.00" (76.20) B: 12.00" (304.80) C: 1.90 (48.26) D: 4.21 (106.93) <b>HBLALULPBA</b> A: 3.00" (76.20) B: 12.00" (304.80) C: 1.90 (48.26) D: 3.00" (76.20)			

**Base Mounted Device Cover Design**

No exposed screw holes. Receptacle is securely mounted to the raceway base rather than the cover.



Ortronics®, Series II® and TracJack® are registered trademarks of The Ortronics Company.

Dimensions in Inches (mm)

# Aluminum Raceway HBLALU5000 and HBLALU7620 Series

*Features and Benefits*



## Two and Three Channel

- Two and three channel aluminum raceways.
- Satin anodized finish.
- Resists oxidation, corrosion and fading.
- Can be installed as recessed or surface mounted.
- UL Listed and CSA Certified.

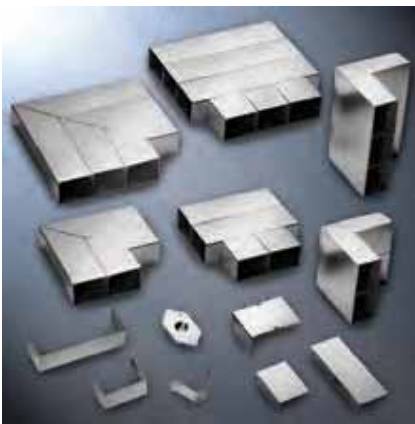

## Wide Selection of Fittings

- External, internal, flat and tee fittings available to accommodate all types of applications.
- Available in both two and three channel versions.





## Covers





- Two and three channel raceway utilize common covers.
- Available in single and dual channel cover designs.
- Single covers allow access to one service at a time.
- Dual channel cover fits over two channels for a seamless look.
- Common aesthetics throughout line.

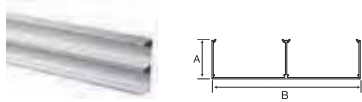



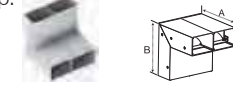



## Compatible Cover Plates

- Cover plates can be used for both HBLALU5000 and HBLALU7620 Raceways.
- Cover plates offer option for most common power device applications.
- Low profile bezel cover accommodates Hubbell iSTATION Modules.
- Open System data option available.
- Base mounted cover plates available for added strength.

HBLALU5000 Series	Description	Color	Catalog Number	Description	Color	Catalog Number
	<p><b>Two Channel Base</b>                      Satin anodized finish. Packed 40 ft. (12.19m) per carton, 10 ft. (3m) lengths.</p> <p>Assembled cover and base dimensions.                      W: 5.08" (129.03)                      H: 1.75" (44.45)</p> 	Anodized Aluminum	<b>HBLALU5000B10</b> A: 1.66" (42.16) B: 5.08" (129.03)	<p><b>Cover - Single Channel</b>                      Satin anodized finish. Packed 40 ft. (12.19m) per carton, 5 ft. (1.5m) lengths.</p> 	Anodized Aluminum	<b>HBLALUC57</b> A: 2.54" (64.52)
			<p><b>Cover - Two Channel</b>                      Satin anodized finish. Packed 40 ft. (12.19m) per carton, 5 ft. (1.5m) lengths.</p> 	Anodized Aluminum	<b>HBLALU2C57</b> A: 5.08" (129.03)	

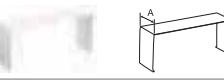

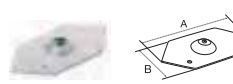
Elbows and Tees	Description	Color	Catalog Number	Description	Color	Catalog Number
	<p><b>Internal Elbow</b>                      For making a 90° internal turn in a raceway run.</p> 	Anodized Aluminum	<b>HBLALU5017*</b> A: 6.00" (152.40) B: 6.00" (152.40)	<p><b>Inverted Internal Elbow</b>                      For connecting a vertical run of HBLALU5000 with a horizontal run with its cover facing up.</p> 	Anodized Aluminum	<b>HBLALU5017N*</b> A: 5.91" (150.20) B: 5.98" (151.89)
	<p><b>External Elbow</b>                      For making a 90° external turn in a raceway run.</p> 	Anodized Aluminum	<b>HBLALU5018*</b> A: 6.00" (152.40) B: 6.00" (152.40)	<p><b>Tee</b>                      For branch connections of two runs of HBLALU5000 Raceway.</p> 	Anodized Aluminum	<b>HBLALU5015*</b> A: 9.00" (228.60) B: 8.08" (205.30)
<p><b>Flat Elbow</b>                      For making a 90° flat turn in a raceway run.</p> 	Anodized Aluminum	<b>HBLALU5011*</b> A: 9.00" (228.60) B: 9.00" (228.60)				







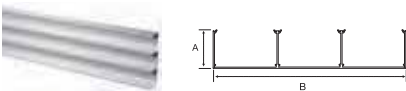

End Fittings	Description	Color	Catalog Number	Description	Color	Catalog Number
	<p><b>Entrance End Fitting</b>                      For feeding raceway, has concentric ½ in. and ¾ in. trade size KOs.</p> 	Anodized Aluminum	<b>HBLALU5010B2</b> A: 5.08" (129.10) B: 1.75" (44.40)	<p><b>Blank End Fitting</b>                      For closing end of raceway.</p> 	Anodized Aluminum	<b>HBLALU5010B</b> A: 5.08" (129.10) B: 1.75" (44.40)

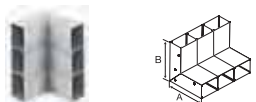
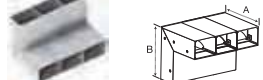
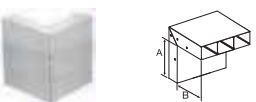
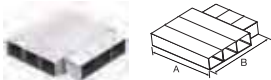
Fittings	Description	Color	Catalog Number	Description	Color	Catalog Number
	<p><b>Cover Clip</b>                      To cover seam where lengths of HBLALU5000 Raceway come together.</p> 	Stainless Steel	<b>HBLALU5006</b> A: 1.38" (34.92)	<p><b>Wire Clip</b>                      For holding conductors in place. Can be used for either HBLALU5000 or HBLALU7620 Raceway.</p> 	Anodized Aluminum	<b>HBLALU57WC</b> A: 1.00" (25.40)
	<p><b>Internal Corner Coupling</b>                      For butting two raceway sections to form an internal 90° turn in a raceway run.</p> 	Anodized Aluminum	<b>HBLALU5717A</b> A: 3.50" (88.90) B: 2.38" (60.30)	<p><b>Grounding Adapter</b>                      For connection of equipment grounding. #10-32 Locking screws included.</p> 	Galvanized Steel	<b>HBLALU5709</b> A: 3.37" (85.50) B: 2.00" (50.83)
<p><b>Couplings (Pair)</b>                      To join lengths of HBLALU5000 or HBLALU7620 base.</p> 	Aluminum	<b>HBLALU5701</b> A: 2.38" (60.30) B: 4.00" (101.80)				

Note: \*HBLALU5701 couplings included.  
 See page R-44 for cover plates.





Dimensions in Inches (mm)

HBLALU7620 Series	Description	Color	Catalog Number	Description	Color	Catalog Number	
	<b>Three Channel Base</b> Satin anodized finish. Packed 40 ft. (12.19m) per carton, 10 ft. (3m) lengths.  Assembled cover and base dimensions. W: 7.62" (193.55) H: 2.25" (57.15)	Anodized Aluminum	<b>HBLALU7620B10</b> A: 2.16" (54.86) B: 7.62" (193.55)		<b>Cover - Single Channel</b> Satin anodized finish. Packed 40 ft. (12.19m) per carton, 5 ft. (1.5m) lengths.	Anodized Aluminum	<b>HBLALUC57</b> A: 2.54" (64.52)
				<b>Cover - Two Channel</b> Satin anodized finish. Packed 40 ft. (12.19m) per carton, 5 ft. (1.5m) lengths.	Anodized Aluminum	<b>HBLALU2C57</b> A: 5.08" (129.03)	

Elbow Fittings	Description	Color	Catalog Number	Description	Color	Catalog Number		
	<b>Internal Elbow</b> For making a 90° internal turn in a raceway run.	Anodized Aluminum	<b>HBLALU7617*</b> A: 6.50" (165.10) B: 6.50" (165.10)		<b>Inverted Internal Elbow</b> For connecting a vertical run of HBLALU7620 with a horizontal run with its cover facing up.	Anodized Aluminum	<b>HBLALU7617N*</b> A: 6.50" (165.10) B: 5.98" (151.89)	
<b>External Elbow</b> For making a 90° external turn in a raceway run.	Anodized Aluminum	<b>HBLALU7618*</b> A: 5.50" (139.70) B: 5.50" (139.70)		<b>Tee</b> For branch connections of two runs of HBLALU7620 Raceway.	Anodized Aluminum	<b>HBLALU7615*</b> A: 9.00" (228.60) B: 10.62" (269.80)		
<b>Flat Elbow</b> For making a 90° flat turn in a raceway run.	Anodized Aluminum	<b>HBLALU7611*</b> A: 11.54" (293.10) B: 11.54" (293.10)						
End Fittings	<b>Entrance End Fitting</b> For feeding raceway, has concentric 1/2 in. and 3/4 in. trade size KOs.	Anodized Aluminum	<b>HBLALU7610B2</b> A: 7.62" (193.50) B: 2.31" (58.70)		<b>Blank End Fitting</b> For closing end of raceway.	Anodized Aluminum	<b>HBLALU7610B</b> A: 7.62" (193.50) B: 2.31" (58.70)	
	<b>Cover Clip</b> To cover seam where lengths of HBLALU7620 Raceway come together.	Stainless Steel	<b>HBLALU7606</b> A: 1.38" (34.92)		<b>Wire Clip</b> For holding conductors in place. Can be used for either HBLALU5000 or HBLALU7620 Raceway.	Anodized Aluminum	<b>HBLALU57WC</b> A: 1.00" (25.40)	
Fittings	<b>Internal Corner Coupling</b> For butting two raceway sections to form an internal 90° turn in a raceway run.	Anodized Aluminum	<b>HBLALU5717A</b> A: 3.50" (88.90) B: 2.38" (60.30)		<b>Grounding Adapter</b> For connection of equipment grounding. #10-32 Locking screws included.	Galvanized Steel	<b>HBLALU5709</b> A: 3.37" (85.50) B: 2.00" (50.83)	
	<b>Couplings (Pair)</b> To join lengths of HBLALU5000 or HBLALU7620 base.	Aluminum	<b>HBLALU5701</b> A: 2.38" (60.30) B: 4.00" (101.80)					

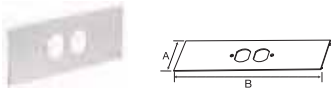
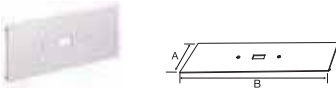
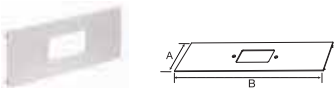
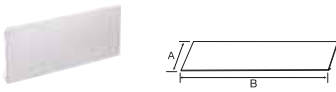
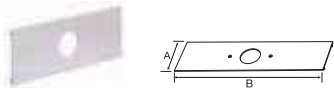
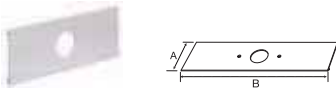
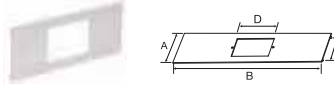
Note: \*HBLALU5701 couplings included.  
 See page R-44 for cover plates.

Dimensions in Inches (mm)

Cover Plates	Description	Color	Catalog Number	Description	Color	Catalog Number		
	<b>Duplex Receptacle Cover</b> For duplex receptacles and duplex communication frames shown on page R-45.	Anodized Aluminum	<b>HBLALU57DR</b> A: 2.54" (64.50) B: 12.00" (304.80)  <b>HBLALU57DRBM</b> (Base Mounted Device) A: 2.54" (64.50) B: 12.00" (304.80)		<b>Toggle Switch Cover</b> For single pole, two pole, three way or four way switches.	Anodized Aluminum	<b>HBLALU57N</b> A: 2.54" (64.50) B: 12.00" (304.80)  <b>HBLALU57NBM</b> (Base Mounted Device) A: 2.54" (64.50) B: 12.00" (304.80)	
	<b>Rectangular Style Line® Cover</b> For Style Line rectangular duplex receptacle, GFCI, surge device or rectangular communication frames shown on page R-45.	Anodized Aluminum	<b>HBLALU57G</b> A: 2.54" (64.50) B: 12.00" (304.80)  <b>HBLALU57GBM</b> (Base Mounted Device) A: 2.54" (64.50) B: 12.00" (304.80)		<b>Blank Cover</b> To cover 12 in. (305.00) section of raceway.	Anodized Aluminum	<b>HBLALU57BL</b> A: 2.54" (64.50) B: 12.00" (304.80)	
	<b>Single Receptacle Cover</b> For single receptacle with face diameters of 1.38 in. to 1.39 in. (35.05 to 35.31).	Anodized Aluminum	<b>HBLALU57E</b> A: 2.54" (64.50) B: 12.00" (304.80)  <b>HBLALU57EBM</b> (Base Mounted Device) A: 2.54" (64.50) B: 12.00" (304.80)		<b>Single Receptacle Cover</b> For single receptacle with face diameters of 1.56 in. to 1.59 in. (39.62 to 40.39).	Anodized Aluminum	<b>HBLALU57F</b> A: 2.54" (64.50) B: 12.00" (304.80)  <b>HBLALU57FBM</b> (Base Mounted Device) A: 2.54" (64.50) B: 12.00" (304.80)	
	<b>Hubbell iSTATION Cover</b> For mounting Hubbell iSTATION modules. IMF1GY or IFPxxGY frames and plates on pages R-45 and R-46.	Anodized Aluminum	<b>HBLALU57LPB</b> A: 2.54" (64.50) B: 12.00" (304.80) C: 1.90 (48.26) D: 3.00" (76.20)		<b>Ortronics® Cover Plate</b> For two Ortronics TracJack® or one Series II® datacom insert. Both bezels included.	Anodized Aluminum	<b>HBLALU57ABRT</b> A: 2.54" (64.50) B: 12.00" (304.80)	
	<b>2-Gang Raised Device Box</b> KP device plates only, found on page R-45.	Gray PVC	<b>HBLALU57KP2G</b> A: 5.08" (129.10) B: 7.64" (193.90)					

**Base Mounted Device Cover Design**

No exposed screw holes. Receptacle is securely mounted to the raceway base rather than the cover.



Ortronics®, Series II® and TracJack® are registered trademarks of The Ortronics Company.



Dimensions in Inches (mm)













# Metal Raceway Device Brackets, Plates and Frames

Communication Outlet Plates and Frames































1. Choose Device Mounting Bracket	<b>Description</b>	<b>Color</b>	<b>HBL4750 Series</b>	<b>HBL6750 Series</b>
	Device Mounting Bracket for HBL4750 and HBL6750 Series Metal Raceway. Ivory metal raceway matches almond devices and plates.	Ivory Gray	 HBL4750IV HBL4750GY	 HBL6750IV HBL6750GY

2. Choose 1-Gang "KP" Plates	<b>Color</b>	<b>Catalog Number</b>	<b>Catalog Number</b>	<b>Catalog Number</b>	<b>Catalog Number</b>	<b>Catalog Number</b>
	Almond Gray	 <b>KP8AL</b> <b>KP8GY</b> Duplex	 <b>KP26AL</b> <b>KP26GY</b> Style Line®	 <b>KP1AL</b> <b>KP1GY</b> Toggle	 <b>KP7AL</b> <b>KP7GY</b> Receptacle (1.41 ID)	 <b>KP720AL</b> <b>KP720GY</b> Receptacle (1.60 ID)
	Almond Gray	 <b>KP14AL</b> <b>KP14GY</b> Blank	 <b>KP212AL</b> <b>KP212GY</b> Coax (2)	 <b>KP2140AL</b> <b>KP2140GY</b> Jack/Coax	 <b>KP2162AL</b> <b>KP2162GY</b> Modular Jacks (2)	 <b>KP2163AL</b> <b>KP2163GY</b> Modular Jacks (3)
Almond Gray	 <b>KPORTAL</b> <b>KPORTGY</b> Ortronics Series II® Data Module	 <b>KPPANAL</b> <b>KPPANGY</b> Panduit Mini-Com® Data Module	 <b>KPIMBZAL</b> <b>KPIMBZGY</b> 3-Unit iSTATION (Accepts all Hubbell iSTATION Modules located in Network Wiring section).			

Comm. "IFP" Plates & Frames	<b>Color</b>	<b>Catalog Number</b>	<b>Catalog Number</b>	<b>Catalog Number</b>	<b>Catalog Number</b>	<b>Catalog Number</b>
	Almond Gray	 <b>IFP126AL</b> — Style Line®	 <b>ISF2AL</b> <b>ISF2GY</b> Style Line® 2-Port	 <b>ISF3AL</b> <b>ISF3GY</b> Style Line® 3-Port	 <b>ISF4AL</b> <b>ISF4GY</b> Style Line® 4-Port	 <b>ISF6AL</b> <b>ISF6GY</b> Style Line® 6-Port
	Almond Gray	 <b>IFP18AL</b> — Duplex	 <b>BR106AL</b> <b>BR106G</b> Duplex 2-Port	 <b>Q106AL</b> <b>Q106G</b> Duplex 4-Port		
Almond Gray	 <b>IFP12AL</b> <b>IFP12GY</b> Flush 2-Port	 <b>IFP13AL</b> <b>IFP13GY</b> Flush 3-Port	 <b>IFP14AL</b> <b>IFP14GY</b> Flush 4-Port	 <b>IFP16AL</b> <b>IFP16GY</b> Flush 6-Port		

Note: Ivory metal raceway matches almond devices and plates. For HBL3000 series raceway applications, catalog number HBL3051LEIV/GY must be used with plates and devices. See page R-46 or section W for additional information on datacom products.



Painted Steel Plates	<b>Color</b>	<b>1-Gang</b>	<b>2-Gang</b>	<b>3-Gang</b>	<b>4-Gang</b>	<b>5-Gang</b>	<b>6-Gang</b>
	Almond Gray	 <b>SP1AL</b> <b>SP1G</b> Toggle	 <b>SP2AL</b> <b>SP2G</b> Toggle	 <b>SP3AL</b> — Toggle	 <b>SP4AL</b> — Toggle	 <b>SP5AL</b> — Toggle	 <b>SP6AL</b> — Toggle
	Almond Gray	 <b>SP8AL</b> <b>SP8G</b> Duplex	 <b>SP82AL</b> <b>SP82G</b> Duplex	 <b>SP83AL</b> — Duplex	 — Duplex	 — Duplex	 — Duplex
	Almond Gray	 <b>PHPS1AL</b> <b>PHPS1G</b> Style Line®	 <b>PHPS2AL</b> <b>PHPS2G</b> Style Line®	 <b>PHPS3AL</b> — Style Line®	 <b>PHPS4AL</b> — Style Line®	 <b>PHPS5AL</b> — Style Line®	 <b>PHPS6AL</b> — Style Line®
	Almond Gray	 <b>SP7AL</b> <b>SP7G</b> Single recept. (1.41" ID)	 <b>SP18AL</b> <b>SP18G</b> Combination	 <b>SP28AL</b> <b>SP28G</b> Combination	 <b>PJS126AL</b> <b>PJS126G</b>	 — <b>PJS226G</b>	
<b>Color</b>	<b>1-Gang</b>	<b>2-Gang</b>	<b>3-Gang</b>	<b>1-Gang</b>	<b>2-Gang</b>	<b>3-Gang</b>	
Almond Gray	 <b>SP14BAL</b> <b>SP14BG</b> Blank, Box Mount	 <b>SP24BAL</b> <b>SP24BG</b> Blank, Box Mount	 <b>SP34BAL</b> — Blank, Box Mount	 <b>SP14AL</b> <b>SP14G</b> Blank, Strap Mount	 <b>SP24AL</b> <b>SP24G</b> Blank, Strap Mount	 <b>SP34AL</b> — Blank, Strap Mount	













Panduit® and Mini-Com® are registered trademarks of Panduit Corp.  
Ortronics® and Series II® are registered trademarks of Ortronics/LeGrand.

# Metal Raceway Frame Modules and Modular Connector Fittings















Communication Outlet Plates and Frames





1. Choose Plate Frame	Description	Color	HBL4750 Series	HBL6750 Series
	Front loading plate will accept any modules in three unit combinations. Angled fixtures to be used in bottom opening only. Use KPIMBZAL/GY plate with modules for HBL4750 and HBL6750 Series device mounting bracket located on page R-45. See section W for additional Hubbell iSTATION modules and datacom products. Ivory metal raceway matches almond devices and plates.	Office White	 IMF1AL IMF1GY	 IMF2AL IMF2GY
<i>Note: Each gang accepts 3 module units.</i>				

2. Choose Modules	Color	Catalog Number	Catalog Number	Catalog Number	Catalog Number	Catalog Number
	Almond Gray	 <b>IMB05AL</b> <b>IMB05GY</b> Blank Module .5 Unit	 <b>IMB1AL</b> <b>IMB1GY</b> Blank Module 1 Unit	 <b>IMB15AL</b> <b>IMB15GY</b> Blank Module 1.5 Unit	 <b>IM1K1AL</b> <b>IM1K1GY</b> Modular Flat 1 Unit	 <b>IM2K1AL</b> <b>IM2K1GY</b> Modular Flat 1 Unit
	Almond Gray	 <b>IM1KA15AL</b> <b>IM1KA15GY</b> Modular Angled 1.5 Unit	 <b>IM2KA15AL</b> <b>IM2KA15GY</b> Modular Angled 1.5 Unit	 <b>IM1SCA15AL</b> <b>IM1SCA15GY</b> SC 1 Duplex Angled, 1.5 Unit	 <b>IM2SCA2AL</b> <b>IM2SCA2GY</b> SC 2 Duplex Angled, 2 Unit	 <b>IM1IA15AL</b> <b>IM1IA15GY</b> Modular Recessed 1.5 Unit
	Almond Gray	 <b>IM2IA15AL</b> <b>IM2IA15GY</b> Modular Recessed 1.5 Unit	<b>Keystone Opening</b> Hole size for mounting all Hubbell Jacks.			 A: .580" (14.73) B: .760" (19.30)

Modular connectors to be used with any plate with a standard modular opening. Not recommended for use with KP plates. For KP applications use KPIMBZAL/GY bezel and appropriate Hubbell iSTATION modules located in the section W. Use appropriate Hubbell iSTATION modules for SC fiber adapters. See section W for additional modular connectors. Ivory metal raceway matches almond devices and plates.

Modular Connector Fittings	Color	Catalog Number	Catalog Number	Catalog Number	Catalog Number	Catalog Number
	Almond Gray	 <b>SFFGAL</b> <b>SFFGGY</b> F-Type Coupler Gold	 <b>SFFALX</b> <b>SFFGX</b> F-Type Coupler Nickel	 <b>SFBAL</b> <b>SFBGY</b> BNC Connector	 <b>SFSV110AL</b> <b>SFSV110GY</b> S-Video 110	 <b>SFSVAL</b> <b>SFSVGY</b> S-Video F/F Coupler
	Almond Gray	 <b>SFRCRFFAL</b> <b>SFRCRFFGY</b> RCA Gold Pass-through F/F Coupler Red Insulator	 <b>SFRCWFFAL</b> <b>SFRCWFFGY</b> RCA Gold Pass-through F/F Coupler White Insulator	 <b>SFRCYFFAL</b> <b>SFRCYFFGY</b> RCA Gold Pass-through F/F Coupler Yellow Insulator	 <b>SFSPGBK*</b> <b>SFSPGR**</b> Speaker Post Connector	 <b>SF35SJAL</b> <b>SF35SJGY</b> 3.5mm Stereo Jacks
	Almond Gray	 <b>SFRC110R</b> (Black housing only) RCA 110 Punchdown Red Insulator	 <b>SFRC110W</b> (Black housing only) RCA 110 Punchdown White Insulator	 <b>SFRC110Y</b> (Black housing only) RCA 110 Punchdown Yellow Insulator	 <b>SFBAL10</b> <b>SFBG10</b> Blank (10 Pack)	

Note: \*Office white housing with black ring color.  
\*\*Office white housing with red ring color.

Xcelerator Modular Jacks	Color	Catalog Number	Catalog Number	Catalog Number
	Almond	 <b>HXJ5EAL</b> Cat. 5e, T568A, T568B, RJ45	 <b>HXJ6AL</b> Cat. 6, T568A, T568B, RJ45	 <b>HXJUAL</b> 6 Position USOC, RJ25

Note: Ivory metal raceway matches almond devices and plates.

### Jack Color Options (Replaces AL Suffix)

OW=Office White	GY=Gray	BK=Black	W=White	OR=Orange	R=Red	Y=Yellow	B=Blue	GN=Green	EI=Elec Ivory
-----------------	---------	----------	---------	-----------	-------	----------	--------	----------	---------------



Metal Raceway Wire Fill Capacities															
Series	Channel Area (sq. in.)	Power (THHN/T90 Nylon)			Voice		Data (Copper Cables)				Data (Multimode Fiber Optic Cables)				
		14 AWG	12 AWG	10 AWG	4-Pair	25-Pair	Type RG59U	Cat. 5e	Cat. 6	Cat. 6A	Cat. 6 STP	(2) or (4) Fiber Round Cable	Fiber Optic Jumpers	Fiber Optic Zip Cord	
		Wire O.D. (in.):	0.111	0.13	0.164	0.19	0.41	0.242	0.21	0.25	0.35	0.29	0.19	0.118	.12 X .24
	Wire Area (sq. in.):	0.0097	0.0133	0.0211	0.0283	0.1320	0.0460	0.0346	0.0491	0.0962	0.0660	0.0283	0.0109	0.0288	
	Wire Fill Capacity	40%			40%	40%	40%	40%	40%	40%	40%	40%	40%	40%	
HBL500		0.22	7	5	3	3	1	2	3	2	1	1	3	8	3
HBL750		0.40	12	9	5	6	1	3	5	3	2	2	6	15	6
HBL2000		0.89	7	7	0	13	3	8	10	7	4	5	13	33	12
HBL2000A		0.86	35	26	16	11	2	7	9	7	4	5	13	33	12
HBL2400		1.39	57	41	26	19	4	12	16	11	5	8	19	51	19
HBL2400D	Channel- A	0.86	26	19	11	12	2	7	9	7	3	5	12	31	11
	Channel- B	0.37	11	9	6	5	1	3	4	3	1	2	5	13	5
HBL3000		3.70	152	111	70	52	11	32	43	30	15	22	52	136	51
HBL4750	No Barriers	7.20	296	216	136	102	22	63	83	59	30	44	102	264	100
	Barrier Centered Ch. A	3.10	127	93	58	44	9	27	36	25	13	19	44	114	43
	Barrier Centered Ch. B	3.30	127	93	58	47	10	29	38	27	14	20	47	121	46
	Barrier Offset Ch. A	2.10	86	63	39	30	6	18	24	17	9	13	30	77	29
	Barrier Offset Ch. B	4.30	176	129	81	61	13	37	50	35	18	26	61	158	60
HBL6750	No Barriers	13.77	566	412	259	195	42	120	159	112	57	83	195	505	191
	Barrier Offset 1/3 Ch. A	4.59	189	138	86	65	14	40	53	37	19	28	65	168	64
	Barrier Offset 2/3 Ch. B	9.18	379	278	173	130	28	80	106	75	38	56	130	337	128
HBLALU2000		1.20	49	36	22	16	3	10	13	9	4	7	16	44	16
HBLALU3800		5.80	214	156	98	82	18	50	67	47	24	35	82	213	81
HBLALU4800	Center Barrier/ Both Channels	11.60	428	312	196	164	35	101	134	95	48	70	164	426	161
	Center Barrier/ 1 Channel	5.80	214	156	98	82	18	50	67	47	24	35	82	213	81
HBLALU5000	Center Barrier/ Both Channels	7.60	312	228	142	106	22	64	86	60	30	46	106	278	104
	Center Barrier/ 1 Channel	3.80	156	114	71	53	11	32	43	30	15	23	53	139	52
HBLALU7620	2 Barriers with 3 Equal Channels/Total	15.00	618	450	282	210	45	129	171	120	60	90	210	549	207
	2 Barriers with 3 Equal Channels/ 1 Channel	5.00	206	150	94	70	15	43	57	40	20	30	70	183	69

Note: Pathway (Raceway) fill shall be 40% maximum. Raceway fittings and outlets/receptacles reduce the cross section of the raceway system, thus reducing overall cable fill capacity.

**Physical Properties**

Material Galvanized Steel or Anodized Aluminum

**Metal PlugTrak Specifications**

Receptacle Rating NEMA 5-15R and NEMA 5-20R  
 Wire #12 AWG Stranded Copper  
 Receptacle Face Thermoplastic

**Codes/Standards**

TIA/EIA 569B  
 UL Standard UL 5  
 Listings E253976 /E253830 /E253833  
 CSA Standard C22.2 no. 62  
 Certification LR87514

# Metal Raceway Cross Reference

HBL500, HBL750 and HBL2000 Series

Hubbell Catalog Number	Wiremold®	Mono-Systems, Inc.™
<b>HBL500 Series</b>	<b>500 Series</b>	
HBL502B	502	SMS502
HBL605CUT	605	SMS605
HBL600B	600B	N/A
HBL605K	605K	N/A
HBL500TFIV	N/A	N/A
HBL50010IV	V500	SMS500
HBL5005IV	V500-5	N/A
HBL504IV	V504	SMS504
HBL506IV	V506	SMS506
HBL511IV	V511	SMS511
HBL512IV	V512	SMS512
HBL517IV	V517	SMS517
HBL518IV	V518	SMS518

Hubbell Catalog Number	Wiremold®	Mono-Systems, Inc.™
<b>HBL750 Series</b>	<b>700 Series</b>	
HBL607CUT	607	SMS607
HBL702B	702	SMS702
HBL607K	607K	N/A
HBL750TFIV	N/A	N/A
HBL75010IV	V700	SMS700
HBL7505IV	V700-5	N/A
HBL704IV	V704	SMS704
HBL706IV	V706	SMS706
HBL711IV	V711	SMS711
HBL712IV	V712	SMS712
HBL717IV	V717	SMS717
HBL718IV	V718	SMS718

Hubbell Catalog Number	Wiremold®	Mono-Systems, Inc.™
<b>HBL500/HBL750 Series</b>	<b>500/700 Series</b>	
HBL5701C	5701	SMS5701
HBL5709	5709	SMS5709
HBL5780	5780	SMS5780
HBL5781	5781	SMS5781
HBL5782C	5782	SMS5782
HBL5791	5791	N/A
HBL5709GC	5709GC	N/A
HBL5781A	5781A	SMS5781A
HBL5782A	5782A	SMS5782A
HBL5790B	5790B	SMS5790B
HBL5752R	R5752	SMS5752R
HBL5753R	R5753	SMS5753R
HBL5700FIV	V5700F	SMS5700F
HBL5703IV	V5703	SMS5703
HBL5711LHIV	V5711LH	SMS5711LH
HBL5711RHIV	V5711RH	SMS5711RH
HBL5715IV	V5715	SMS5715
HBL5719IV	V5719	SMS5719
HBL57242IV	V57242	SMS57242
HBL5731IV	V5731	SMS5731
HBL5733IV	V5733	SMS5733
HBL5735IV	V5735	SMS5735
HBL5736IV	V5736	SMS5736
HBL5737IV	V5737	SMS5737
HBL5737AIV	V5737A	SMS5737A
HBL5738IV	V5738	SMS5738
HBL5738AIV	V5738A	SMS5738A
HBL5738AFIV	V5738AF	SMS5738AF
HBL5739IV	V5739	SMS5739
HBL5739AIV	V5739A	SMS5739A
HBL5744IV	V5744	SMS5744
HBL57442IV	V5744-2	SMS57442
HBL57443IV	V5744-3	SMS57443
HBL5744SIV	V5744S	SMS5744S
HBL5744S2IV	V5744S-2	SMS5744S2
HBL5744S3IV	V5744S-3	SMS5744S3
HBL5745IV	V5745	SMS5745
HBL5747IV	V5747	SMS5747

Hubbell Catalog Number	Wiremold®	Mono-Systems, Inc.™
HBL57472IV	V5747-2	SMS57472
HBL57473IV	V5747-3	SMS57473
HBL5748IV	V5748	SMS5748
HBL57482IV	V5748-2	SMS57482
HBL57483IV	V5748-3	SMS57483
HBL57484IV	V5748-4	SMS57484
HBL57485IV	V5748-5	SMS57485
HBL57486IV	V5748-6	SMS57486
HBL5751IV	V5751	SMS5751
HBL57512IV	V5751-2	SMS5751-2
HBL57513IV	V5751-3	SMS5751-3
HBL5751AIV	V5751A	N/A
HBL5752IV	V5752	SMS5752
HBL5753IV	V5753	SMS5753
HBL5760IV	V5760	SMS5760
HBL5783IV	V5783	SMS5783
HBL5784IV	V5784	SMS5784
HBL5785IV	V5785	SMS5785
HBL5786IV	V5786	SMS5786
HBL5786AIV	N/A	N/A
HBL5711BRIV	N/A	SMS5711-1
HBL5715BRIV	N/A	N/A
HBL5717BRIV	N/A	SMS5717-1
HBL5718BRIV	N/A	SMS5718-1

Hubbell Catalog Number	Wiremold®	Mono-Systems, Inc.™
<b>HBL2000 Series</b>	<b>2000 Series</b>	
HBL620C	620	SMS621BC
HBL2001C	2001	SMS2101
HBL2003SC	2003	SMS2103
HBL2009GC	2009	SMS2109
HBL2000WC	2000WC	SMS2100WC
HBL2000WCA	N/A	N/A
HBL2017TC	2017TC	SMS2117TC
HBL620BCK	620BCK	N/A
HBL2000B5GY	G2000B-5	N/A
HBL2000BCGY	G2000BC	N/A
HBL2000BCAGY	N/A	N/A
HBL2000CGY	G2000C	N/A
HBL2000CAGY	G2100C	N/A
HBL2006GY	G2006	N/A
HBL2010A2GY	G2010A2	N/A
HBL2010A3GY	G2010A3	N/A
HBL2010BGY	G2010B	N/A
HBL2011GY	G2011	N/A
HBL2011BRGY	N/A	N/A
HBL2015GY	G2015	N/A
HBL2015BRGY	N/A	N/A
HBL2017BRGY	N/A	N/A
HBL2018BRGY	N/A	N/A
HBL2018CGY	G2018C	N/A
HBL2048GY	G2048	N/A
HBL20482GY	G2048-2	N/A
HBL2051HGY	G2051H	N/A
HBL2000TFIV	N/A	N/A
HBL2000TFGY	N/A	N/A
HBL2000B5IV	V2000B-5	N/A
HBL2000BCIV	V2000BC	SMS2100B
HBL2000BCAIV	N/A	N/A
HBL2000CIV	V2000C	SMS2100C
HBL2000CAIV	V2100C	SMS2100C
HBL2006IV	V2006	SMS2106
HBL2010A2IV	V2010A2	SMS2110A
HBL2010A3IV	V2010A3	SMS2110C
HBL2010BIV	V2010B	SMS2110B
HBL2011IV	V2011	SMS2111
HBL2011BRIV	N/A	SMS2111-FO
HBL2015IV	V2015	SMS2115
HBL2015BRIV	N/A	SMS2115-FO
HBL2017BRIV	N/A	SMS2117TC-FO

Wiremold® is a registered trademark of The Wiremold Company. Mono-Systems, Inc.™ is a trademark of Mono-Systems, Inc. Hubbell Inc. is not affiliated with Mono-Systems, Inc.™ or The Wiremold Company.

# Metal Raceway Cross Reference

HBL2400/HBL2400D, HBL3000 and HBL4750 Series

Hubbell Catalog Number	Wiremold®	Mono- Systems, Inc.™	Hubbell Catalog Number	Wiremold®	Mono- Systems, Inc.™
HBL2018BRIV	N/A	SMS2118A-FO	HBL3007CGY	G3007C	SMS3022
HBL2018CIV	V2018C	SMS2118A	HBL3010AEGY	G3010AE	SMS3005
HBL2048IV	V2048	SMS2141	HBL3010BGY	G3010B	SMS3004
HBL20482IV	V2048-2	SMS21412	HBL3010CGY	G3010C	SMS3005
HBL2051HIV	V2051H	SMS2051H	HBL3011EGY	G3011E	SMS3009
HBL2089IV	V2089	N/A	HBL3014CGY	G3014C	SMS3030
HBL2089EIV	V2089E	N/A	HBL3015EGY	G3015E	SMS3010
			HBL3017TCEGY	G3017TCE	SMS3014
<b>HBL2400/HBL2400D Series</b>	<b>2400/2400D Series</b>		HBL3018AEGY	G3018AE	SMS3018
HBL624CUT	624	N/A	HBL3027AEGY	G3027AE	N/A
HBL2401C	2401	SMS2401	HBL3028GY	G3028	SMS3028
HBL2409GC	2409	SMS2409	HBL3033JEGY	G3033JE	SMS3045
HBL2400WC	2400WC	SMS2400WC	HBL3036HEGY	G3036HE	SMS3053
HBL2401DC	2401D	N/A	HBL3040CEGY	G3040CE	SMS3048
HBL624BCK	624BCK	N/A	HBL3043BEGY	G3043BE	SMS3046
HBL24DRK	N/A	N/A	HBL30442GY	G3044-2	SMS3062
HBL24SRK	N/A	N/A	HBL3046BEGY	G3046BE	N/A
HBL24106DRK	N/A	N/A	HBL3046H2GY	G3046H-2	N/A
HBL24106RRK	N/A	N/A	HBL3048RGY	G3048R	SMS3023
HBL4724REDIV	N/A	N/A	HBL3051LEGY	G3051LE	SMS3051
HBL2420REDIV	N/A	N/A	HBL3082GY	G3082	N/A
HBL2400TFIV	N/A	N/A	HBL3086GY	G3086	SMS3086
HBL2400DTFIV	N/A	N/A	HBL3200REDIV	N/A	N/A
HBL2400BIV	V2400B	N/A	HBL3200REDGY	N/A	N/A
HBL2400B10IV	V2400B-10	SMS2400B	HBL3000TFIV	N/A	N/A
HBL2400BCIV	V2400BC	N/A	HBL3000TFGY	N/A	N/A
HBL2400BDIV	V2400BD	SMS2400BD	HBL3000BIV	V3000B	SMS3000-I
HBL2400CIV	V2400C	SMS2400C	HBL3000C075IV	V3000C075	N/A
HBL2406IV	V2406	SMS2406	HBL3000C195IV	V3000C195	N/A
HBL2410AIV	V2410A	N/A	HBL3000CEIV	V3000CE	SMS3003-I
HBL2410BIV	V2410B	SMS2410B	HBL3003IV	V3003	SMS3008-I
HBL2410BDIV	V2410BD	N/A	HBL3006EIV	V3006E	SMS3007-I
HBL2410CIV	V2410C	N/A	HBL3010AEIV	V3010AE	SMS3005-I
HBL2410DFOIV	V2410DFO	N/A	HBL3010BIV	V3010B	SMS3004-I
HBL2410FCIV	V2410FC	SMS2410C	HBL3010CIV	V3010C	SMS3005-I
HBL2411DFOIV	V2411DFO	SMS2411DFO	HBL3011EIV	V3011E	SMS3009-I
HBL2415DFOIV	V2411DFO	SMS2415DFO	HBL3014CIV	V3014C	SMS3030-I
HBL2411IV	V2411FO	SMS2411FO	HBL3015EIV	V3015E	SMS3010-I
HBL2415IV	V2415FO	SMS2415FO	HBL3017TCEIV	V3017TCE	SMS3014-I
HBL2417DFOIV	V2417DFO	SMS2417DFO	HBL3018AEIV	V3018AE	SMS3018-I
HBL2417IV	V2417FO	SMS2417FO	HBL3027AEIV	V3027AE	N/A
HBL2418DFOIV	V2418DFO	SMS2418DFO	HBL3028IV	V3028	SMS3028-I
HBL2418IV	V2418FO	SMS2418FO	HBL3033JEIV	V3033JE	SMS3045-I
HBL2426IV	V2426	N/A	HBL3036HEIV	V3036HE	SMS3053-I
HBL2444IV	V2444	SMS2444	HBL3040CEIV	V3040CE	SMS3048-I
HBL24442IV	V2444-2	SMS2444-2	HBL3043BEIV	V3043BE	SMS3046-I
HBL2444DIV	V2444D	SMS2444D	HBL30442IV	V3044-2	SMS3062-I
HBL2444D2AIV	V2444D-2A	SMS2444D-2	HBL3046BEIV	V3046BE	N/A
HBL2448IV	V2448	SMS2448	HBL3046H2IV	V3046H-2	N/A
HBL24482IV	V2448-2	N/A	HBL3048RIV	V3048R	SMS3023-I
HBL2451HIV	V2451H	N/A	HBL3051LEIV	V3051LE	SMS3051-I
HBL2475DBRIV	V2475D	SMS2457B	HBL3086IV	V3086	SMS3086-I
HBL2489IV	V2489	N/A			
<b>HBL3000 Series</b>	<b>3000 Series</b>		<b>HBL4750 Series</b>	<b>4000 Series</b>	
HBL630B	630B	SMS632B	HBL4751AC	4001A	SMS4202
HBL630BDK	630BDK	N/A	HBL4750IV	V4050	N/A
HBL630C	630C	SMS632C	HBL640C	640C	SMS642C
HBL630CDK	630CDK	N/A	HBL4750B10GY	G4000B-10	SMS4200
HBL3000BGY	G3000B	SMS3200	HBL4750C075GY	G4000C075	SMS4261
HBL3000C075GY	G3000C075	N/A	HBL4750C195GY	G4000C195	SMS4265
HBL3000C195GY	G3000C195	N/A	HBL640B	640B	SMS642B
HBL3000CEGY	G3000CE	SMS3003	HBL4747RXIV	V4047RX	N/A
HBL3000WCGY	G3000WC	SMS3006	HBL4747RFIV	V4047RF	N/A
HBL3001GY	G3001	SMS3002	HBL4747C1GY	G4047C-1	N/A
HBL3001AGY	G3001A	SMS3001	HBL4747BXGY	G4047BX	N/A
HBL3003GY	G3003	SMS3008	HBL4747RXGY	G4047RX	N/A
HBL3006EGY	G3006E	SMS3007	HBL4747RFGY	G4047RF	N/A
			HBL4747JXGY	G4047JX	N/A
			HBL4747C2GY	G4047C-2	N/A

Wiremold® is a registered trademark of The Wiremold Company. Mono-Systems, Inc.™ is a trademark of Mono-Systems, Inc. Hubbell Inc. is not affiliated with Mono-Systems, Inc.™ or The Wiremold Company.

# Metal Raceway HBL4750 and HBL6750 Series

HBL4750 and HBL6750 Series

Hubbell Catalog Number	Wiremold®	Mono- Systems, Inc.™
HBL4715DFOGY	G4015DFO	SMS4211FO
HBL4717NGY	G4017N	N/A
HBL4746H2GY	G4046H-2	N/A
HBL4718DFOGY	G4018FO	SMS4218FO
HBL47472BBFFGY	G4047-2BBFF	N/A
HBL47472BBBBGY	G4047-2BBBB	N/A
HBL47472BBSSGY	G4047-2BBSS	N/A
HBL47472BBXXGY	G4047-2BBXX	N/A
HBL47472BBTTGY	G4047-2BBTT	N/A
HBL4747AXGY	G4047AX	N/A
HBL47472RRXXGY	G4047-2RRXX	N/A
HBL4747BFGY	G4047BF	N/A
HBL4747BBGY	G4047BB	N/A
HBL4747BRGY	N/A	N/A
HBL4747BRIV	N/A	N/A
HBL4747BTGY	G4047BT	N/A
HBL4747BSGY	G4047BS	N/A
HBL4774AGY	G4074A	N/A
HBL4750GY	G4050	N/A
HBL47472RRXXIV	V4047-2RRXX	N/A
HBL47472BBXXIV	V4047-2BBXX	N/A
HBL4747BBIV	V4047BB	N/A
HBL4747AXIV	V4047AX	N/A
HBL4747BFIV	V4047BF	N/A
HBL4747BTIV	V4047BT	N/A
HBL4747BSIV	V4047BS	N/A
HBL4747C1IV	V4047C-1	N/A
HBL4747BXIV	V4047BX	N/A
HBL4747JXIV	V4047JX	N/A
HBL4747C2IV	V4047C-2	N/A
HBL4750CIV	V4000C	SMS4203-I
HBL4750B10IV	V4000B-10	SMS4200-I
HBL4750C315IV	V4000C315	SMS4267-I
HBL4750C195IV	V4000C195	SMS4265-I
HBL4711DFOIV	V4011FO	SMS4209FI
HBL4711IV	V4011	SMS4209-I
HBL4710DFOIV	V4010DFO	SMS4205-I
HBL4710IV	V4010	SMS4205-I
HBL4710BIV	V4010B	SMS4204-I
HBL4756AIV	V4006	N/A
HBL4714AIV	V4014A	SMS4230-I
HBL4712TXIV	V4012TX	SMS4215-I
HBL4750C135IV	V4000C135	SMS4263-I
HBL4750C075IV	V4000C075	SMS4261-I
HBL4717DFOIV	V4017FO	SMS4214FI
HBL4717IV	V4017	SMS4214-I
HBL4715DFOIV	V4015DFO	SMS4211FI
HBL4715IV	V4015	SMS4211-I
HBL4718DFOIV	V4018FO	SMS4218FI
HBL4718IV	V4018	SMS4218-I
HBL4717NIV	V4017N	N/A
HBL47472BBBBIV	V4047-2BBBB	N/A
HBL4746H2IV	V4046H-2	N/A
HBL47472BBTTIV	V4047-2BBTT	N/A
HBL47472BBSSIV	V4047-2BBSS	N/A
HBL4747CVMGY	G6007C-1	N/A
HBL4786AGY	G4086A	SMS4286
HBL4750TFIV	N/A	N/A
HBL4747CVM2GY	G6007C-2	N/A
HBL4750BP	N/A	N/A
HBL4750TFGY	N/A	N/A
HBL4756GY	G4006	N/A
HBL4751DA	4001DA	SMS4201
HBL640BDK	640BDK	N/A
HBL640CDK	640CDK	N/A
HBL4750CGY	G4000C	SMS4203
HBL4750C135GY	G4000C135	SMS4263
HBL4750C315GY	G4000C315	SMS4267
HBL4750DGY	G4000D	SMS4207

Hubbell Catalog Number	Wiremold®	Mono- Systems, Inc.™	
HBL4750WCGY	G4000WC	SMS4206	
HBL4710BGY	G4010B	SMS4204	
HBL4710DFOGY	G4010DFO	SMS4205	
HBL4710GY	G4010	SMS4205	
HBL4711DFOGY	G4011FO	SMS4209FO	
HBL4711GY	G4011	SMS4209	
HBL4712TXGY	G4012TX	SMS4215	
HBL4714AGY	G4014A	SMS4230	
HBL4717DFOGY	G4017FO	SMS4214FO	
HBL4717GY	G4017	SMS4214	
HBL4717TCAGY	G4017TCA	N/A	
HBL4774AIV	V4074A	N/A	
HBL4786AIV	V4086A	SMS4286-I	
HBL4747CVMIV	V6007C-1	N/A	
HBL4747CVM2IV	V6007C-2	N/A	
<b>HBL6750 Series</b>		<b>6000 Series</b>	
HBL6751A	6001A	SMS4402	
HBL660C	640C	SMS644C	
HBL660CDK	640CDK	N/A	
HBL660B	660B	SMS644B	
HBL660BDK	660BDK	N/A	
HBL6718DFOGY	G4018FO	N/A	
HBL6718GY	G6017TX	SMS4418	
HBL6746HHGY	G4046H-2	N/A	
HBL67473BBBBBBGY		(4000 Series 2-Gang) G4047-2BBBB	N/A
HBL67473BBBBFFGY		(4000 Series 2-Gang) G4047-2BBFF	N/A
HBL67473BBBBSSGY		(4000 Series 2-Gang) G4047-2BBSS	N/A
HBL67473BBBBTTGY		(4000 Series 2-Gang) G4047-2BBTT	N/A
HBL67473BBBBXXGY		(4000 Series 2-Gang) G4047-2BBXX	N/A
HBL6747AXXGY		(4000 Series 2-Gang) G4047AX	N/A
HBL6747BBBGY		(4000 Series 2-Gang) G4047BB	N/A
HBL6747BBFGY		(4000 Series 2-Gang) G4047BF	N/A
HBL6747BBSGY		(4000 Series 2-Gang) G4047BS	N/A
HBL6747BBTGY		(4000 Series 2-Gang) G4047BT	N/A
HBL6747BXXGY		(4000 Series 2-Gang) G4047BX	N/A
HBL6747C1GY		(4000 Series 2-Gang) V4047C-1 (4000 Series 1-Gang Overlapping)	N/A
HBL6747C2GY		(4000 Series 2-Gang) V4047C-2 (4000 Series 2-Gang Overlapping)	N/A
HBL6747JXXGY		(4000 Series 2-Gang) G4047JX	N/A
HBL6747RRFGY		(4000 Series 2-Gang) G4047RF	N/A
HBL6747RXXGY		(4000 Series 2-Gang) G4047RX	N/A
HBL67473RRRRXXGY		(4000 Series 2-Gang) G4047-2RRRX	N/A
HBL6750GY	G4050	N/A	
HBL6750B10GY	G6000B-10	SMS4400	
HBL6750CGY	G6000C	SMS4203	
HBL6750DAGY	G6000DA	SMS4407	
HBL6750WCGY	G6000WC	SMS4406	
HBL6751DAGY	G6001DA	SMS4401	
HBL6756AGY	G6006	SMS4408	
HBL6710BGY	G6010B	SMS4404	
HBL6711DFOGY	G6011TX	SMS4419	
HBL6711GY	G6011TX	SMS4419	

Wiremold® is a registered trademark of The Wiremold Company. Mono-Systems, Inc.™ is a trademark of Mono-Systems, Inc. Hubbell Inc. is not affiliated with Mono-Systems, Inc.™ or The Wiremold Company.

# Metal Raceway

## HBL6750 Series and Metal PlugTrak®

HBL6750 Series, Metal PlugTrak®, HBLALU2000, Aluminum PlugTrak®, HBLALU3800 and HBLALU4800 Series

Hubbell Catalog Number	Wiremold®	Mono-Systems, Inc.™	Hubbell Catalog Number	Wiremold®	Mono-Systems, Inc.™
HBL6712TXGY	G6012TX	SMS4415	HBL6711IV	V6011TX	SMS4419-I
HBL6714AGY	G6014A	SMS4430	HBL6712TXIV	V6012TX	SMS4415-I
HBL6717DFOGY	G6017TX	SMS4418	HBL6714AIV	V6014A	SMS4430-I
HBL6717GY	G6017TX	SMS4418	HBL6774AIV	V6074A	SMS4473-I
HBL6774AGY	G6074A	SMS4473	HBL6786IV	V6086	SMS4486-I
HBL6786GY	G6086	SMS4486			
HBL6750C075IV	N/A	N/A	<b>Metal PlugTrak®</b>	<b>Metal Plugmold®</b>	
HBL6750C075GY	N/A	N/A	HBL20C215IV	V20-C2	SSC40
HBL6750C135IV	N/A	N/A	HBL20C215GY	G20-C2	N/A
HBL6750C135GY	N/A	N/A	HBL20C315IV	N/A	SSC52
HBL6750C195IV	N/A	N/A	HBL20C315GY	N/A	N/A
HBL6750C195GY	N/A	N/A	HBL20GB306GY	G20GB306	N/A
HBL6750C315IV	N/A	N/A	HBL20IG306GY	G20IG306	N/A
HBL6750C315GY	N/A	N/A	HBL20GB506GY	G20GB506	N/A
HBL6715DFOIV	N/A	SMS4410-I	HBL20GB512GY	G20GB512	N/A
HBL6715IV	N/A	SMS4410-I	HBL20GB606GY	G20GB606	N/A
HBL6715DFOGY	N/A	N/A	HBL20GB609GY	G20GB609	N/A
HBL6715GY	N/A	SMS4410	HBL20GB612GY	G20GB612	N/A
HBL6717NIV	N/A	N/A	HBL20GB618GY	G20GB618	N/A
HBL6717NGY	N/A	N/A	HBL20GBA512GY	G20GBA512	N/A
HBL6717TCAGY	N/A	N/A	HBL20GBA609GY	G20GBA609	N/A
HBL6710DFOIV	N/A	N/A	HBL20GBA612GY	G20GBA612	N/A
HBL6710DFOGY	N/A	N/A	HBL20GBA618GY	G20GBA618	N/A
HBL6750TFIV	N/A	N/A	HBL20IG512GY	G20IG512	N/A
HBL6750TFGY	N/A	N/A	HBL20IG606GY	G20IG606	N/A
HBL6718DFOIV	V4018FO	N/A	HBL24GB306GY	G24GB306	N/A
HBL6746HHHIV	V4046H-2	N/A	HBL24GB506GY	G24GB506	N/A
	(4000 Series 2-Gang)		HBL24GB512GY	G24GB512	N/A
HBL67473BBBBXXGY	V4047-2BBBB	N/A	HBL24GBA512GY	G24GBA512	N/A
	(4000 Series 2-Gang)		HBL24GB606GY	G24GB606	N/A
HBL67473BBBBFFIV	V4047-2BBFF	N/A	HBL24GB612GY	G24GB612	N/A
	(4000 Series 2-Gang)		HBL24GB618GY	G24GB618	N/A
HBL67473BBBBSSIV	V4047-2BBSS	N/A	HBL24GBA612GY	G24GBA612	N/A
	(4000 Series 2-Gang)		HBL24GBA618GY	G24GBA618	N/A
HBL67473BBBBTTIV	V4047-2BBTT	N/A	HBL20GB306IV	V20GB306	19GB306
	(4000 Series 2-Gang)		HBL20IG306IV	V20IG306	19IG306
HBL67473BBBBXXIV	V4047-2BBXX	N/A	HBL20GB506IV	V20GB506	19GB506
	(4000 Series 2-Gang)		HBL20GB512IV	V20GB512	19GB512
HBL6747AXXIV	V4047AX	N/A	HBL20GB606IV	V20GB606	19GB606
	(4000 Series 2-Gang)		HBL20GB609IV	V20GB609	19GB609
HBL6747BBBIV	V4047BB	N/A	HBL20GB612IV	V20GB612	19GB612
	(4000 Series 2-Gang)		HBL20GB618IV	V20GB618	19GB618
HBL6747BBFIV	V4047BF	N/A	HBL20GBA512IV	V20GBA512	19GBA512
	(4000 Series 2-Gang)		HBL20GBA609IV	V20GBA609	19GBA609
HBL6747BBSIV	V4047BS	N/A	HBL20GBA612IV	V20GBA612	19GBA612
	(4000 Series 2-Gang)		HBL20GBA618IV	V20GBA618	19GBA618
HBL6747BBTIV	V4047BT	N/A	HBL20IG512IV	V20IG512	19IG512
	(4000 Series 2-Gang)		HBL20IG606IV	V20IG606	19IG606
HBL6747BXXIV	V4047BX	N/A	HBL24GB306IV	V24GB306	192GB306
	(4000 Series 2-Gang)		HBL24GB506IV	V24GB506	192GB506
HBL6747C1IV	V4047C-1 (4000 Series 1-Gang Overlapping)	N/A	HBL24GB512IV	V24GB512	192GB512
	(4000 Series 2-Gang)		HBL24GBA512IV	V24GBA512	192GBA512
HBL6747C2IV	V4047C-2 (4000 Series 2-Gang Overlapping)	N/A	HBL24GB606IV	V24GB606	192GB606
	(4000 Series 2-Gang)		HBL24GB612IV	V24GB612	192GB612
HBL6747JXXIV	V4047JX	N/A	HBL24GB618IV	V24GB618	192GB618
	(4000 Series 2-Gang)		HBL24GBA612IV	V24GBA612	192GBA612
HBL6747RRFIV	V4047RF	N/A	HBL24GBA618IV	V24GBA618	192GBA618
	(4000 Series 2-Gang)				
HBL6747RXXIV	V4047RX	N/A	<b>HBLALU2000 Series</b>	<b>ALA2000 Series</b>	
	(4000 Series 2-Gang)		HBLALU2000B10	AL2000B-10	N/A
HBL67473RRRRXXIV	V4047-2RRXX	N/A	HBLALU2000B5	AL2000B-5	N/A
	(4000 Series 2-Gang)		HBLALU2000C5	AL2000C-5	N/A
HBL6750IV	V4050	N/A	HBLALU2000WC	AL2000WC	N/A
HBL6750B10IV	V6000B-10	SMS4400-I	HBLALU2001	AL2001	N/A
HBL6750CIV	V6000C	SMS4203-I	HBLALU2003	AL2003	N/A
HBL6756AIV	V6006	SMS4408-I	HBLALU2006	AL2006	N/A
HBL6710BIV	V6010B	SMS4404-I	HBLALU2009	AL2009	N/A
HBL6711DFOIV	V6011TX	SMS4419-I	HBLALU2010A	AL2010A	N/A

Wiremold® is a registered trademark of The Wiremold Company. Mono-Systems, Inc.™ is a trademark of Mono-Systems, Inc. Hubbell Inc. is not affiliated with Mono-Systems, Inc.™ or The Wiremold Company.

## Metal Raceway

# HBL6750 Series and Metal PlugTrak®

HBLALU2000, Aluminum PlugTrak®, HBLALU3800 and HBLALU4800 Series

Hubbell Catalog Number	Wiremold®	Mono-Systems, Inc.™
HBLALU2010B	AL2010B	N/A
HBLALU2011	AL2011	N/A
HBLALU2015	AL2015	N/A
HBLALU2017	AL2017	N/A
HBLALU2018	AL2018	N/A
HBLALU2038	AL2038	N/A
HBLALU2040A	AL2040A	N/A
HBLALU2043	AL2043	N/A
HBLALU2044	AL2044	N/A
HBLALU20442	AL2044-2	N/A
HBLALU2047	AL2047	N/A
HBLALU20472	AL2047-2	N/A
HBLALU2051H	AL2051H	N/A

Aluminum PlugTrak®	Aluminum Plugmold®	
HBLALU20GB306	AL20GB306	N/A
HBLALU20GB506	AL20GB506	N/A
HBLALU20GB512	AL20GB512	N/A
HBLALU20GB606	AL20GB606	N/A
HBLALU20GB612	AL20GB612	N/A
HBLALU20GB618	AL20GB618	N/A
HBLALU20GBA606	AL20GBA606	N/A
HBLALU20GBA612	AL20GBA612	N/A
HBLALU20GBA618	AL20GBA618	N/A
HBLALU20IG306	AL20IG306	N/A
HBLALU20IG506	AL20IG506	N/A
HBLALU20IG606	AL20IG606	N/A
HBLALU24GB306	N/A	N/A
HBLALU24IG306	N/A	N/A
HBLALU24GB506	N/A	N/A
HBLALU24GB512	N/A	N/A
HBLALU24IG506	N/A	N/A
HBLALU24GB606	N/A	N/A
HBLALU24GB612	N/A	N/A
HBLALU24GB618	N/A	N/A
HBLALU24GBA606	N/A	N/A
HBLALU24GBA612	N/A	N/A
HBLALU24GBA618	N/A	N/A
HBLALU24IG606	N/A	N/A

HBLALU3800 Series	ALA3800 Series	
HBLALU3800B10	ALA3800B-10	SWA3300
HBLALU3806	ALA3806	SWA3306
HBLALU3810B	ALA3810B	SWA3304
HBLALU3810B1	ALA3810B1	SWA3304
HBLALU3811	ALA3811	SWA3309
HBLALU3815	ALA3815	SWA3310
HBLALU3817	ALA3817	SWA3314
HBLALU3817N	ALA3817N	N/A
HBLALU3818	ALA3818	SWA3318
HBLALUC5	ALAC-5	SWA3303
HBLALUWC	ALAWC	N/A

Hubbell Catalog Number	Wiremold®	Mono-Systems, Inc.™
<b>HBLALU4800 Series</b>		
HBLALU01	ALA01	SWA4802
HBLALU09	ALA09	SWA33GC
HBLALU17A	ALA17A	N/A
HBLALU4800B10	ALA4800B-10	SWA4804
HBLALU4806	ALA4806	SWA4806
HBLALU4810B	ALA4810B	SWA4804
HBLALU4810B2	ALA4810B2	SWA4804
HBLALU4811	ALA4811	SWA4809
HBLALU4815	ALA4815	SWA4810
HBLALU4817	ALA4817	SWA4814
HBLALU4817N	ALA4817N	SWA4817
HBLALU4818	ALA4818	SWA4818
HBLALUABRT	ALA-ABRT	N/A
HBLALUBL	ALA-BL	N/A
HBLALUDR	ALA-DR	SWA3346/SWA4846
HBLALUE	ALA-E	SWA3325/SWA4825
HBLALUF	ALA-F	SWA3345/SWA4826
HBLALUG	ALA-G	SWA3323/SWA4823
HBLALUJ	ALA-J	SWA4845
HBLALUN	ALA-N	SWA3348/SWA4848
HBLALULPB	N/A	N/A

Touch-Up Paint	Touch-Up Paint	
HBLGWEP	GWE-S	SMSPT-G
HBLIWE	IWE-S	SMSPT-I

Wiremold® is a registered trademark of The Wiremold Company. Mono-Systems, Inc.™ is a trademark of Mono-Systems, Inc. Hubbell Inc. is not affiliated with Mono-Systems, Inc.™ or The Wiremold Company.

# Non-Metallic Raceway Hubbell PolyTrak® Non-Metallic Surface Raceway

Features and Benefits



## Complete Line of Raceway

- PolyTrak® Non-Metallic Surface Raceway is a complete system with raceway, fittings, boxes and devices.
- Sizes range from single channel PremiseTrak® to three channel Super BaseTrak® for all types of surface raceway requirements.
- Single and two channel latching raceways are dual-rated for both power and data applications, reducing inventory requirements.
- UL Listed and CSA Certified to 600 volts.
- Office white color.



## Non-Metallic PlugTrak®

- Available as hard wired multi-outlet assembly or relocatable power tap.
- Hubbell designed and manufactured 15 or 20 Amp receptacles.
- UL Listed and CSA Certified.
- Office white color.

### Hard Wired Multi-Outlet PlugTrak®:

- Available in 5 ft. or 6 ft. lengths.
- Available in single, two circuit and is inherently an isolated ground product.
- Multiple spacing configurations.
- Hard wired PlugTrak® mates with LANTrak® fittings and boxes.
- Tamper-Resistant versions available.

### Portable PlugTrak®:

- Available in 3 ft. (0.9m) or 5 ft. (1.5m) lengths.
- 6 ft. (1.8m) length 15 or 20 Amp molded cord set allows reliable access.
- Pre-punched holes make mounting easy.



## One Box, Three Systems

- Boxes have three cut-aways that can be utilized with WallTrak®, LANTrak and PremiseTrak (Latching) systems.
- Reduces inventory requirements.
- Eliminates need to order three separate boxes.
- Boxes available in low, standard and deep profiles.
- Two-gang divided box available for power, data, voice, audio and video applications.
- Boxes utilize Hubbell KP plates or Hubbell iSTATION Modules and Bezels.



## Flush or Full Capacity Boxes

- Super BaseTrak® and BaseTrak® Raceway offer multiple solutions for box installation.
- Super BaseTrak® in-line three-gang box allows maximum capacity in a flush design.
- Super BaseTrak® and BaseTrak® available in single, two and three-gang full capacity boxes.
- Two and three channel BaseTrak® (PB2 and PB3) available with one and two-gang in-line boxes.
- Full capacity in-line boxes eliminate the need to de-rate the wire fill capacity due to the intrusion of devices into the raceway channel.

# Non-Metallic Raceway PT1 PremiseTrak® (Non-Latching)

Raceway, Boxes and Fittings



PT1 PremiseTrak®	<b>Description</b>	<b>Color</b>	<b>Length</b>	<b>Without Adhesive</b>	<b>With Adhesive</b>
	<b>Base and Cover</b> Single channel raceway. Available in 5 ft. (1.5m) and 7 ft. (2.1m) lengths.	Office White	5 ft. 7 ft.	<b>PT1BC5</b> <b>PT1BC7</b> A: .68" (17.27) B: .75" (19.05)	<b>PT1ABC5</b> <b>PT1ABC7</b> A: .68" (17.27) B: .75" (19.05)



	Description	Color	Catalog Number	Description	Color	Catalog Number
Device Boxes	<b>1-Gang Low Profile Box</b> For shallow switches and receptacles. See page R-63 for recommended plate options.	Office White	<b>PT12LPB</b> A: 4.90" (124.46) B: 3.25" (82.55) C: 1.12" (28.45)	<b>1-Gang Deep Box</b> For deep devices or applications where additional room is beneficial. See page R-63 for recommended plate options.	Office White	<b>PT12DBA</b> A: 4.90" (124.46) B: 3.25" (82.55) C: 1.91" (48.51)
	<b>1-Gang Standard Box</b> For standard switches and receptacles. See page R-63 for recommended plate options.	Office White	<b>PT12SBA</b> A: 4.90" (124.46) B: 3.25" (82.55) C: 1.63" (41.40)	<b>2-Gang Deep Box</b> For deep devices or applications where additional room is beneficial. Uses 2-gang "KP", "IMF", or "IFP" plates for power or data applications. See page R-63 for recommended plate options.	Office White	<b>PT12TGB</b> A: 4.90" (124.46) B: 5.06" (128.52) C: 1.91" (48.51)
	<b>Round Lighting Fixture Box</b> To hang fixtures.	Office White	<b>PT12LFB</b> A: 5.31" (134.87) B: 1.04" (26.52)			
Fittings	<b>Internal Elbow, Cover Only</b> For inside surfaces at right angles.	Office White	<b>PT1IE</b> A: 1.34" (34.04) B: 0.89" (22.61) C: 1.34" (34.04)	<b>External Elbow, Cover Only</b> For outside surfaces at right angles.	Office White	<b>PT1EE</b> A: 1.24" (31.50) B: 0.88" (22.35) C: 1.24" (31.50)
	<b>Flat Elbow, Cover Only</b> For right angle turns on same surface.	Office White	<b>PT1FE</b> A: 1.33" (33.78) B: 1.33" (33.78) C: 0.74" (18.80)	<b>Tee, Cover Only</b> For T-connection off PremiseTrak® Raceway.	Office White	<b>PT1TC</b> A: 1.77" (44.90) B: 1.33" (33.78) C: 0.74" (18.80)
	<b>Splice Cover</b> For covering potential openings where two lengths of raceway come together.	Office White	<b>PT1SC</b> A: 1.00" (25.40) B: 0.89" (22.61) C: 0.74" (18.80)	<b>End Cap</b> For closing end of raceway.	Office White	<b>PT1EC</b> A: 0.88" (22.35) B: 0.74" (18.80) C: 0.89" (22.61)
	<b>Conduit Adapter/Ceiling Fitting</b> For connecting conduit to raceway. Also use for ceiling feeds. Has combination 1/2 in., 3/4 in. and 1 in. trade size KOs.	Office White	<b>PT12CA</b> A: 1.64" (41.66) B: 1.62" (41.15) C: 2.50" (63.50)			

Dimensions in Inches (mm)



PP1 PremiseTrak®	Description	Color	Length	Without Adhesive	With Adhesive
	<b>Base and Cover</b> Single channel raceway. Available in 5 ft. (1.5m) and 7 ft. (2.1m) lengths.	Office White	5 ft. 7 ft.	<b>PP1BC5</b> <b>PP1BC7</b> A: 0.77" (19.56) B: 0.84" (21.34)	<b>PP1ABC5</b> <b>PP1ABC7</b> A: 0.77" (19.56) B: 0.84" (21.34)



	Description	Color	Catalog Number	Description	Color	Catalog Number
Device Boxes	<b>1-Gang Low Profile Box</b> For shallow switches and receptacles. See page R-63 for recommended plate options.	Office White	<b>PDB12LP</b> A: 4.90" (124.46) B: 3.25" (82.55) C: 1.25" (31.75)	<b>1-Gang Deep Box</b> For deep devices or applications where additional room is beneficial. See page R-63 for recommended plate options.	Office White	<b>PDB12D</b> A: 4.90" (124.46) B: 3.25" (82.55) C: 2.44" (61.98)
	<b>1-Gang Standard Box</b> For standard switches and receptacles. See page R-63 for recommended plate options.	Office White	<b>PDB12S</b> A: 4.90" (124.46) B: 3.25" (82.55) C: 1.78" (45.21)	<b>Round Lighting Fixture Box</b> To hang fixtures.	Office White	<b>PDB12LF</b> A: 5.31" (134.87) B: 1.29" (32.77)
	<b>2-Gang Deep Divided Box</b> For deep switches, receptacles and communication devices. See page R-63 for single gang "KP" plate options. Comes with removable divider.	Office White	<b>PDB12TGD</b> A: 4.90" (124.46) B: 5.06" (128.52) C: 2.44" (61.98)	<b>2-Gang Deep Undivided Box</b> For low voltage applications only. Use with 2-gang "IFP" or "IMF" plates only. See page R-63 for details.	Office White	<b>PDB12TGLV</b> A: 4.90" (124.46) B: 5.06" (128.52) C: 2.44" (61.98)
Fittings	<b>Internal Elbow</b> Full capacity 1¼ in. bend radius internal elbow.	Office White	<b>PP1IE*</b> <b>PP1IEBC**</b> A: 2.40" (60.96) B: 1.03" (26.16) C: 2.40" (60.96)	<b>External Elbow</b> Full capacity 1¼ in. bend radius external elbow.	Office White	<b>PP1EE*</b> <b>PP1EEBC**</b> A: 4.47" (113.54) B: 1.03" (26.16) C: 4.47" (113.54)
	<b>Flat Elbow</b> Full capacity 1¼ in. bend radius flat elbow.	Office White	<b>PP1FE*</b> <b>PP1FEBC**</b> A: 2.62" (66.55) B: 2.62" (66.55) C: 0.85" (21.59)	<b>Tee</b> Full capacity 1¼ in. bend radius tee.	Office White	<b>PP1TC*</b> <b>PP1TCBC**</b> A: 4.22" (107.19) B: 2.62" (66.55) C: 0.85" (21.59)
	<b>Splice Cover</b> For covering potential openings where two lengths of raceway come together.	Office White	<b>PP1SC</b> A: 1.09" (27.69) B: 1.02" (25.91) C: 0.85" (21.59)	<b>End Cap</b> For closing end of raceway.	Office White	<b>PP1EC</b> A: 1.00" (25.40) B: 0.84" (21.34) C: 0.77" (19.56)
	<b>Conduit Adapter/Ceiling Fitting</b> For connecting conduit to raceway. Also use for ceiling feeds. Has combination ½ in., ¾ in. and 1 in. trade size KOs.	Office White	<b>PLP1CACF</b> A: 2.29" (58.17) B: 3.31" (84.07) C: 3.90" (99.06)	<b>Safety Strap</b> For preventing potential tampering with PP1 PremiseTrak cover. Can also be used as a splice cover.	Office White	<b>PP1SS</b> A: 0.62" (15.75) B: 1.94" (49.28) C: 0.86" (21.84)

Note: \*Cover only. \*\*Base and Cover.

Dimensions in Inches (mm)

# Non-Metallic Raceway PL1 LANTrak® (Latching)

Raceway, Boxes and Fittings



PL1 LANTrak®	Description	Color	Length	Without Adhesive	With Adhesive
	<b>Base and Cover</b> Single channel raceway. Available in 5 ft. (1.5m) and 7 ft. (2.1m) lengths.	Office White	5 ft. 7 ft.	<b>PL1BC5</b> <b>PL1BC7</b> A: 1.04" (26.42) B: 1.38" (35.05)	<b>PL1ABC5</b> <b>PL1ABC7</b> A: 1.04" (26.42) B: 1.38" (35.05)



Device Boxes	Description	Color	Catalog Number	Description	Color	Catalog Number
	<b>1-Gang Low Profile Box</b> For shallow switches and receptacles. See page R-63 for recommended plate options.	Office White	<b>PDB12LP</b> A: 4.90" (124.46) B: 3.25" (82.55) C: 1.25" (31.75)	<b>1-Gang Deep Box</b> For deep devices or applications where additional room is beneficial. See page R-63 for recommended plate options.	Office White	<b>PDB12D</b> A: 4.90" (124.46) B: 3.25" (82.55) C: 2.44" (61.98)
<b>1-Gang Standard Box</b> For standard switches and receptacles. See page R-63 for recommended plate options.	Office White	<b>PDB12S</b> A: 4.90" (124.46) B: 3.25" (82.55) C: 1.78" (45.21)	<b>Round Lighting Fixture Box</b> To hang fixtures.	Office White	<b>PDB12LF</b> A: 5.31" (134.87) B: 1.29" (32.77)	
<b>2-Gang Deep Divided Box</b> For deep switches, receptacles and communication devices. See page R-63 for single gang "KP" plate options. Comes with removable divider.	Office White	<b>PDB12TGD</b> A: 4.90" (124.46) B: 5.06" (128.52) C: 2.44" (61.98)	<b>2-Gang Deep Undivided Box</b> For low voltage applications only. Use with 2-gang "IFP" or "IMF" plates only. See page R-63 for details.	Office White	<b>PDB12TGLV</b> A: 4.90" (124.46) B: 5.06" (128.52) C: 2.44" (61.98)	
Fittings	<b>Internal Elbow</b> Full capacity 1¼ in. bend radius internal elbow.	Office White	<b>PL1IE*</b> <b>PL1IEBC**</b> A: 2.51" (63.75) B: 1.57" (39.88) C: 2.51" (63.75)	<b>External Elbow</b> Full capacity 1¼ in. bend radius external elbow.	Office White	<b>PL1EE*</b> <b>PL1EEBC**</b> A: 5.06" (128.52) B: 1.57" (39.88) C: 5.06" (128.52)
	<b>Flat Elbow</b> Full capacity 1¼ in. bend radius flat elbow.	Office White	<b>PL1FE*</b> <b>PL1FEBC**</b> A: 3.19" (81.03) B: 3.19" (81.03) C: 1.11" (28.19)	<b>Tee</b> Full capacity 1¼ in. bend radius tee.	Office White	<b>PL1TC*</b> <b>PL1TCBC**</b> A: 4.75" (120.65) B: 3.15" (80.01) C: 1.11" (28.19)
	<b>Splice Cover</b> For covering potential openings where two lengths of raceway come together.	Office White	<b>PL1SC</b> A: 1.12" (28.45) B: 1.55" (39.37) C: 1.11" (28.19)	<b>End Cap</b> For closing end of raceway.	Office White	<b>PL1EC</b> A: 1.00" (25.40) B: 1.39" (35.31) C: 1.04" (26.42)
	<b>Conduit Adapter/Ceiling Fitting</b> For connecting conduit to raceway. Also use for ceiling feeds. Has combination ½ in., ¾ in. and 1 in. trade size KOs.	Office White	<b>PLP1CACF</b> A: 2.29" (58.17) B: 3.31" (84.07) C: 3.90" (99.06)	<b>Safety Strap</b> For preventing potential tampering with PL1 LANTrak cover. Can also be used as a splice cover.	Office White	<b>PL1SS</b> A: 0.62" (15.75) B: 2.68" (68.07) C: 1.12" (28.45)

Note: \*Cover only. \*\*Base and Cover.

Dimensions in Inches (mm)

Non-Metallic Raceway  
**PW1 WallTrak® Low Profile (Latching)**  
*Raceway, Device Boxes and Fittings*



	Description	Color	Length	Without Adhesive	With Adhesive
PW1 WallTrak®	<b>Base and Cover</b> Single channel raceway. Available in 5 ft. (1.5m) and 7 ft. (2.1m) lengths.	Office White	5 ft. 7 ft.	<b>PW1BC5</b> <b>PW1BC7</b> A: .50" (12.70) B: 1.19" (30.23)	<b>PW1ABC5</b> <b>PW1ABC7</b> A: .50" (12.70) B: 1.19" (30.23)

	Description	Color	Catalog Number	Description	Color	Catalog Number
Device Boxes	<b>1-Gang Low Profile Box</b> For shallow switches and receptacles. See page R-63 for recommended plate options.	Office White	<b>PW1LPB</b> A: 4.90" (124.46) B: 3.25" (82.55) C: 1.13" (28.70)	<b>1-Gang Deep Box</b> For deep devices or applications where additional room is beneficial. See page R-63 for recommended plate options.	Office White	<b>PW1DBA</b> A: 4.90" (124.46) B: 3.25" (82.55) C: 1.91" (48.51)
	<b>1-Gang Standard Box</b> For standard switches and receptacles. See page R-63 for recommended plate options.	Office White	<b>PW1SBA</b> A: 4.90" (124.46) B: 3.25" (82.55) C: 1.63" (41.40)	<b>2-Gang Deep Box</b> For deep devices or applications where additional room is beneficial. Uses 2-gang "KP" or "IFP" plates for power or data applications. See page R-63 for recommended plate options.	Office White	<b>PW1TGB</b> A: 4.90" (124.46) B: 5.06" (128.52) C: 1.91" (48.51)
	<b>Round Lighting Fixture Box</b> To hang fixtures.	Office White	<b>PW1LFB</b> A: 5.31" (134.87) B: 1.04" (26.52)			
Fittings	<b>Internal Elbow, Cover Only</b> For inside surfaces at right angles.	Office White	<b>PW1IE</b> A: 1.75" (44.45) B: 1.43" (36.32) C: 1.75" (44.45)	<b>External Elbow, Cover Only</b> For outside surfaces at right angles.	Office White	<b>PW1EE</b> A: 1.50" (38.10) B: 1.43" (36.32) C: 1.50" (38.10)
	<b>Flat Elbow, Cover Only</b> For right angle turns on same surface.	Office White	<b>PW1FE</b> A: 2.18" (55.37) B: 2.18" (55.37) C: .60" (15.24)	<b>Tee, Cover Only</b> For T-connection off PremiseTrak® Raceway.	Office White	<b>PW1TC</b> A: 2.93" (74.42) B: 2.18" (55.37) C: .60" (15.24)
	<b>Splice Cover</b> For covering potential openings where two lengths of raceway come together.	Office White	<b>PW1SC</b> A: 1.00" (25.40) B: 1.43" (36.32) C: .60" (15.24)	<b>End Cap</b> For closing end of raceway.	Office White	<b>PW1EC</b> A: 1.00" (25.40) B: 1.24" (31.50) C: .50" (12.70)
	<b>Conduit Adapter/Ceiling Fitting</b> For connecting conduit to raceway. Also use for ceiling feeds. Has combination 1/2 in., 3/4 in. and 1 in. trade size KOs.	Office White	<b>PW1CA</b> A: 1.40" (35.56) B: 2.34" (59.44) C: 3.22" (81.79)			

Dimensions in Inches (mm)



# Non-Metallic Raceway PW2 WallTrak® (Latching) Raceway, Device Boxes and Fittings













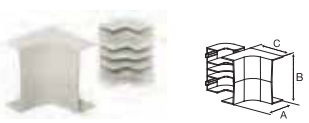

PW2 WallTrak®	Description	Color	Length	Without Adhesive	With Adhesive
	<b>Base and Cover</b> Two channel raceway. Available in 5 ft. (1.5m) and 7 ft. (2.1m) lengths.	Office White	5 ft. 7 ft.	<b>PW2BC5</b> <b>PW2BC7</b> A: 1.04" (26.42) B: 2.12" (53.85)	<b>PW2ABC5</b> <b>PW2ABC7</b> A: 1.04" (26.42) B: 2.12" (53.85)

Device Boxes	Description	Color	Catalog Number	Description	Color	Catalog Number
		<b>1-Gang Low Profile Box</b> For shallow switches and receptacles. See page R-63 for recommended plate options.	Office White	<b>PDB12LP</b> A: 4.90" (124.46) B: 3.25" (82.55) C: 1.25" (31.75)	<b>Round Lighting Fixture Box</b> To hang fixtures.	Office White
	<b>1-Gang Standard Box</b> For standard switches and receptacles. See page R-63 for recommended plate options. If using dual services, the PDB1DIV must be ordered.	Office White	<b>PDB12S</b> A: 4.90" (124.46) B: 3.25" (82.55) C: 1.78" (45.21)	<b>2-Gang Deep Undivided Box</b> For low voltage applications only. Use with 2-gang "IFP" or "IMF" plates only. See page R-63 for details.	Office White	<b>PDB12TGLV</b> A: 4.90" (124.46) B: 5.06" (128.52) C: 2.44" (61.98)
	<b>1-Gang Deep Box</b> For deep devices or applications where additional room is beneficial. See page R-63 for recommended plate options. If using dual services, the PDB1DIV must be ordered.	Office White	<b>PDB12D</b> A: 4.90" (124.46) B: 3.25" (82.55) C: 2.44" (61.98)	<b>2-Gang Deep Divided Box</b> For deep devices or applications where additional room is beneficial. See page R-63 for single gang "KP" plate options. Comes with removable divider. If using dual services, in a perpendicular run the PDB2DIV must be ordered.	Office White	<b>PDB12TGD</b> A: 4.90" (124.46) B: 5.06" (128.52) C: 2.44" (61.98)
	<b>1-Gang Divider</b> For use with PDB12S and PDB12D 1-gang boxes. Required when two services are passing through box.	Office White	<b>PDB1DIV</b> A: 2.79" (70.86) B: 1.40" (35.56) C: 0.94" (23.88)	<b>2-Gang Divider</b> For use with PDB12TGD 2-gang box only. Required when two services are passing through box and mounting devices perpendicular to raceway.	Office White	<b>PDB2DIV</b> A: 4.62" (117.35) B: 2.76" (70.10) C: 0.94" (23.88)
Fittings	<b>Internal Elbow</b> Full capacity 1¼ in. bend radius internal elbow.	Office White	<b>PW2IE*</b> <b>PW2IEBC**</b> A: 2.83" (71.88) B: 2.32" (58.93) C: 2.83" (71.88)	<b>External Elbow</b> Full capacity 1¼ in. bend radius external elbow.	Office White	<b>PW2EE*</b> <b>PW2EEBC**</b> A: 5.00" (127.00) B: 2.32" (58.93) C: 5.00" (127.00)
	<b>Flat Elbow</b> Full capacity 1¼ in. bend radius flat elbow.	Office White	<b>PW2FE*</b> <b>PW2FEBC**</b> A: 3.94" (100.08) B: 3.94" (100.08) C: 1.11" (28.19)	<b>Tee</b> Full capacity 1¼ in. bend radius tee.	Office White	<b>PW2TC*</b> <b>PW2TCBC**</b> A: 5.42" (137.67) B: 3.91" (99.31) C: 1.90" (48.26)
	<b>Splice Cover</b> For covering potential openings where two lengths of raceway come together.	Office White	<b>PW2SC</b> A: 1.11" (28.19) B: 2.30" (58.42) C: 1.11" (28.19)	<b>Safety Strap</b> For preventing potential tampering with PW2 WallTrak Cover. Can also be used as a splice cover.	Office White	<b>PW2SS</b> A: 0.62" (15.75) B: 3.43" (87.12) C: 1.12" (28.45)
	<b>Conduit Adapter/Ceiling Fitting</b> For connecting conduit to raceway. Also use for ceiling feeds. Has combination ½ in., ¾ in. and 1 in. trade size KOs.	Office White	<b>PW2CACF</b> A: 4.18" (106.17) B: 3.32" (84.33) C: 4.20" (106.68)	<b>Reducer</b> Reduces from PW2 WallTrak Raceway to one or two PP1 PremiseTrak Raceway(s).	Office White	<b>PW2RED</b> A: 1.62" (41.15) B: 2.40" (60.96) C: 1.15" (29.21)
	<b>End Cap</b> For closing end of PW2 WallTrak Raceway.	Office White	<b>PW2EC</b> A: 1.00" (25.40) B: 2.14" (54.36) C: 1.04" (26.42)			





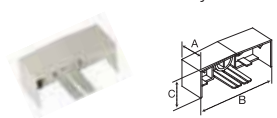





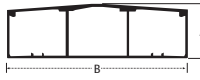



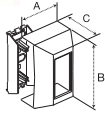
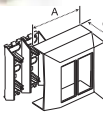
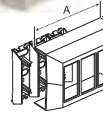

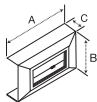

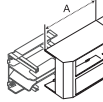

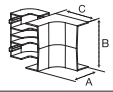

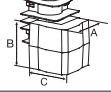

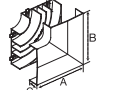

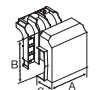

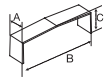

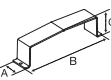

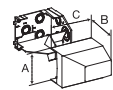

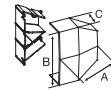
Note: \*Cover only. \*\*Base and Cover.  
Dimensions in Inches (mm)

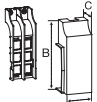
PB2 BaseTrak®	Description	Color	Length	Catalog Number	Description	Color	Length	Catalog Number
	<p><b>Base</b>                      Two channel raceway. Available in 5 ft. (1.5m) and 10 ft. (3m) lengths.</p> <p>Assembled cover and base dimensions.                      W: 4.50" (114.30)                      H: 1.63" (41.40)</p> 	Office White	5 ft. 10 ft.	<b>PB2B5</b> <b>PB2B10</b> A: 1.42" (36.07) B: 4.50" (114.30)	<p><b>Cover</b>                      Cover allows access to multiple channels. Available in 5 ft. (1.5m) and 10 ft. (3m) lengths.</p> 	Office White	5 ft. 10 ft.	<b>PB2C5</b> <b>PB2C10</b> B: 4.50" (114.30)
				<p><b>Split Cover</b>                      Cover allows separation of channels and access to a single channel. Available in 5 ft. (1.5m) and 10 ft. (3m) lengths. Two split covers are required for each raceway section.</p> 	Office White	5 ft. 10 ft.	<b>PB2SPL5</b> <b>PB2SPL10</b> B: 2.22" (56.39)	

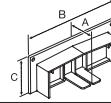

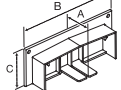

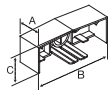









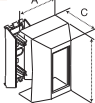
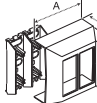
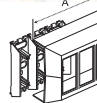

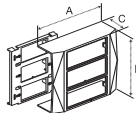

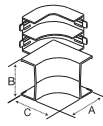

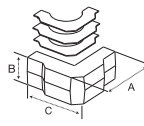

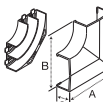



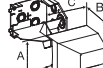

Device Boxes	Description	Color	Catalog Number
	<p><b>2-Gang In-Line Box</b>                      For switches, receptacles and communication devices. Provides flush look. See page R-63 for recommended single gang "KP" plate options.</p> 	Office White	<b>PB2IND2G</b> A: 7.66" (194.56) B: 4.74" (120.40) C: 1.84" (46.74)

Fittings	Description	Color	Catalog Number	Description	Color	Catalog Number
	<p><b>Internal Elbow, Base and Cover</b>                      Full capacity 1¼ in. bend radius internal elbow.</p> 	Office White	<b>PB3IEBCA</b> A: 4.36" (110.74) B: 4.72" (119.89) C: 4.36" (110.74)	<p><b>External Elbow, Base and Cover</b>                      Full capacity 1¼ in. bend radius external elbow.</p> 	Office White	<b>PB3EEBCA</b> A: 6.48" (164.59) B: 4.72" (119.89) C: 6.48" (164.59)
<p><b>Flat Elbow, Base and Cover</b>                      Full capacity 1¼ in. bend radius flat elbow.</p> 	Office White	<b>PB3FEBCA</b> A: 7.64" (194.66) B: 7.64" (194.66) C: 1.71" (43.43)	<p><b>Tee, Base and Cover</b>                      Full capacity 1¼ in. bend radius tee.</p> 	Office White	<b>PB3TCBCA</b> A: 7.37" (187.20) B: 7.08" (179.83) C: 2.72" (69.09)	
<p><b>Splice Cover</b>                      For covering potential openings where two lengths of raceway come together.</p> 	Office White	<b>PB3SC</b> A: 1.56" (39.62) B: 4.74" (120.40) C: 1.69" (42.93)	<p><b>Safety Strap</b>                      For preventing potential tampering with PB2 BaseTrak cover. Can also be used as a splice cover.</p> 	Office White	<b>PB3SS</b> A: 1.50" (38.10) B: 6.01" (152.65) C: 1.74" (44.20)	
<p><b>Conduit Adapter/Ceiling Fitting</b>                      For connecting conduit to raceway. Also use for ceiling feeds. Has combination ½ in., ¾ in., 1 in., 1¼ in. and 1½ in. trade size KOs.</p> 	Office White	<b>PB2CACF</b> A: 4.72" (119.89) B: 5.22" (132.70) C: 6.30" (160.02)	<p><b>Reducer</b>                      Reduces from PB2 BaseTrak Raceway to PW2 WallTrak Raceway.</p> 	Office White	<b>PB3REDA</b> A: 3.50" (88.90) B: 4.72" (119.89) C: 1.73" (43.94)	
<p><b>Transition Fitting</b>                      Transitions horizontal PB2 BaseTrak to vertical PW2 WallTrak. PL1 LANTrak or PP1 PremiseTrak.</p> 	Office White	<b>PB3TRBC</b> A: 3.22" (81.79) B: 7.28" (184.91) C: 2.42" (61.47)	<p><b>Surface Panel Connector</b>                      For connecting PB2 Raceway with surface type panel boxes.</p> 	Office White	<b>PB3SPCA</b> A: 2.22" (56.39) B: 5.66" (143.76) C: 1.60" (40.64)	
<p><b>End Cap</b>                      For closing end of PB2 BaseTrak Raceway.</p> 	Office White	<b>PB3ECA</b> A: 2.02" (51.31) B: 4.68" (118.97) C: 1.72" (43.69)	<p><b>Wire Clip</b>                      For holding conductors in place.</p> 	Office White	<b>PB2WC</b>	

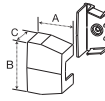
Dimensions in Inches (mm)

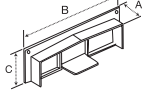
PB3 BaseTrak®	Description	Color	Length	Catalog Number		
	<b>Base and Cover</b> Three channel raceway. Available in 5 ft. (1.5m) and 10 ft. (3m) lengths.	Office White	5 ft. 10 ft.	<b>PB3BC5</b> <b>PB3BC10</b> A: 1.63" (41.40) B: 4.50" (114.30)		
						
Device Boxes	Description	Color	Catalog Number	Catalog Number	Catalog Number	
	<b>Full Capacity Boxes</b> 1-, 2- and 3-Gang boxes that allows full capacity from PB3 Raceway to box for either power or datacom applications. See page R-63 for recommended single gang "KP" plate options.	Office White	<b>PB3FCIB (1-Gang)</b> A: 4.38" (111.25) B: 4.80" (121.92) C: 3.17" (80.52)	<b>PB3FCIB2G (2-Gang)</b> A: 7.20" (182.88) B: 4.80" (121.92) C: 3.17" (80.52)	<b>PB3FCIB3G (3-Gang)</b> A: 9.96" (252.98) B: 4.80" (121.92) C: 3.17" (80.52)	
						
						
<b>1-Gang In-Line Box</b> For switches, receptacles and communication devices. Provides flush look. See page R-63 for recommended plate options.	Office White	<b>PB3IND</b> A: 4.90" (124.46) B: 3.25" (82.55) C: 1.25" (31.75)	<b>2-Gang In-Line Box</b> For switches, receptacles and communication devices. Barriers allow separation of power and datacom. Removal of barriers allows for expanded capacity. See page R-63 for recommended single gang "KP" plate options.	Office White	<b>PB3IND2G</b> A: 4.90" (124.46) B: 3.25" (82.55) C: 2.44" (61.98)	
						
Fittings	<b>Internal Elbow</b> Full capacity 1¼ in. bend radius internal elbow.	Office White	<b>PB3IE*</b> <b>PB3IEBCA**</b> A: 4.36" (110.74) B: 4.72" (119.89) C: 4.36" (110.74)	<b>External Elbow</b> Full capacity 1¼ in. bend radius external elbow.	Office White	<b>PB3EE*</b> <b>PB3EEBCA**</b> A: 6.48" (164.59) B: 4.72" (119.89) C: 6.48" (164.59)
						
	<b>Flat Elbow</b> Full capacity 1¼ in. bend radius flat elbow.	Office White	<b>PB3FE*</b> <b>PB3FEBCA**</b> A: 7.64" (194.66) B: 7.64" (194.66) C: 1.71" (43.43)	<b>Tee</b> Full capacity 1¼ in. bend radius tee.	Office White	<b>PB3TCBCA**</b> A: 7.37" (187.20) B: 7.08" (179.83) C: 2.72" (69.09)
						
	<b>Splice Cover</b> For covering potential openings where two lengths of raceway come together.	Office White	<b>PB3SC*</b> A: 1.56" (39.62) B: 4.74" (120.40) C: 1.69" (42.93)	<b>Safety Strap</b> Prevents potential tampering with PB3 BaseTrak cover. Can also be used as a splice cover.	Office White	<b>PB3SS*</b> A: 1.50" (38.10) B: 6.01" (152.65) C: 1.74" (44.20)
						
	<b>Conduit Adapter/Ceiling Fitting</b> For connecting conduit to raceway. Also use for ceiling feeds. Has combination ½ in., ¾ in., 1 in., 1¼ in. and 1½ in. trade size KOs.	Office White	<b>PB3CACF**</b> A: 4.72" (119.89) B: 5.22" (132.70) C: 6.30" (160.02)	<b>Reducer</b> Reduces from PB3 BaseTrak Raceway to PW2 WallTrak Raceway.	Office White	<b>PB3REDA**</b> A: 3.50" (88.90) B: 4.72" (119.89) C: 1.73" (43.94)
						
<b>Transition Fitting</b> Transitions horizontal PB3 BaseTrak to vertical PW2 WallTrak, PL1 LANTrak or PP1 PremiseTrak.	Office White	<b>PB3TRBC**</b> A: 3.22" (81.79) B: 7.28" (184.91) C: 2.42" (61.47)	<b>Transition Fitting</b> Transitions from BT3 (old style) BaseTrak Raceway to PB3 (new style) BaseTrak Raceway.	Office White	<b>BTPB3TF*</b> A: 2.22" (56.39) B: 5.66" (143.76) C: 1.35" (34.29)	
						
<b>Surface Panel Connector</b> For connecting PB3 Raceway with surface type panel boxes.	Office White	<b>PB3SPCA*</b> A: 2.22" (56.39) B: 5.66" (143.76) C: 1.60" (40.64)	<b>End Cap</b> For closing end of PB3 BaseTrak Raceway.	Office White	<b>PB3ECA*</b> A: 2.02" (51.31) B: 4.68" (118.97) C: 1.72" (43.69)	
						
<b>Wire Clip</b> For holding conductors in place.	Office White	<b>PB3WC</b>				
						

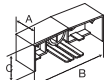
Note: \*Cover only. \*\*Base and Cover.  
 Dimensions in Inches (mm)



PS3 BaseTrak®	Description	Color	Length	Catalog Number		
	<b>Base and Cover</b> Three channel raceway. Available in 5 ft. (1.5m) and 10 ft. (3m) lengths.	Office White	5 ft. 10 ft.	<b>PS3BC5</b> <b>PS3BC10</b> A: 1.97" (50.04) B: 6.70" (170.18)		
						
Device Boxes	Description	Color	Catalog Number	Catalog Number	Catalog Number	
	<b>Full Capacity Boxes</b> 1-, 2- and 3-Gang boxes that allows full capacity from PS3 Raceway to box for either power or datacom applications. See page R-63 for recommended single gang "KP" plate options.	Office White	<b>PS3FCIB (1-Gang)</b> A: 4.38" (111.25) B: 6.95" (176.53) C: 3.46" (87.88)	<b>PS3FCIB2G (2-Gang)</b> A: 7.20" (182.88) B: 6.95" (176.53) C: 3.46" (87.88)	<b>PS3FCIB3G (3-Gang)</b> A: 9.96" (252.98) B: 6.95" (176.53) C: 3.46" (87.88)	
						
						
	<b>3-Gang In-Line Box</b> For any combination of power and datacom applications. Provides flush look. See page R-63 for recommended single gang "KP" plate options.	Office White		<b>PS3IND</b> A: 7.00" (177.80) B: 6.95" (176.53) C: 2.28" (57.91)		
						
Fittings	<b>Internal Elbow</b> Full capacity 1¼ in. bend radius internal elbow.	Office White	<b>PS3IE*</b> <b>PS3IEBC**</b> A: 4.36" (110.74) B: 6.93" (176.02) C: 4.36" (110.74)	<b>External Elbow</b> Full capacity 1¼ in. bend radius external elbow.	Office White	<b>PS3EE*</b> <b>PS3EEBC**</b> A: 6.81" (172.97) B: 6.93" (176.02) C: 6.81" (172.97)
						
	<b>Flat Elbow</b> Full capacity 1¼ in. bend radius flat elbow.	Office White	<b>PS3FE*</b> <b>PS3FEBC**</b> A: 9.85" (250.19) B: 9.85" (250.19) C: 2.08" (52.83)	<b>Tee</b> Full capacity 1¼ in. bend radius tee.	Office White	<b>PS3TCBC**</b> A: 10.00" (254.00) B: 9.68" (245.87) C: 3.30" (83.82)
						
	<b>Splice Cover</b> For covering potential openings where two lengths of raceway come together.	Office White	<b>PS3SC*</b> A: 1.56" (39.62) B: 6.95" (176.53) C: 2.03" (51.62)	<b>Safety Strap</b> Prevents potential tampering with PS3 Super BaseTrak cover. Can also be used as a splice cover.	Office White	<b>PS3SS*</b> A: 1.50" (38.10) B: 8.24" (209.30) C: 2.08" (52.85)
						
	<b>Conduit Adapter/Ceiling Fitting</b> For connecting conduit to raceway. Also use for ceiling feeds. Has combination ½ in., ¾ in., 1 in., 1¼ in. and 1½ in. trade size KOs.	Office White	<b>PS3CACF**</b> A: 6.93" (176.02) B: 4.32" (109.73) C: 6.29" (159.77)	<b>Reducer</b> Reduces from PS3 Super BaseTrak Raceway to PB3 BaseTrak Raceway.	Office White	<b>PS3RED**</b> A: 4.81" (122.17) B: 6.93" (176.02) C: 2.05" (52.07)
						
<b>Surface Panel Connector</b> To connect PS3 Raceway with surface type panel boxes.	Office White	<b>PS3SPC*</b> A: 1.00" (25.40) B: 7.87" (199.90) C: 2.54" (64.52)	<b>End Cap</b> For closing end of PS3 Super BaseTrak Raceway.	Office White	<b>PS3EC*</b> A: 1.50" (38.10) B: 6.88" (174.75) C: 2.06" (52.32)	
						
<b>Wire Clip</b> For holding conductors in place.	Office White	<b>PS3WC</b>				
						

Note: \*Cover only. \*\*Base and Cover.

Dimensions in Inches (mm)

 Tamper-Resistant



	5 Foot Base and Cover		# Duplex Receptacles	Receptacle Spacing (in.)	Catalog Number
	Amp	Circuits			
	15	Single	5	12	PT155112
	15	Two	5	12	PT155212
	15	Single	4	15	PT155115
	15	Single	2	30	PT155130
	15	TR/Single	5	12	PT155112TR 
	20	Single	5	12	PT205112
	20	Two	5	12	PT205212
	20	Single	4	15	PT205115
	20	Two	4	15	PT205215
	20	Single	2	30	PT205130
	20	Single	5	12	PT205112TR 
	<b>6 Foot Base and Cover</b>				
	15	Single	6	12	PT156112
	15	Two	6	12	PT156212
	15	Single	4	18	PT156118
	15	Single	3	24	PT156124
	20	Single	12	6	PT206106
	20	Two	12	6	PT206206
	20	Single	6	12	PT206112
	20	Two	6	12	PT206212
	20	Single	4	18	PT206118
	20	Two	4	18	PT206218
	20	Single	3	24	PT206124
	20	Two	3	24	PT206224
	20	Single	2	36	PT206136

Note: Each Non-Metallic PlugTrak is supplied with one PL1EC end cap and "IG" stickers for isolated ground applications.



	Portable		# Duplex Receptacles	Catalog Number
	Amp	Length (ft.)		
	15	3	3	PT153112P
	15	5	5	PT155112P
	20	3	2	PT203112P
	20	5	5	PT205112P
	Supporting Mounting Clip for Portable PlugTrak. <b>PL1MC</b>			

Note: Includes on/off switch and circuit breaker.



	Device Boxes		Description	Catalog Number
	Description	Catalog Number		
	1-Gang Low Profile	<b>PDB12LP</b>	1-Gang Deep	<b>PDB12D</b>
	1-Gang Standard	<b>PDB12S</b>	2-Gang Deep Divided	<b>PDB12TGD</b>
	Round Lighting Fixture	<b>PDB12LF</b>		
	<b>Fittings</b>			
	Internal Elbow Base and Cover	<b>PL1IEBC</b>	Internal Elbow Cover Only	<b>PL1IE</b>
	External Elbow Base and Cover	<b>PL1EEBC</b>	External Elbow Cover Only	<b>PL1EE</b>
	Flat Elbow Base and Cover	<b>PL1FEBC</b>	Flat Elbow Cover Only	<b>PL1FE</b>
	Tee Base and Cover	<b>PL1TCBC</b>	Tee Cover Only	<b>PL1TC</b>
	Splice Cover	<b>PL1SC</b>	Safety Strap	<b>PL1SS</b>
	Conduit Adapter/Ceiling Fitting	<b>PLP1CACF</b>	End Cap	<b>PL1EC</b>

Note: See page R-56 for additional information.



**PL1MC**  
Supporting Mounting Clip



# Non-Metallic Raceway Plates, Frames and Modular Connector Fittings

Communication Outlet Plates and Frames



1-Gang "KP" Plates	Color	Catalog Number	Catalog Number	Catalog Number	Catalog Number	Catalog Number
	Office White	<b>KP8</b> Duplex	<b>KP26</b> Style Line®	<b>KP1</b> Toggle	<b>KP7</b> Receptacle (1.41 ID)	<b>KP720</b> Receptacle (1.60 ID)
	Office White	<b>KP14</b> Blank	<b>KP212</b> Coax (2)	<b>KP2140</b> Jack/Coax	<b>KP2162</b> Modular Jacks (2)	<b>KP2163</b> Modular Jacks (3)
Office White	<b>KPORTOW</b> Ortronics Series II® Data Module	<b>KPPANOW</b> Panduit Mini-Com® Data Module	<b>KPIMBZOW</b> 3-Unit iSTATION (Accepts all Hubbell iSTATION Modules located in Network Wiring section).			

2-Gang "KP" Plates	Color	Catalog Number	Catalog Number	Catalog Number	Catalog Number
	Office White	<b>KP82</b> 2-Gang Duplex	<b>KP262</b> 2-Gang Style Line®	<b>KP2</b> 2-Gang Toggle	<b>KP24</b> 2-Gang Blank

Note: 2-Gang "KP" plates, for use with PT12TGB and PW1TGB only.

Comm. "IFP" Plates & Frames	Color	Catalog Number	Catalog Number	Catalog Number	Catalog Number	Catalog Number
	Office White	<b>IFP126OW</b> Style Line®	<b>ISF2OW</b> Style Line® 2-Port	<b>ISF3OW</b> Style Line® 3-Port	<b>ISF4OW</b> Style Line® 4-Port	<b>ISF6OW</b> Style Line® 6-Port
	Office White	<b>IFP18OW</b> Duplex	<b>BR106C</b> Duplex 2-Port	<b>Q106O</b> Duplex 4-Port	<b>IFP12OW</b> Flush 2-Port	<b>IFP13OW</b> Flush 3-Port
Office White	<b>IFP14OW</b> Flush 4-Port	<b>IFP16OW</b> Flush 6-Port	<b>IFP26OW</b> 2-Gang 6-Port	<b>IFP29OW</b> 2-Gang 9-Port	<b>IFP212OW</b> 2-Gang 12-Port	

Note: Ivory metal raceway matches almond devices and plates. For HBL3000 series raceway applications, catalog number HBL3051LEIV/GY must be used with plates and devices.

Frames & Modules	Description	Color	1-Gang	2-Gang
	Front loading plate will accept any modules in three unit combinations. Angled fixtures to be used in bottom opening only. See section W for additional information on Hubbell iSTATION modules. Each gang accepts 3 module units.	Office White	<b>IMF1OW</b>	<b>IMF2OW</b>

Modular connectors to be used with any plate with a standard modular opening. Not recommended for use with KP plates. For KP applications use KPIMBZOW bezel and appropriate Hubbell iSTATION modules located in section W. Use appropriate Hubbell iSTATION modules for SC fiber adapters. See section W for additional information on modular connectors.

Modular Connector Fittings	Color	Catalog Number	Catalog Number	Catalog Number	Catalog Number
	Office White	<b>SFFX</b> F-Connector	<b>SFST</b> ST Fiber Connector	<b>SFBOW</b> BNC Connector	<b>SFB10</b> Blank (10 Pack)
Office White	<b>SFRC110R</b> (Black housing only) RCA 110 Punchdown	<b>SFSV110BK</b> (Black housing only) Super S-Video	<b>FASCMPB6</b> SC Duplex Adapter	<b>FASTSCMPB6</b> SC to ST Duplex Adapter	

Xcelerator Modular Jacks	Color	Catalog Number	Catalog Number	Catalog Number
	Office White	<b>HXJ5EOW</b> Cat. 5e, T568A, T568B, RJ45	<b>HXJ6OW</b> Cat. 6, T568A, T568B, RJ45	<b>HXJUOW</b> 6 Position USOC, RJ25

Jack Color Options (Replaces AL Suffix)

OW=Office White	GY=Gray	BK=Black	W=White	OR=Orange	R=Red	Y=Yellow	B=Blue	GN=Green	EI=Elec Ivory
-----------------	---------	----------	---------	-----------	-------	----------	--------	----------	---------------

Panduit® and Mini-Com® are registered trademarks of Panduit Corp.  
Ortronics® and Series II® are registered trademarks of Ortronics/Legrand.

# Non-Metallic Raceway Technical Information and Wire Fill Capacity Chart

Technical Information



Non-Metallic Raceway Wire Fill Capacities															
		Power (THHN/T90 Nylon)			Voice		Data (Copper Cables)					Data (Multimode Fiber Optic Cables)			
		14 AWG	12 AWG	10 AWG	4-Pair	25-Pair	Type RG59U	Cat. 5e	Cat. 6	Cat. 6A	Cat. 6 STP	(2) or (4) Fiber Round Cable	Fiber Optic Jumpers	Fiber Optic Zip Cord	
		Wire O.D. (in.):	0.111	0.13	0.164	0.19	0.41	0.242	0.21	0.25	0.35	0.29	0.19	0.118	.12 X .24
		Wire Area (sq. in.):	0.0097	0.0133	0.0211	0.0283	0.1320	0.0460	0.0346	0.0491	0.0962	0.0660	0.0283	0.0109	0.0288
Series	Channel	Channel Area (sq. in.)	Wire Fill Capacity			40%	40%	40%	40%	40%	40%	40%	40%	40%	40%
PT1	A	0.29	5	8	5	4	1	3	3	2	1	2	4	11	4
PP1	A	0.38	12	11	8	5	1	3	4	3	2	2	5	14	5
PL1	A	1.03	42	34	22	15	3	9	12	8	4	6	15	38	14
PW1	A	0.30	6	10	4	4	0	2	3	2	1	2	4	11	4
PW2	A+B	1.60	41	36	22	23	5	14	18	13	7	10	23	59	22
A   B	A	0.81	12	22	12	11	2	7	9	7	3	5	11	30	11
	B	0.79	12	22	10	11	2	7	9	6	3	5	11	29	11
PB2	A+B	5.72	60	36	45	81	17	50	66	47	24	35	81	210	79
A   B	A or B	2.86	42	30	28	40	9	25	33	23	12	17	40	105	40
PB3	A+B+C	5.57	60	36	45	79	17	48	64	45	23	34	79	204	77
A   B   C	A or C	1.80	42	30	28	25	5	16	21	15	7	11	25	66	25
	B	1.97	42	30	28	28	6	17	23	16	8	12	28	72	27
PS3	A+B+C	10.58	72	66	78	150	32	92	122	86	44	64	150	388	147
A   B   C	A or C	3.41	42	36	42	48	10	30	39	28	14	21	48	125	47
	B	3.76	42	36	42	53	11	33	43	31	16	23	53	138	52

Note: Pathway (Raceway) fill shall be 40% maximum. Raceway fittings and outlets/receptacles reduce the cross section of the raceway system, thus reducing overall cable fill capacity.

Recommended Plate to Box Compatibility Selection Chart																
Non-Metallic Raceway Box Series		PS3 Series				PB3 Series					PB2 Series	PDB12 Series			PT12 & PW1 Series	
Plate Style	Sample Catalog Number	IND	FCIB	FCIB2G	FCIB3G	IND	IND2G	FCIB	FCIB2G	FCIB3G	IND2G	LP, S, D	TGD	TGLV	LP(B), S(BA), D(BA)	TGB
1-Gang KP Series Plate	KP8	X	X	X	X	X	X	X	X	X	X	X	X		X	
1-Gang KP Series Bezel	KPIMBZ	X	X	X	X	X	X	X	X	X	X	X	X		X	
1-Gang Standard Data Plate	IFP12OW		X	X	X	X		X	X	X		X			X	
1-Gang iSTATION Plate Frame	IMF1OW		X	X	X	X		X	X	X		X			X	
Style Line® Data Plate	IFP126OW		X	X	X	X		X	X	X		X			X	
Duplex Data Plate	IFP18OW		X	X	X	X		X	X	X		X			X	
2-Gang iSTATION Plate Frame	IMF2OW													X		X
2-Gang Standard Data Plate	IFP29OW													X		X
2-Gang KP Series Plate	KP82															X

Note: Hubbell Office White plates and devices color match all non-metallic raceway systems.

## Physical Properties

(When tested in accordance with UL 5A)

Impact Resistance	5 ft. lbs.
Crush Resistance	300 lbs.
Temperature Range	-25.6° to 158° F
Flame Rating	UL94V-0
Material	UV Stabilized PVC

## Codes/Standards

EIA/TIA	569A
UL Standard	UL 5A
Listings	E118895 / E119190
CSA Standard	C22.2 no. 62
Certified	LR87514

## PlugTrak Specifications

Receptacle Rating	NEMA 5-15R & 5-20R
Wire	#12 AWG Stranded Copper
Receptacle Face	Thermoplastic

# Pre-Wired Raceway Pre-Wired Raceway Systems

Introduction

*Hubbell has been setting the standard* in the electrical industry since 1888, through innovations such as Twist-Lock®, Hospital Grade, and AUTOGUARD™ Self Test GFCI receptacles. Again, Hubbell has listened to our customers for new innovation, capacity requirements, and flexibility. We have taken raceway systems to the next level with *Pre-Wired Raceway Systems* that are manufactured to your specifications.

*Our Pre-Wired Raceway Systems* will accommodate your power and data requirements as your facility changes over time. Pre-Wired Raceways provide you with the benefit of keeping your fast track projects on schedule, and helping complete the job on time! Our Pre-Wired Raceway solutions will save up to 45% of the installation time needed for field installing component raceway parts.

*Pre-Wired Raceways are available in:*

- ✓ Steel (Ivory and Gray)
- ✓ Aluminum
- ✓ Non-Metallic (Office White)



### Quality by Design

All Hubbell Pre-Wired Raceways are UL Listed and CSA Certified. Each raceway receives a 100% quality inspection and testing prior to shipment. Pre-Wired Raceway is now available with the high quality and workmanship you have come to expect from Hubbell.



### Labeling and Engraving

Optional labeling is available to identify branch panels and circuits at receptacle locations. Choose from adhesive labels or engraved aluminum plates.



### Wire Identification

Wire leads are clearly labeled with corresponding circuit numbers. This aids the installer when terminating to building wiring or connecting from duct to duct. Ample wire is provided at feed locations.

**Save Time and Money, Completing the Job Quicker and On Schedule, with Hubbell...**

**With Standard Raceway...**



Unpack, identify and sort component parts.  
 Deliver components to work area for assembly and installation.



Measure and cut.  
 Clean and de-burr sharp edges.  
 Secure to the wall and fasten.



Pull wire.  
 Label and bundle each raceway circuit.  
 Install receptacles and test.

**With Hubbell Pre-Wired Raceway...**



Pallet delivered to your worksite, labeled by room, floor area and/or building.



Unpack and install!



Installed in half the time!



**Project Support and Documentation**

- ✓ A local and factory support team is there to assist in defining bills of material and project quotes, so costs can be budgeted accordingly.
- ✓ A project engineer, located at the factory, is assigned to your project as a direct point of contact.

**Manufacturing and Testing**

- ✓ Precisely measured, cleanly cut, wired and assembled to your specifications.
- ✓ The wiring harness is then bundled and labeled for circuit identification for ease of installation.
- ✓ Assembly is tested for assured continuity and 100% quality inspected before kitting.



**Installs In A Snap**

- ✓ Raceway ducts are kitted, labeled, and shipped by room, area or floor locations.
- ✓ Just remove raceway from the packaging and secure to the wall.
- ✓ Make power connections, snap on covers, test and you are done!



**Options:**



**Circuit Identification and Labeling:**

- ✓ Adhesive Labeling
- ✓ Engraving



**Wiring Circuits Options:**

- ✓ Insulation Displacement Connectors
- ✓ Wire Nuts
- ✓ Wiring Devices



**Kit raceway for delivery by:**

- ✓ Room
- ✓ Floor
- ✓ Area
- ✓ Building

**Aluminum Pre-Wired Raceway (LINKOSITY® devices may be utilized with this Raceway Series)**

**HBLALU3800 Series Aluminum Raceway**

**Description**

Aluminum Raceway, Single Channel,  
Satin Anodized Finish.

**Dimension**

A: 2.25" (57.15)  
B: 3.00" (76.20)

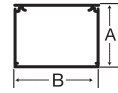

**HBLALU4800 Series Aluminum Raceway**

**Description**

Aluminum Raceway, Two Channel,  
Satin Anodized Finish.

A: 2.25" (57.15)  
B: 6.00" (152.40)

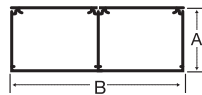

**HBLALU5000 Series Aluminum Raceway**

**Description**

Aluminum Raceway, Two Channel,  
Satin Anodized Finish.

A: 1.75" (44.45)  
B: 5.08" (129.03)

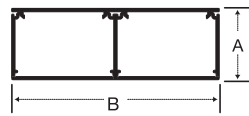

**HBLALU7620 Series Aluminum Raceway**

**Description**

Aluminum Raceway, Three Channel,  
Satin Anodized Finish.

A: 2.25" (57.15)  
B: 7.62" (193.55)

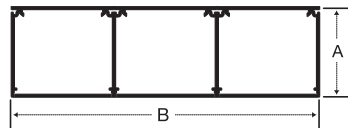

**Steel Pre-Wired Raceway (LINKOSITY® devices may be utilized with this Raceway Series)**

**HBL3000 Series Metal Raceway**

**Description**

Steel Raceway, Single Channel,  
Ivory or Gray Finish.

A: 1.53" (38.86)  
B: 2.75" (69.85)

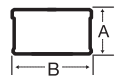

**HBL4750 Series Metal Raceway**

**Description**

Steel Raceway, Single or  
Two Channel (with Divider),  
Ivory or Gray Finish.

A: 1.75" (44.45)  
B: 4.75" (120.65)

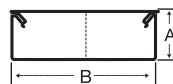

**HBL6750 Series Metal Raceway**

**Description**

Steel Raceway, Single,  
Two Channel (with One Divider)  
or Three Channel (with Two Dividers),  
Ivory or Gray Finish.

A: 2.22" (56.39)  
B: 6.75" (171.45)



**Non-Metallic Pre-Wired Raceway**

**PB2 BaseTrak® Series Non-Metallic Raceway**

**Description**

Non-Metallic Raceway,  
Two Channel,  
Office White Color.

A: 1.63" (41.40)  
B: 4.50" (114.30)

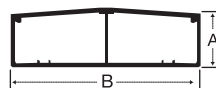

**PS3 Super BaseTrak® Series Non-Metallic Raceway**

**Description**

Non-Metallic Raceway,  
Three Channel,  
Office White Color.

A: 1.97" (50.04)  
B: 6.70" (170.18)

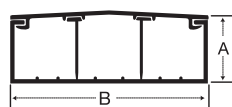

Dimensions in Inches (mm)



## UL Listed Modular Pre-Wired Raceway Systems Featuring the Flexibility of LINKOSITY® Connections

Hubbell Pre-Wired Metal Raceway with LINKOSITY® connections is a Hubbell innovation providing a flexible, modular UL Listed System that allows users to relocate furniture and equipment without the need to access the internal wiring of the raceway. The inherent flexibility of this system greatly reduces the cost of installation and future end-user costs associated with re-configuring space.

The Hubbell Metal Raceway/LINKOSITY combination can be provided as a factory assembled system or by having a licensed electrician purchase and field install the required LINKOSITY components into the metal raceway.

Features	Benefits
UL Listed, NEC Compliant assemblies	Complete code compliance minimizes design time, startup costs and building inspector acceptance.
Flexible, modular terminations	Simplifies moves, adds and changes. Reduces long term total cost of ownership.
Pre-configured, factory wired	Minimizes field wiring. Devices are custom configured to the application, tested and ready to install.
Cable rated TC-ER, MTW, STOOV	One cable suitable for use in all commercial applications
In-line 106 data/communications frame	Data/Communications may be field installed anywhere along the raceway eliminating large boxes.



Device Type	Ratings	Wires	Conductor Colors**	Length (FT)
PH = Double Ended Cable with Male/Female Straight PM = Male Single Ended Straight PN = Male Single Ended 90° PF = Female Single Ended Straight PG = Female Single Ended 90° PQ = Double Ended Cable with Female 90° PR = Double Ended Cable with Male 90° PS = Double Ended Cable with (2) 90° Connectors RF = Female Receptacle* RM = Male Receptacle (Inlet)*	20 = 20A up to 600V	02 03 04 05	PA = Green/Yellow Black (all others)  PB = Green/Yellow White Black (all others)  PE = All Blue***	001 = 1' 005 = 5' 010 = 10' 015 = 15' 020 = 20' 025 = 25' 030 = 30' 035 = 35' 040 = 40' 045 = 45' 050 = 50'
	23 = 20A up to 600V Specialty construction (Includes isolated ground on 6 wire and 10AWG super neutral conductor on 5 and 6 wire devices)	03 04 05 06		
	30 = 30A up to 600V	04		

\* 1/2 inch NPT rear thread  
 \*\*other color codes available upon request.  
 \*\*\*Two wire only.

Example: PH 23 06 PB 005



### Cable Assemblies

The LINKOSITY® cable assemblies are code compliant with the NEC and NFPA 79, and suitable for use in virtually any environment as either a permanent or temporary installation.



### Receptacles

The UL Listed LINKOSITY® male inlets or female receptacles provide the capability of interfacing directly with facility wiring by simply mounting into established fixed enclosures.



### Closure Caps

Protects unused devices from the harmful effects of harsh environments.



### Tees

Description	Catalog Number
LINKOSITY® M/F/F Tee, 20A, 2P	TX2002002002T00
LINKOSITY® M/F/F Tee, 20A, 3P	TX2003002003T00
LINKOSITY® M/F/F Tee, 20A, 4P	TX2004002004T00
LINKOSITY® M/F/F Tee, 20A, 5P	TX2005002005T00
LINKOSITY® M/F/F Tee, 20A SNIG, 4P	TX2304002304T00
LINKOSITY® M/F/F Tee, 20A SNIG, 6P	TX2306002306T00
LINKOSITY® M/F/F Tee, 20A SNIG, A Phase Tap	TX2306002304A00
LINKOSITY® M/F/F Tee, 20A SNIG, B Phase Tap	TX2306002304B00
LINKOSITY® M/F/F Tee, 20A SNIG, C Phase Tap	TX2306002304C00
LINKOSITY® M/F/F Tee, 30A, 4P	TX3004003004T00

### Specifications

Material	
Raceway	Steel, Anodized Aluminum
LINKOSITY Cables	UL 600V Type TC-ER, MTW, STOOV, polyurethane overmolded terminations
Codes/Standards	
Raceway	UL5, surface metal raceway and fittings C22.2 no. 62, surface metal raceway and fittings TIA/EIA 569B, commercial building standard for telecom pathways and spaces
LINKOSITY	UL2238, UL50

# Section S Trench and Wall Duct Products

## Index

Hubbell Trench Duct Series	Page
Features and Benefits . . . . .	S-2
Trench Duct Series and Fittings . . . . .	S-3
Additional Trench Duct Fittings . . . . .	S-4

Hubbell Wall Duct Series	Page
Features and Benefits . . . . .	S-5
Wall Duct Series and Elbows . . . . .	S-6
Wall Duct Fittings . . . . .	S-7
Additional Wall Duct Fittings . . . . .	S-8

Trench and Wall Duct Series

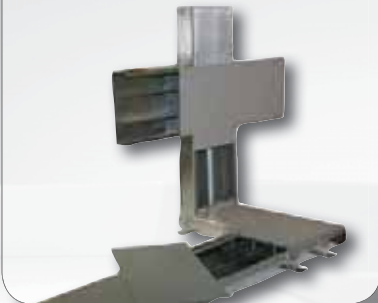

Elbow Fittings

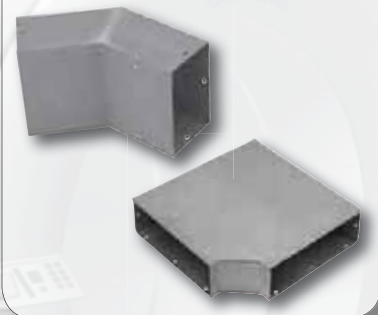

Vertical Riser Fittings

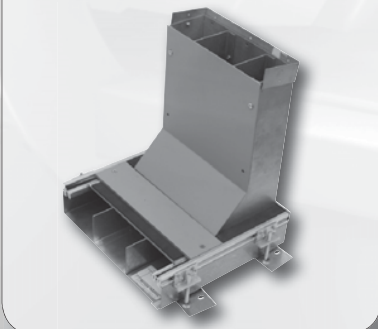

Trench Duct Fittings

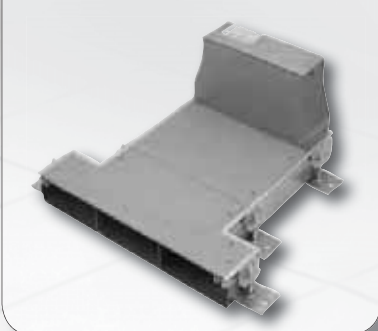

Hubbell also manufactures a comprehensive line of Floor Duct and Casino Duct products. Contact your local Hubbell representative for product information.

## Trench and Wall Duct Products

### Hubbell Trench Duct Series

Features and Benefits

#### A high capacity trench system for in-floor wire management.

The Hubbell Trench system is an in-floor wire management system that meets today's high capacity wiring needs that require multiple circuit separation. Trench duct is commonly used as a feeder system for medical wall duct when installing radiology equipment such as X-Ray and MRI machines. Trench duct is also used as a stand alone system for commercial and retail applications where ease of access and high capacity are crucial variables.



#### Multiple compartments provide more capacity than conventional ducts.

The Hubbell Trench system provides more capacity than conventional conduits and ducts. It features a single, high-capacity duct with up to four compartments for easy placement of additional wiring.

It's open top design allows wiring to be laid in the duct instead of being pulled, eliminating the need for junction boxes.

Removable covers are 1/4" thick and lock into the track of the trench. Internal dividers and/or support strips increase load capacity of heavy-duty cover. These removable covers allow free access to wiring and can be placed anywhere along the duct for easy wire exit relocation.

- High capacity design supports large wiring for single and multiple service requirements
- Open top design allows wire to be easily laid in duct
- Cover plates are removable and adjust horizontally to any point along the duct. Custom lengths of trench and fittings are available. Provided in either galvanized G90 steel or nonferrous aluminum.
- Multiple compartment options allows for multiple circuit and low voltage separation
- Innovative duct support assembly allows for pre-pour leveling
- Packaging and labeling by project floor and room is available



#### Trench Duct Range of Offering

Trench Product	Depth 1/2" Increments	Width	Compartments	Cover Plate
OKA = Trench	A = 2"	9	1C = 1 Compartment	1/4" = 1/4" thick
OKB = Pull Box	B = 2 1/2"	12	2C = 2 Compartment	
OKC = Exit Cover	C = 3"	18	3C = 3 Compartment	
OKE = End Cap	D = 3 1/2"	24	4C = 4 Compartment	
OKL = Horizontal L	E = 4"	(Other Widths Avail.)		
OKR = Vertical Riser	J = 6"			
OKT = T Junction Box	N = 8"			
OKX = X Junction Box	(Other Depths Available)			

Note: For Aluminum Trench Duct or Fittings, add "AL" suffix to catalog number.

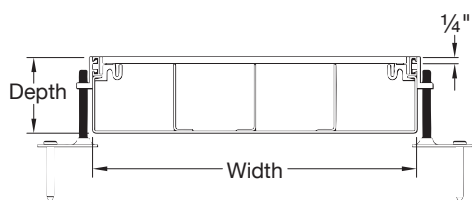



# Trench and Wall Duct Products

## Hubbell Trench Duct Series

Trench Duct Series and Fittings

### Ordering Information Notes:

1. Common use sizes are listed below. Contact factory for other configurations or see page S-2 for Range of Offering table.
2. Trench Duct part numbers are for reference only. All Trench Duct orders are lot billed with a generic TW prefix project specific part numbers. Please contact your local Hubbell Territory Manager for all Hubbell Duct quotations.

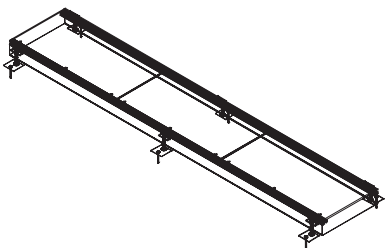
Trench Duct	Description	Trench Depth	Cover Width	No. of Compartments	Catalog Number	
	<b>Straight Section</b>		2½"	9"	1	
Manufactured in standard 6' lengths with factory installed dividers. Provided with (3) leveling feet on each side, (3) 24" long cover plates and (3) cover plate joint protectors.		3"	9"	2	OKA/C9-2C-1/4	
		2½"	12"	2	OKA/B12-2C-1/4	
		3"	12"	3	OKA/C12-3C-1/4	
		2½"	18"	3	OKA/B18-3C-1/4	
		3"	18"	4	OKA/C18-4C-1/4	
		2½"	24"	3	OKA/B24-3C-1/4	
		3"	24"	4	OKA/C24-4C-1/4	

Note: For Aluminum Trench Duct or Fittings, add "AL" suffix to catalog number.

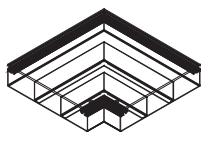
Fittings	Description	Outside Cover	No. of Compartments	Catalog Number	
	<b>Horizontal "L" Fitting</b>		12" x 12"	1	
Manufactured with a single cover and matching internal partitions to form a 90° horizontal "L". Includes cover plate joint protectors and leveling feet.		12" x 12"	2	OKL/C9-2C	
		15" x 15"	2	OKL/B12-2C	
		15" x 15"	3	OKL/C12-3C	
		21" x 21"	3	OKL/B18-3C	
		21" x 21"	4	OKL/C18-4C	
		27" x 27"	3	OKL/B24-3C	
		27" x 27"	4	OKL/C24-4C	
	<b>Horizontal 45° Elbow Fitting</b>		45°	1	OKL/B9-1Cx45
Manufactured with a split cover plate and matching internal partitions to form a 45° Mitered "L". Other angles available. Includes cover plate joint protectors and leveling feet.		45°	2	OKL/C9-2Cx45	
		45°	2	OKL/B12-2Cx45	
		45°	3	OKL/C12-3Cx45	
		45°	3	OKL/B18-3Cx45	
		45°	4	OKL/C18-4Cx45	
		45°	3	OKL/B24-3Cx45	
		45°	4	OKL/C24-4Cx45	
<b>Single Level "T" Junction Fitting</b>		15" x 12"	1	OKT/B9-1C	
Manufactured with matching internal partitions and crossovers to isolate power and communications. Includes cover plate joint protectors and leveling feet.		15" x 12"	2	OKT/C9-2C	
		18" x 15"	2	OKT/B12-2C	
		18" x 15"	3	OKT/C12-3C	
		24" x 21"	3	OKT/B18-3C	
		24" x 21"	4	OKT/C18-4C	
		30" x 27"	3	OKT/B24-3C	
		30" x 27"	4	OKT/C24-4C	
<b>Pull Box</b>		9" x 12"	1	OKB/B9-1C	
Manufactured to attach to trench section replacing end cap. Divided into compartment as shown. Additional depth permits attachment of large conduits. Box is field punched for conduits. Standard depth is 6".		9" x 12"	2	OKB/C9-2C	
		12" x 12"	2	OKB/B12-2C	
		12" x 12"	3	OKB/C12-3C	
		18" x 12"	3	OKB/B18-3C	
		18" x 12"	4	OKB/C18-4C	
		24" x 12"	3	OKB/B24-3C	
		24" x 12"	4	OKB/C24-4C	

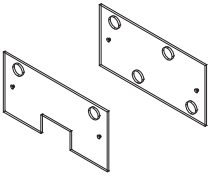
Exit Cover Fittings	Description	Trench Width	Max Size Conduit	Catalog Number	
	<b>Exit Cover</b>		9"	¾"	
Designed to provide exit and feed for Trench Duct. Conduit openings are provided for power and communication exit or feed using conventional fittings or service fittings. Cable Exit Cap (OKSK) is for communication cable only. Exit fittings cover may be spaced anywhere along the length of the trench. All exit fitting covers are 6" long.		12"	¾"	OKC/12-3/4A	
		18"	¾"	OKC/18-3/4A	
		24"	¾"	OKC/24-3/4A	
		9"	¾"	OKC/9-3/4C	
		12"	¾"	OKC/12-3/4C	
		18"	¾"	OKC/18-3/4C	
		24"	¾"	OKC/24-3/4C	
	<b>Cable Exit Cap</b>		All	—	OKSK
Fits opening in Type "A" Exit Cover. Provides outlet for communication cable. Debris barrier included. Cable Exit Cap constructed from die cast aluminum. For use with Type "A" exit covers only.					



# Trench and Wall Duct Products

## Hubbell Trench Duct Series

Trench Duct Fittings

### Ordering Information Notes:

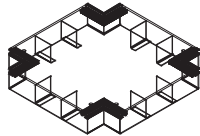
1. Common use sizes are listed below. Contact factory for other configurations or see page S-2 for Range of Offering table.
2. Trench Duct part numbers are for reference only. All Trench Duct orders are lot billed with a generic TW prefix project specific part numbers. Please contact your local Hubbell Territory Manager for all Hubbell Duct quotations.

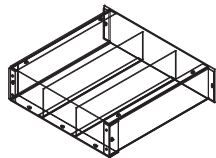
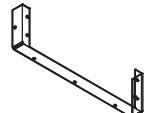
Fittings	Description	For Trench Duct (Width x Depth)	Max Size Conduit	Catalog Number	
	<b>Single Level "X" Junction Fitting</b> Manufactured with matching internal partitions and crossovers to isolate power and communications. Includes cover plate joint protectors and leveling feet.	15" x 15"	1	OKX/B9-1C	
15" x 15"		2	OKX/C9-2C		
18" x 18"		2	OKX/B12-2C		
18" x 18"		3	OKX/C12-3C		
24" x 24"		3	OKX/B18-3C		
24" x 24"		4	OKX/C18-4C		
30" x 30"		3	OKX/B24-3C		
30" x 30"	4	OKX/C24-4C			
<b>End Cap</b> Fits over end of trench run to close trench and prevent foreign material from entering. End cap may be drilled to accept conduit.	9" x 2½"	¾"	OKE/B9		
	9" x 3"	1"	OKE/C9		
	12" x 2½"	¾"	OKE/B12		
	12" x 3"	1"	OKE/C12		
	18" x 2½"	¾"	OKE/B18		
	18" x 3"	1"	OKE/C18		
	24" x 2½"	¾"	OKE/B24		
24" x 3"	1"	OKE/C24			
<b>Vertical Riser Fitting (Straight)</b> Manufactured to transition from trench duct to a panel, pull box or to conduit. Mounts on trench in place of cover. Partitioned to separate cells and flanged to attach to a pull box or panel. Removable front cover and top cover. Includes OWV trench-to-wall duct adapter. Standard height above finish floor — 12". Standard depth — 3½". Available in a sweep version (replace OKR with OKSWR)	9" x 3½"	—	OKR/D9-1C		
	9" x 3½"	—	OKR/D9-2C		
	12" x 3½"	—	OKR/D12-2C		
	12" x 3½"	—	OKR/D12-3C		
	18" x 3½"	—	OKR/D18-3C		
	18" x 3½"	—	OKR/D18-4C		
	24" x 3½"	—	OKR/D24-3C		
24" x 3½"	—	OKR/D24-4C			
<b>Trench to Wall Duct Adapter</b> Manufactured to transition from Trench Duct to Wall Duct. Mounts on trench in place of cover.	9" x 3½"	—	OWV/D9		
	12" x 3½"	—	OWV/D12		
	18" x 3½"	—	OWV/D18		
	24" x 3½"	—	OWV/D24		

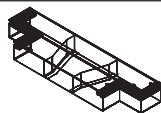
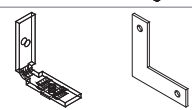
Additional Fittings	Description	Trench Width #1	Trench Width #2	Catalog Number	
	<b>Reducer Fitting</b> Manufactured to transition from a wide trench duct width to a narrower trench duct width.	9"	6"	OKARED/B9-6-2C	
12"		9"	OKARED/B12-9-3C		
18"		12"	OKARED/B18-12-3C		
24"		18"	OKARED/B24-18-4C		
<b>Fastening Angles</b> Accessories to join trench sections for field fabrication of horizontal and vertical assemblies.	Horizontal Angle	—	OK/VWI		
	Vertical Angle	—	OK/VVW		

Trench Duct Accessories	Description	Accessory Type	Catalog Number
	Permits 1" of pre-pour vertical adjustment and couples sections together. "x" represents screw height (max. 6") and height of trench. Additional vertical adjustment is available by increasing the length of screw "x".	Single Leveling Foot Assembly	OK/F-x
Provides a 1½" wide surface (with gasket) for cover plate joints. "x" represents trench width.	Single Cover Plate Joint Protector	OK/DSD-x	
Separates trench duct compartments. "x" represents trench depth (see catalog number system).	Divider	OKP/x	
Provided with ¼" x 18 bolts on 6" or 12" centers for increased cover plate weight loading capability.	Support Stud Strip	Consult Factory	

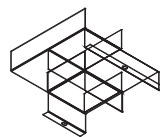
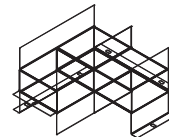
Tunnel Fittings	Description	No. of Compartments	"T" Unit Fitting Type	"X" Unit Fitting Type
	<b>Tunnels</b> Factory installed inside of multi-compartment "T" and "X" units to maintain separation of services. May be ordered separately and field installed.	2, 3, or 4	Consult Factory	Consult Factory
				

## Trench and Wall Duct Products

### Hubbell Wall Duct Series

*Features and Benefits*

The Hubbell Wall Duct is a UL Listed metal raceway system designed for the enclosure of wiring of MRI or X-Ray equipment in medical applications. The system provides complete lay-in wiring capability in order to accommodate the large cables and connectors used in today's installations.

Hubbell Wall Duct is available in either flush or surface mount and a combination will usually be required on any job. Vertical runs in the walls are usually flush mounted with horizontal runs on walls and all duct in ceiling plenum are typically surface type.

Wall Duct is available in ferrous steel and non-ferrous aluminum versions.



- Lay in wiring accommodates large cables and connectors to connect equipment
- Corrosion resistant galvanized A60 steel or non ferrous aluminum versions
- Flush (primarily wall) and Surface (primarily ceiling) mount provides flexibility to address specific equipment placement and unique room design requirements
- Hubbell Wall Duct is utilized with Hubbell Trench Duct
- Packaging and labeling by project floor and room is available



#### Wall Duct Range of Offering

Wall Duct Product		Depth ½" Increments	Width	Cover Style
OWA = Wall Duct	OWI = Internal Elbow	A = 2"	6	S = Surface
OWB = Adapter	OWL = External Elbow	B = 2½"	10	F = Flush
OWC = Coupling	OWP = Partition	C = 3"	12	
OWD = Reducer Coupling	OWR = Vertical Riser	D = 3½"	18	
OWE = End Closure	OWT = T Unit	E = 4"	(Other Widths Available)	
OWF = Cabinet Connector	OWV = Trench to Wall Duct Adapter	J = 6"		
OWH = Horizontal Elbow	OWX = X Unit	N = 8"		
		(Other Depths Available)		

*Note: For Aluminum Wall Duct or Fittings, add "AL" suffix to catalog number.*

# Trench and Wall Duct Products

## Hubbell Wall Duct Series

Wall Duct Series and Elbows

### Ordering Information Notes:

1. Common use sizes are listed below. Contact factory for other configurations or see page S-2 for Range of Offering table.
2. Trench Duct part numbers are for reference only. All Trench Duct orders are lot billed with a generic TW prefix project specific part numbers. Please contact your local Hubbell Territory Manager for all Hubbell Duct quotations.

Wall Duct	Description	Overall Depth	Body Width	Cover Width	Flush Catalog Number	Cover Width	Surface Catalog Number
	<b>Wall and Ceiling Duct</b> Manufactured in standard 60" lengths with two 30" long cover plates. Provided with one coupling and necessary screws.	3½"	9 <sup>13</sup> / <sub>16</sub> "	12"	OWA/D10F	10"	OWA/D10S
		3½"	11 <sup>13</sup> / <sub>16</sub> "	14"	OWA/D12F	12"	OWA/D12S
		3½"	17 <sup>13</sup> / <sub>16</sub> "	20"	OWA/D18F	18"	OWA/D18S

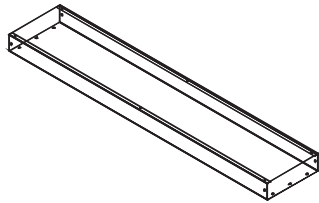

Note: For Aluminum Wall Duct or Fittings, add "AL" suffix to catalog number.

Elbow Fittings	Description	Overall Depth	Body Width	Cover Width	Flush Catalog Number	Cover Width	Surface Catalog Number
	<b>Internal Elbow</b> Forms a sharp 90° Internal "L". Provided with one cover plate, one coupling and necessary screws.	3½"	9 <sup>13</sup> / <sub>16</sub> "	12"	OVI/D10F	10"	OVI/D10S
		3½"	11 <sup>13</sup> / <sub>16</sub> "	14"	OVI/D12F	12"	OVI/D12S
		3½"	17 <sup>13</sup> / <sub>16</sub> "	20"	OVI/D18F	18"	OVI/D18S
	<b>Internal Elbow, Sweep</b> Forms a chamfered 90° Internal "L" for increased cable bend radius. Provided with one cover plate, one coupling and necessary screws.	3½"	9 <sup>13</sup> / <sub>16</sub> "	12"	OOSWI/D10F	10"	OOSWI/D10S
		3½"	11 <sup>13</sup> / <sub>16</sub> "	14"	OOSWI/D12F	12"	OOSWI/D12S
		3½"	17 <sup>13</sup> / <sub>16</sub> "	20"	OOSWI/D18F	18"	OOSWI/D18S
<b>Internal 45° Elbow</b> Forms a 45° Vertical "L". Provided with one cover plate, one coupling and necessary screws.	3½"	9 <sup>13</sup> / <sub>16</sub> "	12"	OVI45/D10F	10"	OVI45/D10S	
	3½"	11 <sup>13</sup> / <sub>16</sub> "	14"	OVI45/D12F	12"	OVI45/D12S	
	3½"	17 <sup>13</sup> / <sub>16</sub> "	20"	OVI45/D18F	18"	OVI45/D18S	
<b>Horizontal Elbow</b> Forms a 90° Horizontal "L". Provided with one cover plate, one coupling and necessary screws. Corner divider "OWCP" ordered separately.	3½"	9 <sup>13</sup> / <sub>16</sub> "	12"	OVIH/D10F	10"	OVIH/D10S	
	3½"	11 <sup>13</sup> / <sub>16</sub> "	14"	OVIH/D12F	12"	OVIH/D12S	
	3½"	17 <sup>13</sup> / <sub>16</sub> "	20"	OVIH/D18F	18"	OVIH/D18S	
<b>Horizontal 45° Elbow</b> Forms a 45° Horizontal "L". Provided with one cover plate, one coupling and necessary screws.	3½"	9 <sup>13</sup> / <sub>16</sub> "	12"	OVIH45/D10F	10"	OVIH45/D10S	
	3½"	11 <sup>13</sup> / <sub>16</sub> "	14"	OVIH45/D12F	12"	OVIH45/D12S	
	3½"	17 <sup>13</sup> / <sub>16</sub> "	20"	OVIH45/D18F	18"	OVIH45/D18S	
<b>External Elbow</b> Forms a sharp 90° External "L". Provided with two cover plates, one coupling and necessary screws.	3½"	9 <sup>13</sup> / <sub>16</sub> "	12"	OVIW/D10F	10"	OVIW/D10S	
	3½"	11 <sup>13</sup> / <sub>16</sub> "	14"	OVIW/D12F	12"	OVIW/D12S	
	3½"	17 <sup>13</sup> / <sub>16</sub> "	20"	OVIW/D18F	18"	OVIW/D18S	

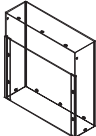
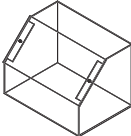
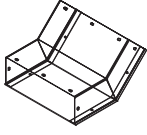
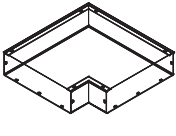
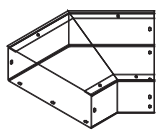
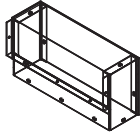
Note: Images shown are surface mount.

# Trench and Wall Duct Products

## Hubbell Wall Duct Series

Wall Duct Fittings

### Ordering Information Notes:

1. Common use sizes are listed below. Contact factory for other configurations or see page S-2 for Range of Offering table.
2. Trench Duct part numbers are for reference only. All Trench Duct orders are lot billed with a generic TW prefix project specific part numbers. Please contact your local Hubbell Territory Manager for all Hubbell Duct quotations.

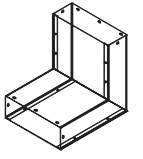
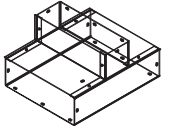
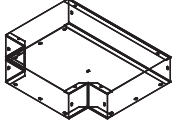
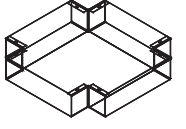
	Description	Overall Depth	Body Width	Cover Width	Flush Catalog Number	Cover Width	Surface Catalog Number	
Internal / External Elbows	<b>Internal / External Elbow</b>	3½"	9 <sup>13</sup> / <sub>16</sub> "	12"	—	10"	SPOWI/D10S	
	Transitions from surface wall duct to surface style ceiling duct. Flush wall duct to surface style ceiling duct available upon request. Provided with two cover plates, one coupling and necessary screws.	3½"	11 <sup>13</sup> / <sub>16</sub> "	14"	—	12"	SPOWI/D12S	
		3½"	17 <sup>13</sup> / <sub>16</sub> "	20"	—	18"	SPOWI/D18S	
	<b>Internal / External Elbow, Sweep</b>	3½"	9 <sup>13</sup> / <sub>16</sub> "	12"	—	10"	SPOWSWI/D10S	
	Transitions from surface wall duct to surface style ceiling duct. Flush wall duct to surface style ceiling duct available upon request. Provided with two cover plates, one coupling and necessary screws.	3½"	11 <sup>13</sup> / <sub>16</sub> "	14"	—	12"	SPOWSWI/D12S	
		3½"	17 <sup>13</sup> / <sub>16</sub> "	20"	—	18"	SPOWSWI/D18S	
"T" Units	<b>Vertical "T" Unit</b>	3½"	9 <sup>13</sup> / <sub>16</sub> "	12"	OWVT/D10F	10"	OWVT/D10S	
	Forms a 90° Vertical "T". Provided with three cover plates, two couplings and necessary screws.	3½"	11 <sup>13</sup> / <sub>16</sub> "	14"	OWVT/D12F	12"	OWVT/D12S	
		3½"	17 <sup>13</sup> / <sub>16</sub> "	20"	OWVT/D18F	18"	OWVT/D18S	
	<b>Horizontal "T" Unit</b>	3½"	9 <sup>13</sup> / <sub>16</sub> "	12"	OWT/D10F	10"	OWT/D10S	
Forms a 90° Horizontal "T". Provided with one cover plate, one coupling and necessary screws. Tunnels are ordered separately.	3½"	11 <sup>13</sup> / <sub>16</sub> "	14"	OWT/D12F	12"	OWT/D12S		
	3½"	17 <sup>13</sup> / <sub>16</sub> "	20"	OWT/D18F	18"	OWT/D18S		
"X" Unit	<b>"X" Unit</b>	3½"	9 <sup>13</sup> / <sub>16</sub> "	12"	OWX/D10F	10"	OWX/D10S	
	Forms intersection of four perpendicular ducts. Provided with one cover plate, two coupling and necessary screws. Tunnels are ordered separately.	3½"	11 <sup>13</sup> / <sub>16</sub> "	14"	OWX/D12F	12"	OWX/D12S	
		3½"	17 <sup>13</sup> / <sub>16</sub> "	20"	OWX/D18F	18"	OWX/D18S	

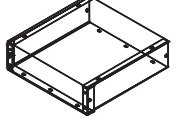
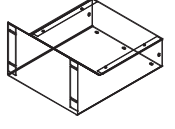
	Description	For Trench Width	For Wall Duct (Width x Depth)	Flush Catalog Number	Surface Catalog Number	
Vertical Riser Fittings	<b>Vertical Riser Fitting, Straight</b>	10"	10" x 3½"	OWR/D10F	OWR/D10S	
	Transitions from trench duct to a vertical run of wall duct. Mounts on trench in place of cover. Removable front cover. Standard height above finish floor — 12" (7" for OWR/D12x10). Standard depth — 3½". Provided with one coupling and necessary screws.	12"	12" x 3½"	OWR/D12F	OWR/D12S	
		18"	18" x 3½"	OWR/D18F	OWR/D18S	
		12"	10" x 3½"	OWR/D12-10F	OWR/D12-10S	
	<b>Vertical Riser Fitting, Sweep</b>	10"	10" x 3½"	OWSWR/D10F	OWSWR/D10S	
	Transitions from trench duct to a vertical run of wall duct. Mounts on trench in place of cover. Removable front cover. Standard height above finish floor — 12". Standard depth — 3½". Provided with one coupling and necessary screws.	12"	12" x 3½"	OWSWR/D12F	OWSWR/D12S	
	18"	18" x 3½"	OWSWR/D18F	OWSWR/D18S		
	12"	10" x 3½"	OWSWR/D12-10F	OWSWR/D12-10S		

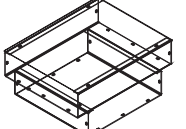
	Description	Overall Depth	Flush Wall Duct Body Width	Surface Cover Width	Catalog Number	
Adapter Fitting	<b>Flush to Surface Adapter</b>	3½"	9 <sup>13</sup> / <sub>16</sub> "	10"	OWB/D10-10	
	Transitions from flush wall duct to perpendicular surface wall duct. Provided with one cover plate, two couplings and necessary screws.	3½"	11 <sup>13</sup> / <sub>16</sub> "	18"	OWB/D12-18	
		3½"	17 <sup>13</sup> / <sub>16</sub> "	12"	OWB/D18-12	
		3½"	17 <sup>13</sup> / <sub>16</sub> "	18"	OWB/D18-18	

# Wall and Trench Duct Products



## Hubbell Wall Duct Series

Wall Duct Fittings

### Ordering Information Notes:

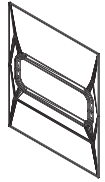
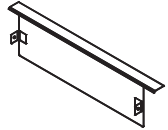
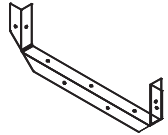
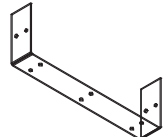
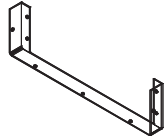
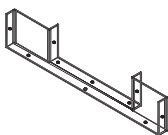
1. Common use sizes are listed below. Contact factory for other configurations or see page S-2 for Range of Offering table.
2. Trench Duct part numbers are for reference only. All Trench Duct orders are lot billed with a generic TW prefix project specific part numbers. Please contact your local Hubbell Territory Manager for all Hubbell Duct quotations.

	Description	Overall Depth	Cover Width	Flush Catalog Number	Cover Width	Surface Catalog Number	
Additional Fittings	<b>Split Cover Plate</b> Provides wire egress from raceway. Provided with assembly screws and grommet material.	—	12"	OWSC/10F	10"	OWSC/10S	
		—	14"	OWSC/12F	12"	OWSC/12S	
		—	20"	OWSC/18F	18"	OWSC/18S	
	<b>End Cap</b> Closes off end of wall duct. Screws provided.	3½"	12"	OWE/D10F	10"	OWE/D10S	
		3½"	14"	OWE/D12F	12"	OWE/D12S	
		3½"	20"	OWE/D18F	18"	OWE/D18S	
	<b>Cabinet Connector</b> Connects wall duct to enclosures. Designed to be positioned around outside surface of duct and secured with screws from inside of duct. Screws provided.	3½"	12"	—	10"	OWF/D10	
	3½"	14"	—	12"	OWF/D12		
	3½"	20"	—	18"	OWF/D18		
<b>Coupling</b> Joins surface or flush wall duct sections together. Designed to be positioned around outside surface of duct and secured with screws from inside of duct. Screws provided.	3½"	12"	—	10"	OWC/D10		
	3½"	14"	—	12"	OWC/D12		
	3½"	20"	—	18"	OWC/D18		
<b>Trench to Wall Duct Adapter</b> Transitions from trench duct to a vertical run of wall duct when not using the OWR series Vertical Riser. Mounts on trench in place of cover. Provided with necessary screws.	3½"	12"	—	10"	OWV/D10		
	3½"	14"	—	12"	OWV/D12		
	3½"	20"	—	18"	OWV/D18		
<b>Reducer Coupling</b> Joins two sizes of surface or flush wall duct sections together. Designed to be positioned around outside surface of duct and secured with screws from inside of duct. Screws provided.	3½"	12"	—	18" to 10"	OWD/D (18-10)		
	3½"	14"	—	18" to 12"	OWD/D (18-12)		

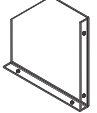
	Description	For Overall Raceway Depth	Surface Cover Width	For Fitting Style		
				Straight	Horizontal "L"	Internal Sweep Elbow
Partitions Fittings	<b>Internal Duct Partitions</b> Divides raceway and fittings into compartments. Screws provided.	3½"	10"	OWP/D10	—	—
		3½"	12"	—	OWC/PD	—
		3½"	18"	—	—	OWSWP/D
						

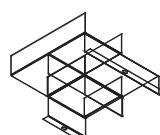
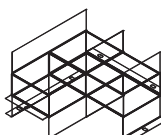
	Description	No. of Compartments	"T" Unit Fitting Type	"X" Unit Fitting Type
Tunnel Fittings	<b>Tunnels</b> Field installed inside of multi-compartment "T" and "X" units to maintain separation of services. May be factory installed.	2, 3, or 4	Consult Factory	Consult Factory
				

# Section T Wire Basket Tray System

## Index

Product	Page
Innovative, Flexible, Field-Configurable Wire Basket Solutions . . . . .	T-2
Wire Fill and Maximum Load Chart . . . . .	T-3
Round Wire Basket Tray . . . . .	T-4
Flat Style Wire Basket Tray . . . . .	T-5
Stainless Steel Wire Basket Tray . . . . .	T-6
Accessories for Wire Basket Tray . . . . .	T-7
Wire Basket Tray Technical Support . . . . .	T-9
Wire Basket Tray: Create a Bill of Material . . . . .	T-10

Round and Flat Style Wire Basket Tray



Accessories



Technical Support



Create a Bill of Material



# Wire Basket Tray System

## Innovative, Flexible, Field-Configurable Wire Basket Solutions

### Support Broad Range of Applications

Hubbell has a wire basket system to meet specific requirements. From pre-galvanized solutions for commercial controlled interior environments, to a stainless steel version for industrial applications, such as food processing, marine and highly corrosive environments. Hubbell Wire Basket Systems will help save labor and minimize waste, while reducing impact to the environment. The painted masked version reduces on-site paint removal, saving time and money. Hubbell Wire Basket Systems are available in overhead and raised floor applications. Both systems are UL classified as equipment ground conductor, provided they are installed and spliced according to our recommended instructions.

### Pre-Galvanized Finish is Environmentally Friendly

The standard finish for Hubbell Basket Tray is pre-galvanized, which is a significantly more environment friendly manufacturing process than a galvanizing dip. Pre-galvanizing applies a zinc galvanizing to the basket PRIOR to fabrication. Then the galvanized wire is welded and formed into the appropriate basket size. On the other hand, a post-fabrication zinc application involves chemical cleaning and stripping, and heavy metal dipping vats to apply the zinc. This produces fumes and requires proper disposal of chemicals and metals. Hubbell's pre-galvanized finish performs the same as the post-production finish while avoiding secondary chemical processing. A post-fabrication electro-zinc finish is also available, if the customer prefers.

### Pre-Galvanized

Wire is galvanized prior to fabrication.



Applications	Specification
<ul style="list-style-type: none"> <li>• Commercial</li> <li>• Controlled Interiors</li> </ul>	ASTM A641

### Painted Finishes ♦

Powder coat; Black is available as standard.



Applications	Specification
<ul style="list-style-type: none"> <li>• Data Center</li> <li>• Controlled Interiors</li> </ul>	N/A

Note: ♦ Available as a special order.

### Sustainable Approach



Hubbell utilizes a sustainable approach to assist in maintaining our environment.

Our wire basket systems utilize 100% recycled steel content in the manufacturing of our tray, and are packaged in kraft packaging that is not bleached. Packaging and strapping materials are recyclable. MillCerts are available upon request to assist in documenting recycled content for possible LEED credits.

### Customer Support and Technical Assistance

Hubbell's knowledgeable sales team is just a call away for assistance in selecting the proper type basket tray for any application or providing design assistance, including developing a bill of material.

### Stainless Steel ♦

Type 304L and 316S



Applications	Specification
<ul style="list-style-type: none"> <li>• Industrial</li> <li>• Marine</li> <li>• Food Processing</li> <li>• Outdoor</li> </ul>	ASTM A580

### Electroplated Zinc ♦

Tray is galvanized after fabrication.



Applications	Specification
<ul style="list-style-type: none"> <li>• Commercial</li> <li>• Controlled Interiors</li> </ul>	ASTM A641



# Wire Basket Tray System Wire Fill and Maximum Load Chart

## Wire Fill and Maximum Load Chart

Depth	Width	Area	Cat 5e (0.18" dia.) 50% Wire Fill	Cat 6 (0.23" dia.) 50% Wire Fill	Cat 6a (0.30" dia.) 50% Wire Fill	Max. load (Lb/ft) (Supported at 6ft spacing)
2	4	8	157	96	57	45
2	6	12	236	144	85	50
2	8	16	315	193	113	52
2	12	24	472	289	170	58
2	16	32	629	385	226	70
2	18	36	708	433	255	70
2	20	40	786	482	283	73
2	22	44	865	530	311	73
2	24	48	944	578	340	75
2	26	52	1022	626	368	73
2	28	56	1101	674	396	73
2	30	60	1180	722	425	70
2	32	64	1258	771	453	70
4	4	16	315	193	113	49
4	6	24	472	289	170	49
4	8	32	629	385	226	78
4	12	48	944	578	340	78
4	16	64	1258	771	453	108
4	18	72	1415	867	510	116
4	20	80	1573	963	566	116
4	22	88	1730	1060	623	116
4	24	96	1887	1156	679	116
4	28	112	2202	1349	793	108
6	8	48	944	578	340	116
6	12	72	1415	867	510	123
6	16	96	1887	1156	679	123
6	18	108	2123	1300	764	127
6	20	120	2359	1445	849	127
6	22	132	2595	1589	934	127
6	24	144	2831	1734	1019	150
8	8	64	1258	771	453	116
8	12	96	1887	1156	679	116
8	16	128	2516	1541	906	116
8	18	144	2831	1734	1019	116
8	20	160	3145	1926	1132	116

### Sizes are UL Classified and cUL Classified as equipment ground conductor

2" Depth	4" Depth	6" Depth	8" Depth
2 x 6	4 x 6	6 x 8	8 x 8
2 x 8	4 x 8	6 x 12	8 x 12
2 x 12	4 x 12	6 x 16	8 x 16
2 x 16	4 x 16	6 x 18	8 x 20
2 x 18	4 x 18	6 x 20	
2 x 20	4 x 20	6 x 22	
2 x 24	4 x 24	6 x 24	

Note: Applicable to pre-galvanized and powder coat painted when spliced as recommended. Other non-UL sizes require external grounding conductor. Stainless steel is not UL Classified.

### Instructions to Achieve Ground

- Use Hubbell splice kits (**HBTSK**) to achieve proper grounding at all splices, joints, and fitting.
- Grounding lugs and external ground wire are not required, provided **HBTSK** splice kits are utilized with steel tray. (Stainless steel tray requires external grounding conductor.)

# Wire Basket Tray System

## Round Wire Basket Tray



Round Cross-Wire Design



### Features

- T-weld construction prevents snags
- 5mm round wire on smaller sizes
- 6mm round wire on larger sizes
- High load rating
- Easy to cut and fabricate fittings in the field
- 100% recycled steel
- Use factory support hardware or fabricate supports on the job site
- 2" x 4" mesh opening
- Painted tray includes factory installed masking to assure proper grounding at splices; no need to remove paint during installation

### Round Wire Basket Tray

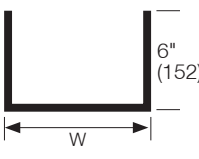
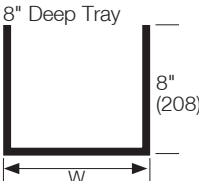
10 Feet per Length 118.312" (3m) 10 pc. min. order qty. 2" Deep Tray	Width In (mm)	Load (Lb/ft)	Weight per Piece (Lb)	Splice Quantity		Finish	
				90° Sweep Elbow	Straight Splice	Pre-Galvanized	Black Powder Coat
	4" (102) ●	45	7	2	2	HBT0204	HBT0204BK
	6" (152) ●●	50	9	3	4	HBT0206	HBT0206BK
	8" (203) ●●●	52	10.5	4	4	HBT0208	HBT0208BK
	12" (305) ●●●●	58	12	6	4	HBT0212	HBT0212BK
	16" (406) ●●●●●	70	15	7	4	HBT0216	HBT0216BK
	18" (457) ●●●●●●	70	23	9	4	HBT0218	HBT0218BK
	20" (508) ●●●●●●●	73	25	9	5	HBT0220	HBT0220BK
	22" (559) ●●●●●●●●	73	27	12	5	HBT0222	HBT0222BK
	24" (610) ●●●●●●●●●	75	31	12	5	HBT0224	HBT0224BK
	26" (660) ●●●●●●●●●●	73	33	13	6	HBT0226	HBT0226BK
	28" (711) ●●●●●●●●●●●	73	35	14	6	HBT0228	HBT0228BK
	30" (762) ●●●●●●●●●●●●	70	38	15	6	HBT0230	HBT0230BK
32" (813) ●●●●●●●●●●●●●	70	39	16	6	HBT0232	HBT0232BK	
	4" (102) ●	49	12	2	4	HBT0404	HBT0404BK
	6" (152) ●●	49	13	3	5	HBT0406	HBT0406BK
	8" (203) ●●●	78	15	4	6	HBT0408	HBT0408BK
	12" (305) ●●●●	78	23	6	6	HBT0412	HBT0412BK
	16" (406) ●●●●●	108	27	7	7	HBT0416	HBT0416BK
	18" (457) ●●●●●●	116	29	9	7	HBT0418	HBT0418BK
	20" (508) ●●●●●●●	116	31	9	7	HBT0420	HBT0420BK
	22" (559) ●●●●●●●●	116	33	12	8	HBT0422	HBT0422BK
	8" (203) ●●	116	23	4	6	HBT0608	HBT0608BK
	12" (305) ●●●	123	27	6	6	HBT0612	HBT0612BK
	16" (406) ●●●●	123	31	7	7	HBT0616	HBT0616BK
	18" (457) ●●●●●	127	33	9	7	HBT0618	HBT0618BK
	20" (508) ●●●●●●	127	35	9	7	HBT0620	HBT0620BK
	22" (559) ●●●●●●●	127	37	12	8	HBT0622	HBT0622BK
	24" (610) ●●●●●●●●	150	39	12	8	HBT0624	HBT0624BK
	8" (203) ●●	116	27	4	8	HBT0808	HBT0808BK
	12" (305) ●●●	116	31	6	8	HBT0812	HBT0812BK
	16" (406) ●●●●	116	35	7	9	HBT0816	HBT0816BK
	18" (457) ●●●●●	116	37	9	9	HBT0818	HBT0818BK
20" (508) ●●●●●●	116	39	9	9	HBT0820	HBT0820BK	

Note: ● UL Classified and cUL Classified as equipment ground conductor.  
 ● 5mm diameter round wire. (All others are 6mm diameter round wire.)  
 All dimensions are +/- 0.25". Custom paint colors available in addition to Black Powder Coat (Contact Hubbell).

### Field Configurable Fittings



**90° Sweep Elbow**  
Use appropriate quantity of splice Kits



**Tee Fitting**  
Use one HBTCS corner splice per each

### Supports and Hardware

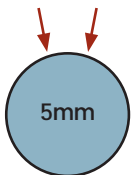
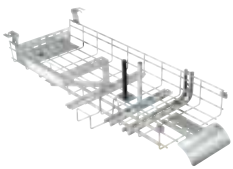

.0078125 sq. inch  
"Round" Wire Design

Dimensions in Inches (mm)

# Wire Basket Tray System

## Flat Style Wire Basket Tray



Flat Cross-Wire Design



### Features

- Flat shaped cross-wires provide significantly more surface area to support weight of cables
- Flat ribs provide 400% more surface area and reduce stress on cables by 60%
- 100% recycled steel
- 2" x 4" mesh opening
- Reduction in stress helps maintain Cat 6 and Cat 6A performance
- Cuts and configures the same as round wire tray
- Uses the same splicing and mounting hardware as round wire tray

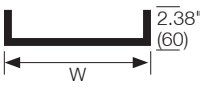
### Flat Style Wire Basket Tray

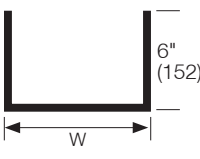
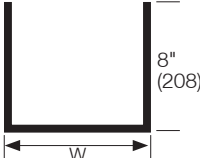
10 Feet per Length 118.312" (3m) 10 pc. min. order qty. 2" Deep Tray	Width In (mm)	Load (Lb/ft)	Weight per Piece (Lb)	Splice Quantity		Finish	
				90° Sweep Elbow	Straight Splice	Pre-Galvanized	Black Powder Coat
	4" (102)	45	7	2	2	HBT0204S	HBT0204SBK
	6" (152) ●	50	9	3	4	HBT0206S	HBT0206SBK
	8" (203) ●	52	10.5	4	4	HBT0208S	HBT0208SBK
	12" (305) ●	58	12	6	4	HBT0212S	HBT0212SBK
	16" (406) ●	70	15	7	4	HBT0216S	HBT0216SBK
	18" (457) ●	70	23	9	4	HBT0218S	HBT0218SBK
	20" (508) ●	73	25	9	5	HBT0220S	HBT0220SBK
	22" (559)	73	27	12	5	HBT0222S	HBT0222SBK
	24" (610) ●	75	31	12	5	HBT0224S	HBT0224SBK
	26" (660)	73	33	13	6	HBT0226S	HBT0226SBK
	28" (711)	73	35	14	6	HBT0228S	HBT0228SBK
	30" (762)	70	38	15	6	HBT0230S	HBT0230SBK
32" (813)	70	39	16	6	HBT0232S	HBT0232SBK	
	4" (102)	49	12	2	4	HBT0404S	HBT0404SBK
	6" (152) ●	49	13	3	5	HBT0406S	HBT0406SBK
	8" (203) ●	78	15	4	6	HBT0408S	HBT0408SBK
	12" (305) ●	78	23	6	6	HBT0412S	HBT0412SBK
	16" (406) ●	108	27	7	7	HBT0416S	HBT0416SBK
	18" (457) ●	116	29	9	7	HBT0418S	HBT0418SBK
	20" (508) ●	116	31	9	7	HBT0420S	HBT0420SBK
	22" (559)	116	33	12	8	HBT0422S	HBT0422SBK
	24" (610) ●	116	35	12	8	HBT0424S	HBT0424SBK
	28" (711)	108	39	14	9	HBT0428S	HBT0428SBK
	8" (203) ●	116	23	4	6	HBT0608S	HBT0608SBK
	12" (305) ●	123	27	6	6	HBT0612S	HBT0612SBK
	16" (406) ●	123	31	7	7	HBT0616S	HBT0616SBK
	18" (457) ●	127	33	9	7	HBT0618S	HBT0618SBK
	20" (508) ●	127	35	9	7	HBT0620S	HBT0620SBK
	22" (559) ●	127	37	12	8	HBT0622S	HBT0622SBK
	24" (610) ●	150	39	12	8	HBT0624S	HBT0624SBK
	8" (203) ●	116	27	4	8	HBT0808S	HBT0808SBK
	12" (305) ●	116	31	6	8	HBT0812S	HBT0812SBK
	16" (406) ●	116	35	7	9	HBT0816S	HBT0816SBK
	18" (457) ●	116	37	9	9	HBT0818S	HBT0818SBK
	20" (508) ●	116	39	9	9	HBT0820S	HBT0820SBK

Note: ● UL Classified and cUL Classified as equipment ground conductor.  
All dimensions are +/- 0.25". Custom paint colors available in addition to Black Powder Coat (Contact Hubbell).

### Field Configurable Fittings



**90° Sweep Elbow**  
Use appropriate quantity of splice Kits



**Tee Fitting**  
Use one HBTCS corner splice per each

### Supports and Hardware

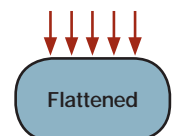
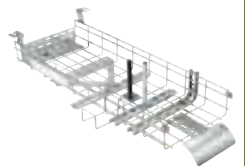

Flattened  
.03125 sq. inch  
"Flat" Wire Design

Dimensions in Inches (mm)

# Wire Basket Tray System

## Stainless Steel Wire Basket Tray

Round Cross-Wire Design



### Features

- Type 304L and 316S Stainless Steel
- Meets ASTM A580 specifications
- Stainless splice kits and ceiling supports are available

### Applications

- Food processing
- Wash down areas
- Corrosive environments
- Outdoor installations
- Marine

### Stainless Steel Accessories Available





HBTSKSS  
Splice Kits



HBTCLGyySS  
Ceiling Support  
(yy = width of tray)

Use standard galvanized or painted supports and hardware.

### Stainless Steel Wire Basket Tray

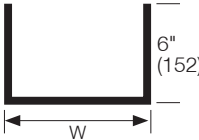
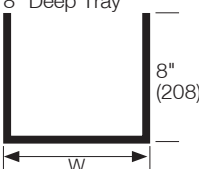
10 Feet per Length 118.312" (3m) 10 pc. min. order qty. 2" Deep Tray	Width In (mm)	Load (Lb/ft)	Weight per Piece (Lb)	Splice Quantity		Round	
				90° Sweep Elbow	Straight Splice	Type 304L	Type 316S
	4" (102)	45	7	2	2	HBT0204S04	HBT0204S16
	6" (152)	50	9	3	4	HBT0206S04	HBT0206S16
	8" (203)	52	10.5	4	4	HBT0208S04	HBT0208S16
	12" (305)	58	12	6	4	HBT0212S04	HBT0212S16
	16" (406)	70	15	7	4	HBT0216S04	HBT0216S16
	18" (457)	70	23	9	4	HBT0218S04	HBT0218S16
	20" (508)	73	25	9	5	HBT0220S04	HBT0220S16
	22" (559)	73	27	12	5	HBT0222S04	HBT0222S16
	24" (610)	75	31	12	5	HBT0224S04	HBT0224S16
	26" (660)	73	33	13	6	HBT0226S04	HBT0226S16
	28" (711)	73	35	14	6	HBT0228S04	HBT0228S16
	30" (762)	70	38	15	6	HBT0230S04	HBT0230S16
32" (813)	70	39	16	6	HBT0232S04	HBT0232S16	
	4" (102)	49	12	2	4	HBT0404S04	HBT0404S16
	6" (152)	49	13	3	5	HBT0406S04	HBT0406S16
	8" (203)	78	15	4	6	HBT0408S04	HBT0408S16
	12" (305)	78	23	6	6	HBT0412S04	HBT0412S16
	16" (406)	108	27	7	7	HBT0416S04	HBT0416S16
	18" (457)	116	29	9	7	HBT0418S04	HBT0418S16
	20" (508)	116	31	9	7	HBT0420S04	HBT0420S16
	22" (559)	116	33	12	8	HBT0422S04	HBT0422S16
	24" (610)	116	35	12	8	HBT0424S04	HBT0424S16
	8" (203)	116	23	4	6	HBT0608S04	HBT0608S16
	12" (305)	123	27	6	6	HBT0612S04	HBT0612S16
	16" (406)	123	31	7	7	HBT0616S04	HBT0616S16
	18" (457)	127	33	9	7	HBT0618S04	HBT0618S16
	20" (508)	127	35	9	7	HBT0620S04	HBT0620S16
	22" (559)	127	37	12	8	HBT0622S04	HBT0622S16
	24" (610)	150	39	12	8	HBT0624S04	HBT0624S16
		8" (203)	116	27	4	8	HBT0808S04
12" (305)		116	31	6	8	HBT0812S04	HBT0812S16
16" (406)		116	35	7	9	HBT0816S04	HBT0816S16
18" (457)		116	37	9	9	HBT0818S04	HBT0818S16
20" (508)		116	39	9	9	HBT0820S04	HBT0820S16

Note: All dimensions are +/- 0.25".

Dimensions in Inches (mm)

# Wire Basket Tray System Accessories for Wire Basket Tray

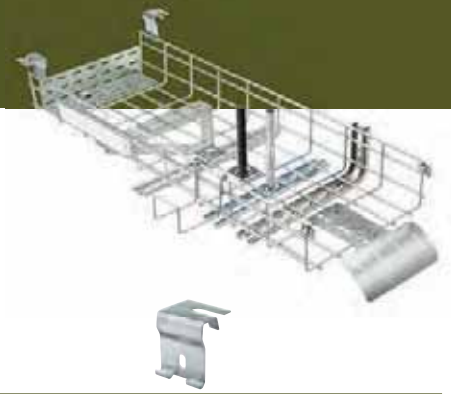

## Supports\*





Width In (mm)	Center Support			Ceiling Support			Trapeze Support		
	Qty per Box	Weight (Lb/each)	Catalog Number	Qty per Box	Weight (Lb/each)	Catalog Number	Qty per Box	Weight (Lb)	Catalog Number
4" (102)	1	1.6	<b>HBTCTRS4</b>	–	–	–	50	9.0/box	<b>HBTT5</b> Attaches to the side of the tray; for tray sizes 16" wide and smaller; use in pairs
6" (152)	1	1.8	<b>HBTCTRS6</b>	–	–	–			
8" (203)	1	2	<b>HBTCTRS8</b>	–	–	–			
12" (305)	1	2.7	<b>HBTCTRS12</b>	1	1.1	<b>HBTCGLS12</b>			
16" (406)	1	3.3	<b>HBTCTRS16</b>	1	1.5	<b>HBTCGLS16</b>			
18" (457)	1	3.4	<b>HBTCTRS18</b>	1	1.6	<b>HBTCGLS18</b>			
20" (508)	1	3.8	<b>HBTCTRS20</b>	1	1.9	<b>HBTCGLS20</b>			
24" (610)	1	4.4	<b>HBTCTRS24</b>	1	1.9	<b>HBTCGLS24</b>			

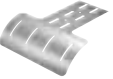

## Supports\*

Width In (mm)	L-Bracket			C-Bracket			Shelf Support		
	Qty per Box	Weight (Lb/each)	Catalog Number	Qty per Box	Weight (Lb/each)	Catalog Number	Qty per Box	Weight (Lb/each)	Catalog Number
4" (102)	1	0.7	<b>HBTLB4</b>	1	1.2	<b>HBTCB4</b>	1	0.4	<b>HBTSS4</b>
6" (152)	1	0.8	<b>HBTLB6</b>	–	–	–	1	0.5	<b>HBTSS6</b>
8" (203)	1	0.9	<b>HBTLB8</b>	1	1.5	<b>HBTCB8</b>	1	0.6	<b>HBTSS8</b>
12" (305)	1	1.4	<b>HBTLB12</b>	1	2.0	<b>HBTCB12</b>	1	1.2	<b>HBTSS12</b>
16" (406)	1	1.5	<b>HBTLB16</b>	–	–	–	1	1.7	<b>HBTSS16</b>
18" (457)	1	1.7	<b>HBTLB18</b>	1	2.7	<b>HBTCB18</b>	1	1.9	<b>HBTSS18</b>
20" (508)	1	2.1	<b>HBTLB20</b>	–	–	–	1	2.6	<b>HBTSS20</b>
24" (610)	1	2.3	<b>HBTLB24</b>	–	–	–	1	3.2	<b>HBTSS24</b>

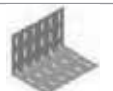
## Accessories\*

Description	Tray Width In (mm)	Qty. per Box	Weight (Lb/each)	Catalog Number	
<b>Radius Down</b> Increases cable protection and cable bend control	4" (102) 6" (152) 12" (305)	1 1 1	2.5 3.75 7.5	<b>HBTRD4</b> <b>HBTRD6</b> <b>HBTRD12</b>	
<b>Vertical Down</b> Protects cables when dropping from the end or side of tray	7¾" (102)	1	1.5	<b>HBTVD</b>	
<b>Label Clip</b> Attachment for all sizes of tray		1	0.1	<b>HBTLCL</b>	
<b>Cable Guide</b> Maintains cable bend radius and acts as a divider for straight sections and fittings		1	1.0	<b>HBTCG</b>	
<b>Electrical Box Bracket</b> Attaches electrical box to side of tray		1	0.75	<b>HBTEB</b>	
<b>Sidcar</b> Attaches to outside of tray, provides additional cable support 2" deep		1	0.5	<b>HBTSC</b>	

Note: \*Catalog numbers shown are for pre-galvanized accessories. Add "BK" to the end of the part number for Black Finish.

# Wire Basket Tray System Accessories for Wire Basket Tray

## Galvanized Steel Inserts\*

Provides a solid bottom for tray; 5 feet length per piece

Width In (mm)	Length In (mm)	Weight (Lb/each)	Catalog Number
4" (102)	59" (1500)	3.5	<b>HBTINSM04</b>
6" (152)	59" (1500)	5.0	<b>HBTINSM06</b>
8" (203)	59" (1500)	7.0	<b>HBTINSM08</b>
12" (305)	59" (1500)	11.0	<b>HBTINSM12</b>
16" (406)	59" (1500)	13.5	<b>HBTINSM16</b>
18" (457)	59" (1500)	16.5	<b>HBTINSM18</b>
20" (508)	59" (1500)	18.0	<b>HBTINSM20</b>
24" (610)	59" (1500)	20.0	<b>HBTINSM24</b>

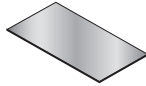

## Termination Support\*

Secures end of tray to wall and can serve as blank end fitting;  
1 piece per box

Tray Width In (mm)	Weight (Lb/each)	Catalog Number
6" (152)	0.75	<b>HBTTs6</b>
8" (203)	1.0	<b>HBTTs8</b>
12" (305)	1.2	<b>HBTTs12</b>
16" (406)	1.4	<b>HBTTs16</b>
18" (457)	1.6	<b>HBTTs18</b>
20" (508)	1.75	<b>HBTTs20</b>
24" (610)	2.0	<b>HBTTs24</b>



## Galvanized Steel Covers\*

5 feet length per piece; 1 piece per box

Width In (mm)	Length In (mm)	Weight (Lb/each)	Catalog Number
4" (102)	59" (1500)	3.0	<b>HBTCVR4</b>
6" (152)	59" (1500)	3.5	<b>HBTCVR6</b>
8" (203)	59" (1500)	4.5	<b>HBTCVR8</b>
12" (305)	59" (1500)	6.0	<b>HBTCVR12</b>
16" (406)	59" (1500)	8.0	<b>HBTCVR16</b>
18" (457)	59" (1500)	8.5	<b>HBTCVR18</b>
20" (508)	59" (1500)	9.5	<b>HBTCVR20</b>
24" (610)	59" (1500)	11.0	<b>HBTCVR24</b>



## Galvanized Steel Dividers\*

Bolt and nut to secure to support bracket (sold separately);  
5 feet length per piece; 1 piece per box

For use with tray	Length In (mm)	Weight (Lb/each)	Catalog Number
2" deep	60" (1524)	2.0	<b>HBTDIV2</b>
4" deep	60" (1524)	5.0	<b>HBTDIV4</b>
6" deep	60" (1524)	7.5	<b>HBTDIV6</b>
8" deep	60" (1524)	10.0	<b>HBTDIV8</b>



## Polymer Inserts, Black

Provides a solid bottom for tray; 10 feet length per piece; 1 piece per box

Width In (mm)	Length In (mm)	Weight (Lb/each)	Catalog Number
4" (102)	118" (3000)	0.5	<b>HBTINSNM04</b>
6" (152)	118" (3000)	0.65	<b>HBTINSNM06</b>
8" (203)	118" (3000)	0.75	<b>HBTINSNM08</b>
12" (305)	118" (3000)	1.0	<b>HBTINSNM12</b>
16" (406)	118" (3000)	1.25	<b>HBTINSNM16</b>
18" (457)	118" (3000)	1.5	<b>HBTINSNM18</b>
20" (508)	118" (3000)	1.75	<b>HBTINSNM20</b>
24" (610)	118" (3000)	2.25	<b>HBTINSNM24</b>

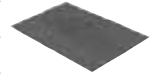

## Attachments

1 piece per box

Description	Weight (Lb)	Catalog Number
<b>Fitting Attachment, 2"</b> Fills the gap in 2" tray when creating fittings	1.0/each	<b>HBTFa2</b>
<b>Fitting Attachment, 4" to 6"</b> Fill the gap in 4" or 6" tray when creating fittings	1.0/each	<b>HBTFa46</b>
<b>Rack Attachment</b> Attaches tray directly to the top of a standard rack	1.0/each	<b>HBTRA</b>
<b>Conduit Attachment</b> Connects conduit to tray (1/2", 3/4" and 1" conduit)	1.0/each	<b>HBTCa3</b>



## Splice Hardware\*

Description	Weight (Lb)	Catalog Number
<b>Splice Kit</b> 3 piece staked bolt/washer and nut combination; Splices straight sections and field formed fittings; <b>50 pieces per box</b>	5.0/box	<b>HBTSK</b>
<b>Bar Splice</b> Slotted bar 11-15/16" long; Splices straight sections and fittings; Bend to form tray reducers; Adds rigidity to tray splices; <b>50 pieces per box</b>	14.0/box	<b>HBTSB</b>
<b>Corner Splice</b> (2) 90° splice bars and (8) sets of the splice kit; Splices fittings; Use one per each Tee Fitting; Use two per each Cross Fitting	1.0/each	<b>HBTCS</b>
<b>Washer Support</b> Splices straight sections and fittings and can also be used as a hold down method for tray to strut (Nut and bolt provided separately); <b>50 pieces per box</b>	6.0/box	<b>HBTWS</b>

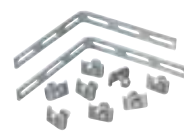

Note: \*Catalog numbers shown are for pre-galvanized accessories. Add "BK" to the end of the part number for Black Finish.

# Wire Basket Tray System

## Wire Basket Tray Technical Support

*Cutting and Forming Fittings*

### Cutting Wire Basket Tray

- Always make field cuts with the side action angle cutting tool
- Cuts can be made on any finish, width or depth basket tray
- Cut as many segments required for sweep elbows (see Splice Quantity column on product pages)
- Remove any sharp edges to eliminate possible damage to cables



### Cutting Tool

Description	Qty. per Box	Weight (Lb/each)	Catalog Number
Manual offset angled cutting tool, 24" leveraged handle	1	6.0	<b>HBTCUTTOOL</b>

### Splice Hardware\*

Description	Weight (Lb)	Catalog Number
<b>Splice Kit</b> 3 piece staked bolt/washer and nut combination; Splices straight sections and field formed fittings; <b>50 pieces per box</b>	5.0/box	<b>HBTSK</b>
<b>Bar Splice</b> Slotted bar 11-15/16" long; Splices straight sections and fittings; Bend to form tray reducers; Adds rigidity to tray splices; <b>50 pieces per box</b>	14.0/box	<b>HBTBS</b>
<b>Corner Splice</b> (2) 90° splice bars and (8) sets of the splice kit; Splices fittings; Use one per each Tee Fitting; Use two per each Cross Fitting	1.0/each	<b>HBTCS</b>
<b>Washer Support</b> Splices straight sections and fittings and can also be used as a hold down method for tray to strut (Nut and bolt provided separately); <b>50 pieces per box</b>	6.0/box	<b>HBTWS</b>
<b>Grounding Kit</b> Provides additional supplemental grounding for basket tray splices. May be specified in addition to the standard method of splicing basket tray using HBTSK splice kits. Kit includes five 9" #6 AWG copper leads and ten split bolts.	1.5/each	<b>HBTGRDKIT</b>



### How to Form a 90° Flat Sweep Elbow

- Determine which wires must be cut for the type of fitting or redirection required. This will usually be the side and bottom wires of every other mesh section.
- Cut the top side wire first.
- Cut the remaining side wires.
- Turn the tray over and cut the bottom wires.
- This creates open gaps in the side wall and bottom of the tray.
- Bend the tray to form the desired elbow radius curve by closing the gaps.
- Install splice kits and hardware where the wedge-shaped sections come together.
- Splice kits provide the mechanical connection, as well as electrical grounding continuity.



### How to Form a Tee Fitting

- Determine the location of the horizontal "tee" fitting along the length of basket tray.
- Cut the side wires from the tray which shall be the horizontal tray section, to the same width as the perpendicular tray section.
- Do not cut the bottom wires.
- Align the perpendicular tray to the opening in the side of the horizontal tray.
- Position one angle bracket from the HBTCS corner splice kit on each side of the opening.
- Secure the angle brackets to the horizontal and perpendicular tray sections with splice kits (nut, bolt, and washer) provided in the HBTCS corner splice kit.
- Support the tee fitting on all three sides of the tee using appropriate support method.



# Wire Basket Tray System

## Wire Basket Tray: Create a Bill of Material

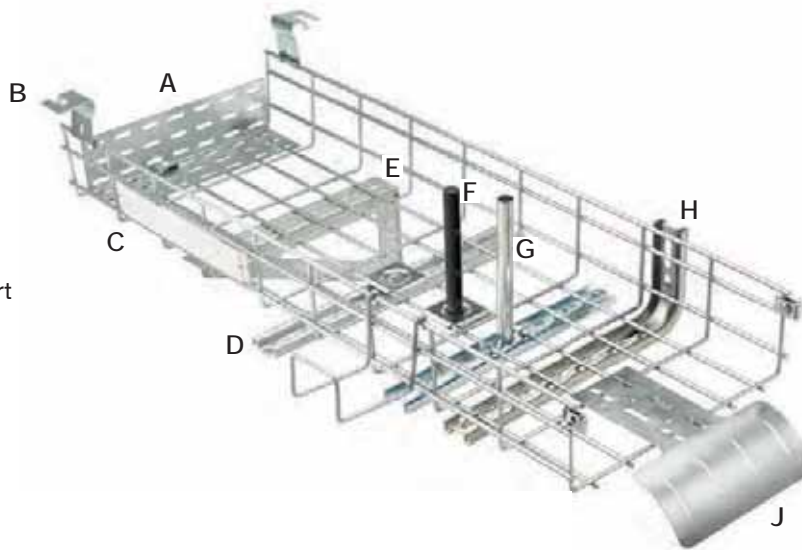

- A Termination Support
- B Trapeze Clips
- C Label Clip
- D Ceiling Support
- E Shelf Support

- F Cable Guide
- G Center Support
- H L-Bracket
- I Splice Kit
- J Vertical Down

Job Name: \_\_\_\_\_

Location: \_\_\_\_\_

Date: \_\_\_\_\_

I. Tray Size	Fill in info
Depth (inches):	_____
Width (inches):	_____
Total linear feet:	_____
Total feet/10 = pieces:	_____

II. Finish	Check One
Pre-galvanized:	<input type="checkbox"/>
Painted black:	<input type="checkbox"/>
Stainless steel:	<input type="checkbox"/>
Electro-zinc plated:	<input type="checkbox"/>
Custom color paint:	<input type="checkbox"/>

III. Fittings	Qty
90° sweep elbow:	_____
Tee fitting:	_____
Cross-X fitting:	_____
45° sweep elbow:	_____
Reducer:	_____

IV. Splices	Qty*
Splice kits:	_____
Corner splice:	_____
Washer support:	_____
Bar splice:	_____

V. Supports (6ft spacing)	Qty
Ceiling:	_____
Center:	_____
Trapeze clips (use in pairs):	_____
Wall bracket:	_____
Termination support:	_____
Field fabricated from strut:	_____

VI. Cable management	Qty
Vertical down:	_____
Radius down:	_____
Cable guide:	_____
Side car:	_____

VII. Attachment hardware	Qty
Termination support or blank end:	_____
Electrical box bracket:	_____
Fitting attachment:	_____
Rack attachment:	_____
Conduit attachment:	_____

VIII. Tray accessories	Qty
Steel divider:	_____
Steel cover:	_____
Steel bottom insert:	_____
Polymer bottom insert:	_____
Label clip:	_____

Note: \*See product selection tables for quantities of splices. These are dependent upon tray size. Additional splices required for fittings.



# Section U Hose and Cable Protection Systems

## Index

Product	Page
Features and Benefits.....	U-2
AccessTrak® System.....	U-3
TrukTrak® System.....	U-4
TredTrak® System.....	U-5
FloorTrak® System.....	U-6

### Features and Benefits



### AccessTrak® System



### TrukTrak® and TredTrak® Systems



### FloorTrak® System

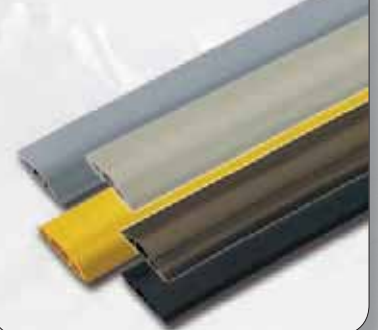



The **AccessTrak® ramping system** is a modular cable protection product that enables users to be ADAAG (American Disabilities Act Accessibility Guidelines) compliant and limits the exposure of cables and hoses to people and light vehicles passing over those cables and hoses. AccessTrak is an expandable five channel system that will protect cable and hose diameters up to 1.31 inches (33.0mm). For applications requiring more than five channels, AccessTrak can be expanded by width. In addition, AccessTrak is expandable by length to protect cables and hoses of any length. The AccessTrak ramping system provides a safe, flexible means of protecting cables and hoses in areas requiring ADA compliance.



**Hubbell TrukTrak® and TredTrak®** non-metallic cable protectors are designed to safeguard electrical cables and cords from vehicle and pedestrian traffic. The TrukTrak system comes in two, three and five channel sizes and will protect cables up to 3.25 inches (82.6mm) in diameter. It is ideal for the industrial environment where it is necessary to support heavy trucks and fork lifts. The TredTrak system is a five channel modular cable protection system that will protect cable diameters up to 1.28 inches (32.5mm). It is designed to support pedestrian and light vehicle traffic in public, institutional and commercial applications.



It can also be interconnected to protect cables and cords of any length. The Hubbell modular cable protection line also permits compliance with NEC® requirements (Article 525) for insulating electrical cables and cord at carnivals, amusement parks, convention centers and similar public areas.



**FloorTrak®** is a flexible, non-metallic cover for cables that run over the floor when portable cords and cables cannot be concealed or routed away from traffic patterns. FloorTrak protects, organizes and reduces trip hazards. Four different sizes mean it will handle cables of up to 1.25 inches (31.8mm) in diameter. FT2, FT3 and FT4 are available in five PVC colors to blend with the various decors. FT10 is available in black and yellow colors only. The F10 Heavy Duty FloorTrak is ideal for applications such as industrial work areas, food processing plants and abusive areas where cable management is necessary.

NEC® is a registered trademark of the The National Electrical Code.

# Hose and Cable Protection Systems AccessTrak® System

Ordering Information and Specifications



AccessTrak Expanded by Length



AccessTrak Expanded by Width

## AccessTrak® System

Description	Length in. (mm)	Height in. (mm)	Width in. (mm)	Channel		Weight lbs. (kg)	Catalog Number
				Width in. (mm)	Height in. (mm)		
5 Channel AccessTrak® kit*, blue and gray.	41.06" (1043.0)	4.00" (102.0)	42.90" (1090.0)	1.34" (34.0)	1.31" (33.0)	73.65 (33.41)	<b>HBLAT5KITA</b>
5 Channel AccessTrak® trough, blue and gray.	36.00" (914.0)	1.94" (49.0)	13.34" (339.0)	1.34" (34.0)	1.31" (33.0)	22.35 (10.14)	<b>HBLAT5A</b>
AccessTrak® trough end rails (set), gray.	2.50" (63.0)	4.00" (102.0)	13.28" (337.0)	—	—	6.95 (3.15)	<b>HBLAT5ERA</b>
AccessTrak® ramps (set), blue.	36.00" (914.0)	1.94" (49.0)	14.50" (368.0)	—	—	29.90 (13.56)	<b>HBLAT5RAMPA</b>
AccessTrak® ramp end rails (set), gray.	2.50" (63.5)	4.00" (102.0)	14.75" (375.0)	—	—	8.05 (3.65)	<b>HBLAT5RAMPERA</b>

Note: \*Consists of (1) HBLAT5A; (1 set) HBLAT5ERA; (1 set) HBLAT5RAMPA; (2 sets) HBLAT5RAMPERA.

### Assembled Kit

Accessibility label, blue symbol, white background

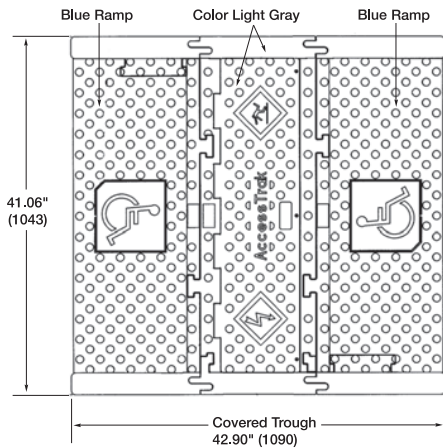

### Trough

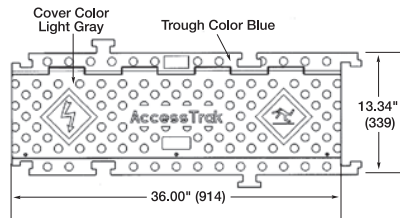

### Trough (side view)

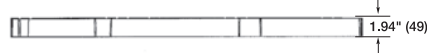

### Ramp (top view)

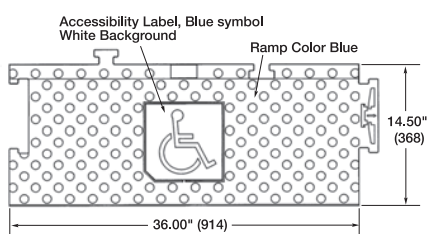

### Trough End Rails (side view)

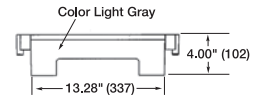

### Ramp End Rails (top view)

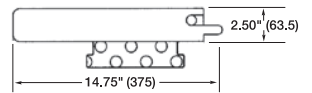

### Ramp End Rails (side view)

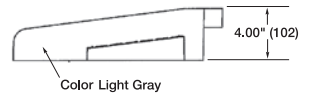

### Ramp (side view)



## Specifications

Material	Polyurethane.
Operating Temperature	-40°F to +120°F (-40°C to +49°C).
Hinge Material	Reinforced fiberglass.
Safety Symbols	Per ANSI Z535.3-1991.
ADA Symbols	Per ADAAG "Symbols of Accessibility"

## Load Capacity

Test Fixture Footprint Inches (mm)	Measured Load lbs. (N) +/- 20%	
	70°F (21°C)	120°F (49°C)
7" x 7" (178 x 178)	10,000 (44,480)	8,000 (35,584)

Dimensions in Inches (mm)

# Hose and Cable Protection Systems TrukTrak® System

Ordering Information and Specifications



TrukTrak® System	A	B	C	D	E		
				Channel			
Description	Length in. (mm)	Width in. (mm)	Height in. (mm)	Width in. (mm)	Height in. (mm)	Weight lbs. (kg)	Catalog Number
5 Channel TrukTrak®, blue and yellow.	36.0" (914)	20" (508)	2.31" (58.7)	1.25" (31.8)	1.25" (31.8)	30.60 (13.9)	<b>HBLTT5B</b>
5 Channel TrukTrak® end caps (pair only), yellow.	7.50" (190)	20" (508)	2.31" (58.7)	1.25" (31.8)	1.25" (31.8)	8.55 (3.9)	<b>HBLTT5ECB</b> (Female end)
	5.25" (133)	20" (508)	2.31" (58.7)	1.25" (31.8)	1.25" (31.8)	8.55 (3.9)	(Male end)
5 Channel 45° right turn TrukTrak®, blue and yellow.	25.0" (635)	20" (508)	2.31" (58.7)	1.25" (31.8)	1.25" (31.8)	15.35 (7.0)	<b>HBLTT545RB</b>
5 Channel 45° left turn TrukTrak®, blue and yellow.	25.0" (635)	20" (508)	2.31" (58.7)	1.25" (31.8)	1.25" (31.8)	14.45 (6.6)	<b>HBLTT545LB</b>
3 Channel TrukTrak®, blue and yellow.	36.0" (914)	20" (508)	3.05" (77.5)	2.25" (57.2)	2.25" (57.2)	30.85 (14.0)	<b>HBLTT3B</b>
3 Channel TrukTrak® end caps (pair only), yellow.	8.25" (209)	20" (508)	3.05" (77.5)	2.25" (57.2)	2.25" (57.2)	10.25 (4.6)	<b>HBLTT3ECB</b> (Female end)
	6.38" (162)	20" (508)	3.05" (77.5)	2.25" (57.2)	2.25" (57.2)	10.25 (4.6)	(Male end)
2 Channel TrukTrak®, blue and yellow.	36.0" (914)	22" (559)	4.13" (104.9)	3.25" (82.6)	3.25" (82.6)	41.00 (18.6)	<b>HBLTT2B</b>

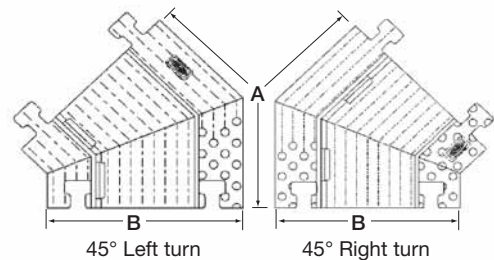
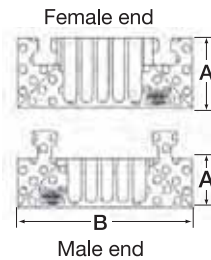
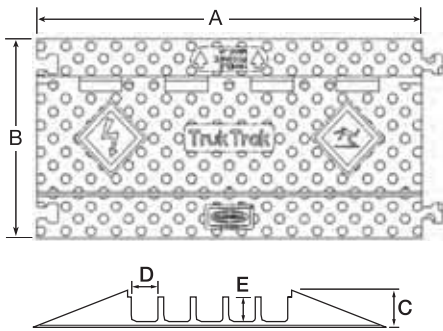

## Features

High density polyurethane construction.  
Modular interlocking design.  
Safety surface pattern.  
Safety blue and yellow colors.

## Benefits

Supports heavy loads and is weather resistant.  
Easy installation, breakdown and storage.  
Reduces slipping and skidding.  
High visibility.

## Specifications

Material	Polyurethane.
Operating Temperature	-40°F to +120°F (-40°C to +49°C).
Hinge Material	Reinforced fiberglass.
Safety Symbols	Per ANSI Z535.3.

## Load Capacity

No. of Channels	Test Fixture Footprint Inches (mm)	Measured Load lbs. (N) +/- 20%	
		70°F (21°C)	120°F (49°C)
5	6.9" x 17.3" (175 X 439)	20,150 (89,627)	9,200 (40,921)
3	6.9" x 17.3" (175 X 439)	14,210 (63,206)	4,653 (20,696)
2	6.9" x 17.3" (175 X 439)	10,880 (48,394)	2,095 (9,318)

Dimensions in Inches (mm)

# Hose and Cable Protection Systems TredTrak® System

Ordering Information and Specifications

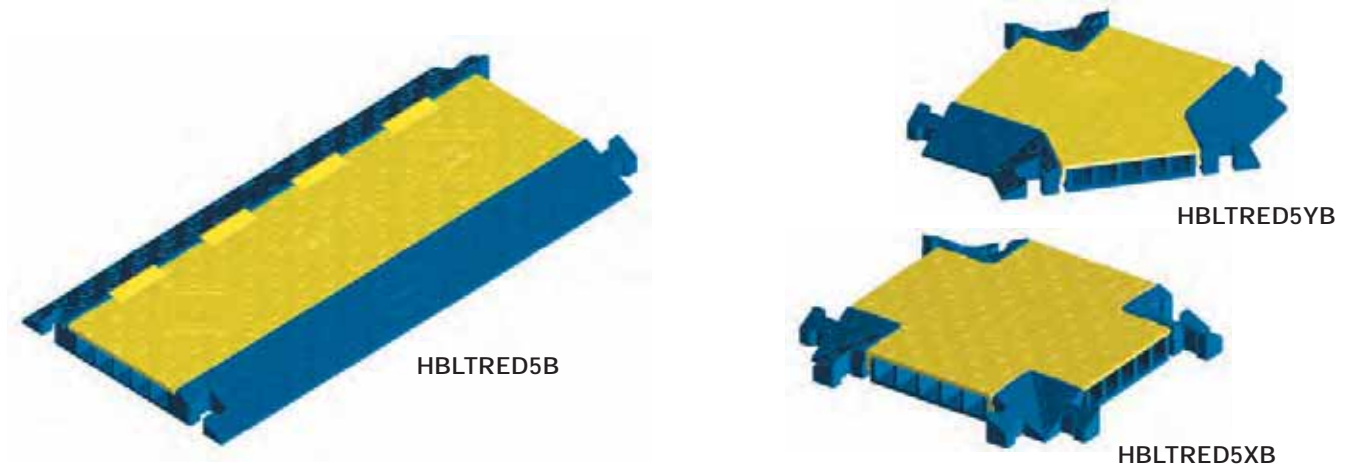

TredTrak® System	A	B	C	D	E	Weight lbs. (kg)	Catalog Number
	Length in. (mm)	Width in. (mm)	Height in. (mm)	Channel Width in. (mm)	Channel Height in. (mm)		
5 Channel TredTrak®, blue and yellow.	36.0" (914)	17.5" (445)	1.95" (50)	1.30" (33)	1.30" (33)	21.15 (9.6)	<b>HBLTRED5B</b>
5 Channel TredTrak® end caps (pair only), yellow.	5.5" (139)	17.5" (445)	1.95" (50)	1.30" (33)	1.30" (33)	6.40 (2.9)	<b>HBLTRED5ECB</b> (Female end)
	5.5" (139)	17.5" (445)	1.95" (50)	1.30" (33)	1.30" (33)	6.40 (2.9)	(Male end)
5 Channel TredTrak® female end caps (2 females), yellow.	5.5" (139)	17.5" (445)	1.95" (50)	1.30" (33)	1.30" (33)	6.40 (2.9)	<b>HBLTRED5ECFB</b>
5 Channel "X" fitting, blue and yellow.	17.5" (445)	17.5" (445)	1.95" (50)	1.30" (33)	1.30" (33)	14.25 (6.5)	<b>HBLTRED5XB</b>
5 Channel "Y" fitting, blue and yellow.	17.5" (445)	17.5" (445)	1.95" (50)	1.30" (33)	1.30" (33)	13.95 (6.3)	<b>HBLTRED5YB</b>

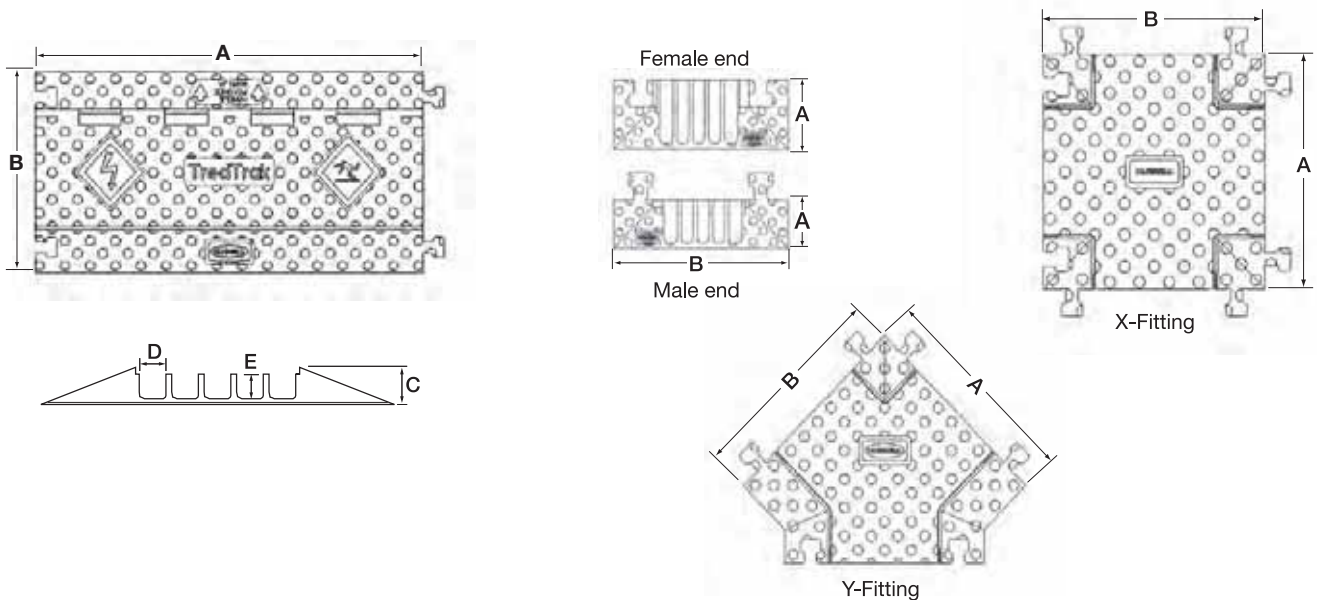

## Specifications

Material	Polyurethane.
Operating Temperature	-40°F to +120°F (-40°C to +49°C).
Hinge Material	Reinforced fiberglass.
Safety Symbols	Per ANSI Z535.3.

## Load Capacity

Product	Test Fixture Footprint Inches (mm)	Measured Load lbs. (N) +/- 20%	
		70°F (21°C)	120°F (49°C)
TredTrak	6.9" x 17.3" (175 X 439)	10,500 (46,700)	6,500 (28,900)
"X" Fitting	6.9" x 17.3" (175 X 439)	2,900 (12,900)	2,300 (10,230)
"Y" Fitting	6.9" x 17.3" (175 X 439)	2,900 (12,900)	2,300 (10,230)

Dimensions in Inches (mm)

# Hose and Cable Protection Systems

## FloorTrak® Floor Cable Cover

FT2BK10

FT3BK5

FT4BK5

FT10BK5

### FloorTrak® 2

Color	Length Feet (meters)	Catalog Number
Black	10.0' (3.05)	<b>FT2BK10</b>
Brown	10.0' (3.05)	<b>FT2BR10</b>
Beige	10.0' (3.05)	<b>FT2BG10</b>
Gray	10.0' (3.05)	<b>FT2GY10</b>
Yellow	10.0' (3.05)	<b>FT2Y10</b>

### FloorTrak® 4

Color	Length Feet (meters)	Catalog Number
Black	5.0' (1.52)	<b>FT4BK5</b>
Black	25.0' (7.62)	<b>FT4BK25</b>
Gray	25.0' (7.62)	<b>FT4GY25</b>
Yellow	5.0' (1.52)	<b>FT4Y5</b>
Yellow	25.0' (7.62)	<b>FT4Y25</b>

### FloorTrak® 3

Color	Length Feet (meters)	Catalog Number
Black	5.0' (1.52)	<b>FT3BK5</b>
Black	25.0' (7.62)	<b>FT3BK25</b>
Brown	5.0' (1.52)	<b>FT3BR5</b>
Brown	25.0' (7.62)	<b>FT3BR25</b>
Beige	5.0' (1.52)	<b>FT3BG5</b>
Beige	25.0' (7.62)	<b>FT3BG25</b>
Gray	5.0' (1.52)	<b>FT3GY5</b>
Gray	25.0' (7.62)	<b>FT3GY25</b>
Yellow	5.0' (1.52)	<b>FT3Y5</b>
Yellow	25.0' (7.62)	<b>FT3Y25</b>

### FloorTrak® 10 (Heavy Duty)

Color	Length Feet (meters)	Catalog Number
Black	3.0' (.914)	<b>FT10BK3</b>
Black	5.0' (1.52)	<b>FT10BK5</b>
Yellow	3.0' (.914)	<b>FT10Y3</b>
Yellow	5.0' (1.52)	<b>FT10Y5</b>

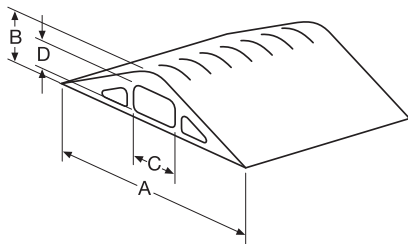

### Dimensions

FloorTrak®	FT2 inches (mm)	FT3 inches (mm)	FT4 inches (mm)	FT10 (Heavy Duty) inches (mm)
Width (A)	2.75" (69.9)	3.00" (76.2)	3.25" (82.6)	5.6" (142.24)
Height (B)	.53" (13.5)	.75" (19.1)	1.10" (27.9)	1.7" (43.18)
Center Hole (CxH)	.60" x .31" (15.2) x (7.9)	.75" x .50" (19.1) x (12.7)	1.21" x .75" (30.7) x (19.1)	1.81" x 1.25" (45.98 x 31.75)

### Accessories



Description	Catalog Number
1" Wide, 75' Roll Double-Sided Adhesive Tape.	<b>FTT1</b>
2" Wide, 75' Roll Double-Sided Adhesive Tape.	<b>FTT2</b>

### Specifications

Material	Rigid PVC.
Operating Temperature	0°F to +120°F (-18°C to +49°C).

Dimensions in Inches (mm)

# Section V Kellems® Wire Management Products

## Index

Product	Page
Kellems® Wire Mesh Grips Diagram . . . . .	V-2
Quick Reference Selection Guide for Grip Applications . . . . .	V-4
<b>Pulling Grips</b> . . . . .	V-5
Overhead DUA-PULL® Pulling Grips . . . . .	V-6
Overhead Multiple Strength Pulling Grips . . . . .	V-7
Underground K-Type Pulling Grips . . . . .	V-8
Underground T-Type Pulling Grips . . . . .	V-9
Special Purpose Pulling Grips . . . . .	V-10
Low Tension Pulling Grips . . . . .	V-12
Wire Rope Splicing Grips . . . . .	V-13
Cable Splicing Grips . . . . .	V-14
Tools, Bands, and Swivels . . . . .	V-15
Technical Information . . . . .	V-17
<b>Support Grips</b> . . . . .	V-27
Standard Duty Support Grips . . . . .	V-30
Heavy Support Grips . . . . .	V-34
Service Drop Grips . . . . .	V-36
Bus Drop Support Grips . . . . .	V-38
Conduit Riser Grips . . . . .	V-39
Technical Information . . . . .	V-41
<b>Fiber Optic Cable Grips</b> . . . . .	V-46
Pulling Grips . . . . .	V-47
Support Grips . . . . .	V-50
Technical Information . . . . .	V-51
<b>Hose Containment Grips</b> . . . . .	V-55
<b>Strain Relief System Selection Chart</b> . . . . .	V-56
Strain Relief Grips for Flexible Cords . . . . .	V-57
Deluxe Cord Grips . . . . .	V-58
PG and Metric Threaded Deluxe Cord Grips . . . . .	V-62
Dust-Tight Strain Relief Grips . . . . .	V-63
I-Grips . . . . .	V-64
Thread Adapters for Multi-Pin Connectors . . . . .	V-65
Strain Relief Grips for Liquidtight Conduit . . . . .	V-66
Technical Information . . . . .	V-69
<b>Cord Connectors</b> . . . . .	V-77
Straight Male Cord Connectors . . . . .	V-78
45° and 90° Male Cord Connectors . . . . .	V-81
Straight Female and Underground Feeder . . . . .	V-82
Low Profile NPT, PG and Metric Thread Connectors . . . . .	V-83
Accessories . . . . .	V-84
Hubbell Juniors® Miniature Nylon Cord Connectors . . . . .	V-85
Technical Information . . . . .	V-87
<b>PolyTuff® Non-Metallic Liquidtight Conduit and Tubing</b> . . . . .	V-98
PolyTuff® Non-Metallic Liquidtight Fittings . . . . .	V-100
Metallic Liquidtight Conduit Fittings . . . . .	V-101
Technical Information . . . . .	V-102



Pulling Grips



Support Grips



Strain Relief Grips



Liquidtight Conduit,  
Tubing and Fittings

# Wire Management Products Kellems® Wire Mesh Grips Diagram

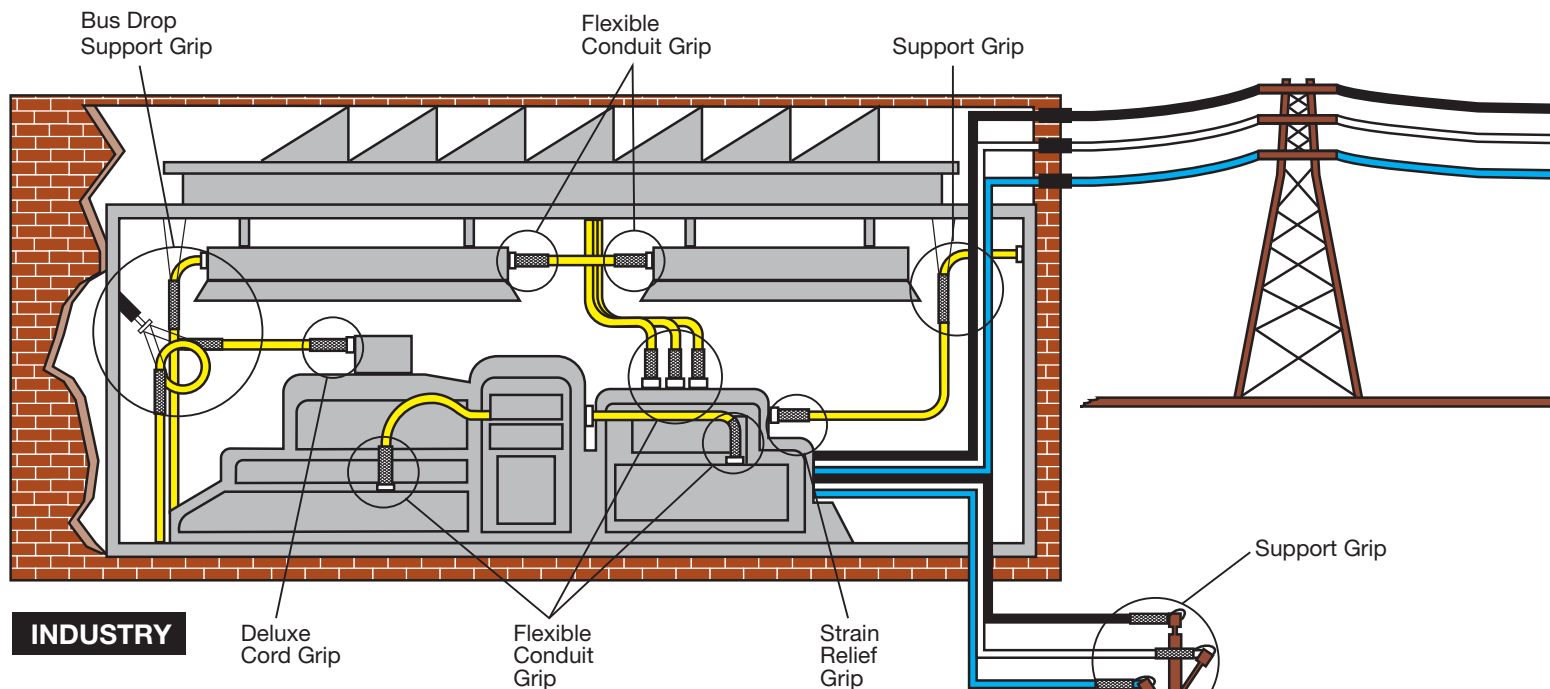

To help you fully visualize the variety of uses available to you through Hubbell-Kellems Mesh Grips, we have prepared this diagram of common applications. It follows the typical pattern of usage you would find traveling from utility to industrial, commercial and residential environments.

**Pulling Grips** are instrumental in the installations of transmission lines, service lines and cabling for construction and maintenance.

**Support Grips** provide holding management for indoor and outdoor permanent cable installations.

**Strain Relief Grips** are most often used to provide maximum reliability and minimum maintenance in areas where cords on machinery or equipment is impacted by motion or vibration or at risk of damage from cable pullout.

Beyond the electrical applications illustrated here, Hubbell-Kellems Mesh Grips can be used for wire management on radio and microwave communications towers, crane and hoist wire rope maintenance, elevator cable management and more.

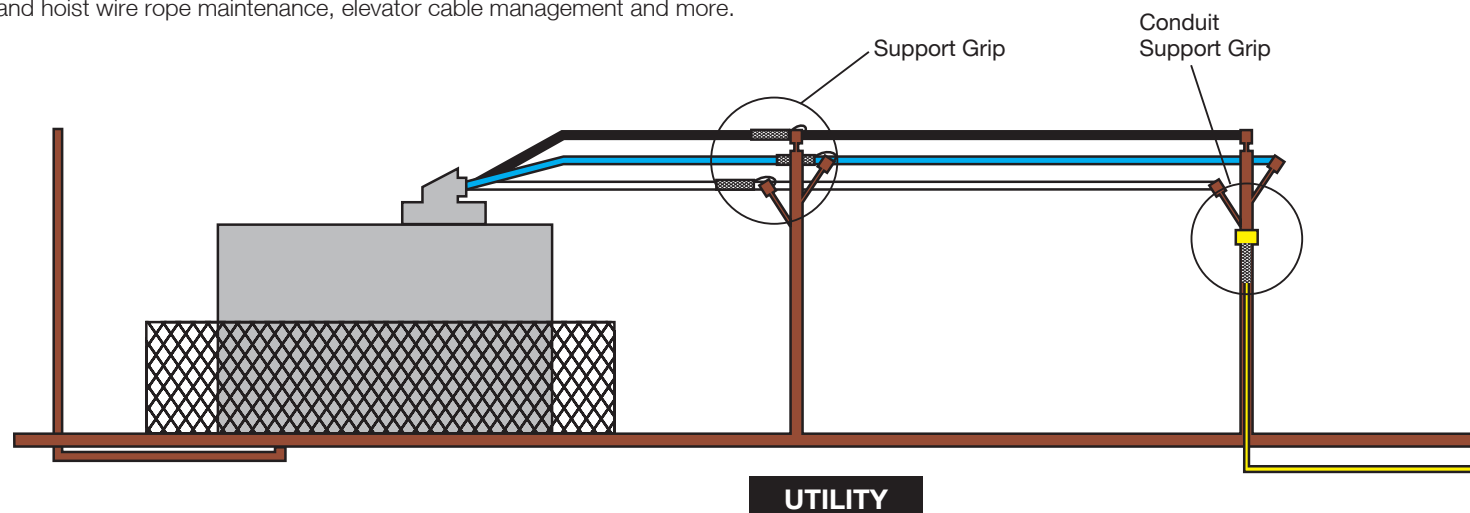



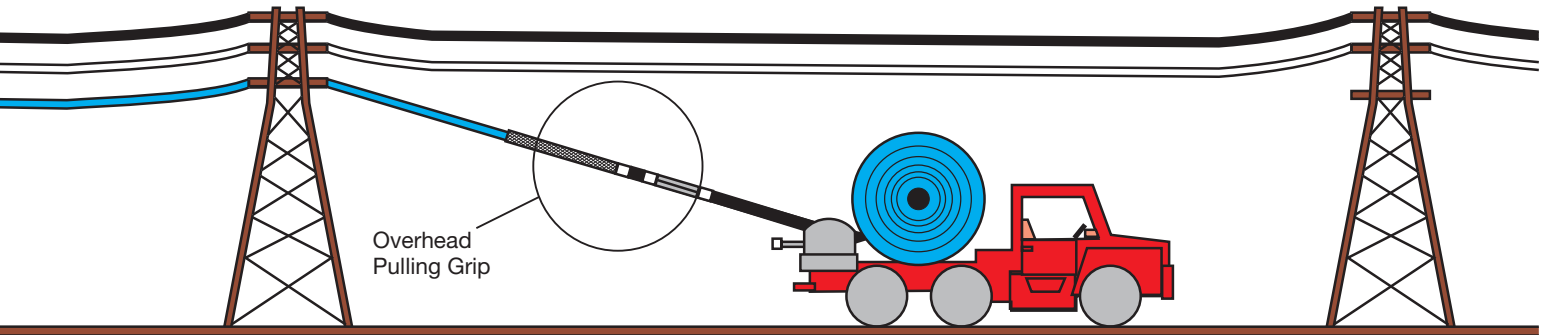

**UTILITY**

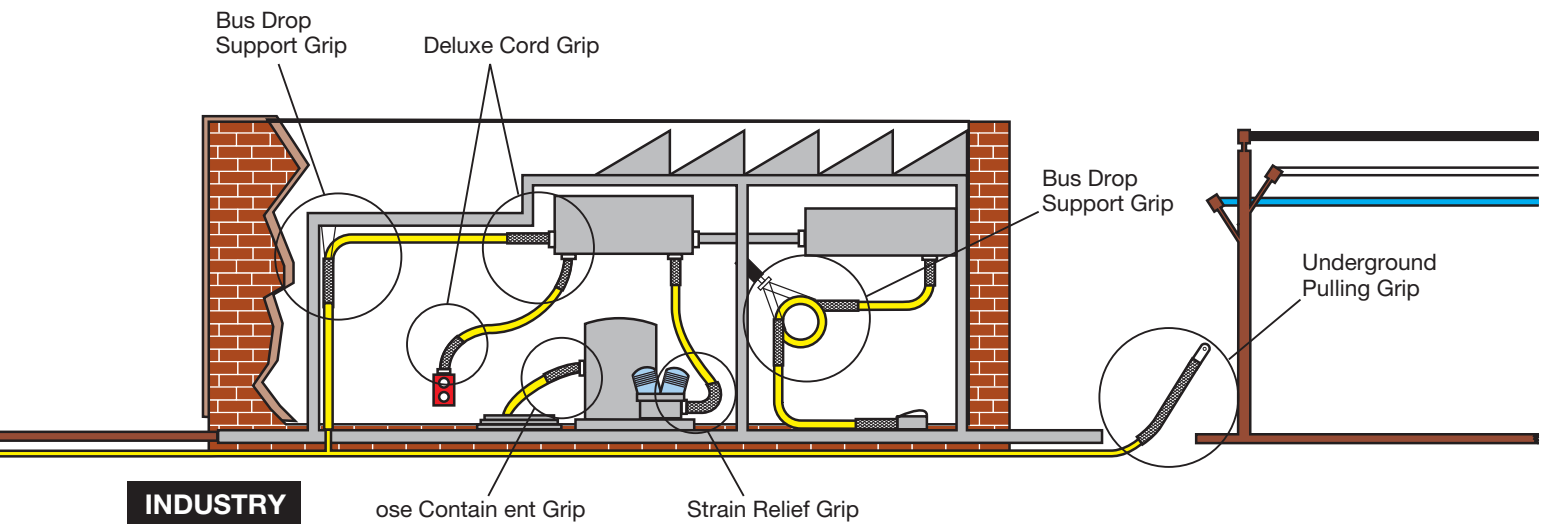

**INDUSTRY**

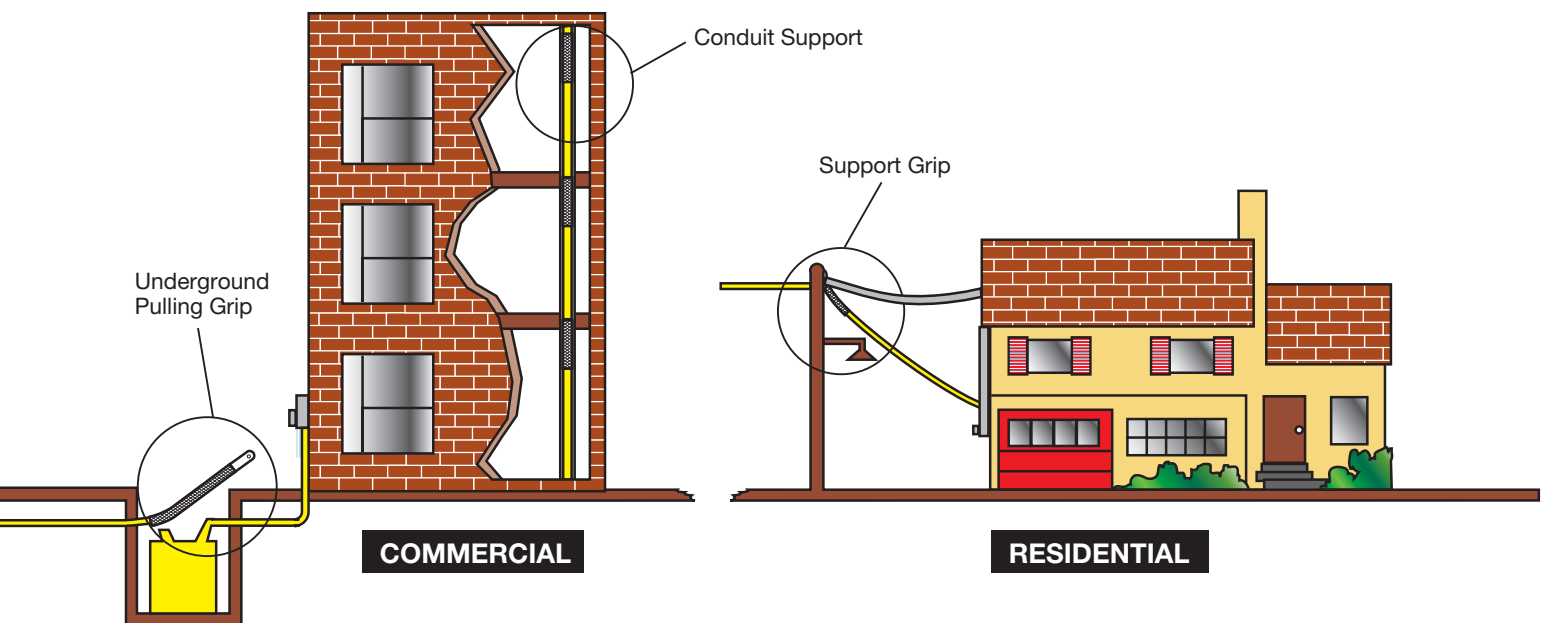

# Kellems® Wire Management Products

## Quick Reference Selection Guide for Grip Applications

### Pulling Grips

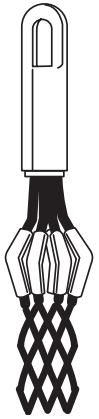

#### Heavy-Duty Rotating Eye

For underground wiring and overhead heavy-duty pulling of service lines and new construction cable. See pages V-7 and V-8.

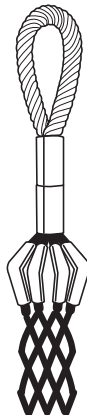

#### Heavy-Duty Flexible Eye

For overhead transmission and distribution line stringing. See pages V-6, V-7, and V-9.

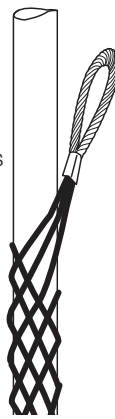

#### Slack Grips

For removing underground cable and pulling slack in existing cable and new installations and when end of cable is not available. See pages V-10 and V-11.



#### Light-Duty Flexible Eye

For light industrial pulling of electrical cable and for underground and industrial plant wiring and re-wiring. See page V-12.

### Support Grips



#### Single Eye

For single hook attachment of permanent indoor/outdoor cable. Available on heavy-duty, standard duty, and service drop grips. See pages V-28, V-32, and V-34.

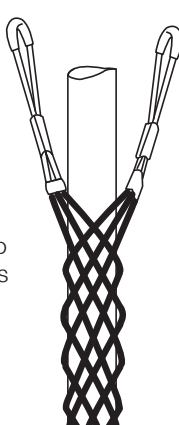

#### Double Eye

For double hook attachment of permanent indoor/outdoor cable. Available on heavy-duty and standard duty grips. See pages V-29 and V-33.



#### Single Offset Eye

For offset hook attachment of permanent indoor/outdoor cable. Available on standard duty and light-duty support grips. See page V-30.

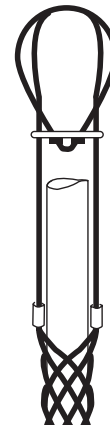

#### Universal Eye

Used to fasten around a structure or closed loop. Available on standard duty support and light or heavy duty service drop grips. See pages V-31 and V-35.

### Support Grips

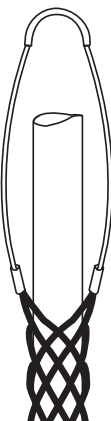

#### Wide Range Bus Drop

Used indoors for cable support where flexible cable connects electrical equipment to bus duct. Support air hose and water hose. See page V-36.

### Strain Relief Grips



#### Dust-Tight Strain Relief

Indoor use only for wiring of electrical enclosures, machine tools, portable power tools, bus drop cable systems. See page V-63.

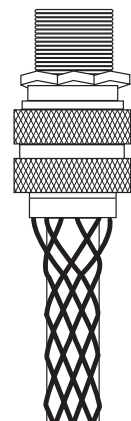

#### Deluxe Cord

Indoor or outdoor use where subject to moisture, splash, or washdown. Examples are enclosures, crane hoist and pendant drop stations, hand tools, pumps, and processing equipment. Available in straight, 90°, or 45° configurations. See pages V-58 to V-61.



#### Liquid-Tight, Flexible Metal Conduit

Wiring of machine tools, electrical enclosures, motors, and systems subjected to vibration, flexure, motion, or strain. Available in straight, 90°, or 45° configurations. See pages V-66 to V-68.

### Other Specialty Grips

#### Splicing Grips

Used as temporary splice for cable and wire rope, or as reinforcement to protect cables and hoses. See pages V-13 and V-14.

#### Conduit Riser Grips

Ideal for supporting electrical wires inside rigid conduit via a supporting ring. See pages V-38 to V-40.

#### Hose Containment Grips

Used on flexible hose lines to prevent violent whipping of hose in the event of failure at the fitting. See page V-55.

*Specifications are subject to change without notice.*

# Kellems® Wire Management Products Pulling Grips

*Overhead, Underground, Commercial Construction, Specialty*

Flexible or rotating eyes will mate easily with line stringing swivels for attachment to pulling lines; they have great strength for trouble free pulling jobs

Shoulder protectors contain the cable inside the grip and smooth the passage of the grip over line stringing blocks or conduit bends; they protect the leading edge of the grip from abrasion

The galvanized steel mesh grip provides strength for secure pulling jobs and a slim profile with little build-up; it has flexibility to follow cable path

The multiweave styles available add strength for big pulling jobs and provide positive gripping power

Endless weave allows easy installation onto cable. It has a snag-free low profile; designed to be a reusable tool



### DUA-PULL® Grips, Flexible Eye, Double Weave Mesh

DUA-PULL Pulling Grips are the highest strength pulling grips manufactured for overhead transmission line stringing applications. They have a dual function, not provided by any other grip, of working with both bare and insulated conductors and synthetic rope.

**IMPORTANT**  
 Read all breaking strength, safety and technical data relating to this product. Pages V-17 to V-26.

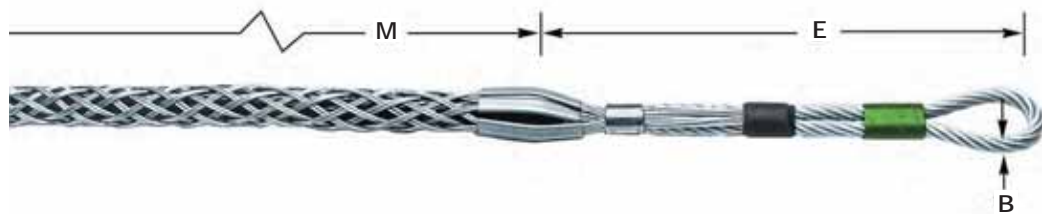

### DUA-PULL® Grips

Diameter Range		Approx. Breaking Strength Lbs. (N)	E Inches (cm)	M Inches (cm)	Eye B Diameter Inches (cm)	Over Cable and Grip** Inches (cm)	Color Code	Catalog Number
Conductor Inches (cm)	Rope* Inches (cm)							
.19"-.37" (.48-.94)	.25"-.65" (.63-1.65)	6,500 (28,912)	10" (25.40)	24" (60.96)	.220" (.56)	.200" (.51)	Black	<b>033271037</b>
.38"-.62" (.97-1.57)	.50"-.90" (1.27-2.29)	14,000 (62,272)	12" (30.48)	36" (91.44)	.375" (.95)	.280" (.71)	Dk Green	<b>033271038</b>
.63"-.87" (1.60-2.21)	.75"-.1.10" (1.90-2.79)	20,000 (88,960)	13" (33.02)	48" (121.92)	.437" (1.11)	.360" (.91)	Red	<b>033271039</b>
.88"-.1.12" (2.24-2.84)	1.00"-.1.50" (2.54-3.81)	30,600 (136,109)	15" (38.10)	60" (152.40)	.500" (1.27)	.500" (1.27)	Dk Blue	<b>033271040</b>
1.13"-.1.37" (2.87-3.48)	1.25"-.1.70" (3.17-4.32)	46,800 (208,166)	18" (45.72)	76" (193.04)	.625" (1.59)	.625" (1.59)	Yellow	<b>033271041</b>
1.38"-.1.90" (3.51-4.88)	1.50"-.2.10" (3.81-5.33)	66,500 (295,792)	24" (60.96)	89" (226.06)	.750" (1.90)	.750" (1.90)	Aluminum	<b>033271042</b>

Note: E = Eye length. M = Mesh length at nominal diameter.  
 \*For rope, select smallest size grip which meets required work load.  
 \*\*Add to cable or rope diameter.



### DUA-PULL® Feed Tube

For Use with DUA- PULL Grip	Rope Diameter Inches (cm)	Feed Tube Length Inches (cm)	Catalog Number
033271037	.25"-.65" (.63-1.65)	28" (71.12)	<b>091061043</b>
033271038	.50"-.90" (1.27-2.29)	40" (101.60)	<b>091061044</b>
033271039	.75"-.1.10" (1.90-2.79)	52" (132.08)	<b>091061045</b>
033271040	1.00"-.1.50" (2.54-3.81)	67" (170.18)	<b>091061046</b>
033271041	1.25"-.1.70" (3.17-4.32)	83" (210.82)	<b>091061047</b>
033271042	1.50"-.2.10" (3.81-5.33)	96" (243.84)	<b>091061048</b>

### Multiple Strength Style Grips

Multiple Strength Pulling Grips are designed for pulling aluminum or copper bare conductor, ground wires, messenger strands, wire rope and insulated cables.

**IMPORTANT**  
 Read all breaking strength, safety and technical data relating to this product. Pages V-17 to V-26.



### Multiple Strength Grip-Rotating Eye

Cable Diameter Range Inches (cm)	Approx. Breaking Strength Lbs. (N)	E Inches (cm)	M Inches (cm)	Rotating Eye Dia. Inches (cm)	Color Code	Catalog Number
.25"--.49" (.63-1.24)	6,800 (20,567)	5" (12.70)	26" (66.04)	7/8" (2.22)	Dark Green	<b>03302016</b>
.50"-.74" (1.27-1.88)	10,000 (44,480)	6" (15.24)	32" (81.28)	1" (2.54)	Brown	<b>03302018</b>
.75"-.99" (1.90-2.51)	14,400 (64,051)	6" (15.24)	41" (104.14)	1" (2.54)	Light Blue	<b>03302020</b>
1.00"-1.24" (2.54-3.15)	24,600 (109,420)	8" (20.32)	52" (132.08)	1 1/8" (3.49)	Gold	<b>03302022</b>
1.25"-1.49" (3.17-3.78)	30,600 (136,109)	8" (20.32)	56" (142.24)	1 1/8" (4.13)	Black	<b>03302024</b>
1.50"-1.74" (3.81-4.42)	30,600 (136,109)	9" (22.86)	60" (152.40)	1 1/8" (4.76)	Red	<b>03302026</b>
1.75"-2.24" (4.44-5.69)	48,000 (213,504)	10" (25.40)	70" (177.80)	1 1/8" (4.76)	Dark Blue	<b>03302028</b>
2.00"-2.49" (5.08-6.32)	48,000 (213,504)	10" (25.40)	50" (127.00)	1 1/8" (4.76)	Yellow	<b>03302066</b>
2.50"-2.99" (6.35-7.59)	48,000 (213,504)	10" (25.40)	52" (132.08)	1 1/8" (4.76)	Orange	<b>03302097</b>
3.00"-3.49" (7.62-8.86)	48,000 (213,504)	10" (25.40)	50" (127.00)	1 1/8" (4.76)	Aluminum	<b>033021030</b>
3.50"-3.99" (8.89-10.13)	48,000 (213,504)	10" (25.40)	53" (134.62)	1 1/8" (4.76)	Light Green	<b>033021031</b>

Note: E- Eye length M-Mesh length at nominal diameter.

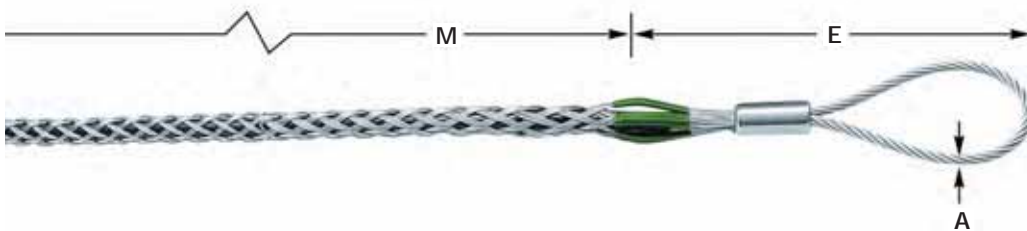

### Multiple Strength Grip-Flexible Eye

Cable Diameter Range Inches (cm)	Approx. Breaking Strength Lbs. (N)	E Inches (cm)	M Inches (cm)	Eye A Dia. Inches (cm)	Color Code	Catalog Number
.25"-.49" (.63-1.24)	6,800 (20,567)	9" (22.86)	26" (66.04)	1/4" (.63)	Dark Green	<b>03302044</b>
.50"-.74" (1.27-1.88)	10,000 (44,480)	9" (22.86)	32" (81.28)	5/16" (.79)	Brown	<b>03302046</b>
.75"-.99" (1.90-2.51)	14,400 (64,051)	11" (27.94)	41" (104.14)	3/8" (.95)	Light Blue	<b>03302048</b>
1.00"-1.24" (2.54-3.15)	24,600 (109,420)	12" (30.48)	52" (132.08)	1/2" (1.27)	Gold	<b>03302050</b>
1.25"-1.49" (3.17-3.78)	30,600 (136,109)	12" (30.48)	56" (142.24)	1/2" (1.27)	Black	<b>03302052</b>
1.50"-1.74" (3.81-4.42)	30,600 (136,109)	12" (30.48)	60" (152.40)	1/2" (1.27)	Red	<b>03302054</b>
1.75"-2.24" (4.44-5.69)	48,000 (213,504)	18" (45.72)	70" (177.80)	5/8" (1.59)	Dark Blue	<b>03302056</b>
2.00"-2.49" (5.08-6.32)	48,000 (213,504)	18" (45.72)	50" (127.00)	5/8" (1.59)	Yellow	<b>033021078</b>
2.50"-2.99" (6.35-7.59)	48,000 (213,504)	18" (45.72)	52" (132.08)	5/8" (1.59)	Orange	<b>033021079</b>
3.00"-3.49" (7.62-8.86)	48,000 (213,504)	18" (45.72)	50" (127.00)	5/8" (1.59)	Aluminum	<b>033021080</b>
3.50"-3.99" (8.89-10.13)	48,000 (213,504)	18" (45.72)	53" (134.62)	5/8" (1.59)	Light Green	<b>033021081</b>

Note: E- Eye length. M-Mesh length at nominal diameter.

## K-Type Grips

Kellems® Rotating Eye, K-Type Pulling Grips are made of high strength galvanized steel strand. All Grips feature double weave mesh for greater strength and added mesh contact on the table, to handle longer or heavier pulling jobs. The forged eye mates easily with a swivel or shackle.

### IMPORTANT

Read all breaking strength, safety and technical data relating to this product. Pages V-17 to V-26.



## K-Type Grips

Cable Diameter Range Inches (cm)	Approx. Breaking Strength Lbs. (N)	E Inches (cm)	M Inches (cm)	Rotating Eye Dia. Inches (cm)	Catalog Number
<b>Short</b>					
.50"-.62" (1.27-1.57)	5,600 (24,909)	5" (12.70)	11" (27.94)	7/8" (2.22)	03301001
.63"-.74" (1.60-1.88)	6,800 (30,246)	5" (12.70)	11" (27.94)	7/8" (2.22)	03301002
.75"-.99" (1.90-2.51)	6,800 (30,246)	6" (15.24)	20" (50.80)	1" (2.54)	03301013
1.00"-1.24" (2.54-3.15)	12,800 (56,934)	7" (17.78)	20" (50.80)	1 1/8" (3.49)	03301014
1.25"-1.49" (3.17-3.78)	12,800 (56,934)	7" (17.78)	21" (53.34)	1 1/8" (3.49)	03301016
1.50"-1.99" (3.81-5.05)	16,400 (72,941)	7" (17.78)	25" (63.50)	1 1/8" (3.49)	03301017
2.00"-2.49" (5.08-6.32)	27,200 (120,986)	8" (20.32)	26" (66.04)	1 5/8" (4.13)	03301018
2.50"-2.99" (6.35-7.59)	33,000 (146,784)	10" (25.40)	28" (71.12)	1 7/8" (4.76)	03301019
3.00"-3.49" (7.62-8.86)	41,000 (182,368)	10" (25.40)	30" (76.20)	1 7/8" (4.76)	03301020
3.50"-3.99" (8.89-10.13)	48,000 (213,504)	10" (25.40)	32" (81.28)	1 7/8" (4.76)	03301021
4.00"-4.49" (10.16-11.40)	48,000 (213,504)	10" (25.40)	33" (83.82)	1 7/8" (4.76)	03301017
<b>Standard</b>					
.50"-.62" (1.27-1.57)	5,600 (24,909)	5" (12.70)	16" (40.64)	7/8" (2.22)	03301011
.63"-.74" (1.60-1.88)	6,800 (30,246)	5" (12.70)	16" (40.64)	7/8" (2.22)	03301012
.75"-.99" (1.90-2.51)	9,600 (42,701)	6" (15.24)	32" (81.28)	1" (2.54)	03301024
1.00"-1.49" (2.54-3.78)	16,400 (72,947)	7" (17.78)	33" (83.82)	1 1/8" (3.49)	03301025
1.50"-1.99" (3.81-5.05)	16,400 (72,947)	7" (17.78)	34" (86.36)	1 1/8" (3.49)	03301026
2.00"-2.49" (5.08-6.32)	27,200 (120,986)	9" (22.86)	36" (91.44)	1 5/8" (4.13)	03301027
2.50"-2.99" (6.35-7.59)	33,000 (146,784)	10" (25.40)	38" (96.52)	1 7/8" (4.76)	03301028
3.00"-3.49" (7.62-8.86)	41,000 (182,368)	10" (25.40)	39" (99.06)	1 7/8" (4.76)	03301029
3.50"-3.99" (8.89-10.13)	48,000 (213,504)	10" (25.40)	41" (104.14)	1 7/8" (4.76)	03301030
4.00"-4.49" (10.16-11.40)	48,000 (213,504)	10" (25.40)	42" (106.68)	1 7/8" (4.76)	03301031
4.50"-4.99" (11.43-12.67)	48,000 (213,504)	10" (25.40)	58" (147.32)	1 7/8" (4.76)	03301039
5.00"-5.99" (12.70-15.21)	40,000 (177,920)	10" (25.40)	60" (152.40)	1 7/8" (4.76)	03301047
6.00"-6.99" (15.24-17.75)	48,000 (213,504)	10" (25.40)	66" (167.64)	1 7/8" (4.76)	03301045

Note: E- Eye length. M-Mesh length at nominal diameter.  
 See page V-25 for multiple cables in a single pulling grip.

### T-Type Grips

Kellems® Flexible T-Type Pulling Grips are made of high strength galvanized steel strand. They feature double weave mesh for positive holding power in medium to heavy pulling jobs. The grip eye will easily attach to a swivel.

### IMPORTANT

Read all breaking strength, safety and technical data relating to this product. Pages V-17 to V-26.



### T-Type Grips

Cable Diameter Range Inches (cm)	Approx. Breaking Strength Lbs. (N)	E Inches (cm)	M Inches (cm)	Catalog Number
<b>Short</b>				
.50"-.62" (1.27-1.57)	4,500 (20,016)	8" (20.32)	21" (53.34)	033041082
.63"-.74" (1.60-1.88)	5,600 (24,909)	8" (20.32)	24" (60.96)	033041083
.75"-.99" (1.90-2.51)	6,800 (30,246)	9" (22.86)	24" (60.96)	033041084
1.00"-1.49" (2.54-3.78)	9,600 (42,701)	9" (22.86)	24" (60.96)	033041085
1.50"-1.99" (3.81-5.05)	16,400 (72,947)	11" (27.94)	24" (60.96)	033041086
2.00"-2.49" (5.08-6.32)	18,500 (82,288)	12" (30.48)	24" (60.96)	033041087
2.50"-2.99" (6.35-7.59)	24,500 (108,976)	12" (30.48)	24" (60.96)	033041088
3.00"-3.49" (7.62-8.86)	24,500 (108,976)	14" (35.56)	24" (60.96)	033041089
3.50"-3.99" (8.89-10.13)	31,000 (137,888)	14" (35.56)	26" (66.04)	033041090
<b>Standard</b>				
.75"-.99" (1.90-2.51)	6,800 (30,246)	9" (22.86)	36" (91.44)	033041091
1.00"-1.49" (2.54-3.78)	9,600 (42,701)	9" (22.86)	36" (91.44)	033041092
1.50"-1.99" (3.81-5.05)	16,400 (72,947)	11" (27.94)	36" (91.44)	033041093
2.00"-2.49" (5.08-6.32)	18,500 (82,288)	12" (30.48)	36" (91.44)	033041094
2.50"-2.99" (6.35-7.59)	24,500 (108,976)	12" (30.48)	36" (91.44)	033041095
3.00"-3.49" (7.62-8.86)	24,500 (108,976)	14" (35.56)	36" (91.44)	033041096
3.50"-3.99" (8.89-10.13)	31,000 (137,888)	14" (35.56)	40" (101.60)	033041097

Note: E- Eye length. M-Mesh length at nominal diameter.  
 See page V-25 for multiple cables in a single pulling grip.

### Non-Conductive Grips

Kellems® Non-Conductive Pulling Grips, made of a high strength, non-conductive aramid fiber, are available for pulling single cable or cable bundles. Their braided double weave design adds strength and positive holding power.

**IMPORTANT**  
 Read all breaking strength, safety and technical data relating to this product. Pages V-17 to V-26.

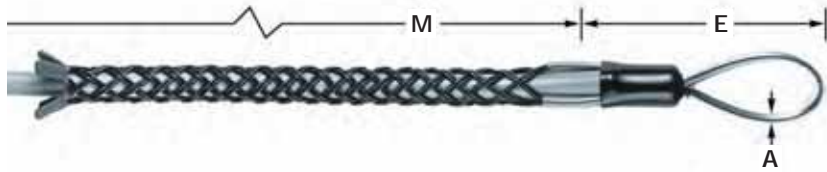

### Non-Conductive Grips, Single Eye, Double Weave, Non-Metallic

Cable Diameter Range Inches (cm)	Approx. Breaking Strength Lbs. (N)	E Inches (cm)	M Inches (cm)	A Inches (cm)	Color Code	Catalog Number
.50"-.62" (1.27-1.57)	4,000 (17,792)	5.5" (13.97)	24" (60.96)	.44" (1.12)	Green	<b>03628001</b>
.63"-.74" (1.60-1.88)	5,000 (22,240)	5.5" (13.97)	26" (66.04)	.44" (1.12)	Yellow	<b>03628002</b>
.75"-.99" (1.90-2.51)	6,000 (26,688)	6.0" (15.24)	31" (78.74)	.63" (1.60)	Red	<b>03628003</b>
1.00"-1.24" (2.54-3.15)	6,000 (26,688)	6.5" (16.51)	36" (91.44)	.63" (1.60)	Blue	<b>03628004</b>
1.25"-1.49" (3.17-3.78)	6,000 (26,688)	6.7" (17.02)	41.5" (105.41)	.63" (1.60)	White	<b>03628005</b>
1.50"-1.99" (3.815-05)	6,000 (26,688)	8.0" (20.32)	44.0" (121.76)	.63" (1.60)	Pink	<b>03628006</b>

### Slack Pulling Grips

Slack Pulling Grips are offered in three styles made of galvanized steel. The closed type is used when the cable end is accessible. When not accessible, there are split lace and split rod closing styles. All grips feature a single offset eye for easy attachment to a pulling line.

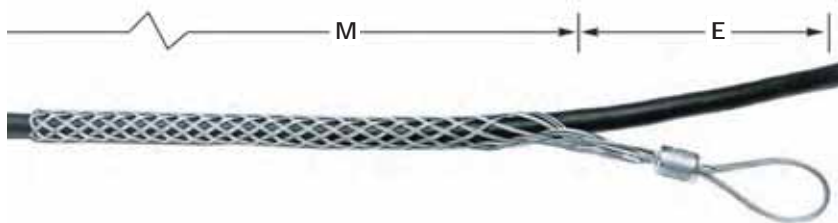

### Slack Grip-Closed Mesh, Offset Eye, Double Weave, Galvanized Steel

Cable Diameter Range Inches (cm)	Approx. Breaking Strength Lbs. (N)	E Inches (cm)	M Inches (cm)	Catalog Number
<b>Standard</b>				
.75"-.99" (1.90-2.51)	2,600 (11,565)	7" (17.78)	12" (30.48)	<b>03308003</b>
1.00"-1.24" (2.54-3.15)	4,000 (17,792)	8" (20.32)	15" (38.10)	<b>03308004</b>
1.25"-1.49" (3.17-3.78)	5,400 (24,019)	8" (20.32)	16" (40.64)	<b>03308005</b>
1.50"-1.74" (3.81-4.42)	6,600 (29,357)	8" (20.32)	20" (50.80)	<b>03308006</b>
1.75"-1.99" (4.44-5.05)	10,000 (44,480)	10" (25.40)	18" (45.72)	<b>03308007</b>
2.00"-2.49" (5.08-6.32)	11,000 (48,928)	10" (25.40)	19" (48.26)	<b>03308008</b>
2.50"-2.99" (6.35-7.59)	11,000 (48,928)	10" (25.40)	20" (50.80)	<b>03308009</b>
3.00"-3.49" (7.62-8.86)	14,500 (64,496)	12" (30.48)	21" (53.34)	<b>03308010</b>
3.50"-3.99" (8.89-10.13)	14,500 (64,496)	12" (30.48)	22" (55.88)	<b>03308011</b>

*Note: E- Eye length. M-Mesh length at nominal diameter.  
 See page V-25 for multiple cables in a single pulling grip.*



### Slack Pulling Grips

Slack Pulling Grips are offered in three styles made of galvanized steel. The closed type is used when the cable end is accessible. When not accessible, there are split lace and split rod closing styles. All grips feature a single offset eye for easy attachment to a pulling line.

**IMPORTANT**  
 Read all breaking strength, safety and technical data relating to this product. Pages V-17 to V-26.

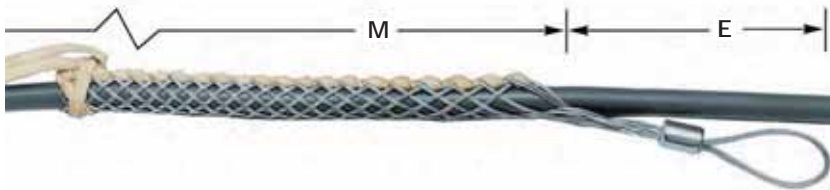

#### Slack Grip-Split Mesh, Rawhide Lace Closing, Offset Eye, Double Weave, Galvanized Steel

Cable Diameter Range Inches (cm)	Approx. Breaking Strength Lbs. (N)	E Inches (cm)	M Inches (cm)	Catalog Number
<b>Standard</b>				
.75"-1.99" (1.90-2.51)	2,500 (11,120)	7" (17.78)	12" (30.48)	03309003
1.00"-1.24" (2.54-3.15)	3,500 (15,568)	8" (20.32)	15" (38.10)	03309004
1.25"-1.49" (3.17-3.78)	4,000 (17,792)	8" (20.32)	16" (40.64)	03309005
1.50"-1.74" (3.81-4.42)	4,000 (17,792)	9" (22.86)	17" (43.18)	03309006
1.75"-1.99" (4.44-5.05)	4,000 (17,792)	10" (25.40)	18" (45.72)	03309007
2.00"-2.49" (5.08-6.32)	4,000 (17,792)	10" (25.40)	19" (48.26)	03309008
2.50"-2.99" (6.35-7.59)	4,000 (17,792)	10" (25.40)	20" (50.80)	03309009
<b>Long</b>				
1.50"-1.99" (3.81-5.05)	4,000 (17,792)	9" (22.86)	25" (63.50)	03309015
2.00"-2.49" (5.08-6.32)	4,000 (17,792)	10" (25.40)	26" (66.04)	03309016
2.50"-2.99" (6.35-7.59)	4,000 (17,792)	10" (25.40)	29" (73.66)	03309017
3.00"-3.49" (7.62-8.86)	4,000 (17,792)	12" (30.48)	32" (81.28)	03309018
3.50"-3.99" (8.89-10.13)	4,000 (17,792)	12" (30.48)	35" (88.90)	03309019

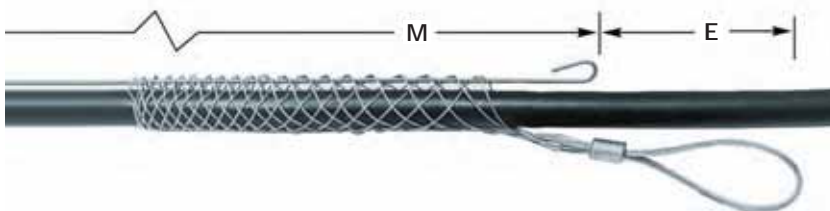

#### Slack Grip-Split Mesh, Rod Closing, Offset Eye, Single Weave, Galvanized Steel

Cable Diameter Range Inches (cm)	Approx. Breaking Strength Lbs. (N)	E Inches (cm)	M Inches (cm)	Catalog Number
.50"-1.61" (1.27-1.55)	1,500 (6,672)	7" (17.78)	6" (15.24)	03310001
.62"-1.74" (1.57-1.88)	1,800 (8,006)	7" (17.78)	8" (20.32)	03310002
.75"-1.99" (1.90-2.51)	2,200 (9,786)	7" (17.78)	10" (25.40)	03310003
1.00"-1.24" (2.54-3.15)	3,400 (15,123)	8" (20.32)	12" (30.48)	03310004
1.25"-1.49" (3.17-3.78)	4,500 (20,016)	8" (20.32)	14" (35.56)	03310005
1.50"-1.74" (3.81-4.42)	5,800 (25,798)	9" (22.86)	15" (38.10)	03310006
1.75"-1.99" (4.44-5.05)	7,600 (33,805)	10" (25.40)	16" (40.64)	03310007
2.00"-2.49" (5.08-6.32)	9,000 (40,032)	10" (25.40)	19" (48.26)	03310008
2.50"-2.99" (6.35-7.59)	11,000 (48,928)	10" (25.40)	20" (50.80)	03310009
3.00"-3.49" (7.62-8.86)	12,000 (53,376)	12" (30.48)	21" (53.34)	03310010
3.50"-3.99" (8.89-10.13)	12,000 (53,376)	12" (30.48)	24" (60.96)	03310011

Note: E- Eye length. M-Mesh length at nominal diameter.  
 See page V-25 for multiple cables in a single pulling grip.

### Light Duty Grips

Light Duty Grips are made of galvanized steel in a single weave construction. They feature a flexible eye for easy attachment to a pulling line.

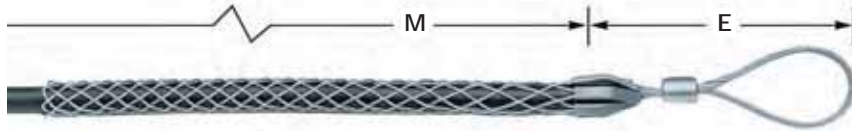

**IMPORTANT**  
 Read all breaking strength, safety and technical data relating to this product. Pages V-17 to V-26.

### Light Duty Grips

Cable Diameter Range Inches (cm)	Approx. Breaking Strength Lbs. (N)	E Inches (cm)	M Inches (cm)	Catalog Number
<b>Short</b>				
.50"-.62" (1.27-1.57)	2,800 (12,454)	5" (12.70)	11" (27.94)	03303001
.63"-.74" (1.60-1.88)	2,800 (12,454)	5" (12.70)	11" (27.94)	03303002
.75"-.99" (1.90-2.51)	4,000 (17,792)	6" (15.24)	12" (30.48)	03303003
1.00"-1.24" (2.54-3.15)	5,300 (23,574)	7" (17.78)	13" (33.02)	03303004
1.25"-1.49" (3.17-3.78)	5,300 (23,574)	7" (17.78)	14" (35.56)	03303005
1.50"-1.74" (3.81-4.42)	6,800 (30,246)	8" (20.32)	15" (38.10)	03303006
1.75"-1.99" (4.44-5.05)	8,500 (37,808)	9" (22.86)	17" (43.18)	03303007
2.00"-2.49" (5.08-6.32)	8,500 (37,808)	9" (22.86)	18" (45.72)	03303008
<b>Standard</b>				
.50"-.62" (1.27-1.57)	2,800 (12,454)	5" (12.70)	16" (40.64)	03303010
.63"-.74" (1.60-1.88)	2,800 (12,454)	5" (12.70)	16" (40.64)	03303011
.75"-.99" (1.90-2.51)	4,000 (17,792)	6" (15.24)	20" (50.80)	03303012
1.00"-1.24" (2.54-3.15)	6,800 (30,246)	7" (17.78)	20" (50.80)	03303013
1.25"-1.49" (3.17-3.78)	6,800 (30,246)	7" (17.78)	21" (53.34)	03303015
1.50"-1.99" (3.81-5.05)	6,800 (30,246)	8" (20.32)	23" (58.42)	03303016
2.00"-2.49" (5.08-6.32)	8,500 (37,808)	9" (22.86)	25" (63.50)	03303017
2.50"-2.99" (6.35-7.59)	10,600 (47,149)	9" (22.86)	27" (68.58)	03303018
3.00"-3.49" (7.62-8.86)	14,700 (65,386)	10" (25.40)	30" (76.20)	03303019
3.50"-3.99" (8.89-10.13)	14,700 (65,386)	10" (25.40)	32" (81.28)	03303029

### Junior Pulling Grips

Junior Pulling Grips feature a strong galvanized steel, single weave mesh. A flexible eye easily attaches to a pulling line, snake or fish tape.

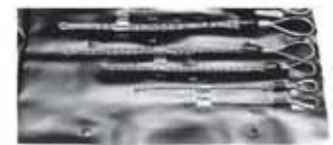
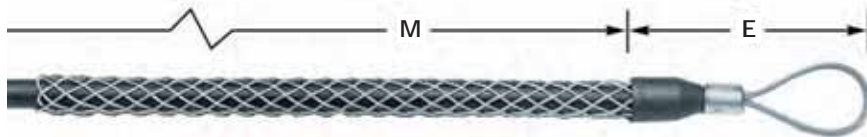

033051114

### Junior Pulling Grips

Cable Diameter Range Inches (cm)	Approx. Breaking Strength Lbs. (N)	E Inches (cm)	M Inches (cm)	Model	Catalog Number
.19"-.24" (.48-.61)	400 (1,779)	3¼" (8.25)	4¼" (10.79)	J19	03305011*
.25"-.37" (.63-.94)	450 (2,002)	3¼" (8.25)	4¼" (10.79)	J25	03305001
.38"-.49" (.97-1.24)	900 (4,003)	3¾" (9.52)	7" (17.78)	J37	03305002
.50"-.62" (1.27-1.57)	1,300 (5,782)	4¼" (10.79)	8½" (21.59)	J50	03305003
.63"-.74" (1.60-1.88)	1,950 (8,674)	5" (12.70)	10" (25.40)	J62	03305004
.75"-.99" (1.90-2.51)	2,800 (12,454)	5¾" (14.60)	10" (25.40)	J75	03305005
1.00"-1.24" (2.54-3.15)	3,900 (17,347)	6½" (16.51)	11½" (29.21)	J100	03305006
Junior Grip Kit contains 6 grips, one of each size above, except 03305011.					033051114

Note: E- Eye length. M-Mesh length at nominal diameter.  
 \*Not included in Junior Grip Kit, 033051114.  
 Note: See page V-25 for multiple cables in a single pulling grip.  
 See page V-26 for building wire selection chart.

### Kellems® Wire Rope Grips

Wire Rope Grips are made of high strength galvanized steel strand in a construction of triple, double and single weave for superior gripping ability. They are available with or without a rotating barrel which will help eliminate twist in the old rope from being transferred to the new rope.

#### IMPORTANT

Read all breaking strength, safety and technical data relating to this product. Pages V-17 to V-26.



### Regular Wire Rope Grips

Cable Diameter Range Inches (cm)	Approx. Breaking Strength Lbs. (N)	Approx. Strength of Grip Feet (m)	Catalog Number
5/16" - 5/8" (1.43-1.59)	7,500 (33,360)	5.75 (1.75)	<b>03316001</b>
3/4" - 7/8" (1.90-2.22)	12,500 (55,600)	6.75 (1.90)	<b>03316002</b>
1" - 1 1/8" (2.54-2.86)	16,000 (71,168)	7.00 (2.13)	<b>03316003</b>
1 1/4" - 1 3/8" (3.17-3.49)	20,000 (88,960)	8.00 (2.44)	<b>03316004</b>
1 3/8" - 1 1/2" (3.49-3.81)	20,000 (88,960)	8.00 (2.44)	<b>03316006</b>



### Rotating Wire Rope Grips

Cable Diameter Range Inches (cm)	Approx. Breaking Strength Lbs. (N)	Approx. Strength of Grip Feet (m)	Barrel Dimensions Length. x O.D. In. (cm)	Catalog Number
7/16" - 1/2" (1.11-1.27)	5,000 (22,240)	5.33 (1.63)	3.00" (7.62) x .87" (2.21)	<b>03317001</b>
5/16" - 5/8" (1.43-1.59)	7,500 (33,360)	5.83 (1.78)	4.25" (10.79) x 1.00" (2.54)	<b>03317002</b>
3/4" - 7/8" (1.90-2.22)	12,500 (55,600)	6.50 (1.98)	4.25" (10.79) x 1.00" (2.54)	<b>03317003</b>
1" - 1 1/8" (2.54-2.86)	16,000 (71,168)	8.67 (2.64)	5.50" (13.97) x 1.37" (3.48)	<b>03317004</b>
1 1/4" - 1 3/8" (3.17-3.49)	20,000 (88,960)	9.00 (2.74)	5.50" (13.97) x 1.37" (3.48)	<b>03317005</b>
1 1/2" - 1 3/4" (3.81-4.44)	20,000 (88,960)	11.00 (3.35)	5.50" (13.97) x 1.37" (3.48)	<b>03317006</b>

### Splicing Grips

Splicing Grips are made of galvanized steel in double weave mesh construction. They are available in various lengths and sizes to suit most applications.

#### IMPORTANT

Read all breaking strength, safety and technical data relating to this product. Pages V-17 to V-26.



### Double Weave Tube

Cable Diameter Range Inches (cm)	.37"-.49" (.94-1.24)	.50"-.61" (1.27-1.55)	.62"-.74" (1.57-1.88)	.75"-.99" (1.90-2.51)	1.00"-1.49" (2.54-3.78)
Approx. Breaking Strength Lbs. (N)	3,500 (15,568)	3,500 (15,568)	4,400 (19,571)	7,500 (33,360)	10,000 (44,480)
Mesh Length Inches (cm)	Catalog Number				
18" (45.72)	<b>013041330</b>	<b>01304064</b>	<b>01304009</b>	—	—
24" (60.96)	—	<b>01304011</b>	<b>01304013</b>	<b>01304010</b>	<b>01304015</b>
36" (91.44)	—	—	<b>013041234</b>	<b>01304054</b>	<b>01304055</b>
48" (121.92)	—	—	—	<b>01304017</b>	<b>01304029</b>
72" (182.88)	—	—	—	<b>01304037</b>	<b>013041333</b>

### Junior Splicing Grips, Single Weave

Junior Splicing Grips are made of galvanized steel and are designed for use in very light duty and small splicing jobs.



### Junior Tube

Cable Diameter Range Inches (cm)	Approx. Breaking Strength Lbs. (N)	Length @ Nom Diameter Inches (cm)	Catalog Number
.18"-.24" (.46-.61)	400 (1,779)	7" (17.78)	<b>01301008</b>
.25"-.36" (.63-.91)	400 (1,779)	8" (20.32)	<b>01301013</b>

### Punch-Lok® Bands

Punch-Lok Bands are applied over the tail of a grip to prevent the mesh from being tripped or pulled loose. Also, they assure full gripping action by locking the mesh of the tail in tight contact with the cable or rope.



When the tail of a grip is the leading end, the bands are particularly important to prevent accidental release caused by tripping on obstructions. A conductor-to-conductor (double-socking) pulling operation is a good example: where two grips connect two conductors to form a temporary splice. Bands should be applied to the ends of the grips as illustrated herein. It is also common practice to tape over the banded tail area to assure smooth passage through the sheaves.

The conductor should be installed in the grip up to the elbows of the aluminum shoulders in order to assure full and complete gripping action as illustrated above.

### Punch-Lok® Bands

Grip Banding Range Inches (cm)	Band Width Inches (cm)	Band Inside Diameter Inches (cm)	Model	Catalog Number
¼"-1½" (.63-2.86)	¾" (.95)	1¾" (3.49)	0-311	20320050
1½"-1¾" (2.86-4.13)	¾" (.95)	2" (5.08)	0-316	20320051
1¾"-2¼" (4.13-5.71)	¾" (1.59)	2½" (6.35)	0-10	20320052
2¼"-3½" (5.71-8.89)	¾" (1.59)	4" (10.16)	0-16	20320053
3½"-5" (8.89-12.70)	¾" (1.59)	6" (15.24)	0-24	20320054



20320054

### Accessories

Punch-Lok Tools	Catalog Number
P-1000 for use with ¾" width Banding tool.	20320048
P-38 for use with ¾" and ¾" width Banding tool for tight spaces.	20320047



20320048



20320047

*Note: In all cases two Punch-Lok Bands should be double wrapped approximately one inch to two inches (2.54cm to 5.08cm) from the grip's tail. Banding is required to ensure maximum reliability and guard against accidental release.*

*Punch-Lok® is a registered trademark of Punch-Lok Inc.*

**Stainless Steel Swivels**

Swivels are essential to the efficiency and safety of any high tension application. They are particularly important where continuous pulls develop higher and higher torque levels. Torque is intensified by the pull-resistance of the cable itself and the resistance of the high tension controlling equipment regulating line sag.

Ball bearing swivels release torque and prevent it from reaching dangerous levels that can damage the cable and obstruct the lines.

**IMPORTANT**  
 Read all breaking strength, safety and technical data relating to this product. Pages V-17 to V-26.



**Stainless Steel Swivels**

Maximum Safe Working Load Lbs. (N)	Dimensions in Inches (cm)							Model	Catalog Number
	A	B	C	D	E	F	G		
2,250 (10,000)	7/8" (2.22)	2 1/2" (6.35)	3 3/8" (8.57)	7/16" (1.11)	3/8" (0.95)	5/16" (0.79)	3 1/32" (2.46)	A-13L	<b>20308001A</b>
5,000 (22,240)	1 1/4" (3.17)	3 1 1/16" (9.37)	4 3/4" (12.06)	1 7/32" (1.35)	1 7/32" (1.35)	1 3/32" (1.03)	1 9/32" (3.25)	BB-13L	<b>20308002A</b>
9,000 (40,030)	1 1/2" (3.81)	4 1/4" (10.79)	5 5/8" (14.29)	1 1/4" (1.75)	1 9/32" (1.51)	1/2" (1.27)	1 9/16" (3.97)	B-13L	<b>20308003A</b>
10,000 (44,480)	1 5/8" (4.13)	4 1/2" (11.43)	6" (15.24)	3/4" (1.90)	1 1/16" (1.75)	5/8" (1.59)	1 23/32" (4.36)	C-13L	<b>20308004A</b>
30,000 (133,440)	2 3/8" (6.03)	7 5/8" (19.37)	10" (25.40)	1 3/16" (3.02)	1 1/32" (2.62)	7/8" (2.22)	2 25/32" (7.06)	D-13L	<b>20308005A</b>

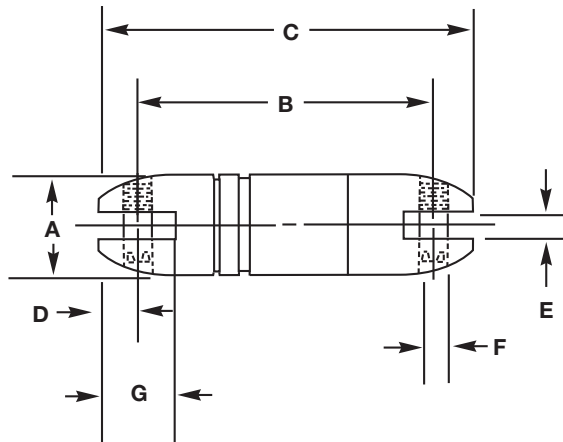

Kellems Pulling Grips are reusable tools for pulling electrical cable, bare conductor or rope. They are easy and fast to install, providing the user with a smooth, slim profile that allows for easy passage through ducts and conduit. Kellems Pulling Grips are made of the highest quality galvanized steel strand which assures the user of a long lasting grip. There is a Kellems Pulling Grip for every pulling job.

**CAUTION:** It is very important to comply with all of the following precautions. Failure to do so may result in property damage, personal injury or death.

1. Pulling grips are to be installed by a qualified individual in accordance with all applicable national and local safety, electrical and rigging codes.
2. Ensure that the correct grip is selected for your specific needs.
3. Do not use a pulling grip for any application other than pulling cable.
4. Thoroughly examine the grip for damage. Do not use a damaged grip.
5. Ensure that the recommended work load of the grip is suitable for the application. Never use grips at their approximated rated breaking strength. A safety factor of 5 is recommended for pulling grips.
6. Do not alter grips in any way. For example, do not modify pulling eyes, shoulders, fittings or lugs.
7. Do not attach any type of pulling hardware to any point on the grip other than the pulling eye. The pulling eye is the only acceptable means of attachment to external hardware.
8. Always apply 2 bands at 1" and 2" respectively, from the tail end of the mesh to guard against accidental release of the grip. Accidental release can occur if an object contracts and pushes against the tail end of the mesh, thereby expanding and releasing its hold.

### Select The Correct Pulling Grip

Each Kellems Grip is designed to work on a specific range of cable diameters.

**Step 1** Refer to the chart below to determine the style of grip best suited for your application.

**Step 2** Determine your cable outside diameter.

**Step 3** Find the grip size that encompasses your cable diameter.

**Step 4** Estimate the tension to be put on the grip, establish the working load you require and compare this to the listed approximate breaking strength of the grip to insure that the grip will be strong enough. Refer to page V-18 for safety and working load factors.

### Pulling Grip Selection Chart

Grip Style	Application	Page Number
DUA-PULL®, flexible eye	Extra high strength overhead transmission line stringing for bare or insulated conductor and synthetic rope.	V-6
Multiple strength, flexible eye	Normal overhead transmission and distribution line stringing for bare or insulated conductor.	V-7
Multiple strength, rotating eye	Normal overhead transmission and distribution line stringing for bare or insulated conductor.	V-7
K-type grip, rotating eye	Underground power cables and communication lines. Service lines into factories.	V-8
T-type grip, flexible eye	Underground power cables and communication lines. Service lines into factories.	V-9
Non-conductive, flexible eye	Pull insulated distribution cable into place.	V-10
Slack pulling, closed mesh	Remove underground cable. For pulling slack in final placement of new cable when end of cable is available.	V-10
Slack pulling, split mesh,	Remove underground cable. For pulling slack in final placement of new cable rawhide lace closing when end of cable is not available.	V-11
Slack pulling, split mesh,	Remove underground cable. For pulling slack in final placement of new cable rod closing when end of cable is not available, with rod closing for quick installation.	V-11
Light duty, flexible eye	Light pulling, underground electrical construction. Industrial plant wiring and rewiring jobs.	V-12
Junior, flexible eye	Connect bundled insulated building wire to a pulling tape. Pull wire through conduit.	V-12
Regular and rotating wire rope	Restraining wire rope in cranes and oil rigs.	V-13
Splicing	Temporary splice for cable or wire rope.	V-14
Pulling Grip Accessories	Tools, bands, swivels.	V-15, V-16
Fiber Optic Cable Pulling Grips	Pull fiber optic cable into place overhead, underground or through duct and conduit.	V-47, V-48, V-49

### Safety And Working Load Factors For Wire Mesh Grips

The broad application of Kellems grips on a wide variety of objects requires that adequate safety factors be used to establish working loads. The approximate breaking strength of a Kellems grip represents an average calculation based on data established from actual direct tension testing done in our engineering laboratories.

It is impossible to catalog or guarantee a safety factor suitable for all applications as operating conditions are never the same. The tension, diameter, movement, number of objects gripped, gripping surface, and the attachments used are just some of the factors which vary with each application. These factors, together with the effects of abrasion, corrosion, prior use or abuse and any other variables of a specific application, must be considered by the user and

the grip replaced as appropriate. Where the conditions of the application are not well defined or known, or where risk of injury to persons or property is involved, a greater safety factor should be utilized.

**Under normal conditions, Kellems' recommended factor of safety is five for catalog listed pulling grips, and ten for catalog listed support grips.**

Any warranty as to quality, performance or fitness for use of grips is always premised on the condition that the published breaking strengths apply only to new, unused grips, and that such products are properly stored, handled, used, maintained and inspected by the user at a frequency appropriate for the use and condition of the grip.

### Examples

Grip Style	Approx. Breaking Strength Lbs. (N)	Safety Factor	Max. Recommended Load Lbs. (N)	Catalog Number
Pulling Grips	27,200 (120,986)	5	5,440 (24,197)	<b>03301027</b>
Support Grips	1,610 (7,161)	10	161 (716)	<b>02201018</b>

The maximum recommended working load then is the tension to be exerted on the grip in application with a margin of safety to take care of unforeseen and unusual circumstances.

It is the end-user's decision to determine how much of a safety factor is acceptable for the application.

The metric unit of measure (force) for breaking strength and load is newtons (N). To convert from newtons to the metric unit of weight (kilograms) the conversion factor is 9.808 newtons/kilogram.

### Pulling Grip Materials

Material	Features	Product Group
Galvanized steel wire	<ul style="list-style-type: none"> <li>• High strength</li> <li>• Not subject to continuous outside environment</li> </ul>	<ul style="list-style-type: none"> <li>• Pulling grips</li> <li>• Wire rope grips</li> <li>• Splicing grips</li> </ul>
Non-metallic strand	<ul style="list-style-type: none"> <li>• Superior flex life</li> <li>• Non-conductive</li> <li>• Corrosion resistant</li> <li>• Moderate strength</li> </ul>	<ul style="list-style-type: none"> <li>• Non-conductive pulling grips</li> </ul>

### Approvals

UL and CSA Certification is indicated on appropriate product catalog pages.



## Overhead Pulling DUA-PULL® Grips

DUA-PULL Pulling Grips are the highest strength pulling grips manufactured for overhead transmission line stringing applications. They have a dual function of working with both bare and insulated conductors and synthetic rope, not provided by any other grip. Kellems' patented two-over, two-under weave design gives exceptional strength and gripping ability by putting more steel mesh in contact with the cable or rope surfaces.

**THIS IS THE ONLY PULLING GRIP RECOMMENDED FOR USE ON SYNTHETIC ROPE.**

### Application

The DUA-PULL Grips are primarily used in overhead transmission line construction where loads and safety considerations require an extra high strength grip. They are most commonly used for attaching pulling lines to conductors, conductors to running boards and "double socking" for conductor-to-conductor connections. The DUA-PULL line accommodates ACSR, ACAR, all aluminum and copper conductors. Also, the grips accommodate ground wires, messenger strands, wire ropes and synthetic ropes.

### Benefits

- Made of high strength galvanized steel strand.
- Recommended for pulling bare or insulated conductor, wire rope and synthetic rope.
- DUA-PULL mesh design offers the greatest holding power for all pulling applications.
- Each grip size is color coded for fast and accurate identification and selection.
- Will mate with swivels. See page V-16.

### Feed Tubes

The Kellems Feed Tube is used when assembling synthetic rope into the DUA-PULL Grip. It is required on the largest two sizes of DUA-PULL Grips. Feed Tubes are available for use on all size DUA-PULL Grips.

### Benefits

- Saves time, allowing fast, easy assembly.
- Can be reused if not damaged.

*Note: 1. Do not run grips or swivels over bullwheels while under tension.*

*2. Two Punch-Lok® bands should be firmly attached approximately 1" and 2" (2.54cm and 5.08cm) from the grip's tail.*

*Banding is required to ensure maximum reliability and guard against accidental release. See page V-15.*

*3. Double braided rope, such as 2-in-1 type, should be back spliced for approximately 2/3 of the mesh length for best gripping results. Grip size should be selected by diameter of back splice.*

### Components

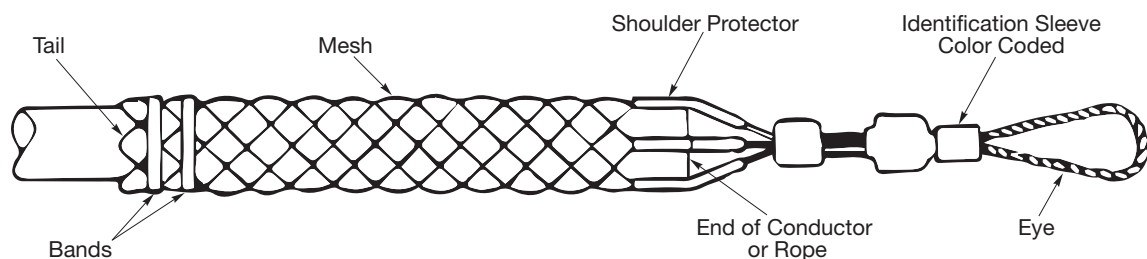

## Overhead Pulling Multiple Strength Grips

Multiple Strength Pulling Grips are designed for pulling aluminum or copper bare conductor, ground wires, messenger strands, wire rope and insulated cables. They are made of high strength galvanized steel strand and feature a multi-weave mesh construction of single, double and triple weave for firm holding power.

## Application

Kellems Multiple Strength Grips are ideal for overhead transmission and distribution line stringing where moderate loading is anticipated. They are economical tools for attaching conductors to pulling lines and double socking for conductor-to-conductor connections.

## Rotating Eye Feature

Multiple Strength Grips are available with a forged steel rotating eye which can be attached to a swivel. The forged eye is durable, compact and streamlined and will thread through blocks and sheaves without binding. The rotating eye is not a swivel and will not turn while under tension; it can turn to relieve pulling torque when tension is relaxed. If constant swivel action is required, a swivel should be used. For swivel dimensions, see page V-16. For rotating eye dimensions, see page V-21.

## Flexible Eye Feature

Multiple Strength Grips are also available with a flexible, patented wire rope eye. This compact eye will mate with a swivel, and pass through blocks and sheaves without binding.

## Benefits

- Economical, high strength pulling tool.
- Multi-weave construction provides greater strength and holding power.
- Endless Weave Grip end lies flat on the cable and will not snag.

*Note: 1. Do not run grips or swivels over bullwheels while under tension.*

*2. Two Punch-Lok® bands should be firmly attached approximately 1" and 2" (2.54cm and 5.08cm) from the grip's tail. Banding is required to ensure maximum reliability and guard against accidental release. See page V-15.*

## Components

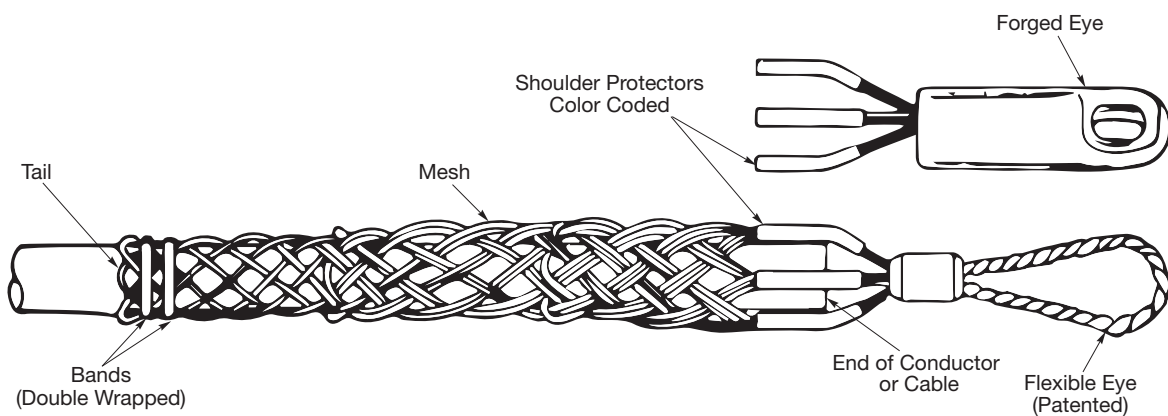

## Underground Pulling K-Type and T-Type Grips

### K-Type Application

Rotating Eye, K-Type Pulling Grips are specially designed for use in the installation of underground power cables, communication lines and service lines into factories, shopping centers, construction projects and general underground electrical construction.

### Rotating Eye Feature

K-Type Grips come equipped with a forged steel rotating eye which can be attached to a swivel. The forged eye is durable, compact and streamlined, and will thread through blocks and sheaves without binding.

**The rotating eye is not a swivel and will not turn while under tension;** it can turn to relieve pulling torque when the tension is relaxed. If constant swivel action is required, a swivel should be used. For swivel dimensions, see page V-16.

### Benefits

- An economical tool for pulling cable.
- Safe, rugged and dependable.
- Equipped with a rotating eye for spin out of pulling torque after load release.
- Easily installed and removed.

### Rotating Eye Dimensions

Rotating Eye Dimensions Inches (cm)	A	B	C	D	F
7/8" (2.22)	7/8" (2.22)	9/32" (.71)	1/2" (1.27)	7/8" (2.22)	2 5/8" (6.67)
1" (2.54)	1" (2.54)	1/2" (1.27)	9/16" (1.43)	1 3/16" (2.06)	3 1/2" (8.89)
1 1/8" (3.49)	1 1/8" (3.49)	1/2" (1.27)	1 1/16" (1.75)	1" (2.54)	4 1/2" (11.43)
1 1/4" (4.13)	1 1/4" (4.13)	5/8" (1.59)	7/8" (2.22)	1 3/16" (3.02)	5 5/16" (13.49)
1 1/2" (4.76)	1 1/2" (4.76)	2 1/32" (1.67)	1" (2.54)	1 3/8" (3.49)	6 1/8" (15.56)

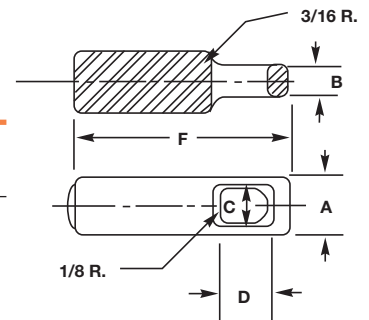

### T-Type

Kellems Flexible T-Type Pulling Grips are made of high strength galvanized steel strand. They feature double weave mesh for positive holding power in medium to heavy pulling jobs. The grip eye will easily attach to a swivel.

### Application

T-Type Pulling Grips are used for the installation of underground power cables, communication lines and service lines into factories, construction projects and for general underground electrical construction. Available in two mesh lengths, short for medium pulls, and standard for general purpose pulling.

### Benefits

- Will pull a single cable or cable bundles.
- Patented flexible eye design provides flexibility to follow line of pull.
- A dependable, reusable pulling tool.
- Easily installed and removed.
- Mates easily with a swivel. See page V-16.

## Special Purpose Grips

### Non-Conductive Pulling Grips

---

Kellems Non-Conductive Pulling Grips, made of a high strength, non-conductive aramid fiber, are available for pulling single cable or cable bundles. Their braided double weave design adds strength and positive holding power.

### Application

---

Kellems Non-Conductive Pulling Grips were developed for use by utilities for pulling overhead distribution lines in close proximity to energized lines and hardware.

### Benefits

---

- Color coded for fast on-site selection.
- Extra flexibility for easy installation.
- Non-metallic mesh provides for safe pulls over "hot" areas.
- Pellethane jacketed aramid fiber mesh resists abrasion.
- Grips are corrosion resistant.

*Note: Taping is required to guard against accidental release and to insure maximum reliability. Apply vinyl plastic electrical tape starting 2" to 3" (5.08cm to 7.62cm) from the tail of the grip onto 2" to 3" (5.08cm to 7.62cm) of cable.*

### Slack Pulling Grips

---

Slack Pulling Grips are offered in three styles made of galvanized steel. The closed type is used when the cable end is accessible. When not, there are split lace and split rod closing styles. All grips feature single offset eye for easy attachment to a pulling line.

### Application

---

Slack Grips are widely used in pulling slack for final placement of under ground cable after it has been pulled in. They are also used for removing cable. Standard mesh lengths are generally used in restricted space for short pulls. Longer lengths are used for higher pulling loads where space is not restricted.

### Benefits

---

- Easy attachment to pulling lines.
- Reusable rawhide lace for lace closure.
- Galvanized steel for strength.

*Note: 1. Replacement rawhide lace. Catalog number 20920002.  
2. See page V-43 for lace and rod closing instructions.*

## Commercial Construction/Light Duty Grips

### Light Duty Pulling Grips

---

Light Duty Pulling Grips are made of galvanized steel in a single weave construction. They feature a flexible eye for easy attachment to a pulling line.

### Application

---

Light Duty Grips are used in general underground electrical construction where pulling tensions are low. They are easy tools to use in wiring industrial plants and commercial buildings.

### Benefits

---

- Perfect tools for light pulling jobs.
- Installs easily on cable.
- Strong, galvanized steel construction.

### Junior Duty Pulling Grips

---

Junior Pulling Grips feature a strong galvanized steel, single weave mesh. A flexible eye easily attaches to a pulling line, snake or fish tape.

### Application

---

Designed to pull building wire, Junior grips are safe tools to use in pulling wire at low tension through conduit during electrical construction.

### Benefits

---

- Installs easily over building wire.
- Strong secure grip.
- Reusable.
- Pulls single cable or cable bundles.

### Junior Grip Kit

---

Junior Grip Kit contains 6 grips, one of each size. Catalog number **033051114**. See page V-12.

*Note: See page V-26 for building wire selection chart.*

## Splicing Grips

### Wire Rope Splicing

---

Kellems Wire Rope Grips are made of high strength galvanized steel strand in a construction of triple, double and single weave for superior gripping ability. They are available with or without a rotating barrel which will help eliminate twist in the old rope from being transferred to the new rope.

### Application

---

Wire Rope Grips are used for changing wire rope on oil derricks, large cranes, overhead cranes and drag lines. It provides a quick, safe, inexpensive temporary splice. By installing the used wire rope in one end and the new rope in the other, the new wire rope can be pulled in as the old one is pulled out.

### Benefits

---

- High strength for secure pulling.
- Easy installation.
- Flexible to pass through sheaves and blocks.

*Note: 1. During installation each end of the grip should be banded and taped down securely over the rope to insure smooth passage through sheaves and to guard against accidental release. See page V-15 for end bands.*

*2. The rotating barrel is not a swivel and will not turn while under tension. It can turn to relieve pulling torque when tension is relaxed.*

### Cable Splicing

---

Splicing Grips are made of galvanized steel in double or single weave mesh construction. They are available in various lengths and sizes to suit most applications.

### Application

---

Splicing Grips are used as a temporary splice for rope, cable or wire rope. They can also be used as cable reinforcement, and can act as a shield to protect cables and hoses from abrasion.

### Benefits

---

- Easily installed or removed.
- Galvanized steel construction for strength.
- Flexible to follow cable path.

*Note: 1. During installation, each end of the splicing grip should be banded and taped down securely to the cable to insure smooth passage with the cable and guard against accidental release.*

*2. See page V-15 for end bands.*

**Multiple Cable Selection Charts for Cables and Wires of Unequal Diameters**

**How to choose the correct grip size:**

1. Find the Grip Circumference Range by measuring the circumference of the bundle of different diameter cables to be gripped (see illustration).
2. Divide the bundle circumference by 3.14 to determine the diameter.
3. Choose a grip offering a range of cable diameters the same as the cable diameter.

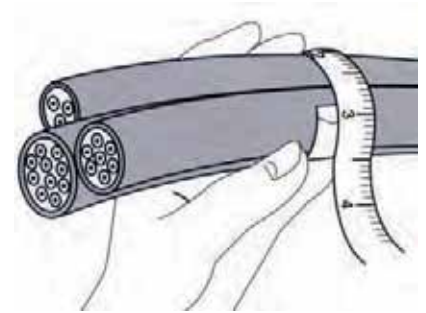

**For Pulling Grips\***

**CAUTION:** When a grip is used on multiple cables, the tail end of the grip should be banded after positioning on the cables.

**For Cables of Equal Diameters**

Under "Number of Cables in One Grip", find the diameter of your single cable in vertical column. Read the grip diameter range to the right. If your diameter is the maximum of the range shown, go to the next larger size for Split Grips, stay with the same size for Closed Grips.

**Example:** Three cables, each with .89" (2.26cm) diameter, for a Closed Grip select the 1.50"-1.74" (3.81cm-4.42cm) range, for a Split Grip select the 1.75"-1.99" (4.44cm-5.05cm) range.

**Number of Cables in One Grip**

2	3	4	5	6 and 7	8	9	Grip Dia. Range Inches (cm)
.30-.38 (.76-.97)	.25-.31 (.63-.79)	.22-.27 (.56-.69)	.19-.24 (.48-.60)	.17-.22 (.43-.56)	.15-.19 (.38-.48)	.14-.18 (.36-.46)	.50-.61 (1.27-1.55)
.38-.44 (.97-1.12)	.31-.36 (.79-.91)	.27-.31 (.69-.79)	.24-.29 (.61-.74)	.22-.26 (.56-.66)	.19-.23 (.48-.58)	.18-.21 (.46-.53)	.62-.74 (1.57-1.88)
.44-.59 (1.12-1.50)	.36-.49 (.91-1.24)	.31-.42 (.79-1.07)	.29-.38 (.74-.97)	.26-.34 (.66-.86)	.23-.31 (.58-.79)	.21-.28 (.53-.71)	.75-.99 (1.90-2.51)
.59-.75 (1.50-1.90)	.49-.63 (1.24-1.60)	.42-.54 (1.07-1.37)	.38-.48 (.97-1.22)	.34-.43 (.86-1.09)	.31-.39 (.79-.99)	.28-.35 (.71-.89)	1.00-1.24 (2.54-3.15)
.75-.90 (1.90-2.29)	.63-.76 (1.60-1.93)	.54-.65 (1.37-1.65)	.48-.58 (1.22-1.47)	.43-.52 (1.09-1.32)	.39-.46 (.99-1.17)	.35-.42 (.89-1.07)	1.25-1.49 (3.17-3.78)
.90-1.07 (2.29-2.72)	.76-.89 (1.93-2.26)	.65-.77 (1.65-1.96)	.58-.67 (1.47-1.70)	.52-.60 (1.32-1.52)	.46-.54 (1.17-1.37)	.42-.49 (1.07-1.24)	1.50-1.74 (3.81-4.42)
1.07-1.22 (2.72-3.10)	.89-1.02 (2.26-2.59)	.77-.88 (1.96-2.24)	.67-.77 (1.70-1.96)	.60-.69 (1.52-1.75)	.54-.62 (1.37-1.57)	.49-.56 (1.24-1.42)	1.75-1.99 (4.44-5.05)
1.22-1.53 (3.10-3.89)	1.02-1.28 (2.59-3.25)	.88-1.10 (2.24-2.79)	.77-.96 (1.96-2.44)	.69-.86 (1.75-2.18)	.62-.77 (1.57-1.96)	.56-.71 (1.42-1.80)	2.00-2.49 (5.08-6.32)
1.53-1.83 (3.89-4.65)	1.28-1.53 (3.25-3.89)	1.10-1.32 (2.79-3.35)	.96-1.16 (2.44-2.95)	.86-1.03 (2.18-2.62)	.77-.93 (1.96-2.36)	.71-.85 (1.80-2.16)	2.50-2.99 (6.35-7.59)
1.83-2.14 (4.65-5.44)	1.53-1.79 (3.89-4.55)	1.32-1.54 (3.35-3.91)	1.16-1.35 (2.95-3.43)	1.03-1.20 (2.62-3.05)	.93-1.08 (2.36-2.74)	.85-.99 (2.16-2.51)	3.00-3.49 (7.62-8.86)
2.14-2.44 (5.44-6.20)	1.79-2.05 (4.55-5.21)	1.54-1.76 (3.91-4.47)	1.35-1.54 (3.43-3.91)	1.20-1.37 (3.05-3.48)	1.08-1.24 (2.74-3.15)	.99-1.13 (2.51-2.87)	3.50-3.99 (8.89-10.13)
2.44-2.75 (6.20-6.98)	2.05-2.30 (5.21-5.84)	1.76-1.98 (4.47-5.03)	1.54-1.74 (3.91-4.42)	1.37-1.55 (3.48-3.94)	1.24-1.39 (3.15-3.53)	1.13-1.27 (2.87-3.23)	4.00-4.49 (10.16-11.40)
2.75-3.06 (6.98-7.77)	2.30-2.56 (5.84-6.50)	1.98-2.20 (5.03-5.59)	1.74-1.93 (4.42-4.90)	1.55-1.72 (3.94-4.37)	1.39-1.55 (3.53-3.94)	1.27-1.41 (3.23-3.58)	4.50-4.99 (11.43-12.67)

*Note: \*This chart is not to be used for Conduit Riser Grips. Refer to the chart for Conduit Riser multiple cable section. It is always recommended that, when multiple cables are installed in a pulling grip, the tail end be banded and tightly taped after installation on the cable bundle. See page V-15 for end bands.*

### Junior Pulling Grip Selection Chart

These charts are a general guide to assist in the selection of the correct Junior Pulling Grip for pulling various groupings of building wire. It is not intended to be restrictive inasmuch as the use of "dummy" wires (short pieces of wire used to fill out the Grip) or the tight taping of the wires into a compact bundle may increase or decrease the number of wires per Grip.

#### T.H.W.N., T.H.H.N. and X.H.H.W. Building Wire

Cable Diameter Range In. (cm)	Approx. Breaking Strength Lbs. (N)	Approximate Number Of Wires In One Grip											Model	Catalog Number
		#14 19 Strand	#12 19 Strand	#10 19 Strand	#8 19 Strand	#6 19 Strand	#4 19 Strand	#3 19 Strand	#2 19 Strand	#1 37 Strand	#1/0 37 Strand			
.25-.36 (.63-.91)	450 (2,002)	4-8	3-6	2-3	2	1	1	1	—	—	—	J 25	03305001	
.37-.49 (.94-1.24)	900 (4,003)	9-16	6-11	4-6	3	2	—	—	1	1	1	J 37	03305002	
.50-.61 (1.27-1.55)	1,300 (5,782)	16-25	11-17	7-10	4-5	3-4	2	2	—	—	—	J 50	03305003	
.62-.74 (1.57-1.88)	1,950 (8,674)	26-37	18-25	11-14	6-8	5-6	3	3	2	2	—	J 62	03305004	
.75-.99 (1.90-2.51)	2,800 (12,454)	37-66	26-47	15-27	9-16	6-11	4-7	4-5	3-4	3	2-3	J 75	03305005	
1.00-1.24 (2.54-3.15)	3,900 (17,347)	66-104	47-74	28-43	16-24	11-17	8-10	6-8	5-7	4-5	4	J 100	03305006	

#### R.H.H., R.H., R.W. and R.H.W. Building Wire

Cable Diameter Range In. (cm)	Approx. Breaking Strength Lbs. (N)	Approximate Number Of Wires In One Grip										Model	Catalog Number
		#14 7 Strand	#12 7 Strand	#10 7 Strand	#8 7 Strand	#6 7 Strand	#4 7 Strand	#2 7 Strand	#1 7 Strand	#1/0 19 Strand			
.25-.36 (.63-.91)	450 (2,002)	2	2	1	1	—	—	—	—	—	J 25	03305001	
.37-.49 (.94-1.24)	900 (4,003)	3	2-3	2	—	1	1	1	—	—	J 37	03305002	
.50-.61 (1.27-1.55)	1,300 (5,782)	4-5	4-5	3-4	2	—	—	—	1	—	J 50	03305003	
.62-.74 (1.57-1.88)	1,950 (8,674)	6-8	6-7	4-5	3	2	2	—	—	1	J 62	03305004	
.75-.99 (1.90-2.51)	2,800 (12,454)	9-16	8-14	6-10	4-6	3-4	3-4	2-3	2	—	J 75	03305005	
1.00-1.24 (2.54-3.15)	3,900 (17,347)	16-24	15-22	11-16	7-10	5-7	4-6	4	3	2-3	J 100	03305006	

#### T.H.W. Building Wire

Cable Diameter Range In. (cm)	Approx. Breaking Strength Lbs. (N)	Approximate Number Of Wires In One Grip										Model	Catalog Number
		#14 7 Strand	#12 7 Strand	#10 7 Strand	#8 7 Strand	#6 7 Strand	#4 7 Strand	#2 7 Strand	#1 7 Strand	#1/0 19 Strand			
.25-.36 (.63-.91)	450 (2,002)	2-4	2-3	2	1	1	1	—	—	—	J 25	03305001	
.37-.49 (.94-1.24)	900 (4,003)	5-7	4-5	3-4	2	—	—	1	—	—	J 37	03305002	
.50-.61 (1.27-1.55)	1,300 (5,782)	8-11	6-8	5-7	3-4	2	2	—	1	1	J 50	03305003	
.62-.74 (1.57-1.88)	1,950 (8,674)	12-16	9-12	8-10	5-6	3-4	3	2	—	—	J 62	03305004	
.75-.99 (1.90-2.51)	2,800 (12,454)	17-30	13-24	11-19	7-10	5-7	4-5	3-4	2	2	J 75	03305005	
1.00-1.24 (2.54-3.15)	3,900 (17,347)	31-48	25-37	20-30	11-17	8-11	6-8	5-6	3-4	3	J 100	03305006	



Kellems® Wire Management Products  
**Support Grips - Heavy Duty, Standard Duty, Light Duty**  
*Tin-Coated Bronze/Stainless Steel*

Solid eye assemblies provide eye reinforcement at support hardware

Four eye styles available: single (shown), double, universal, and offset

Identification tag shows: catalog number, diameter range, agency approval, and bar code

The strand equalizer positions wires for equal loading throughout the entire grip length

The positive action mesh grip is designed for light duty up to heavy duty. Closed grips fit over the cable end, split grips wrap around the cable mid-span. The standard material is nonmagnetic, tin-coated bronze. Selected items are available in stainless steel. For exceptional immunity to rust and corrosion with superior strength and flexibility for heavy duty support application in harsh environments; contact the factory

The endless weave provides easy installation onto cable and can be easily repositioned



**IMPORTANT**  
 Read all breaking strength, safety and technical data relating to this product. Pages V-41 to V-45.

### Single Eye, Closed Mesh

For permanent support when cable end is available to be installed through grip.

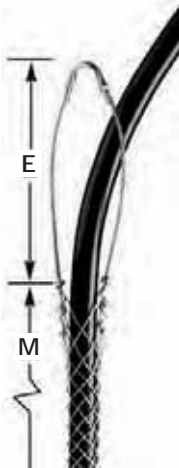

Cable Diameter Range Inches (cm)	Approx. Breaking Strength Lbs. (N)		E Inches (cm)	M Inches (cm)	Tin-Coated Bronze	Stainless Steel
	Tin-Coated Bronze	Stainless Steel				
.50"-1.27" (1.27-1.57)	530 (2,357)	1,370 (6,094)	7" (17.78)	10" (25.40)	02201013	02401013
.63"-1.74" (1.60-1.88)	790 (3,514)	2,060 (9,163)	8" (20.32)	10" (25.40)	02201014	02401014
.75"-1.91" (1.90-2.51)	1,020 (4,537)	2,060 (9,163)	8" (20.32)	13" (33.02)	02201015	02401015
1.00"-2.54" (2.54-3.15)	1,610 (7,161)	2,678 (11,912)	9" (22.86)	14" (35.56)	02201017	02401017
1.25"-3.17" (3.17-3.78)	1,610 (7,161)	4,490 (19,972)	10" (25.40)	15" (38.10)	02201018	02401018
1.50"-3.81" (3.81-4.42)	1,610 (7,161)	4,492 (19,981)	12" (30.48)	17" (43.18)	02201019	02401019
1.75"-4.44" (4.44-5.05)	2,150 (9,563)	5,000 (22,241)	14" (35.56)	19" (48.26)	02201020	02401020
2.00"-5.08" (5.08-6.32)	3,260 (14,500)	8,940 (39,767)	16" (40.64)	21" (53.34)	02201021	02401021
2.50"-6.35" (6.35-7.59)	3,260 (14,500)	8,947 (39,798)	18" (45.72)	23" (58.42)	02201022	02401022
3.00"-7.62" (7.62-8.86)	4,900 (21,795)	13,420 (59,695)	21" (53.34)	25" (63.50)	02201023	02401023
3.50"-8.89" (8.89-10.13)	4,900 (21,795)	—	24" (60.96)	27" (68.58)	02201024	—

### Single Eye, Split Mesh, Lace Closing

For permanent support when cable end is not available.

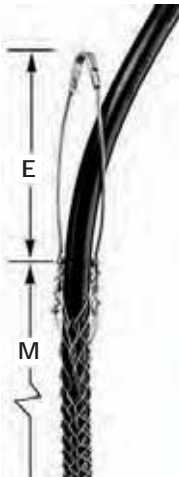

Cable Diameter Range Inches (cm)	Approx. Breaking Strength Lbs. (N)		E Inches (cm)	M Inches (cm)	Tin-Coated Bronze	Stainless Steel
	Tin-Coated Bronze	Stainless Steel				
.50"-1.27" (1.27-1.57)	530 (2,357)	1,370 (6,094)	7" (17.78)	10" (25.40)	02202013	02402013
.63"-1.74" (1.60-1.88)	790 (3,514)	2,066 (9,190)	8" (20.32)	10" (25.40)	02202014	02402014
.75"-1.91" (1.90-2.51)	1,020 (4,537)	2,060 (9,163)	8" (20.32)	13" (33.02)	02202015	02402015
1.00"-2.54" (2.54-3.15)	1,610 (7,161)	2,670 (11,876)	9" (22.86)	14" (35.56)	02202017	02402017
1.25"-3.17" (3.17-3.78)	1,610 (7,161)	4,490 (19,972)	10" (25.40)	15" (38.10)	02202018	02402018
1.50"-3.81" (3.81-4.42)	1,610 (7,161)	4,490 (19,972)	12" (30.48)	17" (43.18)	02202019	02402019
1.75"-4.44" (4.44-5.05)	2,150 (9,563)	4,375 (19,461)	14" (35.56)	19" (48.26)	02202020	02402020
2.00"-5.08" (5.08-6.32)	3,260 (14,500)	8,947 (39,798)	16" (40.64)	21" (53.34)	02202021	02402021
2.50"-6.35" (6.35-7.59)	3,260 (14,500)	8,940 (39,767)	18" (45.72)	23" (58.42)	02202022	02402022
3.00"-7.62" (7.62-8.86)	4,900 (21,795)	13,420 (59,695)	21" (53.34)	25" (63.50)	02202023	02402023
3.50"-8.89" (8.89-10.13)	4,900 (21,795)	13,420 (59,695)	24" (60.96)	27" (68.58)	02202024	02402024

### Single Eye, Split Mesh, Rod Closing

For support when cable end is not available.

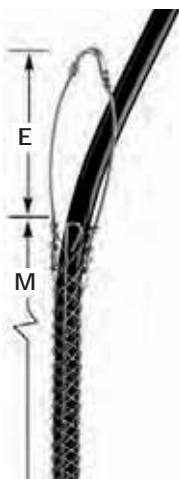

Cable Diameter Range Inches (cm)	Approx. Breaking Strength Lbs. (N)		E Inches (cm)	M Inches (cm)	Tin-Coated Bronze	Stainless Steel
	Tin-Coated Bronze	Stainless Steel				
.50"-1.27" (1.27-1.57)	790 (3,514)	1,050 (4,670)	7" (17.78)	8.5" (21.59)	02203013	02403013
.63"-1.74" (1.60-1.88)	790 (3,514)	2,050 (9,119)	8" (20.32)	8.5" (21.59)	02203014	02403014
.75"-1.91" (1.90-2.51)	1,020 (4,537)	2,050 (9,119)	8" (20.32)	10.5" (26.67)	02203015	02403015
1.00"-2.54" (2.54-3.15)	1,610 (7,161)	2,650 (11,788)	9" (22.86)	12.5" (31.75)	02203017	02403017
1.25"-3.17" (3.17-3.78)	1,610 (7,161)	4,500 (20,017)	10" (25.40)	14.5" (36.83)	02203018	02403018
1.50"-3.81" (3.81-4.42)	1,610 (7,161)	4,500 (20,017)	12" (30.48)	15.5" (39.37)	02203019	02403019
1.75"-4.44" (4.44-5.05)	2,150 (9,563)	6,000 (26,689)	14" (35.56)	16.5" (41.91)	02203020	02403020
2.00"-5.08" (5.08-6.32)	3,260 (14,500)	8,950 (39,812)	16" (40.64)	19.5" (49.53)	02203021	02403021
2.50"-6.35" (6.35-7.59)	3,260 (14,500)	7,750 (34,474)	18" (45.72)	21.5" (54.61)	02203022	02403022
3.00"-7.62" (7.62-8.86)	5,750 (25,576)	8,500 (37,810)	21" (53.34)	23.5" (59.69)	02203023	02403023
3.50"-8.89" (8.89-10.13)	5,750 (25,576)	—	24" (60.96)	25.5" (64.77)	02203024	—

Note: E-Eye length. M-Mesh length at nominal diameter.

**IMPORTANT**

Read all breaking strength, safety and technical data relating to this product. Pages V-41 to V-45.

**Double Eye, Closed Mesh**

For permanent support when cable end is available to be installed through grip.

Cable Diameter Range Inches (cm)	Approx. Breaking Strength Lbs. (N)		E Inches (cm)	M Inches (cm)	Tin-Coated Bronze	Stainless Steel
	Tin-Coated Bronze	Stainless Steel				
.50"-.62" (1.27-1.57)	530 (2,357)	1,370 (6,094)	4" (10.16)	10" (25.40)	02201001	02401001
.63"-.74" (1.60-1.88)	790 (3,514)	2,060 (9,163)	4" (10.16)	10" (25.40)	02201002	02401002
.75"-.99" (1.90-2.51)	1,020 (4,537)	2,060 (9,163)	4" (10.16)	13" (33.02)	02201003	02401003
1.00"-1.24" (2.54-3.15)	1,610 (7,161)	2,670 (11,877)	5" (12.70)	14" (35.56)	02201005	02401005
1.25"-1.49" (3.17-3.78)	1,610 (7,161)	4,490 (19,972)	5" (12.70)	15" (38.10)	02201006	02401006
1.50"-1.74" (3.81-4.42)	1,610 (7,161)	4,490 (19,972)	5" (12.70)	17" (43.18)	02201007	02401007
1.75"-1.99" (4.44-5.05)	2,150 (9,563)	5,000 (22,241)	6" (15.24)	19" (48.26)	02201008	02401008
2.00"-2.49" (5.08-6.32)	3,260 (14,500)	8,940 (39,767)	6" (15.24)	21" (53.34)	02201009	02401009
2.50"-2.99" (6.35-7.59)	3,260 (14,500)	8,940 (39,767)	6" (15.24)	23" (58.42)	02201010	02401010
3.00"-3.49" (7.62-8.86)	4,900 (21,795)	12,000 (53,379)	8" (20.32)	25" (63.50)	02201011	02401011
3.50"-3.99" (8.89-10.13)	4,900 (21,795)	12,000 (53,379)	8" (20.32)	27" (68.58)	02201012	02401012

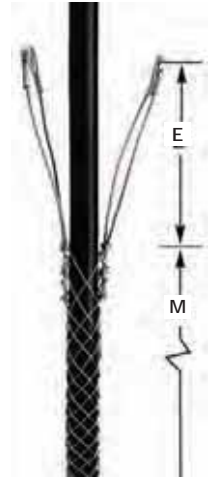

**Double Eye, Split Mesh, Lace Closing**

For permanent support when cable end is not available.

Cable Diameter Range Inches (cm)	Approx. Breaking Strength Lbs. (N)		E Inches (cm)	M Inches (cm)	Tin-Coated Bronze	Stainless Steel
	Tin-Coated Bronze	Stainless Steel				
.50"-.62" (1.27-1.57)	530 (2,357)	—	4" (10.16)	10" (25.40)	02202001	—
.63"-.74" (1.60-1.88)	790 (3,514)	2,066 (9,190)	4" (10.16)	10" (25.40)	02202002	02402002
.75"-.99" (1.90-2.51)	1,020 (4,537)	2,060 (9,163)	4" (10.16)	13" (33.02)	02202003	02402003
1.00"-1.24" (2.54-3.15)	1,610 (7,161)	2,678 (11,912)	5" (12.70)	14" (35.56)	02202005	02402005
1.25"-1.49" (3.17-3.78)	1,610 (7,161)	4,490 (19,972)	5" (12.70)	15" (38.10)	02202006	02402006
1.50"-1.74" (3.81-4.42)	1,610 (7,161)	3,750 (16,681)	5" (12.70)	17" (43.18)	02202007	02402007
1.75"-1.99" (4.44-5.05)	2,150 (9,563)	5,000 (22,241)	6" (15.24)	19" (48.26)	02202008	02402008
2.00"-2.49" (5.08-6.32)	3,260 (14,500)	8,940 (39,767)	6" (15.24)	21" (53.34)	02202009	02402009
2.50"-2.99" (6.35-7.59)	3,260 (14,500)	—	6" (15.24)	23" (58.42)	02202010	—
3.00"-3.49" (7.62-8.86)	4,900 (21,795)	—	8" (20.32)	25" (63.50)	02202011	—
3.50"-3.99" (8.89-10.13)	4,900 (21,795)	—	8" (20.32)	27" (68.58)	02202012	—

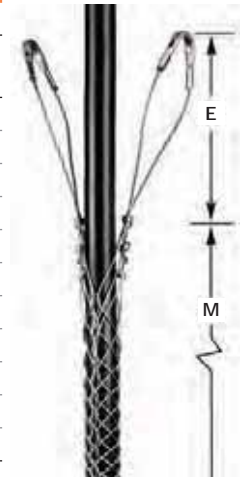

**Double Eye, Split Mesh, Rod Closing**

For support when cable end is not available.

Cable Diameter Range Inches (cm)	Approx. Breaking Strength Lbs. (N)		E Inches (cm)	M Inches (cm)	Tin-Coated Bronze	Stainless Steel
	Tin-Coated Bronze	Stainless Steel				
.50"-.62" (1.27-1.57)	790 (3,514)	—	4" (10.16)	6.5"	02203001	—
.63"-.74" (1.60-1.88)	790 (3,514)	2,050 (9,119)	4" (10.16)	8.5" (21.59)	02203002	02403002
.75"-.99" (1.90-2.51)	1,020 (4,537)	2,050 (9,119)	4" (10.16)	10.5" (26.67)	02203003	02403003
1.00"-1.24" (2.54-3.15)	1,610 (7,161)	2,650 (11,788)	5" (12.70)	12.5" (31.75)	02203005	02403005
1.25"-1.49" (3.17-3.78)	1,610 (7,161)	3,750 (16,681)	5" (12.70)	14.5" (36.83)	02203006	02403006
1.50"-1.74" (3.81-4.42)	1,610 (7,161)	3,750 (16,681)	5" (12.70)	15.5" (39.37)	02203007	02403007
1.75"-1.99" (4.44-5.05)	2,150 (9,563)	5,000 (22,241)	6" (15.24)	16.5" (41.91)	02203008	02403008
2.00"-2.49" (5.08-6.32)	3,260 (14,500)	8,950 (39,812)	6" (15.24)	19.5" (49.53)	02203009	02403009
2.50"-2.99" (6.35-7.59)	3,260 (14,500)	8,950 (39,812)	6" (15.24)	21.5" (54.61)	02203010	02403010
3.00"-3.49" (7.62-8.86)	5,750 (25,576)	11,150 (49,598)	8" (20.32)	23.5" (59.69)	02203011	02403011
3.50"-3.99" (8.89-10.13)	5,750 (25,576)	—	8" (20.32)	25.5" (64.77)	02203012	—

Note: E-Eye length. M-Mesh length at nominal diameter.

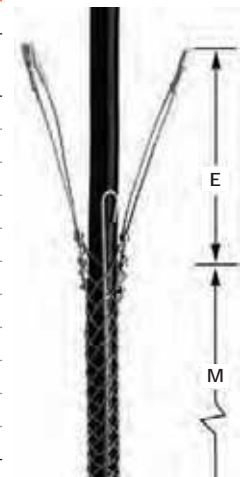

**IMPORTANT**  
 Read all breaking strength, safety and technical data relating to this product. Pages V-41 to V-45.

### Offset Eye, Closed Mesh

For permanent support when cable end is available to be installed through grip.

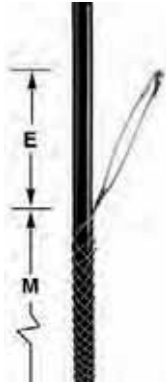

Cable Diameter Range Inches (cm)	Approx. Breaking Strength Lbs. (N)		E Inches (cm)	M Inches (cm)	Tin-Coated Bronze	Stainless Steel
	Tin-Coated Bronze	Stainless Steel				
.50"-1.24" (1.27-3.15)	530 (2,357)	1,370 (6,094)	4" (10.16)	10" (25.40)	02201037	02401037
.63"-1.49" (1.60-3.78)	750 (3,336)	1,950 (8,674)	4" (10.16)	10" (25.40)	02201038	02401038
.75"-1.99" (1.90-5.05)	950 (4,226)	2,060 (9,163)	4" (10.16)	13" (33.02)	02201039	02401039
1.00"-1.24" (2.54-3.15)	1,500 (6,672)	2,678 (11,912)	5" (12.70)	14" (35.56)	02201041	02401041
1.25"-1.49" (3.17-3.78)	1,500 (6,672)	4,490 (19,972)	5" (12.70)	15" (38.10)	02201042	02401042
1.50"-1.74" (3.81-4.42)	1,500 (6,672)	3,700 (16,458)	5" (12.70)	17" (43.18)	02201043	02401043
1.75"-1.99" (4.44-5.05)	2,000 (8,896)	4,375 (19,461)	6" (15.24)	19" (48.26)	02201044	02401044
2.00"-2.49" (5.08-6.32)	3,100 (13,789)	5,500 (24,465)	9" (22.86)	21" (53.34)	02201045	02401045
2.50"-2.99" (6.35-7.59)	3,100 (13,789)	—	9" (22.86)	23" (58.42)	02201046	—
3.00"-3.49" (7.62-8.86)	3,800 (16,902)	—	11" (27.94)	25" (63.50)	02201047	—
3.50"-3.99" (8.89-10.13)	3,250 (14,480)	—	11" (27.94)	27" (68.58)	02201048	—

### Offset Eye, Split Mesh, Lace Closing

For permanent support when cable end is not available.

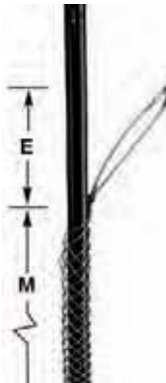

Cable Diameter Range Inches (cm)	Approx. Breaking Strength Lbs. (N)		E Inches (cm)	M Inches (cm)	Tin-Coated Bronze	Stainless Steel
	Tin-Coated Bronze	Stainless Steel				
.50"-1.24" (1.27-3.15)	500 (2,224)	1,370 (6,094)	4" (10.16)	10" (25.40)	02202037	02402037
.63"-1.49" (1.60-3.78)	750 (3,336)	1,952 (8,683)	4" (10.16)	10" (25.40)	02202038	02402038
.75"-1.99" (1.90-5.05)	950 (4,226)	2,060 (9,163)	4" (10.16)	13" (33.02)	02202039	02402039
1.00"-1.24" (2.54-3.15)	1,500 (6,672)	2,670 (11,877)	5" (12.70)	14" (35.56)	02202041	02402041
1.25"-1.49" (3.17-3.78)	1,500 (6,672)	4,490 (19,972)	5" (12.70)	15" (38.10)	02202042	02402042
1.50"-1.74" (3.81-4.42)	1,500 (6,672)	4,490 (19,972)	5" (12.70)	17" (43.18)	02202043	02402043
1.75"-1.99" (4.44-5.05)	1,800 (8,006)	4,375 (19,461)	6" (15.24)	19" (48.26)	02202044	02402044
2.00"-2.49" (5.08-6.32)	2,150 (9,563)	5,500 (24,465)	9" (22.86)	21" (53.34)	02202045	02402045
2.50"-2.99" (6.35-7.59)	2,150 (9,563)	5,500 (24,465)	9" (22.86)	23" (58.42)	02202046	02402046
3.00"-3.49" (7.62-8.86)	3,250 (14,480)	10,190 (45,327)	11" (27.94)	25" (63.50)	02202047	02402047
3.50"-3.99" (8.89-10.13)	3,250 (14,480)	—	11" (27.94)	27" (68.58)	02202048	—

### Offset Eye, Split Mesh, Rod Closing

For support when cable end is not available.

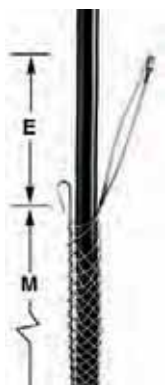

Cable Diameter Range Inches (cm)	Approx. Breaking Strength Lbs. (N)		E Inches (cm)	M Inches (cm)	Tin-Coated Bronze	Stainless Steel
	Tin-Coated Bronze	Stainless Steel				
.50"-1.24" (1.27-3.15)	500 (2,224)	1,000 (4,448)	4" (10.16)	7" (17.78)	02203037	02403037
.63"-1.49" (1.60-3.78)	750 (3,336)	1,950 (8,674)	4" (10.16)	9" (22.86)	02203038	02403038
.75"-1.99" (1.90-5.05)	950 (4,226)	1,950 (8,674)	4" (10.16)	10" (25.40)	02203039	02403039
1.00"-1.24" (2.54-3.15)	1,500 (6,672)	2,500 (11,121)	5" (12.70)	12" (30.48)	02203041	02403041
1.25"-1.49" (3.17-3.78)	1,500 (6,672)	4,200 (18,683)	5" (12.70)	14" (35.56)	02203042	02403042
1.50"-1.74" (3.81-4.42)	1,500 (6,672)	4,500 (20,017)	5" (12.70)	15" (38.10)	02203043	02403043
1.75"-1.99" (4.44-5.05)	2,000 (8,896)	4,375 (19,461)	6" (15.24)	16" (40.64)	02203044	02403044
2.00"-2.49" (5.08-6.32)	3,100 (13,789)	8,350 (37,143)	9" (22.86)	19" (48.26)	02203045	02403045
2.50"-2.99" (6.35-7.59)	3,100 (13,789)	—	9" (22.86)	20" (50.80)	02203046	—
3.00"-3.49" (7.62-8.86)	4,300 (19,126)	8,400 (37,365)	11" (27.94)	21" (53.34)	02203047	02403047
3.50"-3.99" (8.89-10.13)	4,900 (21,795)	—	11" (27.94)	21" (53.34)	02203048	—

Note: E-Eye length. M-Mesh length at nominal diameter.

**IMPORTANT**

Read all breaking strength, safety and technical data relating to this product. Pages V-41 to V-45.

**Universal Eye, Closed Mesh**

For permanent support when cable end is available to be installed through grip.

Cable Diameter Range Inches (cm)	Approx. Breaking Strength Lbs. (N)		E Inches (cm)	M Inches (cm)	Tin-Coated Bronze	Stainless Steel
	Tin-Coated Bronze	Stainless Steel				
.50"-.62" (1.27-1.57)	530 (2,357)	1,370 (6,094)	18" (45.72)	10" (25.40)	02201051	02401051
.63"-.74" (1.60-1.88)	790 (3,514)	2,060 (9,163)	18" (45.72)	10" (25.40)	02201052	02401052
.75"-.99" (1.90-2.51)	1,020 (4,537)	2,066 (9,190)	18" (45.72)	13" (33.02)	02201053	02401053
1.00"-1.24" (2.54-3.15)	1,610 (7,161)	—	18" (45.72)	14" (35.56)	02201050	—
1.25"-1.49" (3.17-3.78)	1,610 (7,161)	4,490 (19,972)	18" (45.72)	15" (38.10)	02201054	02401054
1.50"-1.74" (3.81-4.42)	1,610 (7,161)	4,490 (19,972)	18" (45.72)	17" (43.18)	02201055	02401055
1.75"-1.99" (4.44-5.05)	2,150 (9,563)	—	18" (45.72)	19" (48.26)	02201056	02401056
2.00"-2.49" (5.08-6.32)	3,260 (14,500)	—	18" (45.72)	21" (53.34)	02201057	02401057
2.50"-2.99" (6.35-7.59)	3,260 (14,500)	—	18" (45.72)	23" (58.42)	02201058	02401058



**Universal Eye, Split Mesh, Lace Closing**

For permanent support when cable end is not available.

Cable Diameter Range Inches (cm)	Approx. Breaking Strength Lbs. (N)		E Inches (cm)	M Inches (cm)	Tin-Coated Bronze	Stainless Steel
	Tin-Coated Bronze	Stainless Steel				
.50"-.62" (1.27-1.57)	530 (2,357)	—	18" (45.72)	10" (25.40)	02202050	—
.63"-.74" (1.60-1.88)	790 (3,514)	2,060 (9,163)	18" (45.72)	10" (25.40)	02202051	02402051
.75"-.99" (1.90-2.51)	1,020 (4,537)	—	18" (45.72)	13" (33.02)	02202052	—
1.00"-1.24" (2.54-3.15)	1,610 (7,161)	—	18" (45.72)	14" (35.56)	02202054	—
1.25"-1.49" (3.17-3.78)	1,610 (7,161)	—	18" (45.72)	15" (38.10)	02202055	—
1.50"-1.74" (3.81-4.42)	1,610 (7,161)	—	18" (45.72)	17" (43.18)	02202056	—
1.75"-1.99" (4.44-5.05)	2,150 (9,563)	—	18" (45.72)	19" (48.26)	02202057	—
2.00"-2.49" (5.08-6.32)	3,260 (14,500)	—	18" (45.72)	21" (53.34)	02202058	—
2.50"-2.99" (6.35-7.59)	3,260 (14,500)	—	18" (45.72)	23" (58.42)	02202059	—
3.50"-3.99" (8.89-10.13)	4,900 (21,795)	—	18" (45.72)	27" (68.58)	02202061	—



**Universal Eye, Split Mesh, Rod Closing**

For support when cable end is not available.

Cable Diameter Range Inches (cm)	Approx. Breaking Strength Lbs. (N)		E Inches (cm)	M Inches (cm)	Tin-Coated Bronze	Stainless Steel
	Tin-Coated Bronze	Stainless Steel				
.50"-.62" (1.27-1.57)	790 (3,514)	—	18" (45.72)	8.5" (21.59)	02203064	—
.63"-.74" (1.60-1.88)	790 (3,514)	2,050 (9,119)	18" (45.72)	8.5" (21.59)	02203065	02403065
.75"-.99" (1.90-2.51)	1,020 (4,537)	2,050 (9,119)	18" (45.72)	10.5" (26.67)	02203066	02403066
1.00"-1.24" (2.54-3.15)	1,610 (7,161)	2,650 (11,788)	18" (45.72)	12.5" (31.75)	02203068	02403068
1.25"-1.49" (3.17-3.78)	1,610 (7,161)	4,500 (20,017)	18" (45.72)	14.5" (36.83)	02203069	02403069
1.50"-1.74" (3.81-4.42)	1,610 (7,161)	4,500 (20,017)	18" (45.72)	15.5" (39.37)	02203070	02403070
1.75"-1.99" (4.44-5.05)	2,150 (9,563)	—	18" (45.72)	16.5" (41.91)	02203071	—
2.00"-2.49" (5.08-6.32)	3,260 (14,500)	—	18" (45.72)	19.5" (49.53)	02203072	—
2.50"-2.99" (6.35-7.59)	3,260 (14,500)	—	18" (45.72)	21.5" (54.61)	02203073	—
3.00"-3.49" (7.62-8.86)	5,750 (25,576)	—	18" (45.72)	23.5" (59.69)	02203074	—



Note: E-Eye length. M-Mesh length at nominal diameter.

**IMPORTANT**  
 Read all breaking strength, safety and technical data relating to this product. Pages V-41 to V-45.

### Heavy Duty, Single Eye, Closed Mesh

For heavy duty permanent support when cable end is available to be installed through grip.

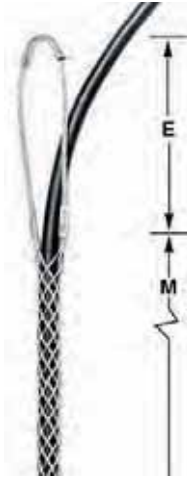

Cable Diameter Range Inches (cm)	Approx. Breaking Strength Lbs. (N)		E Inches (cm)	M Inches (cm)	Tin-Coated Bronze	Stainless Steel
	Tin-Coated Bronze	Stainless Steel				
.75"- .99" (1.90-2.51)	2,820 (12,543)	4,200 (18,683)	10" (25.40)	25" (63.50)	<b>02206010</b>	<b>02406010</b>
1.00"-1.24" (2.54-3.15)	4,280 (19,037)	7,300 (32,472)	12" (30.48)	28" (71.12)	<b>02206011</b>	<b>02406011</b>
1.25"-1.49" (3.17-3.78)	4,280 (19,037)	7,300 (32,472)	12" (30.48)	30" (76.20)	<b>02206012</b>	<b>02406012</b>
1.50"-1.99" (3.81-5.05)	4,280 (19,037)	11,150 (49,598)	12" (30.48)	34" (86.36)	<b>02206013</b>	<b>02406013</b>

### Single Eye, Split Mesh, Lace Closing

For permanent support when cable end is not available to be installed through grip.



Cable Diameter Range Inches (cm)	Approx. Breaking Strength Lbs. (N)		E Inches (cm)	M Inches (cm)	Tin-Coated Bronze	Stainless Steel
	Tin-Coated Bronze	Stainless Steel				
.75"- .99" (1.90-2.51)	2,820 (12,543)	4,200 (18,683)	10" (25.40)	25" (63.50)	<b>02207010</b>	<b>02407010</b>
1.00"-1.24" (2.54-3.15)	4,280 (19,037)	7,300 (32,472)	12" (30.48)	28" (71.12)	<b>02207011</b>	<b>02407011</b>
1.25"-1.49" (3.17-3.78)	4,280 (19,037)	7,300 (32,472)	12" (30.48)	30" (76.20)	<b>02207012</b>	<b>02407012</b>
1.50"-1.99" (3.81-5.05)	4,280 (19,037)	11,150 (49,598)	12" (30.48)	34" (86.36)	<b>02207013</b>	<b>02407013</b>

Note: E-Eye length. M-Mesh length at nominal diameter.

**IMPORTANT**

Read all breaking strength, safety and technical data relating to this product. Pages V-41 to V-45.

**Double Eye, Closed Mesh**

For permanent support when cable end is available to be installed through grip.

Cable Diameter Range Inches (cm)	Approx. Breaking Strength Lbs. (N)		E Inches (cm)	M Inches (cm)	Tin-Coated Bronze	Stainless Steel
	Tin-Coated Bronze	Stainless Steel				
.75"- .99" (1.90-2.51)	2,820 (12,543)	4,250 (18,905)	10" (25.40)	25" (63.50)	02206001	02406001
1.00"-1.24" (2.54-3.15)	4,280 (19,037)	7,300 (32,472)	10" (25.40)	28" (71.12)	02206002	02406002
1.25"-1.49" (3.17-3.78)	4,280 (19,037)	7,300 (32,472)	10" (25.40)	30" (76.20)	02206003	02406003
1.50"-1.99" (3.81-5.05)	4,280 (19,037)	11,100 (49,375)	10" (25.40)	34" (86.36)	02206004	02406004
2.00"-2.49" (5.08-6.32)	8,050 (35,806)	20,100 (89,409)	12" (30.48)	36" (91.44)	02206005	02406005
2.50"-2.99" (6.35-7.59)	8,050 (35,806)	20,100 (89,409)	12" (30.48)	38" (96.52)	02206006	02406006
3.00"-3.49" (7.62-8.86)	10,060 (44,747)	25,200 (112,095)	12" (30.48)	40" (101.60)	02206007	02406007
3.50"-3.99" (8.89-10.13)	12,070 (53,687)	—	12" (30.48)	44" (111.76)	02206008	—
4.00"-4.49" (10.16-11.40)	12,070 (53,687)	—	12" (30.48)	46" (116.84)	02206009	—
4.50"-4.99" (11.43-12.67)	12,070 (53,687)	—	12" (30.48)	68" (172.72)	02208009	—

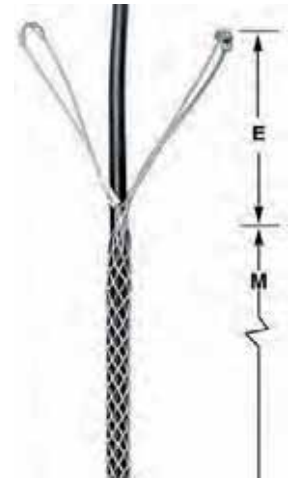

**Double Eye, Split Mesh, Lace Closing**

For support when cable end is not available.

Cable Diameter Range Inches (cm)	Approx. Breaking Strength Lbs. (N)		E Inches (cm)	M Inches (cm)	Tin-Coated Bronze	Stainless Steel
	Tin-Coated Bronze	Stainless Steel				
.75"- .99" (1.90-2.51)	2,820 (12,543)	4,250 (18,905)	10" (25.40)	25" (63.50)	02207001	02407001
1.00"-1.24" (2.54-3.15)	4,280 (19,037)	7,300 (32,472)	10" (25.40)	28" (71.12)	02207002	02407002
1.25"-1.49" (3.17-3.78)	4,280 (19,037)	7,300 (32,472)	10" (25.40)	30" (76.20)	02207003	02407003
1.50"-1.99" (3.81-5.05)	4,280 (19,037)	11,150 (49,598)	10" (25.40)	34" (86.36)	02207004	02407004
2.00"-2.49" (5.08-6.32)	8,050 (35,806)	20,150 (89,632)	12" (30.48)	36" (91.44)	02207005	02407005
2.50"-2.99" (6.35-7.59)	8,050 (35,806)	20,150 (89,632)	12" (30.48)	38" (96.52)	02207006	02407006
3.00"-3.49" (7.62-8.86)	10,060 (44,747)	25,200 (112,095)	12" (30.48)	40" (101.60)	02207007	02407007
3.50"-3.99" (8.89-10.13)	12,070 (53,687)	30,200 (134,336)	12" (30.48)	44" (111.76)	02207008	02407008
4.00"-4.49" (10.16-11.40)	12,070 (53,687)	30,200 (134,336)	12" (30.48)	46" (116.84)	02207009	02407009
4.50"-4.99" (11.43-12.67)	12,070 (53,687)	—	12" (30.48)	68" (172.72)	02209009	—

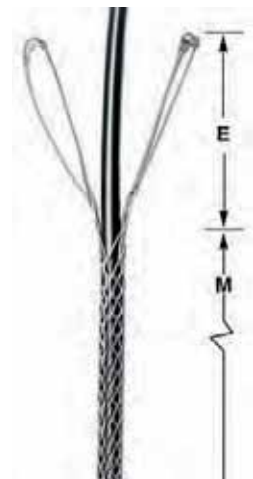

Note: E-Eye length. M-Mesh length at nominal diameter.

**IMPORTANT**  
 Read all breaking strength, safety and technical data relating to this product. Pages V-41 to V-45.

**Light Duty, Single Eye, Closed Mesh, Single Weave**

For permanent support when cable end is available to be installed.



Cable Diameter Range Inches (cm)	Approx. Breaking Strength Lbs. (N)		E Inches (cm)	M Inches (cm)	Tin-Coated Bronze	Stainless Steel
	Tin-Coated Bronze	Stainless Steel				
.23"-.31" (.58-.79)	290 (1,290)	700 (3,114)	3" (7.62)	3.75" (9.52)	02216001	02416001
.29"-.37" (.74-.94)	290 (1,290)	700 (3,114)	5" (12.70)	4.25" (10.79)	02216002	02416002
.35"-.44" (.89-1.12)	500 (2,224)	850 (3,781)	5.5" (13.97)	4.75" (12.06)	02216003	02416003
.41"-.50" (1.04-1.27)	500 (2,224)	850 (3,781)	5.5" (13.97)	5" (12.70)	02216004	02416004
.46"-.56" (1.17-1.42)	660 (2,936)	850 (3,781)	6" (15.24)	5.25" (13.33)	02216005	02416005
.52"-.62" (1.32-1.57)	790 (3,514)	1,050 (4,670)	7" (17.78)	6.25" (15.87)	02216006	02416006
.58"-.68" (1.47-1.73)	790 (3,514)	1,050 (4,670)	7" (17.78)	6" (15.24)	02216007	02416007
.64"-.75" (1.63-1.90)	790 (3,514)	1,050 (4,670)	7" (17.78)	6.75" (17.14)	02216008	02416008
.70"-.81" (1.78-2.06)	790 (3,514)	2,050 (9,119)	7" (17.78)	7.25" (18.41)	02216009	02416009
.75"-.87" (1.90-2.21)	1,020 (4,537)	2,050 (9,119)	8" (20.32)	8" (20.32)	02216010	02416010
.81"-.94" (2.06-2.39)	1,020 (4,537)	2,050 (9,119)	8" (20.32)	8.25" (20.95)	02216011	02416011
.87"-1.00" (2.21-2.54)	1,020 (4,537)	—	8" (20.32)	8.75" (22.22)	02216012	—
.94"-1.06" (2.39-2.69)	1,020 (4,537)	2,050 (9,119)	9" (22.86)	9" (22.86)	02216013	02416013
1.00"-1.18" (2.54-3.00)	1,020 (4,537)	2,050 (9,119)	9" (22.86)	9.5" (24.13)	02216014	02416014
1.06"-1.25" (2.69-3.17)	1,020 (4,537)	2,050 (9,119)	9" (22.86)	9.5" (24.13)	02216015	02416015

**Heavy Duty, Single Eye, Closed Mesh, Multi-Weave**

For permanent support when cable end is available to be installed.

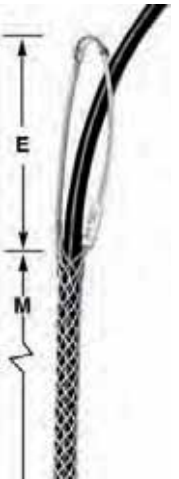

Cable Diameter Range Inches (cm)	Approx. Breaking Strength Lbs. (N)		E Inches (cm)	M Inches (cm)	Tin-Coated Bronze	Stainless Steel
	Tin-Coated Bronze	Stainless Steel				
.23"-.31" (.58-.79)	500 (2,224)	1,400 (6,228)	5" (12.70)	4.5" (11.43)	02217001	02417001
.29"-.37" (.74-.94)	500 (2,224)	1,150 (5,115)	5" (12.70)	5.5" (13.97)	02217002	02417002
.35"-.44" (.89-1.12)	870 (3,870)	1,700 (7,562)	6" (15.24)	6.5" (16.51)	02217003	02417003
.41"-.50" (1.04-1.27)	870 (3,870)	1,700 (7,562)	6" (15.24)	7.5" (19.05)	02217004	02417004
.46"-.56" (1.17-1.42)	1,050 (4,670)	2,100 (9,341)	6" (15.24)	8" (20.32)	02217005	02417005
.52"-.62" (1.32-1.57)	1,050 (4,670)	2,100 (9,341)	7" (17.78)	8.5" (21.59)	02217006	02417006
.58"-.68" (1.47-1.73)	1,050 (4,670)	2,100 (9,341)	7" (17.78)	9.5" (24.13)	02217007	02417007
.64"-.75" (1.63-1.90)	1,390 (6,183)	4,161 (18,509)	7" (17.78)	9.5" (24.13)	02217008	02417008
.70"-.81" (1.78-2.06)	1,390 (6,183)	4,100 (18,238)	8" (20.32)	10.5" (26.67)	02217009	02417009
.75"-.87" (1.90-2.21)	1,390 (6,183)	—	8" (20.32)	10.5" (26.67)	02217010	—
.81"-.94" (2.06-2.39)	1,390 (6,183)	—	8" (20.32)	10.5" (26.67)	02217011	—
.87"-1.00" (2.21-2.54)	1,790 (7,962)	5,350 (23,798)	8" (20.32)	11.5" (29.21)	02217012	02417012
.94"-1.06" (2.39-2.69)	1,790 (7,962)	5,300 (23,576)	9" (22.86)	12.5" (31.75)	02217013	02417013
1.00"-1.18" (2.54-3.00)	1,790 (7,962)	5,300 (23,576)	9" (22.86)	13.5" (34.29)	02217014	02417014
1.06"-1.25" (2.69-3.17)	1,790 (7,962)	5,350 (23,798)	9" (22.86)	14.5" (36.83)	02217015	02417015

Note: E-Eye length. M-Mesh length at nominal diameter.

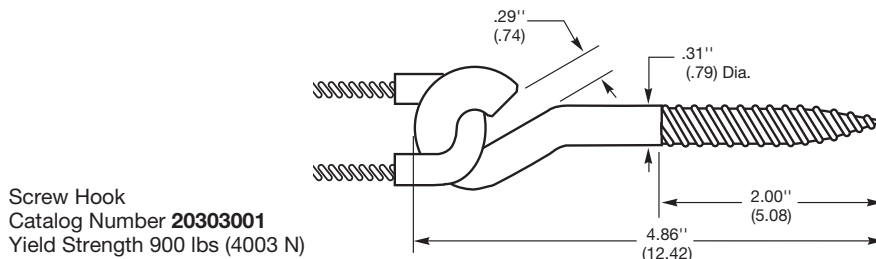



**IMPORTANT**

Read all breaking strength, safety and technical data relating to this product. Pages V-41 to V-45.

**Light Duty, Universal Eye, Closed Mesh, Single Weave**

For permanent support when cable end is available to be installed.

Cable Diameter Range Inches (cm)	Approx. Breaking Strength Lbs. (N)	E Inches (cm)	M Inches (cm)	Catalog Number
.23"-.31" (.58-.79)	290 (1,290)	9" (22.86)	3.75" (9.52)	02216016
.29"-.37" (.74-.94)	290 (1,290)	10" (25.40)	4.25" (10.79)	02216017
.35"-.44" (.89-1.12)	500 (2,224)	10" (25.40)	4.75" (12.06)	02216018
.41"-.50" (1.04-1.27)	500 (2,224)	11" (27.94)	5" (12.70)	02216019
.46"-.56" (1.17-1.42)	660 (2,936)	12" (30.48)	5.25" (13.33)	02216020
.52"-.62" (1.32-1.57)	790 (3,514)	13" (33.02)	6.25" (15.87)	02216021
.58"-.68" (1.47-1.73)	790 (3,514)	13" (33.02)	6.5" (16.51)	02216022
.64"-.75" (1.63-1.90)	790 (3,514)	13" (33.02)	6.75" (17.14)	02216023
.70"-.81" (1.78-2.06)	790 (3,514)	13" (33.02)	7.25" (18.41)	02216024
.75"-.87" (1.90-2.21)	1,020 (4,537)	14" (35.56)	8" (20.32)	02216025
.81"-.94" (2.06-2.39)	1,020 (4,537)	14" (35.56)	8.25" (20.95)	02216026
.87"-1.00" (2.21-2.54)	1,020 (4,537)	14" (35.56)	8.75" (22.22)	02216027
.94"-1.06" (2.39-2.69)	1,020 (4,537)	15" (38.10)	9" (22.86)	02216028
1.00"-1.18" (2.54-3.00)	1,020 (4,537)	15" (38.10)	9.5" (24.13)	02216029
1.06"-1.25" (2.69-3.17)	1,020 (4,537)	15" (38.10)	9.5" (24.13)	02216030



**Heavy Duty, Universal Eye, Closed Mesh, Multi-Weave**

For permanent support when cable end is available to be installed.

Cable Diameter Range Inches (cm)	Approx. Breaking Strength Lbs. (N)	E Inches (cm)	M Inches (cm)	Catalog Number
.23"-.31" (.58-.79)	500 (2,224)	11" (27.94)	4.5" (11.43)	02217016
.28"-.37" (.74-.94)	500 (2,224)	11" (27.94)	5.5" (13.97)	02217017
.35"-.44" (.89-1.12)	870 (3,870)	12" (30.48)	6.5" (16.51)	02217018
.41"-.50" (1.04-1.27)	870 (3,870)	12" (30.48)	7.5" (19.05)	02217019
.46"-.56" (1.17-1.42)	1,050 (4,670)	12" (30.48)	8" (20.32)	02217020
.52"-.62" (1.32-1.57)	1,050 (4,670)	13" (33.02)	8.5" (21.59)	02217021
.58"-.68" (1.47-1.73)	1,050 (4,670)	13" (33.02)	9.5" (24.13)	02217022
.64"-.75" (1.63-1.90)	1,390 (6,183)	13" (33.02)	9.5" (24.13)	02217023
.70"-.81" (1.78-2.06)	1,390 (6,183)	14" (35.56)	10.5" (26.67)	02217024
.75"-.87" (1.90-2.21)	1,390 (6,183)	14" (35.56)	10.5" (26.67)	02217025
.81"-.94" (2.06-2.39)	1,390 (6,183)	14" (35.56)	10.5" (26.67)	02217026
.87"-1.00" (2.21-2.54)	1,790 (7,962)	14" (35.56)	11.5" (29.21)	02217027
.94"-1.06" (2.39-2.69)	1,790 (7,962)	15" (38.10)	12.5" (31.75)	02217028
1.00"-1.18" (2.54-3.00)	1,790 (7,962)	15" (38.10)	13.5" (34.29)	02217029
1.06"-1.25" (2.69-3.17)	1,790 (7,962)	15" (38.10)	14.5" (36.83)	02217030



Note: E-Eye length. M-Mesh length at nominal diameter.

**IMPORTANT**

Read all breaking strength, safety and technical data relating to this product. Pages V-41 to V-45.



**Safety Spring**

Maximum Deflection Inches/Lbs (cm/N)	Approx. Breaking Strength Lbs. (N)	Length* Inches (cm)	Diameter Inches (cm)	Model Lbs. (N)	Catalog Number
2¾" at 40 lbs. (6.98 at 178)	500 (2,224)	8.25" (20.95)	.75" (1.90)	40 lb. spring (178)	<b>20302001</b>
3½" at 80 lbs. (7.94 at 356)	850 (3,781)	8.25" (20.95)	1" (2.54)	80 lb. spring (356)	<b>20302002</b>

Note: Springs can be used with single eye grips by disassembling drawbar from coil, placing through eye and replacing drawbar.  
 \*No load.



**Single Eye, Wide Range**

Cable Diameter Range Inches (cm)	Approx. Breaking Strength Lbs. (N)	E Inches (cm)	M Inches (cm)	Catalog Number
.24"-.32" (.61-.81)	350 (1,557)	3" (7.62)	3.5" (8.89)	<b>073041276**</b>
.32"-.43" (.81-1.09)	450 (2,002)	4" (10.16)	4" (10.16)	<b>073041277</b>
.43"-.56" (1.09-1.42)	550 (2,446)	6" (15.24)	4.75" (12.06)	<b>073041278</b>
.56"-.73" (1.42-1.85)	1,000 (4,448)	7" (17.78)	6" (15.24)	<b>073041279</b>
.73"-.85" (1.85-2.16)	1,400 (6,227)	7" (17.78)	6.75" (17.14)	<b>073041280</b>
.85"-1.00" (2.16-2.54)	1,400 (6,227)	8" (20.32)	8" (20.32)	<b>073041281</b>
1.00"-1.25" (2.54-3.17)	1,500 (6,672)	9" (22.86)	9.5" (24.13)	<b>073041282</b>



**Universal Eye, Wide Range**

Cable Diameter Range Inches (cm)	Approx. Breaking Strength Lbs. (N)	E Inches (cm)	M Inches (cm)	Catalog Number
.32"-.43" (.81-1.09)	450 (2,002)	10" (25.40)	4" (10.16)	<b>073041284</b>
.43"-.56" (1.09-1.42)	550 (2,446)	12" (30.48)	4.75" (12.06)	<b>073041285</b>
.56"-.73" (1.42-1.85)	1,000 (4,448)	13" (33.02)	6" (15.24)	<b>073041286</b>
.73"-.85" (1.85-2.16)	1,400 (6,227)	13" (33.02)	6.75" (17.14)	<b>073041287</b>
.85"-1.00" (2.16-2.54)	1,400 (6,227)	14" (35.56)	8" (20.32)	<b>073041288</b>
1.00"-1.25" (2.54-3.17)	1,500 (6,672)	15" (38.10)	9.5" (24.13)	<b>073041289</b>

Note: E-Eye length. M-Mesh length at nominal diameter.  
 \*\*Item indicated is not UL listed.

**Bus Drop Grips and Safety Springs**

Kellems Bus Drop Grips are offered with either a single eye or universal bale attachment. The mesh is single weave galvanized steel with the patented wide range construction. They are suitable for indoor use only. Consult Technical Service for Stainless Steel Grips.

**Application**

Bus Drop Grips provide a safe, easy and economical method to support flexible cord or bus drop cable at bus duct and other industrial areas.

**Benefits**

- Easily installed.
- Absorb tension, vibration and pull with no cable damage.
- Patented mesh construction.

**Safety Spring**

Springs can be used with single eye grips by disassembling drawbar from coil, placing through eye and replacing drawbar.

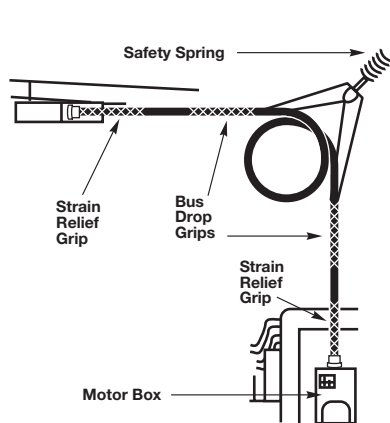

**Single Weave, Closed Mesh**

Kellems® Conduit Riser Support Grips are available in closed mesh and in split mesh with lace or rod closures, to cover all applications including single cable or multiple wire support. Refer to page V-45 for grip selection assistance for cable bundles. The standard material is tin-coated bronze strand. The grip is permanently fastened to a support ring, resulting in a one piece unit which will allow air ventilation within the conduit. The ring will fit standard electrical rigid metal conduit and schedule 40 rigid PVC conduit only. See page V-40 for ring dimensions. For permanent support when cable end is available to be installed through the grip.

**IMPORTANT**  
 Read all breaking strength, safety and technical data relating to this product. Pages V-41 and V-45.



**Suitable For Standard Electrical Rigid Metal Conduit and Schedule 40 Rigid PVC Conduit Only**

Cable Sizes In. (cm)	.50"- .62" (1.27-1.57)	.63"- .74" (1.60-1.88)	.75"- .99" (1.90-2.51)	1.00"- 1.24" (2.54-3.15)	1.25"- 1.49" (3.17-3.78)	1.50"-1.74" (3.81-4.42)	1.75"-1.99" (4.44-5.05)	2.00"- 2.49" (5.08-6.32)	2.50"-2.99" (6.35-7.59)	3.00"- 3.49" (7.62-8.86)	3.50"- 3.99" (8.89-10.13)
Model	<b>R050</b>	<b>R062</b>	<b>R075</b>	<b>R100</b>	<b>R125</b>	<b>R150</b>	<b>R175</b>	<b>R200</b>	<b>R250</b>	<b>R300</b>	<b>R350</b>
Length In. (cm)	8" (20.32)	9" (22.86)	11" (27.94)	12" (30.48)	12" (30.48)	14" (35.56)	15" (38.10)	17" (43.18)	18" (45.72)	20" (50.80)	21" (53.34)
Conduit Sizes Inches	Catalog Number Approx. Breaking Strength Lbs. (N)										
¾	<b>02211106</b> 530 (2,357)	—	—	—	—	—	—	—	—	—	—
1	<b>02211100</b> 490 (2,179)	<b>02211101</b> 790 (3,514)	—	—	—	—	—	—	—	—	—
1¼	<b>02211001</b> 450 (2,002)	<b>02211002</b> 740 (3,292)	<b>02211003</b> 1,030 (4,581)	—	—	—	—	—	—	—	—
1½	—	<b>02211006</b> 690 (3,069)	<b>02211007</b> 970 (4,315)	<b>02211009</b> 1,610 (7,161)	—	—	—	—	—	—	—
2	—	<b>02211107</b> 640 (2,847)	<b>02211010</b> 920 (4,092)	<b>02211012</b> 1,520 (6,761)	<b>02211013</b> 1,610 (7,161)	—	—	—	—	—	—
2½	—	—	—	—	<b>02211017</b> 1,510 (6,716)	<b>02211018</b> 1,610 (7,161)	<b>02211019</b> 2,150 (9,563)	—	—	—	—
3	—	—	—	<b>02211022</b> 1,340 (5,960)	<b>02211023</b> 1,400 (6,227)	<b>02211024</b> 1,490 (6,627)	<b>02211025</b> 1,990 (8,851)	<b>02211026</b> 3,260 (14,500)	—	—	—
3½	—	—	—	—	—	—	—	<b>02211033</b> 2,970 (13,211)	<b>02211034</b> 3,260 (14,500)	—	—
4	—	—	—	—	—	—	<b>02211040</b> 1,670 (7,248)	<b>02211041</b> 2,680 (11,921)	<b>02211042</b> 2,890 (12,855)	<b>02211043</b> 4,080 (18,148)	—
5	—	—	—	—	—	—	—	—	<b>02211061</b> 2,150 (9,563)	<b>02211062</b> 2,860 (12,721)	<b>02211063</b> 3,130 (13,922)
6	—	—	—	—	—	—	—	—	—	<b>02211072</b> 2,245 (9,986)	<b>02211073</b> 2,245 (9,986)

Note: See page V-45 for multiple cables in a single conduit riser grip.



**Double Weave, Split Mesh, Lace Closing**

Kellems® Conduit Riser Support Grips will support cable runs in vertical or sloping standard rigid conduit. The grip is fastened to a support ring which seats on the rim of the conduit. The entire grip is supported by the conduit itself and no other hardware is required. See page V-40 for ring dimensions. The rings will fit schedule 40 rigid PVC conduit and standard electrical rigid metal conduit only. For permanent support when cable end is not available.

**IMPORTANT**  
 Read all breaking strength, safety and technical data relating to this product. Pages V-41 and V-45.



**Suitable For Standard Electrical Rigid Metal Conduit and Schedule 40 Rigid PVC Conduit Only**

Cable Sizes In. (cm)	.75" - .99" (1.90-2.51)	1.00" - 1.24" (2.54-3.15)	1.25" - 1.49" (3.17-3.78)	1.50" - 1.74" (3.81-4.42)	1.75" - 1.99" (4.44-5.05)	2.00" - 2.49" (5.08-6.32)	2.50" - 2.99" (6.35-7.59)	3.00" - 3.49" (7.62-8.86)	3.50" - 3.99" (8.89-10.13)
Model	RS075	RS100	RS125	RS150	RS175	RS200	RS250	RS300	RS350
Length In. (cm)	11" (27.94)	12" (30.48)	12" (30.48)	14" (35.56)	15" (38.10)	17" (43.18)	18" (45.72)	20" (50.80)	21" (53.34)
Conduit Sizes Inches	Catalog Number Approx. Breaking Strength Lbs. (N)								
1¼	02212003 1,580 (7,028)	—	—	—	—	—	—	—	—
1½	02212007 1,500 (6,672)	—	—	—	—	—	—	—	—
2	02212010 1,430 (6,361)	02212012 1,930 (8,585)	02212013 2,040 (9,074)	—	—	—	—	—	—
2½	—	—	02212017 1,910 (8,496)	02212018 2,040 (9,074)	—	—	—	—	—
3	—	—	02212023 1,780 (7,917)	02212024 1,890 (8,407)	02212025 2,520 (11,209)	02212026 4,300 (19,126)	—	—	—
3½	—	—	—	—	—	02212033 3,910 (17,392)	02212034 4,300 (19,126)	—	—
4	—	—	—	—	02212040 2,110 (9,385)	02212041 3,530 (15,701)	02212042 3,820 (16,991)	02212043 5,380 (23,930)	—
5	—	—	—	—	—	—	02212061 2,860 (12,721)	—	—
6	—	—	—	—	—	—	—	—	02212073 2,955 (13,144)

Note: See page V-45 for multiple cables in a single conduit riser grip.

### Single Weave, Split Mesh, Rod Closing Benefits

- Easy and fast to install.
- Will not damage electrical cable.
- Allows cable to expand or contract.
- Ideal way to hold cable in vertical conduit.
- Prevents cable creep in conduit.
- Helps prevent cable pullouts.
- The rings will fit schedule 40 rigid PVC conduit and standard electrical rigid metal conduit only.
- For support when cable end is not available.

### IMPORTANT

Read all breaking strength, safety and technical data relating to this product. Pages V-41 and V-45.



### Suitable For Standard Electrical Rigid Metal Conduit and Schedule 40 Rigid PVC Conduit Only

Cable Sizes In. (cm)	.75" - .99" (1.90-2.51)	1.00" - 1.24" (2.54-3.15)	1.25" - 1.49" (3.17-3.78)	1.50" - 1.74" (3.81-4.42)	1.75" - 1.99" (4.44-5.05)	2.00" - 2.49" (5.08-6.32)	2.50" - 2.99" (6.35-7.59)	3.00" - 3.49" (7.62-8.86)	3.50" - 3.99" (8.89-10.13)
Model	RR075	RR100	RR125	RR150	RR175	RR200	RR250	RR300	RR350
Length In. (cm)	11" (27.94)	12" (30.48)	12" (30.48)	14" (35.56)	15" (38.10)	17" (43.18)	18" (45.72)	20" (50.80)	21" (53.34)
Conduit Sizes Inches	Catalog Number Approx. Breaking Strength Lbs. (N)								
1¼	<b>02213003</b> 1,020 (4,537)	—	—	—	—	—	—	—	—
1½	<b>02213007</b> 970 (4,315)	<b>02213009</b> 1,610 (7,161)	—	—	—	—	—	—	—
2	—	<b>02213012</b> 1,520 (6,761)	<b>02213013</b> 1,610 (7,161)	—	—	—	—	—	—
2½	—	—	<b>02213017</b> 1,510 (6,716)	<b>02213018</b> 1,610 (7,161)	—	—	—	—	—
3	—	—	<b>02213023</b> 1,400 (6,227)	<b>02213024</b> 1,490 (6,627)	<b>02213025</b> 1,990 (8,851)	<b>02213026</b> 3,260 (14,500)	—	—	—
3½	—	—	—	—	—	<b>02213033</b> 2,970 (13,211)	—	—	—
4	—	—	—	—	—	<b>02213041</b> 2,670 (11,876)	<b>02213042</b> 2,890 (12,855)	—	—

Note: See page V-45 for multiple cables in a single conduit riser grip.

# Conduit Riser Grips

Conduit Riser Support Grip-Ring Dimensions

## Conduit Ring Dimensions

Ring dimensions are found in the chart below. The ring material is corrosion resistant. These rings will fit schedule 40 rigid PVC conduit and standard electrical rigid metal conduit only.

**IMPORTANT**  
 Read all breaking strength, safety and technical data relating to this product. Pages V-41 to V-45.

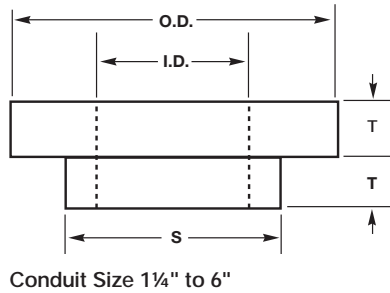
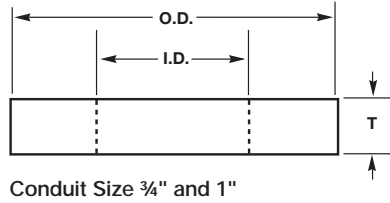

Conduit Size Inches	Ring Number	O.D. Inches (cm)	I.D. Inches (cm)	S Inches (cm)	T Inches (cm)
3/4	C-3/4	.94" (2.39)	.62" (1.57)	—	.19" (.48)
1	C-1	1.17" (2.97)	.80" (2.03)	—	.19" (.48)
1 1/4	C-1 1/4	1.50" (3.81)	1.03" (2.62)	1.31" (3.33)	.16" (.41)
1 1/2	C-1 1/2	1.76" (4.47)	1.23" (3.12)	1.52" (3.86)	.16" (.41)
2	C-2	2.23" (5.66)	1.55" (3.94)	1.97" (5.00)	.16" (.41)
2 1/2	C-2 1/2	2.67" (6.78)	2.05" (5.21)	2.40" (6.10)	.16" (.41)
3	C-3	3.20" (8.13)	2.55" (6.48)	2.97" (7.54)	.22" (.56)
3 1/2	C-3 1/2	3.80" (9.65)	3.05" (7.75)	3.47" (8.81)	.22" (.56)
4	C-4	4.30" (10.92)	3.55" (9.02)	3.94" (10.01)	.22" (.56)
4 1/2	C-4 1/2	4.80" (12.19)	4.03" (10.24)	4.45" (11.30)	.22" (.56)
5	C-5	5.30" (13.46)	4.46" (11.33)	4.96" (12.60)	.22" (.56)
6	C-6	6.30" (16.00)	5.36" (13.61)	5.96" (15.14)	.25" (.63)

## Kellems® Support Grips

Kellems Support Grips are used to hold the weight of electrical cable as it hangs in a vertical, sloping or horizontal position. Electrical cable must be supported, or its dead weight can cause excessive strain or pullout at the connections resulting in power failure. Support grips also absorb additional strain from flexure, vibration, expansion and contraction. Kellems Support Grips listed in this catalog are made of high grade, non-magnetic tin-coated bronze strand. Stainless steel grips, made of alloy 302–304 SST for severe service or unusual environmental conditions, are available on request.

### Select the Correct Support Grip

Each Kellems grip is designed to work on a specific range of cable diameters.

- Step 1** Refer to the Kellems chart below to determine the grip style best suited for your application.

---

- Step 2** Determine your cable outside diameter.

---

- Step 3** Find the grip size that encompasses your cable diameter.

---

- Step 4** Whenever possible, use a closed mesh that assembles over the cable end. If the cable end is not available, use a split mesh.

---

- Step 5** Where available, select an eye style that suits your needs.

---

- Step 6** Select the proper material—tinned bronze or stainless steel\*.

---

- Step 7** Estimate the tension to be put on the grip, establish the working load you require and compare this to the listed approximate breaking strength of the grip to insure that the grip will be strong enough. Refer to page V-42 for safety and working load considerations.

**CAUTION:** It is very important to comply with all of the following precautions.

1. Support grips are to be installed by a qualified individual in accordance with all applicable national and local safety, electrical and rigging codes.
2. Ensure that the correct grip is selected for your specific needs.
3. Do not use a support grip for any application other than supporting cable.
4. Thoroughly examine the grip for damage. Do not use a damaged grip.
5. Ensure that the recommended work load of the grip is suitable for the application. Never use grips at their approximated rated breaking strength. A safety factor of 10 is recommended for support grips.
6. Do not alter grips in any way. For example, do not flatten, straighten, bend or otherwise modify eye tubes, hooks, and strand equalizers.
7. Do not attach any type of hook, clamp or other hardware directly to the stranded bale of a “U” eye support grip. The formed eye tube is the only acceptable means of attachment to external hardware.
8. Always apply 2 bands at 1" and 2" respectively, from the tail end of the mesh to guard against accidental release of the grip. Accidental release can occur if an object contracts and pushes against the tail end of the mesh, thereby expanding and releasing it's hold.

### Support Grip Selection Chart

Grip Styles	Application	Page
Closed mesh	Standard, permanent support, cable end available.	V-28 to V-36
Split lace closing	Standard, permanent support, cable end unavailable.	V-28 to V-33
Split rod closing	Standard, temporary support, cable end unavailable. Tape or band tail end of wire mesh grip after positioning for permanent support.	V-28 to V-31
Material*	Tin-coated bronze standard or stainless steel by special request.	V-28 to V-34
Standard support grips	Support vertical runs to 99 ft. loads to 600 lbs.	V-28 to V-31
Heavy duty grips	Support vertical runs over 100 ft. loads over 600 lbs.	V-32, V-33
Service drop	Light duty to support service entrance cable.	V-34, V-35
Bus drop	Light duty support, indoors only, on Bus drop cable.	V-36
Conduit riser	Support cable runs in rigid (Schedule 40) conduit.	V-37 to V-39
Fiber optic cable support grips	Support fiber optic cable.	V-50

*Note: \*Most catalog listed support grips are made of tin-coated bronze strand. To order stainless steel support grips, change the first three catalog number digits from 022-0x-xxx to 024-0x-xxx. Consult Technical Service for details.*

### Eye Styles

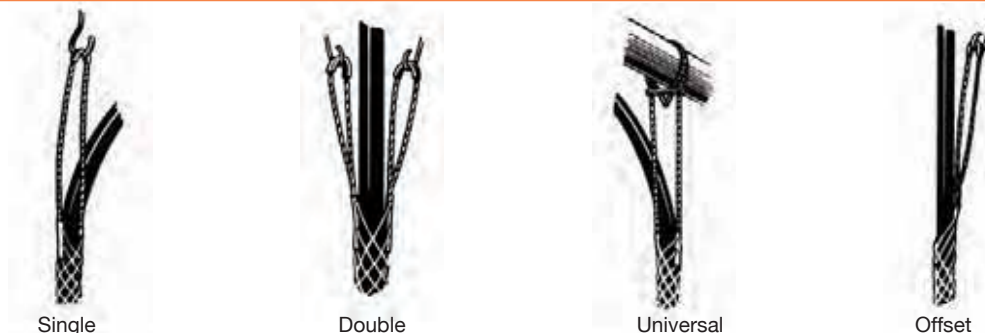

## Safety And Working Load Factors For Wire Mesh Grips

The broad application of Kellems grips on a wide variety of objects requires that adequate safety factors be used to establish working loads. The approximate breaking strength of a Kellems grip represents an average calculation based on data established from actual direct tension testing done in our engineering laboratories.

It is impossible to catalog or guarantee a safety factor suitable for all applications as operating conditions are never the same. The tension, diameter, movement, number of objects gripped, gripping surface, and the attachments used are just some of the factors which vary with each application. These factors, together with the effects of abrasion, corrosion, prior use or abuse and any other variables of a specific application, must be considered by the user and

the grip replaced as appropriate. Where the conditions of the application are not well defined or known, or where risk of injury to persons or property is involved, a greater safety factor should be utilized.

**Under normal conditions, Kellems' recommended factor of safety is five for catalog listed pulling grips, and ten for catalog listed support grips.**

Any warranty as to quality, performance or fitness for use of grips is always premised on the condition that the published breaking strengths apply only to new, unused grips, and that such products are properly stored, handled, used, maintained, and inspected by the user at a frequency appropriate for the use and condition of the grip.

## Examples

Grip Style	Approx. Breaking Strength Lbs. (N)	Safety Factor	Max. Recommended Load Lbs. (N)	Catalog Number
Pulling Grips	27,200 (120,986)	5	5,440 (24,197)	<b>03301027</b>
Support Grips	1,610 (7,161)	10	161 (716)	<b>02202019</b>

The maximum recommended working load is the tension to be exerted on the grip in application with a margin of safety to take care of unforeseen and unusual circumstances.

It is the end-user's decision to determine how much of a safety factor is acceptable for the application.

The metric unit of measure (force) for breaking strength and load is newtons (N). To convert from newtons to the metric unit of weight (kilograms) the conversion factor is 9.808 newtons/kilogram.

## Support Grip Materials

Material	Features	Grip Type
Tin-coated bronze wire	<ul style="list-style-type: none"> <li>• Corrosion resistant for normal outside areas</li> <li>• Non-magnetic</li> <li>• Moderate strength</li> </ul>	<ul style="list-style-type: none"> <li>• Support grips</li> <li>• Service drop grips</li> <li>• Conduit riser grips</li> </ul>
Stainless steel wire (302-304)	<ul style="list-style-type: none"> <li>• High strength</li> <li>• Corrosion resistant</li> </ul>	<ul style="list-style-type: none"> <li>• Support grips</li> <li>• Hose containment grips</li> </ul>
Galvanized steel wire	<ul style="list-style-type: none"> <li>• Slightly magnetic</li> <li>• Not subject to continuous outside environment</li> </ul>	<ul style="list-style-type: none"> <li>• Bus drop grips</li> </ul>

## Approvals

CSA Certifications are indicated on appropriate product catalog pages.

*Note: It is always recommended that the tail end of the grip be banded after the installation on the cable to prevent accidental release of the mesh. See page V-15 for end bands.*



### Split Support Grip Lace Closing Instructions

Single Weave Grips should be laced with single strand lacing; double weave with double strand. Lacing strands should be the same material as the grip. Kellems supplies the appropriate lacing with each grip.

1. Start the lacing at the lead or anchoring end of the grip. Thread the lacings through the first two loops of the split and pull through until the lacings are centered at this point. Lace as you would your shoe, crossing the lacings before lacing the next two loops.
2. Don't pull lacing too tight. Leave a space between adjoining loops approximately equal to the width of one diamond of the mesh.
3. Twist the lacing strands tightly together at the tail end of the grip.
4. Wrap the ends of the lacings once or twice tightly around the tail of the grip, twisting the ends together securely. Excess lace can be cut off.



### Split Support Grip Rod Closing Instructions

The stainless steel rod is a precise built-in feature which makes threading easy and fast. The strands of the mesh pass around the rod and match up with the strands from the opposite direction. The rod does not touch the cable at any point and therefore cannot cut the cable. Rod Closing Grips are reusable. They may be removed and reused as many times as desired.

#### 1. Fast to install

Wrap the grip around the cable and thread the rod through the pre-formed loops with a corkscrew motion, using the curved end of the rod to engage the loops.

2. The action required is a steady push and twist simultaneously. The fingers of the left hand are used to bring the loops together just ahead of the hook on the end of the rod.
3. To remove, simply pull the rod out.



## For Support Grips Only\*

### Multiple Cable Selection Charts for Cables and Wires of Unequal Diameters

#### How to choose the correct grip size:

1. Find the Grip Circumference Range by measuring the circumference of the bundle of different diameter cables to be gripped (see illustration).
2. Divide the bundle circumference by 3.14 to determine the diameter.
3. Choose a grip offering a range of cable diameters the same as the cable diameter.

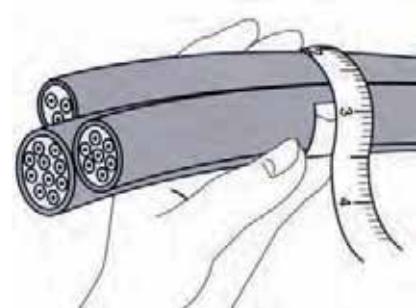

### For Cables of Equal Diameters

Under "Number of Cables in One Grip", find the diameter of your single cable in vertical column. Read the grip diameter range to the right.

If your diameter is the maximum of the range shown, go to the next larger size for Split Grips, stay with the same size for Closed Grips.

**Example:** 3 cables, each with .89" (2.26) diameter, for a Closed Grip select the 1.50"-1.74" (3.81-4.42) range, for a Split Grip select the 1.75"-1.99" (4.44-5.05) range.

### Number of Cables in One Grip

2	3	4	5	6 and 7	8	9	Grip Dia. Range Inches (cm)
.30-.38 (.76-.97)	.25-.31 (.63-.79)	.22-.27 (.56-.69)	.19-.24 (.48-.61)	.17-.22 (.43-.56)	.15-.19 (.38-.48)	.14-.18 (.36-.46)	.50-.61 (1.27-1.55)
.38-.44 (.97-1.12)	.31-.36 (.79-.91)	.27-.31 (.69-.79)	.24-.29 (.61-.74)	.22-.26 (.56-.66)	.19-.23 (.48-.58)	.18-.21 (.46-.53)	.62-.74 (1.57-1.88)
.44-.59 (1.12-1.50)	.36-.49 (.91-1.24)	.31-.42 (.79-1.07)	.29-.38 (.74-.97)	.26-.34 (.66-.86)	.23-.31 (.58-.79)	.21-.28 (.53-.71)	.75-.99 (1.90-2.51)
.59-.75 (1.50-1.90)	.49-.63 (1.24-1.60)	.42-.54 (1.07-1.37)	.38-.48 (.97-1.22)	.34-.43 (.86-1.09)	.31-.39 (.79-.99)	.28-.35 (.71-.89)	1.00-1.24 (2.54-3.15)
.75-.90 (1.90-2.29)	.63-.76 (1.60-1.93)	.54-.65 (1.37-1.65)	.48-.58 (1.22-1.47)	.43-.52 (1.09-1.32)	.39-.46 (.99-1.17)	.35-.42 (.89-1.07)	1.25-1.49 (3.17-3.78)
.90-1.07 (2.29-2.72)	.76-.89 (1.93-2.26)	.65-.77 (1.65-1.96)	.58-.67 (1.47-1.70)	.52-.60 (1.32-1.52)	.46-.54 (1.17-1.37)	.42-.49 (1.07-1.24)	1.50-1.74 (3.81-4.42)
1.07-1.22 (2.72-3.10)	.89-1.02 (2.26-2.59)	.77-.88 (1.96-2.24)	.67-.77 (1.70-1.96)	.60-.69 (1.52-1.75)	.54-.62 (1.37-1.57)	.49-.56 (1.24-1.42)	1.75-1.99 (4.44-5.05)
1.22-1.53 (3.10-3.89)	1.02-1.28 (2.59-3.25)	.88-1.10 (2.24-2.79)	.77-.96 (1.96-2.44)	.69-.86 (1.75-2.18)	.62-.77 (1.57-1.96)	.56-.71 (1.42-1.80)	2.00-2.49 (5.08-6.32)
1.53-1.83 (3.89-4.65)	1.28-1.53 (3.25-3.89)	1.10-1.32 (2.79-3.35)	.96-1.16 (2.44-2.95)	.86-1.03 (2.18-2.62)	.77-.93 (1.96-2.36)	.71-.85 (1.80-2.16)	2.50-2.99 (6.35-7.59)
1.83-2.14 (4.65-5.44)	1.53-1.79 (3.89-4.55)	1.32-1.54 (3.35-3.91)	1.16-1.35 (2.95-3.43)	1.03-1.20 (2.62-3.05)	.93-1.08 (2.36-2.74)	.85-.99 (2.16-2.51)	3.00-3.49 (7.62-8.86)
2.14-2.44 (5.44-6.20)	1.79-2.05 (4.55-5.21)	1.54-1.76 (3.91-4.47)	1.35-1.54 (3.43-3.91)	1.20-1.37 (3.05-3.48)	1.08-1.24 (2.74-3.15)	.99-1.13 (2.51-2.87)	3.50-3.99 (8.89-10.13)
2.44-2.75 (6.20-6.98)	2.05-2.30 (5.21-5.84)	1.76-1.98 (4.47-5.03)	1.54-1.74 (3.91-4.42)	1.37-1.55 (3.48-3.94)	1.24-1.39 (3.15-3.53)	1.13-1.27 (2.87-3.23)	4.00-4.49 (10.16-11.40)
2.75-3.06 (6.98-7.77)	2.30-2.56 (5.84-6.50)	1.98-2.20 (5.03-5.59)	1.74-1.93 (4.42-4.90)	1.55-1.72 (3.94-4.37)	1.39-1.55 (3.53-3.94)	1.27-1.41 (3.23-3.58)	4.50-4.99 (11.43-12.67)

*Note: \*This chart is to be used for determining grip size when multiple cables are held in a single Support Grip. For Conduit Riser multiple cable selection, see page V-45. It is always recommended that, when multiple cables are installed in a Support Grip, the tail end of the grip be banded after installation on the cable bundle. See page Tech-23 for cable and wire charts.*

## For Conduit Riser Grips Only\*

### Multiple Cable Selection Charts for Cables and Wires of Unequal Diameters

#### How to choose the correct grip size:

1. Find the Grip Circumference Range by measuring the circumference of the bundle of different diameter cables to be gripped (see illustration).
2. Divide the bundle circumference by 3.14 to determine the diameter.
3. Choose a grip offering a range of cable diameters the same as the cable diameter.

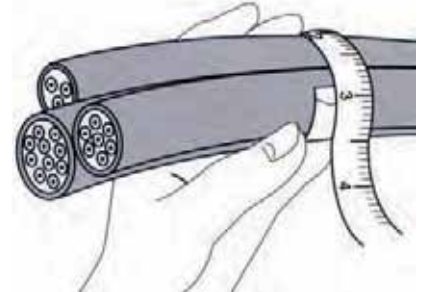

### For Cables of Equal Diameters

Under "Number of Cables in One Grip", find the diameter of your single cable in vertical column. Read the grip diameter range to the right.

If your diameter is the maximum of the range shown, go to the next larger size for Split Grips, stay with the same size for Closed Grips.

**Example:** 3 cables, each with .85" (2.16) diameter, for a Closed Grip select the 1.50"-1.74" (3.81-4.42) range, for a Split Grip select the 1.75"-1.99" (4.44-5.05) range.

### Number of Equal Diameter Cables in One Grip

2	3	4	5	6 and 7	8	9	Grip Dia. Range Inches (cm)
.29-.36 (.74-.91)	.24-.30 (.61-.76)	.21-.25 (.53-.63)	.18-.22 (.46-.56)	.16-.20 (.41-.51)	.15-.18 (.38-.46)	.14-.17 (.36-.43)	.50-.62 (1.27-1.57)
.37-.43 (.94-1.09)	.31-.36 (.79-.91)	.26-.30 (.66-.76)	.23-.27 (.58-.69)	.21-.24 (.53-.61)	.19-.22 (.48-.56)	.18-.20 (.46-.51)	.63-.74 (1.60-1.88)
.44-.58 (1.12-1.47)	.37-.48 (.94-1.22)	.31-.41 (.79-1.04)	.28-.36 (.71-.91)	.25-.32 (.63-.81)	.23-.29 (.58-.74)	.21-.27 (.53-.69)	.75-.99 (1.90-2.51)
.59-.72 (1.50-1.83)	.49-.60 (1.24-1.52)	.42-.51 (1.07-1.30)	.37-.45 (.94-1.14)	.33-.40 (.84-1.02)	.30-.36 (.76-.91)	.28-.34 (.71-.86)	1.00-1.24 (2.54-3.15)
.73-.87 (1.85-2.21)	.61-.72 (1.55-1.83)	.52-.61 (1.32-1.55)	.46-.54 (1.17-1.37)	.41-.48 (1.04-1.22)	.37-.43 (.94-1.09)	.35-.40 (.89-1.02)	1.25-1.49 (3.17-3.78)
.88-1.01 (2.24-2.57)	.73-.85 (1.85-2.16)	.62-.71 (1.57-1.80)	.55-.63 (1.40-1.60)	.49-.56 (1.24-1.42)	.44-.51 (1.12-1.30)	.41-.47 (1.04-1.19)	1.50-1.74 (3.81-4.42)
1.02-1.16 (2.59-2.95)	.86-.96 (2.18-2.44)	.72-.81 (1.83-2.06)	.64-.72 (1.63-1.83)	.57-.64 (1.45-1.63)	.52-.58 (1.32-1.49)	.48-.54 (1.22-1.37)	1.75-1.99 (4.44-5.05)
1.17-1.44 (2.97-3.66)	.97-1.20 (2.46-3.05)	.82-1.02 (2.08-2.59)	.73-.90 (1.85-2.29)	.65-.80 (1.65-2.03)	.59-.72 (1.50-1.83)	.55-.67 (1.40-1.70)	2.00-2.49 (5.08-6.32)
1.45-1.73 (3.68-4.39)	1.21-1.45 (3.07-3.68)	1.03-1.22 (2.62-3.10)	.91-1.08 (2.31-2.74)	.81-.96 (2.06-2.44)	.73-.87 (1.85-2.21)	.68-.81 (1.73-2.06)	2.50-2.99 (6.35-7.59)
1.74-2.02 (4.42-5.13)	1.46-1.69 (3.71-4.29)	1.23-1.43 (3.12-3.63)	1.09-1.26 (2.77-3.20)	.97-1.11 (2.46-2.82)	.83-1.01 (2.11-2.57)	.82-.94 (2.08-2.39)	3.00-3.49 (7.62-8.86)
2.03-2.31 (5.16-5.87)	1.70-1.93 (4.32-4.90)	1.44-1.63 (3.66-4.14)	1.27-1.44 (3.23-3.66)	1.12-1.27 (2.84-3.23)	1.02-1.15 (2.59-2.92)	.95-1.08 (2.41-2.74)	3.50-3.99 (8.89-10.13)

*Note: \*This chart is to be used for determining grip size when multiple cables are held in a single Conduit Riser Grip. For Support Grip multiple cable selection, see page V-44. It is always recommended that, when multiple cables are installed in a Conduit Riser Grip, the tail end of the grip be banded after installation on the cable bundle. See page Tech-23 for cable and wire charts.*

Kellems® Wire Management Products  
**Fiber Optic Cable Grips**  
*Pulling and Support Grips*

OPTISOK® Grip is a revolutionary tool to pull preterminated fiber optic cables. They will protect the connectors and guide the bundle through the pulling environment



Pulling Grips are used for outside plant cable. They are easy to install and remove, reusable, and have a slim profile for small build up



Grips for cable support are easy to install or position. They come in a closed style when the cable end is available, and a split rod style for mid-span installation. Will support the cable's weight as it hangs in vertical, sloping or horizontal position



**OPTISOK® Non-metallic Fiber Optic Pulling Tool For Preterminated, Inside Plant Fiber Optic Cables and Bundles of Twisted Pair**

**IMPORTANT**  
 Read all breaking strength, safety and technical data relating to this product. Pages V-51 to V-54.



**OPTISOK® Non-Metallic Fiber Optic Pulling Tool**

Bundle/Size Range Inches (cm)	Approx. O/A Length Inches (cm)	Ring O.D. Inches (cm)	Ring Thickness Inches (cm)	Maximum Work Load Lbs. (N)	Catalog Number
.125"-.562" (.318-1.427)	28" (71.12)	.71" (1.803)	.10" (.254)	30 (133)	<b>CCPS1</b>
.250"-.750" (.635-1.905)	31" (78.74)	.71" (1.803)	.10" (.254)	40 (178)	<b>CCPS2</b>
.750"-1.750" (1.905-4.445)	33" (83.82)	1.57" (3.988)	.16" (.406)	50 (222)	<b>CCPS3</b>

**Pulling Grip For Loose Tube Fiber Optic Cable, Galvanized Steel**



**Pulling Grip For Loose Tube Fiber Optic Cable, Galvanized Steel**

Diameter Range Inches (cm)	Mesh Length Inches (cm)	Eye Length Inches (cm)	Eye Diameter Inches (cm)	Lug Diameter Inches (cm)	Maximum Breaking Strength Lbs. (N)	Catalog Number
.312"-.625" (.79-1.59)	22.5" (57.15)	6.3" (16.00)	.20" (.51)	.51" (1.30)	3,000 (13,344)	<b>PFOLT312</b>

**IMPORTANT**  
 Read all breaking strength, safety and technical data relating to this product. Pages V-51 to V-54.

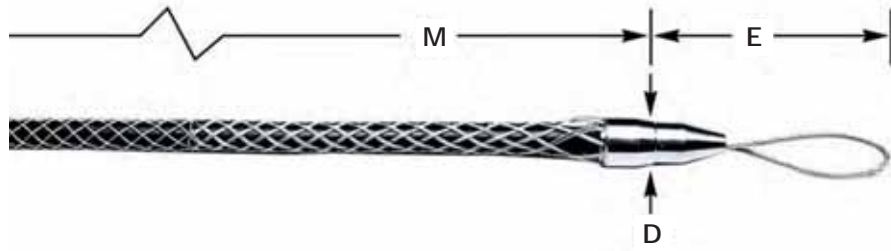

**Fiber Optic Pulling Grip, Flexible Eye**

Cable Diameter Range Inches (cm)	Approx. Breaking Strength Lbs. (N)	E Approx. Inches (cm)	M Approx. Inches (cm)	D Approx. Inches (cm)	Catalog Number
.10"-.22" (.25-.56)	1,000 (4,448)	5.5" (14)	9" (23)	0.8" (2)	033291000
.21"-.35" (.53-.89)	1,500 (6,672)	5.5" (14)	14" (36)	0.8" (2)	033291001
.32"-.48" (.81-1.22)	2,200 (9,786)	6.0" (15)	18" (46)	0.9" (2.29)	033291002
.42"-.61" (1.07-1.55)	2,800 (12,454)	6.0" (15)	21" (53)	0.9" (2.29)	033291003
.53"-.74" (1.35-1.88)	3,300 (14,678)	6.5" (17)	24" (61)	1.3" (3.30)	033291004
.64"-.87" (1.63-2.21)	4,700 (20,906)	6.5" (17)	27" (69)	1.3" (3.30)	033291005

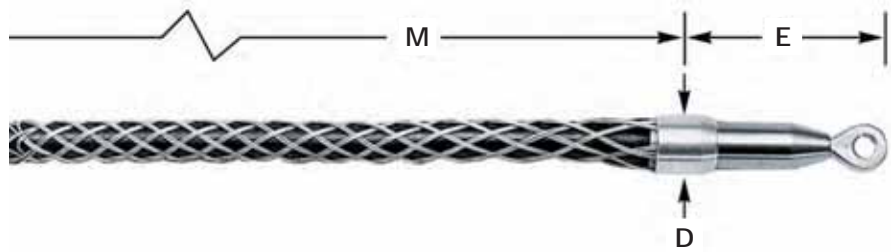

**Fiber Optic Pulling Grip, Swivel Eye**

Cable Diameter Range Inches (cm)	Approx. Breaking Strength Lbs. (N)	E Approx. Inches (cm)	M Approx. Inches (cm)	D Approx. Inches (cm)	Catalog Number
.21"-.35" (.53-.89)	1,500 (6,672)	4.0" (10.16)	14" (35.56)	0.9" (2.29)	033291008
.32"-.48" (.81-1.22)	2,200 (9,786)	4.0" (10.16)	18" (45.72)	0.9" (2.29)	033291009
.42"-.61" (1.07-1.55)	2,800 (12,454)	4.0" (10.16)	21" (53.34)	0.9" (2.29)	033291010
.53"-.74" (1.35-1.88)	3,250 (14,457)	4.8" (12.19)	24" (60.96)	1.3" (3.30)	033291011
.64"-.87" (1.63-2.21)	4,700 (20,906)	4.8" (12.19)	27" (68.58)	1.3" (3.30)	033291012

Note: E-Eye length. M-Mesh length at nominal diameter.

**IMPORTANT**

Read all breaking strength, safety and technical data relating to this product. Pages V-51 to V-54.

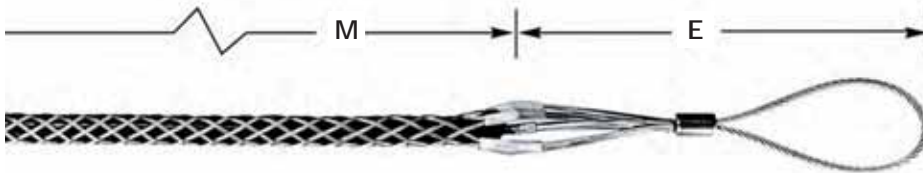

**Fiber Optic Pulling Grip, Flexible Eye, Low Profile, Double/Single Weave Mesh**

Cable Diameter Range Inches (cm)	Approx. Breaking Strength Lbs. (N)	E Approx. Inches (cm)	M Approx. Inches (cm)	Catalog Number
.10"-.22" (.25-.56)	900 (4,003)	7.5" (19)	10" (25)	033291193
.21"-.35" (.53-.89)	1,400 (6,227)	7.5" (19)	14" (36)	033291194
.32"-.48" (.81-1.22)	2,000 (8,896)	8.5" (22)	19" (48)	033291195
.42"-.61" (1.07-1.55)	2,500 (11,120)	8.5" (22)	21" (53)	033291196
.53"-.74" (1.35-1.88)	3,000 (13,344)	8.5" (22)	23" (58)	033291197
.64"-.87" (1.63-2.21)	4,200 (18,682)	8.5" (22)	25" (64)	033291198
.75"-1.00" (1.90-2.54)	4,200 (18,682)	8.5" (22)	28" (71)	033291199

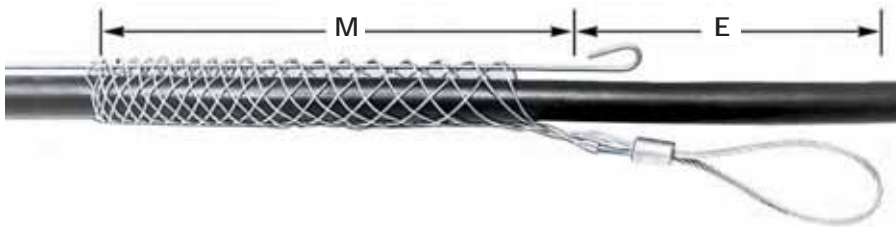

**Fiber Optic Slack Pulling Grip, Split Mesh Rod Closing, Single Weave**

Cable Diameter Range Inches (cm)	Approx. Breaking Strength Lbs. (N)	E Approx. Inches (cm)	M Approx. Inches (cm)	Catalog Number
.25"-.37" (.63-.94)	300 (1,334)	3" (7.6)	4.7" (12)	033291015
.38"-.49" (.97-1.24)	800 (3,558)	3" (7.6)	5" (13)	033291016
.50"-.61" (1.27-1.55)	800 (3,558)	3" (7.6)	7.5" (19)	033291017
.62"-.74" (1.57-1.88)	1,200 (5,338)	3" (7.6)	8" (20)	033291018

Note: E-Eye length. M-Mesh length at nominal diameter.

**IMPORTANT**  
 Read all breaking strength, safety and technical data relating to this product. Pages V-51 to V-54.

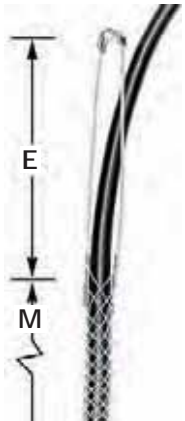

**Fiber Optic Single Eye Cable Support Grip, Closed Mesh, Single Weave**

For permanent support when cable end is available to be installed through grip.

Cable Diameter Range Inches (cm)	Approx. Breaking Strength Lbs. (N)	E Approx. Inches (cm)	M Approx. Inches (cm)	Catalog Number
.18"-.25" (.46-.63)	300 (1,334)	3" (7.6)	1.7" (4.3)	022291000
.23"-.32" (.58-.81)	300 (1,334)	3" (7.6)	2.5" (6.4)	022291001
.30"-.39" (.76-.99)	300 (1,334)	4" (10)	2.5" (6.4)	022291002
.37"-.48" (.94-1.22)	300 (1,334)	5" (13)	4" (10)	022291003
.46"-.58" (1.17-1.47)	400 (1,779)	6" (15)	4" (10)	022291004
.56"-.71" (1.42-1.80)	600 (2,669)	7" (18)	5.5" (14)	022291005
.69"-.88" (1.75-2.24)	800 (3,558)	8" (20)	6" (15)	022291006

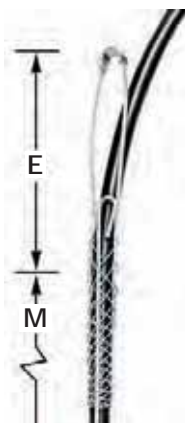

**Fiber Optic Single Eye Cable Support Grip, Split Mesh, Rod Closing, Single Weave**

For support when cable end not available.

Cable Diameter Range Inches (cm)	Approx. Breaking Strength Lbs. (N)	E Approx. Inches (cm)	M Approx. Inches (cm)	Catalog Number
.18"-.25" (.46-.63)	300 (1,334)	3" (7.6)	2.5" (6.4)	022291016
.23"-.32" (.58-.81)	300 (1,334)	3" (7.6)	2.5" (6.4)	022291017
.30"-.39" (.76-.99)	300 (1,334)	4" (10)	2.5" (6.4)	022291018
.37"-.48" (.94-1.22)	300 (1,334)	5" (13)	4" (10)	022291019
.46"-.58" (1.17-1.47)	400 (1,779)	6" (15)	5" (13)	022291020
.56"-.71" (1.42-1.80)	600 (2,669)	7" (18)	5" (13)	022291021
.69"-.88" (1.75-2.24)	800 (3,558)	8" (20)	6" (15)	022291022

*Note: E-Eye length. M-Mesh length at nominal diameter.*



Kellems has wide experience with grips for use with fiber optic cable. As the industry leader in producing wire mesh grips for the stringent requirements of fiber optic applications, Kellems has developed several series of grips for use with fiber optic communications cable.

These grips include pulling grips with built in swivels, grips with steel ends to protect fragile cable ends, grips with low profiles to pull cables in tight places and the OPTISOK® an effective tool to place preterminated cables. Also available are grips to support fiber optic cable.

### Safety And Working Load Factors For Wire Mesh Grips

The broad application of Kellems grips on a wide variety of objects requires that adequate safety factors be used to establish working loads. The approximate breaking strength of a Kellems grip represents an average calculation based on data established from actual direct tension testing done in our engineering laboratories.

It is impossible to catalog or guarantee a safety factor suitable for all applications as operating conditions are never the same. The tension, diameter, movement, number of objects gripped, gripping surface, and the attachments used are just some of the factors which vary with each application. These factors, together with the effects of abrasion, corrosion, prior use or abuse and any other variables of a specific application, must be considered by the user and the grip replaced as appropriate. Where the conditions of

### Select the Correct Fiber Optic Grip

Each Kellems grip is designed to work on a specific range of cable diameters.

- Step 1** Determine your cable outside diameter.
- Step 2** Find the grip size that encompasses your cable diameter.
- Step 3** Whenever possible, use a closed mesh that assembles over the cable end. If the cable end is not available, use a split mesh.
- Step 4** Where available, select an eye style that suits your needs.
- Step 5** Estimate the tension to be put on the grip, establish the working load you require and compare this to the listed approximate breaking strength of the grip to insure that the grip will be strong enough.

the application are not well defined or known or where risk of injury to persons or property is involved, a greater safety factor should be utilized.

**Under normal conditions, Kellems' recommended factor of safety is five for catalog listed pulling grips, and ten for catalog listed support grips.**

Any warranty as to quality, performance or fitness for use of grips is always premised on the condition that the published breaking strengths apply only to new, unused grips, and that such products are properly stored, handled, used, maintained and inspected by the user at a frequency appropriate for the use and condition of the grip.

For grip applications on materials other than those that the grips have been specifically designed for, consult the factory.

### Examples

Grip Style	Approx. Breaking Strength Lbs. (N)	Safety Factor	Max. Recommended Load Lbs. (N)	Catalog Number
Pulling Grips	2,500 (11,120)	5	500 (2,224)	<b>033291196</b>
Support Grips	400 (1,779)	10	40 (178)	<b>022291004</b>

The maximum recommended working load is the tension to be exerted on the grip in application with a margin of safety to take care of unforeseen and unusual circumstances.

It is the end-user's decision to determine how much of a safety factor is acceptable to for the application.

### Fiber Optic Grip Materials

Material	Features	Product Group
Galvanized steel wire	<ul style="list-style-type: none"> <li>• High strength</li> <li>• Not subject to continuous outside environment</li> </ul>	<ul style="list-style-type: none"> <li>• Pulling grips</li> </ul>
Tin-coated bronze wire	<ul style="list-style-type: none"> <li>• Corrosion resistant for normal outside areas</li> <li>• Non-magnetic</li> <li>• Moderate strength</li> </ul>	<ul style="list-style-type: none"> <li>• Support grips</li> </ul>
Non-metallic braid	<ul style="list-style-type: none"> <li>• Superior flex life</li> <li>• Non-conductive</li> <li>• Corrosion resistant</li> <li>• Moderate strength</li> </ul>	<ul style="list-style-type: none"> <li>• OPTISOK®</li> </ul>

### Approvals

CSA Certification is indicated on appropriate product catalog pages.

## Kellems® Wire Management Products Technical Information

### OPTISOK® Pulling Grips

Kellems offers a unique and simple to use tool for the installation of preconnectorized fiber optic cables, jumpers and bundles of twisted pair communication cables - the OPTISOK®.

The OPTISOK® is a highly flexible and expandable nonmetallic sleeve open on one end and with a pulling ring on the other. It will expand to enclose the larger group of fiber optic connectors and grab the cable below the connector bundle by wrapping and taping to provide a gripping tool that will grab the cable(s) below the connectors. The pulling ring can be attached to a pulling line or fish tape and the OPTISOK® will act as the pulling tool.

OPTISOK® will contain and protect the connector bundle and save time and labor by making the pulling job easier, protecting the connectors from possible damage during the pull and facilitating the passage of the connector bundle through cramped and tight spaces. The OPTISOK® can be used to pull cables through plenums, underfloor duct, office partitions, raised access floors and conduits. Three sizes are available for all applications.

### How to Select OPTISOK®

- Identify connector bundle diameter to be inserted into the OPTISOK®.
- Choose appropriate catalog number based on size range.

### Installation Information

**Step 1** Expand open end of OPTISOK® and gently work in fiber optic connector bundle.

**Step 2** Still gently, work connector bundle up to the forward section of the OPTISOK®.

**Step 3** Starting at approximately 6" (15.2cm) from tail end of OPTISOK®, tightly fold over the OPTISOK® around cables and tape wrapped section 3" (7.62cm) past tail end onto the bundle.

**Step 4** Securely attach pulling line or tape to pulling ring.

*Note: To remove OPTISOK® carefully unwrap tape and slide out cables and connectors or cut OPTISOK® away without damaging connectors or cables.*

#### Step 1

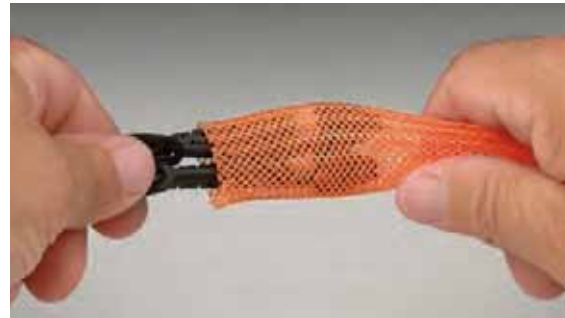

#### Step 2



#### Step 3



#### Step 4



### **Pulling Grip for Loose Tube Fiber Optic Cable**

---

Kellems offers a wire mesh specifically designed to pull loose tube fiber optic cable and meet the special pulling requirements recommended by fiber optic cable manufacturers.

Many fiber optic cable manufacturers require special cable preparation prior to pulling where a short section of the outer jacket is stripped off exposing the aramid strength member. This creates two cable diameters, one including the jacket and a second smaller diameter at the strength member. Kellems fiber grip with its special weave will accommodate and securely grab both diameters, at the outside jacket and the internal aramid strength member.

Additionally, this galvanized steel mesh grip has longer leads at the pulling eye to facilitate pulling the cable up through the top, a very low profile lug and eye to slip through tight areas, and short shoulders to protect the cable while maintaining the slim profile.

The grip can be used to pull cable overhead as well as underground through conduit and duct. It easily mates with a swivel and has the necessary strength to securely make pulls.

### **Application Information**

---

- Prior to pulling cable, follow cable manufacturers' cable preparation recommendations.
- Never exceed cable manufacturers' pulling tension recommendations.
- Never use grips to approximate breaking strength safety factor of 5 recommended.

### **Pulling Grips for Other Outside Plant Cables, Swivel Eye, Flexible Eye, Split Style, Low Profile**

---

Kellems Pulling Grips for fiber optic cable are made of high strength galvanized steel strand. They feature a multiweave mesh, with one-half the mesh length double weave, and the second half single weave. This special weave provides positive holding power while allowing the grip to remain flexible with no damage to the cable jacket. Added features include a steel nose cone which protects the cable end and allows the grip to pass easily through conduit and enclosures. The eye connects easily to a swivel or a pulling line. Several grip sizes are available to accommodate all diameters of fiber optic cable.

### **Application**

---

Kellems Flexible Eye Pulling Grips for fiber optic cable are used for the installation of fiber optic communication lines either underground, overhead, through conduit or through enclosures. They will fit single cables or cable bundles, are easily installed on the cable, and are reusable.

### **Benefits**

---

- High strength multiweave mesh for positive holding power.
- Highly flexible mesh to follow the pulling path of the cable.
- Steel nose cone reduces snags and hang-ups and protects cable end.
- Easily installed and removed.
- A dependable, reusable pulling tool.

### Support Grips for Fiber Optic Cable

Kellems Support Grips for fiber optic cable are specially designed to hold the cable weight as it hangs in a vertical or horizontal position. Fiber optic cable must be supported and Kellems Grips provide the support easily and economically.

These grips are made of high grade, non-magnetic tin-coated bronze strand. They are offered in universal bale or single eye configurations and are available in either closed mesh (for use where the cable end is available) or in split mesh, rod closing (for installation on existing cable runs or at specific locations).

### Split Support Grip Rod Closing Instructions

The stainless steel rod is a precise built-in feature which makes threading easy and fast. The strands of the mesh pass around the rod and match up with the strands from the opposite direction. The rod does not touch the cable at any point and therefore cannot cut the cable. Rod Closing Grips are reusable. They may be removed and reused as many times as desired.

### Fast to Install

**Step 1** Wrap the grip around the cable and thread the rod through the preformed loops with a corkscrew motion, using the curved end of the rod to engage the loops.

**Step 2** The action required is a steady push and twist simultaneously. The fingers of the left hand are used to bring the loops together just ahead of the hook on the end of the rod.

**Step 3** To remove, simply pull the rod out.



# Kellems® Wire Management Products Hose Containment Grips

## Types of Attachment

The five attachment methods shown below provide unlimited flexibility of attachment to meet any condition.

### Type E

Double Eye Grip, used where fastening is made with eyebolts or similar anchor terminations.

### Type A

Single Eye Grip, used where fastening MUST be made from one point.

### Type U

Universal Bale Grip, used to fasten around a structure or closed eye.

### Type Y

Threaded bolt ( $\frac{5}{16}$ -18 x 1 $\frac{1}{2}$ " long), used to fasten through drilled holes in plate.

### Type F

Split fitting to fit AN-818 nuts. Fitting is positioned over nut and located with internal flange. A hose clamp is furnished and required to hold the fitting in correct position.

## IMPORTANT

Read all breaking strength, safety and technical data relating to this product. Pages V-41 to V-42.

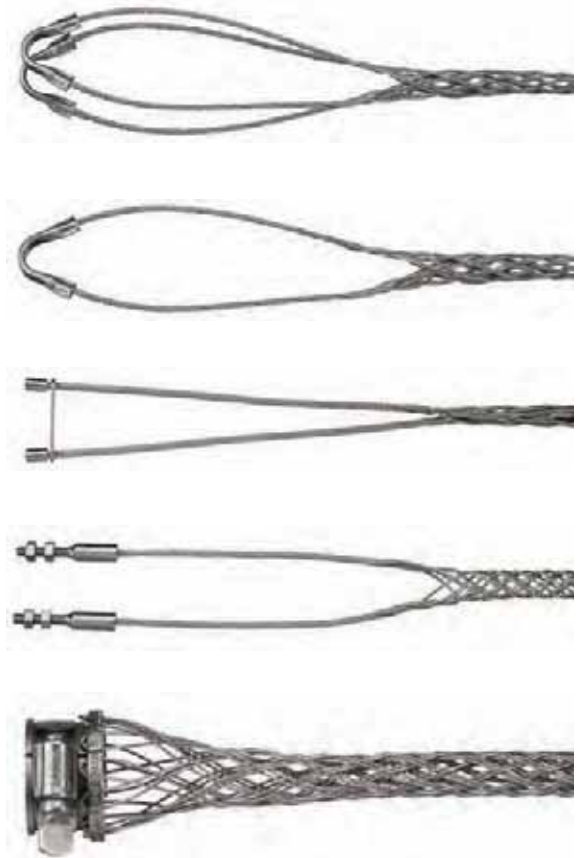

*Note: It should be emphasized that Kellems® Hose Containment Grips are not to be used as a pressure reinforcing device for hose systems. These grips are custom made. Consult Technical Services for details.*

Kellems Hose Containment Grips are used on high pressure, flexible hose lines to prevent the hose from whipping violently in the event of hose failure at the fitting. These grips will prevent serious injury to personnel and damage to equipment by holding the hose in place in the event of hose failure.

Kellems patented Hose Containment Grips are made of stainless steel with double weave mesh construction for high strength and come complete with hose clamps.

Kellems Hose Containment Grips are supplied in diameters, length and attachments to meet individual requirements. Contact the Wiring Device-Kellems factory for specific information. These grips help meet OSHA Federal Register 1926-302 (b), 1926-603 (9), (10), JIC H-1-1973 (H13.11) and JIC P-1-1975 (P11.34) requirements.

# Kellems® Wire Management Products

## Strain Relief System Selection Chart

### Strain Relief Grips

Kellems Strain Relief Grips are designed to prevent tension from being transmitted to joints and terminals on electrical cord, cable and conduit. In most applications, a Kellems grip for strain relief is stronger than the cable itself and gives much greater security than the use of a fitting alone. Kellems Grips for strain relief help make electrical systems safer, and save money by minimizing downtime from costly electrical failure due to cable pull-out. Kellems Grips also aid in compliance with the National Electric Code's terminal tension protection requirements.

### Select the Correct Grip for Strain Relief

Kellems Grips for strain relief are designed to fit on electrical cord, cable or flexible conduit.

**Step 1** Refer to the chart below to determine the grip style best suited for your application.







**Step 2** Determine your cable outside diameter or conduit size.

**Step 3** Locate environment—indoors or outdoors.

**Step 4** Decide if a liquidtight seal is required.

**Step 5** Select NPT size and fitting style.

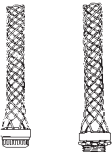
### Strain Relief System Selection Chart

Grip Type	Application	Features	Cord or Conduit Range Inches (cm)	Type Fitting or Attachment	Page Number
<b>Deluxe Cord Aluminum Fitting/ Stainless Steel Grip</b>	 Outdoors or indoors where subjected to moisture or splash. Examples are crane and hoist pendant drop stations, hand tools, pumps and processing equipment.	Aluminum fittings, stainless steel mesh, neoprene oil-and-watertight bushing. Double-single weave.	.187"-3.250" (.47-8.25)	NPT, PG, and metric aluminum, male straight, 45° male, 90° male, female straight. Thread sizes 3/8"-3".	V-58, V-59, V-62
<b>Deluxe Cord Nylon Fitting/ Stainless Steel Grip</b>	 Outdoors or indoors where subjected to moisture or splash. Examples are marine and food processing equipment.	Nylon fitting, stainless steel mesh, double-single weave, neoprene oil-and-watertight bushing.	.187"-1.125" (.47-2.86)	NPT nylon, male straight, 90° male. Thread sizes 1/2"-1".	V-60
<b>Deluxe Cord Nylon Fitting/ Non-metallic Grip</b>	 Indoor or outdoors. Provides liquidtight seal, where exposed to moisture. Excellent for oil refining and chemical processing.	Non-metallic grip is corrosion resistant, nonconductive and provides superior gripping and flexing benefits. Neoprene liquidtight bushing. Nylon fitting.	.187"-1.000" (.47-2.54)	NPT nylon, straight male, thread sizes 3/8"-1" 90° male, thread sizes 1/2"-1".	V-61
<b>Deluxe Cord Stainless Steel Fitting And Grip</b>	 Indoor or outdoor use where exposed to moisture. Very strong for heavy abuse areas such as drilling platforms, steel mills and mines.	Stainless steel fitting and grip for strength. Neoprene liquidtight bushing. Double/single weave grip.	.187"-1.000" (.47-2.54)	Straight male Only with NPT Thread sizes 1/2"-1".	V-61
<b>Dust-Tight Strain Relief</b>	 Indoor use only for wiring of electrical enclosures, machine tools, portable power tools, bus drop cable systems.	Neoprene gasket—seals out chips, dirt, dust. One piece design with galvanized steel mesh. Insulating bushing available. Zinc-plated steel locknut.	.240"-2.450" (.61-6.22)	Straight male NPS or NPT	V-63
<b>Liquidtight Flexible Conduit Grip (Metal and Non-Metallic)</b>	 Wiring of machine tools, electrical enclosures, motors and systems where metallic liquidtight flexible conduit is subjected to vibration, flexure, motion or strain.	Stainless steel mesh, liquidtight fittings. Sealing "O" rings (optional). Choice of fittings.	.375"-4.000" trade sizes	NPT 1/2"-4", Hubbell fittings, Male straight, 45° male, 90° male, female straight.	V-66, V-67
<b>Liquidtight Flexible Conduit Grip (UL Type A)</b>	 Wiring or machine tools, electrical enclosures, motors and systems where conduit is subject to vibration and strain.	Stainless steel mesh, liquidtight fittings with "O" ring and locknut.	.375"-2.008" trade size male	NPT steel, Hubbell fittings, straight male, 90° Thread sizes 1/2"-2".	V-68

Kellems® Wire Management Products  
**Strain Relief for Flexible Cords**  
*For Insulated Cables and Flexible, Liquidtight Conduits*

Endless weave provides easy cable/flexible conduit installation

Stainless steel mesh is corrosion resistant. Can be used inside or outside. It eliminates cable or flexible conduit pull out and reduces costly downtime

Multiweave grip gives cable arc-of-bend control minimizing cable damage and extending cable life. It is the strongest strain relief device available. Meets and exceeds all code requirements; prevents cable/conduit pull-out

A liquidtight fitting is available with both cable and conduit fittings; prevents liquids from running through the fitting into the enclosure

An NPT and PG threaded body allows easy attachment to either threaded hub or knock-out in box

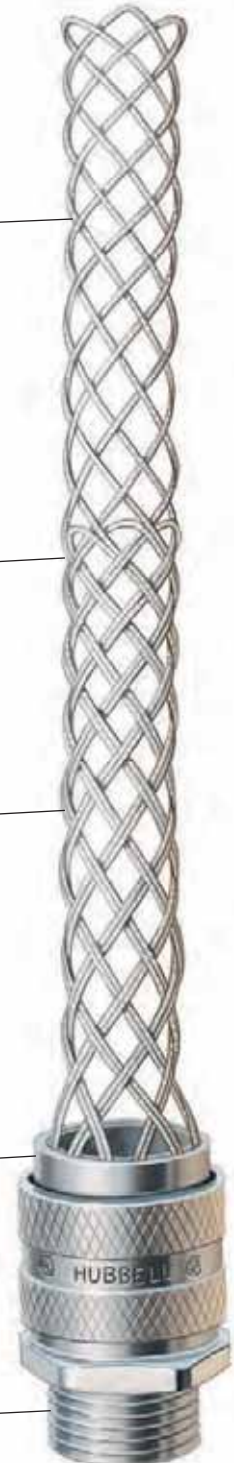

**IMPORTANT**

Read all breaking strength, safety and technical data relating to this product. Pages V-69 to V-76.

**Straight Male Thread**

NPT Thread Size Inches	Grip Diameter Range		Form Size	Catalog Number
	Inches	(cm)		
3/8	.250"-.312"	(.63-.79)	F1	07401001
	.312"-.375"	(.79-.95)		07401002
	.375"-.437"	(.95-1.11)		07401003
1/2	.187"-.250"	(.47-.63)	F2	07401004
	.250"-.375"	(.63-.95)		07401006
	.375"-.500"	(.95-1.27)		07401008
1/2	.500"-.625"	(1.27-1.59)	F3	07401010
	.625"-.750"	(1.59-1.90)		074011247*
	.750"-.875"	(1.90-2.22)		074011248*
3/4	.187"-.250"	(.47-.63)	F2	07401011
	.250"-.375"	(.63-.95)		07401013
	.375"-.500"	(.95-1.27)		07401015
3/4	.500"-.625"	(1.27-1.59)	F3	07401017
	.625"-.750"	(1.59-1.90)		07401018
	.750"-.875"	(1.90-2.22)		074011249*
1	.375"-.500"	(.95-1.27)	F4	074011195
	.500"-.625"	(1.27-1.59)		07401019
	.625"-.750"	(1.59-1.90)		07401021
	.750"-.875"	(1.90-2.22)		07401023
	.875"-.1.000"	(2.22-2.54)		07401025
1	1.000"-.1.125"	(2.54-2.86)	F5	074011250*
	1.125"-.1.250"	(2.86-3.17)		074011028*
	1.250"-.1.375"	(3.17-3.49)		074011029*
	.750"-.875"	(1.90-2.22)		074011251
	.875"-.1.000"	(2.22-2.54)		07401026
1 1/4	1.000"-.1.125"	(2.54-2.86)	F5	07401027
	1.125"-.1.250"	(2.86-3.17)		07401028
	1.250"-.1.375"	(3.17-3.49)		074011178*
	.750"-.875"	(1.90-2.22)		074011252
	.875"-.1.000"	(2.22-2.54)		07401029
1 1/2	1.000"-.1.125"	(2.54-2.86)	F5	07401030
	1.125"-.1.250"	(2.86-3.17)		07401031
	1.250"-.1.375"	(3.17-3.49)		07401032
	1.312"-.1.437"	(3.33-3.65)		074011253
1 1/2	1.437"-.1.562"	(3.65-3.97)	F6	074011254*
	1.562"-.1.687"	(3.97-4.28)		074011255*
	1.687"-.1.812"	(4.28-4.60)		074011256*
	1.750"-.1.875"	(4.44-4.76)		074011257*
	1.250"-.1.375"	(3.17-3.49)		074011258
2	1.312"-.1.437"	(3.33-3.65)	F6	074011259
	1.437"-.1.562"	(3.65-3.97)		07401033
	1.562"-.1.687"	(3.97-4.28)		07401034
	1.687"-.1.812"	(4.28-4.60)		07401035
	1.750"-.1.875"	(4.44-4.76)		074011260
2	1.812"-.1.937"	(4.60-4.92)	F7	074011261
	1.937"-.2.062"	(4.92-5.24)		074011262*
	2.062"-.2.187"	(5.24-5.55)		074011263*
	2.187"-.2.312"	(5.55-5.87)		074011264*
	2.312"-.2.437"	(5.87-6.19)		074011265*
2 1/2	1.688"-.1.812"	(4.29-4.60)	F7	074011030
	1.812"-.1.937"	(4.60-4.92)		074011031
	1.937"-.2.062"	(4.92-5.24)		074011032
	2.062"-.2.187"	(5.24-5.55)		074011033
	2.187"-.2.312"	(5.55-5.87)		074011034
3	2.312"-.2.437"	(5.87-6.19)	F7	074011266*
	1.937"-.2.062"	(4.92-5.24)		074011036
	2.062"-.2.187"	(5.24-5.55)		074011037
	2.187"-.2.312"	(5.55-5.87)		074011038
	2.312"-.2.437"	(5.87-6.19)		074011039
3	2.437"-.2.625"	(6.19-6.67)	F8	074011186
	2.625"-.2.812"	(6.67-7.14)		074011187
	2.812"-.3.000"	(7.14-7.62)		074011188
	3.000"-.3.250"	(7.62-8.25)		074011189*

Note: Kellems® Deluxe Cord Grips are suitable for use in hazardous locations per Class I Div. 2, Class II Div. 1 & 2, Class III Div. 1 & 2 of the National Electric Code Sections 501.10(b)(2), 502.10(a)(2), 502.10(b)(2), 503.10(a)(2) and 503.10(b).  
\*Cable jacket may have to be stripped to pass through connector body.





**IMPORTANT**

Read all breaking strength, safety and technical data relating to this product. Pages V-69 to V-76.

**Straight Female Thread**

NPT Thread Size Inches	Grip Diameter Range		Form Size	Catalog Number
	Inches	(cm)		
1/2	.375"-.500"	(.95-1.27)	F2	07401043
	.500"-.625"	(1.27-1.59)		07401045
3/4	.500"-.625"	(1.27-1.59)	F2	07401052
3/4	.625"-.750"	(1.59-1.90)	F4	07401053

**90° Male Thread**

NPT Thread Size Inches	Grip Diameter Range		Form Size	Catalog Number
	Inches	(cm)		
3/8	.250"-.312"	(.63-.79)	F1	07401071
	.312"-.375"	(.79-.95)		07401072
	.375"-.437"	(.95-1.11)		07401073
1/2	.187"-.250"	(.47-.63)	F2	07401074
	.250"-.375"	(.63-.95)		07401076
	.375"-.500"	(.95-1.27)		07401078
	.500"-.625"	(1.27-1.59)		07401080*
3/4	.375"-.500"	(.95-1.27)	F3	07401081
	.500"-.625"	(1.27-1.59)		07401083
	.625"-.750"	(1.59-1.90)		07401084*
	.750"-.875"	(1.90-2.22)		074011275*
1	.500"-.625"	(1.27-1.59)	F4	07401085
	.625"-.750"	(1.59-1.90)		07401087
	.750"-.875"	(1.90-2.22)		07401089
	.875"-1.000"	(2.22-2.54)		07401091*
	1.000"-1.125"	(2.54-2.86)		074011229*
1 1/4	.750"-.875"	(1.90-2.22)	F5	074011230
	.875"-1.000"	(2.22-2.54)		07401137
	1.000"-1.125"	(2.54-2.86)		07401108
	1.125"-1.250"	(2.86-3.17)		074011042*
1 1/2	1.000"-1.125"	(2.54-2.86)	F5	074011045
	1.125"-1.250"	(2.86-3.17)		074011046
	1.250"-1.375"	(3.17-3.49)		074011047
2	1.312"-1.437"	(3.33-3.65)	F6	074011233
	1.437"-1.562"	(3.65-3.97)		074011244
	1.687"-1.812"	(4.28-4.60)		074011246
	1.750"-1.875"	(4.44-4.76)		074011234*

**45° Male Thread**

NPT Thread Size Inches	Grip Diameter Range		Form Size	Catalog Number
	Inches	(cm)		
1/2	.250"-.375"	(.63-.95)	F2	074011236
	.375"-.500"	(.95-1.27)		074011021
	.500"-.625"	(1.27-1.59)		074011237*
3/4	.500"-.625"	(1.27-1.59)	F3	074011049
	.625"-.750"	(1.59-1.90)		074011051*
	.750"-.875"	(1.90-2.22)		074011239*
1	.625"-.750"	(1.59-1.90)	F4	074011055
	.750"-.875"	(1.90-2.22)		074011057
	.875"-1.000"	(2.22-2.54)		074011199*
1 1/4	1.000"-1.125"	(2.54-2.86)	F5	074011059
	1.125"-1.250"	(2.86-3.17)		074011060

Note: Kellems® Deluxe Cord Grips are suitable for use in hazardous locations per Class I Div. 2, Class II Div. 1 & 2, Class III Div. 1 & 2 of the National Electric Code Sections 501.10(b)(2), 502.10(a)(2), 502.10(b)(2), 503.10(a)(2) and 503.10(b).  
\*Cable jacket may have to be stripped to pass through connector body.



**IMPORTANT**  
 Read all breaking strength, safety and technical data relating to this product. Pages V-69 to V-76.



**Straight Male Thread**

NPT Thread Size Inches	Grip Diameter Range		Form Size	Catalog Number
	Inches	(cm)		
½	.187"-.250"	(.47-.63)	F2	074011331
	.250"-.375"	(.63-.95)		074011332
	.375"-.500"	(.95-1.27)		074011333
	.500"-.625"	(1.27-1.59)		074011334*
¾	.375"-.500"	(.95-1.27)	F3	074011335
	.500"-.625"	(1.27-1.59)		074011336
	.625"-.750"	(1.59-1.90)		074011337
	.750"-.875"	(1.90-2.22)		074011338*
1	.625"-.750"	(1.59-1.90)	F4	074011341
	.750"-.875"	(1.90-2.22)		074011342
	.875"-1.000"	(2.22-2.54)		074011343
	1.000"-1.125"	(2.54-2.86)		074011344*



**90° Male Thread**

NPT Thread Size Inches	Grip Diameter Range		Form Size	Catalog Number
	Inches	(cm)		
½	.250"-.375"	(.63-.95)	F2	074011346
	.375"-.500"	(.95-1.27)		074011347
	.500"-.625"	(1.27-1.59)		074011348*
¾	.375"-.500"	(.95-1.27)	F3	074011349
	.500"-.625"	(1.27-1.59)		074011350
	.625"-.750"	(1.59-1.90)		074011351*

*Note: Kellems® Deluxe Cord Grips are suitable for use in hazardous locations per Class I Div. 2, Class II Div. 1 & 2, Class III Div. 1 & 2 of the National Electric Code Sections 501.10(b)(2), 502.10(a)(2), 502.10(b)(2), 503.10(a)(2) and 503.10(b).  
 \*Cable jacket may have to be stripped to pass through connector body.*



**IMPORTANT**

Read all breaking strength, safety and technical data relating to this product. Pages V-69 to V-76.

**Nylon Fittings Non-metallic Mesh, Liquidtight for Insulated Cables  
Straight Male Thread**

NPT Thread Size Inches	Grip Diameter Range		Form Size	Catalog Number
	Inches	(cm)		
3/8	.187"-.250"	(.47-.63)	F1	CG304NM CG305NM CG306NM
	.250"-.312"	(.63-.79)		
	.312"-.375"	(.79-.95)		
1/2	.187"-.250"	(.47-.63)	F2	CG404NM CG406NM CG408NM
	.250"-.375"	(.63-.95)		
	.375"-.500"	(.95-1.27)		
3/4	.375"-.500"	(.95-1.27)	F3	CG608NM CG610NM CG612NM
	.500"-.625"	(1.27-1.59)		
	.625"-.750"	(1.59-1.90)		
1	.500"-.625"	(1.27-1.59)	F4	CG810NM CG812NM CG814NM CG816NM
	.625"-.750"	(1.59-1.90)		
	.750"-.875"	(1.90-2.22)		
	.875"-1.000"	(2.22-2.54)		



**90° Male Thread**

NPT Thread Size Inches	Grip Diameter Range		Form Size	Catalog Number
	Inches	(cm)		
1/2	.250"-.375"	(.63-.95)	F2	CG40690NM CG40890NM
	.375"-.500"	(.95-1.27)		
3/4	.375"-.500"	(.95-1.27)	F3	CG60890NM CG61090NM CG61290NM*
	.500"-.625"	(1.27-1.59)		
	.625"-.750"	(1.59-1.90)		
1	.625"-.750"	(1.59-1.90)	F4	CG81290NM CG81490NM
	.750"-.875"	(1.90-2.22)		



**Stainless Steel Fittings, Stainless Steel Mesh, Liquidtight for Insulated Cables  
Straight Male Thread**

NPT Thread Size Inches	Grip Diameter Range		Form Size	Catalog Number
	Inches	(cm)		
1/2	.187"-.250"	(.47-.63)	F2	CG404SST CG406SST CG408SST CG410SST
	.250"-.375"	(.63-.95)		
	.375"-.500"	(.95-1.27)		
	.500"-.625"	(1.27-1.59)		
3/4	.375"-.500"	(.95-1.27)	F2	CG608SST CG610SST
	.500"-.625"	(1.27-1.59)		
3/4	.625"-.750"	(1.59-1.90)	F3	CG612SST CG614SST
	.750"-.875"	(1.90-2.22)		
1	.500"-.625"	(1.27-1.59)	F4	CG810SST CG812SST CG814SST CG816SST
	.625"-.750"	(1.59-1.90)		
	.750"-.875"	(1.90-2.22)		
	.875"-1.000"	(2.22-2.54)		



Note: Kellems® Deluxe Cord Grips are suitable for use in hazardous locations per Class I Div. 2, Class II Div. 1 & 2, Class III Div. 1 & 2 of the National Electric Code Sections 501.10(b)(2), 502.10(a)(2), 502.10(b)(2), 503.10(a)(2) and 503.10(b).

\*Cable jacket may have to be stripped to pass through connector body.

**IMPORTANT**  
 Read all breaking strength, safety and technical data relating to this product. Pages V-69 to V-76.



### Straight PG\* Male Thread

Hub Size	Cord Diameter Range		Form Size	Catalog Number
	Inches	(cm)		
PG16	.500"-.625"	(1.27-1.59)	F2	<b>074PG16010</b>
PG21	.500"-.625"	(1.27-1.59)	F2	<b>074PG21010</b>
PG21	.625"-.750"	(1.59-1.90)	F3	<b>074PG211247</b>
	.750"-.875"	(1.90-2.22)		<b>074PG211248</b>
PG29	.625"-.750"	(1.59-1.90)	F4	<b>074PG29021</b>
	.750"-.875"	(1.90-2.22)		<b>074PG29023</b>
	.875"-1.000"	(2.22-2.54)		<b>074PG29025</b>
PG29	1.125"-1.250"	(2.86-3.17)	F5	<b>074PG291028*</b>
PG36	1.125"-1.250"	(2.86-3.17)	F5	<b>074PG36028*</b>

Note: \*Panzergewinde.



### Straight Metric Male Thread

Hub Size	Cord Diameter Range		Form Size	Catalog Number
	Inches	(cm)		
M20	.500"-.625"	(1.27-1.59)	F2	<b>074M20010</b>
M25	.625"-.750"	(1.59-1.90)	F3	<b>074M251247</b>
	.750"-.875"	(1.90-2.22)		<b>074M251248</b>
M25	.500"-.625"	(1.27-1.59)	F2	<b>074M25017</b>
	.625"-.750"	(1.59-1.90)		<b>074M32021</b>
M32	.750"-.875"	(1.90-2.22)	F4	<b>074M32023</b>
	.875"-1.000"	(2.24-2.54)		<b>074M32025</b>
M32	1.000"-1.125"	(2.54-2.86)	F5	<b>074M321250</b>
	1.125"-1.250"	(2.86-3.17)		<b>074M321028</b>

Note: Kellems® Deluxe Cord Grips are suitable for use in hazardous locations per Class I Div. 2, Class II Div. 1 & 2, Class III Div. 1 & 2 of the National Electric Code Sections 501.10(b)(2), 502.10(a)(2), 502.10(b)(2), 503.10(a)(2) and 503.10(b).  
 \*Cable jacket may have to be stripped to pass through connector body.

### Specifications

<b>Material</b>	<b>Temperature Range</b>
Aluminum (Body)	-30°F to +240°F (-34°C to +115°C).
Stainless Steel (Mesh)	-30°F to +240°F (-34°C to +115°C).
Neoprene (Bushings)	-30°F to +240°F (-34°C to +115°C).
<b>Hazardous Locations</b>	Suitable for use in hazardous locations per Class I Div. 2, Class II Div. 1 & 2, Class III Div. 1 & 2 N.E.C. Reference 501.10(b)(2), 502.10(a)(2), 502.10(b)(2), 503.10(a)(2) and 503.10(b).
<b>Approvals</b>	
Deluxe Cord Grips	UL Listed in accordance with Standard 514B for indoor/outdoor use. UL Control numbers 898D and 899D.
<b>Wet Locations</b>	Suitable for use in wet locations when used with a listed sealing ring between box and fitting.

**IMPORTANT**

Read all breaking strength, safety and technical data relating to this product. Pages V-69 to V-76.

**Non-Insulated, Wide Range Strain Relief**

Thread Size	Cable Diameter Range		Mesh Length @ Nom. Dia.	Catalog Number
	Inches	(cm)	Inches (cm)	
½ NPT	.24"-.32"	(.61-.81)	3.25" (8.25)	073031200
½ NPT	.32"-.43"	(.81-1.09)	3.75" (9.52)	073031201
½ NPT	.43"-.54"	(1.09-1.37)	4.75" (12.06)	073031202
¾ NPT	.54"-.73"	(1.37-1.85)	6.5" (16.51)	073031203
1 NPT	.73"-.97"	(1.85-2.46)	7" (17.78)	073031204
1¼ NPT	.97"-1.25"	(2.46-3.17)	9" (22.86)	073031205
PG29*	.73"-.97"	(1.85-2.46)	7" (17.78)	073PG291204

Note: \*Panzergewinde.



**Insulated, Wide Range Strain Relief with Insulating Bushing**

Thread Size	Cable Diameter Range		Mesh Length @ Nom. Dia.	Dim. A	Min. Space Between Grips	Catalog Number
	Inches	(cm)	Inches (cm)	Inches (cm)	Inches (cm)	
½ NPS	.24"-.32"	(.61-.81)	3.25" (8.25)	1" (2.54)	1.25" (3.17)	073031206
½ NPS	.32"-.43"	(.81-1.09)	3.75" (9.52)	1" (2.54)	1.25" (3.17)	073031207
½ NPS	.43"-.54"	(1.09-1.37)	4.75" (12.06)	1" (2.54)	1.25" (3.17)	073031208
¾ NPS	.54"-.73"	(1.37-1.85)	6.5" (16.51)	1" (2.54)	1.5" (3.81)	073031209
1 NPS	.73"-.97"	(1.85-2.46)	7" (17.78)	1.313" (3.02)	1.75" (4.44)	073031210
1¼ NPS	.97"-1.25"	(2.46-3.17)	9" (22.86)	1.313" (3.02)	2.25" (5.71)	073031211
1½ NPT	1.25"-1.50"	(3.17-3.81)	11.75" (29.84)	1.313" (3.02)	2.5" (6.35)	073031212
2 NPT	1.50"-1.70"	(3.81-4.32)	13.25" (33.65)	1.375" (3.49)	3.25" (8.25)	073031213
2½ NPT	1.70"-2.00"	(4.32-5.08)	13.5" (34.29)	1.5" (3.81)	3.625" (9.21)	073031214
2½ NPT	2.00"-2.45"	(5.08-6.22)	13.75" (34.92)	1.5" (3.81)	3.625" (9.21)	073031215



**IMPORTANT**  
 Read all breaking strength, safety and technical data relating to this product. Pages V-69 to V-76.



**Application**

Kellems® I-Grips will fit 2, 3, 4 and 5 wire Hubbell Insulgrip® plugs and connector bodies. The eye tabs fit under the nylon cord clamp and the screws slide through the eyelets, securing the grip in place.

These grips are for indoor use only.

**Benefits**

- Easily attached to Insulgrip plugs and connector bodies.
- Controls cable arc-of-bend.
- Provides heavy-duty strain relief.
- Fits all sizes.



**I-Grips**

Cable Diameter Range Inches (cm)	E Inches (cm)	M Inches (cm)	Catalog Number
.32"-.43" (.81-1.09)	1.25" (3.17)	4" (10.16)	<b>07310001</b>
.43"-.56" (1.09-1.42)	1.25" (3.17)	4.75" (12.06)	<b>07310002</b>
.56"-.73" (1.42-1.85)	1.50" (3.81)	6" (15.24)	<b>07310003</b>
.73"-.85" (1.85-2.16)	1.50" (3.81)	6.5" (16.51)	<b>07310004</b>
.85"-1.00" (2.16-2.54)	1.50" (3.81)	8" (20.32)	<b>07310005</b>
1.00"-1.25" (2.54-3.17)	1.50" (3.81)	10" (25.40)	<b>07310006</b>

Note: E-Eye length. M-Mesh length at nominal diameter.

Eyelet hole diameter .203" (.52cm).

I-Grips should not be used on Insulgrip devices when "Seal-Tite®" weatherproof covers are to be installed.

# Kellems® Wire Management Products

## Thread Adapters for Multi-Pin Connectors

Aluminum

### Thread Adapters for Multi-Pin Connectors

Kellems® Thread Adapters are devices formatting AN-MS connectors and other multi-pin connectors to Kellems grips with NPT threaded fittings. They are made of aluminum with internal threads and replace the connector cord clamp. These adapters permit the installation of Kellems Grips, to prevent cable or conduit pull-out and control arc-of-bend.

### Applications

Thread adapters allow the installation of Kellems® Grips on multi-pin connectors at electrical consoles, mobile equipment, control switches, assembly equipment and testing machines.

### Benefits

- Easy installation.
- Allows the use of Kellems grips.
- Extends connector and cable life.

### Thread Adapters for Multi-Pin Connectors

Thread Adapters					Deluxe Cord Grips		Strain Relief Grips		Liquidtight Conduit Grips (Insulated Throat)
AN-MS Connector Size**	AN-MS Cable Clamp Number***	Thread Size A Inch	NPT Thread Size B	Catalog Number	Cable Diameter Range Inches (cm)	Catalog Number	Cable Diameter Range Inches (cm)	Catalog Number	Catalog Number
8S, 10S	3057-3	1/2" x 28"		<b>091041000</b>	.250"-.312" (.63-.79)	<b>07401001</b>			
10SL, 12, 12S	3057-4	5/8" x 24"	3/8"	<b>091041001</b>	.312"-.375" (.79-.95)	<b>07401002</b>			
14, 14S	3057-6	3/4" x 20"		<b>091041002</b>	.375"-.437" (.95-1.11)	<b>07401003</b>			
14, 14S	3057-6	3/4" x 20"		<b>091041003</b>	.187"-.250" (.47-.63)	<b>07401004</b>	.24"-.32" (.61-.81)	<b>073031200</b>	—
16, 16S	3057-8	7/8" x 20"	1/2"	<b>091041004</b>	.250"-.375" (.63-.95)	<b>07401006</b>	.32"-.43" (.81-1.09)	<b>073031201</b>	<b>074093512</b>
18	3057-10	1" x 20"		<b>091041006</b>	.375"-.500" (.95-1.27)	<b>07401008</b>	.43"-.54" (1.09-1.37)	<b>073031202</b>	—
					.500"-.625" (1.27-1.59)	<b>07401010*</b>			
16, 16S	3057-8	7/8" x 20"		<b>091041005</b>	.187"-.250" (.47-.63)	<b>07401011</b>			
18	3057-10	1" x 20"	3/4"	<b>091041007</b>	.250"-.375" (.63-.95)	<b>07401013</b>			
20, 22	3057-12	1 1/16" x 18"		<b>091041008</b>	.375"-.500" (.95-1.27)	<b>07401015</b>	.54"-.74" (1.37-1.85)	<b>073031203</b>	<b>074093513</b>
					.500"-.625" (1.27-1.59)	<b>07401017</b>			
					.625"-.750" (1.59-1.90)	<b>07401018</b>			
20, 22	3057-12	1 1/16" x 18"		<b>091041009</b>	.375"-.500" (.95-1.27)	<b>074011195</b>			
24, 28	3057-16	1 1/16" x 18"		<b>091041010</b>	.500"-.625" (1.27-1.59)	<b>07401019</b>			
32	3057-20	1 3/4" x 18"	1	<b>091041012</b>	.625"-.750" (1.59-1.90)	<b>07401021</b>	.73"-.97" (1.85-2.46)	<b>073031204</b>	<b>074093514</b>
36	3057-24	2" x 18"		<b>091041015</b>	.750"-.875" (1.90-2.22)	<b>07401023</b>			
					.875"-.1.000" (2.22-2.54)	<b>07401025</b>			
24, 28	3057-16	1 1/16" x 18"		<b>091041011</b>	.750"-.875" (1.90-2.22)	<b>074011251</b>			
32	3057-20	1 3/4" x 18"	1 1/4"	<b>091041013</b>	.875"-.1.000" (2.22-2.54)	<b>07401026</b>	.97"-.1.25" (2.46-3.17)	<b>073031205</b>	<b>074093515</b>
36	3057-24	2" x 18"		<b>091041016</b>	1.000"-.1.125" (2.54-2.86)	<b>07401027</b>			
					1.125"-.1.375" (2.86-3.17)	<b>07401028</b>			
32	3057-20	1 3/4" x 18"		<b>091041014</b>	.875"-.1.000" (2.22-2.54)	<b>07401029</b>			
36	3057-24	2" x 18"	1 1/2"	<b>091041017</b>	1.000"-.1.125" (2.54-2.86)	<b>07401030</b>		—	<b>074093516</b>
40	3057-28	2 1/4" x 16"		<b>091041019</b>	1.125"-.1.250" (2.86-3.17)	<b>07401031</b>			
					1.250"-.1.375" (3.17-3.49)	<b>07401032</b>			

Note: \*Cable jacket may have to be stripped to pass through connector body.

\*\*Number stamped on connector shell.

\*\*\*Number stamped on clamp shell.

### Example

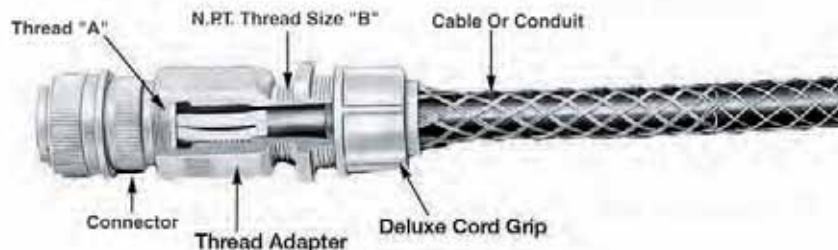

### Thread Adapter



091041006

# Kellems® Wire Management Products

## Strain Relief for Liquidtight Conduit

Steel Fitting, Stainless Steel Mesh for Liquidtight Metal Conduit and PolyTuff® I Non-Metallic Conduit



### Benefits

- Helps prevent conduit pull-out and damage at the fitting.
- Reduces equipment downtime.

### IMPORTANT

Read all breaking strength, safety and technical data relating to this product. Pages V-74 to V-76.

### Straight With Male Fitting



Conduit Trade Size Inches	NPT Fitting Size Inches	Mesh Length Inches (cm)	Catalog Number (Insulated)	Catalog Number (Non-insulated)
3/8	1/2	3" (7.62)	074093511	074093401
1/2	1/2	3.5" (8.89)	074093512	074093402
3/4	3/4	4" (10.16)	074093513	074093403
1	1	5" (12.70)	074093514	074093404
1 1/4	1 1/4	6" (15.24)	074093515	074093405
1 1/2	1 1/2	6.75" (17.14)	074093516	074093406
2	2	8" (20.32)	074093518	074093408
2 1/2	2 1/2	9.75" (24.76)	074093520	074093410
3	3	11" (27.94)	074093522	074093412
4	4	14" (35.56)	074093526	—

### 90° Angle With Male Fitting



Conduit Trade Size Inches	NPT Fitting Size Inches	Mesh Length Inches (cm)	Catalog Number (Insulated)	Catalog Number (Non-insulated)
3/8	1/2	3" (7.62)	074093541	074093421
1/2	1/2	3.5" (8.89)	074093542	074093422
3/4	3/4	4" (10.16)	074093543	074093423
1	1	5" (12.70)	074093544	074093424
1 1/4	1 1/4	6" (15.24)	074093545	074093425
1 1/2	1 1/2	6.75" (17.14)	074093546	074093426
2	2	8" (20.32)	074093548	074093428
2 1/2	2 1/2	9.75" (24.76)	074093550	—
3	3	11" (27.94)	074093552	—

Note: For use with Liquidtight Metal conduit and PolyTuff® I Non-Metallic conduit.



Kellems® Wire Management Products  
**Strain Relief for Liquidtight Conduit**



Steel Fitting, Stainless Steel Mesh for Liquidtight Metal Conduit and PolyTuff® I Non-Metallic Conduit

**IMPORTANT**  
 Read all breaking strength, safety and technical data relating to this product. Pages V-74 to V-76.

**Straight With Chase Fitting**

Conduit Trade Size Inches	NPT Fitting Size Inches	Mesh Length		Catalog Number
		Inches	(cm)	
1/2	1/2	3.5"	(8.89)	<b>07406079</b>
3/4	3/4	4"	(10.16)	<b>07406080</b>
1	1	5"	(12.70)	<b>07406081</b>
1 1/4	1 1/4	6"	(15.24)	<b>07406082</b>
1 1/2	1 1/2	6.75"	(17.14)	<b>07406083</b>



**45° Angle With Male Fitting**

Conduit Trade Size Inches	NPT Fitting Size Inches	Mesh Length		Catalog Number (Insulated)	Catalog Number (Non-insulated)
		Inches	(cm)		
3/8	1/2	3"	(7.62)	<b>074093561</b>	<b>074093441</b>
1/2	1/2	3.5"	(8.89)	<b>074093562</b>	<b>074093442</b>
3/4	3/4	4"	(10.16)	<b>074093563</b>	<b>074093443</b>
1	1	5"	(12.70)	<b>074093564</b>	<b>074093444</b>
1 1/4	1 1/4	6"	(15.24)	<b>074093565</b>	<b>074093445</b>
1 1/2	1 1/2	6.75"	(17.14)	<b>074093566</b>	<b>074093446</b>
2	2	8"	(20.32)	<b>074093568</b>	<b>074093448</b>



*Note: For use with Liquidtight Metal conduit and PolyTuff® I Non-Metallic conduit.*

**IMPORTANT**  
 Read all breaking strength, safety and technical data relating to this product.  
 Page V-76



### Straight Male Hubbell Fitting

Conduit Trade Size Inches	NPT Fitting Size Inches	Mesh Length		Catalog Number
		Inches	(cm)	
3/8	1/2	3.75"	(9.52)	H038CNK
1/2	1/2	4.5"	(11.43)	H050CNK
3/4	3/4	6.25"	(15.87)	H075CNK
1	1	7.5"	(19.05)	H100CNK
1 1/4	1 1/4	9"	(22.86)	H125CNK
1 1/2	1 1/2	13.5"	(34.29)	H150CNK
2	2	14.5"	(36.83)	H200CNK



### 90° Male Hubbell Fitting

Conduit Trade Size Inches	NPT Fitting Size Inches	Mesh Length		Catalog Number
		Inches	(cm)	
3/8	1/2	3.75"	(9.52)	H0389CNK
1/2	1/2	4.5"	(11.43)	H0509CNK
3/4	3/4	6.25"	(15.87)	H0759CNK
1	1	7.5"	(19.05)	H1009CNK
1 1/4	1 1/4	9"	(22.86)	H1259CNK
1 1/2	1 1/2	13.5"	(34.29)	H1509CNK
2	2	14.5"	(36.83)	H2009CNK

### Wire Mesh Grip Materials

Material	Features	Product Group
Galvanized steel wire	<ul style="list-style-type: none"> <li>• High strength</li> <li>• Not subject to continuous outside environment</li> </ul>	<ul style="list-style-type: none"> <li>• Strain relief grips</li> <li>• I-Grips</li> </ul>
Stainless steel wire (302/304)	<ul style="list-style-type: none"> <li>• High strength</li> <li>• Corrosion resistant</li> <li>• Slightly magnetic</li> </ul>	<ul style="list-style-type: none"> <li>• Deluxe cord grips</li> <li>• Liquidtight, flexible, metal conduit grips</li> <li>• UL type A conduit grips</li> </ul>
Non-metallic strand	<ul style="list-style-type: none"> <li>• Superior flex life</li> <li>• Non-conductive</li> <li>• Corrosion resistant</li> <li>• Moderate strength</li> </ul>	<ul style="list-style-type: none"> <li>• Non-metallic deluxe cord grips</li> </ul>

### Operating Temperatures

Material	Temperature Range
Aluminum	-40°F to +300°F (-40°C to +149°C).
Aluminum Deluxe Cord Grips	-30°F to +240°F (-34°C to +115°C).
Non-Metallic Deluxe Cord Grips	-30°F to +225°F (-34°C to +107°C).
Nylon	-40°F to +225°F (-40°C to +107°C).
Nylon Fitting with Stainless Steel Mesh	-40°F to +225°F (-40°C to +107°C).
Stainless Steel	-60°F to +1000°F (-51°C to +537°C).
Stainless Steel Deluxe Cord Grips	-30°F to +240°F (-34°C to +115°C).
Neoprene (Bushings)	-30°F to +240°F (-34°C to +115°C).

### Hazardous Locations

	Product Categories
The product categories listed to the right are suitable for use in hazardous locations per Class I Div. 2, Class II Div. 1 & 2, Class III Div. 1 & 2.	Deluxe cord grip, aluminum fitting; Deluxe cord grip, nylon fitting; Deluxe cord grip, non-metallic; Sealtite conduit grips; Dusttight strain relief grips.

### Flammability

Non-metallic deluxe cord grips will not support combustion. Listed below are the ratings.

Component	Rating
Mesh grip	UL 94HB.
Fitting	UL 94V-2.

### Approvals

UL Listing and CSA Certification are indicated on appropriate product catalog pages.

Agency	UL Control Number
Underwriters Laboratories Inc.	898D and 899D.
	UL Listed in accordance with Standard 514B for indoor/outdoor use.

### Wet Locations

	Product Categories
The products noted to the right are suitable for use in wet locations when a listed sealing ring is used between box and fitting.	Deluxe cord grip, aluminum fitting; Deluxe sealing ring cord grip; Deluxe cord grip, non-metallic; Sealtite conduit grips; Hubbell non-metallic conduit grips; Cord connectors; Hubbell Juniors; PolyTuff® connectors; Hubbell sealtite conduit connectors.

## Form Size Definition

The term "Form Size" refers to the physical mass or overall dimensions of a cord connector. Form 1 is the smallest size, Form 8 is the largest size.

## Knockout Holes

NPT Hub Size Inches	Knockout Hole Recommended Min. to Max. Inches (cm)
¼	.540" to .570" (1.37-1.45)
⅜	.671" to .701" (1.70-1.78)
½	.859" to .906" (2.18-2.30)
¾	1.094" to 1.141" (2.78-2.90)
1	1.359" to 1.406" (3.45-3.57)
1¼	1.719" to 1.766" (4.37-4.49)
1½	1.969" to 2.016" (5.00-5.12)
2	2.453" to 2.500" (6.23-6.35)
2½	2.953" to 3.000" (7.50-7.62)
3	3.578" to 3.625" (9.09-9.21)

## Product Data

### Deluxe Cord Grips, Liquidtight for Insulated Cables

Deluxe Cord Grips helps to alleviate pull tension on terminals, control cable arc-of-bend, prevent cord pull-out, and provide a liquidtight seal. They are offered with either aluminum, stainless steel or nylon fittings in a variety of configurations and NPT thread sizes. Additionally, a completely non-metallic product is offered on page V-61.

## Application

Deluxe Cord Grips are used indoors or outdoors to help prevent cord pull-out, and where cables are subjected to moisture, splash or submersion. Specific uses are: wiring enclosures, pendant stations, hand tools, construction, processing and material handling equipment, pumps, motors and machine tools.

## Benefits

- Helps to prevent cable pull-out.
- Controls cable arc-of-bend.
- Provides a liquidtight seal.
- Corrosion resistant stainless steel mesh with aluminum collar.

**Deluxe Cord Grips Fitting Dimensions**

**Straight Hubbell Connectors**

F NPT Inches	Aluminum, Inches (cm)						Nylon, Inches (cm)						Stainless Steel, Inches (cm)						
	A Form Dia.	B Ref.	C	D Throat Dia.	E		A Dia.	B Ref.	C	D Throat Dia.	E		A A/C*	B A/F*	C Ref.	D Throat Dia.	E		
3/8-18	1 .88" (2.24)	.90" (2.29)	.46" (1.17)	.44" (1.12)	.99" (2.51)	.88" (2.24)	1.00" (2.54)	1.10" (2.79)	.43" (1.09)	.45" (1.14)	1.00" (2.54)	.93" (2.36)	1.01" (2.57)	.88" (2.24)	.90" (2.29)	.46" (1.17)	.45" (1.14)	.87" (2.21)	.75" (1.90)
1/2-14	1 .88" (2.24)	.90" (2.29)	.46" (1.17)	.44" (1.12)	.99" (2.51)	.88" (2.24)	1.00" (2.54)	1.10" (2.79)	.43" (1.09)	.45" (1.14)	1.00" (2.54)	.93" (2.36)	—	—	—	—	—	—	—
1/2-14	2 1.13" (2.87)	1.10" (2.79)	.55" (1.40)	.64" (1.63)	1.11" (2.82)	1.00" (2.54)	1.32" (3.35)	1.50" (3.81)	.53" (1.35)	.58" (1.47)	1.25" (3.17)	1.12" (2.84)	1.30" (3.30)	1.13" (2.87)	1.10" (2.79)	.54" (1.37)	.63" (1.60)	1.16" (2.95)	1.00" (2.54)
1/2-14	3 1.38" (3.51)	1.50" (3.81)	.55" (1.40)	.64" (1.63)	1.40" (3.56)	1.25" (3.17)	—	—	—	—	—	—	—	—	—	—	—	—	—
3/4-14	2 1.13" (2.87)	1.10" (2.79)	.55" (1.40)	.64" (1.63)	1.29" (3.28)	1.13" (2.87)	—	—	—	—	—	—	—	—	—	—	—	—	—
3/4-14	3 1.38" (3.51)	1.50" (3.81)	.55" (1.40)	.82" (2.08)	1.40" (3.56)	1.25" (3.17)	1.56" (3.96)	1.60" (4.06)	.55" (1.40)	.77" (1.96)	1.44" (3.66)	1.31" (3.33)	1.59" (4.04)	1.38" (3.51)	1.30" (3.30)	.56" (1.42)	.81" (2.06)	1.44" (3.66)	1.25" (3.17)
1-11½	3 —	—	—	—	—	—	—	—	—	—	—	—	—	—	—	—	—	—	—
1-11½	4 1.75" (4.44)	1.60" (4.06)	.71" (1.80)	1.02" (2.59)	1.81" (4.60)	1.62" (4.11)	1.88" (4.78)	1.75" (4.44)	.70" (1.78)	1.01" (2.57)	1.84" (4.67)	1.63" (4.14)	2.02" (5.13)	1.75" (4.44)	1.40" (3.56)	.70" (1.78)	1.03" (2.62)	1.88" (4.78)	1.63" (4.14)
1-11½	5 2.31" (5.87)	1.70" (4.32)	.66" (1.68)	1.01" (2.57)	2.28" (5.79)	2.00" (5.08)	—	—	—	—	—	—	—	—	—	—	—	—	—
1¼-11½	5 2.31" (5.87)	1.70" (4.32)	.74" (1.88)	1.26" (3.20)	2.28" (5.79)	2.12" (5.38)	—	—	—	—	—	—	—	—	—	—	—	—	—
1½-11	5 2.31" (5.87)	1.70" (4.32)	.74" (1.88)	1.38" (3.51)	2.28" (5.79)	2.12" (5.38)	—	—	—	—	—	—	—	—	—	—	—	—	—
1½-11½	6 3.00" (7.62)	2.20" (5.59)	.75" (1.90)	1.50" (3.81)	2.97" (7.54)	2.75" (6.98)	—	—	—	—	—	—	—	—	—	—	—	—	—
2-11½	6 3.00" (7.62)	2.20" (5.59)	.80" (2.03)	1.92" (4.88)	3.24" (8.24)	3.00" (7.62)	—	—	—	—	—	—	—	—	—	—	—	—	—
2-11½	7 3.85" (9.78)	2.70" (6.86)	.88" (2.24)	1.94" (4.93)	4.05" (10.29)	3.75" (9.52)	—	—	—	—	—	—	—	—	—	—	—	—	—
2½-8	7 3.85" (9.78)	2.70" (6.86)	1.30" (3.30)	2.32" (5.89)	4.34" (11.02)	4.02" (10.21)	—	—	—	—	—	—	—	—	—	—	—	—	—
2½-8	8 4.75" (12.06)	2.70" (6.86)	1.25" (3.17)	2.38" (6.05)	4.86" (12.34)	4.50" (11.43)	—	—	—	—	—	—	—	—	—	—	—	—	—
3-8	7 3.85" (9.78)	2.70" (6.86)	1.30" (3.30)	2.54" (6.45)	4.34" (11.02)	4.01" (10.21)	—	—	—	—	—	—	—	—	—	—	—	—	—
3-8	8 4.50" (11.43)	2.70" (6.86)	1.38" (3.51)	3.00" (7.62)	4.86" (12.34)	4.50" (11.43)	—	—	—	—	—	—	—	—	—	—	—	—	—

Note: A/C—Across Corners; A/F—Across Flats.

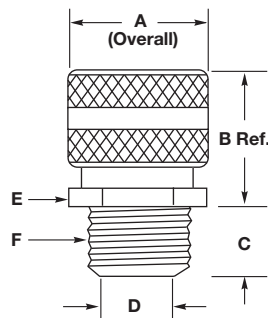

Dimensions shown are approximate and are subject to change without notice.

## Deluxe Cord Grips Fitting Dimensions

### 45° Hubbell Connectors

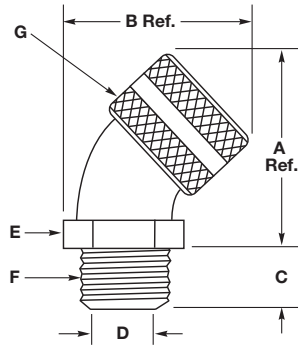

Aluminum, Inches (cm)

F NPT Inches	Form	A Ref.	B Ref.	C	D Throat Dia.	E		G Dia.
						Across Comers	Across Flats	
½-14	2	2.00" (5.08)	1.90" (4.83)	.550" (1.40)	.560" (1.42)	1.270" (3.23)	1.110" (2.79)	1.125" (2.86)
¾-14	3	2.30" (5.84)	2.50" (6.53)	.560" (1.42)	.750" (1.90)	1.480" (3.76)	1.281" (3.25)	1.375" (3.49)
1-11½	4	2.60" (6.60)	2.80" (7.11)	.700" (1.78)	1.000" (2.54)	1.690" (4.29)	1.500" (3.81)	1.750" (4.44)
1¼-11½	5	3.90" (9.91)	3.90" (9.91)	.740" (1.88)	1.250" (3.17)	2.45" (6.22)	2.125" (5.40)	2.310" (5.87)
1½-11½	5	3.90" (9.91)	3.90" (9.91)	.740" (1.88)	1.500" (3.81)	2.45" (6.22)	2.125" (5.40)	2.310" (5.87)

### 90° Hubbell Connectors

F NPT Inches	Aluminum, Inches (cm)							Nylon, Inches (cm)							
	Form	A	B Ref.	C	D Throat Dia.	E		G Dia.	A	B Ref.	C	D Throat Dia.	E		G Dia.
						A/C*	A/F*						A/C*	A/F*	
¾-18	1	1.27" (3.23)	2.00" (5.08)	.460" (1.17)	.440" (1.12)	1.15" (2.92)	1.10" (2.79)	.875" (2.22)	—	—	—	—	—	—	—
½-14	2	1.56" (3.96)	2.30" (5.84)	.500" (1.27)	.546" (1.39)	1.30" (3.30)	1.13" (2.87)	1.125" (2.86)	1.41" (3.58)	2.50" (6.35)	.550" (1.40)	.575" (1.46)	1.23" (3.12)	1.12" (2.82)	1.315" (3.34)
¾-14	3	1.79" (4.55)	2.80" (7.11)	.560" (1.42)	.765" (1.94)	1.49" (3.78)	1.31" (3.33)	1.375" (3.49)	1.65" (4.19)	2.81" (7.14)	.560" (1.42)	.765" (1.94)	1.42" (3.61)	1.29" (3.28)	1.560" (3.96)
1-11½	4	2.08" (5.28)	3.20" (8.13)	.700" (1.78)	1.000" (2.54)	1.70" (4.32)	1.50" (3.81)	1.750" (4.44)	1.99" (5.05)	3.30" (8.38)	.700" (1.78)	1.010" (2.57)	1.82" (4.62)	1.60" (4.06)	1.875" (4.76)
1¼-11½	5	3.18" (8.08)	4.30" (10.92)	.730" (1.85)	1.260" (3.20)	2.47" (6.27)	2.15" (5.46)	2.310" (5.87)	—	—	—	—	—	—	—
1½-11½	5	3.18" (8.08)	4.30" (10.92)	.750" (1.92)	1.500" (3.81)	2.47" (6.27)	2.15" (5.46)	2.310" (5.87)	—	—	—	—	—	—	—
2-11½	6	3.51" (8.92)	5.50" (13.97)	.800" (2.03)	1.920" (4.88)	2.98" (7.57)	2.78" (7.06)	3.000" (7.62)	—	—	—	—	—	—	—

Note: \*A/C - Across Corners; A/F - Across Flats.

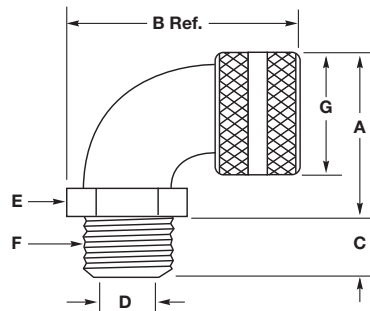

Dimensions shown are approximate and are subject to change without notice.

## Deluxe Cord Grips Fitting Dimensions

### Female Hubbell Connectors

Aluminum, Inches (cm)							
F NPT Inches	Form	A Dia.	B Ref.	C	D Throat Dia.	E	
						Across Comers	Across Flats
¾-18	1	.88" (2.24)	1.40" (3.56)	.560" (1.42)	.44" (1.12)	.94" (2.39)	.81" (2.06)
½-14	2	1.13" (2.87)	1.80" (4.57)	.560" (1.42)	.63" (1.60)	1.15" (2.92)	1.00" (2.54)
¾-14	2	1.13" (2.87)	2.10" (5.33)	.750" (1.90)	.63" (1.60)	1.44" (3.66)	1.25" (3.17)
1-11½	4	1.75" (4.44)	2.30" (5.84)	.880" (2.24)	1.10" (2.79)	1.88" (4.78)	1.63" (4.14)
1¼-11½	5	2.31" (5.87)	2.80" (7.11)	.950" (2.41)	1.43" (3.63)	2.64" (6.71)	2.29" (5.82)
1½-11½	5	2.31" (5.87)	2.80" (7.11)	.950" (2.41)	1.43" (3.63)	2.64" (6.71)	2.29" (5.82)

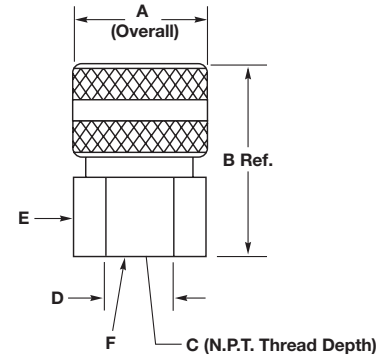

### Product Data

#### Dust-Tight Strain Relief Grips for Insulated Cables

Kellems® Strain Relief Grips connect flexible cord or bus drop cable to electrical enclosures. For indoor use only, they are available with either insulated or non-insulated aluminum fittings, and feature single weave, galvanized steel mesh grips with patented wide range mesh construction. They come with a locknut and a neoprene gasket that provides a dust tight seal.

#### Application

Used to connect electrical cable to power boxes, cabinets, panel boards, power centers, machine tools and with bus drop systems.

#### Benefits

- Helps prevent cord or cable pull-out.
- Provides a dust tight seal.
- Easy installation.
- Patented mesh construction.
- One piece design.

#### I-Grips for Insulated Cables

Kellems I-Grips are made of high strength, plastic coated galvanized steel strand. They are offered in six sizes to fit all cable diameters used with Hubbell Insulgrip®. Kellems I-Grips will control cable arc-of-bend and reduce high pull tensions from being transmitted to the wiring terminals.

#### Application

Kellems I-Grips will fit 2, 3, 4 and 5 wire Hubbell Insulgrip plugs and connector bodies. The eye tabs fit under the nylon cord clamp and the screws slide through the eyelets, securing the grip in place.

I-Grips can be used on any Insulgrip cord set which requires cable, arc-of-bend control or heavy duty strain relief. Cord sets used at in-door construction sites or for plant maintenance jobs are examples.

These grips are for indoor use only.

#### Benefits

- Easily attached to Insulgrip plugs and connector bodies.
- Fits all sizes.
- Provides heavy duty strain relief.
- Controls cable arc-of-bend.

*Note: I-Grips should not be used on Insulgrip devices when "Seal-Tite"® weatherproof covers are to be installed.*

*Dimensions shown are approximate and are subject to change without notice.*

## Strain Relief Grips for Liquidtight Flexible Metal and PolyTuff® I Non-Metallic Conduit

Kellems Liquidtight, Flexible Metal Conduit Grips are offered with high quality Hubbell plated steel fittings in a wide variety of NPT sizes and configurations, either insulated or non-insulated. The addition of a stainless steel mesh to these fittings makes them stronger than the conduit itself. Kellems Conduit Grips helps prevent conduit pull-out from the connecting fitting that is subject to stress, pull tension, vibration, motion or strain. They promote safe electrical systems and reduce equipment downtime.

### Application

Kellems Conduit Grips are used in the wiring of machine tools, motors, molding equipment, transformers, weaving and paper machines, fans, lighting, bakeries, breweries, food processing, chemical plants, dairies, mines and any application that requires Liquidtight Conduit.

### Benefits

- Helps prevent conduit pull-out and damage at the fitting.
- Reduces equipment downtime.
- Liquidtight fittings.
- Easily installed.
- Stainless steel grip resists corrosion.

Kellems Conduit Grips are suitable for use in hazardous locations per Class I Div. 2, Class II Div. 1 & 2, Class III Div. 1 & 2 of the National Electric Code.

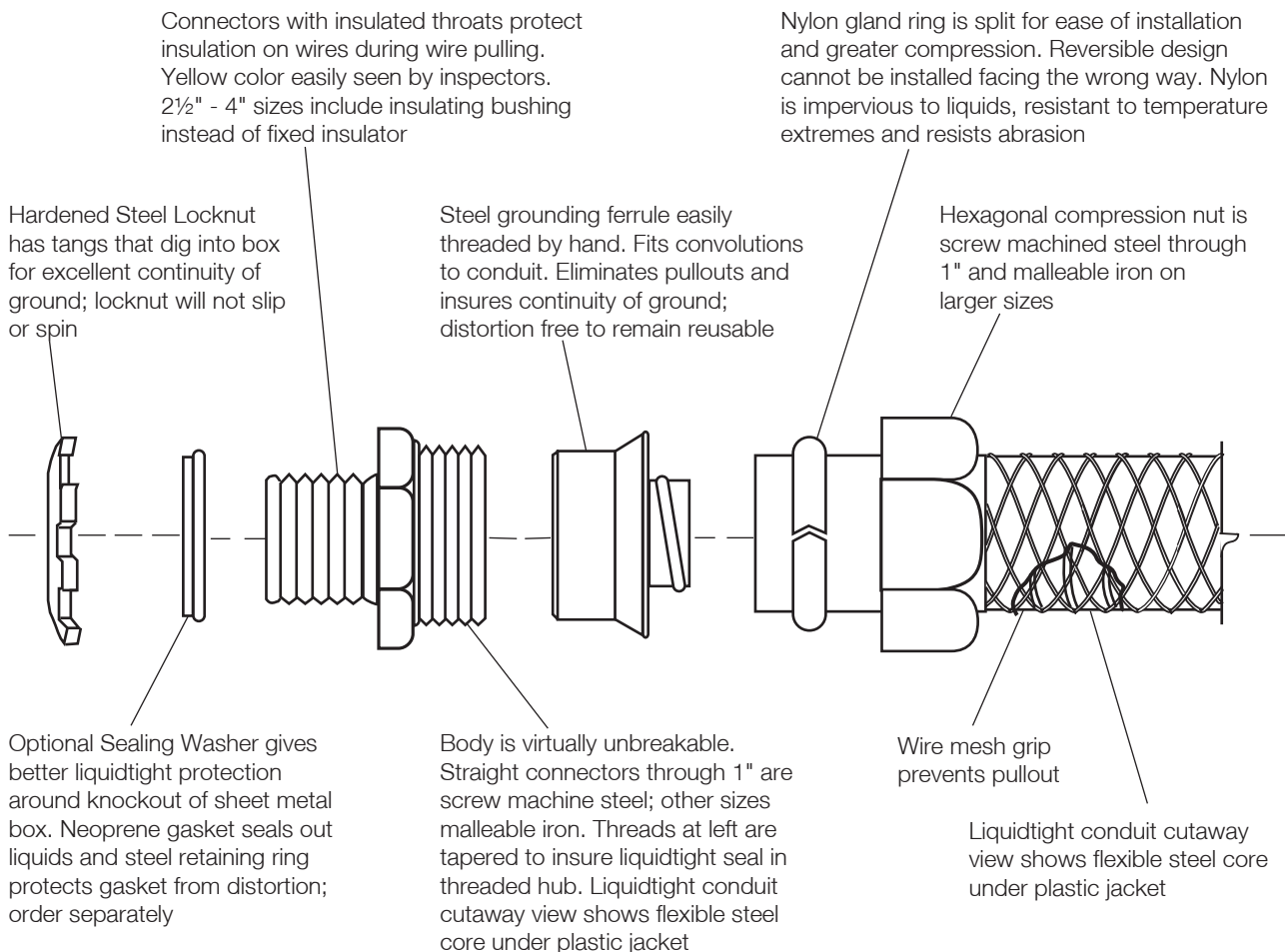



**Liquidtight Conduit Grip Fitting Dimensions, Inches**

**Straight with Male Fitting**

Dimensions, Inches								
Trade Size	A	B	C		D Throat Dia.	E		Catalog Number
Inches	Ref.	Ref.	A/C*	A/F*	A/C*	A/F*		
3/8	1.43"	.59"	1.20"	1.06"	.61"	1.07"	.93"	<b>074093401</b>
1/2	1.43"	.59"	1.34"	1.19"	.61"	1.22"	1.06"	<b>074093402</b>
3/4	1.56"	.59"	1.55"	1.37"	.84"	1.43"	1.25"	<b>074093403</b>
1	1.68"	.66"	1.95"	1.69"	1.06"	1.73"	1.56"	<b>074093404</b>
1 1/4	2.03"	.63"	2.39"	2.06"	1.37"	2.36"	2.08"	<b>074093405</b>
1 1/2	2.21"	.63"	2.72"	2.38"	1.53"	2.79"	2.48"	<b>074093406</b>
2	2.28"	.69"	3.08"	2.87"	2.06"	3.32"	2.90"	<b>074093408</b>

**Straight with Male Fitting with Insulated Throat**

Dimensions, Inches								
Trade Size	A	B	C		D Throat Dia.	E		Catalog Number
Inches	Ref.	Ref.	A/C*	A/F*	A/C*	A/F*		
3/8	1.50"	.66"	1.20"	1.06"	.57"	1.07"	.93"	<b>074093511</b>
1/2	1.50"	.66"	1.34"	1.19"	.57"	1.22"	1.06"	<b>074093512</b>
3/4	1.62"	.66"	1.55"	1.38"	.78"	1.43"	1.25"	<b>074093513</b>
1	1.75"	.72"	1.95"	1.69"	.98"	1.73"	1.56"	<b>074093514</b>
1 1/4	2.09"	.69"	2.39"	2.06"	1.29"	2.36"	2.08"	<b>074093515</b>
1 1/2	2.28"	.69"	2.72"	2.37"	1.53"	2.79"	2.48"	<b>074093516</b>
2	2.34"	.75"	3.08"	2.87"	1.95"	3.32"	2.90"	<b>074093518</b>
2 1/2	3.56"	1.06"	3.92"	3.62"	2.42"	3.85"	3.60"	<b>074093520</b>
3	3.81"	1.06"	4.70"	4.31"	3.01"	4.65"	4.33"	<b>074093522</b>
4	3.81"	1.06"	5.75"	5.31"	3.96"	5.75"	5.39"	<b>074093526</b>

**45° Angle with Male Fitting**

Dimensions, Inches									
Trade Size	H	J	K	L		M Throat Dia.	N		Catalog Number
Inches	Ref.	Ref.	Ref.	A/C*	A/F*	A/C*	A/F*		
3/8	1.19"	1.28"	.59"	1.20"	1.06"	.60"	1.16"	1.02"	<b>074093441</b>
1/2	1.19"	1.28"	.59"	1.34"	1.19"	.61"	1.21"	1.06"	<b>074093442</b>
3/4	1.19"	1.43"	.59"	1.55"	1.45"	.84"	1.50"	1.32"	<b>074093443</b>
1	1.38"	1.53"	.66"	1.95"	1.69"	1.05"	1.82"	1.59"	<b>074093444</b>
1 1/4	1.42"	1.69"	.63"	2.39"	2.06"	1.37"	2.32"	2.03"	<b>074093445</b>
1 1/2	1.66"	2.00"	.66"	2.72"	2.38"	1.60"	2.62"	2.29"	<b>074093446</b>
2	1.69"	2.25"	.66"	3.08"	2.88"	2.05"	3.21"	2.80"	<b>074093448</b>

**45° Angle with Male Fitting with Insulated Throat**

Dimensions, Inches									
Trade Size	H	J	K	L		M Throat Dia.	N		Catalog Number
Inches	Ref.	Ref.	Ref.	A/C*	A/F*	A/C*	A/F*		
3/8	1.25"	1.28"	.66"	1.20"	1.06"	.57"	1.16"	1.02"	<b>074093561</b>
1/2	1.25"	1.28"	.66"	1.34"	1.19"	.57"	1.21"	1.06"	<b>074093562</b>
3/4	1.25"	1.44"	.66"	1.55"	1.45"	.78"	1.50"	1.32"	<b>074093563</b>
1	1.44"	1.53"	.72"	1.95"	1.69"	.98"	1.82"	1.59"	<b>074093564</b>
1 1/4	1.48"	1.69"	.69"	2.39"	2.06"	1.29"	2.32"	2.03"	<b>074093565</b>
1 1/2	1.72"	2.00"	.72"	2.72"	2.38"	1.53"	2.62"	2.29"	<b>074093566</b>
2	1.75"	2.25"	.72"	3.08"	2.87"	1.95"	3.21"	2.80"	<b>074093568</b>

**90° Angle with Male Fitting**

Dimensions, Inches									
Trade Size	D	E	F		G	O Throat Dia.	P		Catalog Number
Inches	Ref.	Ref.	A/C*	A/F*	Ref.	A/C*	A/F*		
3/8	1.31"	.59"	1.20"	1.06"	1.44"	.60"	1.13"	.99"	<b>074093421</b>
1/2	1.31"	.59"	1.34"	1.12"	1.44"	.61"	1.21"	1.00"	<b>074093422</b>
3/4	1.44"	.59"	1.55"	1.45"	1.63"	.83"	1.48"	1.29"	<b>074093423</b>
1	1.78"	.66"	1.95"	1.60"	2.19"	1.05"	1.80"	1.57"	<b>074093424</b>
1 1/4	1.97"	.63"	2.39"	2.06"	2.50"	1.37"	2.32"	2.02"	<b>074093425</b>
1 1/2	2.19"	.66"	2.72"	2.38"	2.69"	1.61"	2.58"	2.25"	<b>074093426</b>
2	2.53"	.66"	3.08"	2.87"	3.25"	2.05"	3.14"	2.75"	<b>074093428</b>

**90° Angle with Male Fitting with Insulated Throat**

Dimensions, Inches									
Trade Size	D	E	F		G	O Throat Dia.	P		Catalog Number
Inches	Ref.	Ref.	A/C*	A/F*	Ref.	A/C*	A/F*		
3/8	1.38"	.66"	1.20"	1.06"	1.44"	.60"	1.13"	.99"	<b>074093541</b>
1/2	1.38"	.66"	1.34"	1.12"	1.44"	.57"	1.21"	1.00"	<b>074093542</b>
3/4	1.50"	.66"	1.55"	1.45"	1.63"	.78"	1.48"	1.29"	<b>074093543</b>
1	1.84"	.66"	1.95"	1.60"	2.19"	.98"	1.80"	1.57"	<b>074093544</b>
1 1/4	2.03"	.69"	2.39"	2.06"	2.50"	1.29"	2.32"	2.02"	<b>074093545</b>
1 1/2	2.25"	.69"	2.72"	2.38"	2.69"	1.53"	2.58"	2.20"	<b>074093546</b>
2	2.59"	.72"	3.08"	2.87"	3.25"	1.95"	3.14"	2.75"	<b>074093548</b>
2 1/2	3.44"	1.00"	3.92"	3.63"	4.25"	2.42"	3.78"	3.50"	<b>074093550</b>
3	3.75"	1.00"	4.70"	4.31"	4.87"	3.01"	4.64"	4.30"	<b>074093552</b>

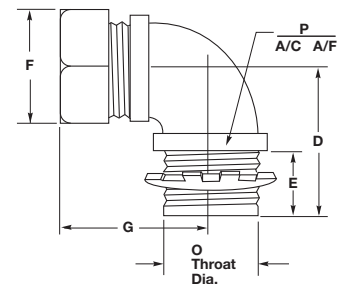
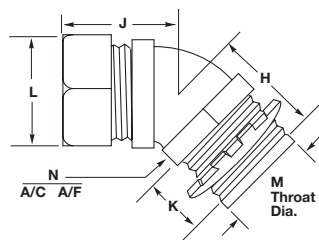
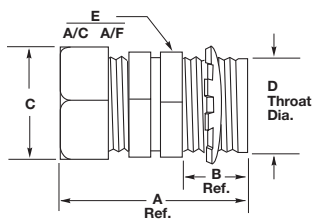

Note: \*A/C - Across Corners; A/F - Across Flats.

Dimensions shown are approximate and are subject to change without notice.

**Strain Relief for UL Type A, Flexible, Liquidtight Conduit**

Kellems Grips for UL Type A, non-metallic, flexible, liquidtight conduit are available in straight and 90° male and feature a high quality Hubbell plated steel or malleable iron fitting, complete with a sealing O-ring, lock nut and stainless steel mesh. These grips increase the retention of the conduit in the fitting, control its arc-of-bend and provide a liquidtight seal.

**Application**

These grips are used on UL Type A non-metallic conduit connections at limit switches, motor boxes, panel boards, control stations and on all types of machinery and machine tools.

Steel Locknut has tangs that dig into box for excellent continuity of ground; locknut will not slip or spin

Neoprene O-ring is factory assembled into the body to seal out liquids

Insulated throat protects insulation on wires during pulling; yellow color easily seen by inspectors

Yellow nylon ferrule fits inside non-metallic conduit to hold the shape; barb in designed to assure liquidtight seal even with non-square cut; ferrule is keyed to fit into body to prevent conduit twisting

**Benefits**

- Provides a liquidtight seal.
- Helps prevent conduit pull-out.
- Reduces conduit cutting, kinking, fraying and splitting at the fitting.
- Easily installed.

Body is virtually unbreakable. Straight connectors through 1" are screw machine steel; other sizes are malleable iron. Threads are tapered to insure liquidtight seal when used in threaded hub; octagonal shape inside holds the ferrule to prevent conduit from twisting during installation

Wire mesh grip prevents pullout

Hexagonal compression nut is machine steel through 1" malleable iron on larger sizes; tapered interior compresses sleeve over conduit sealing out liquids and preventing pullout

Yellow nylon sleeve installs over conduit; six slits in sleeve permit tight compression onto conduit as compression nut is tightened

**Dimensional Charts For UL Type A, Liquidtight Conduit Grip Fittings**

**Straight with Male Fitting with Insulated Throat**

Dimensions Inches (cm)

Trade Size NPT Inches	A	B	C	D	Catalog Number
3/8	1.922" (4.88)	.594" (1.51)	1.156" (2.94)	3.75" (9.52)	<b>H038CNK</b>
1/2	1.922" (4.88)	.594" (1.51)	1.250" (3.17)	4.50" (11.43)	<b>H050CNK</b>
3/4	2.016" (5.12)	.594" (1.51)	1.500" (3.81)	6.25" (15.87)	<b>H075CNK</b>
1	2.157" (5.48)	.719" (1.83)	1.844" (4.68)	7.50" (19.05)	<b>H100CNK</b>
1 1/4	2.219" (5.64)	.750" (1.91)	2.312" (5.87)	9.00" (22.86)	<b>H125CNK</b>
1 1/2	2.344" (5.95)	.750" (1.91)	2.578" (6.55)	13.50" (34.29)	<b>H150CNK</b>
2	2.406" (6.11)	.750" (1.91)	3.187" (8.09)	14.50" (36.83)	<b>H200CNK</b>

**90° Angle with Male Fitting with Insulated Throat**

Dimensions Inches (cm)

Trade Size NPT Inches	E	F	G	H	I	Catalog Number
3/8	1.250" (3.18)	.594" (1.51)	1.156" (2.94)	1.453" (3.69)	3.75" (9.52)	<b>H0389CNK</b>
1/2	1.281" (3.25)	.594" (1.51)	1.250" (3.17)	1.453" (3.69)	4.50" (11.43)	<b>H0509CNK</b>
3/4	1.438" (3.65)	.594" (1.51)	1.500" (3.81)	1.000" (2.54)	6.25" (15.87)	<b>H0759CNK</b>
1	1.750" (4.44)	.719" (1.83)	1.844" (4.68)	2.125" (5.40)	7.50" (19.05)	<b>H1009CNK</b>
1 1/4	1.969" (5.00)	.750" (1.91)	2.312" (5.87)	2.344" (5.95)	9.00" (22.86)	<b>H1259CNK</b>
1 1/2	2.250" (5.71)	.750" (1.91)	2.578" (6.55)	2.500" (6.35)	13.50" (34.29)	<b>H1509CNK</b>
2	2.531" (6.43)	.750" (1.91)	3.187" (8.09)	2.781" (7.06)	14.50" (36.83)	<b>H2009CNK</b>

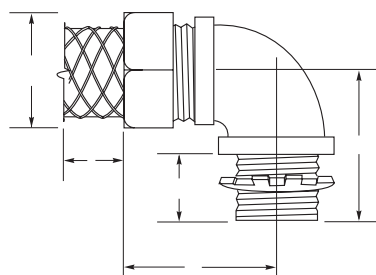
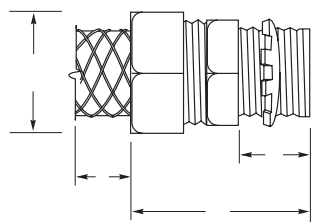

# Kellems® Wire Management Products

## Cord Connectors

Features and Benefits

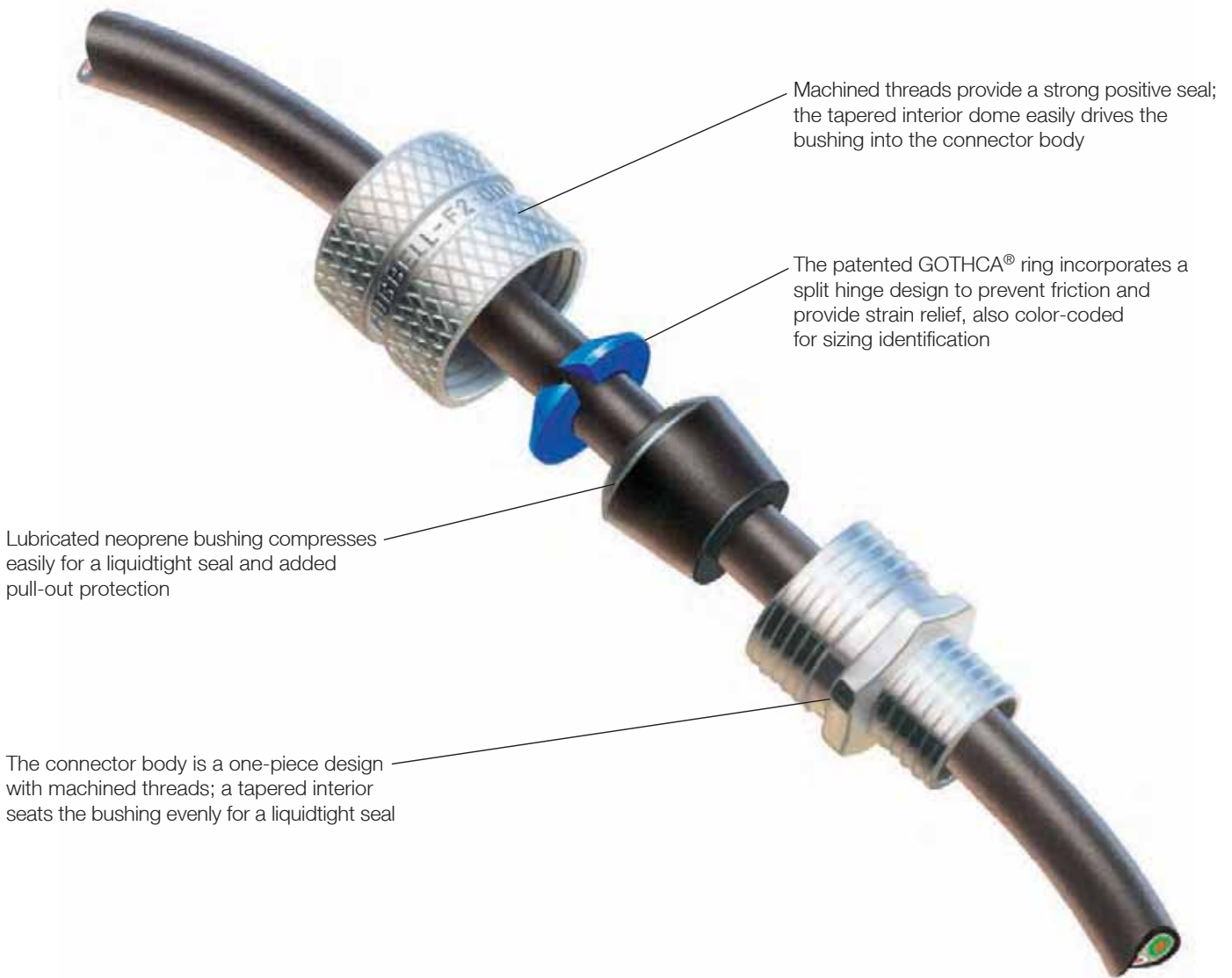

Hubbell has the broadest line and the widest choice of materials in the industry. NPT hub sizes from ¼" to 3" in straight male end, 90°, 45°, female and underground feed connectors. They are available in your choice of aluminum, plated steel, nylon and stainless steel.

Hubbell offers a full line of machined aluminum cord connectors in NPT hub sizes ¼" through 1" and cast aluminum 1" to 3". They provide durable performance and a clean attractive look without adding unwanted weight. NPT hub sizes ¼" to 1" feature an attractive knurled finish which makes them easy to handle and maintain a U.L. listing by hand tightening.

The zinc-plated steel cord connectors offers the strength of steel and the corrosion resistance of zinc-plating. These heavy-duty connectors hold up to most manufacturing chemicals including acid solutions, solvents and other corrosive materials.

Their machined steel nut and body allows for tightening the compression nut and NPT hub without worrying about stripping the threads. For larger size cord, NPT hub sizes 1" to 2", Hubbell utilizes malleable iron connectors which provide excellent holding and liquidtight performance.

Hubbell's nylon cord connectors resist most common industrial corrosives and provide highly effective pullout protection in a lightweight design. They are ideal for any application where weight, conductivity or corrosion may be an issue. They're available in NPT hub sizes from ¼" to 1".

Stainless steel cord connectors provide superior strength and corrosion resistance for industrial and military applications. They are machined from 300 series stainless steel and come in ¼" to 1", NPT hub sizes.

**IP66\***  
 SUITABILITY

**Straight Male**

	NPT Hub Size	Cord Dia. Inches (mm)	Form Size	Color Code	Machined Aluminum	Machined Zinc-Plated Steel	Stainless Steel	Nylon Gray	Nylon Black
 Machined Aluminum	¼	.06"-.13" (1.6-3.2)	F1	Green	—	—	—	SHC1001CR	—
		.13"-.19" (3.2-4.7)		Orange	SHC1002	—	—	SHC1002CR	—
		.19"-.25" (4.7-6.3)		Red	SHC1003	—	SHC1003SS	SHC1003CR	—
		.25"-.31" (6.3-7.9)		Black	SHC1004	—	SHC1004SS	SHC1004CR	—
		.31"-.38" (7.9-9.5)		White	SHC1005**	—	—	SHC1005CR	SHC2005CR
		.38"-.44" (9.5-11)		Blue	—	—	—	SHC1006CR	—
 Machined Zinc-Plated Steel	¾	.06"-.13" (1.6-3.2)	F1	Green	SHC1007	—	—	—	—
		.13"-.19" (3.2-4.7)		Orange	SHC1008	SHC1008ZP	—	SHC1008CR	SHC2008CR
		.19"-.25" (4.7-6.3)		Red	SHC1009	—	SHC1009SS	SHC1009CR	—
		.25"-.31" (6.3-7.9)		Black	SHC1010	SHC1010ZP	—	SHC1010CR	SHC2010CR
		.31"-.38" (7.9-9.5)		White	SHC1011	—	SHC1011SS	SHC1011CR	SHC2011CR
		.38"-.44" (9.5-11.0)		Blue	SHC1012	SHC1012ZP	SHC1012SS	SHC1012CR	SHC2012CR
 Stainless Steel	½	.19"-.25" (4.7-6.3)	F1	Red	SHC1015	—	—	—	—
		.25"-.31" (6.3-7.9)		Black	SHC1016	—	—	—	—
		.31"-.38" (7.9-9.5)		White	SHC1017	—	—	—	—
		.38"-.44" (9.5-11.0)		Blue	SHC1018	—	—	—	—
 Gray Nylon	½	.06"-.13" (1.6-3.2)	F2	Green	SHC1019	—	—	SHC1019CR	—
		.13"-.19" (3.2-4.7)		Orange	SHC1020	SHC1020ZP	SHC1020SS	SHC1020CR	—
		.19"-.25" (4.7-6.3)		Red	SHC1021	SHC1021ZP	SHC1021SS	SHC1021CR	SHC2021CR
		.25"-.38" (6.3-9.7)		White	SHC1022	SHC1022ZP	SHC1022SS	SHC1022CR	SHC2022CR
		.38"-.50" (9.7-12.7)		Blue	SHC1023	SHC1023ZP	SHC1023SS	SHC1023CR	SHC2023CR
 Black Nylon	½	.50"-.63" (12.7-15.9)	F3	Brown	SHC1024	SHC1024ZP	SHC1024SS	SHC1024CR**	SHC2024CR**
		.38"-.50" (9.7-12.7)		Blue	SHC1025	—	—	—	—
		.50"-.63" (12.7-15.9)		Brown	SHC1026	—	—	—	—
		.63"-.75" (15.9-19.0)		Yellow	SHC1027**	SHC1027ZP**	—	—	—
.75"-.88" (19.0-22.2)	Orchid	SHC1028**	SHC1028ZP**	—	—	—			

Note: See pages V-87 to V-95 for technical information and dimensional drawings.  
 \*IP66 Suitability when used with optional metal clad O-ring, see page V-84 for additional information.  
 \*\*Cable jacket may have to be stripped to pass through connector body.  
 Locknuts sold separately. See page V-84 for additional information.

**IP66\***  
 SUITABILITY

**Straight Male**

NPT Hub Size	Cord Dia. Inches (mm)	Form Size	Color Code	Machined Aluminum	Machined Zinc-Plated Steel	Stainless Steel	Nylon Gray	Nylon Black
3/4	.06"-.13" (1.6-3.2)	F2	Green	<b>SHC1029</b>	—	—	—	—
	.13"-.19" (3.2-4.7)		Orange	<b>SHC1030</b>	<b>SHC1030ZP</b>	—	—	—
	.19"-.25" (4.7-6.3)		Red	<b>SHC1031</b>	<b>SHC1031ZP</b>	—	—	—
	.25"-.38" (6.3-9.7)		White	<b>SHC1032</b>	<b>SHC1032ZP</b>	—	—	—
	.38"-.50" (9.7-12.7)		Blue	<b>SHC1033</b>	<b>SHC1033ZP</b>	—	—	—
	.50"-.63" (12.7-15.9)		Brown	<b>SHC1034</b>	<b>SHC1034ZP</b>	—	—	—
3/4	.38"-.50" (9.5-12.7)	F3	Blue	—	<b>SHC1035ZP</b>	<b>SHC1035SS</b>	<b>SHC1035CR</b>	<b>SHC2035CR</b>
	.50"-.63" (12.7-15.9)		Brown	<b>SHC1036</b>	—	<b>SHC1036SS</b>	<b>SHC1036CR</b>	<b>SHC2036CR</b>
	.63"-.75" (15.9-19.0)		Yellow	<b>SHC1037</b>	<b>SHC1037ZP</b>	<b>SHC1037SS</b>	<b>SHC1037CR</b>	<b>SHC2037CR</b>
	.75"-.88" (19.0-22.2)		Orchid	<b>SHC1038**</b>	<b>SHC1038ZP**</b>	<b>SHC1038SS**</b>	<b>SHC1038CR**</b>	<b>SHC2038CR**</b>
1	.50"-.63" (12.7-15.9)	F3	Brown	—	<b>SHC1097ZP</b>	—	—	—
	.63"-.75" (15.9-19.0)		Yellow	—	<b>SHC1098ZP</b>	—	—	—
	.75"-.88" (19.0-22.2)		Orchid	—	<b>SHC1099ZP</b>	—	—	—
1	.38"-.50" (9.7-12.7)	F4	Blue	<b>SHC1039</b>	—	—	<b>SHC1039CR</b>	—
	.50"-.63" (12.7-15.9)		Brown	<b>SHC1040</b>	—	—	<b>SHC1040CR</b>	<b>SHC2040CR</b>
	.63"-.75" (15.9-19.0)		Yellow	<b>SHC1041</b>	—	<b>SHC1041SS</b>	<b>SHC1041CR</b>	<b>SHC2041CR</b>
	.75"-.88" (19.0-22.2)		Orchid	<b>SHC1042</b>	—	<b>SHC1042SS</b>	<b>SHC1042CR</b>	<b>SHC2042CR</b>
	.88"-.1.00" (22.2-25.4)		Gray	<b>SHC1043</b>	<b>SHC1043ZP</b>	<b>SHC1043SS</b>	<b>SHC1043CR</b>	<b>SHC2043CR</b>
	1.00"-.1.13" (25.4-28.6)		Pink	<b>SHC1044**</b>	—	<b>SHC1044SS**</b>	<b>SHC1044CR**</b>	<b>SHC2044CR**</b>



Machined Aluminum



Machined Zinc-Plated Steel



Stainless Steel



Gray Nylon



Black Nylon

Note: See pages V-87 to V-95 for technical information and dimensional drawings.  
 \*IP66 Suitability when used with optional metal clad O-ring, see page V-84 for additional information.  
 \*\*Cable jacket may have to be stripped to pass through connector body.  
 Form 4 aluminum and plated steel nuts are machined, bodies are cast aluminum.  
 Locknuts sold separately. See page V-84 for additional information.

**IP66\***  
 SUITABILITY

**Straight Male**



Cast Aluminum



Cast Aluminum  
 Malleable Iron

NPT Hub Size	Cord Diameter Inches	(mm)	Form Size	Cast Aluminum	Malleable Iron
1	.88"-1.00"	(22.2-25.4)	F5	SHC1046	—
	1.00"-1.13"	(25.4-28.6)		SHC1047**	—
	1.13"-1.25"	(28.6-31.7)		SHC1048**	—
	1.25"-1.38"	(31.7-34.9)		SHC1049**	—
1¼	.75"-.88"	(19.0-22.2)	F5	SHC1050	—
	.88"-1.00"	(22.2-25.4)		SHC1051	—
	1.00"-1.13"	(25.4-28.6)		SHC1052	SHC1052ZP
	1.13"-1.25"	(28.6-31.7)		SHC1053	SHC1053ZP
	1.25"-1.38"	(31.7-34.9)		SHC1054**	SHC1054ZP
1½	.75"-.88"	(19.0-22.2)	F5	SHC1055	—
	.88"-1.00"	(22.2-25.4)		SHC1056	—
	1.00"-1.13"	(25.4-28.6)		SHC1057	SHC1057ZP
	1.13"-1.25"	(28.6-31.7)		SHC1058	SHC1058ZP
	1.25"-1.38"	(31.7-34.9)		SHC1059	SHC1059ZP
1½	1.38"-1.50"	(34.9-38.1)	F6	SHC1061	—
	1.50"-1.63"	(38.1-41.3)		SHC1062**	—
	1.63"-1.75"	(41.3-44.4)		SHC1063**	—
	1.75"-1.88"	(44.4-47.6)		SHC1064**	—
2	1.25"-1.38"	(31.7-34.9)	F6	SHC1065	—
	1.38"-1.50"	(34.9-38.1)		SHC1066	—
	1.50"-1.63"	(38.1-41.3)		SHC1067	—
	1.63"-1.75"	(41.3-44.4)		SHC1068	—
	1.75"-1.88"	(44.4-47.6)		SHC1069	—
2	1.69"-1.81"	(42.9-46.0)	F7	SHC1070	—
	1.81"-1.94"	(46.0-49.2)		SHC1071	—
	1.94"-2.06"	(49.2-52.4)		SHC1072**	—
	2.06"-2.19"	(52.4-55.6)		SHC1073**	—
	2.19"-2.31"	(55.6-58.7)		SHC1074**	—
2½	1.69"-1.81"	(42.9-46.0)	F7	SHC1076	—
	1.81"-1.94"	(46.0-49.2)		SHC1077	—
	1.94"-2.06"	(49.2-52.4)		SHC1078	—
	2.06"-2.19"	(52.4-55.6)		SHC1079	—
	2.19"-2.31"	(55.6-58.7)		SHC1080	—
	2.31"-2.44"	(58.7-61.9)		SHC1081**	—
3	1.69"-1.81"	(42.9-46.0)	F7	SHC1086	—
	1.94"-2.06"	(49.2-52.4)		SHC1088	—
	2.06"-2.19"	(52.4-55.6)		SHC1089	—
	2.19"-2.31"	(55.6-58.7)		SHC1090	—
	2.31"-2.44"	(58.7-61.9)		SHC1091	—
3	2.44"-2.63"	(61.9-66.7)	F8	SHC1092	—
	2.63"-2.81"	(66.7-71.4)		SHC1093	—
	2.81"-3.00"	(71.4-76.2)		SHC1094	—
	3.00"-3.25"	(76.2-82.5)		SHC1095**	—

Note: See pages V-87 to V-95 for technical information and dimensional drawings.  
 \*IP66 Suitability when used with optional metal clad O-ring, see page V-84 for additional information.  
 \*\*Cable jacket may have to be stripped to pass through connector body.  
 Form 4 aluminum and plated steel nuts are machined, bodies are cast aluminum.  
 F5 and larger will not be color coded.  
 Locknuts sold separately. See page V-84 for additional information.

**IP66\***  
 SUITABILITY



**45° Male**

NPT Hub Size	Cord Diameter		Form Size	Color Code	Machined Aluminum†	Machined Zinc-Plated SteelΔ	Cast Aluminum
	Inches	(mm)					
1/2	.19"-.25"	(4.7-6.3)	F2	Red	<b>VHC1021</b>	—	—
	.25"-.38"	(6.3-9.7)		White	<b>VHC1022</b>	<b>VHC1022ZP</b>	—
	.38"-.50"	(9.7-12.7)		Blue	<b>VHC1023</b>	<b>VHC1023ZP</b>	—
	.50"-.63"	(12.7-15.9)		Brown	<b>VHC1024**</b>	<b>VHC1024ZP**</b>	—
3/4	.38"-.50"	(9.7-12.7)	F3	Blue	<b>VHC1035</b>	—	—
	.50"-.63"	(12.7-15.9)		Brown	<b>VHC1036</b>	—	—
	.63"-.75"	(15.9-19.0)		Yellow	<b>VHC1037**</b>	—	—
1	.63"-.75"	(15.9-19.0)	F4	Yellow	<b>VHC1041</b>	—	—
	.75"-.88"	(19.0-22.2)		Orchid	<b>VHC1042</b>	—	—
1 1/4	1.00"-1.13"	(25.4-28.6)	F5	—	—	—	<b>VHC1052</b>
	1.13"-1.25"	(28.6-31.7)		—	—	—	<b>VHC1053**</b>



**90° Male**

NPT Hub Size	Cord Diameter		Form Size	Color Code	Machined Aluminum†	Machined Zinc-Plated SteelΔ	Nylon Gray	Nylon Black	Cast Aluminum
	Inches	(mm)							
3/8	.25"-.31"	(6.3-7.9)	F1	Black	<b>NHC1010</b>	—	—	—	—
	.31"-.38"	(7.9-9.5)		White	<b>NHC1011</b>	—	—	—	—
	.38"-.44"	(9.5-11.0)		Blue	<b>NHC1012</b>	—	—	—	—
1/2	.06"-.13"	(1.6-3.2)	F2	Green	—	—	—	—	—
	.13"-.19"	(3.2-4.7)		Orange	<b>NHC1020</b>	—	<b>NHC1020CR</b>	—	—
	.19"-.25"	(4.7-6.3)		Red	<b>NHC1021</b>	<b>NHC1021ZP</b>	<b>NHC1021CR</b>	—	—
	.25"-.38"	(6.3-9.7)		White	<b>NHC1022</b>	<b>NHC1022ZP</b>	<b>NHC1022CR</b>	<b>NHC2022CR</b>	—
	.38"-.50"	(9.7-12.7)		Blue	<b>NHC1023</b>	<b>NHC1023ZP</b>	<b>NHC1023CR</b>	<b>NHC2023CR</b>	—
	.50"-.63"	(12.7-15.9)		Brown	<b>NHC1024**</b>	<b>NHC1024ZP**</b>	<b>NHC1024CR**</b>	<b>NHC2024CR**</b>	—
3/4	.38"-.50"	(9.7-12.7)	F3	Blue	<b>NHC1035</b>	<b>NHC1035ZP</b>	<b>NHC1035CR</b>	—	—
	.50"-.63"	(12.7-15.9)		Brown	<b>NHC1036</b>	<b>NHC1036ZP</b>	<b>NHC1036CR</b>	—	—
	.63"-.75"	(15.9-19.0)		Yellow	<b>NHC1037</b>	<b>NHC1037ZP</b>	<b>NHC1037CR</b>	—	—
	.75"-.88"	(19.0-22.2)		Orchid	<b>NHC1038</b>	<b>NHC1038ZP</b>	<b>NHC1038CR</b>	—	—
1	.50"-.63"	(12.7-15.9)	F4	Brown	<b>NHC1040</b>	—	—	—	—
	.63"-.75"	(15.9-19.0)		Yellow	<b>NHC1041</b>	<b>NHC1041ZP</b>	<b>NHC1041CR</b>	<b>NHC2041CR</b>	—
	.75"-.88"	(19.0-22.2)		Orchid	<b>NHC1042</b>	—	<b>NHC1042CR</b>	<b>NHC2042CR**</b>	—
	.88"-.1.00"	(22.2-25.4)		Gray	<b>NHC1043**</b>	—	<b>NHC1043CR</b>	<b>NHC2043CR**</b>	—
	1.00"-1.13"	(25.4-28.7)		Pink	<b>NHC1044**</b>	—	—	—	—
1 1/4	.88"-.1.00"	(22.2-25.4)	F5	—	—	—	—	—	<b>NHC1051</b>
	1.00"-1.13"	(25.4-28.6)		—	—	—	—	—	<b>NHC1052</b>
	1.13"-1.25"	(28.6-31.7)		—	—	—	—	—	<b>NHC1053**</b>
	1.25"-1.38"	(31.7-34.9)		—	—	—	—	—	<b>NHC1054**</b>
1 1/2	1.00"-1.13"	(25.4-28.6)	F5	—	—	—	—	—	<b>NHC1057</b>
	1.13"-1.25"	(28.6-31.7)		—	—	—	—	—	—
	1.25"-1.38"	(31.7-34.9)		—	—	—	—	—	<b>NHC1059</b>
2	1.38"-1.50"	(34.9-38.1)	F6	—	—	—	—	<b>NHC1066</b>	

Note: See pages V-87 to V-95 for technical information and dimensional drawings.  
 \*IP66 Suitability when used with optional metal clad O-ring, see page V-84 for additional information.  
 \*\*Cable jacket may have to be stripped to pass through connector body.  
 †Nuts are machined aluminum and bodies are cast aluminum.  
 ΔCompression nuts are machined zinc-plated steel and bodies are zinc-plated malleable iron.  
 Locknuts sold separately. See page V-84 for additional information.

# Kellems® Wire Management Products

## Straight Female, Underground Feeder and Metric Connectors

Form Size 1-4



Machined Aluminum

### Straight Female

NPT Hub Size	Cord Diameter Inches	(mm)	Form Size	Color Code	Machined Aluminum
1/2	.25"-.38"	(6.3-9.7)	F2	White	<b>FHC1022</b>
	.38"-.50"	(9.7-12.7)		Blue	<b>FHC1023</b>
3/4	.38"-.50"	(9.7-12.7)	F2	Blue	<b>FHC1033</b>
	.50"-.63"	(12.7-15.9)		Brown	<b>FHC1034</b>
1	.75"-.88"	(19.0-22.2)	F4	Orchid	<b>FHC1042†</b>
	.88"-1.00"	(22.2-25.4)		Gray	<b>FHC1043†</b>

Note: See pages V-87 to V-95 for technical information and dimensional drawings.

\*Cable jacket may have to be stripped to pass through connector body.

†Nuts are machined aluminum and bodies are cast aluminum.



Machined Aluminum

IP66\*  
SUITABILITY



### Underground Feeder Connectors

NPT Hub Size	Cord Diameter Inches	(mm)	Wire Size	UF** Machined Aluminum	Machined Zinc-Plated Steel	Nylon Gray	Nylon Black
1/2	.2"x.4" min	(5.1 x 10.2)	2 # 14,	<b>UFC0001</b>	<b>UFC0001ZP</b>	<b>UFC0001CR</b>	<b>UFC2001CR</b>
	.25"-.55" max	(6.3 x 14.0)	2 # 12, 2 # 10.				
3/4	.2"x.4" min	(5.1x10.2)	2 # 14,	<b>UFC0002</b>	—	—	—
	.25"-.55" max	(6.3x14.0)	2 # 12, 2 # 10.				
3/4	.2"x.6" min	(5.1x15.2)	3 # 14,	<b>UFC0003</b>	—	<b>UFC0003CR</b>	<b>UFC2003CR</b>
			3 # 12,				
			3 # 10.				

Note: See pages V-87 to V-95 for technical information and dimensional drawings.

\*IP66 Suitability when used with optional metal clad O-ring, see page V-84 for additional information.

\*\*Wire sizes vary among manufacturers.

Locknuts sold separately, see page V-84 for additional information.



Gray Nylon

UL Listed to Type 4,  
4X, 12 and Type 13 †

### Metric Aluminum Cord Connectors

NPT Hub Size	Cord Diameter Inches	(mm)	Form Size	Catalog Number
M16	.31"-.38"	(7.9-9.7)	F1	<b>SHCM161011</b>
M20	.31"-.38"	(7.9-9.7)	F1	<b>SHCM201017</b>
	.25"-.38"	(6.3-9.7)	F2	<b>SHCM201022</b>
M20	.38"-.50"	(9.7-12.7)		<b>SHCM201023</b>
	.50"-.62"	(12.7-15.8)		<b>SHCM201024</b>
M25	.38"-.50"	(9.7-12.7)	F2	<b>SHCM251033</b>
	.50"-.62"	(12.7-15.8)		<b>SHCM251034</b>
M30	.63"-.75"	(15.9-19.0)	F3	<b>SHCM301037</b>

Note: †When used with metal clad O-ring, see page V-84 for additional information.

Non-metallic Locknuts sold separately, see page V-84 for additional information.



Machined Aluminum



**IP66\***  
 SUITABILITY

### Low Profile NPT Cord Connectors

NPT Hub Size	Cord Diameter Inches	(mm)	Color	Catalog Number	Non-metallic Locknuts
3/8	.18"-.31"	(4.6-7.9)	Gray	SEC38GA*	31622002LPK50
3/8	.18"-.31"	(4.6-7.9)	Black	SEC38BA*	31622002LPK50
1/2	.17"-.45"	(4.3-11.4)	Gray	SEC50GA	31622003LPK50
1/2	.17"-.45"	(4.3-11.4)	Black	SEC50BA	31622003LPK50
3/4	.45"-.71"	(11.4-18.0)	Gray	SEC75GA	31622007LPK50
3/4	.45"-.71"	(11.4-18.0)	Black	SEC75BA	31622007LPK50
1	.59"-1.00"	(15-25.4)	Gray	SEC100GA	31622008LPK50
1	.59"-1.00"	(15-25.4)	Black	SEC100BA	31622008LPK50

Note: See pages V-87 to V-95 for technical information and dimensional drawings.  
 Catalog numbers with "PK50" suffix are bulk packed 50 pieces.



SEC100BA

### Low Profile PG<sup>A</sup> Cord Connectors

Hub Size	Cord Diameter Inches	(mm)	Color	Catalog Number	Non-metallic Locknuts
PG7	.11"-.25"	(2.9-6.4)	Gray	SECP7GA*	LNP7BPK100
PG7	.11"-.25"	(2.9-6.4)	Black	SECP7BA*	LNP7BPK100
PG9	.18"-.31"	(4.6-7.9)	Gray	SECP9GA*	LNP9BPK100
PG9	.18"-.31"	(4.6-7.9)	Black	SECP9BA*	LNP9BPK100
PG11	.23"-.40"	(5.8-10.0)	Gray	SECP11GA*	LNP11BPK100
PG11	.23"-.40"	(5.8-10.0)	Black	SECP11BA*	LNP11BPK100
PG13.5	.17"-.47"	(4.3-11.9)	Gray	SECP13GA	LNP13BPK100
PG13.5	.17"-.47"	(4.3-11.9)	Black	SECP13BA	LNP13BPK100
PG16	.23"-.53"	(5.8-13.5)	Gray	SECP16GA	LNP16BPK100
PG16	.23"-.53"	(5.8-13.5)	Black	SECP16BA	LNP16BPK100
PG21	.45"-.71"	(11.4-17.9)	Gray	SECP21GA	LNP21BPK100
PG21	.45"-.71"	(11.4-17.9)	Black	SECP21BA	LNP21BPK100
PG29	.59"-.99"	(15-25.2)	Gray	SECP29GA	LNP29BPK25
PG29	.59"-.99"	(15-25.2)	Black	SECP29BA	LNP29BPK25
PG36	.88"-1.30"	(22.2-32.0)	Gray	SECP36GA	LNP36BPK25
PG36	.88"-1.30"	(22.2-32.0)	Black	SECP36BA	LNP36BPK25



SECP29GA

### Low Profile Metric Cord Connectors

Hub Size	Cord Diameter Inches	(mm)	Color	Catalog Number	Non-metallic Locknuts
M12	.12"-.25"	(2.9-6.4)	Gray	SECM12G	LNM12BPK100
M12	.12"-.25"	(2.9-6.4)	Black	SECM12B	LNM12BPK100
M16	.11"-.31"	(2.7-7.9)	Gray	SECM16G	LNM16BPK100
M16	.11"-.31"	(2.7-7.9)	Black	SECM16B	LNM16BPK100
M20	.17"-.45"	(4.3-11.4)	Gray	SECM20G*	LNM20BPK100
M20	.17"-.45"	(4.3-11.4)	Black	SECM20B*	LNM20BPK100
M25	.49"-.71"	(12.3-18.0)	Gray	SECM25G*	LNM25BPK100
M25	.49"-.71"	(12.3-18.0)	Black	SECM25B*	LNM25BPK100
M32	.59"-1.00"	(15.0-25.4)	Gray	SECM32G*	LNM32BPK100
M32	.59"-1.00"	(15.0-25.4)	Black	SECM32B*	LNM32BPK100
M40	.87"-1.30"	(22.0-32.0)	Gray	SECM40G	LNM40BPK100
M40	.87"-1.30"	(22.0-32.0)	Black	SECM40B	LNM40BPK100



LNP29BPK25

Note: See pages V-87 to V-96 for technical information and dimensional drawings.  
 Catalog numbers above with "PK100" suffix, i.e. LNP7BPK100, are bulk packed 100 per carton.  
 Catalog numbers above with "PK25" suffix, i.e. LNP29BPK25, are bulk packed 25 per carton.  
 \*Items indicated are UL recognized components.  
 ΔPanzergewinde.



SEC100BSMH9

### Multi-Hole Cord Grip Connectors

NPT Hub Size	Cord Diameter Inches	(mm)	Color	Holes	Catalog Number
1/2	.205"	(5.2mm)	Black	2	SEC50B252
3/4	.205"	(5.2mm)	Black	3	SEC75B352
3/4	.205"	(5.2mm)	Black	4	SEC75B452
1/2	.220"	(5.6mm)	Black	3	SEC50B356
1	.215"	(5.5mm)	Black	9*	SEC100BSMH9
1 1/4	.215"	(5.5mm)	Black	13*	SEC125BSMH13

Note: \*Skinned bushings, field configurable.

### Cord Connector Parts

NPT Hub Size	Cord Diameter Inches	(mm)	Form Size	Bushing Catalog Number	Color Code	GOTCHA® Ring Catalog Number
1/4, 3/8, 1/2	.062"-.125"	(1.58-3.17)	F1	31518101BPK100	Green	31648035GPK100
	.125"-.187"	(3.17-4.76)		31518102BPK100	Orange	31648036GPK100
	.187"-.250"	(4.76-6.35)		31518103BPK100	Red	31648037GPK100
	.250"-.312"	(6.35-7.93)		31518104BPK100	Black	31648038GPK100
	.312"-.375"	(7.93-9.50)		31518105BPK100	White	31605010GPK100
	.375"-.437"	(9.50-11.1)		31518106BPK100	Blue	31648039GPK100
1/2, 3/4	.187"-.250"	(4.76-6.35)	F2	31518110BPK100	Red	31648042GPK100
	.250"-.375"	(6.35-9.50)		31518111BPK100	White	31605015GPK100
	.375"-.500"	(9.50-12.7)		31518112BPK100	Blue	31648043GPK100
	.500"-.625"	(12.7-15.8)		31518113BPK100	Brown	31648044GPK100
1/2, 3/4	.375"-.500"	(9.50-12.7)	F3	31518116BPK100	Blue	31648045GPK100
	.500"-.625"	(12.7-15.8)		31518117BPK100	Brown	31648046GPK100
	.625"-.750"	(15.8-19.0)		31518118BPK100	Yellow	31648047GPK100
	.750"-.875"	(19.0-22.2)		31518119BPK100	Orchid	31648048GPK100
1	.500"-.625"	(12.7-15.8)	F4	31518123BPK100	Brown	31648050GPK100
	.625"-.750"	(15.8-19.0)		31518124BPK100	Yellow	31648051GPK100
	.750"-.875"	(19.0-22.2)		31518125BPK100	Orchid	31648052GPK100
	.875"-.1.00"	(22.2-25.4)		31518126BPK100	Gray	31648053GPK100
	1.00"-.1.125"	(25.4-28.5)		31518127BPK100	Pink	31648054GPK100

Note: Catalog numbers above with \*PK100\* suffix, i.e. 31518101BPK100, are bulk packed 100 per carton

### Locknuts and Metal Clad Sealing O-Rings

NPT Hub Size	Zinc-Plated Steel Locknuts	Non-Metallic Locknuts	Metal Clad Sealing O-Rings*
1/4	—	31622001LPK50	—
3/8	—	31622002LPK50	—
1/2	00322001LPK50	31622003LPK50	20509001
3/4	00322002LPK50	31622007LPK50	20509002
1	00322003LPK50	31622008LPK50	20509003
1 1/4	00322004LPK50	—	20509004
1 1/2	00322005LPK50	—	20509005
2	—	—	20509006
2 1/2	—	—	20509007
3	—	—	20509008

Note: Catalog numbers above with \*PK50\* suffix, i.e. 00322001LPK50, are bulk packed 50 per carton.

See page V-96 for technical information and dimensional drawings.

\*UL listed and CSA certified.

Kellems® Wire Management Products  
**Hubbell Juniors® Miniature Connectors**  
*Features and Benefits*

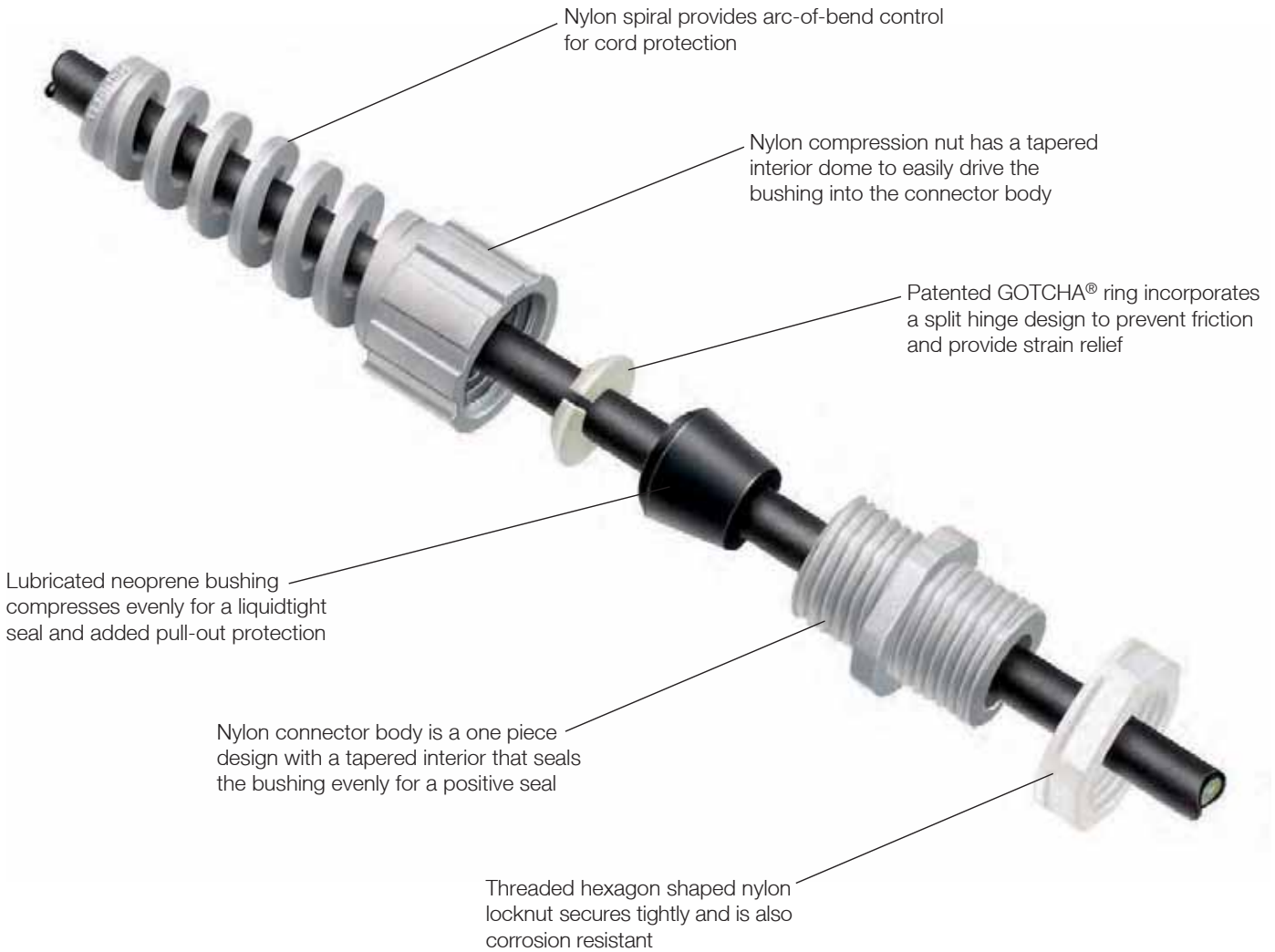

Hubbell Juniors are a miniature liquidtight version of the full-sized Hubbell cord connectors. They feature the same GOTCHA® ring technology and neoprene bushings.

They also come with or without a nylon spiral for arc-of-bend control and longer cord life. They are available in ¼", ⅜", and ½" NPT sizes in both gray and black.



Gray Cord Connector



Black Cord Connector



Gray Cord Connector with Spiral



Black Cord Connector with Spiral



Gray Snap-In Cord Connector



Black Snap-In Cord Connector

### Miniature Nylon Cord Connector

NPT Hub Size	Cord Diameter Range		Gray	Black
	Inches	(mm)		
¼	.08"-.14"	(1.9-3.4)	HJ1001GPK25	HJ1001BPK25
	.14"-.20"	(3.4-5.1)	HJ1002GPK25	HJ1002BPK25
	.20"-.27"	(5.1-6.7)	HJ1003GPK25	HJ1003BPK25
⅜	.15"-.21"	(3.7-5.3)	HJ1004GPK25	HJ1004BPK25
	.21"-.28"	(5.3-7.0)	HJ1005GPK25	HJ1005BPK25
	.28"-.34"	(7.0-8.6)	HJ1006GPK25	HJ1006BPK25
½	.06"-.13"	(1.6-3.2)	HJ1055GPK25	HJ1055BPK25
	.13"-.19"	(3.2-4.7)	HJ1056GPK25	HJ1056BPK25
	.19"-.25"	(4.7-6.3)	HJ1057GPK25	HJ1057BPK25
	.25"-.31"	(6.3-7.9)	HJ1058GPK25	HJ1058BPK25
	.31"-.38"	(7.9-9.5)	HJ1059GPK25	HJ1059BPK25
	.38"-.44"	(9.5-11.1)	HJ1060GPK25	HJ1060BPK25

### Miniature Nylon Cord Connector with Spiral

NPT Hub Size	Cord Diameter Range		Gray	Black
	Inches	(mm)		
¼	.08"-.14"	(1.9-3.4)	HJ1010GPK25	HJ1010BPK25
	.14"-.20"	(3.4-5.1)	HJ1011GPK25	HJ1011BPK25
	.20"-.27"	(5.1-6.7)	HJ1012GPK25	HJ1012BPK25
⅜	.15"-.21"	(3.7-5.3)	HJ1013GPK25	HJ1013BPK25
	.21"-.28"	(5.3-7.0)	HJ1014GPK25	HJ1014BPK25
	.28"-.34"	(7.0-8.6)	HJ1015GPK25	HJ1015BPK25
½	.13"-.19"	(3.2-4.7)	HJ1038GPK25	HJ1038BPK25
	.19"-.25"	(4.7-6.3)	HJ1039GPK25	HJ1039BPK25
	.25"-.31"	(6.3-7.9)	HJ1040GPK25	HJ1040BPK25
	.31"-.38"	(7.9-9.5)	HJ1041GPK25	HJ1041BPK25
	.38"-.44"	(9.5-11.1)	HJ1042GPK25	HJ1042BPK25
	¾	.25"-.49"	(6.4-12.3)	HJ1043GPK25*
.45"-.71"		(11.4-18.0)	HJ1044GPK25*	HJ1044BPK25*

Note: \*Locknuts sold separately, see page V-84 for additional information.

### Miniature Nylon Snap-In Cord Connector with Spiral

Cord Diameter Range	Inches	(mm)	For Chassis Thickness	Gray	Black
.22"-.27"	(5.6-6.9)	.10" (2.5) Max	HS1001GPK25	HS1001BPK25	
.28"-.32"	(7.1-8.1)	.10" (2.5) Max	HS1002GPK25	HS1002BPK25	
.30"-.36"	(7.6-9.1)	.13" (3.2) Max	HS1003GPK25	HS1003BPK25	
.32"-.43"	(8.1-10.9)	.13" (3.2) Max	HS1004GPK25	HS1004BPK25	

Note: Catalog numbers above with \*PK25\* suffix, i.e. HJ1001GPK25, are bulk packed 25 per carton. See page V-97 for technical information and dimensional drawings.

## Operating Temperatures

Material	Temperature Range	
Aluminum	-40°F to +300°F	(-40°C to +149°C)
Nylon (connectors and GOTCHA® rings)	-40°F to +225°F	(-40°C to +107°C)
Plated steel*	-60°F to +1000°F	(-51°C to +537°C)
Stainless steel*	-60°F to +1000°F	(-51°C to +537°C)
Neoprene (bushings)	-30°F to +240°F	(-34°C to +115°C)

*Note: \*Due to the limiting factors of nylon and neoprene, any complete cord connector with a GOTCHA ring, Form 1-5, will continuously perform in the range of -30°F to +225°F (-34°C to +107°C).*

*Cord connectors without GOTCHA rings, Form 6-8, will continuously operate in the range -30°F to +240°F (-34°C to +115°C) due to the limiting factor of neoprene.*

## Hazardous Locations

Hubbell cord connectors are suitable for use in hazardous locations per Class I Div. 2, Class II Div. 1 & 2, Class III Div. 1 & 2 in accordance with the NEC.

## Flammability

Hubbell nylon cord connectors have a UL 94-V2 rating.

## Approvals

### Agency

UL Listed in accordance with Standard 514B for indoor/outdoor use.

CSA Certified.

United States Coast Guard Approved, Title 46-Part 111.

## Form Size Definition

The term "Form Size" refers to the physical overall size of a cord connector.

Form 1 is the smallest size.

Form 8 is the largest size.

## Knockout Holes

NPT Hub Size	Knockout Hole Recommended		Knockout Hole Recommended		Knockout Hole Recommended	
	Min. to Max. Inches	(mm)	PG Hub Size	Inches (mm)	Metric Hub Size	Inches (mm)
¼	.54"-.57"	(13.7-14.5)	PG7	.492" (12.5)	M12	.472" (12)
⅜	.67"-.70"	(17.0-17.8)	PG9	.599" (15.2)	M16	.629" (16)
½	.86"-.91"	(21.8-23.0)	PG11	.733" (18.6)	M20	.787" (20)
¾	1.04"-1.09"	(26.4-27.8)	PG13.5	.804" (20.4)	M25	.984" (25)
1	1.36"-1.41"	(34.5-35.7)	PG16	.888" (22.5)	M32	1.25" (32)
1¼	1.72"-1.77"	(43.7-44.9)	PG21	1.15" (28.3)	M40	1.57" (40)
1½	1.97"-2.02"	(50.0-51.2)	PG29	1.47" (34.3)		
2	2.45"-2.50"	(62.3-63.5)	PG36	1.85" (47.0)		
2½	2.95"-3.00"	(75.0-76.2)				
3	3.58"-3.63"	(90.9-92.1)				

## NPT, PG and Metric Thread Low Profile Connectors

### Specifications

Material	6/6 Nylon.
Gland	Buna N.
Temperature Range	-22°F to 225°F (-30°C to 107°C). Cord Connectors are Halogen and Silicon free.
Protection Class	IP66 Suitability.
Flammability	UL 94V-2.
Listings/Certifications	UL Listing File E-41567, UL Recognition File E-41567. CSA File LR27378C, VDE Marks Licence #136681.



SECP29G

**Straight Hubbell Connectors**

F NPT Inches	Aluminum Inches (mm)						Nylon Inches (mm)						
	Form	A	B	C	D Throat Dia.	E		A	B	C	D Throat Dia.	E	
		Dia.	Ref.			A/C*	A/F*	Dia.	Ref.			A/C*	A/F*
¼-18	1	.88" (22.4)	.90" (22.9)	.46" (11.7)	.32" (8.1)	.99" (25.1)	.88" (22.4)	1.00" (25.4)	1.10" (27.9)	.43" (10.9)	.33" (8.4)	1.00" (25.4)	.93" (23.6)
⅜-18	1	.88" (22.4)	.90" (22.9)	.46" (11.7)	.44" (11.2)	.99" (25.1)	.88" (22.4)	1.00" (25.4)	1.10" (27.9)	.43" (10.9)	.45" (11.4)	1.00" (25.4)	.93" (23.6)
½-14	1	.88" (22.4)	.90" (22.9)	.46" (11.7)	.44" (11.2)	1.00" (25.4)	.88" (22.4)	1.00" (25.4)	1.10" (27.9)	.46" (11.7)	.45" (11.4)	1.00" (25.4)	.93" (23.6)
½-14	2	1.13" (28.7)	1.10" (27.9)	.55" (14.0)	.64" (16.3)	1.11" (28.2)	1.00" (25.4)	1.32" (33.5)	1.50" (38.1)	.53" (13.5)	.58" (14.7)	1.25" (31.7)	1.12" (28.4)
½-14	3	1.38" (35.1)	1.50" (38.1)	.55" (14.0)	.64" (16.3)	1.40" (35.6)	1.25" (31.7)	—	—	—	—	—	—
¾-14	2	1.13" (28.7)	1.10" (27.9)	.55" (14.0)	.64" (16.3)	1.29" (32.8)	1.13" (28.7)	—	—	—	—	—	—
¾-14	3	1.38" (35.1)	1.50" (38.1)	.55" (14.0)	.82" (20.8)	1.40" (35.6)	1.25" (31.7)	1.56" (39.6)	1.60" (40.6)	.55" (14.0)	.77" (19.6)	1.44" (36.6)	1.31" (33.3)
1-11½	4	1.75" (44.4)	1.60" (40.6)	.71" (18.0)	1.02" (25.9)	1.81" (46.0)	1.62" (41.1)	1.88" (47.8)	1.75" (44.4)	.70" (17.8)	1.01" (25.7)	1.84" (46.7)	1.63" (41.4)
1-11½	5	2.31" (58.7)	1.70" (43.2)	.66" (16.8)	1.01" (25.7)	2.28" (57.9)	2.00" (50.8)	—	—	—	—	—	—
1¼-11½	5	2.31" (58.7)	1.70" (43.2)	.74" (18.8)	1.26" (32.0)	2.28" (57.9)	2.12" (53.8)	—	—	—	—	—	—
1½-11½	5	2.31" (58.7)	1.70" (43.2)	.74" (18.8)	1.38" (35.1)	2.28" (57.9)	2.12" (53.8)	—	—	—	—	—	—
1½-11½	6	3.00" (76.2)	2.20" (55.9)	.75" (19.0)	1.50" (38.1)	2.97" (75.4)	2.75" (69.8)	—	—	—	—	—	—
2-11½	6	3.00" (76.2)	2.20" (55.9)	.80" (20.3)	1.92" (48.8)	3.24" (82.4)	3.00" (76.2)	—	—	—	—	—	—
2-11½	7	3.85" (97.8)	2.70" (68.6)	.88" (22.4)	1.94" (49.3)	4.05" (102.9)	3.75" (95.2)	—	—	—	—	—	—
2½-8	7	3.85" (97.8)	2.70" (68.6)	1.30" (33.0)	2.32" (58.9)	4.34" (110.2)	4.02" (102.1)	—	—	—	—	—	—
2½-8	8	4.75" (120.6)	2.70" (68.6)	1.25" (31.7)	2.38" (60.5)	4.86" (123.4)	4.50" (114.3)	—	—	—	—	—	—
3-8	7	3.85" (97.8)	2.70" (68.6)	1.30" (33.0)	2.54" (64.5)	4.34" (110.2)	4.02" (102.1)	—	—	—	—	—	—
3-8	8	4.50" (114.3)	2.70" (68.6)	1.38" (35.1)	3.00" (76.2)	4.86" (123.4)	4.50" (114.3)	—	—	—	—	—	—

Note: \*A/C— Across Corners; A/F—Across Flats.

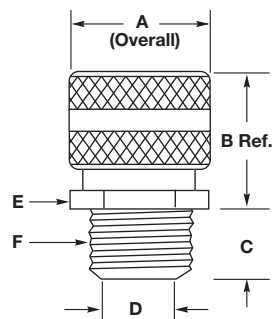

Dimensions shown are approximate and are subject to change without notice.

**Straight Hubbell Connectors**

F NPT Inches	Zinc-Plated Steel Inches (mm)								Stainless Steel Inches (mm)							
	Form	A		B	C	D Throat Dia.	E		A		B	C	D Throat Dia.	E		
		A/C*	A/F*	Ref.			A/C*	A/F*	A/C*	A/F*	Ref.			A/C*	A/F*	
¼- 18	1	—	—	—	—	—	—	—	1.01" (25.7)	.88" (22.4)	.90" (22.9)	.46" (11.7)	.38" (9.7)	.87" (22.1)	.75" (19.0)	
¾-18	1	.98" (24.9)	.88" (22.4)	.90" (22.9)	.42" (10.7)	.45" (11.4)	.99" (25.1)	.88" (22.4)	1.01" (25.7)	.88" (22.4)	.90" (22.9)	.46" (11.7)	.45" (11.4)	.87" (22.1)	.75" (19.0)	
½-14	1	.98" (24.9)	.88" (22.4)	.90" (22.9)	.55" (14.0)	.45" (11.4)	1.00" (25.4)	.88" (22.4)	—	—	—	—	—	—	—	
½-14	2	1.27" (32.3)	1.13" (28.7)	1.20" (30.5)	.55" (14.0)	.64" (16.3)	1.10" (28.2)	1.00" (25.4)	1.30" (33.0)	1.13" (28.7)	1.10" (27.9)	.54" (13.7)	.63" (16.0)	1.16" (29.5)	1.00" (25.4)	
½-14	3	1.55" (39.4)	1.38" (35.1)	1.50" (38.1)	.55" (14.0)	.64" (16.3)	1.40" (35.6)	1.25" (31.7)	—	—	—	—	—	—	—	
¾-14	2	1.27" (32.3)	1.13" (28.7)	1.20" (30.5)	.55" (14.0)	.64" (16.3)	1.29" (32.8)	1.13" (28.7)	—	—	—	—	—	—	—	
¾-14	3	1.55" (39.4)	1.38" (35.1)	1.40" (35.6)	.55" (14.0)	.82" (20.8)	1.40" (35.6)	1.25" (31.7)	1.59" (40.4)	1.38" (35.1)	1.30" (33.0)	.56" (14.2)	.81" (20.6)	1.44" (36.6)	1.25" (31.7)	
1-1½	3	1.55" (39.4)	1.38" (35.1)	1.40" (35.6)	.70" (17.8)	.89" (22.6)	1.54" (39.1)	1.38" (35.1)	—	—	—	—	—	—	—	
1-1½	4	1.92" (48.8)	1.69" (42.9)	1.60" (40.6)	.70" (17.8)	1.02" (25.9)	1.95" (49.5)	1.69" (42.9)	2.02" (51.3)	1.75" (44.4)	1.40" (35.6)	.70" (17.8)	1.03" (26.2)	1.88" (47.8)	1.63" (41.4)	
1-1½	5	2.40" (61.0)	—	1.70" (43.2)	.70" (17.8)	1.02" (25.9)	2.46" (62.5)	2.15" (54.6)	—	—	—	—	—	—	—	
1¼-1½	5	2.40" (61.0)	—	1.70" (43.2)	.73" (18.5)	1.27" (32.3)	2.48" (63.0)	2.19" (55.6)	—	—	—	—	—	—	—	
1½-1½	5	2.40" (61.0)	—	1.70" (43.2)	.74" (18.8)	1.39" (35.3)	2.48" (63.0)	2.19" (55.6)	—	—	—	—	—	—	—	
1½-1½	6	3.06" (77.7)	—	2.20" (55.9)	.75" (19.0)	1.52" (38.6)	3.04" (77.2)	2.83" (71.9)	—	—	—	—	—	—	—	
2-1½	6	3.06" (77.7)	—	2.20" (55.9)	.78" (19.8)	1.92" (48.8)	3.32" (84.3)	3.07" (78.0)	—	—	—	—	—	—	—	
2-1½	7	3.95" (100.3)	—	2.70" (68.6)	.78" (19.8)	1.99" (50.5)	4.18" (106.2)	3.89" (98.8)	—	—	—	—	—	—	—	

Note: \*A/C— Across Corners; A/F—Across Flats.

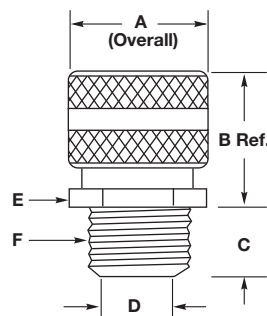

Dimensions shown are approximate and are subject to change without notice.

### 45° Hubbell Connectors

F NPT Inches	Aluminum Inches (mm)								Zinc Plated Steel Inches (mm)							
	Form	A	B	C	D	E		G	A	B	C	D	E		G	
		Dia.	Ref.	Throat Dia.	Across Corners	Across Flats	Dia.	Dia.					Ref.	Throat Dia.	Across Corners	Across Flats
½-14	2	2.00" (50.8)	1.90" (48.3)	.55" (14.0)	.56" (14.2)	1.27" (32.3)	1.10" (27.9)	1.13" (28.6)	1.97" (50.0)	1.90" (48.3)	.55" (14.0)	.57" (14.4)	1.24" (31.5)	1.06" (26.9)	1.27" (32.3)	1.13" (28.6)
¾-14	3	2.30" (58.4)	2.50" (65.3)	.56" (14.2)	.75" (19.0)	1.48" (37.6)	1.28" (32.5)	1.38" (34.9)	—	—	—	—	—	—	—	—
1-11½	4	2.60" (66.0)	2.80" (71.1)	.70" (17.8)	1.00" (25.4)	1.69" (42.9)	1.50" (38.1)	1.75" (44.4)	—	—	—	—	—	—	—	—
1½-11½	5	3.90" (99.1)	3.90" (99.1)	.74" (18.8)	1.25" (31.7)	2.45" (62.2)	2.13" (54.0)	2.31" (58.7)	—	—	—	—	—	—	—	—
1½-11½	5	3.90" (99.1)	3.90" (99.1)	.74" (18.8)	1.50" (38.1)	2.45" (62.2)	2.13" (54.0)	2.31" (58.7)	—	—	—	—	—	—	—	—

### 90° Hubbell Connectors

F NPT Inches	Aluminum Inches (mm)								Zinc Plated Steel Inches (mm)							
	Form	A	B	C	D	E		G	A	B	C	D	E		G	
		Dia.	Ref.	Throat Dia.	Across Corners	Across Flats	Dia.	Dia.					Ref.	Throat Dia.	Across Corners	Across Flats
¾-18	1	1.27" (32.3)	2.00" (50.8)	.46" (11.7)	.44" (11.2)	1.15" (29.2)	1.10" (27.9)	.88" (22.2)	—	—	—	—	—	—	—	—
½-14	2	1.56" (39.6)	2.30" (58.4)	.50" (12.7)	.55" (13.9)	1.30" (33.0)	1.13" (28.7)	1.13" (28.6)	1.65" (41.9)	2.38" (60.5)	.55" (14.0)	.55" (13.8)	1.29" (32.8)	1.13" (28.7)	1.27" (32.3)	1.13" (28.6)
¾-14	3	1.79" (45.5)	2.80" (71.1)	.56" (14.2)	.77" (19.4)	1.49" (37.8)	1.31" (33.3)	1.38" (34.9)	1.88" (47.8)	2.90" (73.7)	.56" (14.2)	.77" (19.4)	1.52" (38.6)	1.33" (33.8)	1.55" (39.2)	1.38" (34.9)
1-11½	4	2.08" (52.8)	3.20" (81.3)	.70" (17.8)	1.00" (25.4)	1.70" (43.2)	1.50" (38.1)	1.75" (44.4)	2.16" (54.9)	3.20" (81.3)	.70" (17.8)	1.00" (25.4)	1.72" (43.7)	1.50" (38.1)	1.92" (48.8)	1.69" (42.8)
1¼-11½	5	3.18" (80.8)	4.30" (109.2)	.73" (18.5)	1.26" (32.0)	2.47" (62.7)	2.15" (54.6)	2.31" (58.7)	—	—	—	—	—	—	—	—
1½-11½	5	3.18" (80.8)	4.30" (109.2)	.75" (19.2)	1.50" (38.1)	2.47" (62.7)	2.15" (54.6)	2.31" (58.7)	—	—	—	—	—	—	—	—
2-11½	6	3.51" (89.2)	5.50" (139.7)	.80" (20.3)	1.92" (48.8)	2.98" (75.7)	2.78" (70.6)	3.00" (76.2)	—	—	—	—	—	—	—	—

### 90° Hubbell Connectors

Nylon Inches (mm)								
F NPT Inches	Form	A	B	C	D	E		G
		Dia.	Ref.	Throat Dia.	Across Corners	Across Flats	Dia.	
¾-18	1	—	—	—	—	—	—	—
½-14	2	1.41" (35.8)	2.50" (63.5)	.55" (14.0)	.58" (14.6)	1.23" (31.2)	1.12" (28.2)	1.32" (33.4)
¾-14	3	1.65" (41.9)	2.81" (71.4)	.56" (14.2)	.77" (19.4)	1.42" (36.1)	1.29" (32.8)	1.56" (39.6)
1-11½	4	1.99" (50.5)	3.30" (83.8)	.70" (17.8)	1.01" (25.7)	1.82" (46.2)	1.60" (40.6)	1.88" (47.6)

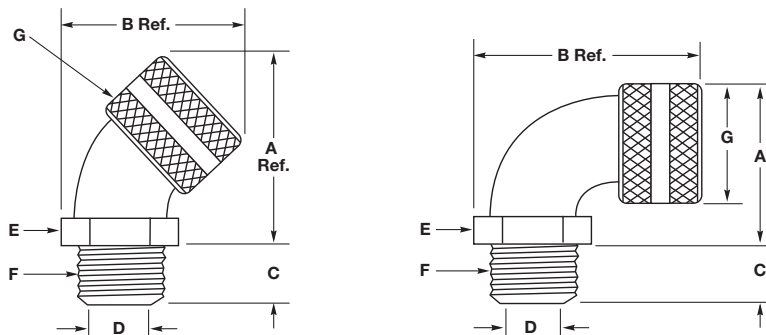

Dimensions shown are approximate and are subject to change without notice.



**Female Hubbell Connectors**

Aluminum Inches (mm)							
F NPT Inches	Form	A		C	D Throat Dia.	E	
		Dia.	Ref.			Across Corners	Across Flats
3/8-18	1	.88" (22.4)	1.40" (35.6)	.56" (14.2)	.44" (11.2)	.94" (23.9)	.81" (20.6)
1/2-14	2	1.13" (28.7)	1.80" (45.7)	.56" (14.2)	.63" (16.0)	1.15" (29.2)	1.00" (25.4)
3/4-14	2	1.13" (28.7)	2.10" (53.3)	.75" (19.0)	.63" (16.0)	1.44" (36.6)	1.25" (31.7)
1-11 1/2	4	1.75" (44.5)	2.30" (58.4)	.88" (22.4)	1.10" (27.9)	1.88" (47.8)	1.63" (41.4)
1 1/4-11 1/2	5	2.31" (58.7)	2.80" (71.1)	.95" (24.1)	1.43" (36.3)	2.64" (67.1)	2.29" (58.2)
1 1/2-11 1/2	5	2.31" (58.7)	2.80" (71.1)	.95" (24.1)	1.43" (36.3)	2.64" (67.1)	2.29" (58.2)

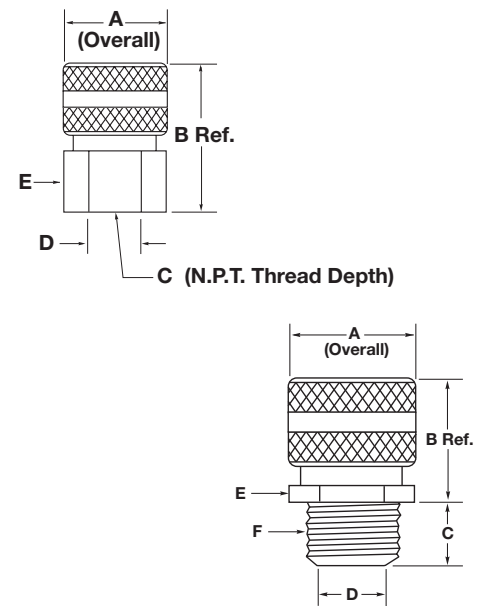

**Underground Feeder Connectors**

F NPT Inches	Form	Aluminum Inches (mm)					Zinc-Plated Steel Inches (mm)					Nylon Inches (mm)								
		A	B	C	D Throat Dia.	E	A	B	C	D Throat Dia.	E	A	B	C	D Throat Dia.	E				
		Dia.	Ref.			A/C* A/F*	A/C* A/F*	Ref.			A/C* A/F*	A/C* A/F*	Dia.	Ref.			A/C* A/F*			
1/2-14	2	1.13" (28.7)	1.10" (27.9)	.55" (14.0)	.64" (16.3)	1.10" (27.9)	1.00" (25.4)	1.27" (32.3)	1.13" (28.7)	1.20" (30.5)	.55" (14.0)	.64" (16.3)	1.11" (28.2)	1.00" (25.4)	1.32" (33.5)	1.50" (38.1)	.55" (14.0)	.58" (14.7)	1.25" (31.7)	1.13" (28.7)
3/4-14	2	1.13" (28.7)	1.10" (27.9)	.55" (14.0)	.64" (16.3)	1.29" (32.8)	1.13" (28.7)	1.27" (32.3)	1.13" (28.7)	1.20" (30.5)	.55" (14.0)	.64" (16.3)	1.29" (32.8)	1.13" (28.7)	—	—	—	—	—	—
3/4-14	3	1.13" (28.7)	1.50" (38.1)	.55" (14.0)	.82" (20.8)	1.40" (35.6)	1.25" (31.7)	1.55" (39.4)	1.38" (35.1)	1.40" (35.6)	.56" (14.2)	.82" (20.8)	1.40" (35.6)	1.25" (31.7)	1.56" (39.6)	1.60" (40.6)	.56" (14.2)	.77" (19.6)	1.44" (36.6)	1.31" (33.3)

Note: \*A/C - Across Corners; A/F - Across Flats.

**Low Profile Non-Metallic NPT, PG and Metric Thread Connectors**

Hub Size	Nylon Inches (mm)					
	A	B	C	D	E	F
3/8 NPT	0.670" (17.0)	1.41" (35.8)	0.48" (12.4)	0.21" (5.3)	0.83" (21.0)	0.55" (14.0)
1/2 NPT	0.875" (22.2)	1.70" (43.2)	0.61" (15.5)	0.21" (5.3)	0.88" (24.8)	0.66" (16.8)
3/4 NPT	1.068" (27.1)	2.00" (50.8)	0.62" (15.7)	0.25" (6.3)	1.30" (33.0)	0.85" (21.6)
1 NPT	1.375" (35.0)	2.41" (61.2)	0.76" (19.3)	0.30" (7.6)	1.73" (43.9)	1.05" (26.7)
PG7	0.492" (12.5)	1.16" (29.5)	0.32" (8.1)	0.21" (5.3)	0.63" (16.0)	0.48" (12.4)
PG9	0.599" (15.2)	1.25" (31.8)	0.32" (8.1)	0.21" (5.3)	0.83" (21.0)	0.55" (14.0)
PG11	0.733" (18.6)	1.48" (37.6)	0.38" (9.7)	0.21" (5.3)	0.94" (23.9)	0.70" (17.8)
PG13.5	0.804" (20.4)	1.53" (38.9)	0.41" (10.4)	0.21" (5.3)	0.98" (24.9)	0.66" (16.8)
PG16	0.888" (22.5)	1.68" (42.7)	0.44" (11.2)	0.25" (6.4)	1.06" (27.0)	0.76" (19.3)
PG21	1.15" (28.3)	1.89" (48.0)	0.52" (13.2)	0.25" (6.4)	1.30" (33.0)	.085" (21.6)
PG29	1.47" (37.30)	2.23" (56.6)	0.58" (14.7)	0.30" (7.6)	1.73" (43.9)	1.05" (26.7)
PG36	1.85" (47.0)	2.39" (60.7)	0.47" (11.9)	0.31" (7.9)	2.05" (52.7)	1.19" (30.2)
M12	0.473" (12.0)	1.16" (29.5)	0.32" (8.1)	0.21" (5.3)	0.63" (16.0)	0.49" (12.4)
M16	0.630" (16.0)	1.25" (31.8)	0.32" (8.1)	0.21" (5.3)	0.83" (21.0)	0.55" (14.0)
M20	0.787" (20.0)	1.53" (38.9)	0.41" (10.4)	0.21" (5.3)	0.98" (24.9)	0.66" (16.8)
M25	0.985" (25.0)	1.89" (48.0)	0.52" (13.2)	0.25" (6.3)	1.30" (33.0)	0.85" (21.6)
M32	1.260" (32.0)	2.23" (56.6)	0.58" (14.7)	0.30" (7.6)	1.73" (43.9)	1.05" (26.7)
M40	1.575" (40.0)	2.39" (60.7)	0.48" (12.2)	0.30" (7.6)	2.05" (52.1)	1.19" (30.2)

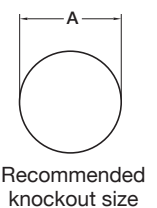
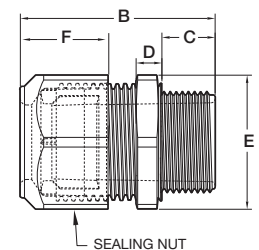

Dimensions shown are approximate and are subject to change without notice.

Kellems® Wire Management Products  
**Technical Information**  
*Cord Connectors*

**2 Conductors**

Cord Type	SVO, SV, SVT				SJ, SJO, SJT, SJTO				S, SO, ST, STO			
Cord Size	#18	#18	#16	#14	#18	#16	#14	#12	#10	#8		
Approx. Dia. Inches (mm)	.25" (6.2)	.31" (7.8)	.33" (8.4)	.37" (9.3)	.38" (9.7)	.40" (10.2)	.54" (13.7)	.62" (15.6)	.68" (17.1)	.81" (20.6)		
Color	Black	Black	White	White	Blue	Blue	Brown	Brown	Yellow	Orchid		
NPT	Form	Catalog Number*										
¼	1	HC1004	HC1004	HC1005	HC1005	HC1006	HC1006	—	—	—	—	
⅜	1	HC1010	HC1010	HC1011	HC1011	HC1012	HC1012	—	—	—	—	
½	1	HC1016	HC1016	HC1017	HC1017	HC1018	HC1018	—	—	—	—	
½	2	HC1022	HC1022	HC1022	HC1022	HC1023	HC1023	HC1024	HC1024	—	—	
½	3	—	—	—	—	HC1025	HC1025	HC1026	HC1026	HC1027	HC1028	
¾	2	HC1032	HC1032	HC1032	HC1032	HC1033	HC1033	HC1034	HC1034	—	—	
¾	3	—	—	—	—	HC1035	HC1035	HC1036	HC1036	HC1037	HC1038	
1	4	—	—	—	—	HC1039	HC1039	HC1040	HC1040	HC1041	HC1042	
1	5	—	—	—	—	—	—	—	—	—	HC1045	
1¼	5	—	—	—	—	—	—	—	—	—	HC1050	
1½	5	—	—	—	—	—	—	—	—	—	HC1055	
1½	6	—	—	—	—	—	—	—	—	—	—	
2	6	—	—	—	—	—	—	—	—	—	—	
2	7	—	—	—	—	—	—	—	—	—	—	
2½	7	—	—	—	—	—	—	—	—	—	—	
3	7	—	—	—	—	—	—	—	—	—	—	

Note: \*Must add prefix, see Note 1; suffix, see Note 2, on page V-95.  
 †F5 and larger will not be color coded.

**3 Conductors**

Cord Type	SVO, SV, SVT				SJ, SJO, SJT, SJTO				S, SO, ST, STO			
Cord Size	#18	#18	#16	#14	#18	#16	#14	#12	#10	#8		
Approx. Dia. Inches (mm)	.26" (6.5)	.33" (8.3)	.35" (8.9)	.39" (9.8)	.39" (9.9)	.42" (10.7)	.57" (14.4)	.65" (16.4)	.71" (18.0)	.85" (21.5)		
Color	Black	White	White	Blue	Blue	Blue	Brown	Yellow	Yellow	Orchid		
NPT	Form	Catalog Number*										
¼	1	HC1004	HC1005	HC1005	HC1006	HC1006	HC1006	—	—	—	—	
⅜	1	HC1010	HC1011	HC1011	HC1012	HC1012	HC1012	—	—	—	—	
½	1	HC1016	HC1017	HC1017	HC1018	HC1018	HC1018	—	—	—	—	
½	2	HC1022	HC1022	HC1022	HC1023	HC1023	HC1023	HC1024	—	—	—	
½	3	—	—	—	HC1025	HC1025	HC1025	HC1026	HC1027	HC1027	HC1028	
¾	2	HC1032	HC1032	HC1032	HC1033	HC1033	HC1033	HC1034	—	—	—	
¾	3	—	—	—	HC1035	HC1035	HC1035	HC1036	HC1037	HC1037	HC1038	
1	4	—	—	—	HC1039	HC1039	HC1039	HC1040	HC1041	HC1041	HC1042	
1	5	—	—	—	—	—	—	—	—	—	HC1045	
1¼	5	—	—	—	—	—	—	—	—	—	HC1050	
1½	5	—	—	—	—	—	—	—	—	—	HC1055	
1½	6	—	—	—	—	—	—	—	—	—	—	
2	6	—	—	—	—	—	—	—	—	—	—	
2	7	—	—	—	—	—	—	—	—	—	—	
2½	7	—	—	—	—	—	—	—	—	—	—	
3	7	—	—	—	—	—	—	—	—	—	—	

Note: \*Must add prefix, see Note 1; suffix, see Note 2, on page V-95.  
 †F5 and larger will not be color coded.

## 2 Conductors

Cord Type	SVO, SV, SVT			SJ, SJO, SJT, SJTO			S, SO, ST, STO				
Cord Size	#6	#4	#3	#2	#1	#1/0	#2/0	#3/0	#4/0	#250	
Approx. Diameter Inches (mm)	.94" (23.8)	1.08" (27.4)	1.17" (29.7)	1.27" (33.3)	1.44" (36.6)	1.52" (38.6)	1.65" (41.9)	1.77" (45.0)	1.92" (48.8)	2.16" (51.9)	
Color	Gray‡	Pink‡	‡	‡	‡	‡	‡	‡	‡	‡	
NPT	Form	Catalog Number*									
¼	1	—	—	—	—	—	—	—	—	—	
⅜	1	—	—	—	—	—	—	—	—	—	
½	1	—	—	—	—	—	—	—	—	—	
½	2	—	—	—	—	—	—	—	—	—	
½	3	—	—	—	—	—	—	—	—	—	
¾	2	—	—	—	—	—	—	—	—	—	
¾	3	—	—	—	—	—	—	—	—	—	
1	4	<b>HC1043</b>	<b>HC1044</b>	—	—	—	—	—	—	—	
1	5	<b>HC1046</b>	<b>HC1047</b>	<b>HC1048</b>	<b>HC1049</b>	—	—	—	—	—	
1¼	5	<b>HC1051</b>	<b>HC1052</b>	<b>HC1053</b>	<b>HC1054</b>	—	—	—	—	—	
1½	5	<b>HC1056</b>	<b>HC1057</b>	<b>HC1058</b>	<b>HC1059</b>	—	—	—	—	—	
1½	6	—	—	—	<b>HC1060</b>	<b>HC1061</b>	<b>HC1062</b>	<b>HC1063</b>	<b>HC1064</b>	—	
2	6	—	—	—	<b>HC1065</b>	<b>HC1066</b>	<b>HC1067</b>	<b>HC1068</b>	<b>HC1069</b>	—	
2	7	—	—	—	—	—	—	—	<b>HC1070</b>	<b>HC1071</b>	
2½	7	—	—	—	—	—	—	—	<b>HC1076</b>	<b>HC1077</b>	
3	7	—	—	—	—	—	—	—	<b>HC1086</b>	<b>HC1087</b>	
									<b>HC1089</b>	<b>HC1073</b>	
									<b>HC1079</b>	<b>HC1075</b>	

Note: \*Must add prefix, see Note 1; suffix, see Note 2, on page V-95.  
‡F5 and larger will not be color coded.

## 3 Conductors

Cord Type	SVO, SV, SVT			SJ, SJO, SJT, SJTO			S, SO, ST, STO				
Cord Size	#6	#4	#3	#2	#1	#1/0	#2/0	#3/0	#4/0	#250	
Approx. Diameter Inches (mm)	1.00" (25.4)	1.17" (29.7)	1.24" (31.5)	1.34" (34.0)	1.51" (38.4)	1.65" (41.9)	1.75" (44.5)	1.80" (48.0)	2.07" (52.6)	2.39" (60.7)	
Color	Gray‡	‡	‡	‡	‡	‡	‡	‡	‡	‡	
NPT	Form	Catalog Number*									
¼	1	—	—	—	—	—	—	—	—	—	
⅜	1	—	—	—	—	—	—	—	—	—	
½	1	—	—	—	—	—	—	—	—	—	
½	2	—	—	—	—	—	—	—	—	—	
½	3	—	—	—	—	—	—	—	—	—	
¾	2	—	—	—	—	—	—	—	—	—	
¾	3	—	—	—	—	—	—	—	—	—	
1	4	<b>HC1044</b>	—	—	—	—	—	—	—	—	
1	5	<b>HC1047</b>	<b>HC1048</b>	<b>HC1048</b>	<b>HC1049</b>	—	—	—	—	—	
1¼	5	<b>HC1052</b>	<b>HC1053</b>	<b>HC1053</b>	<b>HC1054</b>	—	—	—	—	—	
1½	5	<b>HC1057</b>	<b>HC1058</b>	<b>HC1058</b>	<b>HC1059</b>	—	—	—	—	—	
1½	6	—	—	—	<b>HC1060</b>	<b>HC1062</b>	<b>HC1063</b>	<b>HC1064</b>	—	—	
2	6	—	—	—	<b>HC1065</b>	<b>HC1067</b>	<b>HC1068</b>	<b>HC1069</b>	—	—	
2	7	—	—	—	—	—	—	<b>HC1070</b>	<b>HC1071</b>	<b>HC1073</b>	
2½	7	—	—	—	—	—	—	<b>HC1076</b>	<b>HC1077</b>	<b>HC1079</b>	
3	7	—	—	—	—	—	—	<b>HC1086</b>	<b>HC1087</b>	<b>HC1089</b>	
									<b>HC1089</b>	<b>HC1091</b>	

Note: \*Must add prefix, see Note 1; suffix, see Note 2, on page V-95.  
‡F5 and larger will not be color coded.

#### 4 Conductors

Cord Type	SJ, SJO, SJT, SJTO			S, SO, ST, STO						
Cord Size	#18	#16	#14	#18	#16	#14	#12	#10	#8	
Approx. Diameter Inches (mm)	.36" (9.0)	.39" (9.8)	.43" (10.8)	.42" (10.7)	.45" (11.4)	.61" (15.5)	.70" (17.8)	.77" (19.4)	.97" (24.6)	
Color	White	Blue	Blue	Blue	Blue	Brown	Yellow	Orchid	Gray‡	
NPT	Form	Catalog Number*								
¼	1	HC1005	HC1006	HC1006	HC1006	—	—	—	—	—
⅜	1	HC1011	HC1012	HC1012	HC1012	—	—	—	—	—
½	1	HC1017	HC1018	HC1018	HC1018	—	—	—	—	—
½	2	HC1022	HC1023	HC1023	HC1023	HC1023	HC1024	—	—	—
½	3	—	HC1025	HC1025	HC1025	HC1025	HC1026	HC1027	HC1028	—
¾	2	—	HC1033	HC1033	HC1033	HC1033	HC1034	—	—	—
¾	3	—	HC1035	HC1035	HC1035	HC1035	HC1036	HC1037	HC1038	—
1	4	—	HC1039	HC1039	HC1039	HC1039	HC1040	HC1041	HC1042	HC1043
1	5	—	—	—	—	—	—	—	—	HC1046
1¼	5	—	—	—	—	—	—	—	—	HC1051
1½	5	—	—	—	—	—	—	—	—	HC1056
1½	6	—	—	—	—	—	—	—	—	—
2	6	—	—	—	—	—	—	—	—	—
2	7	—	—	—	—	—	—	—	—	—
2½	7	—	—	—	—	—	—	—	—	—
3	7	—	—	—	—	—	—	—	—	—

Note: \*Must add prefix, see Note 1; suffix, see Note 2, on page V-95.  
 ‡F5 and larger will not be color coded.

#### 5 Conductors

Cord Type	S, SO, ST, STO							
Cord Size	#18	#16	#14	#12	#10	#8	#6	
Approx. Dia. Inches (mm)	.50" (12.7)	.54" (13.7)	.70" (17.7)	.76" (19.3)	.83" (21.1)	1.06" (26.9)	1.18" (30.0)	
Color	Blue	Brown	Yellow	Orchid‡	Orchid‡	Pink‡	‡	
NPT	Form	Catalog Number*						
½	2	HC1023	HC1024	—	—	—	—	
½	3	HC1025	HC1026	HC1027	HC1028	HC1028	—	
¾	2	HC1033	HC1034	—	—	—	—	
¾	3	HC1035	HC1036	HC1037	HC1038	HC1038	—	
1	4	HC1039	HC1040	HC1041	HC1042	HC1042	HC1044	
1	5	—	—	—	HC1045	HC1045	HC1047	
1¼	5	—	—	—	HC1050	HC1050	HC1052	
1½	5	—	—	—	HC1055	HC1055	HC1057	

Note: \*Must add prefix, see Note 1; suffix, see Note 2, on page V-95.  
 ‡F5 and larger will not be color coded.

### 4 Conductors

Cord Type	SJ, SJO, SJT, SJTO			S, SO, ST, STO						
Cord Size	#6	#4	#3	#2	#1	#1/0	#2/0	#3/0	#4/0	
Approx. Diameter Inches (mm)	.94" (23.8)	1.08" (27.4)	1.17" (29.7)	1.27" (33.3)	1.44" (36.6)	1.52" (38.6)	1.65" (41.9)	1.77" (45.0)	1.92" (48.8)	
Color	Pink‡	‡	‡	‡	‡	‡	‡	‡	‡	
NPT	Form	Catalog Number*								
¼	1	—	—	—	—	—	—	—	—	—
⅜	1	—	—	—	—	—	—	—	—	—
½	1	—	—	—	—	—	—	—	—	—
½	2	—	—	—	—	—	—	—	—	—
½	3	—	—	—	—	—	—	—	—	—
¾	2	—	—	—	—	—	—	—	—	—
¾	3	—	—	—	—	—	—	—	—	—
1	4	<b>HC1044</b>	—	—	—	—	—	—	—	—
1	5	<b>HC1047</b>	<b>HC1049</b>	<b>HC1049</b>	—	—	—	—	—	—
1¼	5	<b>HC1052</b>	<b>HC1054</b>	<b>HC1054</b>	—	—	—	—	—	—
1½	5	<b>HC1057</b>	<b>HC1059</b>	<b>HC1059</b>	—	—	—	—	—	—
1½	6	—	<b>HC1060</b>	<b>HC1060</b>	<b>HC1061</b>	<b>HC1063</b>	<b>HC1064</b>	—	—	—
2	6	—	<b>HC1064</b>	<b>HC1065</b>	<b>HC1066</b>	<b>HC1068</b>	<b>HC1069</b>	—	—	—
2	7	—	—	—	—	—	<b>HC1070</b>	<b>HC1071</b>	<b>HC1073</b>	<b>HC1074</b>
2½	7	—	—	—	—	—	<b>HC1076</b>	<b>HC1077</b>	<b>HC1079</b>	<b>HC1080</b>
3	7	—	—	—	—	—	<b>HC1086</b>	<b>HC1087</b>	<b>HC1089</b>	<b>HC1090</b>

Note: \*Must add prefix, see Note 1; suffix, see Note 2, below.  
‡F5 and larger will not be color coded.

**Note:**

1. Add the proper prefix to the HC number to identify the type of connector desired:  
SHC = Straight Hubbell Connector  
NHC = 90° Hubbell Connector  
FHC = Female Hubbell Connector  
VHC = 45° Hubbell Connector
2. Add the proper suffix to identify material desired:  
Aluminum = No suffix  
Zinc-Plated Steel = ZP  
Corrosion Resistant Nylon = CR  
Stainless Steel = SS

3. This chart is a general guide to assist in the selection of Hubbell Cord Connectors for various cord sizes. The Hubbell Cord Connector catalog numbers selected, have been inserted into spaces which in our judgment represent the best cord connector which will fit the listed cord size. The diameters of the cords are approximate and may vary depending on the manufacturer. It is suggested that the appropriate cord manufacturer's dimension chart be consulted for exact dimensions.
4. Cable jacket may have to be stripped to allow conductors to pass through connector body.

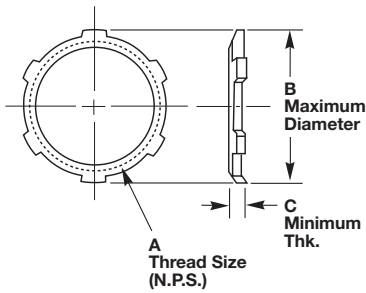

### NPT Thread Locknuts

#### Zinc-Plated Steel

NPT Hub Size	A Inside Diameter Inches	B Outside Dia. Inches (mm)	C Thickness Inches (mm)	Steel Catalog Number
½	½"-14	1.14" (29.0)	.09" (2.3)	00322001LPK50
¾	¾"-14	1.43" (36.3)	.11" (2.8)	00322002LPK50
1	1"-11½	1.77" (45.0)	.13" (3.3)	00322003LPK50
1¼	1¼"-11½	2.28" (57.9)	.13" (3.3)	00322004LPK50
1½	1½"-11½	2.60" (66.0)	.13" (3.3)	00322005LPK50

### Metal Clad Sealing O-Rings – Sizes ½ - 4

#### Zinc-Plated Steel with Neoprene Ring

NPT Hub Size	A Inside Diameter Inches (mm)	B Outside Dia. Inches (mm)	C Thickness Inches (mm)	Catalog Number
½	.80" (20.3)	1.08" (27.4)	.16" (3.2)	20509001
¾	1.00" (25.4)	1.34" (34.0)	.16" (3.2)	20509002
1	1.25" (31.6)	1.63" (41.4)	.16" (3.2)	20509003
1¼	1.61" (40.9)	2.00" (50.8)	.16" (3.2)	20509004
1½	1.84" (46.7)	2.36" (59.9)	.16" (3.2)	20509005
2	2.31" (58.7)	2.83" (71.9)	.16" (3.2)	20509006

#### Chrome Plated Steel with Neoprene Ring

2½	2.91" (73.9)	3.44" (87.4)	.24" (6.1)	20509007
3	3.52" (89.4)	4.08" (103.6)	.24" (6.1)	20509008

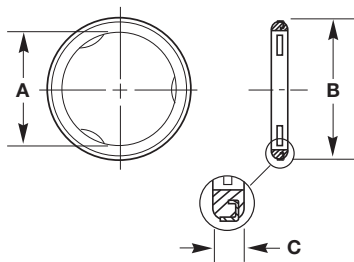

### Nylon PG Thread Locknuts

PG Thread Size	A Inches (mm)	B Inches (mm)	C Inches (mm)	Catalog Number
PG7	.75" (19.1)	.80" (20.3)	.22" (5.6)	LNP7BPK100
PG9	.86" (21.8)	.91" (23.2)	.22" (5.6)	LNP9BPK100
PG11	.94" (23.9)	1.03" (26.2)	.22" (5.6)	LNP11BPK100
PG13.5	1.06" (26.9)	1.14" (29.0)	.24" (6.1)	LNP13BPK100
PG16	1.18" (30.0)	1.30" (33.0)	.25" (6.1)	LNP16BPK100
PG21	1.41" (35.8)	1.54" (39.1)	.25" (6.1)	LNP21BPK100
PG29	1.81" (46.0)	2.00" (50.8)	.25" (6.1)	LNP29BPK25
PG36	2.24" (56.9)	2.50" (63.5)	.25" (6.1)	LNP36BPK25

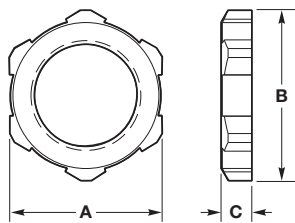

### Nylon Metric Thread Locknuts

PG Thread Size	A Inches (mm)	B Inches (mm)	C Inches (mm)	Catalog Number
M12	.75" (19.1)	.82" (20.8)	.22" (5.6)	LNM12BPK100
M16	.87" (22.09)	.98" (25.0)	.22" (5.6)	LNM16BPK100
M20	1.06" (27.0)	1.18" (30.0)	.25" (6.4)	LNM20BPK100
M25	1.38" (35.1)	1.54" (39.1)	.28" (7.1)	LNM25BPK100
M32	1.61" (40.9)	1.80" (45.7)	.28" (7.1)	LNM32BPK100
M40	1.97" (50.0)	2.18" (55.4)	.28" (7.1)	LNM40BPK100

*Dimensions shown are approximate and are subject to change without notice.*

# Kellems® Wire Management Products

## Technical Information

Hubbell Juniors® Miniature Nylon Cord Connectors

### Hubbell Juniors®

Material	Operating Temperature Range
Nylon (connectors and GOTCHA® rings)	-40°F to +225°F (-40°C to +107°C)
Neoprene (bushings)	-30°F to +240°F (-34°C to +115°C)

Due to the limiting factors of nylon and neoprene, any complete liquidtight Hubbell Junior will continuously perform in the range of -30°F to +225°F (-34°C to +107°C).

Snap-In continuously performs -40°F to +225°F (-40°C to +107°C).

#### Flammability

Hubbell Juniors have a UL 94V-2 rating.

#### Certifications

Product	Agency
Liquidtight and Liquidtight with Spiral	UL Listed. CSA Certified. UL Recognized. CSA Certified.
Snap-In	UL Listed. CSA Certified. UL Recognized. CSA Certified.

### Knockout Holes

NPT Hub Size	Knockout Hole Recommended Min. to Max.	
	inches	(mm)
¼	.54"-.57"	(13.7-14.5)
⅜	.67"-.70"	(17.0-17.8)
½	.86"-.91"	(21.8-23.1)

### Snap-In

Diameter Range Inches (mm)	For Chassis Thickness (Max.) Inches (mm)	Required Hole Size A Inches (mm)	Dimensional Specifications						G Inches (mm)
			B Inches (mm)	C Inches (mm)	D Inches (mm)	E Inches (mm)	F Inches (mm)		
.22"-.27" (5.6-6.9)	.10" (2.5)	.50" (12.7)	.45" (11.4)	.28" (7.1)	.28" (7.1)	.54" (13.7)	.12" (3.0)	1.84" (44.2)	
.28"-.32" (7.1-8.1)	.10" (2.5)	.50" (12.7)	.47" (11.9)	.28" (7.1)	.33" (8.4)	.59" (15.0)	.12" (3.0)	1.84" (44.2)	
.30"-.36" (7.6-9.1)	.13" (3.3)	.63" (16.0)	.55" (14.0)	.36" (9.1)	.37" (9.4)	.65" (16.5)	.14" (3.6)	2.18" (55.4)	
.32"-.43" (8.1-10.9)	.13" (3.3)	.75" (19.0)	.66" (16.8)	.45" (11.4)	.44" (11.2)	.75" (19.1)	.14" (3.6)	2.60" (66.0)	

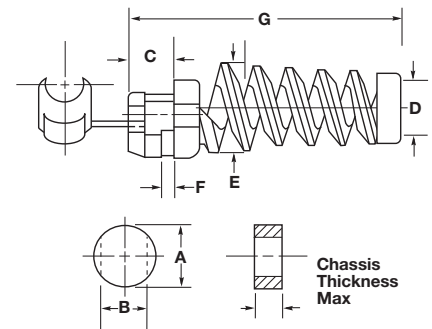

### Liquidtight

F NPT Inches	A Dia. Inches (mm)	B Ref. Inches (mm)	C Inches (mm)	D Throat Dia. Inches (mm)	E	
					Across Corners Inches (mm)	Across Flats Inches (mm)
¼-18	.65" (16.5)	1.30" (33.0)	.40" (10.2)	.29" (7.4)	.65" (16.5)	.60" (15.2)
⅜-18	.81" (20.6)	1.44" (36.6)	.41" (10.4)	.36" (9.1)	.81" (20.6)	.75" (19.1)
½-14	1.00" (25.4)	1.56" (39.6)	.46" (11.7)	.45" (11.4)	.99" (25.1)	.92" (23.4)

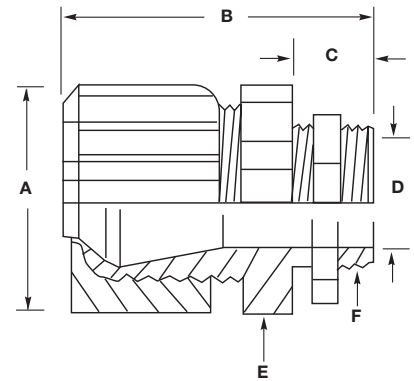

### Liquidtight with Spiral

G NPT Inches	A Dia. Inches (mm)	B Ref. Inches (mm)	C Inches (mm)	D Throat Dia. Inches (mm)	E Inches (mm)	F	
						Across Corners Inches (mm)	Across Flats Inches (mm)
¼-18	.65" (16.5)	2.55" (64.8)	.40" (10.2)	.29" (7.4)	.27" (6.9)	.65" (16.5)	.60" (15.2)
⅜-18	.81" (20.6)	3.10" (78.7)	.41" (10.4)	.36" (9.1)	.35" (8.9)	.81" (20.6)	.75" (19.1)
½-14	1.00" (25.4)	3.72" (94.5)	.46" (11.7)	.45" (11.4)	.45" (11.4)	.99" (25.1)	.92" (23.4)

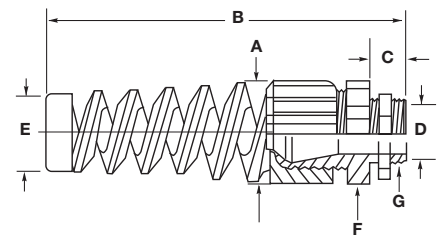

Dimensions shown are approximate and are subject to change without notice.

# Kellems® Wire Management Products

## PolyTuff® I and PolyTuff® II Non-Metallic Liquidtight Conduit

Features and Benefits

### PolyTuff® I Conduit, Gray

Rigid PVC core bonded to flexible PVC jacket

All non-metallic construction ends metal fatigue and separation problems

Cuts cleanly with a knife or PVC cutter so there are no jagged metal edges

UL Listed and CSA Certified

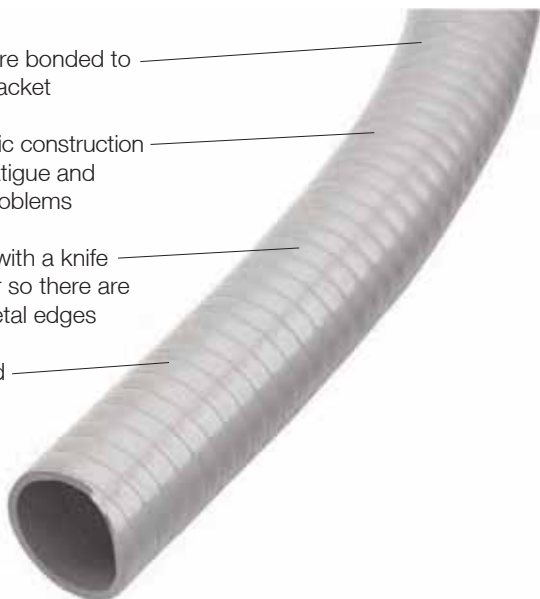

### PolyTuff® II Tubing, Black

PVC core with corrugated walls bonded to PVC jacket

Handles twists, turns, bends, switchbacks and straightaways with ease

All non-metallic construction ends fatigue and separation problems

Can be cut with a knife or PVC cutters

UL Recognized and CSA Certified



### PolyTuff® I Conduit

**IP66**  
SUITABILITY



Trade Size (metric designator)	Feet (m)	Catalog Number
3/8 (12)	100 (30.5)	G1038
1/2 (16)	100 (30.5)	G1050
3/4 (21)	100 (30.5)	G1075
1 (27)	100 (30.5)	G1100
1 1/4 (35)	100 (30.5)	G1125
1 1/2 (41)	50 (15.2)	G1150
2 (53)	50 (15.2)	G1200

Note: See pages V-66 and V-67, V-100 and V-101 for approved fittings.  
See pages V-102 and V-103 for technical information and dimensional drawings.



### PolyTuff® II Tubing

**IP66**  
SUITABILITY



Trade Size (metric designator)	Feet (m)	Catalog Number
1/4 (10)	100 (30.5)	B2025
3/8 (12)	100 (30.5)	B2038
1/2 (16)	100 (30.5)	B2050
3/4 (21)	100 (30.5)	B2075
1 (27)	100 (30.5)	B2100
1 1/4 (35)	100 (30.5)	B2125
1 1/2 (41)	50 (15.2)	B2150
2 (53)	50 (15.2)	B2200

Note: See page V-100 for approved fittings.  
See pages V-102 and V-103 for technical information and dimensional drawings.



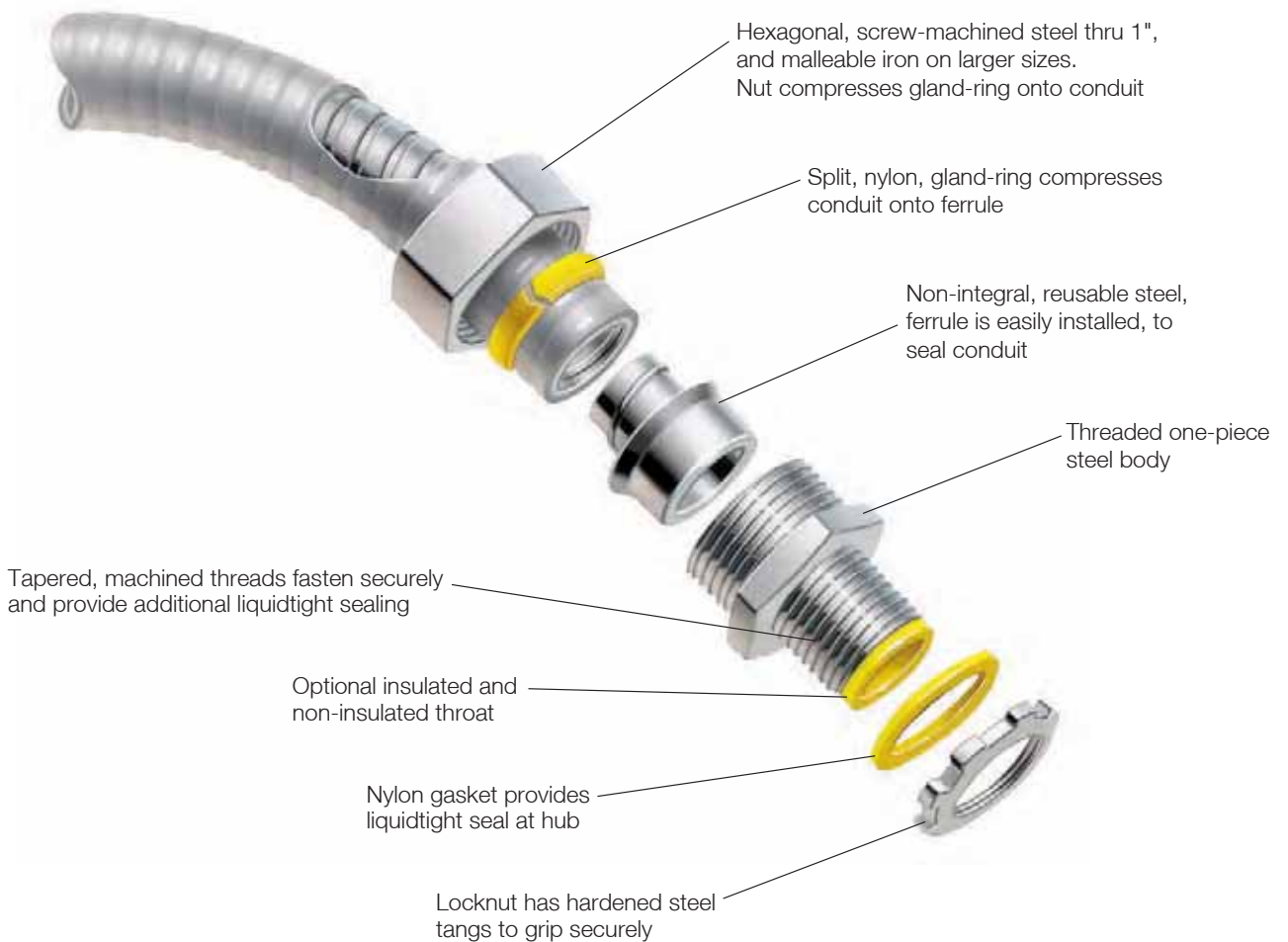
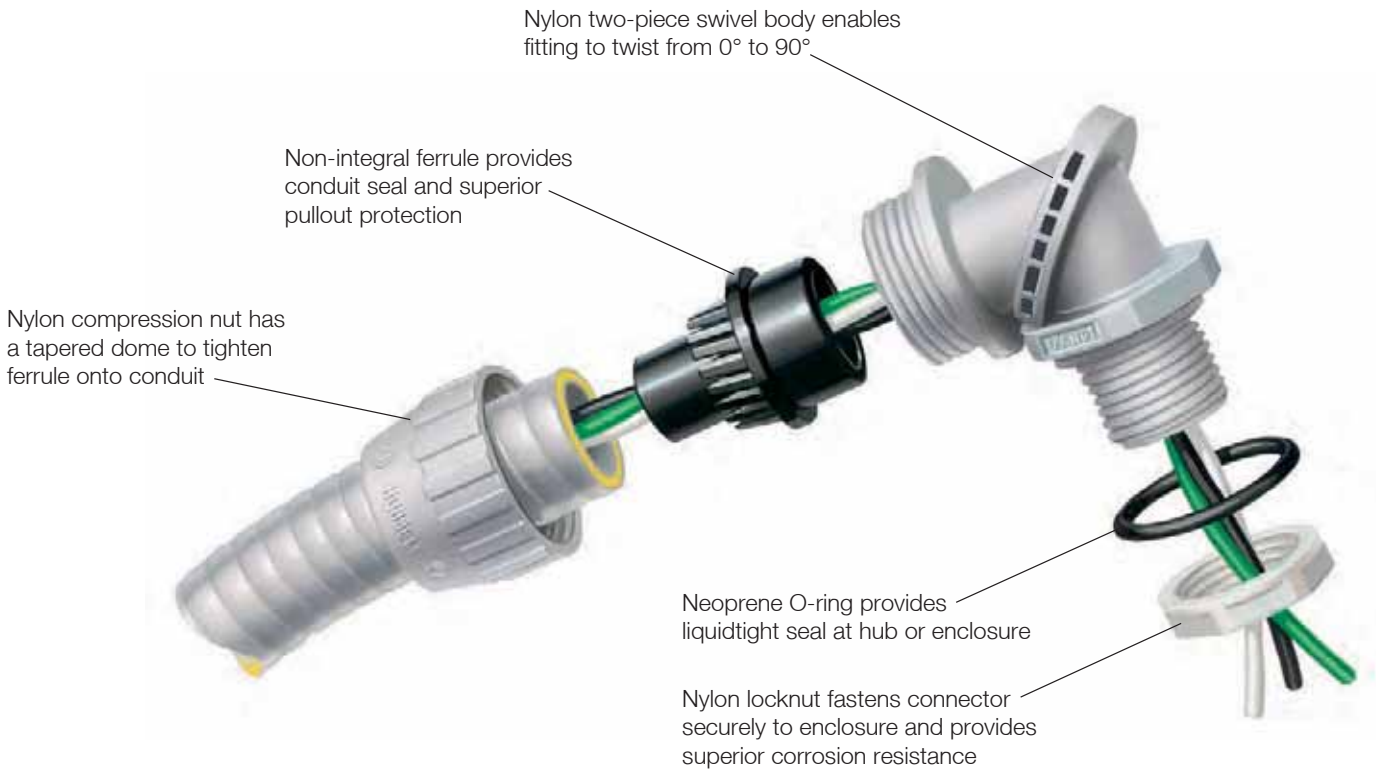



P075NGYA



P125NGY



PS0509NGY  
 SwivelLok® Multi-Position



P1259NGY



PS05GYKIT

### Straight with Male Non-Metallic Liquidtight Fittings

Trade Size (metric designator)	Black Catalog Number	Gray Catalog Number
¼ (10)	F2025	—
⅜ (12)	P038NBKA	P038NGYA
½ (16)	P050NBKA	P050NGYA
¾ (21)	P075NBKA	P075NGYA
1 (27)	P100NBKA	P100NGYA
1¼ (35)	P125NBK	P125NGY
1½ (41)	P150NBK	P150NGY
2 (53)	P200NBK	P200NGY

*Note: Fittings are to be used with PolyTuff I and PolyTuff II.  
 See pages V-104 and V-105 for technical information and dimensional drawings.  
 ¾" Liquidtight conduit fitting have ½ NPT male threads.*

### SwivelLok® Multi-Position with Male Non-Metallic Liquidtight Fittings

Trade Size (metric designator)	Black Catalog Number	Gray Catalog Number
⅜ (12)	PS0389NBK	PS0389NGY
½ (16)	PS0509NBK	PS0509NGY
¾ (21)	PS0759NBK	PS0759NGY
1 (27)	PS1009NBK	PS1009NGY

*Note: Fittings are to be used with PolyTuff I and PolyTuff II.  
 See pages V-104 and V-105 for technical information and dimensional drawings.  
 ¾" Liquidtight conduit fitting have ½ NPT male threads.*

### Fixed 90° Fittings for Non-Metallic Conduit

Trade Size (metric designator)	Black Catalog Number	Gray Catalog Number
⅜ (12)	P0389NBK	P0389NGY
½ (16)	P0509NBK	P0509NGY
¾ (21)	P0759NBK	P0759NGY
1 (27)	P1009NBK	P1009NGY
1¼ (35)	P1259NBK	P1259NGY

*Note: Fittings are to be used with PolyTuff I and PolyTuff II.  
 See pages V-104 and V-105 for technical information and dimensional drawings.  
 ¾" Liquidtight conduit fitting have ½ NPT male threads.*

### SwivelLok® Flexible Conduit Kit

Trade Size (metric designator)	Fitting and Conduit	Catalog Number
½ (16)	2 PS0509NGY, 6' G1050	PS05GYKIT
¾ (21)	2 PS0759NGY, 6' G1075	PS07GYKIT

*Note: See pages V-104 and V-105 for technical information and dimensional drawings.*

### Straight Conduit Fitting

Trade Size (metric designator)	Insulated	Non-Insulated
3/8 (12)	H0381	H038
1/2 (16)	H0501	H050
3/4 (21)	H0751	H075
1 (27)	H1001	H100
1 1/4 (35)	H1251	H125
1 1/2 (41)	H1501	H150
2 (53)	H2001	H200
2 1/2 (63)	H2501	H250
3 (78)	H3001	H300
3 1/2 (91)	H3501	H350
4 (103)	H4001	H400

Note: 3/8" Liquidtight conduit fitting have 1/2 NPT male threads.  
For use with Liquidtight Metal conduit and PolyTuff I Non-Metallic conduit.  
See page V-106 for technical information.



H050  
Straight with Male  
Hubbell Conduit Fitting

### 45° Conduit Fitting

Trade Size (metric designator)	Insulated	Non-Insulated
3/8 (12)	H03841	H0384
1/2 (16)	H05041	H0504
3/4 (21)	H07541	H0754
1 (27)	H10041	H1004
1 1/4 (35)	H12541	H1254
1 1/2 (41)	H15041	H1504
2 (53)	H20041	H2004

Note: 3/8" Liquidtight conduit fitting have 1/2 NPT male threads.  
For use with Liquidtight Metal conduit and PolyTuff I Non-Metallic conduit.  
See page V-106 for technical information.



H0504  
45° Angle with Male  
Hubbell Conduit Fitting

### 90° Conduit Fitting

Trade Size (metric designator)	Insulated	Non-Insulated
3/8 (12)	H03891	H0389
1/2 (16)	H05091	H0509
3/4 (21)	H07591	H0759
1 (27)	H10091	H1009
1 1/4 (35)	H12591	H1259
1 1/2 (41)	H15091	H1509
2 (53)	H20091	H2009
2 1/2 (63)	H25091	H2509
3 (78)	H30091	H3009
4 (103)	H40091	H4009

Note: 3/8" Liquidtight conduit fitting have 1/2 NPT male threads.  
For use with Liquidtight Metal conduit and PolyTuff I Non-Metallic conduit.  
See page V-106 for technical information.



H0509  
90° Angle with Male  
Hubbell Conduit Fitting

# Kellems® Wire Management Products

## Technical Information

Non-Metallic Liquidtight Conduit and Tubing

### PolyTuff® I Conduit

#### Operating Temperature Range

Wet environment	0°F to +140°F (-18°C to +60°C).
Oil environment	0°F to +158°F (-18°C to +70°C).
Dry environment	0°F to +176°F (-18°C to +80°C).

#### Certifications

UL Listed	UL Standard 1660. Sunlight resistant approved for outdoor use, direct burial.
CSA Certified	Meets requirements of NEC.

#### Voltage Rating

Maximum	600V.
---------	-------

#### Material

Conduit	Co-extruded rigid and flexible PVC.
---------	-------------------------------------

### PolyTuff® II Tubing

#### Operating Temperature Range

Operating environment	0°F to +140°F (-18°C to +60°C).
-----------------------	---------------------------------

#### Certifications

UL Recognized	
CSA Certified	

#### Voltage Rating

Maximum	Same as wire insulation rating.
---------	---------------------------------

#### Material

Tubing	Co-extruded rigid and flexible PVC.
--------	-------------------------------------

### PolyTuff® I Conduit

Trade Size (metric designator)	Conduit ID/OD		Bend Radius	
	Inches	(mm)	Inches	(mm)
¾ (12)	.49"/.70"	(12.6/17.8)	2.00"	(50.8)
½ (16)	.63"/.83"	(16.1/21.1)	3.00"	(76.2)
¾ (21)	.83"/1.04"	(21.1/26.4)	4.00"	(101.6)
1 (27)	1.05"/1.30"	(26.0/33.1)	5.00"	(127.0)
1¼ (35)	1.40"/1.65"	(35.4/41.8)	6.30"	(158.8)
1½ (41)	1.59"/1.88"	(40.3/47.8)	7.50"	(190.5)
2 (53)	2.03"/2.36"	(51.6/59.9)	10.00"	(254.0)

### PolyTuff® II Tubing

Trade Size (metric designator)	Conduit ID/OD		Bend Radius	
	Inches	(mm)	Inches	(mm)
¼ (10)	.36"/.57"	(9.3/14.5)	1.50"	(38.1)
¾ (12)	.49"/.70"	(12.6/17.8)	2.00"	(50.8)
½ (16)	.63"/.83"	(16.1/21.1)	2.00"	(50.8)
¾ (21)	.83"/1.04"	(21.1/26.4)	3.00"	(76.2)
1 (27)	1.05"/1.30"	(26.0/33.1)	3.00"	(76.2)
1¼ (35)	1.40"/1.65"	(35.4/41.8)	5.00"	(127.0)
1½ (41)	1.59"/1.88"	(40.3/47.8)	5.00"	(127.0)
2 (53)	2.03"/2.36"	(51.6/59.9)	5.00"	(127.0)

Kellems® Wire Management Products  
**Technical Information**  
 Non-Metallic Liquidtight Conduit and Tubing

**PolyTuff® I and II Conduit/Tubing; PVC Chemical Resistance**

Chemical	Conc.*	Temp.		Chemical	Conc.*	Temp.		Chemical	Conc.*	Temp.	
		70°F 21°C	150°F 66°C			70°F 21°C	150°F 66°C			70°F 21°C	150°F 66°C
Acetate Solvents		D	D	Coconut Oil		C	D	Lubricating Oils		A	A
Acetic Acid		B	C	Corn Oil		A	B	Magnesium Chloride		A	A
Acetic Acid (Glacial)		C	D	Cottonseed Oil		C	D	Magnesium Hydroxide		A	A
Acetone		D	D	Creosote		D	D	Magnesium Sulfate		A	A
Acrylonitrile		A	B	Cresol		C	D	Malathion 50 in Aromatics		D	D
Alcohols (Aliphatic)		C	C	Crylic Acid		D	D	Malic Acid		A	A
Aluminum Chloride		A	A	Cyclohexane		B	C	Methyl Acetate		D	D
Aluminum Sulfate (Alums)		A	A	DDT Weed Killer		A	C	Methyl Alcohol		C	C
Ammonia (Anhydrous Liquids)		D	D	Dibutyl Phthalate		D	D	Methyl Bromide		D	D
Ammonia (Aqueous)		A	A	Diesel Oils		C	D	Methyl Ethyl Ketone		D	D
Ammoniated Latex		A	C	Diethylene Glycol		B	C	Methylene Chloride		D	D
Ammonium Chloride		A	A	Diethyl Ether		A	C	Mineral Oil			
Ammonium Hydroxide		A	A	Di-isodecyl Phthalate		D	D	Monochlorobenzene		A	A
Amyl Acetate		D	D	Dioctyl Phthalate		D	D	Muriatic Acid (see Hydrochloric Acid)			
Aniline Oils		D	D	Dow General Weed Killer (Phenol)		D	D	Naphtha		C	D
Aromatic Hydrocarbons		D	D	Dow General Weed Killer (H2O)		B	C	Naphthalene		D	D
Asphalt		D	D	Ethyl Alcohol		C	C	Nitric Acid	10%	A	B
ASTM Fuel A		C	C	Ethylene Dichloride		D	D	Nitric Acid	35%	A	C
ASTM Fuel B		D	D	Ethylene Glycol		B	C	Nitric Acid	70%	D	D
ASTM #1 Oil		B	C	Ferric Chloride		A	A	Oleic Acid		A	C
ASTM #3 Oil		C	D	Ferric Sulfate		A	A	Oleum		D	D
Barium Chloride		A	A	Ferrous Chloride		A	A	Oxalic Acid		A	A
Barium Sulfide		A	A	Ferrous Sulfate		A	A	Pentachlorophenol in Oil		B	C
Barium Hydroxide		A	A	Formaldehyde		D	D	Pentane		C	D
Benzene (Benzol)		D	D	Fuel Oil		B	C	Perchloroethylene		B	C
Benzine (Petroleum Ether)		C	C	Furfural		C	C	Petroleum Ether		C	C
Black Liquor		A	A	Gallic Acid		A	A	Phenol		A	A
Bordeaux Mixture		A	A	Gasoline (Hi Test)		C	D	Phosphoric Acid	10%	A	A
Boric Acid		A	A	Glycerine		A	A	Pitch	50%	A	B
Butyl Acetate		D	D	Grease		A	C	Potassium Hydroxide		C	D
Butyl Alcohol		B	C	Green Sulfate Liquor		A	A	Sodium Cyanide		A	A
Calcium Hydroxide		A	A	Heptachlor in Petroleum Solvents		A	C	Stoddard Solvent		D	D
Calcium Hypochlorite		A	A	Heptane		C	D	Styrene		D	D
Carbolic Acid (Phenol)		B	C	Hexane		C	D	Sulfur Dioxide (liquid)		D	D
Carbon Dioxide		A	A	Hydrobromic Acid		A	A	Sulfuric Acid	50%	A	B
Carbon Disulfide		D	D	Hydrochloric Acid	10%	A	A	Sulfuric Acid	98%	D	D
Carbon Tetrachloride		D	D	Hydrochloric Acid	40%	C	C	Sulfurous Acid		B	C
Carbonic Acid		A	A	Hydrofluoric Acid	70%	D	D	Tall Oil		D	D
Casein		A	C	Hydrofluorosilicic Acid		A	A	Tannic Acid		A	A
Caustic Soda		A	B	Hydrofluorosilicic Acid	10%	A	A	Toluene		D	D
Chlorine Gas (wet)		D	D	Hydrogen Peroxide		A	B	Trichlorethylene		D	D
Chlorine Gas (dry)		D	D	Iso-Octane		C	C	Triethanol Amine		C	D
Chlorine (water solution)		C	D	Isopropyl Acetate		D	D	Tricresyl Phosphate (Skydrol)		D	D
Chlorobenzene		D	D	Isopropyl Acid		B	C	Turpentine		C	D
Chlorinated Hydrocarbons		D	D	Jet Fuels (JP-3, and 5)		C	D	Vinegar		A	B
Chromic Acid		B	C	Kerosene		C	C	Vinyl Chloride		D	D
Citric Acid		A	A	Ketones		D	D	Water		A	A
Coal Tar		D	D	Linseed Oil		A	A	White Liquor		A	A
								Xylene		D	D
								Zinc Chloride		A	A
								Zinc Sulfate		A	A

Note: \*Conc. = Concentration.  
 (All ratings apply to concentrated or saturated solutions unless otherwise specified.)  
 Chemical resistance ratings are based upon information supplied by the raw material manufacturers.  
 Use as a general guide only – samples should be tested by user under actual conditions.

**Rating Code**

**A-Excellent service**

No harmful effect to reduce service life. Suitable for continuous service.

**B-Good service life.**

Moderate to minor effect. Good for intermittent service. Generally suitable for continuous service.

**C-Fair or limited service.**

Depends on operating conditions. Generally suitable for intermittent service. Not recommended for continuous service.

**D-Unsatisfactory service.**

Not recommended.

# Kellems® Wire Management Products

## Technical Information

Non-Metallic Liquidtight Fittings

### PolyTuff® Fittings

#### Operating Temperature\*

Nylon (Body, Nut, Gripping Ring and Locknut)	-40°F to +225°F (-40°C to +107°C).
Neoprene (Sealing Ring)	-30°F to +240°F (-34°C to +116°C).

#### Flammability

Fire Gas Toxicity Product Testing	Nylon PolyTuff Fittings have a UL 94V-2 rating.
-----------------------------------	---

#### Certifications

UL Listed	UL50 Type 4X, 12 and 13.
CSA Certified	PolyTuff I Fittings, PolyTuff II Fittings.

### Liquidtight Fittings

#### Operating Temperature\*\*

Steel/Malleable Iron (Nut, Body, Ferrule)	-60°F to +1000°F (-51°C to +538°C).
Nylon (Gland Ring)	-40°F to +225°F (-40°C to +107°C).

#### Hazardous Locations - NEC Reference

Class I, Div. 2 - 501-10(A)(3)B  
Class II, Div. 1 - 502-10(A)(2)  
Class II, Div. 2 - 502-10(A)(3)  
Class III, Div. 1 - 503-10(A)(2)  
Class III, Div. 2 - 503-10(B)

#### Certifications

UL Listed to UL 514B  
CSA Certified

*Note: \*Due to the limiting factors of nylon and neoprene, PolyTuff Fittings will continuously perform in the range -30°F to +225°F (-34°C to +107°C).*

*\*\*Due to the limiting factors of nylon, metallic liquidtight flexible conduit fittings will continuously perform in the range of -40°F to +225°F (-40°C to +107°C).*

# Kellems® Wire Management Products

## Technical Information

Non-Metallic Liquidtight Fittings

### Straight with Male Non-Metallic Liquidtight Fittings

Trade Size (md**)	A	B	C	D Throat Dia.	E	
					Across Corners	Across Flats
¼ (10)	.93" (23.6)	1.45" (36.8)	.39" (9.9)	.32" (8.1)	.86" (Dia.) (21.8)	
⅜ (12)	1.14" (29.0)	1.63" (41.4)	.57" (14.5)	.42" (10.7)	1.41" (35.8)	1.30" (33.0)
½ (16)	1.30" (33.0)	2.14" (54.4)	.57" (14.5)	.55" (14.0)	1.41" (35.8)	1.30" (33.0)
¾ (21)	1.53" (38.9)	2.22" (56.4)	.58" (14.7)	.74" (18.8)	1.85" (47.0)	1.53" (38.9)
1 (27)	1.80" (45.7)	2.32" (58.9)	.72" (18.3)	.96" (24.4)	1.94" (49.3)	1.80" (45.7)
1¼ (35)	2.20" (55.9)	2.15" (54.6)	.74" (18.8)	1.30" (33.0)	2.38" (60.5)	2.18" (55.4)
1½ (41)	2.49" (63.2)	2.35" (59.7)	.76" (19.3)	1.46" (37.1)	2.63" (66.8)	2.43" (61.7)
2 (53)	3.05" (77.4)	2.51" (63.6)	.79" (20.1)	1.90" (48.3)	3.13" (79.5)	2.93" (74.4)

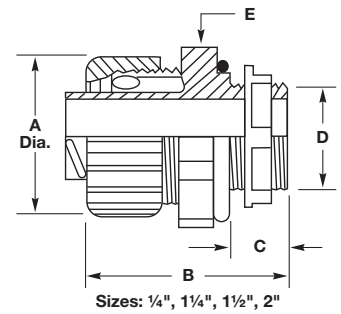

### 90° with Male Non-Metallic Liquidtight Fittings

Trade Size (md**)	A	B	C	D Throat Dia.	E	
					Across Corners	Across Flats
¼ (10)	.93" (23.6)	1.88" (47.8)	.39" (9.9)	.32" (8.1)	.86" (Dia.) (21.8)	
1¼ (35)	2.21" (56.1)	3.57" (90.7)	.74" (18.9)	1.30" (33.0)	2.38" (60.5)	2.18" (55.4)

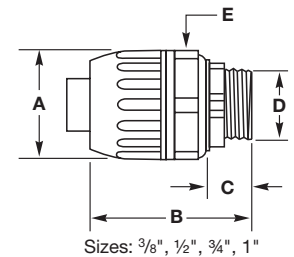

### SwivelLok® Multi-Position Liquidtight Fittings

Trade Size (md**)	A	B	C	D	E	F	G	
							Across Corners	Across Flats
⅜ (12)	1.30" (33.0)	3.27" (83.1)	.57" (14.5)	.55" (14.0)	1.43" (36.3)	2.00" (50.8)	1.41" (35.8)	1.30" (33.0)
½ (16)	1.30" (33.0)	3.27" (83.1)	.57" (14.5)	.55" (14.0)	1.43" (36.3)	2.00" (50.8)	1.41" (35.8)	1.30" (33.0)
¾ (21)	1.53" (38.9)	3.66" (93.0)	.58" (15.7)	.74" (18.8)	1.59" (40.4)	2.23" (56.6)	1.65" (41.9)	1.53" (38.9)
1 (27)	1.80" (45.7)	4.00" (101.6)	.72" (18.3)	.96" (24.4)	1.84" (46.7)	2.30" (58.4)	1.94" (49.3)	1.80" (45.7)

Note: \*A/C = Across Corners, A/F = Across Flats.  
\*\*md = metric designator.

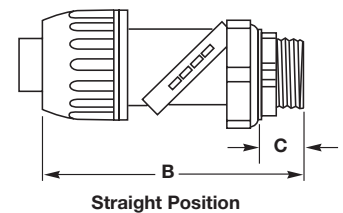
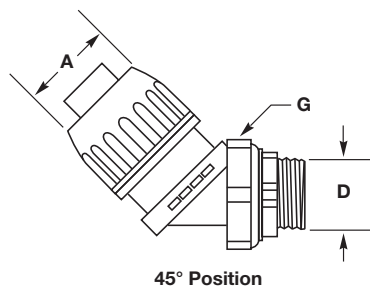
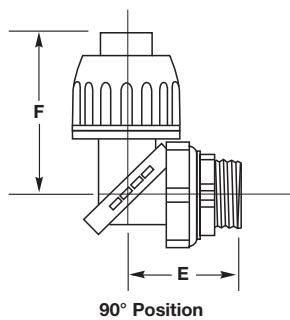
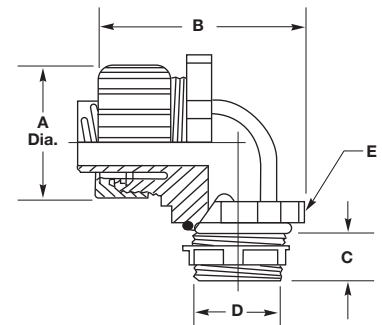

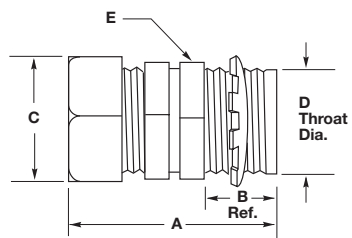

### Straight with Male Metallic Metal Fitting

Trade Size (md**)	A Ref.	B	C		D Throat Dia.	E	
			A/C*	A/F*		A/C*	A/F*
3/8 (12)	1.43" (36.3)	.59" (15.0)	1.20" (30.0)	1.06" (26.9)	.61" (15.5)	1.07" (27.2)	.93" (23.6)
1/2 (16)	1.43" (36.3)	.59" (15.0)	1.34" (34.0)	1.19" (30.2)	.61" (15.5)	1.22" (31.0)	1.06" (26.9)
3/4 (21)	1.56" (39.6)	.59" (15.0)	1.55" (39.0)	1.37" (34.8)	.84" (21.3)	1.43" (36.3)	1.25" (31.8)
1 (27)	1.68" (42.7)	.66" (16.8)	1.95" (50.0)	1.69" (42.9)	1.06" (26.9)	1.73" (43.9)	1.56" (39.6)
1 1/4 (35)	2.03" (51.6)	.63" (16.8)	2.39" (61.0)	2.06" (52.3)	1.37" (34.8)	2.36" (59.9)	2.08" (52.8)
1 1/2 (41)	2.21" (56.1)	.63" (16.8)	2.72" (69.0)	2.38" (60.5)	1.53" (38.9)	2.79" (70.9)	2.48" (63.0)
2 (53)	2.28" (57.9)	.69" (17.5)	3.08" (78.0)	2.87" (72.9)	2.06" (52.3)	3.32" (84.3)	2.90" (73.7)
2 1/2 (63)	3.56" (90.4)	1.06" (26.9)	3.92" (100.0)	3.62" (91.9)	2.42" (61.5)	3.85" (97.8)	3.60" (91.4)
3 (78)	3.81" (96.8)	1.06" (26.9)	4.70" (119.0)	4.31" (109.5)	3.01" (76.5)	4.65" (118.1)	4.33" (110.0)
3 1/2 (91)	3.81" (96.8)	1.06" (26.9)	5.29" (134.0)	4.81" (122.2)	3.49" (88.6)	5.18" (131.6)	4.82" (122.4)
4 (103)	3.81" (96.8)	1.06" (26.9)	5.75" (146.0)	5.31" (134.9)	3.96" (100.6)	5.75" (146.1)	5.39" (136.9)

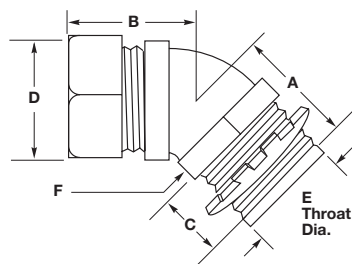

### 45° with Male Metallic Metal Fitting

Trade Size (md**)	A	B	C	D		E Throat Dia.	F	
				A/C*	A/F*		A/C*	A/F*
3/8 (12)	1.19" (30.2)	1.28" (32.5)	.59" (15.0)	1.20" (30.5)	1.06" (26.9)	.60" (15.2)	1.16" (29.5)	1.02" (25.9)
1/2 (16)	1.19" (30.2)	1.28" (32.5)	.59" (15.0)	1.34" (34.0)	1.19" (30.2)	.61" (15.2)	1.21" (30.7)	1.06" (26.9)
3/4 (21)	1.19" (30.2)	1.43" (36.3)	.59" (15.0)	1.55" (39.4)	1.45" (36.8)	.84" (21.3)	1.50" (38.1)	1.32" (33.5)
1 (27)	1.38" (35.1)	1.53" (38.9)	.66" (16.8)	1.95" (49.5)	1.69" (42.9)	1.05" (26.7)	1.82" (46.2)	1.59" (40.4)
1 1/4 (35)	1.42" (36.1)	1.69" (42.9)	.63" (16.0)	2.39" (60.7)	2.06" (52.3)	1.37" (34.8)	2.32" (58.9)	2.03" (51.6)
1 1/2 (41)	1.66" (42.2)	2.00" (50.8)	.66" (16.8)	2.72" (69.1)	2.38" (60.5)	1.60" (40.6)	2.62" (66.5)	2.29" (58.2)
2 (53)	1.69" (42.9)	2.25" (57.2)	.66" (16.8)	3.08" (78.2)	2.88" (73.2)	2.05" (52.1)	3.21" (81.5)	2.80" (71.1)

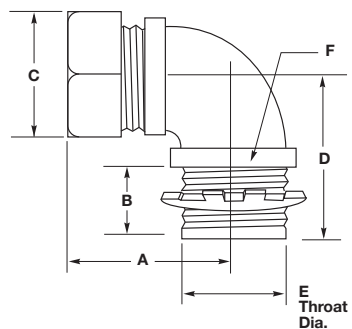

### 90° with Male Metallic Metal Fitting

Trade Size (md**)	A	B	C		D Ref.	E Throat Dia.	F	
			A/C*	A/F*			A/C*	A/F*
3/8 (12)	1.31" (33.3)	.59" (15.0)	1.20" (30.5)	1.06" (26.9)	1.44" (36.6)	.60" (15.2)	1.13" (29.0)	.99" (25.1)
1/2 (16)	1.31" (33.3)	.59" (15.0)	1.34" (34.0)	1.12" (28.4)	1.44" (36.6)	.61" (15.5)	1.12" (28.0)	1.00" (25.4)
3/4 (21)	1.44" (36.6)	.59" (15.0)	1.55" (39.4)	1.45" (36.8)	1.63" (41.4)	.83" (21.1)	1.48" (38.0)	1.29" (32.8)
1 (27)	1.78" (45.2)	.59" (15.0)	1.95" (49.5)	1.60" (40.6)	2.19" (55.6)	1.05" (26.7)	1.80" (46.0)	1.57" (39.9)
1 1/4 (35)	1.97" (50.0)	.63" (16.0)	2.39" (60.7)	2.06" (52.3)	2.50" (63.5)	1.36" (34.5)	2.32" (59.0)	2.02" (51.3)
1 1/2 (41)	2.19" (55.6)	.63" (16.0)	2.72" (69.1)	2.38" (60.5)	2.69" (68.3)	1.61" (40.9)	2.58" (66.0)	2.25" (57.2)
2" (53)	2.53" (64.3)	.66" (16.8)	3.08" (78.2)	2.87" (72.9)	3.25" (82.6)	2.05" (52.1)	3.14" (80.0)	2.75" (69.9)
2 1/2 (63)	3.44" (87.4)	1.00" (25.4)	3.92" (99.6)	3.63" (92.2)	4.25" (108.0)	2.42" (61.5)	3.78" (96.0)	3.50" (88.9)
3 (78)	3.75" (95.3)	1.00" (25.4)	4.70" (119.4)	4.31" (109.5)	4.87" (123.7)	3.01" (76.5)	4.64" (118.0)	4.30" (109.2)
4 (103)	4.25" (108.0)	1.00" (25.4)	5.75" (146.1)	5.31" (134.9)	5.63" (143.0)	3.96" (100.6)	5.76" (146.0)	5.38" (136.7)

Note: \*A/C = Across Corners, A/F = Across Flats.  
 \*\*md = metric designator.



# Section W Network Wiring and netSELECT® Products

## Enterprise Grade Commercial Products

### Index

Network Wiring	Page
<b>Enterprise Grade Commercial Products</b>	
Modular Keystone Jacks . . . . .	W-2
Audio/Video Keystone Connectors . . . . .	W-3
Hubbell iSTATION Face Plates . . . . .	W-5
Hubbell iSTATION Outlet Frames . . . . .	W-6
HDMI Connectors and Audio/Video Modules . . . . .	W-7
Hubbell iSTATION Audio/Video Modules . . . . .	W-8
Hubbell iSTATION Front-Loading Frames and Modules . . . . .	W-9
Hubbell iSTATION Surface Mount Boxes . . . . .	W-10
Universal Patch Panels . . . . .	W-11
Standard UTP Wiring Conventions . . . . .	W-12
<b>netSELECT® Products</b>	<b>W-13</b>
<b>Structured Wiring</b>	
In-Wall AV Delivery . . . . .	W-14
HDMI Products . . . . .	W-15
Advantages and Wiring Layout . . . . .	W-16
Network Enclosures . . . . .	W-17
Network Modules . . . . .	W-18
Audio/Video Modules . . . . .	W-19
Universal Consolidation Blocks, Patch Panels and Patch Cords . . . . .	W-20
Accessories . . . . .	W-21
<b>Data Communications and Audio/Video</b>	
Modular Snap Fit Jacks . . . . .	W-22
Decorator Frames . . . . .	W-23
Molded-In Voice/Data/Video . . . . .	W-24
Molded-In Plates . . . . .	W-25
Telephone Wall Jacks . . . . .	W-26

**Keystone Jacks and Connectors**



**HDMI Connectors**



**Hubbell iSTATION Surface Mount Boxes**



**Modular Snap Fit Jacks**



### Hubbell Xcelerator Jacks, Category 6

The NEXTSPEED® Category 6 system is designed to deliver headroom beyond 500MHz for dependable Multi-gigabit Ethernet applications. NEXTSPEED's extended bandwidth provides reliability with zero bit error rate performance for today's high speed digital communications.

Color	Catalog Number	Bag of 25 Catalog Number
Almond	HXJ6AL	HXJ6AL25
Black	HXJ6BK	HXJ6BK25
Blue	HXJ6B	HXJ6B25
Gray	HXJ6GY	HXJ6GY25
Green	HXJ6GN	HXJ6GN25
Ivory	HXJ6EI	HXJ6EI25
Light Almond	HXJ6LA	HXJ6LA25
Office White	HXJ6OW	HXJ6OW25
Orange	HXJ6OR	HXJ6OR25
Red	HXJ6R	HXJ6R25
White	HXJ6W	HXJ6W25
Yellow	HXJ6Y	HXJ6Y25

### Hubbell Xcelerator Jacks, Category 5e

Supports 10/100/1000BASE-T applications with usable bandwidth of 190 MHz in the channel.

Color	Catalog Number	Bag of 25 Catalog Number
Almond	HXJ5EAL	HXJ5EAL25
Black	HXJ5EBK	HXJ5EBK25
Blue	HXJ5EB	HXJ5EB25
Gray	HXJ5EGY	HXJ5EGY25
Green	HXJ5EGN	HXJ5EGN25
Ivory	HXJ5EEI	HXJ5EEI25
Light Almond	HXJ5ELA	HXJ5ELA25
Office White	HXJ5EOW	HXJ5EOW25
Orange	HXJ5EOR	HXJ5EOR25
Red	HXJ5ER	HXJ5ER25
White	HXJ5EW	HXJ5EW25
Yellow	HXJ5EY	HXJ5EY25

### Hubbell Xcelerator Jacks, 6-Position USOC

Color	Catalog Number	Bag of 25 Catalog Number
Almond	HXJUAL	-
Black	HXJUBK	-
Blue	HXJUB	-
Gray	HXJUGY	-
Green	HXJUGN	-
Ivory	HXJUEI	-
Light Almond	HXJULA	-
Office White	HXJUOW	HXJUOW25
Orange	HXJUOR	-
Red	HXJUR	-
White	HXJUW	-
Yellow	HXJUY	-

### Jack Icons\*

Bag of 100 icons. Snaps to front of enterprise grade Hubbell Xcelerator jacks.

Color	Blank	Computer	Telephone
Black	IBK100	IBK100C	IBK100T
Blue	IB100	IB100C	IB100T
Brown	IBN100	IBN100C	IBN100T
Gray	IGY100	IGY100C	IGY100T
Green	IGN100	IGN100C	IGN100T
Ivory	IEI100	IEI100C	IEI100T
Orange	IOR100	IOR100C	IOR100T
Purple	IP100	IP100C	IP100T
Red	IR100	IR100C	IR100T
White	IW100	IW100C	IW100T
Yellow	IY100	IY100C	IY100T

Note: \*Not UL Listed, CSA Certified.



HXJ6B



HXJ6OR



HXJ5EBK



HXJUEI



IP100C

### F-Type Connectors

Distributes high quality video signal to the workstation. These connectors install with a snap and provide quick, easy "screw-on" termination. Compatible with TV, CATV and CCTV, home theater and entertainment systems, satellite, security and surveillance systems, VCR/DVD applications.

Color	F-Type Coupler Bulkhead F/F	F-Type Coupler Bulkhead F/F Gold	F-Type to RCA Bulkhead F/F Gold	F-Type Recessed
Almond	<b>SFFALX</b>	<b>SFFGAL</b>	–	–
Black	<b>SFFBX</b>	<b>SFFGBK</b>	<b>SFRFGBK</b>	<b>SFGRFBK</b>
Gray	<b>SFFGX</b>	<b>SFFGGY</b>	<b>SFRFGGY</b>	<b>SFGRFGY</b>
Ivory	<b>SFFEX</b>	<b>SFFGEI</b>	<b>SFRFGEI</b>	<b>SFGRFEI</b>
Light Almond	<b>SFFLAX</b>	<b>SFFGLA</b>	–	–
Office White	<b>SFFX</b>	<b>SFFGOW</b>	<b>SFRFGOW</b>	<b>SFGRFOW</b>
White	<b>SFFWX</b>	<b>SFFGW</b>	<b>SFRFGW</b>	<b>SFGRFW</b>



SFFGGY



SFGRFOW



SFRC110R



SFRCR



SFRCROW



SFRCRFF



SFSV110BK

### RCA Connectors

Distributes component and composite audio and video signals from device to device. Typical applications include TV, cable, VCR/DVD, camera, camcorder, projector, home theater, and entertainment centers.

Insulator Color	RCA 110 Punch-Down Black Housing	RCA Solder Coupler Termination		
		Office White Housing	Additional Housing Color*	RCA Recessed*
Black	–	<b>SFRC</b>	<b>SFRCBKxx</b>	<b>SFRCBKRxx</b>
Blue	<b>SFRC110B</b>	<b>SFRCBOW</b>	<b>SFRCBxx</b>	<b>SFRCBRxx</b>
Green	<b>SFRC110GN</b>	<b>SFRCGNOW</b>	<b>SFRCGNxx</b>	<b>SFRCGNRxx</b>
Orange	–	<b>SFRCOROW</b>	<b>SFRCORxx</b>	<b>SFRCORRxx</b>
Red	<b>SFRC110R</b>	<b>SFRCR</b>	<b>SFRCRxx</b>	<b>SFRCRRxx</b>
White	<b>SFRC110W</b>	<b>SFRCW</b>	<b>SFRCWxx</b>	<b>SFRCWRxx</b>
Yellow	<b>SFRC110Y</b>	<b>SFRCY</b>	<b>SFRCYxx</b>	<b>SFRCYRxx</b>

Insulator Color	RCA Gold Pass-through, Office White Housing	F/F Coupler Additional Housing Color*
		Black
Blue	<b>SFRCBFFOW</b>	<b>SFRCBFFxx</b>
Green	<b>SFRCGNFFOW</b>	<b>SFRCGNFFxx</b>
Orange	<b>SFRCORFFOW</b>	<b>SFRCORFFxx</b>
Red	<b>SFRCRFF</b>	<b>SFRCRFFxx</b>
White	<b>SFRCWFF</b>	<b>SFRCWFFxx</b>
Yellow	<b>SFRCYFF</b>	<b>SFRCYFFxx</b>

Note: \*Additional Housing colors: **xx** = **AL** (Almond), **BK** (Black), **EI** (Ivory), **GY** (Gray), **LA** (Light Almond), and **W** (White).

### S-Video Connectors

Transmits video information over a cable by dividing the signal into two separate signals (chrominance) for color and (luminance) for brightness. Applications include cable, satellite, DVD, camera, camcorder, projector, home theater, entertainment systems, security, and surveillance.

Color	S-Video 110 Punch-Down	S-Video F/F Coupler
Black	<b>SFSV110BK</b>	<b>SFSVBK</b>



#### Gender Changers, 9 and 15-Pin Connections

Unit of Measure	15-Pin, 90° F/F Coupler	HD 9-Pin F/F Coupler	HD 15-Pin F/F Coupler
1 per bag	<b>15901</b>	–	–
10 per bag	<b>159010</b>	<b>9GC10</b>	<b>15GC10</b>

#### Screw Terminal, 9 and 15-Pin Connections

Unit of Measure	HD 9-Pin Screw Term	HD 15-Pin Screw Term	HD 15-Pin, Screw Term, Keystone Front Mount
10 per bag	<b>9ST10</b>	<b>15ST10</b>	<b>SF15ST</b>



SFBBOW

SFBGOW



SFSPGR

SPPBK10



SF35FFOW

SF35STOW



SFC5EW

SFC6EBK



SFUSBAA3BK

SFUSBAB3BK



SFUSBABB

SFUSBAAB



SFB10

SFSBE110

### BNC Connectors

Distributes PRO audio video through coaxial 75 ohm signal to the work area. Applications include TV, CCTV, analog and digital CATV, VCR, HDTV satellite, security and surveillance systems.

Color	BNC Connector Nickel Finish	BNC Connector Gold Finish
Black	SFBBK	SFBGBK
Gray	SFBGY	SFBGGY
Ivory	SFBEI	SFBGEI
Light Almond	SFBLA	SFBGLA
Office White	SFBOW	SFBGOW
White	SFBW	SFBGW

### Gold Speaker Post Connectors and Plugs\*

Ring Color	Speaker Post Connector Office White Housing	Speaker Post/ Banana Plugs
Black	SFSPGBK	SPPBK10
Red	SFSPGR	SPPR10

### 3.5mm Stereo Jacks\*

Distributes stereo or mono audio signals to and from devices. Applications include laptop and desktop computer audio I/O output, PRO audio distribution, projectors, and IR (infrared) signal transmission.

Housing Color	3.5mm F/F Coupler	3.5mm Stereo Jack	3.5mm Screw Term.
Black	SF35FFBK	SF35SJBK	SF35STBK
Gray	SF35FFGY	SF35SJGY	SF35STGY
Ivory	SF35FFEI	SF35SJEI	SF35STEI
Light Almond	SF35FFLA	SF35SJLA	SF35STLA
Office White	SF35FFOW	SF35SJ	SF35STOW
White	SF35FFW	SF35SJW	SF35STW

### Inline Couplers\*

Use to deliver a quick and easy interconnect solution at the desktop or in the cross connect.

Color	Wiring: T568A/B	Wiring: T568A/B
Black	SFC5EBK	SFC6EBK
White	SFC5EW	SFC6EW

### USB Connectors

Use to provide a simple and easy way to add a USB connection to a work area.

Housing Color	USB 3.0, A to A, Pass-Thru, F/F, Coupler	USB 3.0, A to B, Pass-Thru, F/F, Coupler	USB 2.0, A to A, Pass-Thru, F/F, Coupler	USB 2.0, A to B, Pass-Thru, F/F, Coupler
Black	SFUSBAA3BK	SFUSBAB3BK	-	-
Blue	-	-	SFUSBAAB	SFUSBABB
Office White	-	-	SFUSBAAOW	SFUSBABOW
White	-	-	SFUSBAAW	SFUSBABW

### Blank Connectors, 10-Pack

Housing Color	Blanks	Smooth Blanks
Almond	SFBAL10	SFSBAL10
Black	SFBB10	SFSBBK10
Gray	SFBG10	SFSBGY10
Ivory	SFBE10	SFSBEI10
Light Almond	SFBLA10	SFSBLA10
Office White	SFB10	SFSBOW10
White	SFBW10	SFSBW10

Note: \*Not UL Listed.

**IFP Face Plates, with Label Fields, 1- and 2-Gang**



Color	1-Gang				2-Gang			
	1-Port	2-Port	3-Port	4-Port	6-Port	6-Port	9-Port	12-Port
Almond	IFP11AL	IFP12AL	IFP13AL	IFP14AL	IFP16AL	IFP26AL	-	-
Black	IFP11BK	IFP12BK	IFP13BK	IFP14BK	IFP16BK	IFP26BK	IFP29BK	IFP212BK
Gray	IFP11GY	IFP12GY	IFP13GY	IFP14GY	IFP16GY	IFP26GY	IFP29GY	IFP212GY
Ivory	IFP11EI	IFP12EI	IFP13EI	IFP14EI	IFP16EI	IFP26EI	IFP29EI	IFP212EI
Light Almond*	IFP11LA	IFP12LA	IFP13LA	IFP14LA	IFP16LA	IFP26LA	IFP29LA	IFP212LA
Office White	IFP11OW	IFP12OW	IFP13OW	IFP14OW	IFP16OW	IFP26OW	IFP29OW	IFP212OW
White	IFP11W	IFP12W	IFP13W	IFP14W	IFP16W	IFP26W	IFP29W	IFP212W

Note: \*Light Almond plates match Office White non-metallic raceway, boxes, jacks and connectors.

**Stainless Steel Face Plates without Label Fields, 1- and 2-Gang**



Catalog No.	1-Gang				2-Gang				
	1-Port	2-Port	3-Port	4-Port	6-Port	4-Port	6-Port	9-Port	12-Port
	SSF11	SSF12	SSF13	SSF14	SSF16	SSF204	SSF206	SSF209	SSF212

**Stainless Steel Face Plates with Label Fields**



1-Gang	Catalog Number
1-Port	SSFL11
2-Port	SSFL12
3-Port	SSFL13
4-Port	SSFL14
6-Port	SSFL16

**Duplex and Decorator Plates with Label Fields**



Color	Duplex Plate	Decorator Plate
Almond	IFP18AL	IFP126AL
Office White	IFP18OW	IFP126OW

**Standard Duplex and Decorator Plates with No Label Fields, 1- and 2-Gang**



Color	1-Gang Duplex Plate	1-Gang Decorator Plate	2-Gang Decorator Plate
Almond	NP8AL	NP26AL	NP262AL
Black	NP8BK	NP26BK	NP262BK
Ivory	NP8I	NP26I	NP262I
Gray	NP8GY	NP26GY	NP262GY
Light Almond*	NP8LA	NP26LA	NP262LA
White	NP8W	NP26W	NP262W

Note: \*Light Almond plates match Office White non-metallic raceway, boxes, jacks and connectors.

**630 Wall Phone Plates, 1-Gang**

Stainless Steel, 1-Gang wall phone plate.



P630S1GJ6 P630SR1GJ6

Jack Format	Includes Gray Jack	Catalog Number
Flush	6-position USOC, RJ25	P630S1GJ6
Flush	8-position Cat. 5e, RJ45	P630S1GJ8
Recessed	6-position USOC, RJ25	P630SR1GJ6
Recessed	8-position Cat. 5e, RJ45	P630SR1GJ8

Keystone Opening  
 Hole size for mounting  
 all Hubbell Jacks.

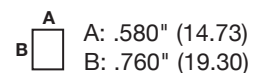

### HDMI\*\* Decorator Frames



Color	1-Port	2-Port
Black	<b>NS801BK</b>	<b>NS802BK</b>
Gray	<b>NS801GY</b>	<b>NS802GY</b>
Ivory	<b>NS801I</b>	<b>NS802I</b>
Light Almond	<b>NS801LA</b>	<b>NS802LA</b>
White	<b>NS801W</b>	<b>NS802W</b>

Note: \*\*HDMI (High Definition Media Interface).

### Blank Duplex Outlet Frames, 1-Gang



Color	Keystone 2-Port	Keystone 4-Port
Almond	<b>BR106AL</b>	<b>Q106AL</b>
Black	<b>BR106B</b>	<b>Q106B</b>
Gray	<b>BR106G</b>	<b>Q106G</b>
Ivory	<b>BR106E</b>	<b>Q106E</b>
Light Almond*	<b>BR106LA</b>	<b>Q106LA</b>
Office White	<b>BR106C</b>	<b>Q106O</b>
White	<b>BR106W</b>	<b>Q106W</b>

Note: \*Light Almond frames match Office White non-metallic raceway, boxes, jacks and connectors.

### Blank Decorator Outlet Frames, 1-Gang

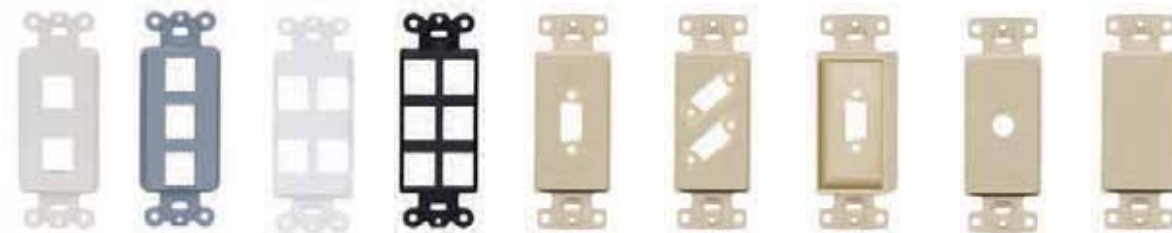

Color	Keystone 2-Port	Keystone 3-Port	Keystone 4-Port	Keystone 6-Port	HD15/9 or HDMI	(2) HD15/9 or HDMI	(1) Recessed HD15/9 or HDMI	.406 in. (10.3) hole	Blank
Almond	<b>ISF2AL</b>	<b>ISF3AL</b>	<b>ISF4AL</b>	<b>ISF6AL</b>	<b>ISFB15AL</b>	—	—	<b>NS621AL</b>	<b>NS620AL</b>
Black	<b>ISF2BK</b>	<b>ISF3BK</b>	<b>ISF4BK</b>	<b>ISF6BK</b>	<b>ISFB15BK</b>	<b>ISFB215BK</b>	<b>ISFBR15BK</b>	—	—
Gray	<b>ISF2GY</b>	<b>ISF3GY</b>	<b>ISF4GY</b>	<b>ISF6GY</b>	<b>ISFB15GY</b>	<b>ISFB215GY</b>	<b>ISFBR15GY</b>	—	—
Ivory	<b>ISF2EI</b>	<b>ISF3EI</b>	<b>ISF4EI</b>	<b>ISF6EI</b>	<b>ISFB15EI</b>	<b>ISFB215EI</b>	<b>ISFBR15EI</b>	<b>NS621I</b>	<b>NS620I</b>
Light Almond*	—	—	—	—	<b>ISFB15LA</b>	—	—	<b>NS621LA</b>	<b>NS620LA</b>
Office White	<b>ISF2OW</b>	<b>ISF3OW</b>	<b>ISF4OW</b>	<b>ISF6OW</b>	<b>ISFB15OW</b>	<b>ISFB215OW</b>	<b>ISFBR15OW</b>	—	—
White	<b>ISF2W</b>	<b>ISF3W</b>	<b>ISF4W</b>	<b>ISF6W</b>	<b>ISFB15W</b>	<b>ISFB215W</b>	<b>ISFBR15W</b>	<b>NS621W</b>	<b>NS620W</b>

Note: \*Light Almond frames match Office White non-metallic raceway, boxes, jacks and connectors.

### Secure-IT Plates



Secure-IT Plates protect mated and unmated connections from physical damage and unauthorized tampering. Available in Tamper-Resistant and Weatherproof versions.



TPF1W

#### Tamper-Resistant Plates

Color	1-Gang/4-Port Catalog Number
Black	<b>TPF1BK</b>
Gray	<b>TPF1GY</b>
Office White	<b>TPF1OW</b>
White	<b>TPF1W</b>



TWPF1GY

#### NEMA 3R Weatherproof Plates

Color	1-Gang/4-Port Catalog Number
Gray	<b>TWPF1GY</b>

**HDMI Connectors**



**HDMI Feed Thru Coupler**

Description	Catalog Number
Single	<b>HDMIC14</b>



**Keystone HDMI Feed Thru**

Description	Color	Catalog Number
Single	Black	<b>SFHC14BK</b>
Single	White	<b>SFHC14W</b>



**HDMI Feed Thru 3-Inch Tail**

Description	Catalog Number
Single	<b>HDMIT14</b>

**DVI Adapters/Couplers**



**DVI-I Coupler**

Description	Catalog Number
Single	<b>DVI1</b>



**DVI to VGA Adapter**

Description	Catalog Number
Single	<b>DVI151</b>



**DVI to HDMI Adapter**

Description	Catalog Number
Single	<b>DVIHDMI1</b>



**DVI to HDMI Adapter**

Description	Catalog Number
Single	<b>HDMIC1</b>

**110 Audio Video Modules\***

Description	Housing Color	Catalog Number
RCA Component, Video to 110 Termination, 1 Unit, 75 ft. max. HD Cat 5, 5e, 6 UTP	Almond	<b>IMCR1101AL</b>
	Black	<b>IMCR1101BK</b>
	Ivory	<b>IMCR1101EI</b>
	Gray	<b>IMCR1101GY</b>
	Office White	<b>IMCR1101OW</b>
S-Video, Stereo RCA Audio to 110 Termination, 1 Unit, 100 ft. max. Cat 5, 5e, 6 UTP	Almond	<b>IMSR1101AL</b>
	Black	<b>IMSR1101BK</b>
	Ivory	<b>IMSR1101EI</b>
	Gray	<b>IMSR1101GY</b>
	Office White	<b>IMSR1101OW</b>
S-Video, 3.5mm Stereo Jack to 110 Termination, 1 Unit, 100 ft. max. Cat 5, 5e, 6	Almond	<b>IMSV351101AL</b>
	Black	<b>IMSV351101BK</b>
	Ivory	<b>IMSV351101EI</b>
	Gray	<b>IMSV351101GY</b>
	Office White	<b>IMSV351101OW</b>
RCA Composite, Video, Stereo Audio to 110 Termination, 1 Unit, 100 ft. max. Cat 5, 5e, 6	Almond	<b>IMR1101AL</b>
	Black	<b>IMR1101BK</b>
	Ivory	<b>IMR1101EI</b>
	Gray	<b>IMR1101GY</b>
	Office White	<b>IMR1101OW</b>
Stereo RCA, Audio 110 Termination, 1 Unit, 100 ft. max. Cat 5, 5e, 6	Almond	<b>IMAR1101AL</b>
	Black	<b>IMAR1101BK</b>
	Ivory	<b>IMAR1101EI</b>
	Gray	<b>IMAR1101GY</b>
	Office White	<b>IMAR1101OW</b>
	White	<b>IMAR1101W</b>



**IMCR1101W**



**IMSR1101W**



**IMSV351101W**



**IMR1101W**



**IMAR1101W**

*Note: \*Not UL Listed.*



IMCRS15OW



IMCRS1OW



IM3RS1OW



IMRSJ1OW



IMCRF1OW



IM3RF1OW



IMSP1OW



SPPBK10

SPPR10

### 110 Audio Video Modules

Description	Housing Color	Catalog Number
RCA Component Video,* Audio 110 Termination, 1.5 Unit	Almond	IMCRS15AL
	Black	IMCRS15BK
	Ivory	IMCRS15EI
	Gray	IMCRS15GY
	Office White	IMCRS15OW
	White	IMCRS15W
RCA Component* Video, Solder, 1 Unit	Almond	IMCRS1AL
	Black	IMCRS1BK
	Ivory	IMCRS1EI
	Gray	IMCRS1GY
	Office White	IMCRS1OW
RCA Composite, Video Audio, Solder, 1 Unit	Almond	IM3RS1AL
	Black	IM3RS1BK
	Ivory	IM3RS1EI
	Gray	IM3RS1GY
	Office White	IM3RS1OW
RCA Composite, Video, 3.5mm Stereo Jack, Solder, 1 Unit	Almond	IMRSJ1AL
	Black	IMRSJ1BK
	Ivory	IMRSJ1EI
	Gray	IMRSJ1GY
	Office White	IMRSJ1OW
	White	IMRSJ1W

### Gold Feed-Through Audio Video RCA Couplers

Description	Housing Color	Catalog Number
RCA Component* Video, Gold, Pass-Through, F/F Coupler, 1 Unit	Almond	IMCRF1AL
	Black	IMCRF1BK
	Ivory	IMCRF1EI
	Gray	IMCRF1GY
	Office White	IMCRF1OW
RCA Composite, Video Audio, Gold, Pass-Through, F/F Coupler, 1 Unit	White	IMCRF1W
	Almond	IM3RF1AL
	Black	IM3RF1BK
	Ivory	IM3RF1EI
	Gray	IM3RF1GY
Office White	IM3RF1OW	
	White	IM3RF1W

### Gold Speaker Posts and Banana Plugs

Description	Housing Color	Catalog Number
Speaker Post, Gold, Black and Red, Screw Termination	Almond	IMSP1AL
	Black	IMSP1BK
	Ivory	IMSP1EI
	Gray	IMSP1GY
	Office White	IMSP1OW
White	IMSP1W	
	Black	SPPBK10
Speaker Banana Plugs*, Gold, Screw Termination, 10-Packs	Red	SPPR10

Note: \*Not UL Listed.





**Modular Face Plate Frames**

Color	1-Gang	2-Gang
Almond	IMF1AL	IMF2AL
Black	IMF1BK	IMF2BK
Gray	IMF1GY	IMF2GY
Ivory	IMF1EI	IMF2EI
Office White	IMF1OW	IMF2OW
White	IMF1W	IMF2W

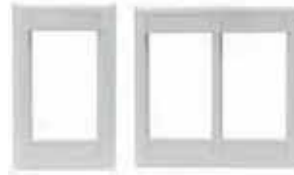

**Raceway Bezel Frames\***

Color	1-Gang
Almond	KPIMBZAL
Gray	KPIMBZGY
Office White	KPIMBZOW



**Unloaded Keystone Modules**

Color	1-Port, Flat 1 Unit	2-Port, Flat 1 Unit	1-Port, Angled 1.5 Unit	2-Port, Angled 1.5 Unit	Recessed Angle 1-Port, 1.5 Unit	Recessed Angle 2-Port, 1.5 Unit
Almond	IM1K1AL	IM2K1AL	IM1KA15AL	IM2KA15AL	-	-
Black	IM1K1BK	IM2K1BK	IM1KA15BK	IM2KA15BK	IM1IA15BK	IM2IA15BK
Ivory	IM1K1EI	IM2K1EI	IM1KA15EI	IM2KA15EI	IM1IA15EI	IM2IA15EI
Gray	IM1K1GY	IM2K1GY	IM1KA15GY	IM2KA15GY	IM1IA15GY	IM2IA15GY
Office White	IM1K1OW	IM2K1OW	IM1KA15OW	IM2KA15OW	IM1IA15OW	IM2IA15OW
White	IM1K1W	IM2K1W	IM1KA15W	IM2KA15W	IM1IA15W	IM2IA15W

Color	Blank 0.5 Unit	Blank 1 Unit	Blank 1.5 Unit	SC Angled 1-Port, 1.5 Unit	SC Angled 2-Port, 1.5 Unit
Almond	IMB05AL	IMB1AL	IMB15AL	-	-
Black	IMB05BK	IMB1BK	IMB15BK	IM1SCA15BK	IM2SCA2BK
Ivory	IMB05EI	IMB1EI	IMB15EI	IM1SCA15EI	IM2SCA2EI
Gray	IMB05GY	IMB1GY	IMB15GY	IM1SCA15GY	IM2SCA2GY
Office White	IMB05OW	IMB1OW	IMB15OW	IM1SCA15OW	IM2SCA2OW
White	IMB05W	IMB1W	IMB15W	IM1SCA15W	IM2SCA2W

**HD (High Definition) 15-Pin/9-Pin Modules**

	Blank HD15/9 or HDMI Module, 1 Unit		Blank HD15/9 or HDMI Module, 1.5 Unit
10-Pack	<b>IMBDS1xx</b>	1-Pack	<b>IMBDSA15xx</b>

**DVI Modules**

	DVI Blank, Unloaded, 1.5 Unit
1-Pack	<b>IMBDV115xx</b>
10-Pack	<b>IMBDVI1015xx</b>

Note: xx = Color: **AL** (Almond), **BK** (Black), **EI** (Ivory), **GY** (Gray), **LA** (Light Almond), **OW** (Office White), and **W** (White).

**Hubbell iSTATION Audio/Video Modules**

XLR, speakON® and ¼ inch modules applications include video distribution, desktop and laptop computers, monitors, cameras, microphones and projectors, home theater and entertainment. Note: Order IMAVB15 series blank modules with AV connectors for Hubbell iSTATION applications.

AV Blank 1.5 Unit	XLR Screw Terminal	XLR Solder-Type	speakON® Conn. Solder-Type	USB Feed-Thru A-to-B	¼" Stereo Jack Solder-Type
10-Pack	<b>IMAVB15xx*</b>	<b>XLRST10</b>	<b>XLR10</b>	<b>SC10</b>	<b>USB10</b>
			<b>SC10</b>	<b>USB10</b>	<b>14S10</b>

Note: xx = Color: **AL** (Almond), **BK** (Black), **EI** (Ivory), **GY** (Gray), **LA** (Light Almond), **OW** (Office White), and **W** (White).

\*Not UL Listed.

speakON® is a registered trademark of Neutrik® AG.



ISB120W

### Specifications

- Low-profile design.
- Accepts XJ jacks, audio video and fiber connectors.
- Provided with double-sided tape and mounting screws for easy installation.
- UL and cUL listed.
- Constructed with a high-impact resistant, flame-retardant polymer.
- ANSI/TIA-606B compliant.



ISB10W



ISB20W



ISB40W



ISB60W



ISB120W

### ISB Surface Mount Boxes, 1- and 2-Port

Ideal for open office, compact surface mount environments, and retrofits to support data, voice, and multimedia applications. Can be mounted with supplied surface mounting screws or double-sided adhesive tape.

Color	1-Port Catalog Number	2-Port Catalog Number
Ivory	<b>ISB1EI</b>	<b>ISB2EI</b>
Office White	<b>ISB1OW</b>	<b>ISB2OW</b>
White	<b>ISB1W</b>	<b>ISB2W</b>

### ISB Surface Mount Boxes, 4- and 6-Port

Ideal for open office MUTOA cabling, compact surface mount environments, and retrofits to support data, voice, and multimedia applications. Features adjustable furniture latches to provide an additional mounting option to common ANSI/TIA/EIA standard furniture openings, and solutions requiring fiber. Box bases feature fiber storage posts that can store one meter fiber cable after termination.

Color	4-Port Catalog Number	6-Port Catalog Number
Ivory	<b>ISB4EI</b>	<b>ISB6EI</b>
Office White	<b>ISB4OW</b>	<b>ISB6OW</b>
White	<b>ISB4W</b>	<b>ISB6W</b>

### ISB Surface Mount Boxes, 12-Port

Ideal for open office MUTOA cabling, large capacity surface mount applications and retrofits to support data, voice, and multimedia installations. Can be mounted with supplied surface mounting screws or double-sided adhesive tape and mounted to NEMA electric boxes or relay racks.

Color	12-Port Catalog Number
Ivory	<b>ISB12EI</b>
Office White	<b>ISB12OW</b>
White	<b>ISB12W</b>

**Consolidation Point Block, Category 6 and Category 5e**

Description	Catalog Number
Category 6, 12-Port, Universal, 89D	<b>P612U</b>
Category 5e, 12-Port, Universal, 89D	<b>P5E12U</b>



P612U

P5E12U

**Universal Patch Panel, Category 5e**

Description	Catalog Number
24-Port, 1.75" H	<b>P5E24UE</b>
48-Port, 3.50" H	<b>P5E48UE</b>
96-Port, 7.0" H	<b>P5E96UE</b>



P5E24UE



P6E48U

**Universal Patch Panel, Category 6**

Description	Catalog Number
24-Port, 1.75" H	<b>P6E24U</b>
48-Port, 3.50" H	<b>P6E48U</b>
96-Port, 7.0" H	<b>P6E96U</b>



UDX24E

**Keystone Jack Panel, Unloaded\***

Description	Catalog Number
Wall Mount, 12-Port, Black	<b>UDX1289</b>
Rack Mount, 24-Port, 1.75" H, Black	<b>UDX24E</b>
Rack Mount, 48-Port, 3.5" H, Black	<b>UDX48E</b>

Note: \*Not UL Listed.

**Rear Cable Management Bar\***

Description	Catalog Number
Screws to the rear flange of a 19-inch rack	<b>CMBR</b>

Note: \*Not UL Listed.



CMBR

# Network Wiring

## Standard UTP Wiring Conventions

Enterprise Grade Commercial Products

### Horizontal UTP Cable and Patch Cords

- Solid copper 4-pair 24 or better AWG UTP is specified for distribution cabling. Stranded UTP is specified for patch cords for flexibility. Shielded cable is not commonly used in the U.S. splices and bridge taps are not permitted.
- Cable, connectors and patch cords shall be marked with the performance category. Always match performance categories of cables and components throughout the infrastructure.
- All cable, cords and connecting hardware shall meet performance requirements of ANSI/TIA/EIA-568-C.1 and 568-C.2. Hubbell assures this compliance with all products and cable partners.

#### COLOR CODING:

	white-blue/blue
	white-orange/orange
	white-green/green
	white-brown/brown

### Recognized Connector and Wiring Configurations

- 8-position modular jack/plug.
- 8-position modular panel/plug.
- T568A wiring or T568B wiring options.
- Cat. 5e or Cat. 6 recommended.

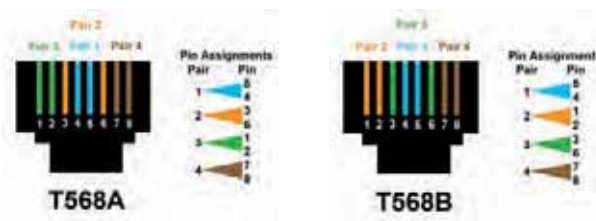

### RJ45 - TIA-568 Conventions

Two wiring standards were adopted. Both configurations provide equivalent transmission performance.



- Preferred method
- Directly compatible with 2-pair voice and Token Ring systems utilizing 6-position connectors



- Optional method
- AT&T's standard
- Directly compatible with AT&T phone systems

### LAN Wiring Conventions

Local Area Network standards designed to operate over UTP specify pin/pair assignments on modular connectors for various signal transmission protocols. While TIA/EIA-568A and 568B conventions support all of these designations, there are some cases where the user chooses to cable only the number of pairs required to support these applications.



- 10 Mbps Ethernet over UTP
- 100 Mbps Ethernet



- 4/16 Mbps Token Ring over copper



- 100 Mbps FDDI over copper (pending)

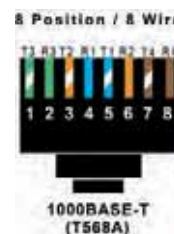

- 1000 Mbps/10Gb Ethernet over UTP
- Uses all four pairs

# Section W netSELECT® Products

## Index

netSELECT® Products	Page
<b>Structured Wiring</b>	
In-Wall AV Delivery . . . . .	W-14
HDMI Products . . . . .	W-15
Advantages and Wiring Layout . . . . .	W-16
Network Enclosures . . . . .	W-17
Network Modules . . . . .	W-18
Audio/Video Modules . . . . .	W-19
Universal Consolidation Blocks, Patch Panels and Patch Cords . . . . .	W-20
Accessories . . . . .	W-21
<b>Data Communications and Audio/Video</b>	
Modular Snap Fit Jacks . . . . .	W-22
Decorator Frames . . . . .	W-23
Molded-In Voice/Data/Video . . . . .	W-24
Molded-In Plates . . . . .	W-25
Telephone Wall Jacks . . . . .	W-26

**In-Wall AV Delivery and HDMI Products**



**Universal Blocks, Patch Panels and Cords**



**Modular Snap Fit Jacks**



**Molded-In Voice/Data/Video**

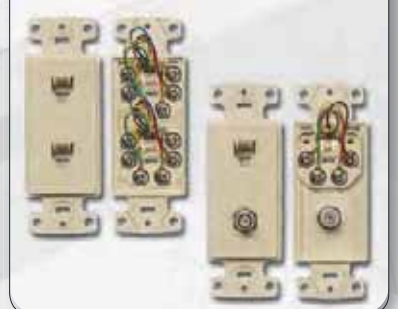

Hubbell's netSELECT® Flat Panel Television (FPTV) connection enclosure delivers high-density connectivity and power in the wall. This allows flat panel displays and interactive "smart" boards to sit flush against walls with no dangling cords. It quickly installs to studs or sheetrock without additional components or hardware.

- 18 Gauge white powder coated rugged steel base
- 2-Gang enclosure with two 1½ and 1¼ inch KOs
- Stud or sheetrock mounting integrated
- Supplied ABS trim ring quickly cleans up sheetrock rough-in
- Optional screw on cover reduces tampering
- cULus 1863 Listed

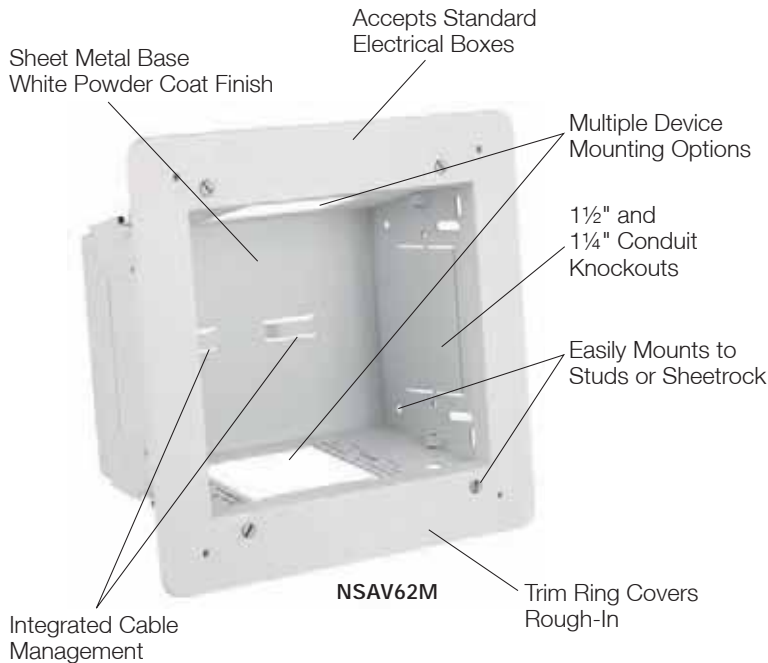

### FPTV Connection Enclosure

Description	Color	Catalog Number
2-Gang In-Wall Enclosure	White	<b>NSAV62M</b>
Steel Cover with Cable Exit	White	<b>NSAV6C</b>
Blank Steel Cover	White	<b>NSAV6CB</b>
Block Wall Adaptor	White	<b>NSAV6BW</b>
New Work Stud Bracket	White	<b>NSAV6NW</b>

### Accessories

#### Power Kits

Description	Color	Catalog Number
Standard Power Kit	White	<b>NSOKPTR</b>
Surge Protected Power Kit	Blue	<b>NSOKPS</b>

#### Unloaded Plates and Frames

1-Gang Blank Plate	White	<b>NP14W</b>
1-Gang Decorator Plate	White	<b>NP26W</b>
1-Gang Hubbell iSTATION Plate	White	<b>IMF1W</b>
1-Gang 4-Port Keystone Plate	White	<b>NSP14W</b>

#### AV Connectors and Plates

1-Port HDMI Frame	White	<b>NS801W</b>
2-Port HDMI Frame	White	<b>NS802W</b>
HDMI Snap Fit	White	<b>SFHC14W</b>
F-Connector Snap Fit	White	<b>NSF70W</b>
USB A-to-B Snap Fit	White	<b>SFUSBABW</b>
Cat 6 Snap Fit Jack	White	<b>NSJ6W</b>

*Note: See page W-22 for snap fit multimedia jacks and AV connectors.*

netSELECT® Products  
**HDMI Products**  
*Structured Wiring*

The AV Ceiling Enclosure is designed to work with active AV devices to integrate AV distribution, data connections and power in one location, providing a direct connection to a projector or a display device. An additional AV/data kit can be added or customized to address all connector, mounting and patching needs, reducing multiple pieces on site.

- Manage multiple applications inside one enclosure
- Flush mounted, white enclosure for consistent look when mounted in the ceiling
- Loaded with two Hubbell 20A duplex receptacles and a 2-gang back box
- All steel rugged construction provides the ultimate strength for installation



AVCE1H

**AV Ceiling Enclosure**

Description	Enclosure Dimensions	Color	Plenum	Non-Plenum
AV Ceiling Enclosure	24" (610) x 12" (305) x 8" (203)	White	<b>AVCE1P</b>	<b>AVCE1H</b>

*Note: Enclosure includes two 20 amp duplex receptacles and 2-gang back box.*

netSELECT® HDMI Decorator Frames deliver uncompromising digital audio and video wherever you need it. Unleash the full potential of your high definition display and audio installations.

- Third party tested for 1080p resolutions
- UL Listed - Communications Circuit Accessory and CSA Certified

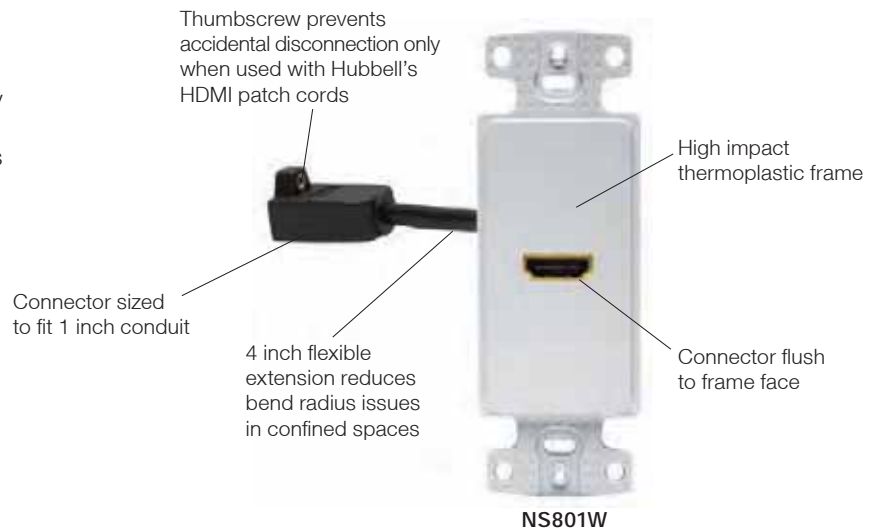

NS801W

**HDMI Products**

Description	Color	1-Gang, 1-Port	1-Gang, 2-Port
HDMI, Decorator Frame, Female to Female	Black	<b>NS801BK</b>	<b>NS802BK</b>
	Gray	<b>NS801GY</b>	<b>NS802GY</b>
	Ivory	<b>NS801I</b>	<b>NS802I</b>
	Light Almond	<b>NS801LA</b>	<b>NS802LA</b>
	Office White	<b>NS801OW</b>	<b>NS802OW</b>
	White	<b>NS801W</b>	<b>NS802W</b>



**HDMI Patch Cords, 24 AWG**

Length	HDMI Device Patch Cords	Length	Horizontal Cords (Connector to Connector)	Length	Link Cords (Connector to Device)	Length	Coupler Cords (Coupler to Device)
3 ft.	<b>HDPC03BK</b>	10 to 30 ft.	<b>HDHyBK</b>	10 to 30 ft.	<b>HDLyBK</b>	10 to 30 ft.	<b>HDCyyBK</b>
6 ft.	<b>HDPC06BK</b>						

*Note: yy = Length in feet. 10 (10'), 15 (15'), 20 (20'), 25 (25'), 30 (30'). Black and non-plenum only. Black and Non-Plenum only.*

netSELECT® Products  
**Advantages and Wiring Layout**  
*Structured Wiring*

**Connect Your Home to Internet, Voice and Video Services**

netSELECT® is an innovative network solution that's perfect for any home or small office. Specifically positioned as the voice/data segment for the Residential brand, the netSELECT® System satisfies the need for a dependable, flexible system that can accommodate all of today's fast-changing voice, data and video requirements.

This cost-effective solution incorporates all the quality you'd expect from Hubbell. Built-in flexibility makes it easy to upgrade and keep pace with evolving technologies.

- Share single analog, cable or DSL internet connection
- Local file access
- Shared peripherals
- Multiple telephone distribution
- Call handling (PBX)
- Video distribution
- Play games that allow multi-users
- Control home automation systems



**Today's Communications Entail A Lot More Than Just Talking.**  
**netSELECT® Keeps You Connected—Internet, Voice, Data and Entertainment**

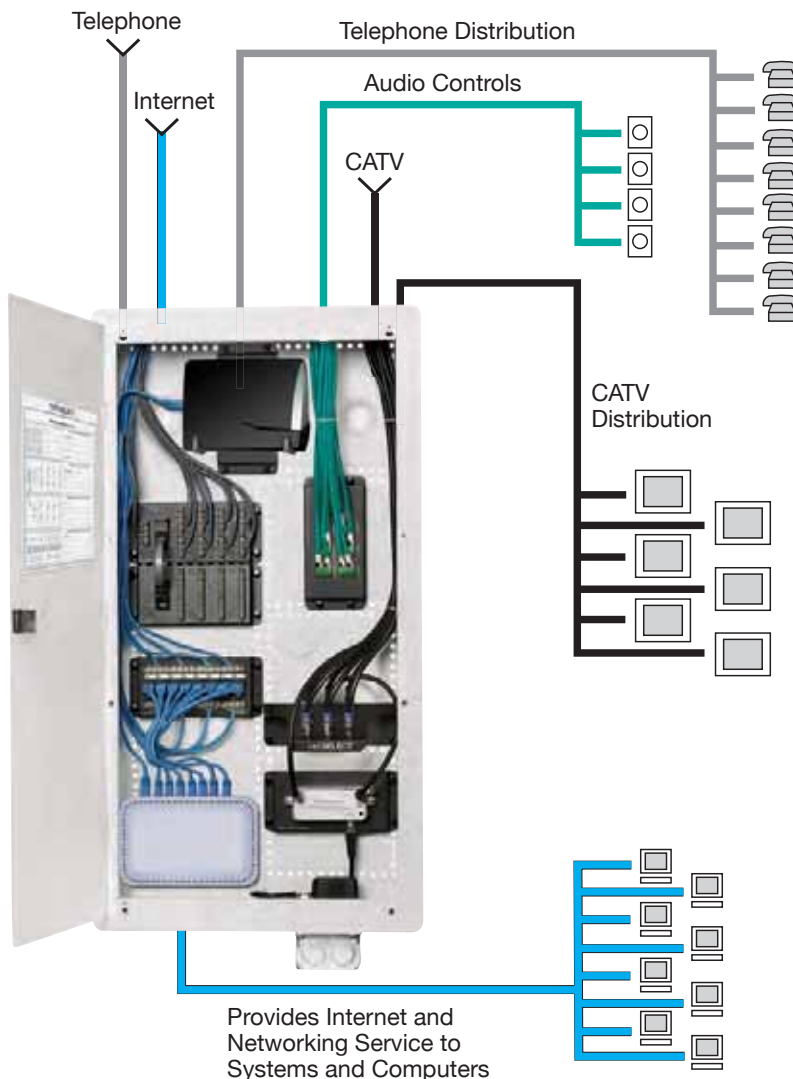



- Flush or surface mount enclosure (hardware provided)
- Hinged cover can be mounted to swing from either side
- Integral trim ring hides rough-in hole in sheet rock providing a finished appearance (except NSOBOX48)
- Horizontal and vertical module mounting holes for maximum flexibility
- Unique 89D bracket mounting holes allow easy mounting of 66 blocks and peripherals

- Provisions to mount optional duplex power and lock kit available
- Integral cable management slots and tie-wraps provided to help dress cable runs
- Additional nylon push pins provided to assist module mounting
- Material: 20-18 gauge steel
- Finish: white, powder coat
- UL and cULus Listed 1863

## Network Enclosures

### Pre-Configured Network System

Description	No. of Module Placement	Catalog Number
Pre-Configured Network System	–	<b>NSOBNK14</b>
Basic home network kit includes:		
One box with hinged cover NSOBOX14,		
One primary 8-port telephone module NSOPTM8,		
One four way coaxial splitter module NSOVM4		

### 10 Inch Network Enclosure for MDU and Modular Applications

Description	Height Inches (mm)	Width Inches (mm)	Depth Inches (mm)	No. of Module Placement	Catalog Number
With Hinged Cover	11.55" (293)	15.65" (398)	4.08" (104)	3	<b>NSOBOX10</b>
With Panel Cover	11.07" (281)	–	4.08" (104)	3	<b>NSOBOX10BC</b>
10"H Box only	10.07" (256)	14.38" (365)	3.96" (101)	3	<b>NSOBOX10B</b>
Hinged Door	11.55" (293)	15.65" (398)	0.58" (15)	–	<b>NSOBOX10D</b>
Panel Cover	11.07" (281)	15.50" (594)	0.20" (5)	–	<b>NSOBOX10C</b>

### 14 Inch Network Enclosure

With Hinged Cover	15.55" (395)	15.65" (398)	4.08" (104)	5	<b>NSOBOX14</b>
With Panel Cover	15.10" (384)	15.54" (395)	4.08" (104)	5	<b>NSOBOX14BC</b>
14"H Box only	14.00" (356)	14.38" (365)	3.96" (101)	5	<b>NSOBOX14B</b>
Hinged Door	15.55" (395)	15.65" (398)	0.33" (8)	–	<b>NSOBOX14D</b>
Vented Door (Louver)	15.55" (395)	15.65" (398)	0.52" (15)	–	<b>NSOBOX14DL</b>
Panel Cover	15.11" (384)	15.54" (395)	0.20" (5)	–	<b>NSOBOX14C</b>
2"D Extension Bracket with ventilation and WiFi KOs	15.30" (389)	15.57" (395)	2.00" (51)	–	<b>NSOBOX14X2</b>

### 28 Inch Network Enclosure

With Hinged Cover	29.55" (751)	–	–	11	<b>NSOBOX28</b>
With Panel Cover	29.13" (740)	15.54" (395)	4.08" (104)	11	<b>NSOBOX28BC</b>
28"H Box only	28.00" (711)	14.38" (365)	3.96" (101)	11	<b>NSOBOX28B</b>
Hinged Door	29.55" (751)	15.65" (398)	0.33" (8)	–	<b>NSOBOX28D</b>
Vented Door* (Louver)	29.55" (751)	15.65" (398)	0.52" (15)	–	<b>NSOBOX28DL</b>
Panel Cover	29.29" (744)	15.54" (395)	0.20" (5)	–	<b>NSOBOX28C</b>
2"D Extension Bracket with ventilation and WiFi KOs	29.3" (744)	15.57" (395)	2.00" (51)	–	<b>NSOBOX28X2</b>

### 48 Inch Network Enclosure

With Hinged Cover	48.94" (1243)	14.94" (379)	4.07" (103)	21	<b>NSOBOX48*</b>
-------------------	---------------	--------------	-------------	----	------------------

Note: \*Door covers rough-in, no trim ring provided.



NSOBOX10



NSOBOX14



NSOBOX28

netSELECT® Modular Components enable the designer to select performance requirements specifically for the application. Modules snap horizontally or vertically into the enclosures for maximum flexibility and optimum space usage.

- Dimensions: 6.47 in. W x 2.95 in. H, except NSOMTM24 6.47 in. W x 6.00 in. H
- Meets FCC Part 68 standard
- Material: High impact plastic
- UL and cULus Listed 1863
- All data and phone modules 568A wired

## Network Modules

Description	Units	Catalog Number
<p>Combo Module</p> <p>Complete Home Network Combo Module 6-Port Telephone Panel and 6-Port Coaxial Splitter with Optional 6-Port Cat. 5e Panel Provides voice, video, and data distribution in a space efficient package. Perfect for use with NSOBOX10 and NS790xx plates to quickly establish a comprehensive home network.</p>		
6-Port Telephone and Video	3	<b>NSOTVM6</b>
6-Port Telephone, Video and Category 5e	3	<b>NSOTVDM6</b>
6-Port Category 5e Data Upgrade Kit	3	<b>NSODK6</b>
<p>Primary Telephone Module, 8-Port</p> <p>Supports 8 phone outlets with up to 4 incoming lines for voice, fax or modem applications in a protected PCB module. Pre-mounted push pins snap the module quickly into place. RJ31X interface jack included for security system connection. RJ45 jack interfaces with optional NSOETM8 Telephone Expansion module for additional extensions.</p>	1	<b>NSOPTM8</b>
<p>Expansion Telephone Module, 8-Port</p> <p>Adds an additional 8 phone outlets with up to 4 incoming lines when used with the primary telephone module. Pre-mounted push pins snap the module quickly into place. Includes RJ45 jumper cord to connect with NSOPTM8 Primary Telephone module.</p>	1	<b>NSOETM8</b>
<p>Category 5e Data Module, 8-Port</p> <p>Supports Gigabit Ethernet for up to 8 Category 5e data lines with front 110 Punch-Down terminations in a protected PCB module. Pre-mounted push pins snap the module quickly into place.</p>	1	<b>NSODM8</b>
<p>Category 6 Data Module, 8-Port</p> <p>Supports enhanced transmission speeds beyond gigabit ethernet. Future proof for tomorrows applications.</p>	1	<b>NSODM8C6</b>
<p>Multiport Patchable Telecom Module</p> <p>Terminates lines via modular plug to accommodate flexibility, by changing plug locations. Reconfigure where phone lines go at the panel level. Allows data lines to be converted to voice, with the move of a patch cord. Includes nine RJ45 jumper cords.</p>	2	<b>NSOMTM24</b>
<p>Combination Module</p> <p>6-Port Telephone and 1-Port Data</p> <p>Provides basic telephone and data delivery in a small package. Allows data lines to be converted to voice, with the move of a patch cord.</p>	1	<b>NSO6P1DM</b>



**NSOTVDM6**



**NSOPTM8**



**NSOETM8**



**NSODM8**



**NSOMTM24**



**NSO6P1DM**

netSELECT® Video Modules support bidirectional signal by splitting to 4, 6, or 8 separate work areas. Pre-mounted push pins snap the module quickly into place.

- Dimensions for VAMP, AM8 and BM: 6.47 in. W x 2.95 in. H
- Dimensions for video splitters: 6.47 in. W x 2.09 in. H x 3.20 in. D
- Material: High impact plastic
- UL and cULus Listed 1863

### Audio/Video Modules

Description	Units	Catalog Number
4-Way Coaxial Splitter Modules, One Incoming Line, Four Outgoing 1 Ghz, Basic Unit 2.3 Ghz, Enhanced Capability	1 1	<b>NSOVM4</b> <b>NSOVM42G</b>
6-Way Coaxial Splitter Modules, One Incoming Line, Six Outgoing 1 Ghz, Basic Unit 2.3 Ghz, Enhanced Capability	1 1	<b>NSOVM6</b> <b>NSOVM62G</b>
8-Way Coaxial Splitter Modules, One Incoming Line, Eight Outgoing 1 Ghz, Basic Unit 2.3 Ghz, Enhanced Capability	1 1	<b>NSOVM8</b> <b>NSOVM82G</b>
Fixed Video Amplifier Module, 10dB 120 volt rated	1	<b>NSOVAMP</b>
Provides video signal amplification for incoming cable feeds recommended for use when more than four outputs are installed or when signal level is low. Provides 10dB forward path gain and supports current digital cable systems and modems with a passive return. Pre-mounted push pins snap the module quickly into place. Includes RG-59 cable jumper to connect amplifier to passive video splitter.		
8 Room Audio Module, Distributes audio from an amplifier to matching volume controllers. Supports up to eight rooms of audio. Power handling - 200W RMS@20° C. Requires impedance matching volume controls, see page W-21.	1	<b>NSOAM8</b>
Blank Module Plate Allows mounting of active components (i.e. switches, routers) or other devices (66 blocks, audio components) onto a modular platform. Can be custom drilled or used with two self-adhesive VELCRO® strips included to mount components onto module. Pre-mounted push pins snap the module quickly into place.	1	<b>NSOBM</b>



NSOVM4



NSOVM6



NSOVM8



NSOVAMP



NSOAM8



NSOBM

VELCRO® is a registered trademark of Velcro Industries B.V.

netSELECT® Patch Panels are excellent for designing rack systems for telephone, data and AV systems. Consolidation Blocks are ideal for small user count configurations that mount in or on the wall.

- Meets ANSI/TIA - Category 6 and Category 5e standards
- cULus Listed

### Universal Consolidation Blocks and Patch Panels

Description	Catalog Number
-------------	----------------



NS5E12U

Category 5e 12-Port Universal Consolidation Block, 89D Bracket Mount	NS5E12U
--	---------



NS612U

Category 6 12-Port Universal Consolidation Block, 89D Bracket Mount	NS612U
---	--------

Category 5e Universal Patch Panel 24-port, 1.75 inch H, 1 Rack Unit 48-port, 3.50 inch H, 2 Rack Units	NS5E24U NS5E48U
--	--------------------



NS5E24U



NS5E48U

Category 6 Universal Patch Panel 24-port, 1.75 inch H, 1 Rack Unit 48-port, 3.50 inch H, 2 Rack Units	NS624U NS648U
---	------------------



NS624U





NS648U

netSELECT® Patch Cords allow for quick change of voice/data lines with insertion of modular plugs.

- Meets and exceeds ANSI/TIA - Category 6 and Category 5e standards
- UL and cUL Listed

### Universal Patch Cords, Category 6 and Category 5e

Description	Color	1-Foot	3-Foot	5-Foot	7-Foot	10-Foot	15-Foot	20-Foot	25-Foot
Cat. 5e Patch Cord 	Blue	HC5EB01	HC5EB03	HC5EB05	HC5EB07	HC5EB10	HC5EB15	HC5EB20	HC5EB25
	Gray	HC5EGY01	HC5EGY03	HC5EGY05	HC5EGY07	HC5EGY10	HC5EGY15	HC5EGY20	HC5EGY25
	Yellow	HC5EY01	HC5EY03	HC5EY05	HC5EY07	HC5EY10	HC5EY15	HC5EY20	HC5EY25
	Red	HC5ER01	HC5ER03	HC5ER05	HC5ER07	HC5ER10	HC5ER15	HC5ER20	HC5ER25
Cat. 6 Patch Cord 	Blue	HC6B01	HC6B03	HC6B05	HC6B07	HC6B10	HC6B15	HC6B20	HC6B25
	Gray	HC6GY01	HC6GY03	HC6GY05	HC6GY07	HC6GY10	HC6GY15	HC6GY20	HC6GY25
	Yellow	HC6Y01	HC6Y03	HC6Y05	HC6Y07	HC6Y10	HC6Y15	HC6Y20	HC6Y25
	Red	HC6R01	HC6R03	HC6R05	HC6R07	HC6R10	HC6R15	HC6R20	HC6R25

netSELECT® Accessories enhance system capabilities. Volume controls expand home audio applications. Cabinet mounted receptacle kits provide convenience power to the enclosure.

- Audio controls available in slide or rotary
- Receptacles available in surge and standard kits

### Accessories

Description	Color	Catalog Number
Slide Audio Volume Controller, Decorator Styling, Power handling - 70W RMS@20° C. Impedance matching for up to 8 pairs of speakers. Includes both ivory and white slides and frames.	Ivory/White	<b>NSOSAVC</b>
Rotary Audio Volume Controller Power handling - 70W RMS@20° C. Impedance matching for up to 8 pairs of speakers. Includes both ivory and white knobs and frames.	Ivory/White	<b>NSORAVC</b>
Standard Power Kit, Includes tamper-resistant duplex receptacle 15A 125V NEMA 5-15R, electrical steel box and wallplate.		<b>NSOKPTR</b>
Surge Suppression Power Kit, Includes surge receptacle 15A 125V NEMA 5-15R, 240 Joules/15,000A protection per mode, electrical steel box and wallplate.		<b>NSOKPS</b>
Chromed Steel Lock Kit, Includes two keys. Eliminates unwanted tampering.		<b>FLOCK1</b>
Panel Bracket Adapter, For use with Adapter Panels shown below, and FSP series modules. Snap mounts into structured cabling enclosures.		<b>NSOFSB</b>
F-Connector Adapter Panel, with Six Populated Coaxial Connectors.		<b>FSPFP6X</b>
Keystone Adapter Panel, with Six Blank Openings for jacks and snap fits.		<b>FSPHD6X</b>
WiFi Antenna Kit, Use with X2 extensions to assure maximum WiFi coverage.		<b>NSOKA</b>



NSOSAVC



NSORAVC



NSOKPS



FLOCK1



NSOFSB



FSPFP6X



FSPHD6X



NSOKA

netSELECT® Products  
**Modular Snap Fit Jacks**  
*Decorator Products*

Customize the jack selections and look

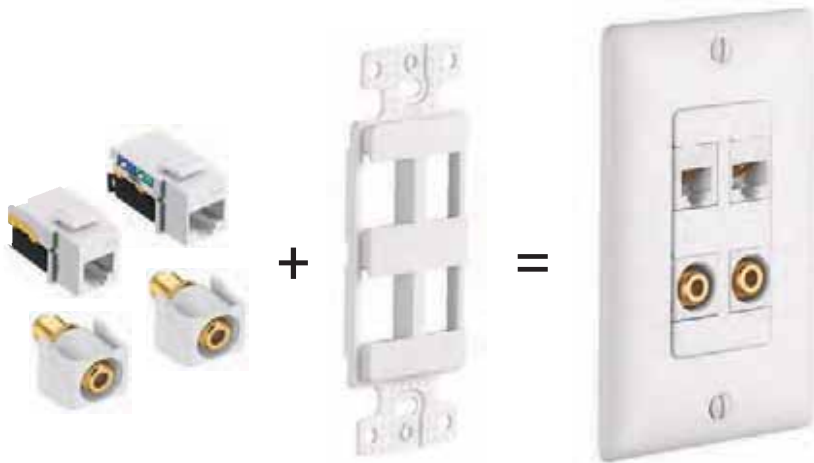

**Molded-In Voice/Low-Speed Data - Modular Snap Fit**

Color	Category 6 Jack		Category 5e Jack		USOC Jack (single)
	(single)	(25 pack)	(single)	(25 pack)	
Black	NSJ6BK	NSJ6BK25	NSJ5EBK	NSJ5EBK25	NSJUBK
Blue	NSJ6B	NSJ6B25	NSJ5EB	NSJ5EB25	NSJUB
Gray	NSJ6GY	NSJ6GY25	NSJ5EGY	NSJ5EGY25	NSJUGY
Green	NSJ6GN	NSJ6GN25	NSJ5EGN	NSJ5EGN25	NSJUGN
Ivory	NSJ6I	NSJ6I25	NSJ5EI	NSJ5EI25	NSJUI
Light Almond	NSJ6LA	NSJ6LA25	NSJ5ELA	NSJ5ELA25	NSJULA
Orange	NSJ6OR	NSJ6OR25	NSJ5EOR	NSJ5EOR25	NSJUOR
Red	NSJ6R	NSJ6R25	NSJ5ER	NSJ5ER25	NSJUR
White	NSJ6W	NSJ6W25	NSJ5EW	NSJ5EW25	NSJUW
Yellow	NSJ6Y	NSJ6Y25	NSJ5EY	NSJ5EY25	NSJUY

**Audio/Video Connectors - Standard Bulkhead**

Color	Nickel F-Type Coupler Bulkhead, Female to Female	Gold F-Type Coupler Bulkhead, Female to Female	RCA Gold Pass Through, Female to Female, Red Interior	RCA Gold Pass Through, Female to Female, White Interior	RCA Gold Pass Through, Female to Female, Yellow Interior	RCA Gold Pass Through, Female to Female, Blue Interior	RCA Gold Pass Through, Female to Female, Green Interior
Black	NSF70BK	SFFGBK	SFRCRFFBK	SFRCWFFBK	SFRCYFFBK	SFRCBFFBK	SFRCGNFFBK
Gray	NSF70GY	SFFGGY	SFRCRFFGY	SFRCWFFGY	SFRCYFFGY	SFRCBFFGY	SFRCGNFFGY
Ivory	NSF70I	SFFGEI	SFRCRFFEI	SFRCWFFEI	SFRCYFFEI	SFRCBFFEI	SFRCGNFFEI
Light Almond	NSF70LA	SFFGLA	SFRCRFFLA	SFRCWFFLA	SFRCYFFLA	SFRCBFFLA	SFRCGNFFLA
White	NSF70W	SFFGW	SFRCRFFW	SFRCWFFW	SFRCYFFW	SFRCBFFW	SFRCGNFFW

**Audio/Video Connectors - Recessed**

Color	Gold F-Type Coupler Bulkhead, Female to Female	RCA Gold Pass Through, Female to Female, Red Interior	RCA Gold Pass Through, Female to Female, White Interior	RCA Gold Pass Through, Female to Female, Yellow Interior	RCA Gold Pass Through, Female to Female, Blue Interior	RCA Gold Pass Through, Female to Female, Green Interior	Blank Insert
Black	SFGRFBK	SFRCRRBK	SFRCWRBK	SFRCYRBK	SFRCBRBK	SFRCGNRBK	SFSBBK10*
Gray	SFGRFGY	SFRCRRGY	SFRCWRGY	SFRCYRGY	SFRCBRGY	SFRCGNRGY	SFSBGY10*
Ivory	SFGRFEI	SFRCRREI	SFRCWREI	SFRCYREI	SFRCBREI	SFRCGNREI	SFSBEI10*
Light Almond	SFGRFLA	SFRCRRLA	SFRCWRLA	SFRCYRLA	SFRCBRLA	SFRCGNRLA	SFSBLA10*
White	SFGRFW	SFRCRRW	SFRCWRW	SFRCYRW	SFRCBRW	SFRCGNRW	SFSBW10*

Note: \*Sold in a package of 10. Order 1 to receive a bag of 10 blanks.

# netSELECT® Products

## Decorator Frames

Decorator Products

### Features

Decorator frames provide a stylized look for that finishing touch. This allows all devices to match. Multimedia jacks insert into frame for custom configuration.

- Elongated strap for better wall box mounting
- High impact-resistant thermoplastic frame
- UL Listed 1863 - Communication Circuit Accessory and CSA Certified

### Decorator Frames



Color	1-Gang, 2-Port	1-Gang, 3-Port	1-Gang, 4-Port	1-Gang, 6-Port	1-Gang, Adapter .406" (10.30) Dia. Hole*	1-Gang, Adapter Blank**
Black	NS612BK	NS613BK	NS614BK	NS616BK	NS621BK	NS620BK
Gray	NS612GY	NS613GY	NS614GY	NS616GY	NS621GY	NS620GY
Ivory	NS612I	NS613I	NS614I	NS616I	NS621I	NS620I
Light Almond	NS612LA	NS613LA	NS614LA	NS616LA	NS621LA	NS620LA
White	NS612W	NS613W	NS614W	NS616W	NS621W	NS620W

Note: \*For use with rotary dimmers or to pull through AV or telephone cable.  
 \*\*To fill an extra decorator opening or to create customized openings.

### Multimedia Face Plates



Description	1-Gang, 1-Port Plate		1-Gang, 2-Port Plate		1-Gang, 3-Port Plate	
	Standard (4.63" x 2.88")	Mid-Size (4.88" x 3.13")	Standard (4.63" x 2.88")	Mid-Size (4.88" x 3.13")	Standard (4.63" x 2.88")	Mid-Size (4.88" x 3.13")
Color						
Black	NSP11BK	NSP101BK	NSP12BK	NSP102BK	NSP13BK	NSP103BK
Gray	NSP11GY	NSP101GY	NSP12GY	NSP102GY	NSP13GY	NSP103GY
Ivory	NSP11I	NSP101I	NSP12I	NSP102I	NSP13I	NSP103I
Light Almond	NSP11LA	NSP101LA	NSP12LA	NSP102LA	NSP13LA	NSP103LA
White	NSP11W	NSP101W	NSP12W	NSP102W	NSP13W	NSP103W



Description	1-Gang, 4-Port Plate		1-Gang, 6-Port Plate		2-Gang, 4-Port Plate	2-Gang, 6-Port Plate
	Standard (4.63" x 2.88")	Mid-Size (4.88" x 3.13")	Standard (4.63" x 2.88")	Mid-Size (4.88" x 3.13")	Standard (4.63" x 4.69")	Standard (4.63" x 4.69")
Color						
Black	NSP14BK	NSP104BK	NSP16BK	NSP106BK	NSP24BK	NSP26BK
Gray	NSP14GY	NSP104GY	NSP16GY	NSP106GY	NSP24GY	NSP26GY
Ivory	NSP14I	NSP104I	NSP16I	NSP106I	NSP24I	NSP26I
Light Almond	NSP14LA	NSP104LA	NSP16LA	NSP106LA	NSP24LA	NSP26LA
White	NSP14W	NSP104W	NSP16W	NSP106W	NSP24W	NSP26W

**Features**

Designed to complement decorator styling, these jacks offer voice and Cat. 5e devices to fit within a decorator wallplate.

- High impact-resistant thermoplastic frame
- Meets FCC part 68
- UL Listed 1863 - Communication Circuit Accessory and CSA Certified

**Molded-In Voice/Low-Speed Data**



Description	Decorative Wallplate, One RJ11 Jack, 6-Position, 4-Conductor	Decorative Wallplate, One RJ11 Jack, 6-Position, 6-Conductor	Decorative Wallplate, Duplex RJ11 Jacks, 6-Position, 6-Conductor	Decorative Wallplate, One Cat. 5e 110 Punch-Down, One RJ11 Jack, 6-Position, 4-Conductor
Color	Screw Terminations	Screw Terminations	Screw Terminations	Screw Terminations
Black	<b>NS770BK</b>	—	—	<b>NS784BK</b>
Brown	<b>NS770</b>	<b>NS771</b>	—	<b>NS784</b>
Gray	<b>NS770GY</b>	—	—	<b>NS784GY</b>
Ivory	<b>NS770I</b>	<b>NS771I</b>	<b>NS772I</b>	<b>NS784I</b>
Light Almond	<b>NS770LA</b>	<b>NS771LA</b>	<b>NS772LA</b>	<b>NS784LA</b>
White	<b>NS770W</b>	<b>NS771W</b>	<b>NS772W</b>	<b>NS784W</b>

**Features**

Coaxial video and combination jacks complement multimedia needs in a 1-gang decorator opening.

- High impact-resistant thermoplastic frame
- Jacks meet FCC part 68
- UL Listed 1863 - Communication Circuit Accessory and CSA Certified

**Molded-In Voice/Low-Speed Data**



Description	Decorative Wallplate, Single F-Type Coupler Bulkhead, Female to Female	Decorative Wallplate, Duplex F-Type Coupler Bulkhead, Female to Female	Decorative Wallplate, One RJ11 Jack, 6-Position, 4-Conductor, One F-Type Coupler Bulkhead, Female to Female	Decorative Wallplate, One Cat. 5e 110 Punch-Down, One F-Type Coupler Bulkhead, Female to Female
Color	Screw Terminations	Screw Terminations	Screw Terminations	Screw Terminations
Black	—	—	—	<b>NS785BK</b>
Brown	—	—	—	<b>NS785</b>
Gray	—	—	—	<b>NS785GY</b>
Ivory	<b>NS780I</b>	<b>NS782I</b>	<b>NS783I</b>	<b>NS785I</b>
Light Almond	<b>NS780LA</b>	<b>NS782LA</b>	<b>NS783LA</b>	<b>NS785LA</b>
White	<b>NS780W</b>	<b>NS782W</b>	<b>NS783W</b>	<b>NS785W</b>



**Features**

Designed for voice, these devices provide an economical alternative to wall phone outlet placement.

- High impact-resistant thermoplastic plate
- Convenient screw down terminals
- Meets FCC part 68
- UL Listed 1863 - Communication Circuit Accessory and CSA Certified

**Molded-In Plates for Voice**



1-Gang Plate,  
 One RJ11 Jack,  
 6-Position, 4-Conductor,  
 Screw Terminations



1-Gang Plate,  
 One RJ11 Jack,  
 6-Position, 6-Conductor,  
 Screw Terminations



1-Gang Plate,  
 Duplex RJ11 Jacks,  
 6-Position, 4-Conductor,  
 Screw Terminations



1-Gang Plate,  
 Duplex RJ11 Jacks,  
 6-Position, 6-Conductor,  
 Screw Terminations

Description	1-Gang Plate, One RJ11 Jack, 6-Position, 4-Conductor, Screw Terminations		1-Gang Plate, One RJ11 Jack, 6-Position, 6-Conductor, Screw Terminations		1-Gang Plate, Duplex RJ11 Jacks, 6-Position, 4-Conductor, Screw Terminations		1-Gang Plate, Duplex RJ11 Jacks, 6-Position, 6-Conductor, Screw Terminations	
	Standard	Mid-Size	Standard	Standard	Mid-Size	Standard	Standard	
Brown	NS730	NS735	NS732	—	—	—	—	
Ivory	NS730I	NS735I	NS732I	NS742I	NS745I	NS744I	—	
Light Almond	NS730LA	NS735LA	NS732LA	NS742LA	—	—	—	
White	NS730W	NS735W	NS732W	NS742W	NS745W	NS744W	—	

**Molded-In Plates for Voice and CATV/Satellite**



1-Gang Plate,  
 One F-Type Coupler Bulkhead,  
 Female to Female,  
 One RJ11 Jack,  
 6-Position, 6-Conductor



1-Gang Plate,  
 One F-Type Coupler Bulkhead,  
 Female to Female,  
 One RJ11 Jack,  
 6-Position, 4-Conductor



1-Gang Plate,  
 One F-Type Coupler Bulkhead,  
 Female to Female



1-Gang Plate,  
 Duplex F-Type Coupler Bulkhead,  
 Female to Female

Description	1-Gang Plate, One F-Type Coupler Bulkhead, Female to Female, One RJ11 Jack, 6-Position, 6-Conductor		1-Gang Plate, One F-Type Coupler Bulkhead, Female to Female, One RJ11 Jack, 6-Position, 4-Conductor		1-Gang Plate, One F-Type Coupler Bulkhead, Female to Female		1-Gang Plate, Duplex F-Type Coupler Bulkhead, Female to Female	
	Standard	Mid-Size	Standard	Standard	Mid-Size	Standard	Standard	
Ivory	NS748I	NS755I	NS747I	NS750I	NS751I	NS752I	—	
Light Almond	NS748LA	NS755LA	NS747LA	NS750LA	NS751LA	NS752LA	—	
White	NS748W	NS755W	NS747W	NS750W	NS751W	NS752W	—	



1-Gang Plate,  
 One Cat. 5e 110 Punch-Down  
 One RJ11 Jack,  
 6-Position, 4-Conductor  
 One F-Type Coupler Bulkhead,  
 Female to Female

Description	Standard
Color	Standard
Black	NS790BK
Brown	NS790
Gray	NS790GY
Ivory	NS790I
Light Almond	NS790LA
White	NS790W

**Features**

Designed for voice applications, these jacks provide an economical alternative to basic wall mount and performance needs.

- Available in high impact-resistant thermoplastic or stainless steel
- Meets FCC part 68
- UL Listed 1863 - Communication Circuit Accessory and CSA Certified

**Telephone Wall Jacks**

			
Description	Wall Phone Jack Quick Connect, 6-Position, 4-Conductor, Punch-Down Termination Tool Included	Wall Phone Jack, 6-Position, 4-Conductor, Screw Terminations	Wall Phone Jack, 6-Position, 6-Conductor, Screw Terminations
Ivory	<b>NS721I</b>	<b>NS722I</b>	<b>NS725I</b>
Light Almond	—	—	<b>NS725LA</b>
White	<b>NS721W</b>	<b>NS722W</b>	<b>NS725W</b>
			
Description	Wall Phone Jack Quick Connect, 6-Position, 4-Conductor, Punch-Down Termination Tool Included	Wall Phone Jack, 6-Position, 4-Conductor, Screw Terminations	
Stainless Steel	<b>NS723SS</b>	<b>NS726SS</b>	

**Features**

Telephone surface mount jacks are available in 4- or 6-conductor configurations for voice. Alternatively, multimedia surface mount boxes can be custom loaded for computer and media use.

- High impact-resistant thermoplastic
- Mounts using screws or double sided tape (both included)
- Meets FCC part 68
- UL Listed 1863 - Communication Circuit Accessory and CSA Certified

**Telephone Wall Jacks**

				
Description	Telephone Surface Mount Jack, 6-Position, 4-Conductor, Screw Terminations	Telephone Surface Mount Jack, 6-Position, 6-Conductor, Screw Terminations	Multimedia 1-Port Surface Mount Box, Jack Not Included	Multimedia 2-Port Surface Mount Box, Jacks Not Included
Ivory	<b>NS760I</b>	<b>NS761I</b>	<b>ISB1E1*</b>	<b>ISB2E1*</b>
White	<b>NS760W</b>	<b>NS761W</b>	<b>ISB1W*</b>	<b>ISB2W*</b>

Note: \*cULus Listed 1863 - Communication Circuit Accessory.  
 See page W-22 for snap fit multimedia jacks and AV connectors.

# Section X tradeSELECT® Products

## Index

Product	Page
<b>Decorator Products</b>	
Decorator Quiet Rocker Switches . . . . .	X-3
Combination Quiet Rocker Switches/Devices . . . . .	X-4
Weather Resistant, Tamper-Resistant and Standard Receptacles . . . . .	X-5
Wallplates . . . . .	X-6
Combination Wallplates. . . . .	X-7
Decorator Frames . . . . .	X-8
Modular Snap Fit Jacks . . . . .	X-9
Molded-In Voice/Data/Video . . . . .	X-10
<b>Switches and Receptacles</b>	
Toggle Switches . . . . .	X-12
Combination Switches/Devices. . . . .	X-13
Duplex Quick Thread Receptacles . . . . .	X-14
Duplex and Single Receptacles . . . . .	X-15
USB Charger Receptacle Tamper-Resistant Duplex. . . . .	X-16
GFCI Receptacles with Auto Grounding . . . . .	X-18
Range and Dryer Power Receptacles and Plugs . . . . .	X-19
Special Use Products . . . . .	X-20
<b>Lighting Controls</b>	
Dimmers and Fan Speed Controls . . . . .	X-21
CFL/LED, Toggle, Rotary Dimmers and Fan Speed Controls. . . . .	X-22
Wall Switches and Sensors. . . . .	X-23
<b>Power Delivery</b>	
Floor Boxes for Wood Floors . . . . .	X-24
Floor Boxes for Concrete Floors. . . . .	X-26
Under Cabinet/Counter Power Distribution . . . . .	X-28
JLOAD® Multimedia Outlet . . . . .	X-29
Technical Information . . . . .	X-30

### Decorator Products



### Data Communications and Audio/Video



### USB Chargers



### Power Delivery



tradeSELECT® Products  
**Decorator Quiet Rocker Switches**

*Advantages*

**Smart Style, Good Looks**

Residential Decorator Switches and Receptacles provide more than solid, dependable function alone. Indeed, they are fashion statements, masterfully complementing the look and feel of any room in any home.

**A Perfect Match**

Residential decorator devices and wallplates blend in beautifully with all kinds of wall coverings.

**Easy-Activate Rockers**

Ideal for use in assisted-living environments—or any living environment.



**Flush and Contemporary**

Sleek, smart and appealing, Residential devices add beautiful, fashionable, highly-styled devices to any home.

**Mini-Rocker Switches**

Take up less space and provide full function.

**Snap-On Wallplates**

Snap-on wallplates offer a clean, elegant look that can be installed in seconds.



**Color Selection**



### Features

- Smooth, quiet rocker
- Self-grounding feature is standard
- Ultrasonically welded cover and base
- Operating temperature: -20°C to 60°C
- UL Listed E3896, CSA Certified

### Single Pole Decorator Quiet Rocker Switches

Description	Single Pole	Single Pole, Illuminated	Single Pole, Pilot Light	Single Pole with ON/OFF Marking
Termination	Self-Grounding, Push, Back and Side Wire	Self-Grounding, Push, Back and Side Wire	Self-Grounding, Push, Back and Side Wire	Self-Grounding, Push, Back and Side Wire
Rating	15A 120-277V AC	15A 120V AC	15A 120V AC	15A 120-277V AC
Black	RSD115BK	—	—	—
Brown	RSD115	—	—	—
Gray	RSD115GY	—	—	—
Ivory	RSD115I	RSD115ILI*	RSD115PLI**	RSD115IM
Light Almond	RSD115LA	RSD115ILLA*	RSD115PLLA**	RSD115LAM
White	RSD115W	RSD115ILW*	RSD115PLW**	RSD115WM

Note: \*Light glows through the top portion of the rocker when switch is in the off position. Does not require a neutral wire.  
\*\*Light glows through the top portion of the rocker when switch is in the on position. Requires a neutral wire.



RSD115W



RSD115PLW



RSD115WM

### Double Pole, Three Way and Four Way Decorator Quiet Rocker Switches

Description	Double Pole	Three Way	Three Way, Illuminated	Four Way
Termination	Self-Grounding, Back and Side Wire	Self-Grounding, Push, Back and Side Wire	Self-Grounding, Push, Back and Side Wire	Self-Grounding, Back and Side Wire
Rating	15A 120-277V AC	15A 120-277V AC	15A 120V AC	15A 120-277V AC
Black	RSD215BK	RSD315BK	—	—
Brown	RSD215	RSD315	—	RSD415
Gray	RSD215GY	RSD315GY	—	RSD415GY
Ivory	RSD215I	RSD315I	RSD315ILI*	RSD415I
Light Almond	RSD215LA	RSD315LA	RSD315ILLA*	RSD415LA
White	RSD215W	RSD315W	RSD315ILW*	RSD415W

Note: \*Light glows through the top portion of the rocker when switch is in the off position. Does not require a neutral wire.

### Dimensions

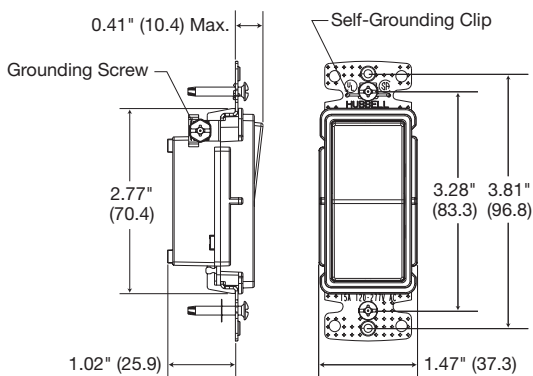

Single Pole Decorator Switch

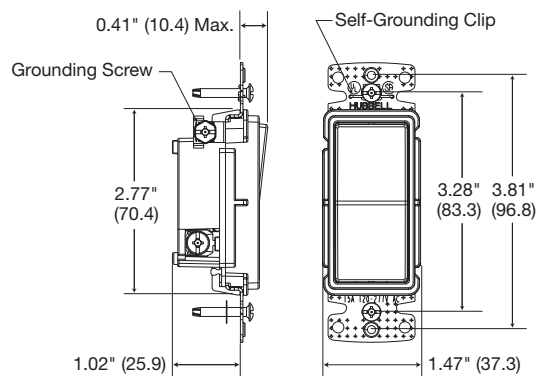

Three Way Decorator Switch



RSD215W

Dimensions in Inches (mm)

### Features

- Low profile, less than 1 inch deep
- Self-grounding feature is standard
- Operating temperature: -20°C to 60°C
- UL Listed E3896, CSA Certified

### Combination Quiet Rocker Switches/Devices



RCD111W



RCD101W



RCD108W



RCD109W

Description	Three (3) Single Pole Switches	Two (2) Single Pole Switches	Single Pole and Three Way Switch	 * Single Pole Switch, Tamper-Resistant, 2 Pole, 3 Wire, Receptacle	Single Pole Switch, 2 Pole, 3 Wire Receptacle
	Termination	Self-Grounding, Side Wire	Self-Grounding, Side Wire	Self-Grounding, Side Wire	Self-Grounding, Side Wire
Rating	15A 120-277V AC	15A 120-277V AC	15A 120-277V AC	15A 120V (switch) 15A 125V (recept.) NEMA 5-15R	15A 120V (switch) 15A 125V (recept.) NEMA 5-15R
Black	—	RCD101BK	RCD103BK	RCD108BKTR	RCD108BK
Gray	—	RCD101GY	RCD103GY	RCD108GYTR	RCD108GY
Ivory	RCD111I	RCD101I	RCD103I	RCD108ITR	RCD108I
Light Almond	RCD111LA	RCD101LA	RCD103LA	RCD108LATR	RCD108LA
White	RCD111W	RCD101W	RCD103W	RCD108WTR	RCD108W

Description	Two (2) Three Way Switches	 * Three Way Switch, Tamper-Resistant, 2 Pole, 3 Wire, Receptacle	Three Way Switch, 2 Pole, 3 Wire Receptacle	Single Pole Switch, Pilot Light, Clear Lens, Amber Neon Bulb	Three Way Switch, Pilot Light, Clear Lens, Amber Neon Bulb
	Termination	Self-Grounding, Side Wire	Self-Grounding, Side Wire	Self-Grounding, Side Wire	Self-Grounding, Side Wire
Rating	15A 120-277V AC	15A 120V (switch) 15A 125V (recept.) NEMA 5-15R	15A 120V (switch) 15A 125V (recept.) NEMA 5-15R	15A 120V	15A 120V
Black	RCD303BK	RCD308BKTR	RCD308BK	—	—
Gray	RCD303GY	RCD308GYTR	RCD308GY	—	—
Ivory	RCD303I	RCD308ITR	RCD308I	RCD109I	RCD309I
Light Almond	RCD303LA	RCD308LATR	RCD308LA	RCD109LA	RCD309LA
White	RCD303W	RCD308WTR	RCD308W	RCD109W	RCD309W

Note: \*See Technical section, page 10 for Tamper-Resistant description.

### Pilot Light Wiring Diagram

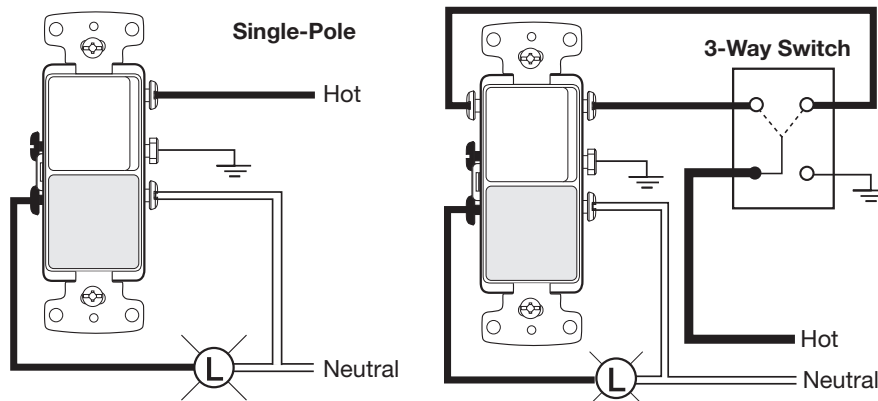

Decorator Duplex Receptacles, 2 Pole, 3 Wire

	*	*		
Description	Weather and Tamper-Resistant	Tamper-Resistant	Standard	Standard
Termination	Self-Grounding, Push and Side Wire	Self-Grounding, Push and Side Wire	Self-Grounding, Push and Side Wire	Push and Side Wire
Rating	15A 125V NEMA 5-15R	15A 125V NEMA 5-15R	15A 125V NEMA 5-15R	15A 125V NEMA 5-15R
Black	RRD15SBKWRTR	RRD15SBKTR	RRD15SBK	RRD15BK
Brown	RRD15SWRTR	RRD15STR	RRD15S	RRD15
Gray	RRD15SGYWRTR	RRD15SGYTR	RRD15SGY	RRD15GY
Ivory	RRD15SIWRTR	RRD15SITR	RRD15SI	RRD15I
Lt. Almond	RRD15SLAWRTR	RRD15SLATR	RRD15SLA	RRD15LA
White	RRD15SWWRTR	RRD15SWTR	RRD15SW	RRD15W



RRD15WTR

	*	*		
Description	Tamper-Resistant	Tamper-Resistant, Without Ears**	Standard, Without Ears**	
Termination	Self-Grounding, Eight Push Wire Holes Only #14 AWG	Self-Grounding, Push and Side Wire	Self-Grounding, Push and Side Wire	
Rating	15A 125V NEMA 5-15R	15A 125V NEMA 5-15R	15A 125V NEMA 5-15R	
Black	RRD15EBKTR	RRD15KBKTR	RRD15KBK	
Brown	RRD15ETR	RRD15KTR	RRD15K	
Gray	RRD15EGYTR	RRD15KGYTR	RRD15KGY	
Ivory	RRD15EITR	RRD15KITR	RRD15KI	
Lt. Almond	RRD15ELATR	RRD15KLATR	RRD15KLA	
White	RRD15EWTR	RRD15KWTR	RRD15KW	



RRD15SW



RRD15KW

Note: \*See Technical section, page 10 for Weather and Tamper-Resistant descriptions.  
\*\*100 per case, bulk packed. Mounting screws inserted into strap.

Decorator Single Receptacles, 2 Pole, 3 Wire

	*		*	
Description	Tamper-Resistant	Standard	Tamper-Resistant	Standard
Termination	Self-Grounding, Side Wire	Self-Grounding, Side Wire	Self-Grounding, Side Wire	Self-Grounding, Side Wire
Rating	15A 125V NEMA 5-15R	15A 125V NEMA 5-15R	20A 125V NEMA 5-20R	20A 125V NEMA 5-20R
Black	RRD151BKTR	RRD151BK	RRD201BKTR	RRD201BK
Brown	RRD151TR	RRD151	RRD201TR	RRD201
Gray	RRD151GYTR	RRD151GY	RRD201GYTR	RRD201GY
Ivory	RRD151ITR	RRD151I	RRD201ITR	RRD201I
Lt. Almond	RRD151LATR	RRD151LA	RRD201LATR	RRD201LA
White	RRD151WTR	RRD151W	RRD201WTR	RRD201W



RRD151W

Description	Standard	Standard
Termination	Self-Grounding, Side Wire	Self-Grounding, Side Wire
Rating	15A 250V NEMA 6-15R	20A 250V NEMA 6-20R
Black	RRD155BK	RRD205BK
Brown	RRD155	RRD205
Gray	RRD155GY	RRD205GY
Ivory	RRD155I	RRD205I
Lt. Almond	RRD155LA	RRD205LA
White	RRD155W	RRD205W



RRD205W

Note: \*See Technical section, page 10 for Tamper-Resistant description.

### More Style In a Snap

Snap-on wallplates offer a clean, elegant look that can be installed in seconds. Screw the mounting plate onto the device and press the snap-on cover into place. Four snaps securely hold the cover to the subplate.

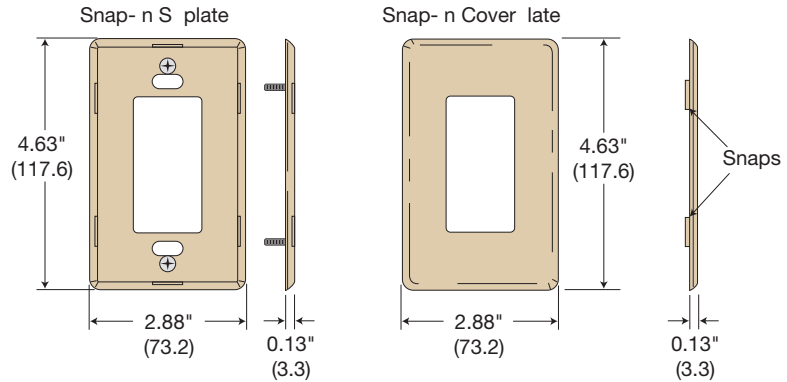

### Decorator, Snap-On, Polycarbonate, Two Piece Construction Wallplates



Color	1-Gang, 1-Decorator	2-Gang, 2-Decorator	3-Gang, 3-Decorator	4-Gang, 4-Decorator	5-Gang, 5-Decorator	6-Gang, 6-Decorator
Ivory	RCW1I	RCW2I	RCW3I	RCW4I	RCW5I	RCW6I
Light Almond	RCW1LA	RCW2LA	RCW3LA	RCW4LA	RCW5LA	RCW6LA
White	RCW1W	RCW2W	RCW3W	RCW4W	RCW5W	RCW6W

### Decorator, Screw-On, Standard, Nylon Wallplates

Color	1-Gang, 1-Decorator	2-Gang, 2-Decorator	3-Gang, 3-Decorator	4-Gang, 4-Decorator	5-Gang, 5-Decorator	6-Gang, 6-Decorator
Black	NP26BK	NP262BK	NP263BK	NP264BK	NP265BK	NP266BK
Brown	NP26	NP262	NP263	NP264	NP265	NP266
Gray	NP26GY	NP262GY	NP263GY	NP264GY	NP265GY	NP266GY
Ivory	NP26I	NP262I	NP263I	NP264I	NP265I	NP266I
Light Almond	NP26LA	NP262LA	NP263LA	NP264LA	NP265LA	NP266LA
White	NP26W	NP262W	NP263W	NP264W	NP265W	NP266W

### Decorator, Screw-On, Mid-Size, Nylon Wallplates

Color	1-Gang, 1-Decorator	2-Gang, 2-Decorator	3-Gang, 3-Decorator	4-Gang, 4-Decorator	5-Gang, 5-Decorator	6-Gang, 6-Decorator
Black	NPJ26BK	NPJ262BK	NPJ263BK	NPJ264BK	—	—
Brown	NPJ26	NPJ262	NPJ263	NPJ264	—	—
Gray	NPJ26GY	NPJ262GY	NPJ263GY	NPJ264GY	—	—
Ivory	NPJ26I	NPJ262I	NPJ263I	NPJ264I	—	—
Light Almond	NPJ26LA	NPJ262LA	NPJ263LA	NPJ264LA	—	—
White	NPJ26W	NPJ262W	NPJ263W	NPJ264W	—	—

### Decorator, Screw-On, Mid-Size, Metal Wallplates

Material	1-Gang, 1-Decorator	2-Gang, 2-Decorator	3-Gang, 3-Decorator	4-Gang, 4-Decorator	5-Gang, 5-Decorator	6-Gang, 6-Decorator
Brass	SB26	SB262	—	—	—	—
Brass Plated	SBP26	SBP262	SBP263	—	—	—
Chrome	SCH26	SCH262	—	—	—	—
S/S 302/304	SS26	SS262	SS263	SS264	SS265	SS266
S/S 430	SS26L	SS262L	—	—	—	—

Dimensions in Inches (mm)



**Combination, Nylon, Standard Wallplates**

Color	2-Gang, 1-Toggle 1-Decorator	2-Gang, 1-Duplex, 1-Decorator	2-Gang, 1-Blank Box Mount 1-Decorator	3-Gang, 2-Toggle 1-Decorator	3-Gang, 1-Toggle 2-Decorator	4-Gang, 3-Toggle 1-Decorator	4-Gang, 2-Toggle 2-Decorator
Black	NP126BK	NP826BK	NP1326BK	NP226BK	NP1262BK	NP326BK	NP2262BK
Brown	NP126	NP826	NP1326	NP226	NP1262	NP326	NP2262
Gray	NP126GY	NP826GY	NP1326GY	NP226GY	NP1262GY	NP326GY	NP2262GY
Ivory	NP126I	NP826I	NP1326I	NP226I	NP1262I	NP326I	NP2262I
Light Almond	NP126LA	NP826LA	NP1326LA	NP226LA	NP1262LA	NP326LA	NP2262LA
White	NP126W	NP826W	NP1326W	NP226W	NP1262W	NP326W	NP2262W

**Combination, Nylon, Mid-Size Wallplates**

Color	2-Gang, 1-Toggle 1-Decorator	2-Gang, 1-Duplex, 1-Decorator	2-Gang, 1-Blank Box Mount 1-Decorator	3-Gang, 2-Toggle 1-Decorator	3-Gang, 1-Toggle 2-Decorator	4-Gang, 3-Toggle 1-Decorator	4-Gang, 2-Toggle 2-Decorator
Black	NPJ126BK	NPJ826BK	—	NPJ226BK	—	—	—
Brown	NPJ126	NPJ826	NPJ1326	NPJ226	—	—	—
Gray	NPJ126GY	NPJ826GY	—	NPJ226GY	—	—	—
Ivory	NPJ126I	NPJ826I	NPJ1326I	NPJ226I	—	—	—
Light Almond	NPJ126LA	NPJ826LA	NPJ1326LA	NPJ226LA	—	—	—
White	NPJ126W	NPJ826W	NPJ1326W	NPJ226W	—	—	—

**Combination, Standard, Metal Wallplates**

Material	2-Gang, 1-Toggle 1-Decorator	2-Gang, 1-Duplex, 1-Decorator	2-Gang, 1-Blank Strap Mount 1-Decorator	3-Gang, 2-Toggle 1-Decorator	3-Gang, 1-Toggle 2-Decorator	4-Gang, 3-Toggle 1-Decorator	4-Gang, 2-Toggle 2-Decorator
Brass	SB126	SB826	—	—	—	—	—
Brass Plated	SBP126	—	—	—	—	—	—
Chrome	—	—	—	—	—	—	—
SS 302/304	SS126	SS826	SS1426	SS226	—	SS326	—
SS 430	SS126L	—	—	—	—	—	—

**Dimensions**

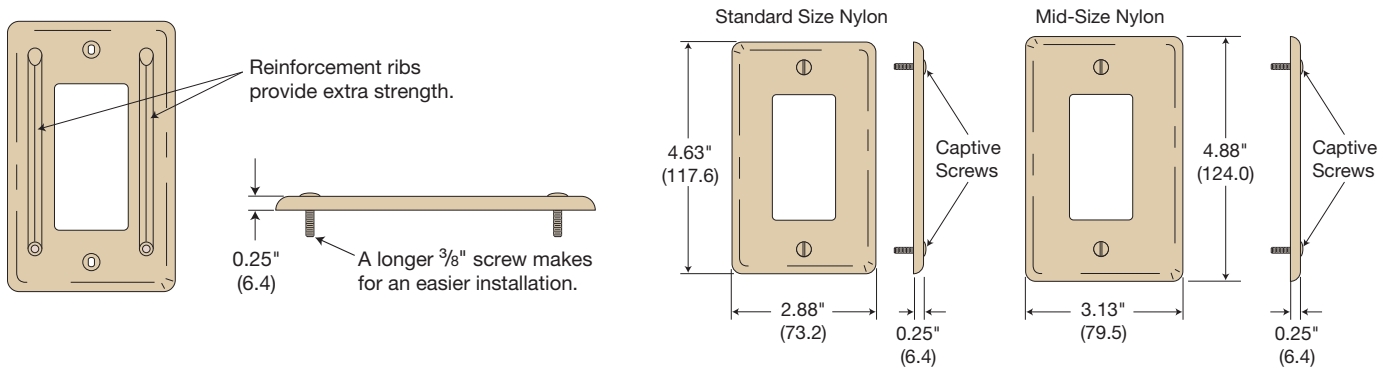

Dimensions in Inches (mm)

**Features**

Decorator frames provide a stylized look for that finishing touch. This allows all devices to match. Multimedia jacks insert into frame for custom configuration.

- Elongated strap for better wall box mounting
- High impact-resistant thermoplastic frame
- UL Listed 1863 - Communication Circuit Accessory and CSA Certified

Customize the jack selections and look

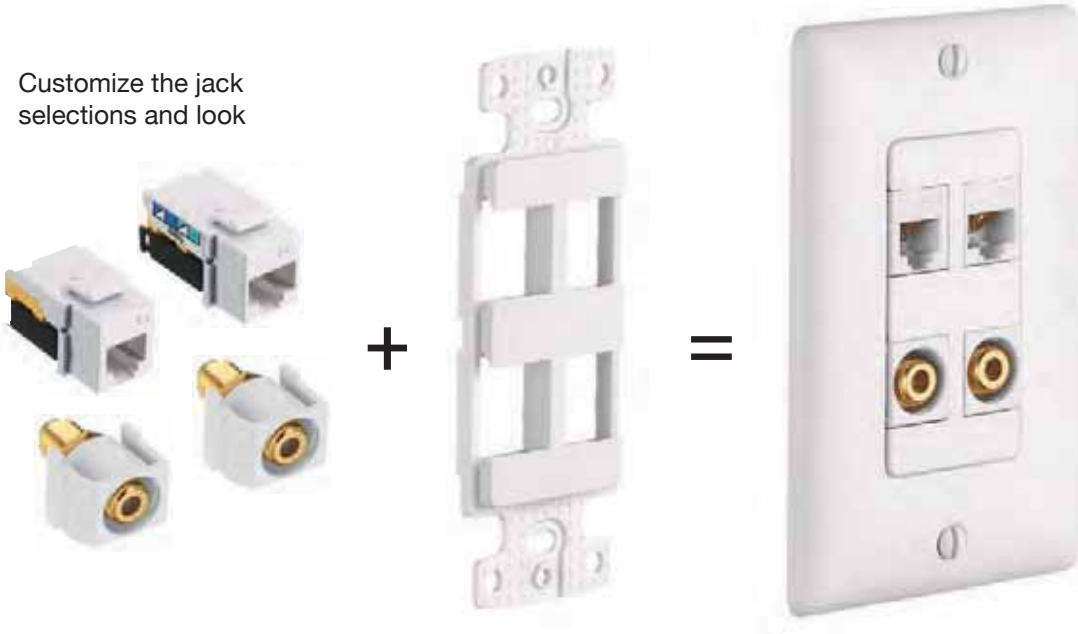

**Decorator Frames**



Color	1-Gang, 2-Port	1-Gang, 3-Port	1-Gang, 4-Port	1-Gang, 6-Port	1-Gang, Adapter .406" (10.30) Dia. Hole*	1-Gang, Adapter Blank**
Black	NS612BK	NS613BK	NS614BK	NS616BK	NS621BK	NS620BK
Gray	NS612GY	NS613GY	NS614GY	NS616GY	NS621GY	NS620GY
Ivory	NS612I	NS613I	NS614I	NS616I	NS621I	NS620I
Light Almond	NS612LA	NS613LA	NS614LA	NS616LA	NS621LA	NS620LA
White	NS612W	NS613W	NS614W	NS616W	NS621W	NS620W

Note: \*For use with rotary dimmers or to pull through AV or telephone cable.  
 \*\*To fill an extra decorator opening or to create customized openings.

### Features

netSELECT® Voice/Data Jacks and AV Connectors allow custom creation of multimedia outlets and workstations while maintaining a decorative look.

- Quick and secure snap-in design
- Use with multimedia plates and decorator frames (see page X-8)
- UL Listed and CSA Certified, or cULus Listed  
 1863 - Communication Circuit Accessory

### Molded-In Voice/Low-Speed Data - Modular Snap Fit

Description	Category 6 Jack		Category 5e Jack		USOC Jack
	(single)	(25 pack)	(single)	(25 pack)	(single)
Black	NSJ6BK	NSJ6BK25	NSJ5EBK	NSJ5EBK25	NSJUBK
Blue	NSJ6B	NSJ6B25	NSJ5EB	NSJ5EB25	NSJUB
Gray	NSJ6GY	NSJ6GY25	NSJ5EGY	NSJ5EGY25	NSJUGY
Green	NSJ6GN	NSJ6GN25	NSJ5EGN	NSJ5EGN25	NSJUGN
Ivory	NSJ6I	NSJ6I25	NSJ5EI	NSJ5EI25	NSJUI
Light Almond	NSJ6LA	NSJ6LA25	NSJ5ELA	NSJ5ELA25	NSJULA
Orange	NSJ6OR	NSJ6OR25	NSJ5EOR	NSJ5EOR25	NSJUOR
Red	NSJ6R	NSJ6R25	NSJ5ER	NSJ5ER25	NSJUR
White	NSJ6W	NSJ6W25	NSJ5EW	NSJ5EW25	NSJUW
Yellow	NSJ6Y	NSJ6Y25	NSJ5EY	NSJ5EY25	NSJUY

### Audio/Video Connectors - Standard Bulkhead

Description							
	Nickel F-Type Coupler Bulkhead, Female to Female	Gold F-Type Coupler Bulkhead, Female to Female	RCA Gold Pass Through, Female to Female, Red Interior	RCA Gold Pass Through, Female to Female, White Interior	RCA Gold Pass Through, Female to Female, Yellow Interior	RCA Gold Pass Through, Female to Female, Blue Interior	RCA Gold Pass Through, Female to Female, Green Interior
Black	NSF70BK	SFFGBK	SFRCRFFBK	SFRCWFFBK	SFRCYFFBK	SFRCBFFBK	SFRCGNFFBK
Gray	NSF70GY	SFFGGY	SFRCRFFGY	SFRCWFFGY	SFRCYFFGY	SFRCBFFGY	SFRCGNFFGY
Ivory	NSF70I	SFFGEI	SFRCRFFEI	SFRCWFFEI	SFRCYFFEI	SFRCBFFEI	SFRCGNFFEI
Light Almond	NSF70LA	SFFGLA	SFRCRFFLA	SFRCWFFLA	SFRCYFFLA	SFRCBFFLA	SFRCGNFFLA
White	NSF70W	SFFGW	SFRCRFFW	SFRCWFFW	SFRCYFFW	SFRCBFFW	SFRCGNFFW

### Audio/Video Connectors - Recessed

Description							
	Gold F-Type Coupler Bulkhead, Female to Female	RCA Gold Pass Through, Female to Female, Red Interior	RCA Gold Pass Through, Female to Female, White Interior	RCA Gold Pass Through, Female to Female, Yellow Interior	RCA Gold Pass Through, Female to Female, Blue Interior	RCA Gold Pass Through, Female to Female, Green Interior	Blank Insert
Black	SFGRFBK	SFRCRRBK	SFRCWRBK	SFRCYRBK	SFRCBRBK	SFRCGNRBK	SFSBBK10*
Gray	SFGRFGY	SFRCRRGY	SFRCWRGY	SFRCYRGY	SFRCBRGY	SFRCGNRGY	SFSBGY10*
Ivory	SFGRFEI	SFRCRREI	SFRCWREI	SFRCYREI	SFRCBREI	SFRCGNREI	SFSBEI10*
Light Almond	SFGRFLA	SFRCRRLA	SFRCWRLA	SFRCYRLA	SFRCBRLA	SFRCGNRLA	SFSBLA10*
White	SFGRFW	SFRCRRW	SFRCWRW	SFRCYRW	SFRCBRW	SFRCGNRW	SFSBW10*

Note: \*Sold in a package of 10. Order 1 to receive a bag of 10 blanks.

### Features

Designed to complement decorator styling, these jacks offer voice and Cat. 5e devices to fit within a decorator wallplate.

- High impact-resistant thermoplastic frame
- Meets FCC part 68
- UL Listed 1863 - Communication Circuit Accessory and CSA Certified

### Molded-In Voice/Low-Speed Data

Description	Decorator Frame, One RJ11 Jack, 6-Position, 4-Conductor	Decorator Frame, One RJ11 Jack, 6-Position, 6-Conductor	Decorator Frame, Duplex RJ11 Jacks, 6-Position, 6-Conductor	Decorator Frame, One Cat. 5e One RJ11 Jack, 6-Position, 4-Conductor
Termination	Screw Terminations	Screw Terminations	Screw Terminations	110 Punch-Down
Color				
Black	NS770BK	—	—	NS784BK
Brown	NS770	NS771	—	NS784
Gray	NS770GY	—	—	NS784GY
Ivory	NS770I	NS771I	NS772I	NS784I
Light Almond	NS770LA	NS771LA	NS772LA	NS784LA
White	NS770W	NS771W	NS772W	NS784W

### Features

Coaxial video and combination jacks complement multimedia needs in a 1-gang decorator opening.

- High impact-resistant thermoplastic frame
- Jacks meet FCC part 68
- UL Listed 1863 - Communication Circuit Accessory and CSA Certified

### Molded-In Voice/Low-Speed Data

Description	Decorator Frame, Single F-Type Coupler Bulkhead, Female to Female	Decorator Frame, Duplex F-Type Coupler Bulkhead, Female to Female	Decorator Frame, One RJ11 Jack, 6-Position, 4-Conductor, One F-Type Coupler Bulkhead, Female to Female	Decorator Frame, One Cat. 5e One F-Type Coupler Bulkhead, Female to Female
Termination	Screw Terminations	Screw Terminations	Screw Terminations	110 Punch-Down
Color				
Black	—	—	—	NS785BK
Brown	—	—	—	NS785
Gray	—	—	—	NS785GY
Ivory	NS780I	NS782I	NS783I	NS785I
Light Almond	NS780LA	NS782LA	NS783LA	NS785LA
White	NS780W	NS782W	NS783W	NS785W

**Features**

Standard toggle switches provide the basic on/off control for home lighting and appliances.

- Tough thermoplastic with ultrasonically welded cover and base
- Elongated strap for easier wall box mounting
- Hi-visibility yellow base for easy installation
- Operating temperature: -20°C to 60°C
- UL Listed E3896, CSA Certified

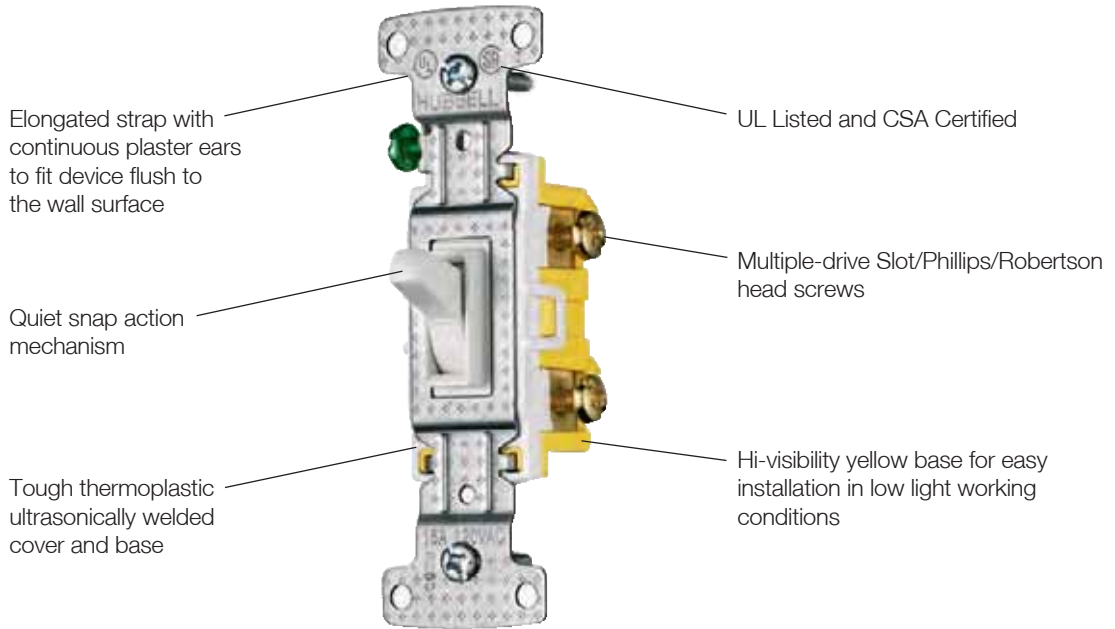

RS115W

**Features**

Mini-toggles provide for multiple switches in a compact single gang. Maximize control while maintaining function and appearance.

- Low profile, less than 1 inch
- Self-grounding feature is standard
- Smooth toggle action
- Operating temperature: -20°C to 60°C
- UL Listed, CSA Certified

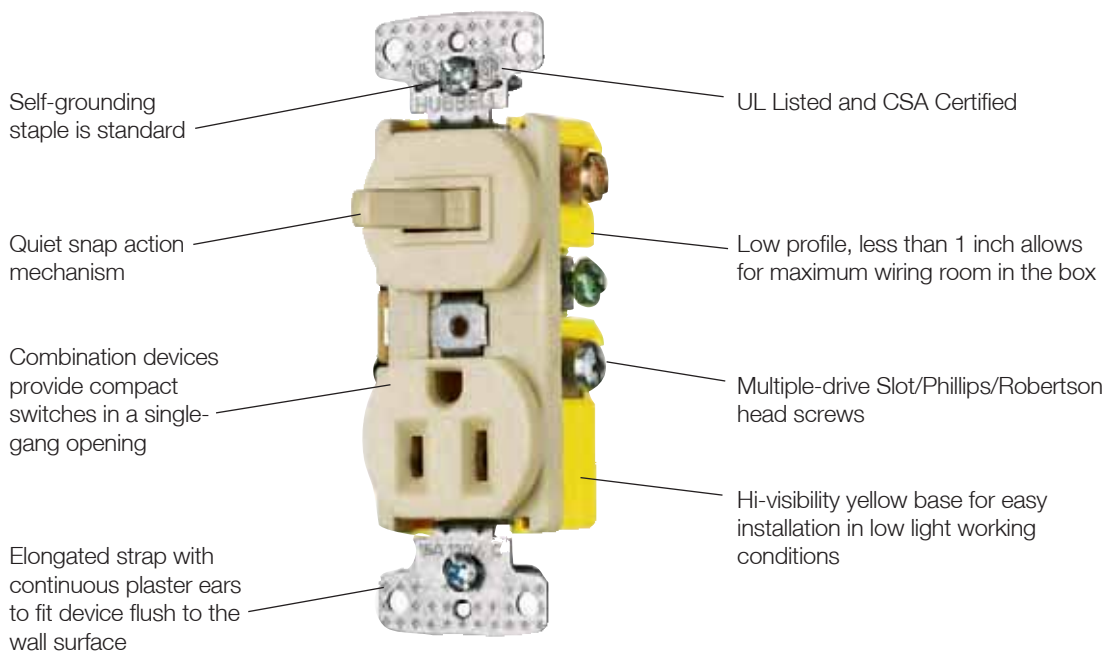

RC108I

### Single Pole Toggle Switches

Description	Single Pole	Single Pole	Single Pole, Illuminated
Termination	Grounding, Push and Side Wire	Self-Grounding, Push and Side Wire	Self-Grounding, Push and Side Wire
Rating	15A 120V AC	15A 120V AC	15A 120V AC
			
Color			
Clear	—	—	RS115ILC
Black	RS115BK	—	—
Brown	RS115	RS115S	—
Ivory	RS115I	RS115SI	RS115ILI*
Light Almond	RS115LA	RS115SLA	RS115ILLA*
White	RS115W	RS115SW	RS115ILW*





Note: \*Frame is clear and illuminates, toggle is colored. Does not require a neutral wire.

### Three and Four Way Toggle Switches

Description	Three Way	Three Way	Three Way, Illuminated	Four Way
Termination	Grounding, Push and Side Wire	Self-Grounding, Push and Side Wire	Self-Grounding, Push and Side Wire	Self-Grounding, Side Wire
Rating	15A 120V AC	15A 120V AC	15A 120V AC	15A 120V AC
				
Color				
Clear	—	—	RS315ILC	—
Black	RS315BK	—	—	RS415BK
Brown	RS315	RS315S	—	RS415
Ivory	RS315I	RS315SI	RS315ILI*	RS415I
Light Almond	RS315LA	RS315SLA	RS315ILLA*	RS415LA
White	RS315W	RS315SW	RS315ILW*	RS415W







Note: \*Frame is clear and illuminates, toggle is colored. Does not require a neutral wire.

### Combination Toggle Switches/Devices

				
Description	Two (2) Single Pole Switches	Single Pole Switch, Tamper-Resistant, 2 Pole, 3 Wire, Receptacle	Single Pole Switch, 2 Pole, 3 Wire, Receptacle	Single Pole Switch, Pilot Light, Clear Lens, Amber Neon Bulb*
Termination	Self-Grounding, Side Wire	Self-Grounding, Side Wire	Self-Grounding, Side Wire	Self-Grounding, Side Wire
Rating	15A 120V AC	15A 120V (switch) 15A 125V (recept.) NEMA 5-15R	15A 120V (switch) 15A 125V (recept.) NEMA 5-15R	15A 120V AC
				
Color				
Brown	RC101	RC108TR	RC108	RC109
Ivory	RC101I	RC108ITR	RC108I	RC109I
Light Almond	RC101LA	RC108LATR	RC108LA	RC109LA
White	RC101W	RC108WTR	RC108W	RC109W

Note: See page Tech-10 for Tamper-Resistant description.  
 \*Neutral required for pilot light, see page X-4 for wiring diagram.

### Combination Toggle Switches/Devices

					
Description	Single Pole and Three Way Switch	Two (2) Three Way Switches	Three Way Switch, Tamper-Resistant, 2 Pole, 3 Wire, Receptacle	Three Way Switch, 2 Pole, 3 Wire, Receptacle	Three Way Switch, Pilot Light, Clear Lens, Amber Neon Bulb*
Termination	Self-Grounding, Side Wire	Self-Grounding, Side Wire	Self-Grounding, Side Wire	Self-Grounding, Side Wire	Self-Grounding, Side Wire
Rating	15A 120V AC	15A 120V AC	15A 120V (switch) 15A 125V (recept.) NEMA 5-15R	15A 120V (switch) 15A 125V (recept.) NEMA 5-15R	15A 120V AC
					
Color					
Brown	RC103	RC303	RC308TR	RC308	RC309
Ivory	RC103I	RC303I	RC308ITR	RC308I	RC309I
Light Almond	RC103LA	RC303LA	—	—	—
White	RC103W	RC303W	RC308WTR	RC308W	RC309W

Note: See page Tech-10 for Tamper-Resistant description.  
 \*Neutral required for pilot light, see page X-4 for wiring diagram.

### Quick and Easy Does It

Residential exclusive “Quick Thread” makes installation of wallplates and receptacles quicker and easier. Just push in the screw and turn. Provides branch circuit convenience power in duplex and single configurations.

- Smooth indented face appearance
- Terminal screws accepts up to #12 AWG
- Push wire designed for #14 AWG solid copper wire only
- Operating temperature: -20°C to 60°C
- UL Listed E2186, CSA Certified

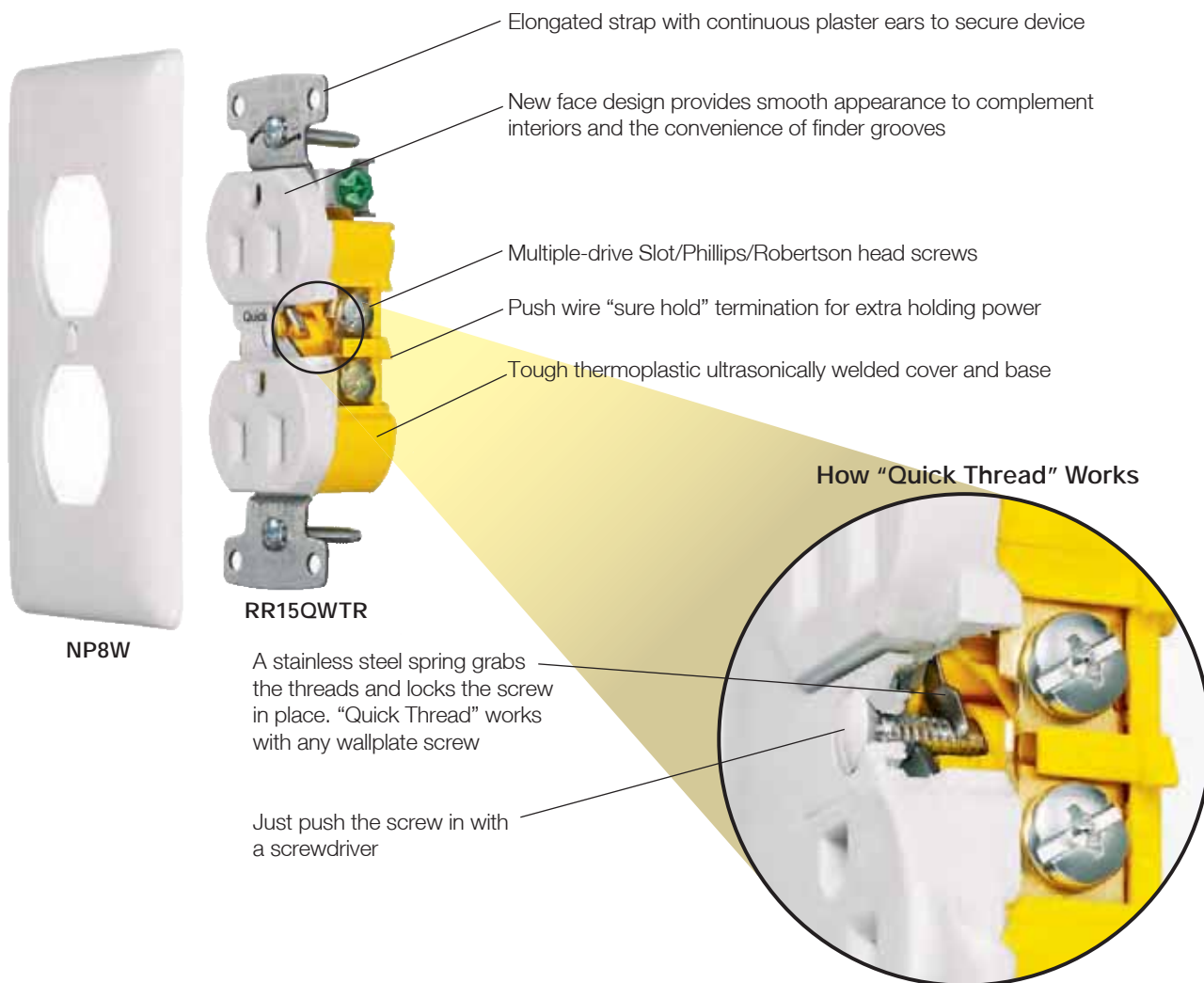

### Duplex Quick Thread Receptacles, 2 Pole, 3 Wire



	Tamper-Resistant, Quick Thread	Tamper-Resistant, Quick Thread
Description	Tamper-Resistant, Quick Thread	Tamper-Resistant, Quick Thread
Termination	Self-Grounding, Push and Side Wire	Eight Push Wire Holes Only #14 AWG
Rating	15A 125V NEMA 5-15R	15A 125V NEMA 5-15R
Black	RR15QBKTR	RR15EQBKTR
Brown	RR15QTR	RR15EQTR
Ivory	RR15QITR	RR15EQITR
Light Almond	RR15QLATR	RR15EQLATR
White	RR15QWTR	RR15EQWTR

Note: See page Tech-10 for Tamper-Resistant description.



Duplex Receptacles, 2 Pole, 3 Wire

Description	Standard	Weather and Tamper-Resistant	Tamper-Resistant	Standard
Termination	Grounding, Push and Side Wire	Self-Grounding, Push and Side Wire	Self-Grounding, Push and Side Wire	Self-Grounding, Push and Side Wire
Rating	15A 125V NEMA 5-15R	15A 125V NEMA 5-15R	15A 125V NEMA 5-15R	15A 125V NEMA 5-15R
Black	RR15BK	RR15SBKWRTR	RR15SBKTR	RR15SBK
Brown	RR15	RR15SWRTR	RR15STR	RR15S
Ivory	RR15I	RR15SIWRTR	RR15SITR	RR15SI
Light Almond	RR15LA	RR15SLAWRTR	RR15SLATR	RR15SLA
White	RR15W	RR15SWRTR	RR15SWTR	RR15SW



RR15W

Description	Tamper-Resistant,	Tamper-Resistant, Without Ears*	Standard, Without Ears*
Termination	Eight Push Wire Holes Only #14 AWG	Eight Push Wire Holes Only #14 AWG	Eight Push Wire Holes Only #14 AWG
Rating	15A 125V NEMA 5-15R	15A 125V NEMA 5-15R	15A 125V NEMA 5-15R
Black	RR15EBKTR	—	—
Brown	RR15ETR	RR15KTR	RR15K
Gray	RR15EGYTR	—	—
Ivory	RR15EITR	RR15KITR	RR15KI
Light Almond	RR15ELATR	RR15KLATR	—
White	RR15EWTR	RR15KWTR	RR15KW



RR15EWTR

Note: See page Tech-10 for Weather and Tamper-Resistant descriptions.  
\*100 per case, bulk packed. Mounting screws inserted into strap.

Single Receptacles, 2 Pole, 3 Wire

Description	Weather and Tamper-Resistant	Tamper-Resistant	Standard	Weather Resistant	Standard
Termination	Self-Grounding, Side Wire	Self-Grounding, Side Wire	Self-Grounding, Side Wire	Self-Grounding, Side Wire	Self-Grounding, Side Wire
Rating	15A 125V NEMA 5-15R	15A 125V NEMA 5-15R	15A 125V NEMA 5-15R	15A 250V NEMA 6-15R	15A 250V NEMA 6-15R
Black	RR151BKWRTR	RR151BKTR	RR151BK	RR155BKWR	RR155BK
Brown	RR151WRTR	RR151TR	RR151	RR155WR	RR155
Gray	RR151GYWRTR	RR151GYTR	RR151GY	RR155GYWR	RR155GY
Ivory	RR151IWRTR	RR151ITR	RR151I	RR155IWR	RR155I
Light Almond	RR151LAWRTR	RR151LATR	RR151LA	RR155LAWR	RR155LA
White	RR151WWRTR	RR151WTR	RR151W	RR155WWR	RR155W



RR15KW



RR151W

Description	Weather and Tamper-Resistant	Tamper-Resistant	Standard	Weather Resistant	Standard
Termination	Self-Grounding, Side Wire	Self-Grounding, Side Wire	Self-Grounding, Side Wire	Self-Grounding, Side Wire	Self-Grounding, Side Wire
Rating	20A 125V NEMA 5-20R	20A 125V NEMA 5-20R	20A 125V NEMA 5-20R	20A 250V NEMA 6-20R	20A 250V NEMA 6-20R
Black	RR201BKWRTR	RR201BKTR	RR201BK	RR205BKWR	RR205BK
Brown	RR201WRTR	RR201TR	RR201	RR205WR	RR205
Gray	RR201GYWRTR	RR201GYTR	RR201GY	RR205GYWR	RR205GY
Ivory	RR201IWRTR	RR201ITR	RR201I	RR205IWR	RR205I
Light Almond	RR201LAWRTR	RR201LATR	RR201LA	RR205LAWR	RR205LA
White	RR201WWRTR	RR201WTR	RR201W	RR205WWR	RR205W



RR201W

Note: See page Tech-10 for Weather and Tamper-Resistant descriptions.

## Features

Hubbell's USB Charger Receptacle provides both USB and electrical power in a standard single gang electrical opening. Designed to provide more charging options for personal electronics. The USB ports are capable of charging two tablets simultaneously. The Tamper-Resistant Style Line® decorator outlets provide additional power for appliance use.

- Two USB ports 3 Amp, 5VDC, Type A, 2.0
- Tamper-Resistant (TR) decorator duplex
- Green LED indicator to show USB power available
- Impact and chemical resistant
- Back and side wire for solid or stranded wire
- Flush fit design

## Typical Applications

Ideal for use in renovation, new construction and to add capacity for USB charging. Especially suited for use in hotels, hospitals, schools, offices, homes and more.



Hotels



Healthcare



Schools



Offices



Residential

Capability to charge wide range of devices including:

- Tablets
- Smartphones
- MP3 players
- Apple® iPad®
- Apple® iPod®
- Apple® iPhone®

- Hospital grade available
- Complies with battery charging specification USB BC1.2
- Compatible with USB 1.1/2.0/3.0 devices, including Apple® products
- Complies with Part 15 of the FCC rules
- cULus listed to UL498 and UL1310

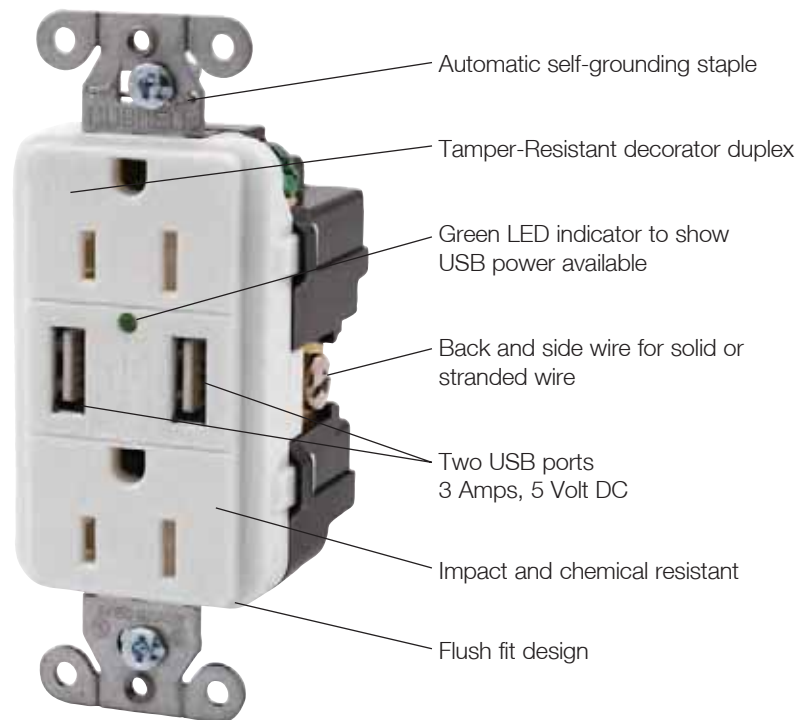

**USB15X2W**

*Apple, iPad, iPod and iPhone are registered trademarks of Apple, inc.*

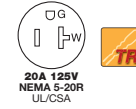
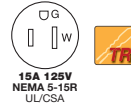

### USB Charger Receptacle Tamper-Resistant Duplex

Description	Color	Catalog Number	
USB Charger Tamper-Resistant receptacle, Two USB Type 2.0 Ports 3 Amp, 5 Volt DC, 15 or 20 Amp, 125 Volt AC decorator duplex.	Black	<b>USB15X2BK</b>	<b>USB20X2BK</b>
	Brown	<b>USB15X2</b>	<b>USB20X2</b>
	Gray	<b>USB15X2GY</b>	<b>USB20X2GY</b>
	Ivory	<b>USB15X2I</b>	<b>USB20X2I</b>
	Light Almond	<b>USB15X2LA</b>	<b>USB20X2LA</b>
	White	<b>USB15X2W</b>	<b>USB20X2W</b>
Hospital Grade USB Charger Tamper-Resistant receptacle, Two USB Type 2.0 Ports 3 Amp, 5 Volt DC, 15 or 20 Amp, 125 Volt AC decorator duplex.	Black	<b>USB8200BK</b>	<b>USB8300BK</b>
	Brown	<b>USB8200</b>	<b>USB8300</b>
	Gray	<b>USB8200GY</b>	<b>USB8300GY</b>
	Ivory	<b>USB8200I</b>	<b>USB8300I</b>
	Light Almond	<b>USB8200LA</b>	<b>USB8300LA</b>
	Red	<b>USB8200R</b>	<b>USB8300R</b>
White	<b>USB8200W</b>	<b>USB8300W</b>	

Note: See page Tech-10 for Tamper-Resistant description.



USB15X2W



USB8300W

### USB 4 Port Charger

Description	Color	Catalog Number
USB Charger 4 Port Outlet, Four USB Type 2.0 Ports 5 Amp, 5 Volt DC decorator.	Black	<b>USB4BK</b>
	Brown	<b>USB4</b>
	Gray	<b>USB4GY</b>
	Ivory	<b>USB4I</b>
	Light Almond	<b>USB4LA</b>
	White	<b>USB4W</b>



USB4W

### Specifications

- Electrical ratings: 15 or 20 Amp, 125VAC, USB 3 Amp, 5VDC
- Input voltage: 125V AC, 60Hz
- Circuit feed-through 20 Amp, 125 Volt
- #10-14 AWG gauge wire terminals
- Dielectric withstand: 2000V
- Operating temperature: maximum continuous 75° C; minimum -40° C (without impact)
- Meets UL94 for 5V flammability rating
- Complies with battery charging specification USB BC1.2
- Compatible with USB 1.1/2.0/3.0 devices, including Apple® products
- Complies with Part 15 of the FCC rules
- cULus listed to UL498 and UL1310

### Dimensions

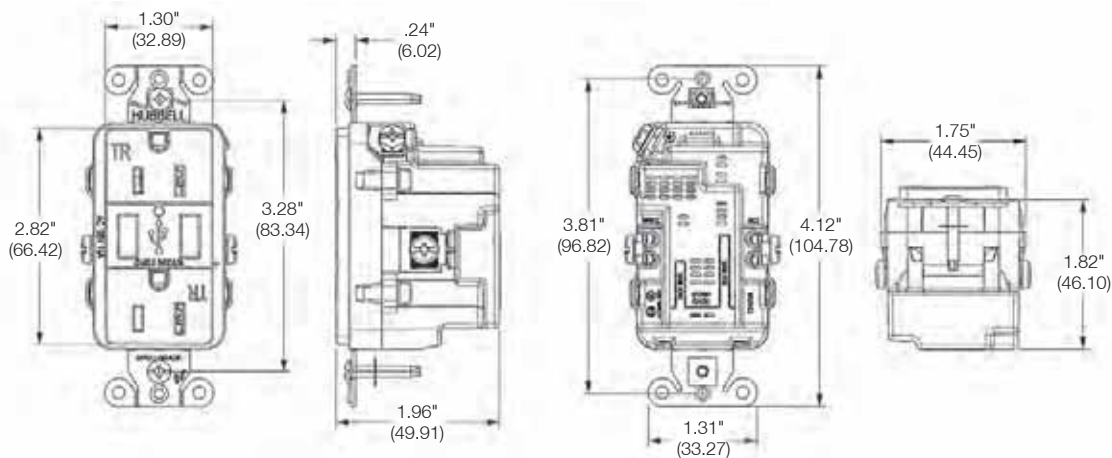

Note: For use with boxes deeper than 1.5" with internal AC/MC clamps.

Apple, iPad, iPod and iPhone are registered trademarks of Apple, inc.

Dimensions in Inches (mm)

**Safety and Economy**



GF15ILA

**10kA Short Circuit Current Rating**

- Comprehensive diagnostics
  - When test button is actuated, both the electronic components and mechanical trip mechanism are functionally tested
- Ground fault indicator
  - Flashing **RED** indicates device has lost capability to provide protection
- No power at face if reverse wired
  - Open circuit condition eliminates false assumption of protection at face
- Installation ease
  - Internal back wiring
  - Automatic grounding feature
  - Captive mounting screws



GF15ILA







GFTR20I



GFBF20ILA

**GFCI Duplex Receptacles, Flush Nylon Face, Matching Nylon Wallplate Included**

Description	 Weather and Tamper-Resistant	 Standard	 Weather and Tamper-Resistant	 Standard
	Termination	Self-Grounding, Back and Side Wire	Self-Grounding, Back and Side Wire	Self-Grounding, Back and Side Wire
Rating	15A 125V AC NEMA 5-15R	15A 125V AC NEMA 5-15R	20A 125V AC NEMA 5-20R	20A 125V AC NEMA 5-20R
Black	GFTR15BK	GF15BKLA	GFTR20BK	GF20BKLA
Brown	GFTR15	GF15LA	GFTR20	GF20LA
Gray	GFTR15GY	GF15GYLA	GFTR20GY	GF20GYLA
Ivory	GFTR15I	GF15ILA	GFTR20I	GF20ILA
Light Almond	GFTR15LA	GF15LALA	GFTR20LA	GF20LALA
Red	GFTR15R	GF15RLA	GFTR20R	GF20RLA
White	GFTR15W	GF15WLA	GFTR20W	GF20WLA

*Note: See page Tech-10 for Weather and Tamper-Resistant descriptions.  
 Bulk 50 pack available without plates, add "BULK" suffix. Example: GFTR20WBULK.*





**GFCI Faceless Receptacles, Flush Nylon Face, Matching Nylon Wallplate Included**

Description	Circuit Guard® Faceless
Termination	Self-Grounding, Back and Side Wire
Rating	20A 125V NEMA 5-20R
Black	GFBF20BKLA
Brown	GFBF20LA
Gray	GFBF20GYLA
Ivory	GFBF20ILA
Light Almond	GFBF20LALA
Red	GFBF20RLA
White	GFBF20WLA

tradeSELECT® Products  
**Range and Dryer Power Receptacles and Plugs**  
 30 and 50 Ampere, 125/250 Volts AC, 3 Pole, 3 Wire and 3 Pole, 4 Wire



**Range and Dryer Power Receptacles**

				
Description	Flush Mount for 1- or 2-Gang Box	Flush Mount for 1- or 2-Gang Box	Flush Mount for 1- or 2-Gang Box	Flush Mount for 1- or 2-Gang Box
Rating	30A 125/250V 3 Pole, 4 Wire with Ground	50A 125/250V 3 Pole, 4 Wire with Ground	30A 125/250V 3 Pole, 3 Wire without Ground	50A 125/250V 3 Pole, 3 Wire without Ground
Black	<b>RR430F</b>	<b>RR450F</b>	<b>RR330F*</b>	<b>RR350F*</b>
White	<b>RR430FW</b>	<b>RR450FW</b>	—	—
Description	Surface Mount	Surface Mount	Surface Mount	Surface Mount
Rating	30A 125/250V 3 Pole, 4 Wire with Ground	50A 125/250V 3 Pole, 4 Wire with Ground	30A 125/250V 3 Pole, 3 Wire without Ground	50A 125/250V 3 Pole, 3 Wire without Ground
Black	<b>RR430</b>	<b>RR450</b>	<b>RR330*</b>	<b>RR350*</b>
Description	Panel Mount	Panel Mount		
Rating	30A 125/250V 3 Pole, 4 Wire with Ground	50A 125/250V 3 Pole, 4 Wire with Ground		
Black	<b>RR430PM</b>	<b>RR450PM</b>		
White	—	—		

Note: \*For replacement use only.



RR430FW







RR450



RR430PM

**Range and Dryer Power Angled Plugs**

				
Description	With Interchangeable Blades for 30 or 50 Amp		With Interchangeable Blades for 30 or 50 Amp	
Rating	30/50A 125/250V 3 Pole, 4 Wire with Ground		30/50A 125/250V 3 Pole, 3 Wire without Ground	
Black	<b>RR435P</b>		<b>RR335P</b>	



RR435P

**Wallplates, Surface Mount, 2.15" Diameter Single Hole**

Description	1-Gang Standard	1-Gang Mid size	2-Gang Standard	2-Gang Mid size
Ivory	<b>NP724I</b>	<b>NPJ724I</b>	<b>NP703I</b>	<b>NPJ703I</b>
White	<b>NP724W</b>	<b>NPJ724W</b>	<b>NP703W</b>	<b>NPJ703W</b>
Chrome	<b>SCH723</b>	—	—	—
Stainless Steel	<b>SS723</b>	—	<b>SS703</b>	—



NP724W



NP703W



RR151CHW

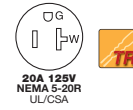
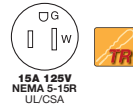

### Special Use Products

Description	Color	Tamper-Resistant	Tamper-Resistant
Clock Hanger/Recessed receptacle, 2 pole, 3 wire, grounding, side wire terminations	Brass	RR151CHBSTR	RR201CHBSTR
	Stainless Steel	RR151CHSSTR	RR201CHSSTR
	Ivory (Nylon)	RR151CHITR	RR201CHITR
	White (Nylon)	RR151CHWTR	RR201CHWTR
JLOAD® Multimedia Outlet Provides power, Cat. 5e and coaxial in a single gang box. Requires RJ600 Box. Includes decorator frame, one Cat. 5e, one F-connector and one power receptacle 125V with voltage dividers.	Black	RJ650BKTR	RJ620BKTR
	Gray	RJ650GYTR	RJ620GYTR
	Ivory	RJ650ITR	RJ620ITR
	Light Almond	RJ650LATR	RJ620LATR
	White	RJ650WTR	RJ620WTR
JLOAD® Multimedia Outlet Includes decorator frame with two open ports for custom configuration and one power receptacle 125V with voltage dividers.	Black	RJ65BKTR	RJ62BKTR
	Gray	RJ65GYTR	RJ62GYTR
	Ivory	RJ65ITR	RJ62ITR
	Light Almond	RJ65LATR	RJ62LATR
	White	RJ65WTR	RJ62WTR
JLOAD® Multimedia Box 3 inches deep with seven ½-inch knockouts, non-metallic sheathed cable clamps on each side. Screw in mounting to stud.	Steel	RJ600	RJ600

Note: See pages X-24 to X-29 for floor boxes and under cabinet power distribution options.  
See page Tech-10 for Tamper-Resistant description.



Dividers

### Door Switch with Cover Plate and Box

Description	"ON" when Door is Open	"OFF" when Door is Open
Rating	3A 125V AC	3A 125V AC
Zinc Plated Steel	RDS50*	RDS30*

Note: \*Not UL Listed.



RJ600

### Dimensions

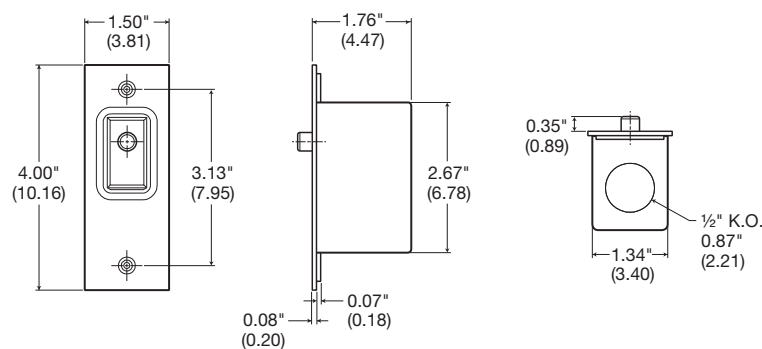

RDS50



RS100W



RS101W

### In-Line Cord Switches

Description	Mini For Use with Flat Lamp Cord	Heavy Duty
Rating	6A 125V AC	6A 125V AC, 1/6 HP
Wire	#18 AWG SPT 1 and SPT 2	#18 to #16 AWG SPT 1 and SPT 2
Ivory	—	RS101I
White	RS100W	RS101W

Dimensions in Inches (mm)

**Rocker Decorator Dimmers, Preset with Night Light**

Description	Side Slide Adjustment, Incandescent	Side Slide Adjustment, Incandescent	Side Slide Adjustment, Incandescent	Side Slide Adjustment, Incandescent
Termination	Single Pole	Three Way	Single Pole	Three Way
Rating	1000W 120V AC	1000W 120V AC	600W 120V AC	600W 120V AC
Ivory	<b>RDV10PI</b>	<b>RDV103PI</b>	<b>RDV600PI</b>	<b>RDV603PI</b>
Light Almond	<b>RDV10PLA</b>	<b>RDV103PLA</b>	<b>RDV600PLA</b>	<b>RDV603PLA</b>
White	<b>RDV10PW</b>	<b>RDV103PW</b>	<b>RDV600PW</b>	<b>RDV603PW</b>



RDV600PW

Description	Magnetic Low Voltage	Magnetic Low Voltage	Electronic Low Voltage	Electronic Low Voltage Requires Neutral
Termination	Single Pole	Three Way	Single Pole	Three Way
Rating	600VA (450W) 120V AC	600VA (450W) 120V AC	300W 120V AC	300W 120V AC
Ivory	<b>RDVLV600PI</b>	<b>RDVLV603PI</b>	<b>RDVELV300PI</b>	<b>RDVELV303PI</b>
Light Almond	<b>RDVLV600PLA</b>	<b>RDVLV603PLA</b>	<b>RDVELV300PLA</b>	<b>RDVELV303PLA</b>
White	<b>RDVLV600PW</b>	<b>RDVLV603PW</b>	<b>RDVELV300PW</b>	<b>RDVELV303PW</b>



RS600PW

**Slide Dimmers, Preset with On/Off Switch**

Description	Incandescent	Incandescent	Incandescent	Incandescent
Termination	Single Pole	Three Way	Single Pole	Three Way
Rating	1000W 120V AC	1000W 120V AC	600W 120V AC	600W 120V AC
Ivory	<b>RS10PI</b>	<b>RS103PI</b>	<b>RS600PI</b>	<b>RS603PI</b>
Light Almond	<b>RS10PLA</b>	<b>RS103PLA</b>	<b>RS600PLA</b>	<b>RS603PLA</b>
White	<b>RS10PW</b>	<b>RS103PW</b>	<b>RS600PW</b>	<b>RS603PW</b>



RS600W

Description	Magnetic Low Voltage	Magnetic Low Voltage	Electronic Low Voltage	Electronic Low Voltage Requires Neutral
Termination	Single Pole	Three Way	Single Pole	Three Way
Rating	600VA (450W) 120V AC	600VA (450W) 120V AC	300W 120V AC	300W 120V AC
Ivory	<b>RSLV600PI</b>	<b>RSLV603PI</b>	<b>RSELV300PI</b>	<b>RSELV303PI</b>
Light Almond	<b>RSLV600PLA</b>	<b>RSLV603PLA</b>	<b>RSELV300PLA</b>	<b>RSELV303PLA</b>
White	<b>RSLV600PW</b>	<b>RSLV603PW</b>	<b>RSELV300PW</b>	<b>RSELV303PW</b>



RS613W

**Slide Dimmers, Slide to Off**

Description	Incandescent Slide to Off	Incandescent Omni Slide Button
Termination	Single Pole	Single Pole/Three Way
Rating	600W 120V AC	600W 120V AC
Ivory	<b>RS600I</b>	<b>RS613PI</b>
Light Almond	<b>RS600LA</b>	<b>RS613PLA</b>
White	<b>RS600W</b>	<b>RS613PW</b>



RS2LFSQW

**Fan Speed Controls, 3 Speed**

Description	Rocker Slide Adjustment	Slide Control Slide to Off	Combination Slide Dimmer, Incandescent
Termination	Single Pole/Three Way	Single Pole	Single Pole
Rating	1.5A 120V AC	1.5A 120V AC	300W 1.5A 120V AC
Ivory	<b>RDVFSQFI</b>	<b>RSFSQFI</b>	<b>RS2LFSQI</b>
Light Almond	<b>RDVFSQFLA</b>	<b>RSFSQFLA</b>	<b>RS2LFSQLA</b>
White	<b>RDVFSQFW</b>	<b>RSFSQFW</b>	<b>RS2LFSQW</b>

**Replacement Knobs**

Knob
—
—
<b>RSKI</b>
<b>RSKLA</b>
<b>RSKW</b>

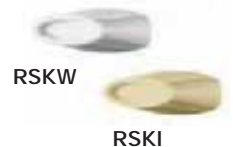

## Features

Standard toggle switches provide the basic on/off control for home lighting and appliances.

- Optimum CFL and LED Control
- Low End Adjustment for Fine Tuning
- Decorator and Traditional Toggle Styling Available
- No Neutral Required

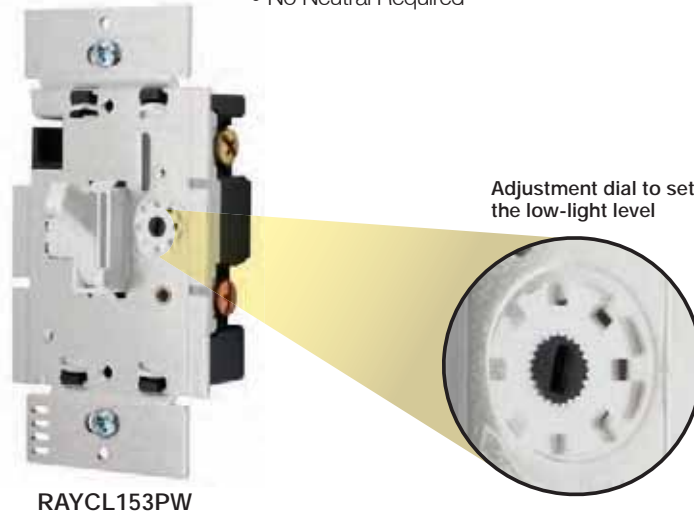

RAYCL153PW



RDVCL153PW



RAY600PW



RFSQ2FDK



R28032401

R28032406

### CFL/LED Dimmers

Description	Decorator Dimmer	Toggle Dimmer
Rating	CFL/LED 150W Incandescent/ Halogen 600W 120V, 60Hz	CFL/LED 150W Incandescent/ Halogen 600W 120V, 60Hz
Termination	Single Pole/Three Way	Single Pole/Three Way
Ivory	RDVCL153PI	RAYCL153PI
Light Almond	RDVCL153PLA	RAYCL153PLA
White	RDVCL153PW	RAYCL153PW

### Toggle Incandescent Preset Dimmers

Description	Side Slide Adjustment with Wire Leads	Side Slide Adjustment with Wire Leads	Side Slide Adjustment with Terminal Screws	Side Slide Adjustment with Terminal Screws
Termination	Single Pole	Three Way	Single Pole	Three Way
Rating	1000W 120V AC	1000W 120V AC	600W 120V AC	600W 120V AC
Ivory	RAY10PI	RAY103PI	RAY600PI	RAY603PI
Light Almond	RAY10PLA	RAY103PLA	RAY600PLA	RAY603PLA
White	RAY10PW	RAY103PW	RAY600PW	RAY603PW

### Rotary Incandescent Dimmers and Replacement Knobs

Description	On/Off Dimmer	Push On/Off Dimmer Ivory and White Knobs Provided	Push On/Off Dimmer Ivory and White Knobs Provided	Replacement Knobs 2 Piece Kit
Termination	Single Pole	Single Pole	Three Way	—
Rating	600W 120V AC	600W 120V AC	600W 120V AC	—
Ivory	RD600RI	—	—	—
Light Almond	RD600RW	—	—	—
White	—	RD600PDK	RD603PDK	RRKDK

### Fan Speed Controls

Description	Toggle 3-Speed	Combination Toggle 3-Speed/Dimmer	Rotary On/Off 3-Speed Ivory and White Knobs Provided	Rotary Variable Speed	Knobs Rotary Fan Control Replacement Knobs
Termination	Single Pole or Three Way	Single Pole	Single Pole	Single Pole	—
Rating	1.5A 120V AC	300W 1.5A 120V AC	1.5A 120V AC	5A 120V AC	—
Ivory	RAYFSQFI	RAY2LFSQI	—	RFS5I	R28032406
Light Almond	RAYFSQFLA	RAY2LFSQLA	—	RFS5LA	—
White	RAYFSQFW	RAY2LFSQW	—	—	R28032401
Ivory/White	—	—	RFSQ2FDK	RFS5W	—



### Passive Infrared Wall Switches

- Passive infrared technology
- Manual adjustment time delay (20 sec. to 30 min.)
- Photocell (WS2000xx)
- Wallplate included
- No neutral required
- cULus, CEC Title 24 Certified

Description	Color	w/ Neutral	w/ Nightlight and Neutral	Standard	w/ Nightlight
Manual adjusting; selectable manual/auto-on operation; dual-voltage 120/277V; 3-way capable.	Gray	—	—	WS2000GY	WS2000NGY
	Ivory	WS2004I	WS2004NI	WS2000I	WS2000NI
	Light Almond	—	—	WS2000LA	WS2000NLA
	White	WS2004W	WS2004NW	WS2000W	WS2000NW
Manual adjusting; auto-on operation; 120V AC only.	Ivory	—	—	WS1000I	WS1000NI
	White	—	—	WS1000W	WS1000NW
Manual adjusting; Manual-on operation; 120V AC only.	Ivory	—	—	WS1001I	WS1001NI
	White	—	—	WS1001W	WS1001NW



WS2000W



WS1000W

### Dimming Control Sensors

Description	Color	Standard	w/ Nightlight
Occupancy sensor, 500W 120V AC, 150° view, single pole switch, incandescent only.	Ivory	RMS121I	RMS121ILI
	Light Almond	RMS121LA	RMS121ILLA
	White	RMS121W	RMS121ILW
Vacancy sensor, 500W 120V AC, 150° view, single pole switch, incandescent only.	Ivory	RMS120I	RMS120ILI
	Light Almond	RMS120LA	RMS120ILLA
	White	RMS120W	RMS120ILW



RMS121ILW  
RMS120ILW

### Digital Timer Wall Switch

Description	Color	120V AC	277V AC	Catalog Number
Dip switch enabled preset intervals. User adjustable up to 4 hours, 3-way capable. Includes an on/off momentary push button switch feature.	White	960W	1200W	DT2000W



DT2000W

### Coverage for Occupancy and Vacancy Sensors

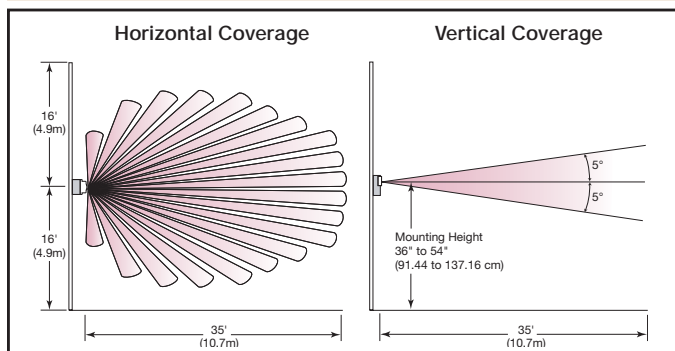

### Coverage for Heavy Duty Occupancy and Vacancy Sensors

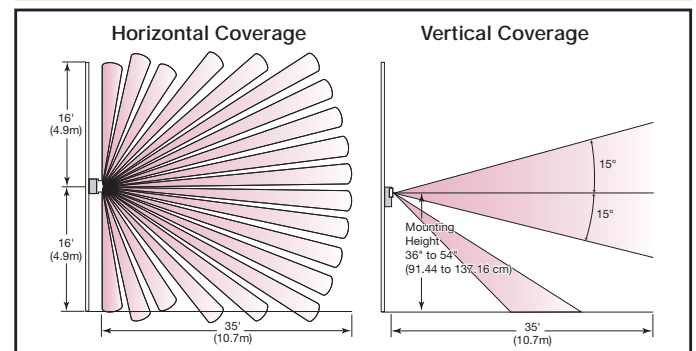



Hubbell Wood Floor Boxes allow for the placement of electrical power or a combination of power and voice/data devices. Specifically designed for use with structural wood floors. The boxes are height adjustable (up to 3/4 inch) for optimal alignment and fit.



Note: Template cutout provided with instructions for proper installation.

The Right Choice for that Perfect Finishing Touch!

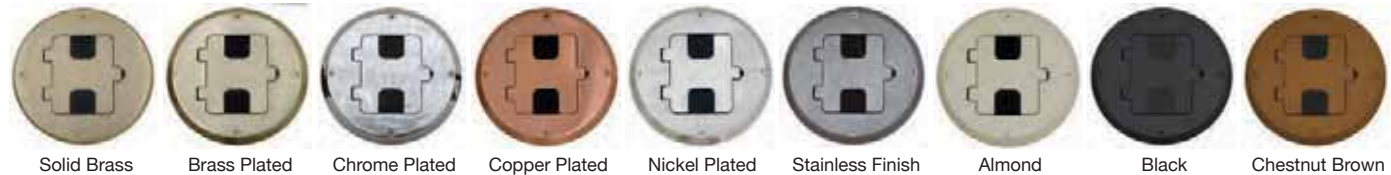

Note: Not all configurations are available in all colors. See below for details.



RF515BR



RF509BR



RF500



RF507BR

Floor Boxes for Structural Wood Floors

Description	Material	Finish	Catalog No.	Material	Finish	Catalog No.
Decorator duplex receptacle floor box kit; includes steel box, flange and hinged door cover assembly with 15A 125V tamper-resistant duplex receptacle; designed for installation in wood floors; mounts to sub-floor or joists.	Solid Brass	Clear Lacquer	<b>RF515BR</b>	Aluminum	Brass Plated	<b>RF515BP</b>
	Aluminum	Stainless Paint	<b>RF515SS</b>	Aluminum	Chrome Plated	<b>RF515CH</b>
	Aluminum	Almond Paint	<b>RF515AL</b>	Aluminum	Copper Plated	<b>RF515CU</b>
	Aluminum	Black Paint	<b>RF515BK</b>	Aluminum	Nickel Plated	<b>RF515NI</b>
	Aluminum	Chestnut Brown Paint	<b>RF515BN</b>			
Flange and hinged door cover assembly; includes tamper-resistant duplex receptacle; neoprene gaskets; for use with steel box RF500.	Solid Brass	Clear Lacquer	<b>RF506BR</b>	Aluminum	Brass Plated	<b>RF506BP</b>
	Aluminum	Stainless Paint	<b>RF506SS</b>	Aluminum	Chrome Plated	<b>RF506CH</b>
	Aluminum	Almond Paint	<b>RF506AL</b>	Aluminum	Copper Plated	<b>RF506CU</b>
	Aluminum	Black Paint	<b>RF506BK</b>	Aluminum	Nickel Plated	<b>RF506NI</b>
	Aluminum	Chestnut Brown Paint	<b>RF506BN</b>			
Flush fit cover for hardwood and tile floors (similar to above).	Solid Brass	Clear Lacquer	<b>RF509BR</b>			
Adjustable floor box; 3 inch deep; three (3) 1/2 inch knockouts: one on bottom; one on each side; non-metallic sheathed cable clamps on each side.				Steel	—	<b>RF500</b>
Hinged Door Cover Only Replacement door for RF515, RF509 and RF506 series.	Solid Brass	Solid Brass	<b>RF507BR</b>	Aluminum	Brass Plated	<b>RF507BP</b>
	Aluminum	Stainless Finish	<b>RF507SS</b>	Aluminum	Chrome Plated	<b>RF507CH</b>
	Aluminum	Almond	<b>RF507AL</b>	Aluminum	Copper Plated	<b>RF507CU</b>
	Aluminum	Black	<b>RF507BK</b>	Aluminum	Nickel Plated	<b>RF507NI</b>
	Aluminum	Chestnut Brown Paint	<b>RF507BN</b>			

### Features

Duplex floor receptacles provide ample connections to service lighting, entertainment equipment and computers for family rooms and offices. Single receptacle configurations available for minimum requirements.

- Solid brass covers
- Cut out template provided to assure proper sub-flooring preparation

### Drop-In Floor Box

Drop-In Floor Boxes are perfect for quick and easy installation of power or low voltage. Simply cut a hole between the floor and joists and drop through. The flange lip holds it in place.

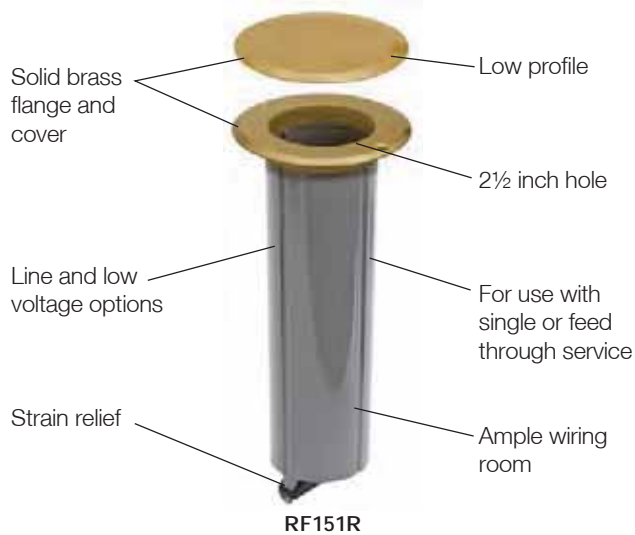

### Floor Boxes for Wood Floors

Description	Material	Catalog Number	Catalog Number
Drop In Floor Box Mounts in 2½ inch hole opening. Includes solid brass cover, single tamper-resistant receptacle, optional device mounts for two (2) voice/data video ports. Suitable for feed through circuitry. Impact resistant box.	Solid Brass	<b>RF151R</b>	<b>RF201R</b>
Duplex Receptacle Floor Box Rated Includes steel box, duplex TR receptacle and cover.	Solid Brass	<b>RF6500BR</b>	—
Single Receptacle Floor Box Rated Includes steel box, single receptacle and cover.	Solid Brass	<b>RF151TR</b>	—
Single Receptacle Display Rated Receptacle and cover only, excludes box.	Solid Brass	<b>RF151DTR</b>	—



Note: See page Tech-10 for Tamper-Resistant description.

### Dimensions

#### Wood Floor Boxes

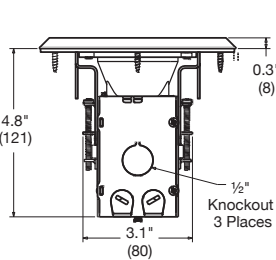
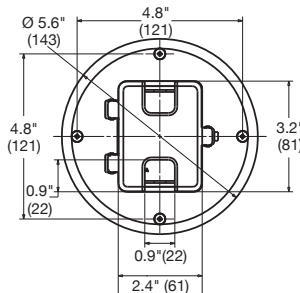

#### Drop-In Floor Box

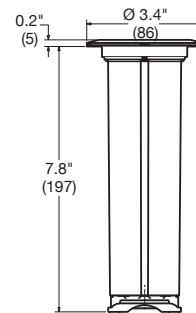
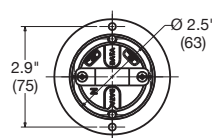

Dimensions in Inches (mm)

tradeSELECT® Products  
**Floor Boxes for Concrete Floors**

Power Delivery



Residential Round Non-Metallic Floor Box offers an economical solution for electrical power or a combination of power and voice/data applications. Designed specifically for slab-on-grade installation. Quick and easy installation is assured using a push in place leveling system. UL Listed E92074.



# tradeSELECT® Products Floor Boxes for Concrete Floors

Power Delivery



## Features

After the box has been secured in concrete, cut for height, apply PVC glue and push the cover assembly into the box. No fasteners or adjustment screws required.

- 4 inch minimum concrete pour
- Recessed GFCI/Decorator opening
- Self height and leveling ring, no adjustments
- TR receptacle included
- UL Listed E92074 Floor Box

## Floor Boxes for Concrete Floors

Description	Rating	Material/Color	Catalog Number
Flange and Hinged Door Cover Assembly Includes duplex receptacle, gasket, floor leveling PVC ring, high impact and chemically resistant nylon. Factory pre-assembled for easy drop-in installation.	15A 125V NEMA 5-15R	Solid Brass	<b>RF406BR</b>
		Almond	<b>RF406AL</b>
		Black	<b>RF406BK</b>
		Gray	<b>RF406GY</b>
		Chestnut Brown	<b>RF406BN</b>
Flush fit cover for hardwood and tile floors (similar to above).		Solid Brass	<b>RF409BR</b>
PVC Floor Box with Concrete Protective Cover Accepts ¾ in. and 1.0 in. schedule 40 and schedule 80 PVC conduit. Includes round box (47/8 in. diameter x 6.0 in. deep), four reducers, closure plugs, and concrete cover with locator flag.		Gray	<b>RF400</b>
Hinged Nylon Replacement Door Cover Includes neoprene gasket to seal plug openings. Replacement cover for RF406 series.		Solid Brass	<b>RF407BR</b>
		Almond Black	<b>RF407AL</b> <b>RF407BK</b>
Low Voltage Divider For use in PVC box RF400, when JLOAD® Multimedia Outlet is used.		Gray	<b>RF408</b>



RF406BK



RF409BR



RF400



RF408



RJ650BK



## JLOAD® Multimedia Outlet

Description	Color	Tamper-Resistant	Tamper-Resistant
JLOAD® Multimedia Outlet Specifically designed to provide power, Cat. 5e and coaxial in a single gang box. Requires Low Voltage Divider RF408 when used in PVC Box RF400. Perfect for HDTV and computer use where a combination of power and data are needed. Includes decorator frame, one Cat. 5e, one F-connector and one power receptacle 125V with voltage dividers.	Black	<b>RJ650BKTR</b>	<b>RJ620BKTR</b>
	Gray	<b>RJ650GYTR</b>	<b>RJ620GYTR</b>
	Ivory	<b>RJ650ITR</b>	<b>RJ620ITR</b>
	Light Almond	<b>RJ650LATR</b>	<b>RJ620LATR</b>
	White	<b>RJ650WTR</b>	<b>RJ620WTR</b>
JLOAD® Multimedia Outlet Includes decorator frame with two open ports for custom configuration and one power receptacle 125V with voltage dividers.	Black	<b>RJ65BKTR</b>	<b>RJ62BKTR</b>
	Gray	<b>RJ65GYTR</b>	<b>RJ62GYTR</b>
	Ivory	<b>RJ65ITR</b>	<b>RJ62ITR</b>
	Light Almond	<b>RJ65LATR</b>	<b>RJ62LATR</b>
	White	<b>RJ65WTR</b>	<b>RJ62WTR</b>

Note: See page Tech-10 for Tamper-Resistant description.



**Features**

These boxes comply with the NEC® for kitchen receptacles, with placement not more than 20 inches above the counter surface. They can also be placed under counter islands, not lower than 15 inches from the surface.

- Available with nylon or metal cover
- Custom configurable, accepts any decorator style device
- Mounting hardware included
- UL Listed E31999 and CSA Certified under cabinet boxes



RU100W



RU200SS

**Under Cabinet/Counter Power Distribution**

Description	Material	Catalog Number
Slim Box	Stainless Steel	RU100SS
	White Metal	RU100W
	White Nylon	RU170W*
GFCI Fit Box	Stainless Steel	RU200SS
	White Metal	RU200W
	White Nylon	RU270W*

*Note: \*Steel box with nylon cover.*

**Dimensions**

**Slim Box**

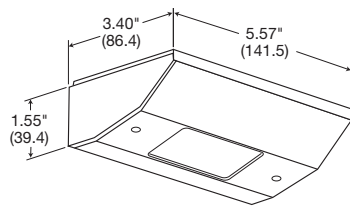

**GFCI Fit Box**

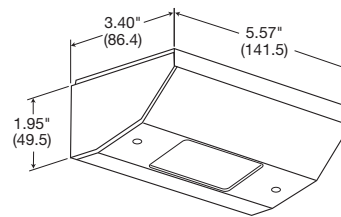

**Vertical Mount**

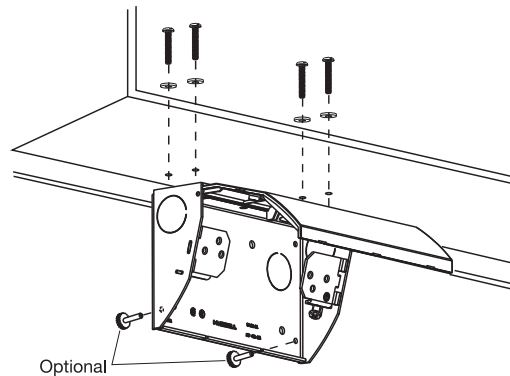

**Horizontal Mount**

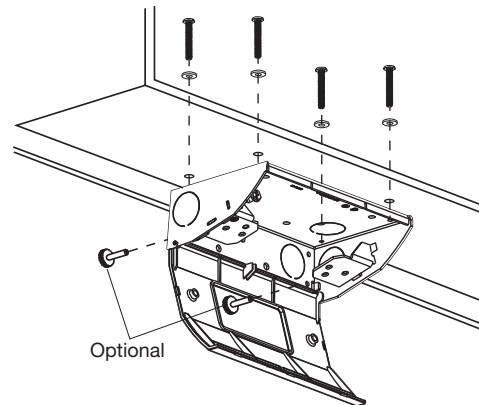

*NEC® is a registered trademark of the National Fire Protection Association (NFPA).*

**Make the Most of a Perfect Location**

Install receptacles and voice/data devices exactly where they are needed, in the smallest space possible.

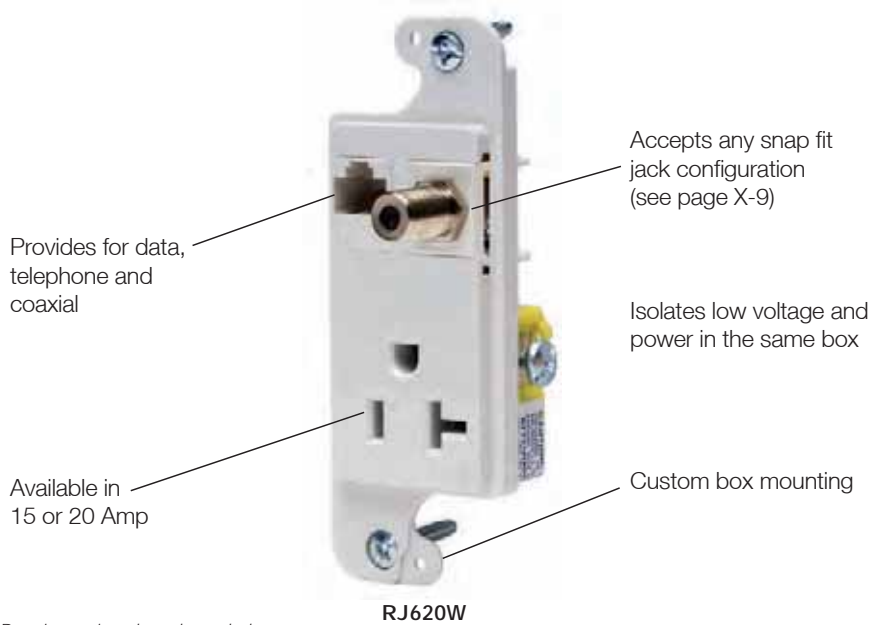

Note: Requires unique box shown below.



**Special Use Products**

Description	Color	Tamper-Resistant	Tamper-Resistant
JLOAD® Multimedia Outlet Specifically designed to provide power, Cat. 5e and coaxial in a single gang box. Requires JLOAD® Multimedia Box RJ600. Perfect for HDTV and computer use where a combination of power and data are needed. Includes decorator frame, one Cat. 5e, one F-connector and one power receptacle 125V with voltage dividers.	Black	<b>RJ650BKTR</b>	<b>RJ620BKTR</b>
	Gray	<b>RJ650GYTR</b>	<b>RJ620GYTR</b>
	Ivory	<b>RJ650ITR</b>	<b>RJ620ITR</b>
	Light Almond	<b>RJ650LATR</b>	<b>RJ620LATR</b>
	White	<b>RJ650WTR</b>	<b>RJ620WTR</b>
JLOAD® Multimedia Outlet Includes decorator frame with two open ports for custom configuration and one power receptacle 125V with voltage dividers.	Black	<b>RJ65BKTR</b>	<b>RJ62BKTR</b>
	Gray	<b>RJ65GYTR</b>	<b>RJ62GYTR</b>
	Ivory	<b>RJ65ITR</b>	<b>RJ62ITR</b>
	Light Almond	<b>RJ65LATR</b>	<b>RJ62LATR</b>
	White	<b>RJ65WTR</b>	<b>RJ62WTR</b>
JLOAD® Multimedia Box 3 inches deep with seven 1/2-inch knockouts, non-metallic sheathed cable clamps on each side. Screw in mounting to stud.	Steel	<b>RJ600</b>	<b>RJ600</b>

Note: See page Tech-10 for Tamper-Resistant description.

**Dimensions**

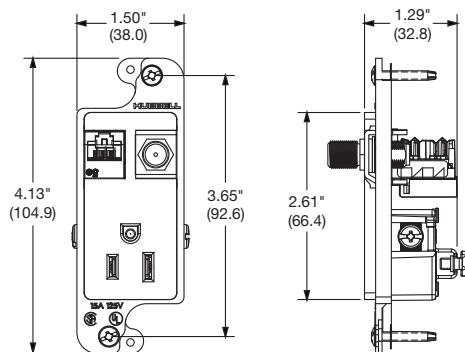

# tradeSELECT® Products Decorator Switches

technical information

## Features

- Smooth, quiet rocker action
- Self-grounding feature standard
- Ultrasonically welded cover and base provides maximum strength
- Push, back and side wiring
- Available colors: Black, Brown, Gray, Ivory, Light Almond and White



RSD115W

## Specifications

Switches	Component	Material
Typical Specification — Catalog Number RSD115xx	Base and body	PVC
Description — Decorator series rocker switch	Rocker	Polycarbonate
Type — Single Pole	Terminals	Brass
Rating — 15A, 120-277V AC	Mounting strap	Galvanized steel
Certification — Listed to UL Standard 20	Contacts	Silver alloy
CSA Certified	Movable contact arm	Copper alloy
	Terminal screws	Steel

Note: **xx** = Color: **BK** (Black), **Blank** (Brown), **GY** (Gray), **I** (Ivory), **LA** (Light Almond), and **W** (White).

## Performance

Electrical	
Dielectric voltage	Withstands 1,500V AC minimum for 1 minute.
Max. working voltage	120V.
Overload	1.5 times rating.
Endurance	30,000 cycles minimum.
Mechanical	
Terminal accommodation	Back and side wire: #14 AWG min. - #12 AWG max. solid and stranded copper wire only; push wire: #14 AWG solid copper wire only.
Environmental	
Flammability	UL V0.
Operating temperatures	Maximum continuous 60°C; minimum -20°C (without impact).

## Dimensions

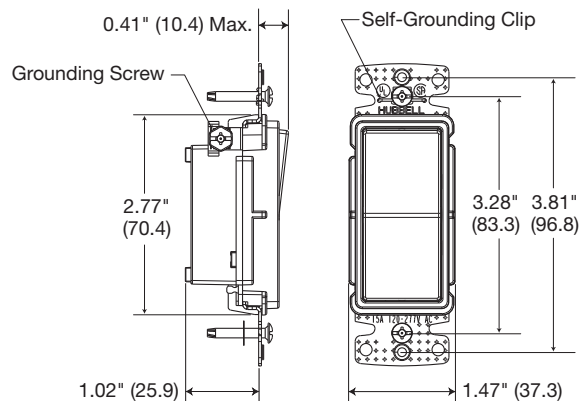

Single-Pole Decorator Switch



# Section Y Marine Products

## Index

Product	Page
Ship-to-Shore Selection Guide .....	Y-2
ELCI Interface Solutions.....	Y-4
<b>Ship-to-Shore Cable Sets and Devices</b>	
30A Twist-Lock®.....	Y-7
50A Twist-Lock®.....	Y-12
100A Pin and Sleeve.....	Y-17
200A Pin and Sleeve.....	Y-22
Internationally Rated Pin and Sleeve Devices .....	Y-24
Internationally Rated Twist-Lock® Devices .....	Y-25
Adapters.....	Y-26
Telephone and Cable TV Devices.....	Y-30
30A, 28V DC Rated .....	Y-32
12V DC Rated Switches .....	Y-33
15A Twist-Lock® and Straight Blade Devices.....	Y-34
20A Twist-Lock® and Straight Blade Devices.....	Y-36
Ground Fault Devices .....	Y-38
<b>Inside the Boat</b>	
Receptacles .....	Y-40
Switches and Weatherproof Switch Plates.....	Y-41
Wallplates .....	Y-42
Communication Frames and Connectors.....	Y-43
<b>Boatyard Accessory Items</b>	
Marine Grade Outlet Box Hoods .....	Y-44
Marine Grade Lift Covers .....	Y-45
Marine Grade Dockside Boxes and Covers .....	Y-46
Lighting and Lighting Fixtures.....	Y-47
<b>Electrical Standards</b>	
Codes and Specifications.....	Y-48

30 Amp Cable Set



50 Amp Cable Set



100 Amp Cable Sets  
and Devices



Twist-Lock® Devices



# Marine Products Ship-to-Shore Selection Chart - Boatside

30A  
125V AC  
2 Pole  
3 Wire

Pages Y-7 to Y-11



HBL303NM



HBL303SS



HBL26CM13



HBL60CM33  
HBL60CM33W

50A  
125V AC  
2 Pole  
3 Wire

Pages Y-12, Y-13, Y-16



HBL503NM



HBL503SS



HBL63CM60



HBL77CM15  
HBL77CM15W

50A  
125/250V AC  
3 Pole  
4 Wire

Pages Y-14 to Y-16



HBL504NM



HBL504SS



HBL63CM64



HBL77CM15  
HBL77CM15W

100A  
125/250V AC  
3 Pole  
4 Wire

Pages Y-17 to Y-19



M4100B12R



M4100C12R

100A  
3ØY  
4 Pole  
5 Wire

Pages Y-17, Y-20, Y-21  
120/208V AC  
277/480V AC



M5100B9R  
M5100B7R



M5100C9R  
M5100C7R

200A  
600V AC/250V DC  
50-400 Hertz  
4 Pole  
5 Wire

Pages Y-22, Y-23



M5200BS1R



M5200CS1R

Portable  
Telephone  
Cable TV  
Devices

Pages Y-30, Y-31



HBLPHTVM



HBLPHTVSS



HBLTVSS



PH6624



PH7440

# Marine Products Ship-to-Shore Selection Chart - Dockside



YC310250 - 280' (85.3m) Yellow cable only.  
YC310280 - 280' (85.3m) White cable only.

- HBL61CM08 & HBL61CM08LED - 50' (15.2m)
- HBL61CM05 & HBL61CM05LED - 35' (10.7m)
- HBL61CM03 & HBL61CM03LED - 25' (7.6m)
- HBL61CM08W & HBL61CM08WLED - 50' (15.2m)
- HBL61CM03W & HBL61CM03WLED - 25' (7.6m)



HBL60CM31  
HBL60CM31W



HBL26CM11



HBL26CM10



HBL74CM25WOA  
HBL74CM25WOAW



YC306250 - 250' (76.2m) Yellow cable only.

- HBL61CM53 & HBL61CM53LED - 50' (15.2m)
- HBL61CM53W & HBL61CM53WLED - 50' (15.2m)
- HBL61CM43 & HBL61CM43LED - 25' (7.6m)



HBL77CM16  
HBL77CM16W



HBL63CM61



HBL63CM70



HBL77CM74WO



YC406250 - 250' (76.2m) Yellow cable only.

- HBL61CM52 & HBL61CM52LED - 50' (15.2m)
- HBL61CM42 & HBL61CM42LED - 25' (7.6m)
- HBL61CM52W & HBL61CM52WLED - 50' (15.2m)
- HBL61CM42W & HBL61CM42WLED - 25' (7.6m)



HBL77CM16  
HBL77CM16W



HBL63CM65



HBL63CM69



HBL77CM74WO



CS1004 - 100' (30.4m) 4-Wire  
CS754 - 75' (22.8m) 4-Wire  
CS100IT4 - 100' (30.4m) 3-Wire  
CS754IT4 - 75' (22.8m) 3-Wire

- CW125IT4 - 125' (38.0m) One-ended cable set for winches.
- CW100IT4 - 100' (30.4m) One-ended cable set for winches.
- CW754 - 75' (22.8m) One-ended cable set for winches.
- CS50EXT4 - 50' (15.2m) Extension cord.



M4100P12



M4100C12



M4100R12



CS100IT5 - 100' (30.4m) 4-Wire  
CS75IT5 - 75' (22.8m) 4-Wire

- CW125IT5 - 125' (38.0m) One-ended cable set for winches.
- CW100IT5 - 100' (30.4m) One-ended cable set for winches.
- CS50EXT5 - 50' (15.2m) Extension cord.



M5100P9  
M5100P7



M5100C9  
M5100C7



M5100R9  
M5100R7



M5200PS1



M5200CS1



M5200RS1



PH6630 - 250' (76.2m) Yellow cable only.  
PH6599 - 50' (15.2m)  
PH6598 - 25' (7.6m)  
PH6599W - 50' (15.2m)  
PH6598W - 25' (7.6m)

75 Ohm TV Cable.  
TV99 - 50' (15.2m)  
TV98 - 25' (7.6m)  
TV99W - 50' (15.2m)  
TV98W - 25' (7.6m)



PH7440



PH6625



PH6596



TV97



PH6597TV

## Marine Products

# ELCI Interface Solutions

30 Amp and 50 Amp

### ABYC Code Requirements

Hubbell Marine Electrical continues its tradition of innovation by developing a simple, flexible method of adapting a variety of ELCI Sensors and Breakers to our traditional Stainless Steel and Non-Metallic Shore Power Inlet Housings.

Effective July 31, 2012, ABYC, E-11.11.1. requires that "An Equipment Leakage Circuit Interrupter (ELCI) shall be installed with or in addition to the main shore power disconnect circuit breaker(s) or at the additional over current protection as required by E-11.10.2.8.3, whichever is closer to the shore power connection".

*Hubbell's family of ELCI adaptive Shore Power Inlet Kits provide a simple, flexible, low-cost solution.*

#### Kits Contain:

- Hubbell Shore Power Inlet
- Matching Shore Power Inlet Housing(s)
- Mounting Adapter Plate(s) for use with various ELCI Sensors and ELCI Breakers (not provided)
- Stainless Steel Hardware



An Equipment Leakage Circuit Interrupter (ELCI) provides 30mA ground fault protection for the entire AC shore power system beyond the ELCI



Marine Products  
**ELCI Interface Solutions**  
*30 Amp and 50 Amp*

**Hubbell ELCI Adapter Kits for North Shore Safety, Ltd® PGFM Series (ELCI Marine) Sensing Module and Sensata Technologies® ELCI Breakers**

Description	Breaker	Sensor	Power Inlet	Catalog Number
30 Amp, 125 Volt Non-Metallic Inlet (HBL303NM) and (2) Non-Metallic Inlet Housings, Adapter Plates and Hardware.				<b>HBL303NMELCI</b>
30 Amp, 125 Volt Non-Metallic Inlet (HBL303NM) and (1) Non-Metallic Inlet Housing that adapts to North Shore Safety's Sensor only (no circuit breaker inlet housing), Adapter Plate and Hardware.				<b>HBL303NMELCIS</b>
30 Amp, 125 Volt Stainless Steel Inlet (HBL303SS) and (2) Stainless Steel Inlet Housings, Adapter Plates and Hardware.				<b>HBL303SSELCI</b>
30 Amp, 125 Volt Stainless Steel Inlet (HBL303SS) and (1) Stainless Steel Inlet Housing that adapts to North Shore Safety's Sensor only (no circuit breaker inlet housing), Adapter Plate and Hardware.				<b>HBL303SSELCIS</b>
50 Amp, 125/250 Volt Stainless Steel Inlet (HBL504SS) and (2) Stainless Steel Inlet Housings, Adapter Plates and Hardware.				<b>HBL504SSELCI</b>
50 Amp, 125/250 Volt Stainless Steel Inlet (HBL504SS) and (2) Stainless Steel Inlet Housing that adapts to a standard overcurrent-type circuit breaker.				<b>HBL504SSELCIH</b>
Blank Non-Metallic Inlet Housing and Hardware for mounting North Shore Safety ELCI Sensor only.				<b>HBLRRELCI</b>

*Note: North Shore Safety's Sensor and Sensata Technologies Circuit Breakers (not provided) are separate devices each requiring their own blank shore power inlet interface.*

Marine Products  
**30 Ampere, 125 Volt Cable Set**  
*Features and Benefits*

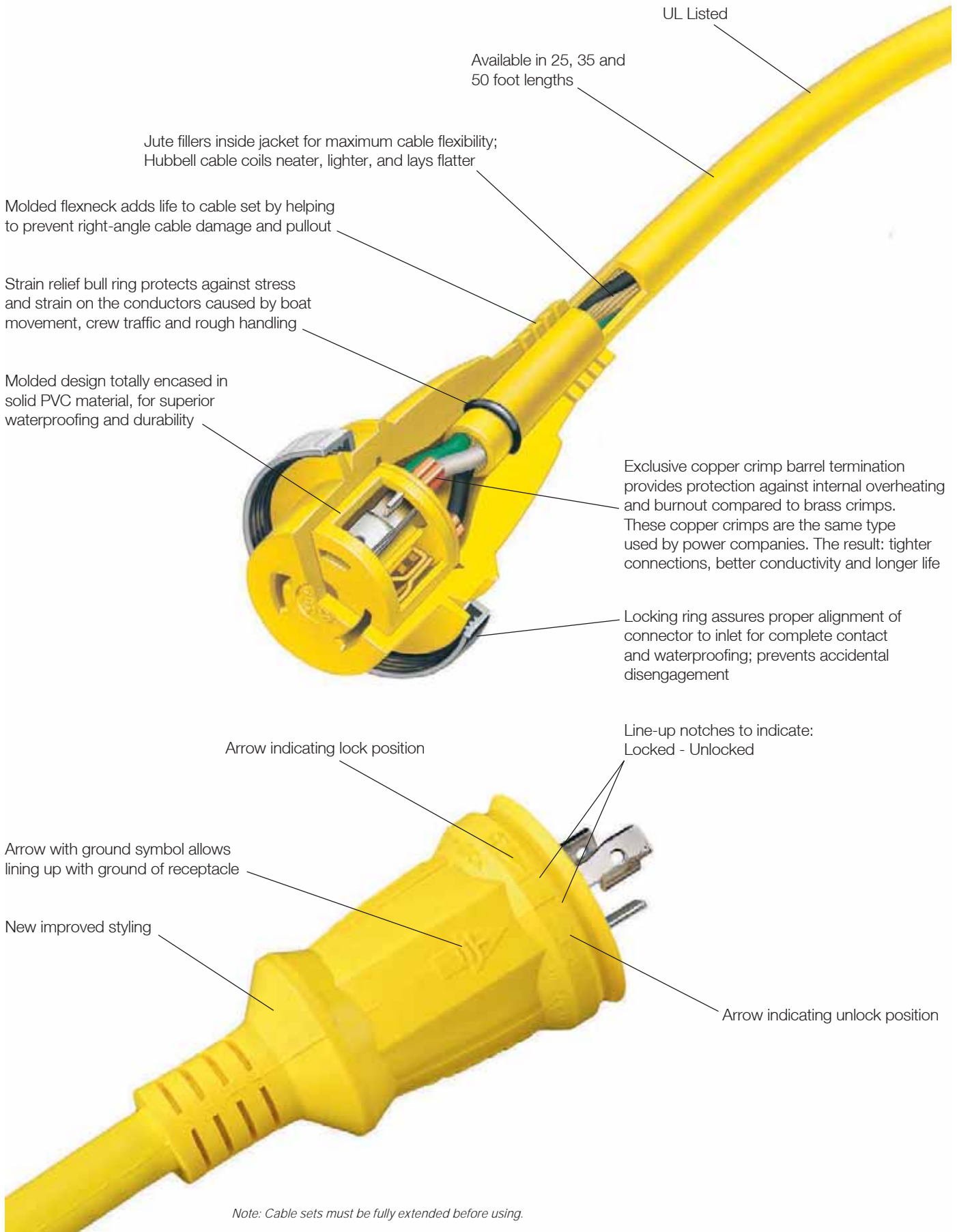

## Ship-to-Shore Devices



### 30A 125V Ship-to-Shore Devices

Description	Catalog Number
Stylized UV resistant non-metallic shore power inlet has white Centrex cover which makes unit weatherproof when completely closed. Interior has easy-to-wire terminations and is transparent for quick and easy visual inspection. Mounting holes are 2.38 in. (60.3) on centers and match existing mounting patterns. Mounting screws and gasket included. Protective rear enclosure/strain relief also included. <b>IP55 SUITABILITY</b>	<b>HBL303NM</b>
Traditional, stainless steel shore power inlet has new easy-to-wire terminations. Interior is transparent for quick and easy visual inspection. Interior is shielded from the elements by a gasketed, self-closing cover, watertight when cover is screwed in place. Mounting holes are 2.38 in. (60.3) on centers. Mounting screws and gasket included. Protective rear enclosure/strain relief also included. <b>IP56 SUITABILITY</b>	<b>HBL303SS</b>
Traditional stainless steel inlet housing; blank for attaching a circuit breaker (not included). Mounting hardware for Carling series breakers included. <b>IP56 SUITABILITY</b>	<b>HBLCBISS</b>
Stylized non-metallic inlet housing; blank for attaching a circuit breaker (not included). Mounting hardware for Carling series breakers included. <b>IP55 SUITABILITY</b>	<b>HBLCBINM</b>
Protective rear cover. Fits all 30A shore power inlets. Secures to back of inlets with three screws which are provided.	<b>SR3050*</b>
Replacement interior for HBL303SS and 60CM61 shore power inlets.	<b>HBL303INT</b>
Traditional Stainless steel power outlet has gasketed, self-closing cover, watertight when cover is screwed in place. Mounting holes are 2.38 in. (60.3) on centers. Mounting screws and gasket included. <b>IP56 SUITABILITY</b>	<b>HBL303SSO</b>
Nickel plated brass adapter plate for mounting 30A traditional style shore power inlets and outlets to FS/FD box.	<b>HBL60CM75</b>

Note: \*Not UL/CSA.



HBL303NM



HBL303SS



HBLCBISS



HBLCBINM



HBL303SSO

### 30A 125V Traditional Stainless Steel Inlets

Base and cover are #316 type stainless steel for strength and corrosion resistance.

Self-closing cover assures the interior is shielded from the elements when the inlet is not in use.

Neoprene gasket on underside of cover. For sealing when the cover is closed.

Contact blades are nickel plated brass for corrosion resistance.

New, easy-to-wire interior is transparent for quick, visual inspection of terminations and high-heat resistance.

Threaded base for making a watertight seal. When in use, it mates to the threaded ring of the weatherproof cover on the connector body. When not in use, it mates to the threaded cover.

Mounting holes are 2 3/8 in. (60.3) on center.

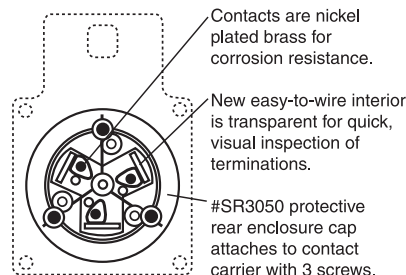

Marine Products  
**30 Ampere, 125 Volt AC Cable Sets and Bulk Cable**  
*2 Pole, 3 Wire*  
 Ship-to-Shore Devices

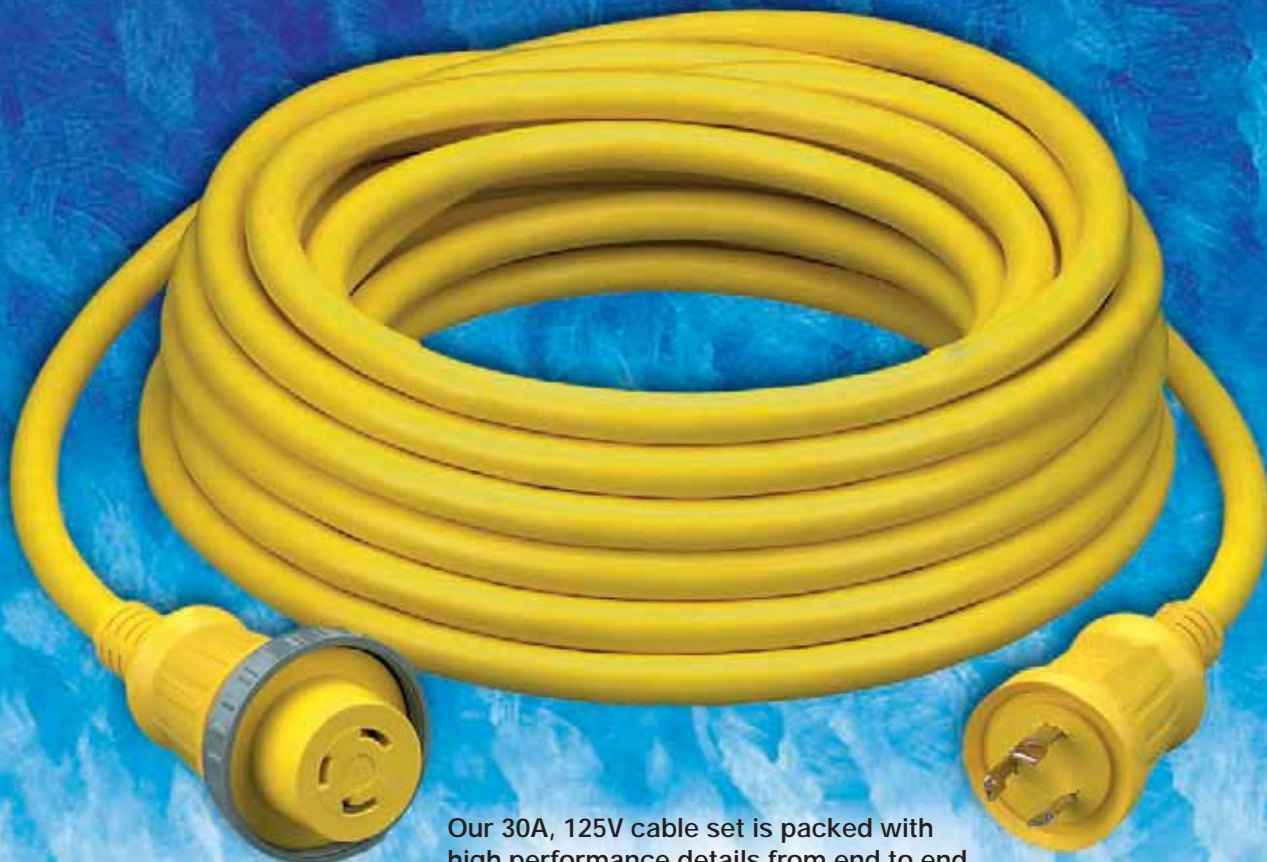

Our 30A, 125V cable set is packed with high performance details from end to end that make a real difference. Completely factory pre-wired with molded-on devices. **Designed to coil easily and lie flat.**



HBL61CM08



(Cable Sets)



**30A 125V Shore Power Cable Set**

Description	Catalog Number
Yellow 50 ft. (15.2m) vinyl jacketed shore power cable set. #10 AWG is factory pre-wired with molded-on devices. Connector end has non-metallic threaded sealing ring which makes inlet/connector interface watertight.	<b>HBL61CM08</b>
Same as HBL61CM08 except 35 ft. (10.7m) in length.	<b>HBL61CM05</b>
Same as HBL61CM08 except 25 ft. (7.6m) in length.	<b>HBL61CM03</b>
Same as HBL61CM08 except in white.	<b>HBL61CM08W</b>
Same as HBL61CM03 except in white.	<b>HBL61CM03W</b>
Yellow 250 ft. (76.2m) three conductor, #10 AWG type STW, PVC jacketed portable cord with jute fillers for added flexibility. Ideal for making cable sets, extension cord, and adapters that will not mark boat's deck. 250 ft. (76.2m) lengths only.	<b>YC310250</b>
White 280 ft. (85.3m) three conductor, #10 AWG type STW, PVC jacketed portable cord with jute fillers for added flexibility. Ideal for making cable sets, extension cord, and adapters that will not mark boat's deck. 280 ft. (85.3m) lengths only.	<b>WC310280</b>
Replacement non-metallic sealing ring for 30A cable sets and boots. Not UL Listed.	<b>RPL30P</b>



YC310250



Marine Products  
**30 Ampere, Cable Set with High Intensity LED "Power-On" Indicator**  
 Ship-to-Shore Cable Sets



- Bright, durable, LED (green) indicates "power-on".
- High intensity LED is visible—even in bright sunlight.
- Totally molded design for superior waterproofing and durability.
- Exclusive copper crimp barrel terminations for tighter connections and longer life.

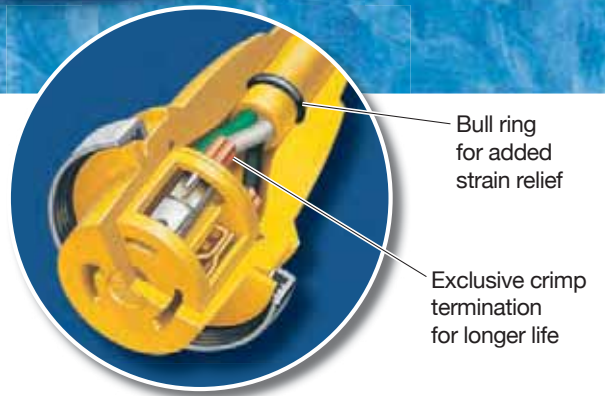

**IP55**  
 SUITABILITY  
 (Boatside)



**30A Shore Power Cable Set with LED "Power-On" Indicator**

Description	Catalog Number
Yellow 50 ft. (15.2m) vinyl jacketed shore power cable set. #10 AWG is factory pre-wired with molded-on devices. Connector end has non-metallic threaded sealing ring which makes inlet/connector interface watertight.	<b>HBL61CM08LED</b>
Same as HBL61CM08LED except 35 ft. (10.7m) in length.	<b>HBL61CM05LED</b>
Same as HBL61CM08LED except 25 ft. (7.6m) in length.	<b>HBL61CM03LED</b>
Same as HBL61CM08LED except in white.	<b>HBL61CM08WLED</b>
Same as HBL61CM05LED except in white.	<b>HBL61CM05WLED</b>
Same as HBL61CM03LED except in white.	<b>HBL61CM03WLED</b>
Replacement non-metallic sealing ring for 30A cable sets and boots. Not UL Listed.	<b>RPL30P</b>



Bright green LED indicates "Power-On"

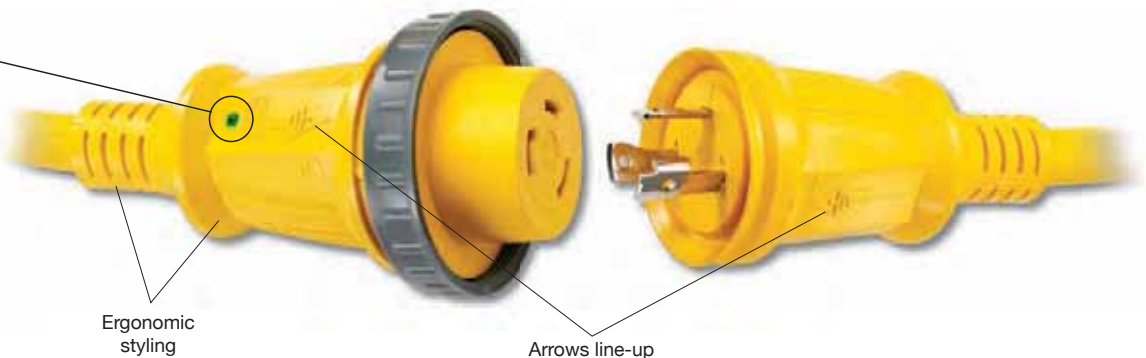

Ship-to-Shore Devices



30A 125V  
NEMA L5-30R  
UL/CSA

**30A 125V Ship-to-Shore Devices**

Description	Catalog Number
Yellow single receptacle has Rynite® body and abuse resistant nylon face. IP20 SUITABILITY.	<b>HBL26CM10</b>
Yellow Insulgrip® plug has rugged nylon housing and cord grip with range of .36-.93 in. (9-24) that utilizes a unique offset jaws arrangement to provide secure strain relief. IP20 SUITABILITY.	<b>HBL26CM11</b>
Yellow Seal-Tite® cover for weatherproofing HBL26CM11 plugs. IP44 SUITABILITY. Note: Fits Insulgrip devices only.	<b>HBL60CM31+</b>
White Seal-Tite cover for weatherproofing HBL26CM11 plugs. IP44 SUITABILITY. Note: Fits Insulgrip devices only.	<b>HBL60CM31W+</b>
Yellow Insulgrip connector body has rugged nylon housing and cord grip with range of .36-.93 in. (9-24) that utilizes a unique offset jaws arrangement to provide secure strain relief.	<b>HBL26CM13</b>
Yellow Seal-Tite cover for weatherproofing HBL26CM13 connector bodies when used with shore power inlets. Threaded sealing ring makes connection watertight. Also for weatherproofing HBL26CM11 plug when used with HBL303SSO power outlet. IP56 SUITABILITY. Note: Fits Insulgrip devices only.	<b>HBL60CM33+</b>
White Seal-Tite cover for weatherproofing HBL26CM13 connector body when used with shore power inlets. Threaded sealing ring makes connection watertight. Also for weatherproofing HBL26CM11 plug when used with HBL303SSO power outlet. IP56 SUITABILITY. Note: Fits Insulgrip devices only.	<b>HBL60CM33W+</b>
Yellow Seal-Tite cover for weatherproofing HBL26CM13 connector bodies when used on extension cords or adapters. IP44 SUITABILITY. Note: Fits Insulgrip devices only.	<b>HBL60CM32+</b>
Yellow polycarbonate spring-loaded lift cover for weather-proofing old style 26CM10 receptacle. Meets the most stringent requirements of UL's three listing categories for weatherproof plates. Stainless steel screws and neoprene gasket included for mounting to FS/FD type weatherproof boxes. IP44 SUITABILITY.	<b>HBL74CM24WO**</b>
Same as HBL74CM24WO except gray in color. IP44 SUITABILITY.	<b>HBL7424WO**</b>
Yellow polycarbonate spring-loaded lift cover for weather-proofing HBL26CM10 receptacle. Meets the most stringent requirements of UL's three listing categories for weatherproof plates. Stainless steel screws and neoprene gasket included for mounting to FS/FD type weatherproof boxes. IP44 SUITABILITY.	<b>HBL74CM25WOA**</b>
Same as HBL74CM25WOA except white in color. IP44 SUITABILITY.	<b>HBL74CM25WOAW</b>
Same as HBL74CM25WOA except gray in color. IP44 SUITABILITY.	<b>HBL7425WOA**</b>
Stainless steel wall plate for old 26CM10.	<b>SS725</b>
Stainless steel wall plate for new HBL26CM10.	<b>SS720</b>

Note: \*\*See page Y-45 for accessories.  
 +Boots are not UL Listed.



HBL26CM10



HBL26CM11



HBL60CM31



HBL26CM13



HBL60CM33



HBL60CM32

Rynite® is a registered trademark of E. I. DuPont.

## Ship-to-Shore Devices



### 30A 125V Ship-to-Shore Devices

Description	Catalog Number
Yellow Valise® plug has one-piece nylon housing and assembles easily with two screws. Built-in cord grip has range of .59-.93 in. (15.0-23.6). IP20 SUITABILITY.	<b>HBL26CM11V</b>
Black Valise plug for use on bass boats with trolling motor. One-piece nylon housing assembles easily with two screws. Built-in cord grip has a range of .59-.93 in. (15.0-23.6). IP20 SUITABILITY.	<b>HBL26CM11VB</b>
Yellow Seal-Tite® cover for weatherproofing HBL26CM11V plugs. IP44 SUITABILITY. Note: Fits Valise devices only.	<b>HBL60CM31V+</b>
Yellow Valise connector body has a one-piece nylon housing and assembles easily with two screws. Built-in cord grip has range of .59-.93 in. (15.0-23.6). IP20 SUITABILITY.	<b>HBL26CM13V</b>
Yellow Seal-Tite cover for HBL26CM13V connector body when used with shore power inlets. Threaded sealing ring makes connection watertight. IP56 SUITABILITY. Note: Fits Valise devices only.	<b>HBL60CM33V+</b>
Yellow Seal-Tite cover for weatherproofing HBL26CM13V connector bodies when used on extension cords or adapters. IP44 SUITABILITY. Note: Fits Valise devices only.	<b>HBL60CM32V+</b>
Replacement non-metallic sealing ring for 30A cable sets and boots. Not UL listed.	<b>RPL30P</b>

Note: +Boots are not UL Listed.



HBL26CM11V



HBL26CM11VB



HBL60CM31V



RPL30P



HBL26CM13V

### Valise® Plug

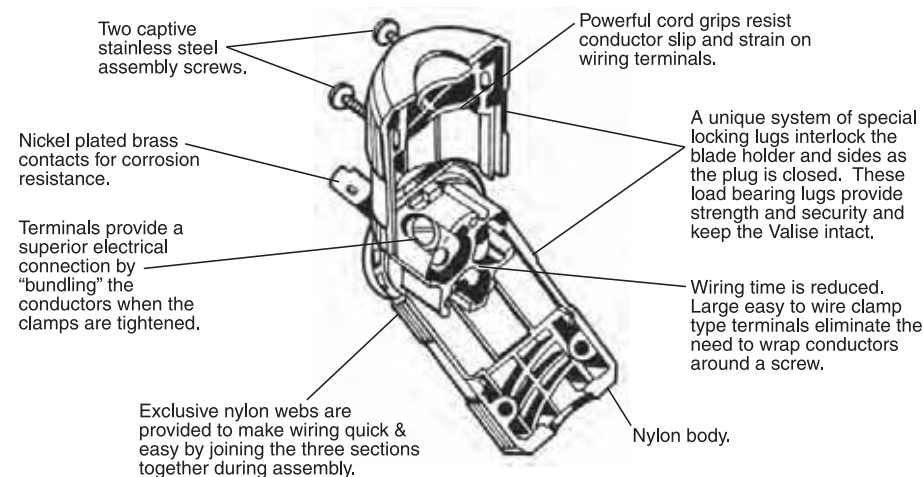

HBL60CM33V



HBL60CM32V

Ship-to-Shore Devices



50A 125V



HBL503NM

**50A 125V Ship-to-Shore Devices**

Description	Catalog Number
Stylized non-metallic shore power inlet has UV resistant white Centrex cover which makes unit weatherproof when completely closed. Interior has easy to wire terminals. Mounting holes are 2.38 in. (60.3) on centers and match existing mounting patterns. Mounting screws and gasket included. <b>IP55 SUITABILITY.</b>	<b>HBL503NM</b>
Traditional stainless steel shore power inlet has gasketed, self-closing cover so interior is shielded from the elements when not in use. Watertight when cover is securely fastened. Mounting holes are 2.38 in. (60.3) on centers, and rear portion has 2.17 in. (55.1) diameter. Mounting screws and gasket included. <b>IP56 SUITABILITY.</b>	<b>HBL503SS</b>
Protective rear cover. Fits all inlets except HBL503SS. Secures to back of inlets with three screws which are provided.	<b>SR3050**</b>
Replacement interior for HBL503SS and 63CM72 shore power inlets.	<b>CR16277</b>
Nickel plated brass connector body has heat resistant thermoset interior and combination metal and rubber cord grip provides superior strain relief capability. Cord grip range is .44–1.14 in. (11.1–29.0). <b>IP20 SUITABILITY.</b>	<b>HBL63CM60</b>
Yellow Seal-Tite® cover for connector bodies when used with 50A shore power inlets. Threaded sealing ring makes connections watertight. <b>IP56 SUITABILITY.</b>	<b>HBL77CM15+</b>
White Seal-Tite cover for connector bodies when used with 50A shore power inlets. Threaded sealing ring makes connections watertight. <b>IP56 SUITABILITY.</b>	<b>HBL77CM15W+</b>
Nickel plated brass cord clamp assembly with clamp range of .44–1.14 in. (11.1–29.0) provides strain relief for terminations on shore power inlets.	<b>HBL77CM67</b>
Yellow Seal-Tite cover for weatherproofing 50A connector bodies on extension cords or adapters. <b>IP56 SUITABILITY.</b>	<b>HBL77CM17+</b>

Note: \*\*Not UL/CSA.  
 +Boots are not UL Listed.



HBL503SS



HBL63CM60



HBL77CM15



HBL77CM17

**50A Traditional Stainless Steel Inlets**

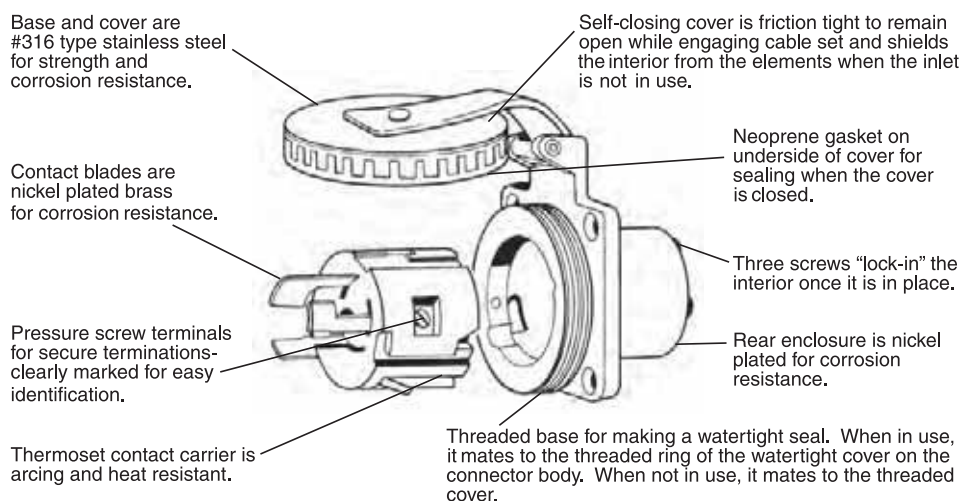

## Ship-to-Shore Devices



### 50A 125V Ship-to-Shore Devices

Description	Catalog Number
Yellow 50 ft. (15.2m) vinyl jacketed shore power cable set. #6 AWG type STOW is completely factory pre-wired with molded-on devices. Connector end has threaded metallic sealing ring to make inlet/connector interface watertight. IP54 SUITABILITY (boatside).	<b>HBL61CM53</b>
Same as HBL61CM53 except with two high intensity LEDs.	<b>HBL61CM53LED*</b>
Same as HBL61CM53 except white.	<b>HBL61CM53W</b>
Same as HBL61CM53W except with two high intensity LEDs.	<b>HBL61CM53WLED*</b>
Same as HBL61CM53 except 25 ft. (7.6m) in length.	<b>HBL61CM43</b>
Same as HBL61CM43 except with two high intensity LEDs.	<b>HBL61CM43LED*</b>
Three conductor, #6 AWG type STOW, yellow PVC jacketed portable cord with jute fillers for added flexibility. Ideal for making cable sets, extension cords, and adapters will not mark boat's deck. 250 ft. (75.2m) lengths only.	<b>YC306250</b>
Nickel plated brass plug has heat resistant thermoset interior and combination metal and rubber cord grip, provides superior strain relief capability. Cord grip range is .44-1.14 in. (11.1-29.0). IP20 SUITABILITY.	<b>HBL63CM61</b>
Yellow Seal-Tite® cover for weatherproofing 50A plugs. IP55 SUITABILITY.	<b>HBL77CM16+</b>
White Seal-Tite cover for weatherproofing 50A plugs. IP55 SUITABILITY.	<b>HBL77CM16W+</b>
Single receptacle has a heat-resistant thermoset base. IP20 SUITABILITY.	<b>HBL63CM70</b>
Yellow Valox® lift cover for weatherproofing 50A receptacles. Meets requirements of the most stringent of UL's three listing categories for weatherproof plates. Stainless steel screws and a neoprene gasket included. For mounting to FS/FD type weatherproof boxes. IP44 SUITABILITY.	<b>HBL77CM74WO</b>
Same as HBL77CM74WO except gray in color. IP44 SUITABILITY.	<b>HBL7774WO</b>
Stainless steel wall plate for 50A receptacle.	<b>SS750</b>

Note: \* See page Y-16 for features and benefits.  
 +Boots are not UL Listed.

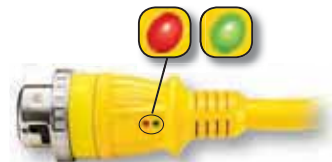

### 50A Molded Cable Sets

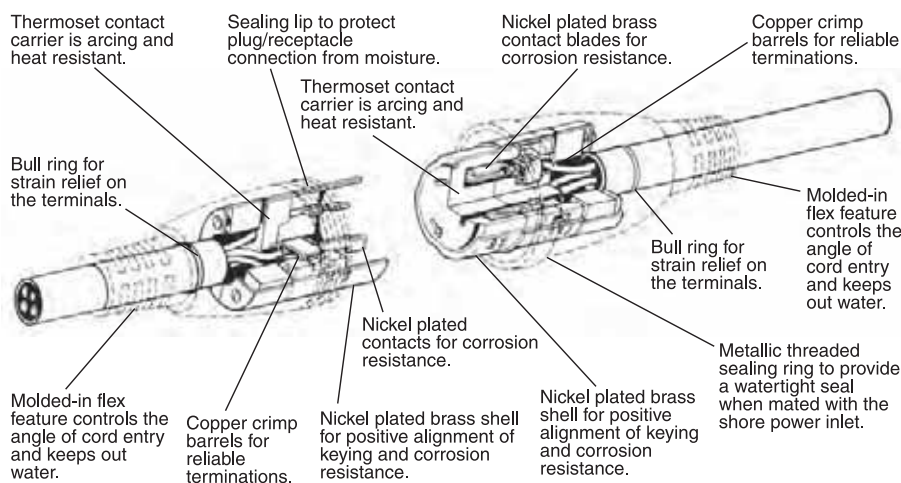

Valox® is a trademark of SABIC Innovative Plastics, acquired from General Electric Company.

Ship-to-Shore Devices



**50A 125/250V Ship-to-Shore Devices**

Description	Catalog Number
Stylized non-metallic shore power inlet has UV resistant white Centrex cover which makes unit weatherproof when completely closed. Interior is heat resistant thermoset material and has box lug terminals. Mounting holes are 2.38 in. (60.3) on centers and match existing mounting patterns. Mounting screws and gasket included. <b>IP55 SUITABILITY.</b>	<b>HBL504NM</b>
Traditional stainless shore power inlet has gasketed, self-closing cover so that the interior is shielded from the elements when not in use. It is watertight when the cover is securely fastened. The mounting holes are 2.38 in. (60.3) on centers, and the rear portion has a 2.17 in. (55.1) diameter. Mounting screws and gasket are included. <b>IP56 SUITABILITY.</b>	<b>HBL504SS</b>
Protective rear cover. Fits all inlets except HBL504SS. Secures to back of inlets with three screws which are provided.	<b>SR3050**</b>
Replacement interior for 63CM74 and HBL504SS power inlets.	<b>CR16279**</b>
Nickel plated brass connector body has a heat resistant thermoset interior and combination metal and rubber cord grip, which provides superior strain relief capability. Cord grip range is .44–1.14 in. (11.1–29.0). <b>IP20 SUITABILITY.</b>	<b>HBL63CM64</b>
Yellow Seal-Tite® cover for connector bodies when used with 50A shore power inlets. Threaded sealing ring makes connections watertight. <b>IP56 SUITABILITY.</b>	<b>HBL77CM15+</b>
White Seal-Tite cover for connector bodies when used with 50A shore power inlets. Threaded sealing ring makes connections watertight. <b>IP56 SUITABILITY.</b>	<b>HBL77CM15W+</b>
Nickel plated brass cord clamp assembly with clamp range of .44–1.14 in. (11.1–29.0) provides strain relief for terminations on shore power inlets.	<b>HBL77CM67</b>
Yellow Seal-Tite cover for weatherproofing 50A connector bodies on extension cords or adapters. <b>IP55 SUITABILITY.</b>	<b>HBL77CM17+</b>

Note: \*\*Not UL/CSA.  
 +Boots are not UL Listed.



**50A Traditional Stainless Steel Inlets**

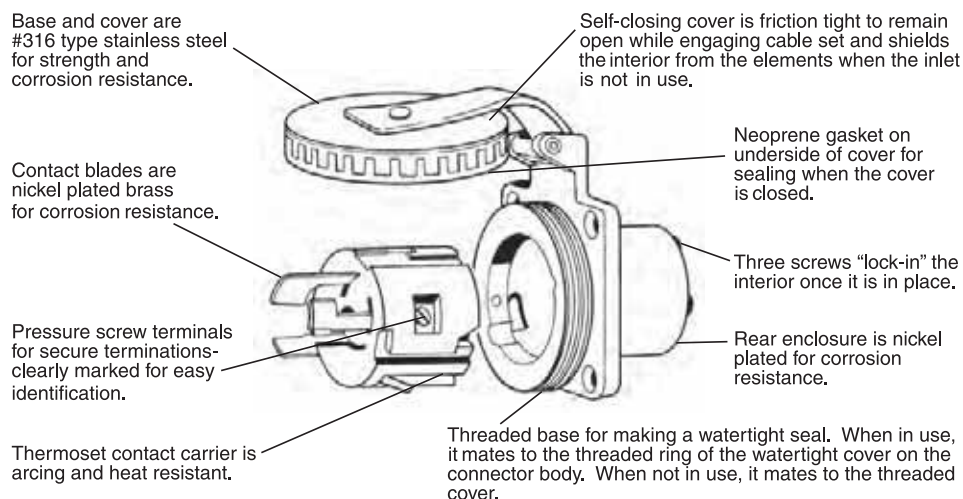

## Ship-to-Shore Devices



### 50A 125/250V Ship-to-Shore Devices

Description	Catalog Number
Yellow 50 ft. (15.2m) vinyl jacketed shore power cable set, #6 AWG type STOW is completely factory pre-wired with molded-on devices. The connector end has a metallic threaded sealing ring for making the inlet/connector interface watertight. <b>IP56 SUITABILITY (boatside).</b>	<b>HBL61CM52</b>
Same as HBL61CM52 except with two high intensity LEDs.	<b>HBL61CM52LED*</b>
Same as HBL61CM52 except white.	<b>HBL61CM52W</b>
Same as HBL61CM52W except with two high intensity LEDs.	<b>HBL61CM52WLED*</b>
Yellow 25 ft. (7.6m) vinyl jacketed shore power cable set, #6 AWG type STOW is completely factory pre-wired with molded-on devices. The connector end has a metallic threaded sealing ring for making the inlet/connector interface watertight. <b>IP56 SUITABILITY (boatside).</b>	<b>HBL61CM42</b>
Same as HBL61CM42 except with two high intensity LEDs.	<b>HBL61CM42LED*</b>
Same as HBL61CM42 except white.	<b>HBL61CM42W</b>
Same as HBL61CM42W except with two high intensity LEDs.	<b>HBL61CM42WLED*</b>
Four conductor, #6 AWG type STOW, yellow PVC jacketed portable cord with jute fillers for added flexibility is ideal for making cable sets, extension cords, and adapters that will not mark the boats deck. Available in 250 ft. (76.2m) lengths only.	<b>YC406250</b>
Nickel plated brass plug has a heat resistant thermoset interior and combination metal and rubber cord grip, which provides superior strain relief capability. Cord grip range is .44-1.14 in. (11.1-29.0). <b>IP20 SUITABILITY.</b>	<b>HBL63CM65</b>
Yellow Seal-Tite® cover for weatherproofing 50A plugs. <b>IP55 SUITABILITY.</b>	<b>HBL77CM16+</b>
White Seal-Tite® cover for weatherproofing 50A plugs. <b>IP55 SUITABILITY.</b>	<b>HBL77CM16W+</b>
Single receptacle has a heat resistant thermoset base. <b>IP20 SUITABILITY.</b>	<b>HBL63CM69</b>
Yellow Valox® lift cover for weatherproofing 50A receptacles. Meets requirements of the most stringent of UL's three listing categories for weatherproof plates. Stainless steel screws and a neoprene gasket included. For mounting to FS/FD type weatherproof boxes. <b>IP44 SUITABILITY.</b>	<b>HBL77CM74WO</b>
Same as HBL77CM74WO except gray in color. <b>IP44 SUITABILITY.</b>	<b>HBL7774WO</b>
Stainless steel wall plate for 50A receptacle.	<b>SS750</b>

Note: \* See page Y-16 for features and benefits.  
 +Boots are not UL Listed.



HBL61CM52  
 HBL61CM52W  
 HBL61CM42  
 HBL61CM42W

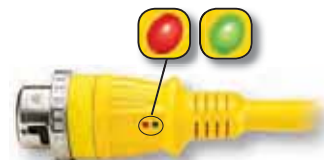

HBL63CM65



HBL77CM16



HBL63CM69



HBL77CM74WO



SS750

### 50A Molded Cable Sets

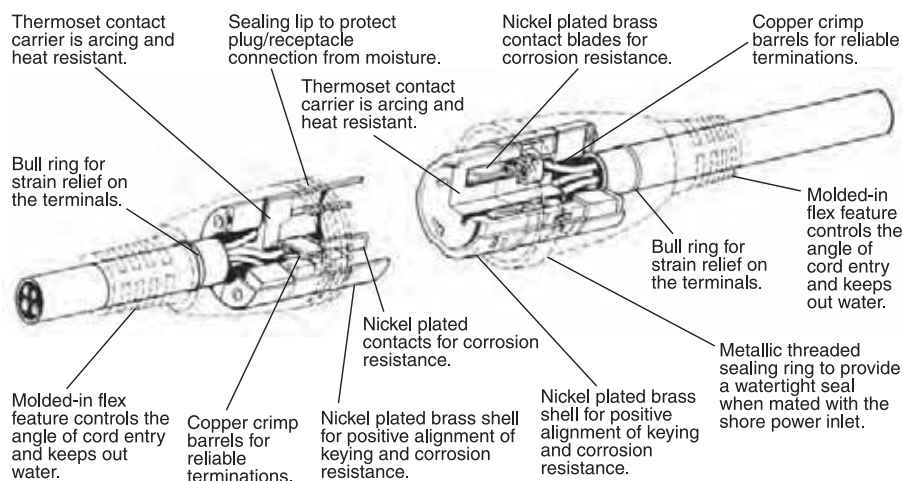

Valox® is a trademark of SABIC Innovative Plastics, acquired from General Electric Company.

Marine Products

50 Ampere, Cable Set with Two High Intensity LEDs:  
 "Power-On" and "Incorrect Wiring" Indicators  
 Ship-to-Shore Cable Sets



- Two bright, durable, LEDs. GREEN indicates "Power-On" and RED indicates "Incorrect Wiring" at the power source.
- High intensity LEDs are visible—even in bright sunlight.
- Totally molded design for superior waterproofing and durability.
- Exclusive copper crimp barrel terminations for tighter connections and longer life.



Bull ring for added strain relief

Exclusive crimp termination for longer life



50A Shore Power Cable Set with Two LED Indicators

Description	Catalog Number	
Yellow 50 ft. (15.2m) vinyl jacketed shore power cable set, #6 AWG type STOW is completely factory pre-wired with molded-on devices. The connector end has a metallic threaded sealing ring for making the inlet/connector interface watertight.	HBL61CM53LED	HBL61CM52LED
Same as HBL61CM52LED except in white.	HBL61CM53WLED	HBL61CM52WLED
Same as HBL61CM52LED except 25 ft. (7.6m) in length.	HBL61CM43LED	HBL61CM42LED
Same as HBL61CM42LED except in white.	—	HBL61CM42WLED

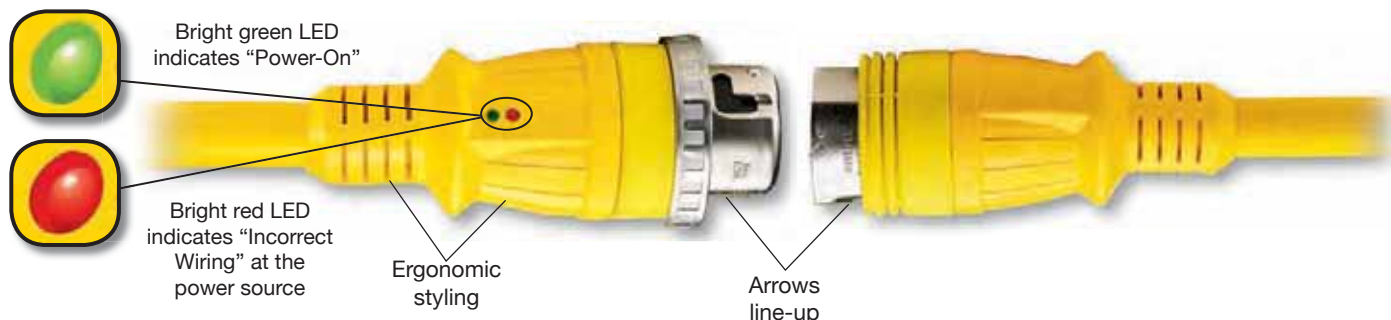

Bright green LED indicates "Power-On"

Bright red LED indicates "Incorrect Wiring" at the power source

Ergonomic styling

Arrows line-up



# Marine Products

## 100 Ampere, 125/250 Volt and 3ØY 120/208 Volt Ship-to-Shore Cable Sets



- Hubbell Marine was the first to offer 100 amp marine grade devices that are considered second to none.
- Hubbell developed the standard for 100 amp Pin and Sleeve devices with the National Electric Code and the American Boat and Yacht Council.
- Only Hubbell offers 3, 4 and 5 wire 100 amp cable sets for your shore power requirements.
- Cable sets manufactured in factory-controlled conditions using specially compounded cable to accommodate a full 100 amp.

### Features

- Factory assembled.
- 100 Amp Pin and Sleeve devices
- UL Listed cable.
- Breadth of line.
- 100% inspection.

### Benefits

- Reliable and consistent terminations.
- Rugged, watertight, UL listed, ABYC compliant, corrosion resistant
- High visibility yellow, STOW cable, 105°C rated, and UL listed.
- Available in 75, 100, and 125 ft. lengths with and without a neutral. Fifty foot extension cords also available.
- Each cable set is tested to ensure quality performance.

**IP56**  
SUITABILITY



100A  
125/250V AC



100A 3ØY  
120/208V AC

### 100A Ship-to-Shore Cable Sets

Description	Catalog Number	
Yellow 75 ft. (22.8m) corrosion resistant shore power cable set, 105°C rated, #2 AWG, (no neutral), STOW cable with plug and connector body for use with boats with isolation transformer on board.	CS75IT4*	CS75IT5
Same as above except 100 ft. (30.4m) in length.	CS100IT4	CS100IT5
Yellow 75 ft. (22.8m) corrosion resistant shore power cable set, 105°C rated, #2 AWG, STOW cable.	CS754	—
Same as CS754/5 except 100 ft. (30.4m) in length.	CS1004	—
Yellow 50 ft. (15.2m) corrosion resistant extension cord, 105°C rated, #2 AWG, STOW cable. For mating with existing shore power cable set.	CS50EXT4	CS50EXT5
Yellow 75 ft. (22.8m) corrosion resistant one-ended (male only) power supply cable, 105°C rated, #2 AWG, STOW cable with 3 pole 4 wire male plug only; for use with boats using a cable winch system.	CW754	—
Yellow 100 ft. (30.4m) corrosion resistant one-ended (male only) power supply cable, 105°C rated, #2 AWG, (no neutral) STOW cable with male plug only; for use with boats with isolation transformer on board and a cable winch system.	CW100IT4	CW100IT5
Same as CW100IT4/5 except 125 ft. (38.0m) in length.	CW125IT4	CW125IT5
Same as CW100IT4/5 except in white.	CW100IT4W	—



CS75IT4

Note: Periodic cleaning and lubrication (such as LPS-1® made by Holt Lloyd Corp.) of the pins and sleeves of these devices is necessary to enjoy years of optimal use.  
\*Also available in white, consult factory.

Ship-to-Shore Devices



**100A 125/250V Ship-to-Shore Devices**

Description	Catalog Number
Gray nylon shore power inlet has gasketed, spring-loaded cover which closes automatically when not in use and is watertight when securely fastened. Mounting holes are 4.88 in. (123.8) on centers and rear portion has 3.94 in. (100.0) diameter. Mounting screws and gasket included. <b>IP56 SUITABILITY.</b>	<b>M4100B12R</b>
Yellow Zytel® super tough nylon watertight connector body has gasketed locking ring to make inlet/connector interface watertight. Cord grip range is 1.06–1.94 in. (26.9–49.3). Note: This device mates with shore power inlet only. <b>IP56 SUITABILITY.</b>	<b>M4100C12R</b>
15° angle cast aluminum back box has corrosion resistant gray finish and top hub with 1½ in. NPT 100A receptacles can be mounted directly to it.	<b>BB1001W</b>
Same as BB1001W except threaded top hub is 2 in. NPT.	<b>BB1002W</b>
15° angle non-metallic back box, made of high-grade engineered thermoplastic Valox® to resist chemicals, abuse and U.V. rays. Has integral grounding plate, 1½ in. NPT hub size and 120 cu. in. capacity (hub is not included - Raco part number 1706 is recommended). <b>IP57 SUITABILITY.</b>	<b>BB100N</b>



M4100B12R



M4100C12R



BB1001W  
BB1002W



BB100N

**Replacement Parts**

Description	Catalog Number
Replacement lift cover assembly; includes cover, arm and assembly tool.	<b>CA100</b>
Replacement locking ring and cord clamp.	<b>CC100</b>
Replacement locking ring only.	<b>LR100</b>

Note: Periodic cleaning and lubrication (such as LPS-1® made by Holt Lloyd Corp.) of the pins and sleeves of these devices is necessary to enjoy years of optimal use.

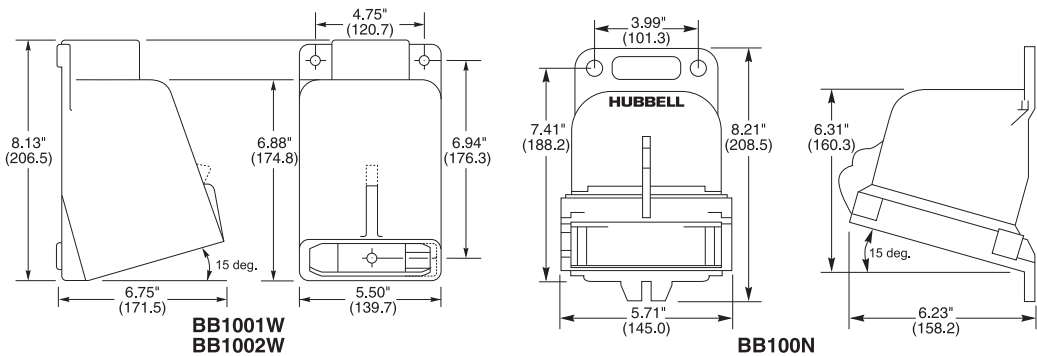

**Shore Power Inlet**

The gasketed, self-closing cover is keyed to normally seat in a position that provides a weatherproof seal. Simply rotating the cover and locking it makes it watertight.

The terminals are clearly identified with large markings for easy recognition.

High impact thermoset contact carrier is arcing and heat resistant.

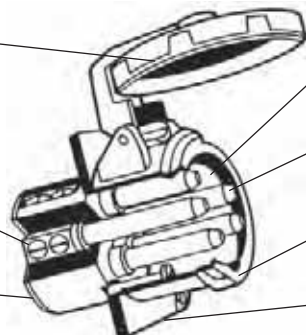

The device is marked with its catalog number and rating for easy identification.

Nickel plated solid brass pins provide for long life and reliable electrical contact in corrosive environments.

Special keying makes proper alignment of mating devices quick and easy.

Nylon housing provides increased safety and abuse resistance.

Zytel® is a registered trademark of E. I. DuPont.  
 Valox® is a trademark of SABIC Innovative Plastics, acquired from General Electric Company.

Dimensions in Inches (mm)

## Ship-to-Shore Devices



### 100A 125/250V Ship-to-Shore Devices

Description	Catalog Number
Yellow Zytel® super tough nylon watertight plug has gasketed locking ring to make plug/receptacle interface watertight. Cord grip range is 1.06–1.94 in. (26.9–49.3). <b>IP56 SUITABILITY.</b>	<b>M4100P12</b>
Gray nylon dockside receptacle has gasketed, spring-loaded cover. Closes automatically when not in use and is watertight when securely fastened. Mounting holes are 4.88 in. (123.8) on centers. Mounting screws and gasket included. <b>IP56 SUITABILITY.</b>	<b>M4100R12</b>
Yellow Zytel® super tough nylon watertight connector body for mating plug to connector interface on extension cords or adapters. Cord grip range is 1.06–1.94 in. (26.9–49.3). Note: It cannot be mated to the shore power inlet. <b>IP56 SUITABILITY.</b>	<b>M4100C12</b>
Back box for inlets and receptacles has 15° angle section which can be installed in any of 4 positions. Box is cast aluminum with corrosion resistant gray alkyd-based enamel finish and 1½ in. NPT hub which can be mounted for either top or bottom feed. <b>IP56 SUITABILITY.</b>	<b>FW60100</b>
Closure Cap for 100A plugs and connector bodies that (do not have a cap attached) have locking rings.	<b>PC100</b>



### Replacement Parts

Description	Catalog Number
Replacement lift cover assembly; includes cover, arm and assembly tool.	<b>CA100</b>
Replacement locking ring and cord clamp.	<b>CC100</b>
Replacement locking ring only.	<b>LR100</b>

Note: Periodic cleaning and lubrication (such as LPS-1® made by Holt Lloyd Corp.) of the pins and sleeves of these devices is necessary to enjoy years of optimal use.

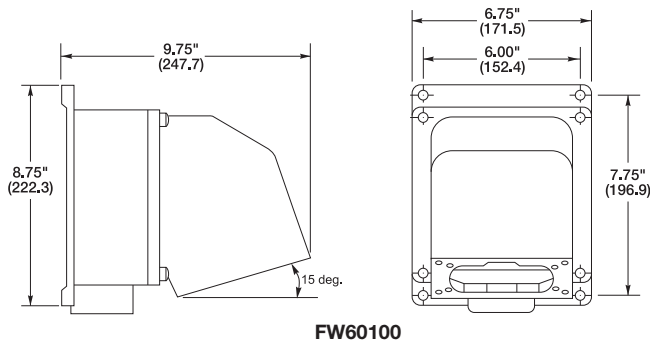

### 100A Connector Body

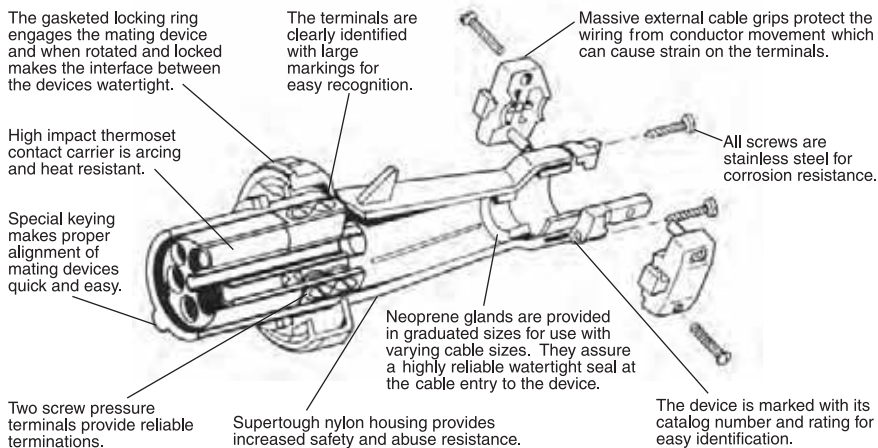

Zytel® is a registered trademark of E.I. DuPont.

Dimensions in Inches (mm)



**Ship-to-Shore Devices**



M5100B9R

**100A 3ØY 120/208V and 100A 3ØY 277/480V**

**Description**  
 Gray nylon shore power inlet has gasketed, spring-loaded cover which closes automatically when not in use and is watertight when securely fastened. Mounting holes are 4.88 in. (123.8) on centers and rear portion has 3.94 in. (100.0) diameter. Mounting screws and gasket included. **IP56 SUITABILITY.**

Yellow Zytel® super tough nylon watertight connector body has gasketed locking ring to make inlet/connector interface watertight. Cord grip range is 1.06–1.94 in. (26.9–49.3). Note: This device mates with shore power inlet only. **IP56 SUITABILITY.**

15° angle cast aluminum back box has corrosion resistant gray finish and top hub with 1½ in. NPT 100A receptacles can be mounted directly to it.

Same as BB1001W except threaded top hub is 2 in. NPT.

15° angle non-metallic back box, made of high-grade engineered thermoplastic Valox® to resist chemicals, abuse and U.V. rays. Has integral grounding plate, 1½ in. NPT hub size and 120 cu. in. capacity (hub is not included - Raco part number 1706 is recommended). **IP57 SUITABILITY.**



100A 3ØY  
120/208V AC



100A 3ØY  
277/480V AC

**Catalog Number**

M5100B9R M5100B7R

M5100C9R M5100C7R

BB1001W BB1001W

BB1002W BB1002W

BB100N BB100N



M5100C9R

**Replacement Parts**

Description	Catalog Number
Replacement lift cover assembly; includes cover, arm and assembly tool.	CA100 CA100
Replacement locking ring and cord clamp.	CC100 CC100
Replacement locking ring only.	LR100 LR100

*Note: Periodic cleaning and lubrication (such as LPS-1® made by Holt Lloyd Corp.) of the pins and sleeves of these devices is necessary to enjoy years of optimal use.*



BB1001W  
BB1002W

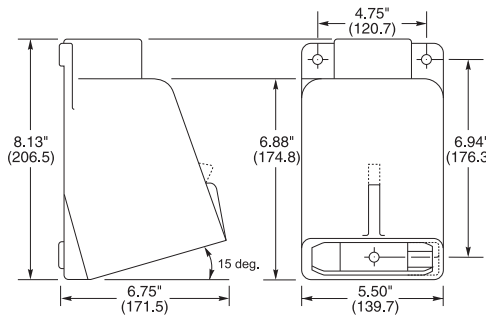

BB1001W  
BB1002W

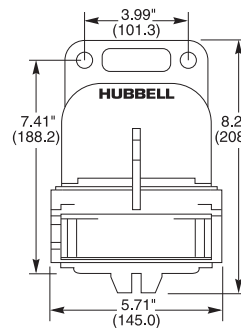

BB100N

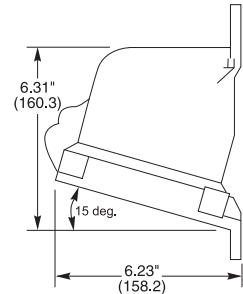

**Shore Power Inlet**



BB100N

The gasketed, self-closing cover is keyed to normally seat in a position that provides a weatherproof seal. Simply rotating the cover and locking it makes it watertight.

The terminals are clearly identified with large markings for easy recognition.

High impact thermoset contact carrier is arcing and heat resistant.

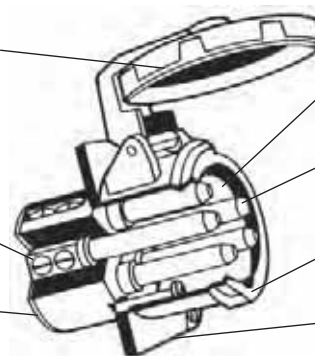

The device is marked with its catalog number and rating for easy identification.

Nickel plated solid brass pins provide for long life and reliable electrical contact in corrosive environments.

Special keying makes proper alignment of mating devices quick and easy.

Nylon housing provides increased safety and abuse resistance.

Dimensions in Inches (mm)

Valox® is a trademark of SABIC Innovative Plastics, acquired from General Electric Company.  
 Zytel® is a registered trademark of E.I. DuPont.

### Ship-to-Shore Devices

#### 100A 3ØY 120/208V and 100A 3ØY 277/480V

Description	Catalog Number	Catalog Number
Yellow Zytel® super tough nylon watertight plug has gasketed locking ring to make plug/receptacle interface watertight. Cord grip range is 1.06–1.94 in. (26.9–49.3). <b>IP56 SUITABILITY.</b>	<b>M5100P9</b>	<b>M5100P7</b>
Gray nylon dockside receptacle has gasketed, spring-loaded cover. Closes automatically when not in use and is watertight when securely fastened. Mounting holes are 4.88 in. (123.8) on centers. Mounting screws and gasket included. <b>IP56 SUITABILITY.</b>	<b>M5100R9</b>	<b>M5100R7</b>
Yellow Zytel® super tough nylon watertight connector body for making plug to connector interface on extension cords or adapters. Cord grip range is 1.06–1.94 in. (26.9–49.3). Note: It cannot be mated to the shore power inlet. <b>IP56 SUITABILITY.</b>	<b>M5100C9</b>	<b>M5100C7</b>
Back box for inlets and receptacles has 15° angle section which can be installed in any of 4 positions. Box is cast aluminum with corrosion resistant gray alkyd-based enamel finish and 1½ in. NPT hub which can be mounted for either top or bottom feed. <b>IP56 SUITABILITY.</b>	<b>FW60100</b>	<b>FW60100</b>
Closure Cap for 100A plugs and connector bodies that (do not have a cap attached) have locking rings.	<b>PC100</b>	<b>PC100</b>



100A 3ØY  
120/208V AC



100A 3ØY  
277/480V AC



M5100P9



M5100R9



M5100C9



FW60100



PC100



CA100

### Replacement Parts

Description	Catalog Number	Catalog Number
Replacement lift cover assembly; includes cover, arm and assembly tool.	<b>CA100</b>	<b>CA100</b>
Replacement locking ring and cord clamp.	<b>CC100</b>	<b>CC100</b>
Replacement locking ring only.	<b>LR100</b>	<b>LR100</b>

Note: Periodic cleaning and lubrication (such as LPS-1® made by Holt Lloyd Corp.) of the pins and sleeves of these devices is necessary to enjoy years of optimal use.

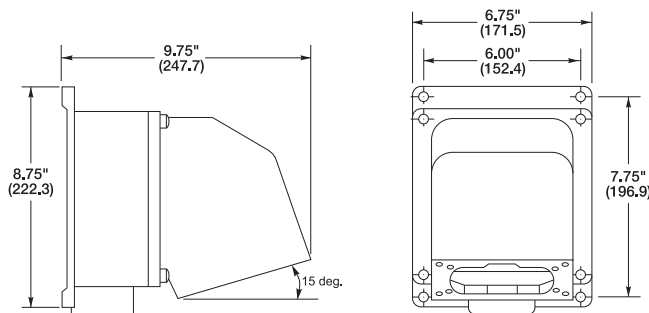

FW60100

### 100A Connector Body

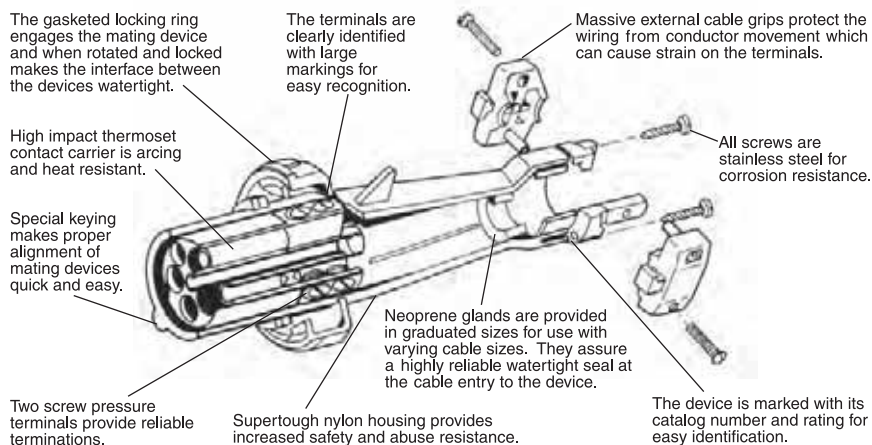

Zytel® is a registered trademark of E.I. DuPont.

Dimensions in Inches (mm)

**Ship-to-Shore Devices**



Hubbell was the first to offer a UL Listed 100 Amp Marine Ship-To-Shore System... and now, we are the first to offer a UL Listed 200 Amp Marine Ship-To-Shore System.

The only 200 Amp-rated Ship-to-Shore System - built specifically for Mega-Yachts.

- Type 3,4, 4X Rated per UL50 standard for superior water resistance.
- UL Listed and CSA Certified.
- Interchangeable with other "UL1686 Series C1" Listed devices.
- Terminal screws feature swivel/pressure pads to secure, and prevent damage to conductors strands.
- Cable clamp captures cable at four points, provides superior retention.
- Housing is made of copper-free aluminum with an electrostatically applied epoxy/polyester finish.
- Accepts a cord range of #1 AWG – 250 MCM.
- Pins and Sleeves are made of nickel-plated Tellurium copper for superior corrosion and heat resistance.

Hubbell 200 Amp devices are listed to UL 1682 and UL Classified for the mating and operation of 200 Amp devices. Mates with Cooper® Crouse-Hinds® Arktite® or Appleton® Powertite® (when installed in accordance with instructions furnished with device).



200A  
600V AC/250V DC

**200A 600V Ship-to-Shore Devices**

Description	Catalog Number
Gray metallic watertight shore power inlet with wingnut-secured lid for water tightness when not in use.	<b>M5200BS1R</b>
Gray/yellow metallic watertight connector body with locking ring to make inlet/connector body interface watertight. Cord grip range is #1 AWG-250 MCM 1.00-2.5 in. (25.4-6.35).	<b>M5200CS1R</b>



M5200BS1R



M5200CS1R

**Dimensions**

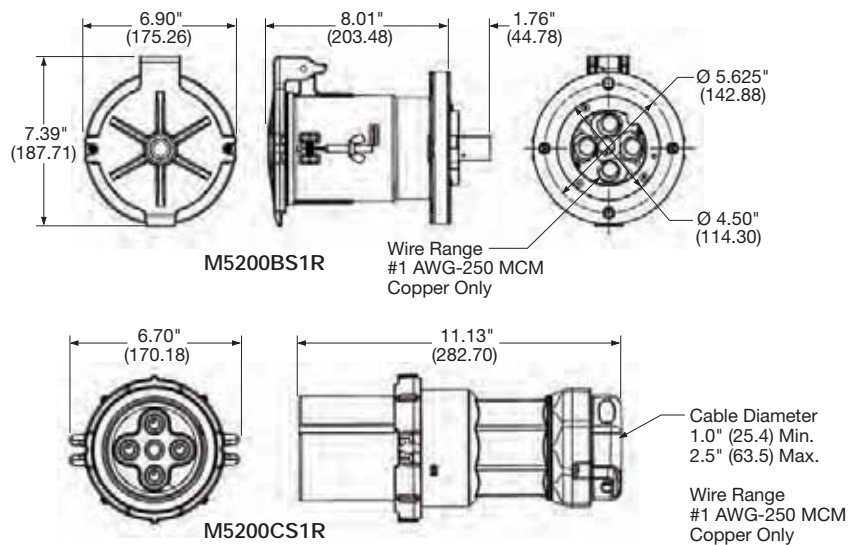

Dimensions in Inches (mm)

Appleton® and Powertite® are registered trademarks of Appleton Electric Company  
 Cooper Crouse-Hinds® and Arktite® are registered trademarks of Cooper Industries, Inc

## Ship-to-Shore Devices



200A  
600V AC/250V DC

### 200A 125/250V Ship-to-Shore Devices

Description	Catalog Number
Gray/yellow metallic watertight plug with locking ring to make plug/receptacle interface watertight. Cord grip range is #1 AWG-250 MCM 1.00-2.5 in. (25.4-6.35).	<b>M5200PS1</b>
Gray metallic, watertight dockside receptacle with wing nut-secured lid for water tightness when not in use.	<b>M5200RS1</b>
Gray/yellow metallic watertight connector body with wing nut-secured lid for water tightness when not in use. For making plug/connector body interface on extension cords or adapters.	<b>M5200CS1</b>
Gray metallic Back Box for inlets and receptacles has 45° angle section which can be installed in any of 4 positions, 2 in. NPT hub.	<b>MB2003W</b>
Gray metallic Back Box – same as above but 2½ in. NPT hub.	<b>MB2004W</b>



M5200PS1



M5200RS1



M5200CS1



MB2003W

## Dimensions

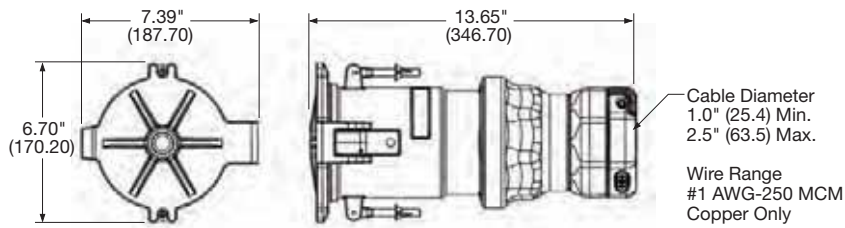

M5200CS1

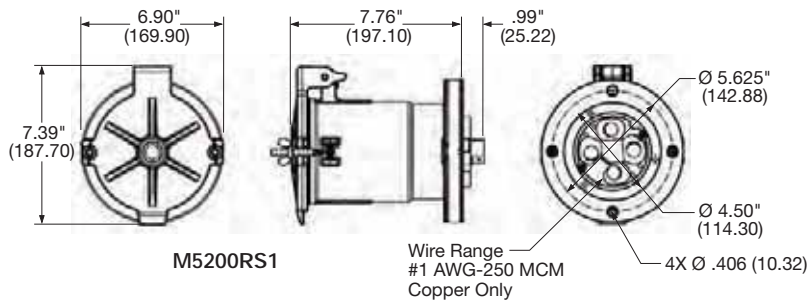

M5200RS1

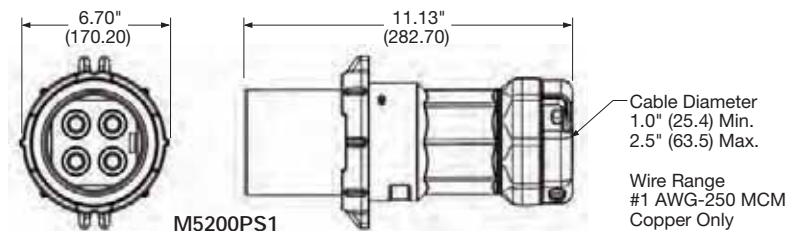

M5200PS1

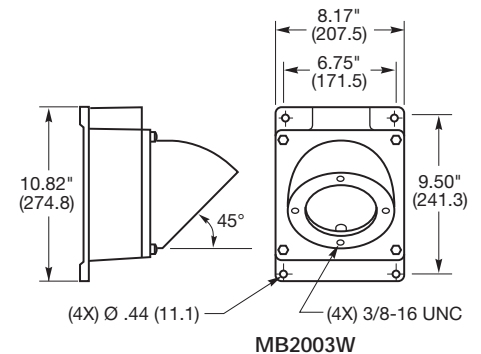

MB2003W

Dimensions in Inches (mm)



HBL316NM  
HBL332NM

Hubbell offers the only CE certified electrical shore power system truly dedicated for boats destined for Europe and the International community. Hubbell's offering of international shore power inlets are available in traditional 316 stainless steel and attractive white non-metallic types resembling our domestic offering in style and appearance but are not interchangeable with the domestic shore power system.

Utilizing standard NEMA (National Electrical Manufacturer's Association) configurations not typically used in the marine market, Hubbell can offer a safe and non-interchangeable 16 Amp 230 Volt system and 32 Amp 230 Volt system for use with 50 cycle systems. The system includes white power supply cables (one-end, female only) in both the 16 Amp and 32 Amp categories.

**Twist-Lock® Devices, Ship-To-Shore Power System**



HBL316SSX  
HBL332SSX

Description	16A 230V	32A 230V, 50 Cycle
Non-metallic, white, stylized, UV resistant shore power inlet. White Centrex cover makes the inlet weatherproof when closed. Mounting holes are 2.38 in. (60.3) on centers and match most existing mounting patterns. Rear enclosure strain/relief cap is provided. <b>IP55 SUITABILITY.</b>	<b>HBL316NM</b>	<b>HBL332NM</b>



HBL316CSW25  
HBL316CSW  
HBL332CSW

Traditional, stainless steel shore power inlet has new easy-to-wire terminations. Interior is transparent for quick and easy visual inspection. Interior is shielded from the elements by a gasketed, self-closing cover, watertight when cover is screwed in place. Mounting holes are 2.38 in. (60.3) on centers. Mounting screws and gasket included. Protective rear enclosure/strain relief also included. <b>IP56 SUITABILITY.</b>	<b>HBL316SSX</b>	<b>HBL332SSX</b>
--	------------------	------------------



HBL316CRCX  
HBL332CRCX

25 ft. (7.6m) white, vinyl jacketed power supply cord with female (boat side) end only; other end blunt cut. <b>IP56 SUITABILITY.</b>	<b>HBL316CSW25</b>	-
---	--------------------	---



HBL60CM33  
HBL60CM33W

50 ft. (15.2m) white, vinyl jacketed power supply cord with female (boat side) end only; other end blunt cut.	<b>HBL316CSW</b>	<b>HBL332CSW</b>
---	------------------	------------------

Yellow locking connector replacement end for HBL316CSW25 and HBL316CSW. <b>IP20 SUITABILITY.</b>	<b>HBL316CRCX</b>	<b>HBL332CRCX</b>
--	-------------------	-------------------

White Seal-Tite® cover with threaded sealing ring for use with HBL316CRC and HBL332CRC connector bodies. <b>IP56 SUITABILITY.</b>	<b>HBL60CM33W</b>	<b>HBL60CM33W</b>
---	-------------------	-------------------

White Seal-Tite® cover with threaded sealing ring for use with HBL316CRC and HBL332CRC connector bodies. <b>IP56 SUITABILITY.</b>	<b>HBL60CM33</b>	<b>HBL60CM33</b>
---	------------------	------------------



HBL316R6W

**Pin and Sleeve Devices, Rated in Either 16A, 32A or 63A, 240V, 2 Pole Plus Earth (⊥)**

**IP66**  
SUITABILITY

Description	16A 240V	32A 240V	63A 240V
Shore power inlet with mounting holes 3.13 in. (79.3) on centers and 2.72 in. (69.1) diameter on rear portion.	<b>HBL316B6W</b>	<b>HBL332B6W</b>	<b>HBL363B6W</b>
Connector body with cord grip range of .36-.83 in. (9.1-21.1).	<b>HBL316C6W</b>	<b>HBL332C6W</b>	<b>HBL363C6W</b>
Shore power receptacle with mounting holes 3.13 in. (79.3) on centers and 2.72 in. (69.1) diameter on rear portion.	<b>HBL316R6W</b>	<b>HBL332R6W</b>	<b>HBL363R6W</b>
Plug with cord grip range of .36-.83 in. (9.1-21.1).	<b>HBL316P6W</b>	<b>HBL332P6W</b>	<b>HBL363P6W</b>
Closure plug for HBL316B6W. Not CSA.	<b>PC320</b>	<b>PC3430</b>	<b>PC60</b>
Back box for inlets and receptacles is cast aluminum with corrosion resistant alkyd-based enamel finish and two ¼ in. NPT hubs.	<b>BB201W</b>	<b>BB301W</b>	<b>BB601W</b>
Feed-thru box for inlets and receptacles is cast aluminum with corrosion resistant alkyd-based enamel finish and one ¼ in. NPT hubs.	<b>FT202W</b>	-	<b>FW60100</b>



HBL316B6W



HBL316C6W



HBL316P6W



# Marine Products Internationally Rated Twist-Lock® Devices

16, 32 Ampere, 230 Volt



## Safe Non-Interchangeable Solutions

Hubbell, the only manufacturer of CE certified 16 Amp and 32 Amp, Shore Power Systems dedicated to the International boating community, now offers a 63 Amp Shore Power System.

Hubbell's 63 Amp System is of similar traditional marine styling, but, similar to Hubbell's 16 and 32 Amp systems, are not interchangeable with U.S. Shore Power Systems – offering a safe, stylish 63 Amp system built to the same high quality standards you've come to expect from Hubbell.



## 63A 230V Ship-To-Shore Power Systems

Description	Catalog Number
Traditional, stainless steel shore power inlet, including higher-quality metal threads, heat-resistant thermoset interior and box lug terminals. IP56 SUITABILITY.	<b>HBL363SSX</b>
Nickel plated brass plug with heat-resistant thermoset interior and box lug terminals cord grip range is .44 – 1.14 in. (11.1 - 29.0). IP55 SUITABILITY.	<b>HBL363CRP</b>
Nickel plated brass connector body with heat-resistant thermoset interior and box lug terminals. Cord grip range is .44 – 1.14 in. (11.1 - 29.0). IP55 SUITABILITY.	<b>HBL363CRC</b>
Single receptacle with heat-resistant thermoset base. IP20 SUITABILITY.	<b>HBL363CRR</b>
Yellow Seal-Tite® cover for connector bodies when used with 63A shore power inlets. Stainless steel threaded sealing ring makes connections watertight. IP56 SUITABILITY.	<b>HBL77CM15</b>
Same as HBL77CM15 except in white.	<b>HBL77CM15W</b>
Yellow Seal-Tite® cover for 63A plugs. IP55 SUITABILITY.	<b>HBL77CM16</b>
Same as HBL77CM16 except in white.	<b>HBL77CM16W</b>



HBL363SSX



HBL363CRP



HBL363CRC



HBL363CRR



HBL77CM15

## 63A Internationally Rated Stainless Steel Inlets

**Base and Cover**  
#316 type stainless steel for strength and corrosion resistance

**Self-closing Cover**  
Friction tight to remain open while engaging cable set and shields the interior from the elements when the inlet is not in use

**Contact Blades**  
Nickel plated brass for corrosion resistance

**Corrosion Resistant**  
Rear enclosure is nickel plated

**Thermoset Contact Carrier**  
Arcing and heat resistant

**Watertight Seal**  
When in use, threaded base mates to the threaded ring of the watertight cover on the connector body. When not in use, it mates to the threaded cover

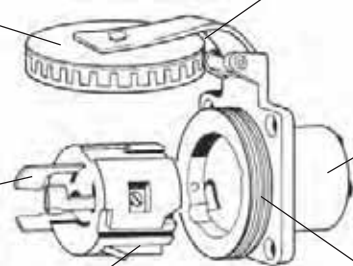

## Marine Products Intelligent Y Adapters

**YQ230** - Safely powers a 50A, 125/250V AC boat from two 30A, 125V AC receptacles at dockside.

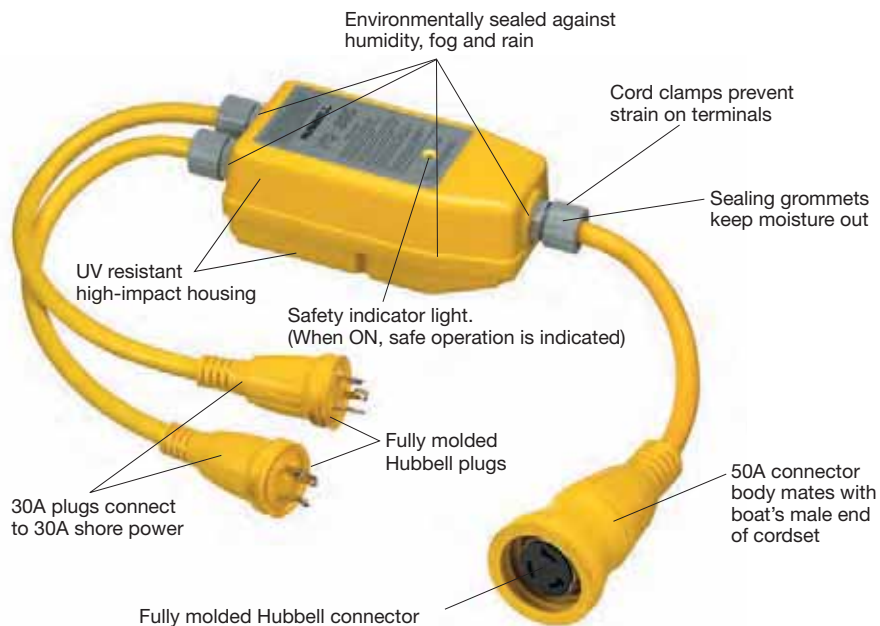

### Application

**Problem:** A boat owner with one electrical system on board docks in a marina that can only provide a different electrical system.

**Solution:** Use of the Hubbell YQ series of Intelligent Adapters can correct many electrical system mismatches.

### Features and Benefits

- 3 pole contactor breaks both hots and neutrals to prevent possibility of “live” plug when not engaged.
- Combines two oppositely-phased 30A, 125V receptacles to provide 30A, 125/250 volts of power.



**YQ100PLUS** - Safely powers a 100A, 125/250V AC boat from two 50A, 125/250V AC receptacles at dockside -or- from a single 50A, 125/250V AC receptacle acting as a single adapter.

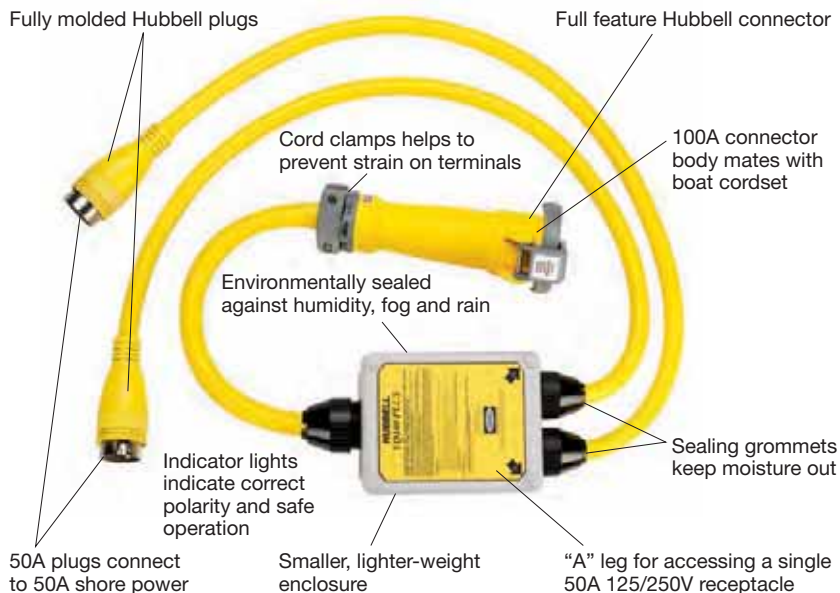

### Internal Logic Senses That:

- Both plugs are fully engaged (i.e., one is not dangling loose while the other is plugged in) -or- the “A” leg plug is engaged to access a single 50A, 125/250V receptacle.
- The polarity of the receptacle on the dock is correct (i.e., no mis-wiring of the hot and neutral wires).
- The two receptacles are from correct phases.











































## Intelligent Y Adapters

Description	Catalog Number
Adapter that permits use of 50A, 125/250V AC cable set. (HBL61CM52), with two 30A, 125V AC receptacles, HBL26CM10.	<b>YQ230</b>
Adapter that permits use of 100A, 125/250V AC cable set. (CS754, CS1004) with one or two 50A, 125/250V AC receptacles, HBL63CM69.	<b>YQ100PLUS</b>

*Note: The YQ230 Adapter will only work with two 30A receptacles that are on different phases.*

*The YQ100PLUS Adapter must be plugged into two 50A, 125/250V AC receptacles that are on the same phase to achieve 100 amp, 125/250 volts power -or- the “A” leg 50A male into a single 50A, 125/250V AC receptacle to achieve 50 amp, 125/250 volts power.*

# Marine Products Adapter Selection Guide

Boat/Cable Set Side Connector Body (Female End)	Molded Straight Adapters		Power Center/Dock Side Plug (Male End)
15A 125V, 2P 3W Straight		<b>HBL105GF*</b>	 30A 125V, 2P 3W Twist-Lock®
30A 125V, 2P 3W Twist-Lock®		<b>HBL61CM22</b> <b>HBL61CM22W</b>	 15A 125V, 2P 3W Straight Blade (lock type)
30A 125V, 2P 3W Twist-Lock		<b>HBL61CM25</b>	 20A 125V, 2P 3W Twist-Lock
50A 125V, 2P 3W Twist-Lock		<b>HBL61CM54</b>	 15A 125V, 2P 3W Straight Blade
30A 125V, 2P 3W Twist-Lock		<b>HBL61CM55</b>	 50A 125V, 2P 3W Twist-Lock
50A 125V, 2P 3W Twist-Lock		<b>HBL61CM56</b>	 30A 125V, 2P 3W Twist-Lock
50A 125/250V, 3P 4W Twist-Lock		<b>HBL61CM59</b>	 50A 125/250V, 3P 4W Crow Foot
30A 125V, 2P 3W Twist-Lock		<b>HBL61CM71</b>	 50A 125/250V, 3P 4W Twist-Lock
50A 125V, 2P 3W Twist-Lock		<b>HBL61CM72</b>	 50A 125/250V, 3P 4W Twist-Lock
100A 125/250V, 3P 4W Pin/Sleeve		<b>HBL61CM100</b>	 50A 125/250V, 3P 4W Twist-Lock
<b>Molded "Y" Adapters</b>			
(2) 30A 125V, 2P 3W Twist-Lock	 	<b>HBL64CM54</b>	 50A 125/250V, 3P 4W Twist-Lock
(2) 50A 125V, 2P 3W Twist-Lock	 	<b>HBL64CM55</b>	 50A 125/250V, 3P 4W Twist-Lock
(2) 30A 125V, 2P 3W Twist-Lock	 	<b>HBL64CM56</b>	 30A 125V, 2P 3W Twist-Lock
(2) 30A 125V, 2P 3W Twist-Lock	 	<b>HBL64CM57</b>	 50A 125V, 2P 3W Twist-Lock
(2) 30A 125V, 2P 3W Twist-Lock	 	<b>HBL64CM59</b>	 50A 125/250V, 3P 4W Crow Foot
<b>One Piece Adapters</b>			
30A 125V, 2P 3W Twist-Lock		<b>HBL31CM28</b>	 15A 125V, 2P 3W Straight Blade
15 or 20A 125V, 2P 3W Straight Blade		<b>HBL31CM29</b>	 30A 125V, 2P 3W Twist-Lock
20A 125V, 2P 3W Twist-Lock		<b>HBL21CM28</b>	 15A 125V, 2P 3W Straight Blade
15 or 20A 125V, 2P 3W Straight Blade		<b>HBL21CM29</b>	 20A 125V, 2P 3W Twist-Lock

Note: See pages Y-28 and Y-29 for photographs and descriptions.  
\*Provides GFCI protection.



HBL21CM28



HBL21CM29



HBL31CM28



HBL31CM29



HBL61CM22



HBL61CM25



HBL61CM54



HBL61CM55

## Molded Straight Adapters

Description	Catalog Number
Permits use of 20A 125V Twist-Lock® locking type plug with 15 or 20A 125V straight blade receptacle. IP20 SUITABILITY.	HBL21CM28*
Permits use of 15A or 20A 125V straight blade plug with 20A 125V Twist-Lock locking type receptacle. IP20 SUITABILITY.	HBL21CM29*
Permits use of 30A 125V Twist-Lock locking type plug with 30A 125V Twist-Lock locking type receptacle. IP20 SUITABILITY.	HBL31CM28
Permits use of 15A or 20A 125V straight blade plug with 15 or 20A 125V straight blade receptacle. IP20 SUITABILITY.	HBL31CM29
Permits use of 30A 125V cable set, HBL61CM08, with 15 or 20A 125V straight blade receptacle. Anchor locking screw on plug when screwed down resists pullout of the cable set. IP55 SUITABILITY (CONNECTOR).	HBL61CM22
Same as HBL61CM22, except white.	HBL61CM22W
Permits use of 30A 125V cable set, HBL61CM08, with 20A 125V Twist-Lock receptacle, HBL23CM10. IP55 SUITABILITY (CONNECTOR).	HBL61CM25
Permits use of 50A 125V cable set, HBL61CM53, with 15 or 20A 125V straight blade receptacle. IP55 SUITABILITY (CONNECTOR).	HBL61CM54
Permits use of 30A 125V cable set, HBL61CM08, with 50A 125V Twist-Lock receptacle, HBL63CM70. IP55 SUITABILITY (CONNECTOR).	HBL61CM55
Permits use of 50A 125V cable set, HBL61CM53, with 30A 125V Twist-Lock receptacle, HBL26CM10. IP55 SUITABILITY (CONNECTOR).	HBL61CM56
Permits use of 50A 125/250V Twist-Lock locking type cable set, HBL61CM52, with 50A 125/250V crow foot straight blade receptacle HBL7962. IP55 SUITABILITY (CONNECTOR).	HBL61CM59
Permits use of 30A 125V cable set, HBL61CM08, with 50A 125/250V Twist-Lock receptacle, HBL63CM69. IP55 SUITABILITY (CONNECTOR).	HBL61CM71▲
Permits use of 50A 125V cable set, HBL61CM53, with 50A 125/250V Twist-Lock receptacle, HBL63CM69. IP55 SUITABILITY (CONNECTOR).	HBL61CM72▲
Permits use of 15A 125V 3 wire straight blade plug with 15 or 20A 125V 2 wire straight blade receptacle. IP55 SUITABILITY (CONNECTOR).	HBL5273L*
Permits a 100A 125/250V cable set to plug into a single 50A 125/250V outlet. IP55 SUITABILITY (CONNECTOR).	HBL61CM100
Permits use of 15A straight blade plug with 30A 125V Twist-Lock receptacle; with GFCI protection. IP55 SUITABILITY (PLUG).	HBL105GF

Note: \*UL Listed.

▲ The male plug end (50A 125/250V) has a blade removed and the blade slot filled with epoxy. Omitting the blade ensures achieving 125V safely. Adapters do not provide overcurrent protection. Adapters do not provide GFCI protection except HBL105GF.



HBL61CM59



HBL105GF



HBL61CM71▲



HBL61CM56



HBL61CM72▲



HBL61CM100

# Marine Products

## Molded Y Adapters

### Molded Y Adapters

Description	Catalog Number
Permits use of two 30A 125V cable sets, HBL61CM08, with one 50A 125/250V receptacle, HBL63CM69. IP55 SUITABILITY (CONNECTORS).	<b>HBL64CM54</b>
Permits use of two 50A 125V cables sets, HBL61CM53, with one 50A 125/250V receptacle, HBL63CM69. IP55 SUITABILITY (CONNECTORS).	<b>HBL64CM55</b>
Permits use of two 30A 125V cable sets, HBL61CM08, with one 30A 125V receptacle, HBL26CM10. IP55 SUITABILITY (CONNECTORS).	<b>HBL64CM56</b>
Permits use of two 30A 125V cable sets, HBL61CM08, with one 50A 125V receptacle, HBL63CM70. IP55 SUITABILITY (CONNECTORS).	<b>HBL64CM57</b>
Permits use of two 30A 125V cable sets, HBL61CM08, with one 50A 125/250V crow-foot straight receptacle, HBL7962. IP55 SUITABILITY (CONNECTORS).	<b>HBL64CM59</b>

*Note: The adapters shown on this page are not UL Listed because of the nature of adapters with their variety of ratings. Adapters do not provide overcurrent protection. Adapters do not provide GFCI protection except HBL105GF.*



HBL64CM54



HBL64CM55



HBL64CM56



HBL64CM57



HBL64CM59

Ship-to-Shore Devices



HBLPHTVNM

Telephone and Cable TV Ship-to-Shore Devices

Description	Catalog Number
Stylized non-metallic inlet provides telephone and cable TV connections in one unit. UV resistant white Centrex® cover makes unit weatherproof when completely closed. Mounting holes are 2.38 in. (60.3) on centers and match existing mounting patterns. Mounting screws and gasket provided. IP55 SUITABILITY.	HBLPHTVNM
Traditional stainless steel inlet provides connections for telephone and cable TV in one unit. Connections can be used individually or together. Gasketed cover is self-closing so interior is shielded from the elements when not in use. Watertight when cover is screwed in place. Mounting holes are 2.38 in. (60.3) on centers. Mounting screws and gasket included. IP56 SUITABILITY.	HBLPHTVSS
Same as HBLPHTVSS above except no phone.	HBLTVSS
Replacement int. for PH6594TV and HBLPHTVSS series inlets.	CR16914
Black locking type plug for telephone cable sets or adapters.	PH6625
Black locking type connector body used on telephone cable sets or adapters.	PH6624
Yellow Seal-Tite® cover for weatherproofing PH6624 connector body on cable sets when connecting to an inlet and for weather-proofing PH6625 plug. IP20 SUITABILITY.	PH7440
Yellow Seal-Tite cover for weatherproofing PH6624 connector body when used on extension cords or adapters. IP55 SUITABILITY.	PH7499
Factory pre-wired 50 ft. (15.2m) telephone cable set. Uses 3 conductor, #16 AWG type SJTO, yellow vinyl cord for marine and recreational vehicle applications. IP20 SUITABILITY.	PH6599
Same as PH6599 except white.	PH6599W
Same as PH6599 except 25 ft. (7.6m) in length.	PH6598
Same as PH6598 except white.	PH6598W



HBLPHTVSS



HBLTVSS



PH6625



PH6624



PH7440



PH6599  
PH6599W  
PH6598  
PH6598W

Centrex® is a registered trademark of LANXESS Corporation.

Ship-to-Shore Devices

Telephone and Cable TV Ship-to-Shore Devices

Description	Catalog Number
Black polycarbonate combination telephone/TV outlet with spring-loaded weatherproof lift cover. Can be wired for telephone service only or for telephone and MATV/CATV services in one FS/FD box in both marinas and RV parks. Can be padlocked to prevent unauthorized use. IP44 SUITABILITY	PH6597TV
Black polycarbonate cable TV outlet has coax connector and gasketed, spring-loaded lift cover for weatherproofing. Designed for mounting to FS/FD type weatherproof boxes (like PH6619) in both marinas and RV parks. IP20 SUITABILITY.	TV97
Black polycarbonate telephone outlet has gasketed, spring-loaded lift cover for weatherproofing. Designed for mounting to FS/FD type weatherproof boxes (like PH6619) in both marinas and RV parks. IP20 SUITABILITY.	PH6597
Black polycarbonate telephone outlet has gasketed, spring-loaded lift cover for weatherproofing. Can be used to retrofit old style telephone outlets of Pauluhn Manufacturing Company (2833 and 2843) in both marinas and RV parks. IP20 SUITABILITY.	PH6596
Black polycarbonate RV inlet for telephone connection only. Has spring-loaded, gasketed weatherproof lift cover designed for mounting to FS/FD type weatherproof boxes. IP20 SUITABILITY.	PH6595
Black non-metallic FS box with 3/4 in. threaded hubs used for mounting phone and TV outlets and PH6595 recreational vehicle inlet (see PH6621 for mounting box on recreational vehicle). Cord connector included for strain relief and to maintain watertight integrity of box when cable is used. PVC adapter also included for connection of PVC conduit to box.	PH6619
Stainless steel bracket for mounting PH6619 FS box to recreational vehicles when used with PH6595 inlet.	PH6621
50 ft. (15.2m) yellow jacketed ship-to-shore TV cable set is the industry standard 75 Ohm, RG59-U with male plugs on both ends. Adapter included for a quick, slip-on connection to inlet on boat.	TV99
Same as TV99 except white.	TV99W
Same as TV99 except 25 ft. (7.6m) in length.	TV98
Same as TV98 except white.	TV98W



PH6597TV



TV97



PH6597



PH6596



PH6595



PH6619



TV99  
TV99W  
TV98  
TV98W



HBL328DCR

### Electric Fishing Reel Devices

Hubbell has a DC rated electrical system designed specifically for larger electric fishing reel systems.

Up until now, larger electric fishing reel systems typically utilized conventional 30 Amp AC rated devices since an appropriately rated DC system was not available.

The system features a corrosion resistant plug, connector body and receptacle and can be used along with a Hubbell outlet box and weatherproof cover plate to complete the installation. These devices are all rated at 28 Volt DC and are applicable for all 12, 24 and 32 Volt DC fishing reel systems. The devices are UL listed and CSA certified. All devices are made of high-visibility yellow nylon that is impact resistant and UV stabilized for longer life. Also, the contacts are nickel plated for corrosion resistance.



HBL328DCP

### Electric Fishing Reel Devices

Description	Catalog Number
Yellow locking single receptacle with abuse-resistant face. Can be mounted in Hubbell box HBL6080 and used with HBL74CM25WOA weatherproof plate.	<b>HBL328DCR</b>
Yellow locking plug has rugged nylon housing and rear dust seal to keep dust and foreign matter out.	<b>HBL328DCP</b>
Yellow locking connector body has rugged, nylon housing and rear dust seal to keep dust and foreign matter out.	<b>HBL328DCC</b>



HBL328DCC

### Accessories

Description	Catalog Number
Black phenolic type FD (deep) weatherproof box has two 3/4 in. (19.1) I.P.S. molded-in knockouts. 4.56 in. H x 2.94 in. W x 3.25 in. D (115.9 x 74.6 x 82.6) and has 22 cubic inch capacity.	<b>HBL6080</b>
Spring-loaded lift cover, for weatherproofing HBL328DCR outlet. Yellow in color.	<b>HBL74CM25WOA</b>
Same as HBL74CM25WOAW except white in color.	<b>HBL74CM25WOAW</b>
Same as HBL74CM25WOAW except gray in color.	<b>HBL7425WOA</b>



HBL6080



HBL74CM25WOA



# Marine Products

## 12 Volt DC Rated Switches

Panel Mount Toggle and Rocker Switches

### KEY CHART



M11SP

#### 1. Toggle switch

Fits panels up to 1/4 in. thick when not using the back-up nut provided; fits panels up to 3/16 in. thick when using the back-up nut. Requires a 1/2 in. mounting hole.



M11LRGSP

#### 2. Lighted toggle switch

Built-in pilot light (R=red, G=green) for night vision. Same panel specs as 1.



M11LTR

#### 3. Lighted-tip toggle switch

Red pilot light visible in tip of toggle only. Same panel specs as 1.



MR11SP

#### 4. Rocker switch

Requires a 1 1/2 in. high x 7/8 in. wide rectangular opening.



MR123LRSP

#### 5. Lighted rocker switch

Built-in pilot light for night vision. Same panel specs as 4.

### Panel Mount Toggle and Rocker Switches

Description	Typical Applications	Key	Catalog Number
Single pole, single throw On/Off.	Lights, bilge blower, bilge pump(s), accessories	1	M11SP
		2	M11LRSP
		2	M11LRGSP
		3	M11LTR
		4	MR11SP
Single pole, single throw. On/Off/On.	Horn, starter, winches, gauges	5	MR11LRSP
			M11MSP
			M11LTRM
			MR11MSP
			M123SP
Single pole, double throw. On/Off/On.	Bilge pumps, speed selector, lights, navigation lights		M123LTR
			MR123SP
			MR123LRSP
			M123MSP
Single pole, double throw. Momentary On/Off/On.	Bilge pumps	1	M123MSP
		4	MR123MSP
Single pole, double throw. Momentary On/Off/Momentary On.	Trim Tabs	1	M123MMSP
		4	MR123MMSP
Double pole, single throw. On/Off.	Lights, accessories	1	M21SP
		4	MR21SP
Double pole, double throw. On/Off/On.	Navigation lights, wipers, dual fuel tanks	1	M223SP
		4	MR223SP
		5	MR223LRSP
Double pole, double throw. On/Off/On (with jumper).	Navigation lights, windlass	1	M223JSP
Double pole, double throw. Momentary On/Off/Momentary On.	Winches, trim tabs, dual fuel tanks	1	M223MMSP
		4	MR223MMSP
Black silicone rubber boot bonded to brass nut.	Provides positive seal against moisture, oil, etc. Fits any non-lighted toggle switch.		MSB1
Push-button horn switch with 1 5/32 in. long nickel plated brass mounting stem. Terminals are .25 in. spade.	For remote operation of horn.		MH11
Black push-button (horn) boot.	Fits MH11 horn switch.		MHB11



M11SP



M123SP



M21SP



M223SP



MSB1



MH11



MHB11



### 15A 125V AC Twist-Lock® Devices

Description	Catalog Number
Yellow duplex receptacle has heat resistant body. IP20 suitability.	<b>HBL47CM00</b>
Yellow Valox® spring-loaded lift cover for weatherproofing duplex receptacles. Stainless steel screws and neoprene gasket included for mounting to FS/FD type weatherproof boxes. IP20 suitability.	<b>HBL52CM21</b>
Same as HBL52CM21 except white in color.	<b>HBL52CM21W</b>
Same as HBL52CM21 except gray in color.	<b>HBL5221</b>
Same as HBL52CM21 except for mounting to standard boxes.	<b>HBL52CM22</b>
Same as HBL52CM22 except gray in color.	<b>HBL5222</b>
Yellow Insulgrip® plug has rugged nylon housing and detachable cord grip with range of .30-.69 in. (7.5-17.4) that utilizes a unique offset jaws arrangement to provide secure strain relief. IP20 suitability.	<b>HBL47CM20C</b>
Short yellow Seal-Tite® cover for weatherproofing HBL47CM20C Insulgrip plug when used with receptacles or connector bodies. Also can be used to weatherproof HBL47CM29C Insulgrip connector body when used with HBL47CM16 flanged inlet. IP44 SUITABILITY.	<b>HBL60CM23+</b>
Yellow Insulgrip connector body has rugged nylon housing and detachable cord grip with range of .30-.69 in. (7.5-17.4) that utilizes a unique offset jaws arrangement to provide secure strain relief. IP20 suitability.	<b>HBL47CM29C</b>
Yellow Seal-Tite cover for weatherproofing HBL47CM29C Insulgrip connector body when used on extension cords and adapters. IP20 SUITABILITY.	<b>HBL60CM24+</b>
Panel mount flanged outlet has heat resistant melamine interior and stainless steel casing. IP20 SUITABILITY.	<b>HBL47CM15</b>
Panel mount flanged inlet has heat resistant melamine interior and stainless steel casing. IP20 SUITABILITY.	<b>HBL47CM16</b>
Three conductor, #14 AWG type STW, yellow PVC jacketed portable cord has jute fillers for added flexibility and is ideal for making cable sets, extension cords and adapters as it will not mark the boat's deck. Available in 250 ft. (76.2m) length only.	<b>YC314250</b>

*Note: +Boots are not UL Listed.*



HBL47CM00



HBL52CM21



HBL47CM20C



HBL60CM23



HBL47CM29C



HBL60CM24



HBL47CM15



HBL47CM16



YC314250

*Valox® is a trademark of SABIC Innovative Plastics, acquired from General Electric Company.*

# Marine Products

## 15 Ampere, 125 Volt AC Straight Blade Devices

2 Pole, 3 Wire



### 15A 125V AC Straight Blade Devices

Description	Catalog Number
Yellow corrosion resistant/weather resistant duplex receptacle. Use outdoors or where salt and other corrosive materials are a problem. Accepts 15A 125V, 2 pole 3 wire straight blade plugs. <b>IP20 SUITABILITY.</b>	<b>HBL52CM62</b>
Same as HBL52CM62 except ivory.	<b>HBL52CM62I</b>
Single version of HBL52CM62 duplex yellow receptacle. <b>IP20 SUITABILITY.</b>	<b>HBL52CM61</b>
Yellow Insulgrip® plug has rugged nylon housing and detachable cord grip with range of .23-.72 in. (5.8-18.3) that utilizes a unique offset jaws arrangement for secure strain relief. <b>IP20 suitability.</b>	<b>HBL52CM66C</b>
Yellow Seal-Tite® cover for weatherproofing straight blade Insulgrip plugs, HBL52CM66C and HBL53CM66C, when used with receptacles and connector bodies. Can also be used to weatherproof Insulgrip connector bodies when mating with flanged inlets. <b>IP44 SUITABILITY.</b> Not UL or CSA. Note: For Insulgrip® devices only.	<b>HBL60CM17+</b>
Yellow Insulgrip connector body has rugged nylon housing and detachable cord grip with range of .23-.72 in. (5.8-18.3) that utilizes a unique offset jaws arrangement for secure strain relief. <b>IP20 suitability.</b>	<b>HBL52CM69C</b>
Yellow Seal-Tite® cover for weatherproofing straight blade Insulgrip connector bodies, HBL52CM69C and HBL53CM69C, on extension cords and adapters. <b>IP55 SUITABILITY.</b> Not UL or CSA. Note: For Insulgrip devices only.	<b>HBL60CM18+</b>
Yellow Valise® plug has one-piece nylon housing that assembles easily with two screws. Built-in cord grip has range of .22-.66 in. (5.6-16.8). <b>IP20 suitability.</b>	<b>HBL52CM66V</b>
Yellow Valise® connector body has one-piece nylon housing that assembles easily with two screws. Built-in cord grip has range of .22-.66 in. (5.6-16.8). <b>IP20 suitability.</b>	<b>HBL52CM69V</b>
Yellow Insulgrip® plug with anchor locking screw to prevent accidental pull-out. The plug is "locked" into the receptacle when the screw is turned down so the head is flush with the plug surface. The cord grip range is .30-.69 in. (7.5-17.4). UL Recognized Component. <b>IP20 suitability.</b>	<b>HBL52CM80C</b>
Compact gray nylon panel mount inlet ideal for bass boat battery charging connection. Has gasketed spring-loaded lift cover for weatherproofing front and neoprene boot for weatherproofing rear. Will accept both 15A 125V and 20A 125V, 2 pole 3 wire straight blade connector bodies. <b>IP44 suitability.</b>	<b>HBL61CM64</b>
Same as HBL61CM64 except black in color.	<b>HBL61CM64BK</b>
Yellow Valox® spring-loaded lift cover for weatherproofing duplex receptacles. Stainless steel screws and neoprene gasket included for mounting to FS/FD type weatherproof boxes. <b>IP20 suitability.</b>	<b>HBL52CM21</b>
Same as HBL52CM21 except gray in color.	<b>HBL5221</b>
Same as HBL52CM21 except for mounting to standard boxes.	<b>HBL52CM22</b>
Same as HBL52CM22 except gray in color.	<b>HBL5222</b>
Yellow Valox spring-loaded lift cover for weatherproofing single straight blade receptacles. Stainless steel screws and neoprene gasket included. For mounting to FS/FD type weatherproof boxes. <b>IP44 SUITABILITY.</b>	<b>HBL74CM23WO</b>
Same as HBL74CM23WO except gray in color.	<b>HBL7423WO</b>

Note: +Boots are not UL Listed.  
See page Tech-10 for Weather Resistant descriptions.



HBL52CM62 HBL52CM61



HBL52CM66C



HBL52CM69C



HBL52CM80C



HBL52CM66V



HBL52CM69V



HBL74CM23WO



HBL61CM64

Rynite® is a registered trademark of E. I. DuPont.  
Valox® is a trademark of SABIC Innovative Plastics, acquired from General Electric Company.



### 20A 125V Twist-Lock® Devices

Description	Catalog Number
Yellow single receptacle has Rynite® body and abuse resistant nylon face. IP20 SUITABILITY.	<b>HBL23CM10</b>
Yellow polycarbonate spring-loaded lift cover for weather-proofing HBL23CM10 receptacle. Meets the most stringent requirements of UL's three listing categories for weatherproof plates. Stainless steel screws and neoprene gasket included for mounting to FS/FD type weatherproof boxes. IP44 SUITABILITY.	<b>HBL74CM25WOA</b>
Same as HBL74CM25WOA except gray in color.	<b>HBL7425WOA</b>
Same as HBL74CM25WOA except white in color.	<b>HBL74CM25WOAW</b>
Yellow Insulgrip® plug has rugged nylon housing and cord grip with range of .36-.93 in. (9-24) that utilizes a unique offset jaws arrangement to provide secure strain relief. IP20 SUITABILITY.	<b>HBL23CM11</b>
Yellow Seal-Tite® cover for weatherproofing HBL26CM11 or HBL23CM11 plugs. IP44 SUITABILITY. Note: Fits Insulgrip devices only.	<b>HBL60CM31+</b>
Same as HBL60CM31 except white in color.	<b>HBL60CM31W+</b>
Yellow Insulgrip connector body has rugged nylon housing and cord with range of .36-.93 in. (9-24) that utilizes a unique offset jaws arrangement to provide secure strain relief. IP20 SUITABILITY.	<b>HBL23CM13</b>
Yellow Seal-Tite cover for weatherproofing HBL26CM13 or HBL23CM13 connector bodies when used on extension cords or adapters. IP44 SUITABILITY. Note: Fits Insulgrip devices only.	<b>HBL60CM32+</b>
Yellow vinyl Seal-Tite cover for weatherproofing HBL23CM13V or HBL26CM13V connector bodies. IP44 SUITABILITY. Note: Fits Valise® devices only.	<b>HBL60CM32V+</b>
Yellow Valise plug has one-piece nylon housing, assembles easily with two screws. Built-in cord grip has range of .33-.72 in. (8.3-18.2). IP20 SUITABILITY.	<b>HBL23CM11V</b>
Yellow Seal-Tite cover for weatherproofing HBL23CM11V or HBL26CM11V plugs. IP44 SUITABILITY. Note: Fits Valise devices only.	<b>HBL60CM31V+</b>
Three conductor, #12 AWG type STW, yellow PVC jacketed portable cord with jute fillers for added flexibility. Ideal for making cable sets, extension cords and adapters as will not mark boat's deck. Available in 250 ft. (76.2m) length only.	<b>YC312250</b>

Note: +Boots are not UL Listed.

HBL23CM10



HBL74CM25WOA



HBL23CM11



HBL60CM31



HBL60CM32



HBL60CM32V



HBL23CM13



HBL60CM31V



YC312250



HBL23CM11V

Rynite® is a registered trademark of E. I. DuPont.

# Marine Products

## 20 Ampere, 125 Volt AC Straight Blade Devices

2 Pole 3 Wire



### 20A 125V AC Straight Blade Devices

Description	Catalog Number
Yellow corrosion resistant/weather resistant duplex receptacle. Use outdoors or where salt and other corrosive materials are a problem. Accepts both 20A 125V and 15A 125V, 2 pole 3 wire straight blade plugs. IP20 SUITABILITY.	HBL53CM62
Single version of HBL53CM62 duplex yellow receptacle. IP20 SUITABILITY.	HBL53CM61
Yellow Insulgrip® plug has rugged nylon housing and detachable cord grip with range of .23-.72 in. (5.8-18.3) that utilizes unique offset jaws arrangement to provide secure strain relief. IP20 SUITABILITY.	HBL53CM66C
Yellow Insulgrip connector body has rugged nylon housing and cord grip with range of .23-.72 in. (5.8-18.3) that utilizes unique offset jaws arrangement for secure strain relief. IP20 SUITABILITY.	HBL53CM69C
Yellow Seal-Tite cover for weatherproofing straight blade Insulgrip® plugs, HBL52CM66C and HBL53CM66C, when used to mate receptacles and connector bodies. Can also be used with Insulgrip connector bodies when mating with flanged inlets. IP44 SUITABILITY. Note: For Insulgrip devices only.	HBL60CM17+
Yellow Seal-Tite® cover for weatherproofing straight blade Insulgrip connector bodies, HBL52CM69C and HBL53CM69C, on extension cords and adapters. IP55 SUITABILITY. Note: For Insulgrip devices only.	HBL60CM18+
Yellow closure plug used with HBL60CM18 long Seal-Tite cover to prevent water from entering front of device when not in use. IP55 SUITABILITY.	HBL60CM19+
Compact gray nylon panel mount outlet ideal for electric trolling motors and reel applications. Features gasketed spring-loaded lift cover for weatherproofing front and neoprene boot for weatherproofing rear. Accepts both 20A 125V and 15A 125V, 2 pole 3 wire straight blade plugs. IP44 SUITABILITY.	HBL61CM65
Yellow polycarbonate spring-loaded lift cover for weatherproofing duplex receptacles. Stainless steel screws and neoprene gasket included for mounting to FS/FD type weatherproof boxes. IP20 SUITABILITY. Not CSA certified.	HBL52CM21
Same as HBL52CM21 except white in color.	HBL52CM21W
Same as HBL52CM21 except gray in color.	HBL5221
Same as HBL52CM21 except for mounting to standard boxes.	HBL52CM22
Same as HBL52CM22 except gray in color.	HBL5222
Yellow polycarbonate spring-loaded lift cover for weatherproofing single straight blade receptacles. Stainless steel screws and neoprene gasket included. For mounting to FS/FD type weatherproof boxes. IP44 SUITABILITY. Not CSA certified.	HBL74CM23WO
Same as HBL74CM23WO except gray in color.	HBL7423WO

Note: +Boots are not UL Listed.  
See page Tech-10 for Weather Resistant descriptions.



HBL53CM62 HBL53CM61



HBL53CM66C



HBL53CM69C



HBL52CM66V



HBL52CM69V



HBL52CM21



HBL52CM21W



HBL7423WO



HBL74CM23WO



HBL61CM65



HBL60CM17



HBL60CM18  
HBL60CM19

Rynite® is a registered trademark of E. I. DuPont.



GFP15M

### Portable Ground Fault Circuit Interrupters (GFCIs)

These UL Listed portable GFCIs have been designed to protect people from line-to-ground electrical shock hazards which may develop from faulty appliance, tools or defective portable cords. If a ground fault does occur and the leakage level exceeds 4 to 6 milliamperes, the GFCI unit quickly acts to protect the user by opening the circuit, thus interrupting the power supply and limiting the duration of any electrical current flow. After tripping, the module is reset by pushing a button on its face. A test button allows the user to test that the GFCI is in working order.

*Note: GFCI devices will not protect against overloads or short circuits.*



GFP315A

### Portable Ground Fault Circuit Interrupters and Testers

Description	Catalog Number
This unit is small and compact—measuring only 4.19 in. H x 5.19 in. L x 6.69 in. W (10.6cm x 13.2cm x 17.0cm) and weighing only 3 pounds—yet protects as many as four tools at one time. The housing is high-impact yellow polycarbonate as are the liftcovers which protect the receptacles from dirt and damage. Simply insert the plug on the end of the 6 foot (1.8m) cord into any 60Hz 120V receptacle and then plug the equipment to be used into one of the receptacles on the unit. Incorporates a 20 Amp GFCI module that can be replaced in the field. The module provides not only ground fault protection, but also contains the no voltage release feature.	<b>GFP15M</b>
3-outlet plug-in unit. Plugs into boat convenience receptacles to provide ground fault protection.	<b>GFP315A</b>
This unit is designed to measure the trip level of GFCI portables, receptacles, or breakers within any range from 2 to 7 milliamperes, or the leakage in portable tools or appliances within a leakage range of 1 to 7 milliamperes. It can be used on any AC circuit of 110 to 130V.	<b>GFT2G*</b>
This outlet circuit tester has a simple arrangement of neon lights which visually indicate correct wiring, reversed polarity, open ground wire, open neutral wire, open hot wire, hot and ground reversed and hot wire on neutral terminal, and hot terminal unwired. Simply plug the HBL5200 into a single phase 125V 2 pole 3 wire outlet and the combination of lighted and/or unlighted lamps will immediately indicate the condition of the circuit. The instructions and symbol identification are printed on durable polyester labels permanently attached to the tester. To test other 2 pole 3 wire single phase 125V outlets, use one of the proper adapters shown on pages Y-28 and Y-29.	<b>HBL5200**</b>

*Note: \*Not UL Listed or CSA Certified.  
 \*\*Not CSA Certified.*



GFT2G



HBL5200

### GFCI Line Cord Devices

Description	Line Cord Length	Catalog Number
Ideal for personal plug-in protection at marinas and onboard boats when used with pumps, drills, sanders and all portable electrical equipment. GFCI mechanism is watertight and approved for outdoor use. High visibility yellow SJTW-A power cord resists moisture, chemicals and sunlight. Two different lengths available.	6 ft. (1.8m)	<b>GFP6C15M</b>
	25 ft. (7.6m)	<b>GFP25C15M</b>

### GFCI Specifications

Rating:	15A 120V 60Hz 2 pole 3 wire straight blade
Trip Level:	4-6 milliamperes
Trip Time:	.025 seconds nominal
Frequency:	60 Hertz nominal
Voltage:	120 volts +10%, -15%
Max Interrupting Capacity:	2,000 amperes
Max Humidity:	95%
UL Class A	



GFP6C15M  
 GFP25C15M

# Marine Products GFCI and Surge Protection Receptacles

Inside the Boat



The American Boat and Yacht Council recommends the use of ground fault protected receptacles in a head, galley, machinery space or on a weather deck. Refer to ABYC "Ground Fault Protection".

## Ground Fault Circuit Interrupter (GFCI) Receptacles

These UL Listed receptacles have been designed to protect people from line-to-ground electrical shock hazards which may develop from faulty appliance, tools or defective portable cords. If a ground fault does occur and the leakage level exceeds 4 to 6 milliamperes, the GFCI unit quickly acts to protect the user by opening the circuit, thus interrupting the power supply and limiting the duration of any electrical current flow. After tripping, the receptacle is reset by pushing a button on its face. A test button allows the user to test that the GFCI is in working order.

*Note: All Hubbell GFCI receptacles are in compliance with new UL 943 Mandate. GFCI receptacles will not protect against overloads or short circuits. Due to 2006 UL 943 revisions, Hubbell Marine Ground Fault Receptacles now come with an LED that will flash if the receptacle is no longer capable of providing GFCI protection. This can occur due to power surges and/or lightning in the area. The new design will also prevent power going to the face when mis-wired.*

Hubbell's GFCI receptacles can be mounted on any standard 2.50 inch (63.5) deep box. A feed-thru feature provides protection not only at that receptacle but also at any other receptacle located downstream from it on the same circuit. These devices meet the requirements of The National Electric Code (NEC) and American Boat and Yacht Council Standard and will accept locking fork terminals. Ground Fault Receptacles are also available for OEM applications.

**Caution: Ground Fault Receptacles should not be mounted in locations exposed to salt spray nor in the engine room. For GFCI protection of such locations, downstream feeding from an internally located Ground Fault Receptacle is recommended.**

Description	Color	Catalog Number
15A 125V brown GFCI duplex receptacle. Nylon wallplate included.	Brown	<b>GFR5252MA</b>
	Gray Ivory	<b>GFR5252MGYA</b>
	White	<b>GFR5252MIA</b>
		<b>GFR5252MWA</b>
PVC weatherproof lift cover for ground fault receptacles (such as GFR5252M series) and Style Line® receptacles. For vertical mounting in standard or FS/FD type boxes.	Gray	<b>CWP26CR</b>
	White	<b>CWP26CRW</b>



GFR5252MWA



CWP26CR

## Surge Suppression Receptacle

Surge suppression receptacles 15A 125V AC Nominal. UL Listed at 600V voltage protection level. Suitable for ANSI/IEEE C 62.41-installation categories "A" (outlets and long branch circuits) and "B" (major feeders and short branch circuits). The Hubbell Surge Suppression Receptacle helps protect your electronic equipment from damage caused by transient voltages. The receptacle contains metal oxide varistors which dissipate the electrical energy of voltage spikes without interfering with normal operations.

Description	Color	Catalog Number
duplex surge suppression receptacle with power on indicator light and damage-alert alarm beeper.	Ivory	<b>HBL5262ISA</b>



HBL5262ISA

## USB Charger Tamper-Resistant Duplex Receptacle

Hubbell's USB Charger Receptacle provides both USB and AC electrical power in a standard single gang electrical opening. Designed to provide more charging options for personal electronics.

Charge Devices Simultaneously!

- Tablets
- Smartphones
- MP3 players
- Apple® iPad®
- Apple® iPod®
- Apple® iPhone®

Description	Color	Catalog Number
15A 125V AC USB Charger Tamper-Resistant receptacle, Two USB Type 2.0 ports 3 Amp, 5 Volt DC, 15 or 20 Amp, 125 Volt AC decorator duplex	Black	<b>USB15X2BK</b>
	Brown	<b>USB15X2</b>
	Gray	<b>USB15X2GY</b>
	Ivory	<b>USB15X2I</b>
	Light Almond	<b>USB15X2LA</b>
	White	<b>USB15X2W</b>



USB15X2W

*Note: See page Tech-10 for Tamper-Resistant descriptions.*

Apple, iPad, iPod and iPhone are registered trademarks of Apple, inc.

## Style Line® Decorator Receptacles

- High-impact nylon face resists breaking, chipping and cracking.
- Will accept locking fork terminal to comply with ABYC standards.
- Available in 4 colors for any decor with matching wall plates.
- Smooth, high-gloss finish for rich appearance.



DR15ITR



DR15GRYWRTR

### Commercial Style Line® Decorator Series



Description	Color	Standard Duplex	Duplex, Tamper-Resistant	Duplex, Weather and Tamper-Resistant
15A 125V duplex receptacle.	Almond	DR15AL	DR15ALTR	-
	Black	DR15BLK	DR15BLKTR	DR15BLKWRTR
	Brown	DR15	DR15TR	DR15WRTR
	Gray	DR15GRY	DR15GRYTR	DR15GRYWRTR
	Ivory	DR15I	DR15ITR	DR15IWRTR
	Light Almond	DR15LA	DR15LATR	DR15LAWRTR
	White	DR15WHI	DR15WHITR	DR15WHIWRTR



CR15TR



BR15IWRTR

### Commercial Series



Description	Color	Standard Duplex, Spec. Grade, Side Wired	Duplex, Tamper-Resistant	Duplex, Weather and Tamper-Resistant, Back and Side Wired
15A 125V duplex receptacle.	Almond	CR15AL	CR15ALTR	-
	Black	CR15BLK	CR15BLKTR	BR15BLKWRTR
	Brown	CR15	CR15TR	BR15WRTR
	Gray	CR15GRY	CR15GRYTR	BR15GRYWRTR
	Ivory	CR15I	CR15ITR	BR15IWRTR
	Light Almond	CR15LA	CR15LATR	BR15LAWRTR
	White	CR15WHI	CR15WHITR	BR15WHIWRTR

Note: All devices above will accept locking fork terminal to comply with ABYC standards.  
See page Tech-10 for Tamper and Weather Resistant descriptions.



HBL5251



HBL5361I

### Extra Heavy Duty Single Receptacles



Description	Color	Catalog Number
15A 125V single receptacle.	Brown	HBL5251
	Ivory	HBL5251I
20A 125V single receptacle.	Brown	HBL5361
	Ivory	HBL5361I

### Corrosion Resistant Receptacles



Description	Color	Catalog Number
15A 125V yellow corrosion resistant duplex receptacle. Use where salt or other corrosive elements are a problem.	Yellow	HBL52CM62
Same as HBL52CM62 except ivory.	Ivory	HBL52CM62I



HBL52CM62I



HBL8200ILI

### Special Application Illuminated Receptacle

Description	Color	Catalog Number
Illuminated receptacle 15A 125V grounding. A high quality receptacle with an illuminated face. Ideal for use in halls or as a gentle night light.	Ivory	HBL8200ILI

Note: See page Tech-10 for Weather Resistant descriptions.



# Marine Products Switches and Weatherproof Switch Plates

15 and 20 Ampere, 120-277V AC



## Commercial Series

Description	Toggle Color	Catalog Number
15A single-pole toggle switch for controlling AC load from one point.	Almond	CS115AL
	Black	CS115BK
	Brown	CS115
	Gray	CS115GY
	Ivory	CS115I
	Light Almond	CS115LA
	White	CS115W
15A three-way toggle switch for controlling AC load from two points.	Almond	CS315AL
	Black	CS315BK
	Brown	CS315
	Gray	CS315GY
	Ivory	CS315I
	Light Almond	CS315LA
	White	CS315W

Note: All devices above will accept locking fork terminal to comply with ABYC standards.



CS115I



HBL1221IL



HBL1221PL

## Special Application Series

Description	Catalog Number
20A 120V toggle switch with LED lamp set in ivory handle. Handle illuminates when switch is in "OFF" position.	HBL1221IL
20A 120V three-way toggle switch with LED illuminated ivory handle for controlling AC load from two points. Handle illuminates when "OFF".	HBL1223IL
20A 120V single-pole toggle switch with LED lamp set in clear red handle. Handle illuminates when switch is "ON". Serves as instant reminder that current is flowing to an appliance.	HBL1221PL
20A 120V three-way toggle switch with LED for controlling AC load from two points. Red handle illuminates when "ON".	HBL1223PL
Single-pole PresSwitch® for controlling AC load from one point. Switch activated brown button.	HBL1281
Same as HBL1281 except ivory button.	HBL1281I
Three-way PresSwitch® for controlling AC load from two points. Switch activated brown button.	HBL1283+
Same as HBL1283 except ivory button.	HBL1283I+
Yellow neoprene weatherproof plate for use only with PresSwitches. PresSwitch® button is activated when bubble is pressed. Not CSA certified.	HBL17CM50+
Clear silicone rubber weatherproof bubble plate for use with all AC toggle switches and PresSwitches. Also ideal for use with lighted handle toggle switches. Not CSA certified.	HBL1795

Note: +Not UL Listed.



HBL1281



HBL1283

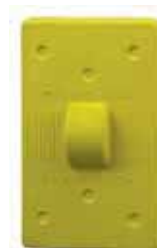

HBL17CM50



HBL1795

## Outlet Box

Description	Catalog Number
Plastic switch/receptacle box. Measures 3.281" x 2.188" x 2.50" (83.3 x 55.6 x 63.5) deep. For mounting in walls without studs. A support strap is provided which pulls box tightly against back side of wall. Not CSA.	HBL6079



HBL6079

- Nylon plates—virtually unbreakable.
- Rounded corners for stylish look.
- Reinforced ribs for extra strength.
- Screws are factory-inserted for fumble-free installation.

Description	Color	Smooth Nylon		Smooth Metal Material	Catalog Number
		Standard	Mid-Size		
 1-Gang, 1-Toggle	Black Brown Gray Ivory White	NP1BK NP1 NP1GY NP1I NP1W	NPJ1BK NPJ1 NPJ1GY NPJ1I NPJ1W	Brass Stainless Steel	SB1 SS1
 1-Gang, 1-Duplex	Black Brown Gray Ivory White	NP8BK NP8 NP8GY NP8I NP8W	NPJ8BK NPJ8 NPJ8GY NPJ8I NPJ8W	Brass Stainless Steel	SB8 SS8
 1-Gang, 1-Decorator	Black Brown Gray Ivory White	NP26BK NP26 NP26GY NP26I NP26W	NPJ26BK NPJ26 NPJ26GY NPJ26I NPJ26W	Brass Stainless Steel	SB26 SS26
 2-Gang, 2-Toggle	Black Brown Gray Ivory White	NP2BK NP2 NP2GY NP2I NP2W	NPJ2BK NPJ2 NPJ2GY NPJ2I NPJ2W	Brass Stainless Steel	SB2 SS2
 2-Gang, 2-Duplex	Black Brown Gray Ivory White	NP82BK NP82 NP82GY NP82I NP82W	NPJ82BK NPJ82 NPJ82GY NPJ82I NPJ82W	Brass Stainless Steel	SB82 SS82
 2-Gang, 2-Decorator	Black Brown Gray Ivory White	NP262BK NP262 NP262GY NP262I NP262W	NPJ262BK NPJ262 NPJ262GY NPJ262I NPJ262W	Brass Stainless Steel	SB262 SS262
 2-Gang, 1-Toggle, 1-Duplex	Black Brown Gray Ivory White	NP18BK NP18 NP18GY NP18I NP18W	NPJ18BK NPJ18 NPJ18GY NPJ18I NPJ18W	Brass Stainless Steel	SB18 SS18
 2-Gang, 1-Toggle, 1-Decorator	Black Brown Gray Ivory White	NP126BK NP126 NP126GY NP126I NP126W	NPJ126BK NPJ126 NPJ126GY NPJ126I NPJ126W	Brass Stainless Steel	SB126 SS126
 1-Gang, 1-Single 1.40" Dia. Hole	Black Brown Gray Ivory White	NP7BK NP7 NP7GY NP7I NP7W	NPJ7BK NPJ7 NPJ7GY NPJ7I NPJ7W	Brass Stainless Steel	SB7 SS7
 1-Gang, 1-Blank, Box Mount	Black Brown Gray Ivory White	NP13BK NP13 NP13GY NP13I NP13W	NPJ13BK NPJ13 NPJ13GY NPJ13I NPJ13W	Brass Stainless Steel	SB13 SS13

**Hubbell Now Offers The Ability To Put 2 or 3 Communication Devices In a Single, Style Line® Plate**

Any combination of phone (6-position jack), cable TV (F-type connector) and Category 5e modular data jacks can be assembled onto a 2-port or 3-port frame—each sold individually so you can customize them as needed. Or the highly popular phone and cable TV combination is available with the frame and matching wallplate under a single catalog number, in all the popular colors.

Finally—a single communications plate that can take the place of 2 or 3 plates—available from a company you can trust for superior quality.

Hubbell’s Marine communication frames and connectors deliver high quality data and multimedia transmission to the point of connection. Hubbell’s 2 and 3 port Style Line frames and leading edge connections allow for customized configurations. Install Hubbell’s Marine communication offering and be assured a reliable connection.

**2 Port Communication Frame, Fully Loaded (6-Position Phone Jack, F-Type Cable TV Jack and Style Line® Plate Included)**

Color	No. of Ports	Connection Type	Catalog Number
Ivory	2	USOC, F-Type	<b>NS783I</b>
White	2	USOC, F-Type	<b>NS783W</b>



NS783I

**Style Line® Frames, 2 Port and 3 Port Unloaded**

Color	No. of Ports	Connection Type	Catalog Number
Black	2	–	<b>NS612BK</b>
Gray	2	–	<b>NS612GY</b>
Ivory	2	–	<b>NS612I</b>
White	2	–	<b>NS612W</b>
Black	3	–	<b>NS613BK</b>
Gray	3	–	<b>NS613GY</b>
Ivory	3	–	<b>NS613I</b>
White	3	–	<b>NS613W</b>



NS612I

NS613I

**Category 6 Modular Keystone Jacks**

Color	Wiring	No. Positions	Catalog Number
Black	T568A/T568B	8-Positions	<b>NSJ6BK</b>
Gray	T568A/T568B	8-Positions	<b>NSJ6GY</b>
Ivory	T568A/T568B	8-Positions	<b>NSJ6I</b>
White	T568A/T568B	8-Positions	<b>NSJ6W</b>



NSJ6W

NSJ5EW

**Category 5e Modular Keystone Jacks**

Color	Wiring	No. Positions	Catalog Number
Black	T568A/T568B	8-Positions	<b>NSJ5EBK</b>
Gray	T568A/T568B	8-Positions	<b>NSJ5EGY</b>
Ivory	T568A/T568B	8-Positions	<b>NSJ5EI</b>
White	T568A/T568B	8-Positions	<b>NSJ5EW</b>



NSJ5EW

NSJ5EI

**USOC Modular Keystone Jacks**

Color	Wiring	No. Positions	Catalog Number
Black	USOC	6-Positions	<b>NSJUBK</b>
Gray	USOC	6-Positions	<b>NSJUGY</b>
Ivory	USOC	6-Positions	<b>NSJUI</b>
White	USOC	6-Positions	<b>NSJUW</b>



NSJUI

NSJUGY

**F-Type Connector Keystone**

Color	Catalog Number
Black	<b>SFFGBK</b>
Gray	<b>SFFGGY</b>
Ivory	<b>SFFGEI</b>
White	<b>SFFGW</b>



SFFGEI

**IP66**  
 SUITABILITY

**1-Gang Weatherproof Covers for Vertical Mounting**

Description	Dimensions		Catalog Number
	Height x Width x Depth		
Thermoplastic, gray, duplex, GFCI, toggle and single receptacles, diameter 1.34", 1.40", 1.60", 1.72", 2.03" and 2.15"	5.8" x 3.5" x 2.8" (147.3 x 88.9 x 71.1)		<b>RW57300</b>



RW57300

Thermoplastic, gray, extra deep, duplex, GFCI, toggle and single receptacles, diameter 1.34", 1.40", 1.60", 1.72", 2.03" and 2.15"	5.8" x 3.5" x 4.8" (147.3 x 88.9 x 121.9)		<b>RW57350</b>
--	--	--	----------------



RW57350

**1-Gang Weatherproof Covers for Horizontal Mounting**

Description	Dimensions		Catalog Number
	Height x Width x Depth		
Thermoplastic, gray, duplex, GFCI, toggle and single receptacles, diameter 1.34", 1.40", 1.60", 1.72", 2.03" and 2.15"	4.0" x 5.2" x 2.8" (101.6 x 132.1 x 71.1)		<b>RW57400</b>



RW57400

**2-Gang Weatherproof Covers for Vertical Mounting**

Description	Dimensions		Catalog Number
	Height x Width x Depth		
Thermoplastic, gray, duplex, GFCI, toggle and single receptacles, diameter 1.34", 1.40", 1.60", 1.72", 2.03" and 2.15"	5.8" x 5.3" x 2.8" (147.3 x 134.6 x 71.1)		<b>RW57750</b>



RW57750

Thermoplastic, gray, duplex, GFCI, toggle and single receptacles, diameter 1.34", 1.40", 1.60", 1.72", 2.03" and 2.15"	5.8" x 5.3" x 4.8" (147.3 x 134.6 x 121.9)		<b>RW57900</b>
--	---	--	----------------



RW57900

Thermoplastic, gray, single receptacles, diameter 1.34", 1.40", 1.60", 1.72", 2.03" and 2.15"	5.8" x 5.3" x 4.8" (147.3 x 134.6 x 121.9)		<b>RW57950</b>
---	---	--	----------------



RW57950

*Note: Required by the NEC® for while-in-use outdoor power distribution. Thermoplastic covers provide protection for use in wet locations with the cover closed, NEMA® 3R rated. Meets NEC 406.8 – receptacles in damp or wet locations. Holes for padlocks are .40 inch.*

*NEC® is a registered trademark of the The National Electrical Code.  
 NEMA® is a registered trademark of The National Electrical Manufacturers Association.*

### Marine Grade Weatherproof Plates

Description	Catalog Number
Yellow Valox® spring-loaded lift cover for weatherproofing duplex receptacles. Stainless steel screws and neoprene gasket included for mounting to FS/FD type weatherproof boxes. <b>IP20 suitability.</b>	<b>HBL52CM21</b>
Same as HBL52CM21 except white in color.	<b>HBL52CM21W</b>
Same as HBL52CM21 except gray in color.	<b>HBL5221</b>
Same as HBL52CM21 except for mounting to standard boxes.	<b>HBL52CM22</b>
Same as HBL52CM22 except gray in color.	<b>HBL5222</b>
Yellow Valox spring-loaded lift cover for weatherproofing single straight blade receptacles. Stainless steel screws and neoprene gasket included. For mounting to FS/FD type weatherproof boxes. <b>IP44 suitability.</b>	<b>HBL74CM23WO</b>
Same as HBL74CM23WO except gray in color.	<b>HBL7423WO</b>
Yellow Valox spring-loaded lift cover for weatherproofing old style 26CM10 receptacle. Meets the most stringent requirements of UL's three listing categories for weatherproof plates. Stainless steel screws and neoprene gasket included for mounting to FS/FD type weatherproof boxes. <b>IP44 suitability.</b>	<b>HBL74CM24WO</b>
Same as HBL74CM24WO except gray in color.	<b>HBL7424WO</b>
Yellow Valox spring-loaded lift cover for weatherproofing HBL26CM10 receptacle. Meets the most stringent requirements of UL's three listing categories for weatherproof plates. Stainless steel screws and neoprene gasket included for mounting to FS/FD type weatherproof boxes. <b>IP44 suitability.</b>	<b>HBL74CM25WOA</b>
Same as HBL74CM25WOA except white in color.	<b>HBL74CM25WOAW</b>
Same as HBL74CM25WOA except gray in color.	<b>HBL7425WOA</b>
Yellow Valox lift cover for weatherproofing 50A receptacles. Meets requirements of the most stringent of UL's three listing categories for weatherproof plates. Stainless steel screws and a neoprene gasket included. For mounting to FS/FD type weatherproof boxes. <b>IP44 suitability.</b>	<b>HBL77CM74WO</b>
Same as HBL77CM74WO except gray in color.	<b>HBL7774WO</b>



HBL52CM21



HBL74CM23WO



HBL77CM74WO



CWP1CR



CWP8CR



CWP26CR

### Commercial Grade Weatherproof Plates

Available in a host of configurations— Twist-Lock® and straight blade receptacles in single or duplex as well as switches—these plates are perfect for marine use. The PVC resists deterioration over time and has high tensile and impact strength. Each plate comes with a tightly sealing, rubberized gasket and a super strong lift cover spring.

Description	Catalog Number
Gray PVC weatherproof lift cover for toggle switches (such as CS115).For vertical mounting in standard or FS/FD type boxes.	<b>CWP1CR</b>
Gray PVC weatherproof lift cover for duplex receptacles (such as HBL52CM62). For vertical mounting in standard or FS/FD type boxes.	<b>CWP8CR</b>
Gray PVC weatherproof lift cover for ground fault receptacles (such as GF5252MGYA) and Style Line® receptacles. For vertical mounting in standard or FS/FD type boxes.	<b>CWP26CR</b>
Same as CWP26CR except white in color.	<b>CWP26CRW</b>

Valox® is a trademark of SABIC Innovative Plastics, acquired from General Electric Company.



HBL6080



HBL60CM83



HBL60CM84



HBL6080OS



HBL6087



HBL60CM88



PH6619



HBL6081



HBL6082

### Marine Grade Dockside Boxes and Covers

Description	Catalog Number
Black phenolic type FD (deep) weatherproof box has two ¼ in. (19.1) I.P.S. molded-in knockouts. 4.56 in. H x 2.94 in. W x 3.25 in. D (115.9H x 74.6W x 82.6D) and has 22 cubic inch capacity.	HBL6080
Yellow fiberglass type FD (deep) weatherproof box has two ¼ in. (19.1) I.P.S. molded-in knockouts. 4.56 in. H x 2.94 in. W x 3.25 in. D (115.9H x 74.6W x 82.6D) and has 22 cubic inch capacity.	HBL60CM83
Yellow fiberglass type FD box same as HBL60CM83 - except has two 1.0 inch (25.4) I.P.S. molded-in knockouts.	HBL60CM84
Black phenolic type FS (shallow) weatherproof box has two ¼ in. (19.1) I.P.S. molded-in knockouts. 4.56 in. H x 2.94 in. W x 2.19 in. D (115.9H x 74.6W x 55.6D) and has 16 cubic inch capacity.	HBL6080OS
Black non-metallic FS box with ¼ in. threaded hubs used for mounting phone and TV outlets and PH6595 recreational vehicle inlet (see PH6621 for mounting box on recreational vehicle). Cord connector included for strain relief and to maintain watertight integrity of box when cable is used. PVC adapter also included for connection of PVC conduit to box.	PH6619
Black phenolic junction box with four ¼ in. (19.1) I.P.S. molded-in knock-outs. Has 4.13 in. (104.8) diameter and is 1.88 in. (47.6) deep.	HBL6081
Phenolic blank cover, ¼ in. (6.4) thick, for HBL6081 box.	HBL6082
Black phenolic blank cover plate for HBL6080OS.	HBL6087
Yellow Valox® blank cover plate for use with FS and FD type boxes.	HBL60CM88

Valox® is a trademark of SABIC Innovative Plastics, acquired from General Electric Company.

### Non-Metallic Vapor-tight Incandescent Fixtures

These non-metallic, vapor-tight incandescent fixtures offer long life and trouble-free lighting in wet locations in marinas and on boats. Some features of these new units are:

- UV resistant, gray, glass filled thermoplastic polyester box, mounting adapters and globe guards resists abuse and harmful effects of the elements.
- Excellent temperature operating range of -40°F (-40°C) to +302°F (150°) for use in areas with wide temperature variations or extreme ambient temperatures.
- High temperature silicone gasketing maintains integrity and molded threads for ease of installation/removal.
- Heat resistant glass globe withstands thermal shock in wet locations and has thread type mounting to assure weathertight sealing.
- High strength protective globe guard helps prevent accidental globe and lamp breakage.
- Accommodates Type A incandescent lamps up to 150 watts.
- UL 1598 Standard for luminaries.
- UL 1598A Marine type luminaries.



NVX15GHGA



NVA15GHGA



NVBA

### Lighting and Lighting Fixtures

Description	Catalog Number
Ceiling mount non-metallic, vapor-tight incandescent luminaries including the fixture, mounting box, guard and heat resistant glass globe. Accepts up to 150 watt Type A incandescent lamp (not included).	NVX15GHGA
Pendant mount non-metallic, vapor-tight incandescent luminaries including fixture, mounting cap, guard and heat resistant glass globe. Accepts up to 150 watt Type A incandescent lamp (not included).	NVA15GHGA
Wall mount bracket only to adapt NVX15GHGA ceiling mount fixture to a wall mount fixture. Order NVBA and NVX15GHGA to get wall mount fixture.	NVBA
Replacement guard to NVX15GHGA and NVA15GHGA.	NVGA
Heat resistant replacement globe for NVX15GHGA and NVA15GHGA. Made of tempered glass.	VCGP100

### Nylon Watertight Strain Relief Cord Connectors

These Hubbell nylon cord connectors provide strain relief and a watertight seal where cable enters a piece of equipment, panel, or box. A patented GOTCHA® ring, with a split and hinge design, allows for better adjustment to the cord as the connector nut is tightened, providing superior cord gripping compared to other types. A soft neoprene bushing compresses to keep liquids out and allows the nut to be easily tightened.

Description	Catalog Number
A gray male PVC adapter with ¼ in. NPT pipe thread for adapting PVC conduit to FS and FD boxes with ¼ in. NPT hub (HBL6080, HBL6080OS, HBL60CM83). Not UL Listed.	HBL6085
Straight nylon cord connector, ½ in. NPT hub size, diameter range .25-.38 in. (6.4-9.5).	HBL10CM22S
Straight nylon cord connector, ½ in. NPT hub size, diameter range .38-.50 in. (9.5-12.7).	HBL10CM23S
Straight nylon cord connector, ¾ in. NPT hub size, diameter range .38-.50 in. (9.5-12.7).	HBL10CM35S
Straight nylon cord connector, ¾ in. NPT hub size, diameter range .50-.63 in. (12.7-15.9).	HBL10CM36S
Straight nylon cord connector, ¾" NPT hub size, diameter range .63-.75 in. (15.9-19.1).	HBL10CM37S
Straight nylon cord connector, 1.0 in. NPT hub size, diameter range .63-.75 in. (15.9-19.1).	HBL10CM41S



VCGP100



HBL6085



HBL10CM22S

## Codes and Specifications

ABYC Standard, July 2012, E-11 Excerpts.

**11.4 DEFINITIONS** – For the purposes of this standard, the following definitions apply.

**11.4.11 Equipment Leakage Circuit Interrupter (ELCI)** - A residual current device which detects equipment ground fault leakage current and disconnects all ungrounded (110V and 240V) and grounded (110V neutral) current carrying conductors from the supply source at a preset trip threshold.

**11.4.14 Ground fault circuit interrupter (GFCI)** - A device intended for the protection of personnel that functions to de-energize a circuit, or portion thereof, within an established period of time when a current to ground exceeds some predetermined value that is less than that required to operate the overcurrent protective device of the supply circuit.

**11.4.33 Watertight** - Constructed so that water will not enter the enclosure under the test conditions specified in NEMA Standard 250, Type 6P or IEC Standard 60529 Type IP67.

**11.4.34 Weatherproof** - Constructed or protected so that exposure to the weather will not interfere with successful operation under the test conditions specified in NEMA Standard 250, Type 3 or IEC Standard 60529 Type IP54.

### 11.11 GROUND FAULT PROTECTION — AC SYSTEMS

**11.11.1** An Equipment Leakage Circuit Interrupter (ELCI) shall be installed with or in addition to the main shore power disconnect circuit breaker(s) or at the additional overcurrent protection as required by E-11.10.2.8.3 whichever is closer to the shore power connection.

**11.11.1.1** Trip level shall be a maximum of 30mA. The trip time shall be a maximum of 100ms.

**11.11.1.4** The ELCI shall be readily accessible.

*Note: A ground fault circuit interrupter (GFCI) may be used on single phase AC circuits to provide additional protection for personnel and equipment.*

**11.11.5** GFCI receptacle devices shall meet the requirements of Underwriters Laboratories' standard UL 943, Ground Fault Circuit Interrupters, and the requirements of UL 498, Electrical Attachment Plugs and Receptacles.

*Note: GFCI receptacle devices may be installed as part of a convenience outlet installation either in single outlet applications or in multiple feed through installations. (See E-11.13.3.5)*

### 11.12 SWITCHES

**11.12.1.1** Switches shall have voltage ratings not less than the system voltage, current ratings not less than the connected load, and shall be rated for the type of load, i.e., inductive or resistive.

**11.12.3.1** Switches used in branch circuits shall simultaneously open all ungrounded conductor(s) of the branch circuit.

### 11.13 PLUGS AND RECEPTACLES

**11.13.1.1** Receptacles shall be installed in locations not normally subject to rain, spray, or flooding but if receptacles are used in such areas the following shall apply:

**11.13.1.1.1** Receptacles installed in locations subject to rain, spray, or splash shall be weatherproof when not in use.

*Note: Weatherproofing may be provided by means such as spring-loaded, self-closing, or snap type receptacle covers.*

**11.13.1.1.2** Receptacles installed in areas subject to flooding or momentary submersion shall be of a watertight design as may be provided by a threaded, gasketed cover.

**11.13.1.3** Receptacles and matching plugs used on AC systems shall not be interchangeable with receptacles and matching plugs used on DC systems.

**11.13.3.1** Receptacles shall be installed in boxes that meet the requirements of UL 514A, Metallic Outlet Boxes, or 514C, Non-metallic Outlet Boxes, Flush Device Boxes And Covers.

**11.13.3.2** Receptacles shall be of the grounding type with a terminal provided for the grounding (green) conductor as shown in Figure 12, Figure 13 and Figure 14 of ABYC E-11.

**11.13.3.3** Power wiring for receptacles shall be connected so that the grounded (white) conductor attaches to the terminal identified by the word "white" or a light color (normally white or silver). The ungrounded conductor(s) shall be attached to the terminal(s) identified by a dark color (normally brass or copper) and, optionally, the letters X, Y, and Z or L1, L2, and L3.

**11.13.3.4** A branch circuit supplying a combination of receptacle loads and permanently connected loads shall not supply permanently connected loads in excess of the following:

**11.13.3.4.1** 600 watts for a 15 ampere circuit.

**11.13.3.4.2** 1000 watts for a 20 ampere circuit.

**11.13.3.5** If installed in a head, galley, machinery space, or on a weather deck, the receptacle shall be protected by a Type A (nominal 5 milliamperes) Ground Fault Circuit Interrupter (GFCI). (See E-11.11.)

*Note: GFCI receptacle devices are not necessarily ignition protected per E-11.5.3.1.*

### 11.6.3.1 SHORE POWER SUPPLY

**11.6.3.1.1** Power Inlet - The receptacle, or receptacles, installed to receive a connecting cable to carry AC shore power aboard shall be a male type connector.

**11.6.3.1.1.1** Power inlets installed in locations subject to rain, spray, or splash shall be weatherproof whether or not in use.

**11.6.3.1.1.2** Power inlets installed in areas subject to flooding or momentary submersion shall be watertight whether or not in use.

**11.6.3.1.1.3** Metallic power inlets installed on metallic or carbon fiber reinforced boats using an isolation transformer or a galvanic isolator shall be insulated from metallic structure and components. On non-metallic boats using an isolation transformer or a galvanic isolator the power inlet shall be insulated from metallic components connected to the boat's ground.

**11.6.3.1.2** Shore Power Cable – On each boat equipped with an AC shore power system, a shore power cable that contains the conductors for the power circuit and a grounding (green) conductor shall be provided.

**11.6.3.1.2.1** Except where the shore power cable is permanently connected to the boat, the boat end of this cable shall be terminated with a locking and grounding female type connector to match the boat power inlet. (See Figure 13 and Figure 14 of ABYC E-11).

**11.6.3.1.2.2** The shore power cable shall be flexible cord with the minimum properties of Type SOW, STW, STOW, SEOW, or STOOW, and shall be suitable for outdoor use. The shore connection end of this cable shall be fitted with a locking and grounding type plug with the required number of poles and shall comply with Article 555 of the National Electrical Code. (See Figure 13 and Table VII-A of ABYC E-11).

*EXCEPTION: Pin and sleeve devices in accordance with Figure 14 of ABYC E-11.*



# Section Z Other Wiring Products

## Index

Product	Page
Adapters and Fluorescent Starters	Z-2
Lockout Devices and Circuit Tester	Z-3
Lockout Devices Specifications	Z-4
Lampholders	Z-5
Fluorescent Lampholders	Z-6
Incandescent Lampholders	Z-7
Lampholder Accessories	Z-8
Taps, Adapters, Plugs and Connectors	Z-9
Technical Information	Z-10

### Adapters, Starters and Receptacle Circuit Tester



### Lockout Devices



### Lampholders



### Taps, Adapters, Plugs and Connectors



## Other Wiring Products Adapters and Fluorescent Starters



### Nylon Convenience Adapters

#### NEMA Configuration

Catalog Number	HBL2270	HBL2271	HBL2128	HBL2274	HBL2129	HBL31CM29*
Male Blade End	15A 125V NEMA 5-15P	15A 125V NEMA 5-15P	15A 125V NEMA 5-15P	15A 125V NEMA L5-15P	20A 125V NEMA L5-20P	30A 125V NEMA L5-30P
Female Slot End	20A 125V NEMA 5-20R	15A 125V NEMA L5-15R	20A 125V NEMA L5-20R	20A 125V NEMA 5-20R	20A 125V NEMA 5-20R	20A 125V NEMA 5-20R

Note: \*Not UL Listed.

**CAUTION:** Where adapters have different ratings on the blade and slot end the following precautions must be exercised in their use.

- (1) Remember that overcurrent protection is determined by the blade end.
- (2) The use of the adapter should be limited to the lowest rated end of the adapter in order to prevent overheating.
- (3) Adapters do not provide GFCI, overcurrent or short circuit protection.



HBL5273L



HBL5289



9053A



9054A



FS4

### Plug In Adapters

Description	Catalog Number
Male end - 2 wire parallel polarized blades, 15A, 125V. Female end - 3 wire 15A, 125V straight slot grounding.	HBL5273L
Male end - 3 wire crow foot 15A, 125V blades. Female end - 3 wire 15A, 125V straight slot grounding.	HBL5289♦*
Male end - 3 wire 10A, 250V, 15A, 125V Twist-Lock® blades. Female end - 3 wire 15A, 125V straight slot grounding.	9053A♦*
Male end - 3 wire 15A, 125V straight blade grounding. Female end - 10A, 250V, 15A 125V Twist-Lock® slots.	9054A♦*

Note: ♦Must always be used with a grounded receptacle.

\*Not UL Listed.

### Fluorescent Starters

Neostart	Lamps	Catalog Number
The Hubbell Neostart is a glow discharge type of starter which combines fast starting speed with rugged, dependable operation. The Neostart lights the lamp very rapidly and insures proper lamp operation throughout rated life. Because of its rugged construction, it can be depended upon to withstand continued punishment resulting from lamp failure. In addition, it operates satisfactorily over a wide temperature range. In dual lamp circuits, the Neostart lights both lamps quickly and uniformly.	14, 15 and 20 watt lamps	FS2
	13, 30 and 40 watt lamps	FS4
	4, 6 and 8 watt lamps	FS5
	22 watt circle line, 25 watt standard lamps	FS25



# Other Wiring Products

## Lockout Devices and Circuit Tester

### PLUGOUT®, Keyed PLUGOUT® and SWITCHOUT® Lockout Devices

Description	Typical Devices Accommodated	Catalog Number
Small yellow lockout device.	15 and 20A straight blade plugs. 15A Twist-Lock® plugs.	<b>HLDMP</b>
Medium yellow lockout device.	15 and 20A, 125V straight blade plugs. 20 and 30A Twist-Lock® plugs.	<b>HLD</b>
Large yellow lockout device.	20, 30 and 60A metallic and non-metallic Pin and Sleeve, Hubbellock® and 50A Twist-Lock® plugs.	<b>HLD2</b>
Yellow SWITCHOUT device.	Toggle switch.	<b>HSLDPK2*</b>
Yellow lockout kit.	One each of above lockout devices.	<b>HLDKIT</b>
Yellow keyed PLUGOUT, keyed differently.	15 and 20A, 125V straight blade plugs with holes in blades.	<b>HKLD</b>
Yellow keyed PLUGOUT, keyed alike.	15 and 20A, 125V straight blade plugs with holes in blades.	<b>HKLDPK2*</b>

Note: See page Z-4 for specifications.  
\*Two devices per package.

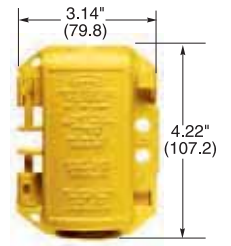

HLDMP

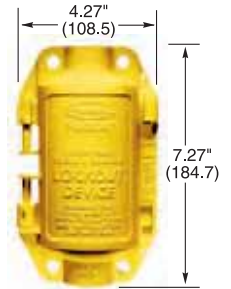

HLD



HSLDPK2



HKLDPK2



HBL5200



HBL112

### Receptacle Circuit Tester



Description	Catalog Number
Receptacle circuit tester.	<b>HBL5200</b>

### How It Operates

The Hubbell HBL5200 Receptacle Circuit Tester has a simple arrangement of neon lights which visually indicate and identify various fault conditions in electrical circuits (see chart below). By plugging the HBL5200 Tester into a single phase, 125V, 2 pole, 3 wire outlet the combination of lighted and/or unlighted lamps will immediately indicate circuit condition.

### Features

- UL Listed.
- Large, easy to read symbols.
- Recessed indicating lamps with one piece Polycarbonate lens.
- Tough impact resistant nylon housing.
- User information and instructions printed on durable Polyester labels permanently attached to the tester.
- Rotatable labels can be easily read regardless of tester position.

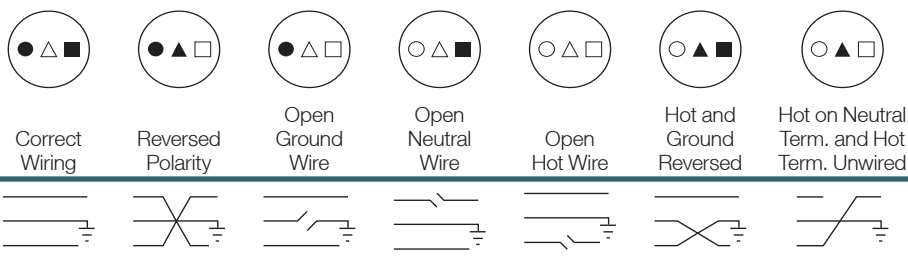

Note: □ △ ○ Indicates Unlighted Lamp. ■ ▲ ● Indicates Lighted Lamp.  
When testing other receptacle types, use HBL5200 only with polarized adapters.

**CAUTION:** This device introduces low level current into the grounding path. Use with caution in critical care areas.

### Cord Grip

Description	Catalog Number
Cord grip for ½ inch knockouts.	<b>HBL112*</b>

Note: \*Not UL Listed.

Dimensions in Inches (mm)

Other Wiring Products  
**Lockout Devices Specifications**  
*Lockout Devices For Electrical Safety*



**Specifications**

Typical Specification	PLUGOUT® Devices
Description	Yellow lockout device.
Housing	UV stabilized polypropylene, heavy metal free colorant.
Optional storage position	Stores on cable when not in use.
Color	High visibility yellow.
Instructional Information	Permanently molded into housing.
Ambient Operating Temperature	Maximum continuous 140°F (60°C); minimum continuous -20°F (-29°C).

Plug Sizes and Padlocks Accommodated	HLDMP	HLD	HLD2
Plug Diameter	0.79" (20.0) min., 1.73" (44.0) max.	1.50" (38.1) min., 2.75" (69.8) max.	1.90" (48.3) min., 4.50" (114.3) max.
Plug Length	3.70" (94.0) max.	4.75" (120.6) max.	10.15" (257.8) max.
Cord	0.64" (16.3) max.	1.11" (28.2) max.	1.45" (36.8) max.
Maximum Number of Padlocks	2 locks, 5/16" (7.9) shackle dia.	4 locks, 3/8" (9.5) shackle dia.	4 locks, 3/8" (9.5) shackle dia.

Typical Specification	Keyed PLUGOUT® Device HKLD and HKLDPK2
Description	ABS with metal cylindrical lock.
Housing	UV stabilized polypropylene, heavy metal free colorant.
Color	High visibility yellow.
Instructional Information	Permanently molded into housing.
Ambient Operating Temperature	Indoor use only.



**Specifications**

Typical Specification	SWITCHOUT® Device HSLDPK2
Description	Yellow switchout device.
Housing	Nylon, heavy metal free colorant.
Color	High visibility yellow.
Installation	Installs without removal of existing wallplate screws.
Maximum Number of Padlocks	Two locks, 5/16" (7.9) shackle dia.
Ambient Operating Temperature	Maximum continuous 140°F (60°C); Minimum continuous -20°F (-29°C).

## Other Wiring Products Lampholders

Lampholders provide lighting in unfinished areas, such as attics and basements.

### Porcelain White Lampholders



Catalog Number	RL8804	RL8806	RL8812	RL8816	RL8822
Description	Keyless, 4 Terminal Screws	Keyless, 6 inch Pigtails	Pull Chain, 2 Terminal Screws	Pull Chain, 6 inch Pigtails	Pull Chain with Receptacle, 2 Terminal Screws
Rating	660W 250V	660W 250V	660W 250V	660W 250V	660W 125V 15A 125V NEMA 5-15R

### Plastic White Lampholders



Catalog Number	RL8504	RL8506	RL8512	RL8516
Description	Keyless, 4 Terminal Screws	Keyless, 6 inch Pigtails	Pull Chain, 2 Terminal Screws	Pull Chain, 6 inch Pigtails
Rating	660W 600V	660W 600V	660W 250V	660W 250V

### Incandescent Brass Lampholders, Medium Base



Catalog Number	RL101*	RL102*	RL105*	RL100**	RL106*
Description	Turn Knob, On/Off	Turn Knob, Three Way	Push Through, On/Off	Keyless	Pull Chain, On/Off
Rating	250W 250V	250W 250V	660W 250V	660W 250V	660W 250V

Note: \*UL or cUL.  
\*\*UL or CSA.

# Other Wiring Products Fluorescent Lampholders

## Compact Fluorescent Lampholders



Catalog Number	<b>RL479HSM</b>	<b>RL413HSI</b>	<b>RL413HSM</b>	<b>RL426G24</b>	<b>RL42G11HSM</b>	<b>RL42G11H9</b>
Description	G23 base	GX23 base	GX23 base	G24Q-3, GX24Q-4	2G11 base, 4 pin	2G11 base, 4 pin
Lamp Type	5W, 7W, 9W	13W	13W	26-32W	18-55W	18-55W
Rating	75W, 600V	75W, 600V	75W, 600V	75W, 600V	75W, 600V	75W, 600V
Mounting	Horizontal, screw-down	Horizontal, snap-in	Horizontal, screw-down	Horizontal, screw-down	Horizontal, screw-down	Vertical 90°, snap-in

**RL42G11C**



Clip for 2G11 Base Lampholders, Adjustable, Snap-in

## High Output Fluorescent Lampholders



Catalog Number	<b>RL305*</b>	<b>RL306*</b>	<b>RL307</b>	<b>RL308</b>	<b>RL356</b>	<b>RL357</b>
Description	Plunger	Fixed	Plunger	Fixed	Plunger	Fixed
Lamp Type	Horizontal - Recessed double contact	Horizontal - Recessed double contact	Horizontal - Recessed double contact	Horizontal - Recessed double contact	Vertical - Power groove & jacketed lamps	Vertical - Power groove & jacketed lamps
Rating	660W, 600V	660W, 600V	660W, 600V	660W, 600V	660W, 600V	660W, 600V
Mounting	Pedestal, slide-on	Pedestal, slide-on	Slide-on, snap-in	Slide-on, snap-in	Slide-on, snap-in	Slide-on, snap-in

Note: \*UL or cUL.

## Medium Bi-Pin Fluorescent Lampholders - T8 and T12



Catalog Number	<b>RL320</b>	<b>RL325</b>	<b>RL325B</b>
Description	Disconnect 4 wire	Disconnect 4 wire	Shunted 2 wire
Lamp Type	Bi-pin/tall profile	Bi-pin/low profile	Bi-pin/low profile
Rating	660W, 600V	660W, 600V	660W, 600V
Mounting	Slide-on and snap-in with captive nut	Slide-on and snap-in with captive nut	Slide-on and snap-in

## Slimline Type Fluorescent Lampholder



Catalog Number	<b>RL310*</b>	<b>RL311*</b>
Description	Plunger	Fixed
Lamp Type	Single pin	Single pin
Rating	660W, 600V	660W, 600V
Mounting	Slide-on and snap-in	Slide-on and snap-in

Note: \*UL or cUL.

## Other Wiring Products Incandescent Lampholders



### HID Incandescent Lampholders, Porcelain Keyless



Catalog Number	RL4221*	RL5221	RL3742
Description	Mogul base	Mogul base	Medium base prefocus
Lamp Type	E39 socket	EX39 socket	Bayonet socket
Rating	1500W, 600V Max, 4KV or 5KV PULSE	1500W, 600V Max, 5KV PULSE	1200W, 250V
Mounting	Screw mount, 12 inch leads	Screw mount, 12 inch leads	Screw mount

Note: \*UL Listed, CSA Certified.



### Straight Body Keyless Porcelain



Catalog Number	RL162	RL156	RL157	RL160	RL158	RL159
Description	Medium base	Medium base	Medium base	Medium base	Medium base, low profile	Medium base, shallow base
Lamp Type	E26 socket	E26 socket	E26 socket	E26 socket	E26 socket	E26 socket
Rating	660W, 250V	660W, 250V	660W, 250V	660W, 250V	660W, 250V	660W, 250V
Mounting	Screw mount, screw terminals	Screw mount, 12 inch leads	NPSF1/8 hickey with terminals	NPSF1/8 hickey with 12 inch leads	Front mount, panel mount snap-in	Front mount, panel mount snap-in



### Surface and Sign Mount, Medium Base



Catalog Number	RL152	RL153	RL161	RL163	RL164
Description	Medium base, Porcelain, Pony Cleat	Medium Base, Plastic, Black, Pony Cleat	Medium base, Porcelain	Medium base, Porcelain	Medium base, Porcelain
Lamp Type	E26 socket	E26 socket	E26 socket	E26 socket	E26 socket
Rating	660W, 250V	660W, 250V	660W, 250V	660W, 250V	660W, 250V
Mounting	1 piece, surface mount	1 piece, surface mount	2 piece, surface mount	2 piece, sign mount with leads	2 piece, sign mount with terminals

## Other Wiring Products Lampholder Accessories

### Incandescent Lampholders, Medium Base



Catalog Number	RL124*	RL124H	RL202
Description	Pigtail Medium Base Socket with 6 inch Leads, Rubber with #18 Gauge Wire	Phenolic Medium Base Socket with Hook, Insulation Piercing Termination	Medium Lampholder to Lampholder Adapter, Pull Chain with Two 2-Prong Outlets without Ground
Rating	660W 250V	660W 250V	660W 125V 15A 125V

Note: \*cCSAus Certified only.

### Incandescent Adapters, Medium Base



Catalog Number	RL150	RL154	RL200	RL201
Description	Medium to medium base extension, Screw-in, E26 to E26 socket	Mogul to medium base adapter, Screw-in E39 to E26 socket	Outlet Adapter, 2 Prong Plug to Medium Lampholder	Medium Lampholder Adapter, Medium Lampholder to Outlet without Ground
Rating	250W, 250V	660W, 250V	15A 660W 125V 15A 125V NEMA 1-15R	15A 125V NEMA 1-15R

### Lamp Switches



Catalog Number	RL120	RL121	RL122	RL125
Description	Pull chain switch, 2 circuit, L1/L2/L1+L2/off	Pull chain switch, SPST on/off	Pull chain switch, L1/L2/L3/off	Rotary switch, SPST on/off
Rating	6A 125V AC, 3A 250V AC, 3A 125V "L"	6A 125V AC, 3A 250V AC, 3A 125V "L"	6A 125V AC, 3A 250V AC	6A 125V AC, 3A 250V AC, 3A 125V "L"

Note: 6 inch wire leads are #18 AWG AWM/TEW 105°C 600V.

### Snap-in Receptacles



Catalog Number	RR374	RR374W
Description	Single receptacle, Black	Single receptacle, White
Rating	15A 125V, 3 wire NEMA 5-15R	15A 125V, 3 wire NEMA 5-15R

- Accommodate panel thickness of .031 to .062 inch (0.7 to 1.5 mm).
- Panel cutout .95 x .95 inch (24.1 x 24.1 mm).
- #14 AWG 6 inch AWM/TEW FT1 105°C 600V on black and white leads.
- #14 AWG 6 inch AWM/TEW FT1 600V on green lead.



# Other Wiring Products Taps, Adapters, Plugs and Connectors



## Taps and Adapters



Color					
Ivory	<b>RT600I</b>	<b>RT300I</b>	—	<b>RT200*</b>	—
Orange	—	—	<b>RT303</b>	—	—
White	<b>RT600W</b>	<b>RT300W</b>	—	—	<b>RT100W</b>
Description	Duplex Receptacle to Six Outlets with Ground	Single Receptacle to Three Outlets with Ground	Single Receptacle to Three Outlets, Heavy Duty Rubber, with Ground	Two Wire to U-Ground	Cube Tap without Ground
Rating	15A 125V AC NEMA 5-15	15A 125V AC NEMA 5-15	15A 125V AC NEMA 5-15	15A 125V AC NEMA 5-15	15A 125V AC NEMA 1-15

Note: \*UL Listed only.

## Plugs and Connectors



Color					
Black	<b>RP101BK</b>	<b>RP102BK</b>	<b>RP646</b>	<b>RP648</b>	<b>RP649</b>
White	<b>RP101W</b>	<b>RP102W</b>	—	—	—
Description	Straight Plug, Polarized, Two Blade Light Duty	Straight Connector, Polarized, Two Blade, Light Duty	Straight Plug, Non-Polarized, Two Blade, Heavy Duty	Straight Plug, Polarized, Two Blade, Heavy Duty	Straight Connector, Polarized, Two Blade, Heavy Duty
Wire Range	#16,18 AWG, Up to .250 inch Dia.	#16,18 AWG, Up to .250 inch Dia.	#14-18 AWG, Up to .330 inch Dia.	#14-18 AWG, Up to .330 inch Dia.	#14-18 AWG, Up to .330 inch Dia.
Rating	15A 125V NEMA 1-15P	15A 125V NEMA 1-15P	15A 125V NEMA 1-15P	15A 125V NEMA 1-15P	15A 125V NEMA 1-15P



Color		
Ivory	<b>RP123I</b>	<b>RP123PI</b>
White	<b>RP123W</b>	<b>RP123PW</b>
Description	Straight Plug, Non-Polarized, Two Blade	Straight Plug, Polarized, Two Blade
Cord	SPT 1 and 2 Cord 18/2 & 16/2 AWG	SPT 1 and 2 Cord 18/2 & 16/2 AWG
Rating	15A 125V NEMA 1-15P	15A 125V NEMA 1-15P



**Technical Information**

RL5221 HID Incandescent Lampholder

**Specification**

Rating 1500W, 600V Max, 5KV Pulse

**Mechanical**

Material Glazed porcelain body with ceramic arc shield  
 Screw shell: Brass with nickel plate

**Terminal Accommodation**

Wire leads: #14 AWG SF-2 (SEW-2) 200° C, 600V glass braid, 12 inch long, stripped 1/2 inch wire.

Mogul Base EX39 lampholder used with ANSI type "o" metal halide lamps, open-rated protected lamps, for use in open or enclosed luminaires. "EX" style exclusionary base designed specifically for operation with protected sockets.



**RL5221**

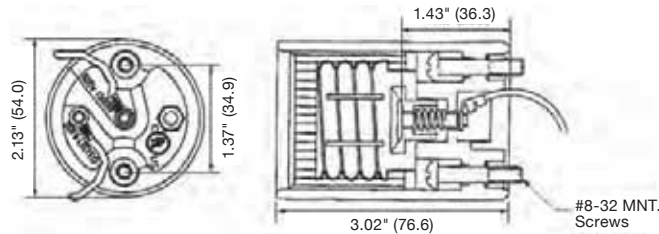

**Technical Information**

RL426G24 Compact Fluorescent Lampholder



**Specification**

Rating 26-32W lamp type, 75W, 600V

**Mechanical**

Material High Strength Polycarbonate

**Terminal Accommodation**

Suitable as G24Q-3 or GX24Q4 type base, horizontal mount, screw down. Push-in wire terminals for #18 AWG solid or twist and tin stripped 7/16 inch wire. Maximum 6.5 inch lbs conductor insertion force. Wiring port accepts 2 wires for harness wiring.



**RL426G24**

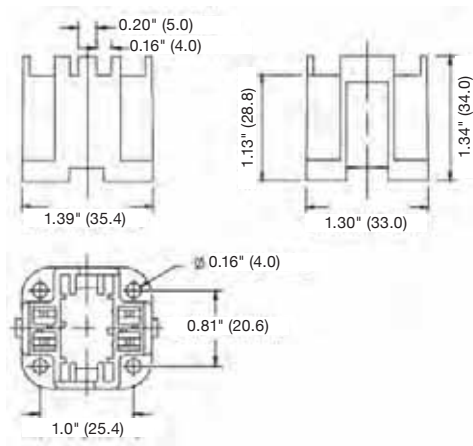

*Dimensions in Inches (mm)*

# Tech Section General Technical Data

## Index

Product	Page
Industry Standards .....	Tech-2
Certification Agencies and Markings .....	Tech-4
Industry Associations, Organizations and Standards .....	Tech-5
Codes and Standards Organizations .....	Tech-6
AC Switch Data and Horsepower Explanation .....	Tech-7
Wiring Device Standards and Testing .....	Tech-8
RoHS, WR, TR and LED Power Descriptions .....	Tech-10
NEMA and IEC Classifications - Enclosures .....	Tech-11
IP Code and Their Meanings .....	Tech-11
Enclosure Types for Self-Certified Non-Hazardous Locations .....	Tech-12
Circuit Wiring Diagrams .....	Tech-14
Horsepower Ratings for NEMA Configurations .....	Tech-19
UL 508A Table SB4.1 .....	Tech-19
Isolated Ground Story .....	Tech-20
Decimal Equivalents Table .....	Tech-21
Electrical Symbols and Abbreviations .....	Tech-22
Diameter Ranges of Jacketed Cord and Wire Charts .....	Tech-23
IEC Pin and Sleeve Terminal Identification .....	Tech-24
Horsepower Ratings for IEC Pin and Sleeve .....	Tech-25
Network Cabling Requirements .....	Tech-26

### Certification Agencies and Markings



### Circuit Wiring Diagrams

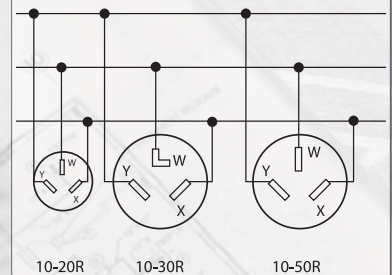

### Electrical Symbols and Abbreviations

	Push Button		Buzzer
	Bell		Annunciator
	Outside telephone		
	Interconnecting telephone		
	Telephone switchboard		
	Bell ringing transformer		
	Electric door opener		
	Fire alarm bell		
	City fire alarm station		

### Horsepower Rating Tables

Catalog Number	A/C Voltage Rating	HP Rating
HBL420R9W	3Ø250	2
HBL420R7W	3Ø480	5
HBL420R5W	3Ø600	7-1/2
HBL520R9W	3ØY 120/208	1/2
HBL520R7W	3ØY 277/480	5
HBL520R5W	3ØY 347/600	7-1/2
HBL430R9W	3Ø250	3
HBL430R7W	3Ø480	7-1/2
HBL430R5W	3Ø600	10
HBL530R9W	3ØY 120/208	2
HBL530R7W	3ØY 277/480	7-1/2
HBL530R5W	3ØY 347/600	10

## General Technical Data

# Industry Standards – Wiring Device Standards

Standards of many types developed by and for our industry form a vital consideration in the design of our products. The following pages in this section briefly describe the functions of the organizations producing the standards which influence the safety and design of wiring devices.

**The American Boat and Yacht Council Inc. (ABYC)** is a not-for-profit membership organization that has been developing and updating the safety standards for boat building and repair for over 50 years. ABYC is actively involved with the International Organization for Standardization (ISO) and is a leader in education for the marine industry, as well as certification programs for marine technicians. ABYC's membership includes boat builders, boat owners, surveyors, boat yards, insurance companies, law firms, trade associations, marinas, dealerships, government agencies, educational institutions and equipment and accessory manufacturers. Over 400 volunteers donate time, expertise, and research while serving on technical committees, which develop and revise the ABYC standards and technical information reports. We ensure quality and professionalism in each of ABYC's services.

**UL LLC, formerly Underwriters Laboratories Inc. (UL)** A for-profit corporation, operating in two distinct roles, as a certifier and testing facility, and as a developer of safety standards. By its own definition, Underwriters Laboratories defines itself as follows: "Underwriters Laboratories Inc. founded in 1894, is chartered as a not-for-profit organization without capital stock, under the laws of the state of Delaware to establish, maintain, and operate laboratories for the examination and testing of devices, systems and materials to determine their relation to hazards to life and property." On January 1, 2012, UL moved to a for-profit structure.

Separate from product certifications, UL develops consensus standards for the U.S. UL evaluates products for paying "clients" and if the product submitted passes the requirements of the UL standard for which it is submitted, a UL "Listing" is granted which allows the manufacturer to use the UL manifest or "Label" on its products. Electrical inspectors or other Authorities Having Jurisdiction (AHJs) use UL Listings of products to determine acceptability of electrical installations. It is important to remember that UL is not an approval agency. It approves nothing, but lists a product as meeting minimum standards for safety. The Underwriters "Listing" mark on a product is generally accepted by the public and government agencies as evidence of a "safe" product, not necessarily a "quality" product.

**CSA Group, formerly Canadian Standards Association (CSA)** is a not-for-profit membership-based association and performs a function for manufacturers similar to that performed in the USA by Underwriters Laboratories Inc. (UL) and National Fire Protection Association (NFPA). CSA Standards develops product safety standards for Canada, which parallel UL standards in many aspects but are not always identical. CSA International evaluates products and grants paying clients "Certification" that their products meet CSA Standards. CSA Standards also sponsors the Canadian Electrical Code (CE Code).

**American National Standards Institute, Inc. (ANSI)** as the voice of the U.S. standards and conformity assessment system, the American National Standards Institute (ANSI) empowers its members and constituents to strengthen the U.S. marketplace position in the global economy while helping to assure the safety and health of consumers and the protection of the environment.

The Institute oversees the creation, promulgation and use of thousands of norms and guidelines that directly impact businesses in nearly every sector: from acoustical devices to construction equipment, from dairy and livestock production to energy distribution, and many more. ANSI is also actively engaged in accrediting programs that assess conformance to standards – including globally-recognized cross-sector programs such as the ISO 9000 (quality), ISO 14000 (environmental) and ISO 17025 (laboratory) management systems.

**The International Electrotechnical Commission (IEC)** is the leading global organization that prepares and publishes international standards for all electrical, electronic and related technologies. These serve as a basis for national standardization and as references when drafting international tenders and contracts. Through its members, the IEC promotes international cooperation on all questions of electrotechnical standardization and related matters, such as the assessment of conformity to standards, in the fields of electricity, electronics and related technologies.

IEC's international standards facilitate world trade by removing technical barriers to trade, leading to new markets and economic growth. Put simply, a component or system manufactured to IEC standards and

## General Technical Data

# Industry Standards – Wiring Device Standards

manufactured in country A can be sold and used in countries B through Z. IEC's standards are vital since they also represent the core of the World Trade Organization's Agreement on Technical Barriers to Trade (TBT), whose 100-plus central government members explicitly recognize that international standards play a critical role in improving industrial efficiency and developing world trade.

### The National Electrical Code® (NEC®)

The NEC is developed by NFPA's Committee on the National Electrical Code®, which consists of 19 Code-Making Panels and a Technical Correlating Committee. Work on the NEC is sponsored by the National Fire Protection Association (NFPA). The NEC is approved as an American National Standard by the American National Standards Institute (ANSI). It is formally identified as ANSI/NFPA 70.

First published in 1897, the NEC is updated and published every three years. The 2014 edition will be published in October 2013. Most states adopt the most recent edition within a couple of years of its publication. As with any "uniform" code, a few jurisdictions regularly omit or modify some sections, or add their own requirements (sometimes based upon earlier versions of the NEC, or locally accepted practices). However, the NEC is the least amended model code, even with it setting minimum standards. No court has faulted anyone for using the latest version of the NEC, even when the local code was not updated to the most recent edition.

**National Electrical Manufacturers Association (NEMA®)** An organization of over 450 manufacturers of electrical equipment, including, but not limited to, wiring devices, wire and cable, conduit, load centers, pressure wire connectors, circuit breakers, fuses, etc. NEMA is the "voice" of the electrical industry, and through it, standards are developed for electrical distribution.

Generally these standards promote interchangeability between products of one manufacturer with like products made by another manufacturer. In some cases, standards relating to product "performance" are also formulated by NEMA but these are the exception rather than the rule.

NEMA standards are not compulsory, but generally are accepted by those manufacturers that help to write them as a way of making their products more saleable and acceptable. However, many NEMA standards, such as ANSI/NEMA WD 6, are approved by the American Standards Institute and referenced by mandatory UL and CSA product standards. NEMA standards are utilized by many consumers

in writing specifications for the materials they purchase. NEMA does not evaluate or certify products or enforce regulations.

**General Services Administration Federal Supply Service (GSA) Federal Supply Service (FSS)** provides federal customers with the products, services, and programs to meet their supply, service, procurement, vehicle purchasing and leasing, travel and transportation, and personal property management requirements. Hubbell offers devices listed by UL as FED SPEC and can be found throughout this catalog.

**Occupational Safety and Health Administration (OSHA)** is a branch of the US Department of Labor which was created to assure safe and healthful working conditions for working men and women. OSHA uses regulations from the Federal Register, NFPA and the National Electric Code to establish and enforce safety standards for the workplace. It is important to note: OSHA does NOT approve products. OSHA enforces existing safety regulations.

### Canadian Electrical Code, Part I (CE Code)

The CE Code is developed by the Committee on CE Code, Part I, composed of members representing inspection authorities, manufacturing and utilizing industries, utilities and allied interests. The Committee meets annually to address reports submitted by 43 section subcommittees. Work on CE Code, Part I is sponsored by CSA Standards. The product standards of CSA Standards comprise the Canadian Electrical Code, Part II.

First published in 1927, the CE Code, Part I, is updated and published every three years, prior to 2006 every four years. The 2012 CE Code, Part I, is the latest edition. As with any "uniform" code, provinces and a few jurisdictions regularly modify or add their own requirements.

**NSF International, formerly National Sanitation Foundation (NSF)** NSF International is a not-for-profit organization founded in 1944 from the University of Michigan's School of Public Safety. NSF develops public health standards, and provides and enforces certifications to protect food, water, and beverages. NSF is the leading certifier of food service equipment.









# General Technical Data

## Certification Agencies and Markings

### Understanding Certification Marks:

Certification marks vary significantly with respect to testing required to achieve a particular mark. In some cases, (i.e.: Specification Grade), no outside certification agency is involved. The manufacturer decides which of their products they wish to be so identified. The following table for 15 and 20A Straight Blade receptacles demonstrates these wide differences. The understanding of these marks permits the user/specifier to make more meaningful product selections.

Understanding Product Certification Marks - 15 and 20 Amp Straight Blade Receptacles  
 Products that carry certification marks must meet the specific testing standards indicated

Certification Mark	Description	UL 498	CSA, C22.2 No. 42	UL 498 Hospital Grade	CSA, C22.2 No. 42 M Hospital Grade	DESC WC596
<b>Spec Grade*</b>	Self Certified, No Testing Required- Advertising/Trade Name					
	Used on recognized component parts that are part of a Listed product or system intended for the United States. Component "C" intended for Canada. Recognized components are intended only for installation by Original Equipment Manufacturers (OEMs) within their Listed products, and are not accepted by electrical inspectors for general-use field installations due to limitations called Conditions Of Acceptability (COA).	X				
	Used on recognized component parts that are part of a Listed product or system intended for the United States and Canada. Recognized components are intended only for installation by Original Equipment Manufacturers (OEMs) within their Listed products, and are not accepted by electrical inspectors for general-use field installations due to limitations called Conditions Of Acceptability (COA).	X				
	Products found with this mark means Underwriters Laboratory or CSA International found that representative samples of this product met Underwriters Laboratory's published Standards for Safety intended for the US market.	X				
	Products found with this mark are certified primarily for the Canadian market.		X			
	Products intended for US and Canada.	X	X			
 • Hospital Grade	In addition to complying with general use requirements, this mark denotes these device have been specially designed and are subject to additional requirements of the standards.	X		X		
 • Hospital Grade	In addition to complying with general use requirements, this mark denotes these device have been specially designed and are subject to additional requirements of the standards.		X		X	
 Fed. Spec.	In addition to complying with general use grade requirements, this mark denotes receptacles also have been investigated for compliance with United States Federal Specification W-C-596.	X				X
 Fed. Spec. • Hospital Grade	In addition to complying with general use and hospital grade requirements, this mark denotes receptacles also have been investigated for compliance with United States Federal Specification W-C-596.	X		X		X

Note: \*Includes such variation as Premium Spec, Super Spec, etc.  
 \*\*End Product test also required.

### Cross Reference Note:

Recognize that cross reference guides supplied by some manufacturers should be used only to determine compatible devices (rating and configuration). It does not, in any way, deal with performance levels (which will vary widely by manufacturer). Common catalog numbers are often used for convenience of selection. The use of the same catalog number is solely the discretion of the manufacturer. It in no way implies compliance to any standard or testing criteria.

# General Technical Data

## Industry Associations, Organizations and Standards

For convenience, the following listings define common acronyms for a variety of organizations.

**Standards Development Organizations: Organizations primarily involved in the development and/or promulgation of standards.**

ANSI	American National Standards Institute.
CANENA	Consejo de Armonizacion de los Naciones de America.
CSA	Canadian Standards Association.
IEC	International Electrotechnical Commission.
IEEE	Institute of Electrical & Electronics Engineers, Inc.
ISA	The Instrumentation, Systems and Automation Society.
ISO	International Organization for Standardization.
LEEDS	Leadership in Energy and Environmental Design.
NFPA	National Fire Protection Association, Inc.
NSF	National Sanitation Foundation.
SAE	Society of Automotive Engineers.
SME	Society of Manufacturing Engineers.
USGBC	United States Green Building Council.
UL	Underwriters Laboratories Inc.



### Installation Codes

CEC Part I	Canadian Electrical Code, Part I.
NEC®	National Electrical Code®.
NOM	Normas Oficiales Mexicanas (Mexican Electrical Code).



**Industry Associations: Associations of companies or individuals for the purpose of standardization, trade, and professional development, etc.**

ABYC	American Boat and Yacht Council.
ASTM	American Society for Testing and Materials.
BICSI	Building Industry Consulting Services International.
BOMA	Building Owner Management Association.
CANAME	Camara Nacional de Manufacturas Electricas.
CEMRA	Canadian Electrical Manufacturers Representative Association.
ECOC	Electrical Contractors of Canada.
EF-C	Electro-Federation-Canada.
EIA	Electronic Industries Alliance.
EPRI	Electric Power Research Institute.
IAEI	International Association of Electrical Inspectors.
IECI	Independent Electrical Contractors International.
IFMA	International Facilities Management Association.
NAED	National Association of Electrical Distributors.
NAW	National Association of Wholesalers.
NECA	National Electrical Contractors Association.
NEMA	National Electrical Manufacturers Association.
NEMRA	National Electrical Manufacturers Representatives Association.
NMDA	National Marine Distributor Association.
NMRA	National Marine Representative Association.
SEMI	Semi Conductor Equipment and Material International.
TIA	Telecommunication Industry Association.



# General Technical Data

## Codes and Standards Organizations

### Addresses

For convenience, the following listings define common acronyms for a variety of organizations.

**Certification Agencies:** Primarily involved in certification of products or manufacturers to standards developed by the certification agency or by others.

ANCE	National Association of Normalization and Certification of the Electrical Sector.
BSI	British Standards Institute.
CE	Self Certification Marking of European Community.
CCC	China Compulsory Certification.
CSA	Canadian Standards Association or CSA International.
FM	Factory Mutual.
NRTL	Nationally Recognized (by OSHA) Testing Laboratory.
PSE	Product Safety Electrical Appliance and Material (Japan).
TÜV	TÜV Rheinland of N.A., Inc.
UL	Underwriters Laboratories Inc.
VDE	Verband Deutscher Elektrotechniker (Germany).



Note:  Hubbell products are in the process of being certified in Mexico. Many have already been certified. Consult with the factory for specific data.

### Government Agencies

DSCC	Defense Supply Center – Columbus.
EU	European Union.
FCC	Federal Communications Commission.
IAPA	Industrial Accident & Prevention Association (Canada).
OSHA	Occupational Safety and Health Administration.

Copies of standards referred to on the preceding pages may be purchased from the following:

**American Boat and Yacht Council, Inc. (ABYC)**  
613 Third Street, Suite 10  
Annapolis, MD 21403  
USA

**The American National Standards Institute (ANSI)**  
25 West 43rd Street,  
(between 5th and  
6th Avenues), 4 floor  
New York, NY 10036

or

1819 L Street, NW  
(between 18th and  
19th Streets), 6th floor  
Washington, DC 20036  
USA

**CSA Group (CSA)**  
178 Rexdale Boulevard  
Toronto, Ontario  
M9W 1R3  
CANADA

**National Electrical Manufacturers Association (NEMA)**  
1300 North 17th Street  
Rosslyn, VA 22209  
USA

**National Fire Protection Association (NFPA)**  
1 Batterymarch Park  
Quincy, MA 02169-7471  
USA

**NSF International (NSF)**  
789 North Dixboro Road  
Ann Arbor, MI 49105  
USA

**The International Electrotechnical Commission (IEC)**  
IEC Central Office  
3, rue de Varembe  
P.O. Box 131  
CH - 1211 GENEVA 20  
Switzerland

**Asociacion Nacional de Normalizacion y Certificacion del Sector Electrico A.C. (NOM – ANCE)**  
Ibsen No.13,  
Colonia Chapultepec Polanco,  
C.P.11560 México, D.F.,  
Conmutador 5280-6775

**Occupational Safety and Health Administration (OSHA)**  
Occupational Safety & Health Administration  
200 Constitution Avenue, NW  
Washington, DC 20210  
USA

**UL LLC (UL)**  
Underwriters Laboratories Inc.  
333 Pfingsten Road  
Northbrook, IL 60062-2096  
USA



# General Technical Data

## AC Switch Data and Horsepower Explanation

### AC Test Requirements

When AC general use switches were considered by the industry and Underwriters' Laboratories, Inc. thought was given to the ratings and it was decided to rate the switches in accordance with NEC branch circuit ratings of 15, 20 and 30 amperes. It was also decided to test the switch for all the loads that could be applied to a branch circuit. Therefore, all AC switches are tested on resistance, tungsten lamp and inductive loads to 100% of switch rating.

### Underwriters' Laboratories and Canadian Standards Association Test requirements for AC General Use Switches

In order to be listed by Underwriters' Laboratories, Inc. and certified by CSA International, all 15, 20 and 30 amperes 120/277V AC switches must perform, without failure, the following sequence of tests.

1. An overload test of 100 cycles at 4.8 times rated current and 40-50% power factor and rated voltage. This overload test is performed at 144 amps, 277 volts for 30 ampere switches at 6-10 cycles per minute.
2. 10,000 cycles on a plain resistance load at full rating of 15, 20 or 30 amperes, at 277 volts at 18-24 cycles per minute.
3. 10,000 cycles on an inductive load of either 15, 20 or 30 amperes at 277 volts, 80% power factor at 24 cycles per minute.
4. 10,000 cycles at 15, 20 or 30 amperes, 120 volts on a tungsten filament lamp load at 6-10 cycles per minute.
5. Temperature rise at test-rated load. In this test, temperature rise must not exceed 30 degrees Celsius.
6. A switch shall withstand, without breakdown, 1500 volts for 1 minute between live parts of opposite polarity and between live parts and dead metal parts, with the switch at the maximum operating temperature reached in intended use.

### Explanation of "Horsepower" Ratings

Manual motor controllers marked with Horsepower Ratings are suitable for controlling the Motor Loads of the HP ratings shown on the manual motor controllers for that operating voltage as well as for lower HP ratings.

To qualify for an HP rating, a manual motor controllers is tested at (6) six times the full load Motor Current corresponding to the HP rating marked on the switch. (For DC Motor Controllers, the test is made at 10 times the full load Motor Current corresponding to the DC HP rating marked on the switch). The test consists of 50 on-off operations at this load and the test is conducted on (6) six samples. For ¾ HP 120 - 240 volts AC rating, (2) two sets of (6) six samples each are tested in addition to the regular overload, endurance, temp. rise and dielectric tests. The test circuit characteristics are:

	For ¾ HP 120V AC	For ¾ HP 240V AC
Closed Circuit Volts	120 volts AC	240 volts AC
Current	82.8 amps	41.4 amps
Power Factor	0.40-0.50	0.40-0.50

*Note: Current at 240V AC is ½ that at 120V AC*

All manual motor controllers must be in good operating condition after the tests have been completed. There must be no excessive arcing, welding or burning of the contacts nor arc-over to the ground (the manual motor controller frames are grounded during the stalled rotor test).

# General Technical Data

## Wiring Device Standards and Testing

### Wiring Device Standards

---

There are many different marketing terms in the electrical industry to describe the various electrical receptacles available from different manufacturers. Some of these terms include: Spec-Grade, Commercial, Heavy Duty, Industrial, Hard-Use, etc. There are no clear or universal definitions for these terms. There is no criteria established to differentiate one term from the next. Reliance solely upon these terms is not a reliable measure of performance or durability in a given application.

Underwriters Laboratories (UL) recognized a need to categorize receptacles based on application and expectations of performance. As a result, UL verifies performance to the following designations. Here are brief descriptions of each:



**General Use - UL 498** – All duplex receptacles are required to meet these general requirements. Devices bearing the UL mark for general use have been tested to insure they can safely provide power in typical everyday usage (vacuum, lamps, electronics, etc.).



Fed. Spec.

**Fed. Spec. - W-C-596** – The Federal Government wanted some way to determine that a receptacle performed better than average and would withstand the tougher demands of institutional use (post offices, military installations, prisons, etc.). Fed. Spec. listing identifies receptacles as having construction features, marking specifications and performance requirement (i.e., plug retention, increased cycle testing) beyond the requirements of the general use listing.



• Hospital Grade

**Hospital Grade** – In addition to compliance with general use requirements, Hospital Grade receptacles must meet performance criteria designed to test: ground reliability, assembly integrity, overall strength and reliability. Hospital Grade devices are marked with a green dot on their face.



Fed. Spec.

• Hospital Grade

**Hospital Grade Fed. Spec.** – Receptacles meeting this designation meet requirements and have completed test programs for both Fed. Spec. and Hospital Grade receptacles. All Hubbell Hospital Grade devices are UL listed to this designation.

These UL designations are a better determinant of performance than marketing descriptions, for performance and durability.

# General Technical Data

## Wiring Device Standards and Testing

### Testing for Hospital Grade and Fed. Spec. Listing of Hubbell Receptacles, Plugs and Connectors

---

All Hubbell Hospital Grade products are tested quarterly in our factories with Underwriters Laboratories.

#### Receptacles

---

**Fed. Spec. Test: Ground Pin Retention Test** - The grounding contact of the receptacle is conditioned by twenty insertions with a 0.204 inch oversized diameter pin. After conditioning, a 0.184 inch diameter pin is inserted in the grounding contact must be capable of supporting a weight of at least 4 ounces for one minute.

**Fed. Spec. Test: Power Blade Retention Test** - A test plug with a single oversized blade measuring 0.075 inch thick is inserted into each current carrying contact for twenty conditioning cycles. When the conditioning cycles are completed, each contact must be capable of supporting, for one minute, 1.5 pounds secured to a single 0.055 inch thick solid steel blade without holes.

**HG Test: Abrupt Removal of Plug Test** - A steel bodied test plug with blades made of brass is inserted into the receptacle. A 10 pound weight dropped from at least 24 inches, pulls the plug out of the receptacle abruptly. This test is done eight times with the receptacle rotated in different positions to create the greatest stress to the face and contacts. Then, with the receptacle facing down, the grounding contact must retain a 4 ounce grounding pin with a 0.184 inch diameter for one minute. After this test there shall be no breakage of the receptacle that interferes with the receptacle function or to the integrity of the enclosure.

**Fed. Spec. Test: Assembly Security Test** - A force of 100 pounds is applied through the slots of the receptacle into the base while the bridge is supported at its screw mounting positions. Each receptacle is then examined for damage.

#### Plugs and Connectors

---

**HG Test: Impact Test** - A plug or connector wired with the minimum size flexible cord is subjected to an impact from a 10 pound cylindrical weight having a flat face with a 2 inch diameter dropped from a height of 18 inches. After the test, there shall be no breakage or other damage that may effect the function of the device.

**HG Test: Mechanical Drop Test** - The cord connector is wired to #18 AWG flexible cord and suspended horizontally. It is released so it impacts a hardwood surface 45 inches below the point of suspension. This is repeated for 1,300 cycles. After the test, there shall be no breakage, deformation or other effect that may interfere with the function of the device.

**HG Test: 500 Pound Crush Test** - A wired plug or connector is placed between two hardwood slabs while subjected to a force which is progressively increased to 500 pounds. After the test, there shall be no breakage, deformation or other effect that may interfere with the function of the device.

**HG Test: Strain Relief Test** - While assembled to a plug or connector but not wired to the terminals; the cord must remain securely fastened after a straight pull of 30 pounds and a rotary motion within 3 inch circles with a 10 pound force applied for two consecutive hours. Displacement of conductors, insulation and outer jacket of the flexible cord shall not exceed 0.031 inch. There shall be no cuts, rips or tears in the insulation of the cord.

# General Technical Data

## RoHS, WR, TR and LED Power Descriptions



### RoHS - Restriction of Hazardous Substances

This EU Directive, 2002/95/EC, prohibits the use of mercury, cadmium, lead, chromium VI, PBB (polybrominated biphenyls) and PBDE (polybrominated diphenyl ethers) in certain electrical products. The regulatory maximums for these items are 0.01%, by weight, for cadmium and 0.1%, by weight, for the other five items in each "homogenous unit" contained within that product. There are certain exemptions available from the RoHS requirements.



### Weather Resistant Receptacles

Per National Electrical Code (NEC®) Article 406.9; all 125 and 250 volt, 15 and 20 amp non-locking receptacles for use in damp or wet locations shall be a listed weather resistant type. Listed devices are required to have a WR marking on the face visible when installed.



### Tamper-Resistant Receptacles

Per National Electrical Code (NEC®) Article 406.12, 406.13, 406.14; all 125 volt, 15 and 20 amp receptacles in dwelling units, lodging guest rooms and suites, and child care facilities shall be a listed tamper resistant type. Dwelling units are defined as a single unit, providing complete and independent living facilities for one or more persons, including permanent provisions for living, sleeping, cooking and sanitation. Listed devices are required to have a TR marking on the face visible when installed without a cover plate.



### LED Power Indicators

Most popularly used to identify emergency circuits in hospitals, the LED power indicators are bright enough to be visible in low light as well as bright daylight conditions.

## Tamper-Resistant SG Series Duplex Receptacle, Hospital Grade. How the SG Tamper-Resistant Receptacle Works.

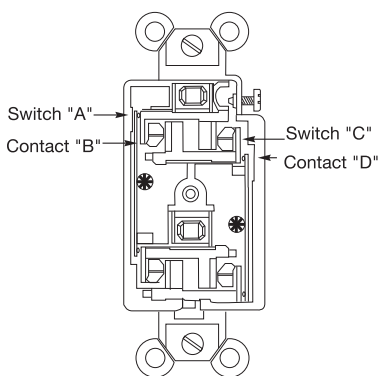

Figure 1

As shown in Figure 1, Switch "A" energizes the left hand Contact "B" and Switch "C" energizes the right hand Contact "D". The same arrangement applies to the lower portion of the outlet.

If, for example, a metallic object is inserted into the left power Contact "B" only, the object is not energized because it requires the additional insertion of a similar object in the opposite Contact "D" to move the slider to close Switch "A".

Similarly, if an object is inserted into the right hand slot only, it cannot become energized unless an additional object is inserted in the opposite slot to close Switch "C".

In other words it requires the presence of an object in both right and left hand contacts to energize the device. This condition is in practice fulfilled only by the insertion of the proper electrical plug as shown in Figure 2.

Remember, this receptacle can be used with either a 2 or 3 wire plug. No other tamper-resistant receptacle on the market can provide you with greater reliability and durability than the Hubbell hospital grade tamper resistant receptacle.

Complies with requirements of NEC Article 517-18(c).

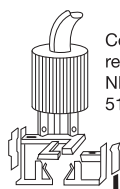

Figure 2

Complies with requirements of NEC Article 517-18(c).

NEC® is a registered trademark of the National Fire Protection Association (NFPA).

**Comparison Between NEMA Enclosure Type Numbers and IEC Enclosure Classification Designations**

IEC Publication 60529 Classification of Degrees of Protection Provided by Enclosures provides a system for specifying the enclosures of electrical equipment on the basis of the degree of protection provided by the enclosure. IEC 60529 does not specify degrees of protection against mechanical damage of equipment, risk of explosions, or conditions such as moisture (produced for example by condensation), corrosive vapors, fungus, or vermin. NEMA Standards Publication 250 does test for environmental condition such as corrosion, rust, icing, oil, and coolants. For this reason, and because the tests and evaluations for other characteristics are not identical, the IEC Enclosure Classification Designations cannot be exactly equated with NEMA Enclosure Type Numbers. The IEC designation consists of the letters IP followed by two numerals. The first characteristic numeral indicates the degree of protection provided by the enclosure with respect to persons and solid foreign objects entering the enclosure. The second characteristic numeral indicates the degree of protection provided by the enclosure with respect to the harmful ingress of water.

The table below provides an equivalent conversion from NEMA Enclosure Type Numbers to IEC Enclosure Classification Designations. The NEMA Types meet or exceed the test requirements for the associated IEC Classifications; for this reason the table cannot be used to convert from IEC Classifications to NEMA Types.

**Conversion of NEMA Type Numbers to IEC Classification Designations**

(Cannot be used to convert IEC classification designations to NEMA type numbers)

NEMA Enclosure Type Number	IEC Enclosure Classification Designation	Basic Description
1	IP10	General Purpose
2	IP11	Drip-proof- Indoor
3	IP54	Dusttight, Raintight and Sleet (Ice) Resistant- Outdoor
3R	IP14	Rainproof and Sleet (Ice) Resistant- Outdoor
3S	IP44, IP54	Dusttight, Raintight and Sleet (Ice) Proof- Outdoor
4	IP56	Watertight and Dusttight- Indoor and Outdoor
4X	IP56	Watertight, Dusttight and Corrosion-Resistant - Indoor and Outdoor
5	IP52	Superseded by Type 12 for Control Apparatus
6	IP67	Submersible, Watertight, Dusttight and Sleet (Ice) Resistant- Indoor and Outdoor
12	IP52	Industrial Use, Dusttight and Driptight- Indoor
12K	IP52	Industrial Use, Dusttight and Driptight with Knockouts- Indoor
13	IP54	Oiltight and Dusttight- Indoor

**Elements of the IP Code and Their Meanings - In Accordance with Standard IEC 60529**

IP Suitability Ratings are a system for classifying the degree of ingress protection provided by enclosures of electrical equipment. Generally, The higher the number, the greater the degree of protection; they apply ONLY to properly installed equipment.

**Example: IP67 = Ingress Protection/Dust-Tight/Temporary Immersion**

**Meaning for the Protection of Equipment**

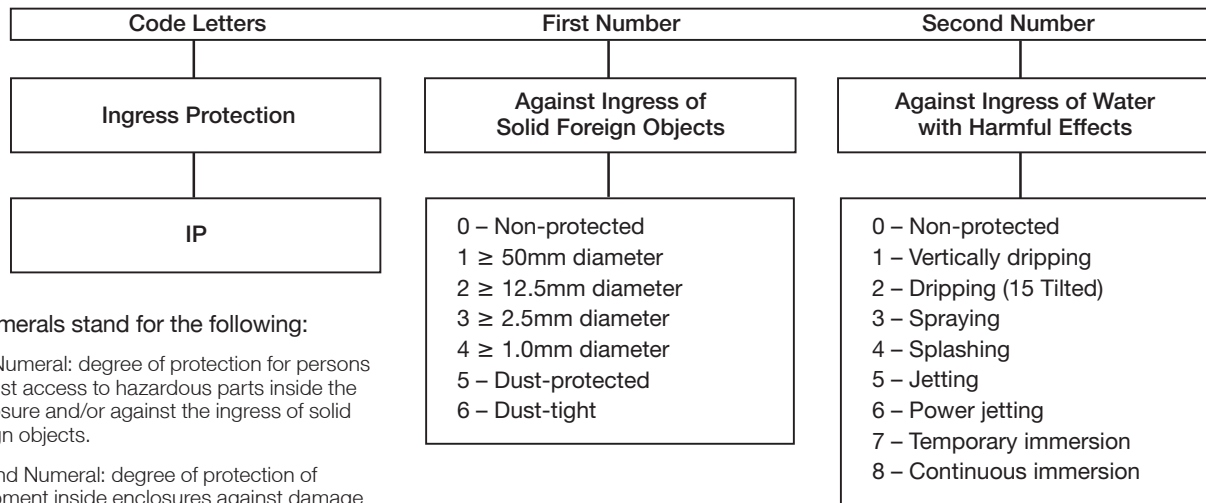

The numerals stand for the following:

1. First Numeral: degree of protection for persons against access to hazardous parts inside the enclosure and/or against the ingress of solid foreign objects.
2. Second Numeral: degree of protection of equipment inside enclosures against damage from the ingress of water.

# Enclosure Types for Self-Certified Non-Hazardous (Unclassified) Locations

	NEMA Standards Publication No. 250 Enclosures for Electrical Equipment (1000 Volts maximum)	UL50E Standard for Enclosures for Electrical Equipment Environmental Considerations	CAN/CSA C22.2 No. 94.2 Special Purpose Enclosures
Designation	Intended Use and Description	Intended Use and Description	Intended Use and Description
<b>Definition</b>	An enclosure is a surrounding case constructed to provide a degree of protection to personnel against incidental contact with the enclosed equipment and to provide a degree of protection to the enclosed equipment against specified environmental conditions.	Enclosure - A surrounding case constructed to provide a degree of protection against incidental contact with the enclosed equipment and to provide a degree of protection to the enclosed equipment against specified environmental conditions.	Enclosures...provide a degree of protection against accidental contact with the enclosed equipment, and to the enclosed equipment, against specified environmental conditions.
<b>Type 1</b>	Enclosures constructed for indoor use to provide a degree of protection to personnel against incidental contact with the enclosed equipment and to provide a degree of protection against falling dirt.	Indoor use primarily to provide a degree of protection against limited amounts of falling dirt.	No CSA equivalent.
<b>Type 2</b>	Enclosures constructed for indoor use to provide a degree of protection to personnel against incidental contact with the enclosed equipment, to provide a degree of protection against falling dirt, and to provide a degree of protection against dripping and light splashing of non-corrosive liquids.	Indoor use primarily to provide a degree of protection against limited amounts of falling water and dirt.	An enclosure for indoor use, constructed so as to provide a degree of protection against dripping and light splashing of non-corrosive liquids, and falling dirt.
<b>Type 3</b>	Enclosures constructed for either indoor or outdoor use to provide a degree of protection to personnel against incidental contact with the enclosed equipment; to provide a degree of protection against falling dirt, rain, sleet, snow, and windblown dust; and that will be undamaged by the external formation of ice on the enclosure.	Outdoor use primarily to provide a degree of protection against rain, sleet, windblown dust and damage from external ice formation.	An enclosure for either indoor or outdoor use, constructed so as to provide a degree of protection against rain, snow, and wind blown dust; undamaged by the external formation of ice on the enclosure.
<b>Type 3X</b>	Same as above and corrosion resistant.	Same as above and corrosion resistant.	Same as above and corrosion resistant.
<b>Type 3R</b>	Enclosures constructed for either indoor or outdoor use to provide a degree of protection to personnel against incidental contact with the enclosed equipment; to provide a degree of protection against falling dirt, rain, sleet, and snow; and that will be undamaged by the external formation of ice on the enclosure.	Outdoor use primarily to provide a degree of protection against rain, sleet, and damage from external ice formation.	An enclosure for either indoor or outdoor use, constructed so as to provide a degree of protection against rain and snow, undamaged by the external formation of ice on the enclosure.
<b>Type 3RX</b>	Same as above and corrosion resistant.	Same as above and corrosion resistant.	Same as above and corrosion resistant.
<b>Type 3S</b>	Enclosures constructed for either indoor or outdoor use to provide a degree of protection to personnel against incidental contact with the enclosed equipment; to provide a degree of protection against falling dirt, rain, sleet, snow, and windblown dust; and in which the external mechanism(s) remain operable when ice laden.	Outdoor use primarily to provide a degree of protection against rain, sleet, windblown dust, and to provide for operation of external mechanisms when ice laden.	An enclosure for either indoor or outdoor use, constructed so as to provide a degree of protection against rain, snow, and windblown dust, the external mechanism(s) remain operable while ice covered.
<b>Type 3SX</b>	Same as above and corrosion resistant.	Same as above and corrosion resistant.	Same as above and corrosion resistant.
<b>Type 4</b>	Enclosures constructed for either indoor or outdoor use to provide a degree of protection to personnel against incidental contact with the enclosed equipment; to provide a degree of protection against falling dirt, rain, sleet, snow, windblown dust, splashing water, and hose-directed water, and that will be undamaged by the external formation of ice on the enclosure.	Indoor or outdoor use primarily to provide a degree of protection against windblown dust and rain, splashing water, hose-directed water, and damage from external ice formation.	An enclosure for either indoor or outdoor use, constructed so as to provide a degree of protection against rain, snow, windblown dust, splashing and hose-directed water; undamaged by the external formation of ice on the enclosure.
<b>Type 4X</b>	Enclosures constructed for either indoor or outdoor use to provide a degree of protection to personnel against incidental contact with the enclosed equipment; to provide a degree of protection against falling dirt, rain, sleet, snow, windblown dust, splashing water, hose-directed water, and corrosion; and that will be undamaged by the external formation of ice on the enclosure.	Indoor or outdoor use primarily to provide a degree of protection against corrosion, windblown dust and rain, splashing water, hose-directed water and damage from external ice formation.	An enclosure for either indoor or outdoor use, constructed so as to provide a degree of protection against rain, snow, windblown dust, splashing and hose-directed water, undamaged by the external formation of ice on the enclosure; resists corrosion.

# General Technical Data

## Enclosure Types for Self-Certified Non-Hazardous (Unclassified) Locations

	NEMA Standards Publication No. 250 Enclosures for Electrical Equipment (1000 Volts maximum)	UL50E Standard for Enclosures for Electrical Equipment Environmental Considerations	CAN/CSA C22.2 No. 94.2 Special Purpose Enclosures
Designation	Intended Use and Description	Intended Use and Description	Intended Use and Description
<b>Type 5</b>	Enclosures constructed for indoor use to provide a degree of protection to personnel against incidental contact with the enclosed equipment; to provide a degree of protection against falling dirt; against settling airborne dust, lint, fibers, and flyings; and to provide a degree of protection against dripping and light splashing of liquids.	Indoor use primarily to provide a degree of protection against settling airborne dust, falling dirt, and dripping non-corrosive liquids.	An enclosure for indoor use, constructed so as to provide a degree of protection against dripping and light splashing of non-corrosive liquids and settling dust, lint, fibers, and flyings.
<b>Type 6</b>	Enclosures constructed for either indoor or outdoor use to provide a degree of protection to personnel against incidental contact with the enclosed equipment; to provide a degree of protection against falling dirt; against hose directed water and the entry of water during occasional temporary submersion at a limited depth; and that will be undamaged by the external formation of ice on the enclosure.	Indoor or outdoor use primarily to provide a degree of protection against hose-directed water, the entry of water during occasional temporary submersion at a limited depth, and damage from external ice formation.	An enclosure for either indoor or outdoor use, constructed so as to provide a degree of protection against the entry of water during occasional temporary submersion at a limited depth; undamaged by the external formation of ice on the enclosure.
<b>Type 6P</b>	Enclosures constructed for either indoor or outdoor use to provide a degree of protection to personnel against incidental contact with the enclosed equipment; to provide a degree of protection against falling dirt; against hose-directed water and the entry of water during prolonged submersion at a limited depth; and that will be undamaged by the external formation of ice on the enclosure.	Indoor or outdoor use primarily to provide a degree of protection against hose-directed water, the entry of water during prolonged submersion at a limited depth, and damage from external ice formation.	An enclosure for either indoor or outdoor use, constructed so as to provide a degree of protection against the entry of water during prolonged submersion at a limited depth; undamaged by the external formation of ice on the enclosure; resists extended corrosion.
<b>Type 12</b>	Enclosures constructed (without knockouts) for indoor use to provide a degree of protection to personnel against incidental contact with the enclosed equipment; to provide a degree of protection against falling dirt; against circulating dust, lint, fibers, and flyings; and against dripping and light splashing of liquids.	Indoor use primarily to provide a degree of protection against circulating dust, falling dirt, and dripping non-corrosive liquids.	An enclosure for indoor use, constructed so as to provide a degree of protection against circulating dust, lint fibers, and flyings; dripping and light splashing of non-corrosive liquids; and provided with knockouts.
<b>Type 12K</b>	Enclosures constructed (with knockouts) for indoor use to provide a degree of protection to personnel against incidental contact with the enclosed equipment; to provide a degree of protection against falling dirt; against circulating dust, lint, fibers, and flyings; and against dripping and light splashing of liquids.	Indoor use primarily to provide a degree of protection against circulating dust, falling dirt, and dripping non-corrosive liquids.	An enclosure for indoor use, constructed so as to provide a degree of protection against circulating dust, lint fibers, and flyings; dripping and light splashing of non-corrosive liquids; and provided with knockouts.
<b>Type 13</b>	Enclosures constructed for indoor use to provide a degree of protection to personnel against incidental contact with the enclosed equipment; to provide a degree of protection against falling dirt; against circulating dust, lint, fibers, and flyings; and against the spraying, splashing, and seepage of water, oil, and non-corrosive coolants.	Indoor use primarily to provide a degree of protection against dust, spraying of water, oil, and non-corrosive coolant.	An enclosure for indoor use, constructed so as to provide a degree of protection against circulating dust, lint, fibers, and flyings; seepage and spraying of non-corrosive liquids including oils and coolants.

# General Technical Data

## Circuit Wiring Diagrams

### Wiring Diagrams for NEMA Configurations

(Configurations shown are for female devices)

#### 125V – 2P, 2W

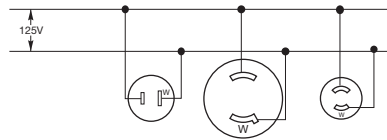

ANSI/NEMA WD-6 1-15R 1L1-15R ML1-R

#### 250V – 2P, 2W

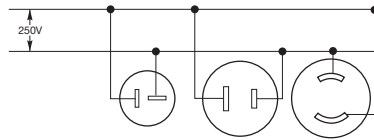

ANSI/NEMA WD-6 2-20R 2-30R L2-20R

#### 208V AC Line-to-Line\* – 2P, 2W

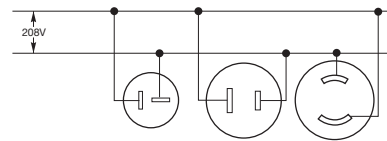

ANSI/NEMA WD-6 2-20R 2-30R L2-20R

#### 125V – 2P, 3W – Grounding

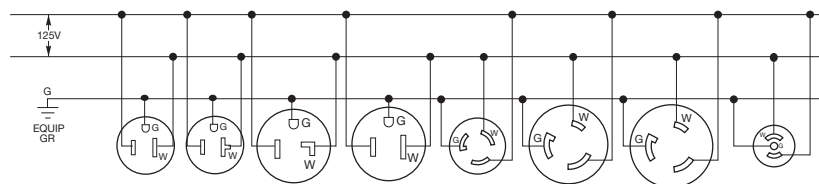

ANSI/NEMA WD-6 5-15R 5-20R 5-30R 5-50R L5-15R L5-20R L5-30R ML2-R

#### 250V – 2P, 3W – Grounding

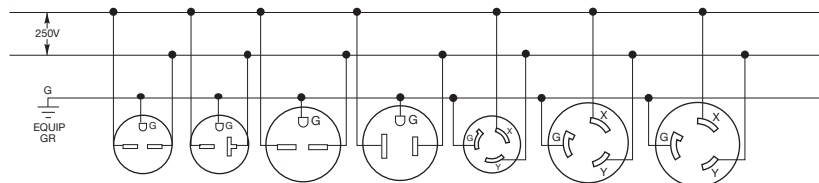

ANSI/NEMA WD-6 6-15R 6-20R 6-30R 6-50R L6-15R L6-20R L6-30R

#### 208V AC Line-to-Line\* – 2P, 3W – Grounding

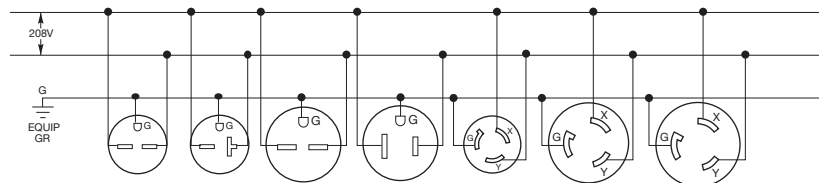

ANSI/NEMA WD-6 6-15R 6-20R 6-30R 6-50R L6-15R L6-20R L6-30R

Note: \*Does NOT encompass 208V AC Line-to-Neutral.  
The above diagrams are intended to show device terminal identification only.



# General Technical Data

## Circuit Wiring Diagrams

### Wiring Diagrams for NEMA Configurations

(Configurations shown are for female devices)

#### 277V AC – 2P, 3W – Grounding

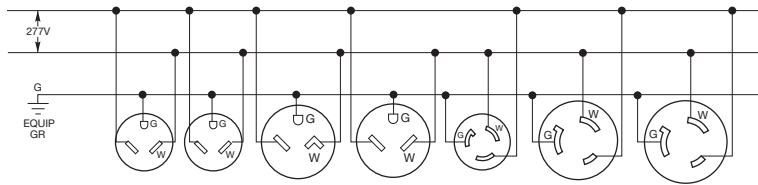

ANSI/NEMA WD-6 7-15R 7-20R 7-30R 7-50R L7-15R L7-20R L7-30R

#### 347V AC – 2P, 3W – Grounding

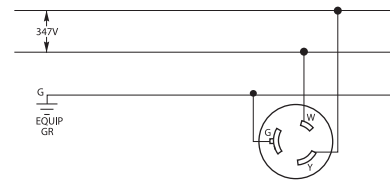

ANSI/NEMA WD-6 L24-20R

#### 480V AC – 2P, 3W – Grounding

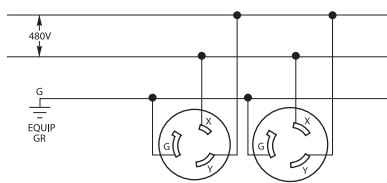

ANSI/NEMA WD-6 L8-20R L8-30R

#### 600V AC – 2P, 3W – Grounding

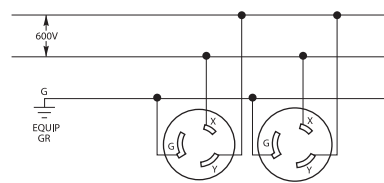

ANSI/NEMA WD-6 L9-20R L9-30R

#### 125/250V – 3P, 3W

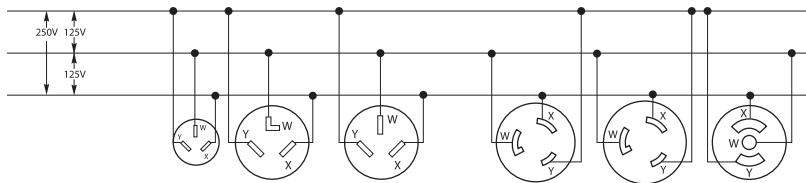

ANSI/NEMA WD-6 10-20R 10-30R 10-50R L10-20R L10-30R ML3-R

#### 1Ø 120/208YV AC – 3P, 3W

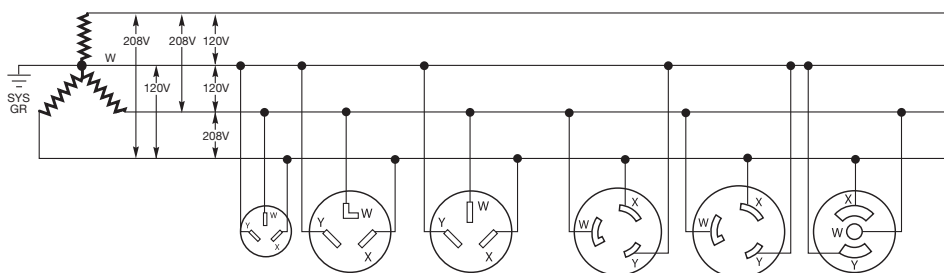

ANSI/NEMA WD-6 10-20R 10-30R 10-50R L10-20R L10-30R ML3-R

Note: The above diagrams are intended to show device terminal identification only.

# General Technical Data

## Circuit Wiring Diagrams

### Wiring Diagrams for NEMA Configurations

(Configurations shown are for female devices)

#### 3Ø 250V AC – 3P, 3W

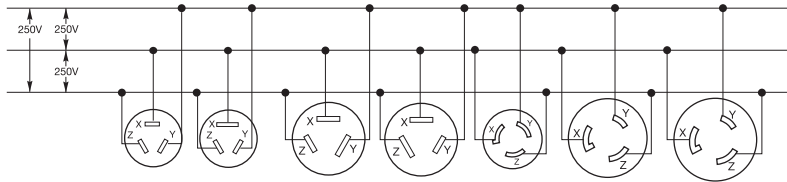

ANSI/NEMA WD-6 11-15R 11-20R 11-30R 11-50R L11-15R L11-20R L11-30R

#### 3Ø 480V AC – 3P, 3W

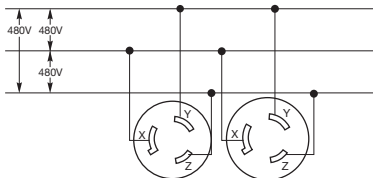

ANSI/NEMA WD-6 L12-20R L12-30R

#### 3Ø 600V AC – 3P, 3W

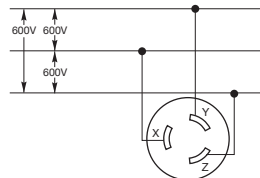

ANSI/NEMA WD-6 L13-30R

#### 125/250V – 3P, 4W

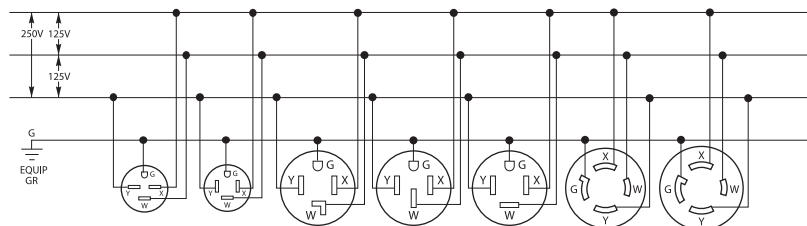

ANSI/NEMA WD-6 14-15R 14-20R 14-30R 14-50R 14-60R L14-20R L14-30R

#### 1Ø 120/208YV AC – 3P, 4W – Grounding

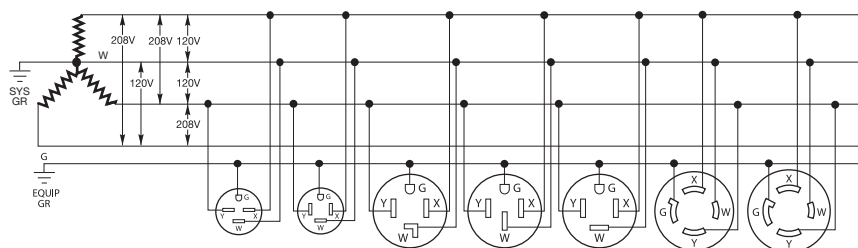

ANSI/NEMA WD-6 14-15R 14-20R 14-30R 14-50R 14-60R L14-20R L14-30R

Note: The above diagrams are intended to show device terminal identification only.

# General Technical Data

## Circuit Wiring Diagrams

### Wiring Diagrams for NEMA Configurations

(Configurations shown are for female devices)

#### 3Ø 250V – 3P, 4W – Grounding

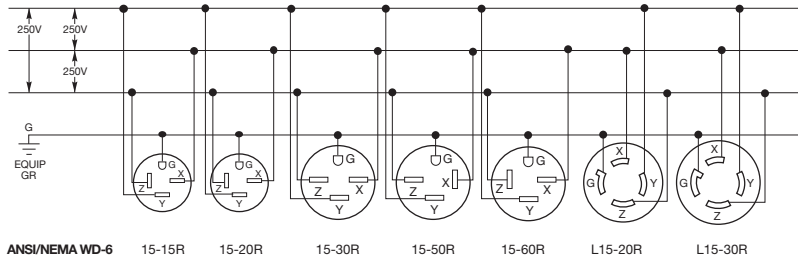

#### 3ØY 277/480V AC – 4P, 4W

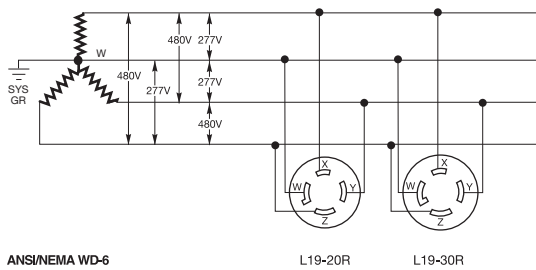

#### 3ØY 347/600V AC – 4P, 4W

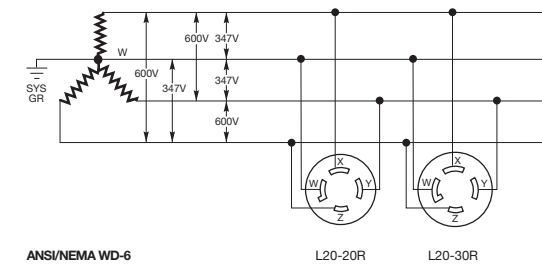

#### 3Ø 480V AC – 3P, 4W – Grounding

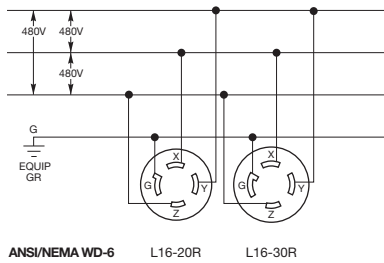

#### 3Ø 600V AC – 3P, 4W – Grounding

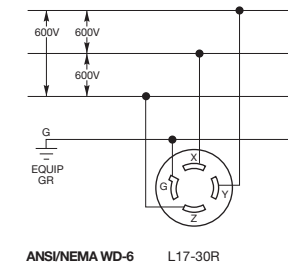

#### 3ØY 120/208V AC – 4P, 4W

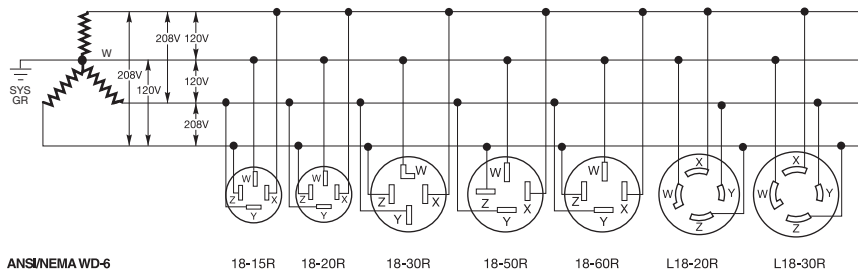

Note: The above diagrams are intended to show device terminal identification only.

# General Technical Data

## Circuit Wiring Diagrams

### Wiring Diagrams for NEMA Configurations

(Configurations shown are for female devices)

#### 3ØY 120/208V AC – 4P, 5W – Grounding

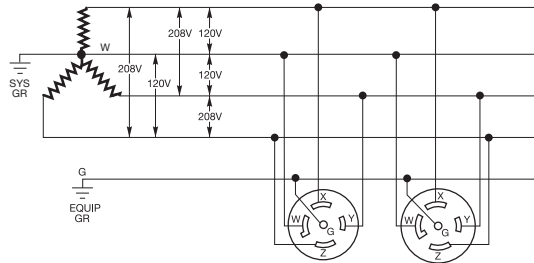

ANSI/NEMA WD-6

L21-20R

L21-30R

#### 3ØY 277/480V AC – 4P, 5W – Grounding

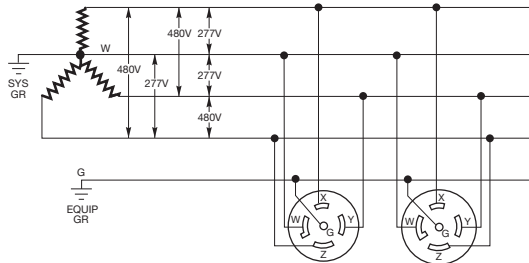

ANSI/NEMA WD-6

L22-20R

L22-30R

#### 3ØY 347/600V AC – 4P, 5W – Grounding

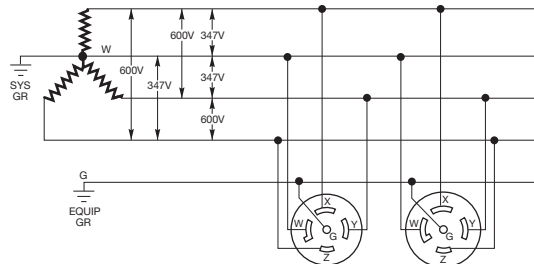

ANSI/NEMA WD-6

L23-20R

L23-30R

#### 3ØY 220/380V AC – 4P, 5W – Grounding

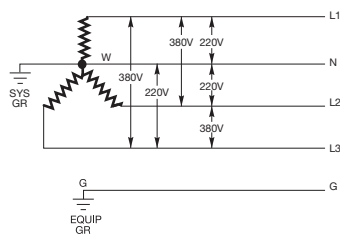

#### 3ØY 240/415V AC – 4P, 5W – Grounding

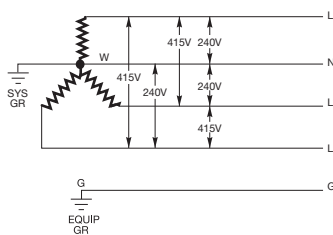

Note: The above diagrams are intended to show device terminal identification only.

# General Technical Data

## Horsepower Ratings and UL 508A Table SB4.1

### Horsepower Ratings for NEMA Configurations – Plugs and Receptacles Only

Straight Blade				Locking			
NEMA Configuration	AC HP Rating <sup>1</sup>	NEMA Configuration	AC HP Rating <sup>1</sup>	NEMA Configuration	AC HP Rating <sup>1</sup>	NEMA Configuration	AC HP Rating <sup>1</sup>
1-15	0.5	11-15	2	L1-15	0.5	L11-15	2
2-15	1.5*	11-20	3	L2-20	2*	L11-20	3
2-20	2*	11-30	3	L5-15	0.5	L11-30	3
2-30	2*	11-50	7.5	L5-20	1		
5-15	0.5	14-15	1.5 L-L*	L5-30	2	L12-20	5
5-20	1		0.5 L-N	L6-15	1.5*	L12-30	10
5-30	2	14-20	2 L-L*	L6-20	2*	L14-20	2 L-L*
5-50	2		1 L-N	L6-30	2*		1 L-N
6-15	1.5*	14-30	2 L-L*	L7-15	2	L14-30	2 L-L*
6-20	2*		1 L-N	L7-20	2		2 L-N
6-30	2*	14-50	2 L-L*	L7-30	3	L15-20	3
6-50	3*		2 L-N			L15-30	3
7-15	2	14-60	3 L-L*	L8-20	3	L16-20	5
7-20	2		2 L-N	L8-30	5	L16-30	10
7-30	3	15-15	2			L18-20	2
7-50	5	15-20	3			L18-30	3
		15-30	3	L10-20	2 L-L*	L19-20	5
10-20	2 L-L*	15-50	7.5		1 L-N	L19-30	10
	1 L-N	15-60	10	L10-30	2 L-L*	L21-20	2
10-30	2 L-L*	18-15	2		2 L-N	L21-30	3
	2 L-N	18-20	2			L22-20	5
10-50	3 L-L*	18-30	3			L22-30	10
	2 L-N	18-50	7.5				
		18-60	7.5				

Note: <sup>1</sup>The phase to phase horsepower ratings are noted "L-L". The phase to neutral ratings are identified "L-N".  
<sup>2</sup>Also suitable for 208V Line-to-Line, not 208V Line-to-Neutral.

### UL 231 Tab3 2.1, UL 508A Table SB4.1, UL 891 Table 16 - Assumed Maximum Short Circuit Current Rating for Unmarked Components When Used in UL 231 Power Outlets, UL 508A Industrial Control Panels, and UL 891 Switchboards

Component	Short Circuit Current Rating, kA
Bus bars	10
Circuit breaker (including GFCI type)	5
Current meters	a
Current shunt	10
Fuseholder	10
Industrial control equipment:	
a. Auxiliary devices (overload relay)	5
b. Switches (other than mercury tube type)	5
c. Mercury tube switches	
- Rated over 60 amperes or over 250 volts	5
- Rated 250 volts or less, 60 amperes or less, and over 2 kVA	3.5
- Rated 250 volts or less and 2 kVA or less	1
Motor controller, rated in horsepower (kW)	
a. 0 – 50 (0 – 37.3)	5c
b. 51 – 200 (38 – 149)	10c
c. 201 – 400 (150 – 298)	18c
d. 401 – 600 (299 – 447)	30c
e. 601 – 900 (448 – 671)	42c
f. 901 – 1500 (672 – 1193)	85c
Meter socket base	10
Miniature or miscellaneous fuse	10b
Receptacle (GFCI type)	2
Receptacle (other than GFCI type)	10
Supplementary protector	0.2
Switch unit	5
Terminal block or power distribution block	10

Note: a A short circuit current rating is not required when connected via a current transformer or current shunt.  
 A directly connected current meter shall have a marked short circuit current rating.  
 b The use of a miniature fuse is limited to 125-volt circuits.  
 c Standard fault current rating for motor controller rated within specified horsepower range.

# General Technical Data

## Isolated Ground Story

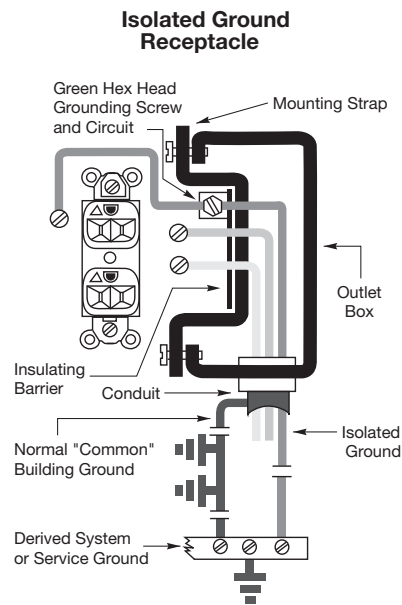
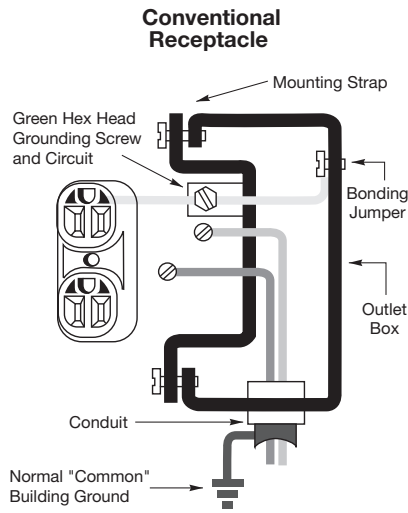

### Hubbell Isolated Ground Receptacles

Why do you need an isolated ground device?

When mounting a conventional receptacle in a steel box, the ground is commonly established through the existing electrical system. This is done by using either the grounding clip on the receptacle's mounting strap, or by running a ground wire (which is part of the "normal" existing system) to the green grounding screw.

In a conventional receptacle the grounding contacts are connected to the mounting strap and the green grounding screw. Thus, even when a separate green wire is brought to the receptacle, it is still tied into the normal ground. This occurs since the mounting strap is in contact with the box grounding system, therefore, a "pure" isolated path to the ground is not established.

### The Problem

The conventional grounding receptacle provides safety for personnel and equipment. However, the ground network also serves as a giant antenna and conductor of electrical noise. This electrical noise is electromagnetic interference and is caused by numerous transient ground currents. This can produce random transient electrical signals on the grounding system.

As a result, sensitive electronic equipment such as point of purchase terminals, accounting machines, computers and highly sensitive medical and communications equipment, can pick up these transient signals. This can interfere with the proper operation of the equipment.

### The Solution

The isolated ground receptacle is similar to a conventional receptacle except for one important change. Insulating barrier construction, first patented by Hubbell, isolates the ground contacts from the mounting strap. The green grounding screw is connected directly to the grounding contacts. The isolated equipment grounding circuit is completed by running an isolated ground wire to the green grounding screw. This ground wire passes through intermediate panel boards without being connected to their grounding terminal and terminates directly at an equipment grounding conductor terminal of the derived system or service, in accordance with NEC<sup>®</sup> requirements.

### The Result

This "isolated ground" can be kept relatively free of electrical noise. This is achieved since the grounding network has less branches, fewer sources of noise, and is connected to the ground at a single point.

*NEC<sup>®</sup> is a registered trademark of the National Fire Protection Association (NFPA).*

# General Technical Data

## Decimal Equivalents Table

Decimal Equivalents Table

Inches	Inches	Millimeters	Inches	Inches	Millimeters
$\frac{1}{64}$	.015625	.3969	$\frac{33}{64}$	.515625	13.0969
$\frac{1}{32}$	.03125	.7938	$\frac{17}{32}$	.53125	13.4938
$\frac{3}{64}$	.046875	1.1906	$\frac{35}{64}$	.546875	13.8906
$\frac{1}{16}$	.0625	1.5875	$\frac{9}{16}$	.5625	14.2875
$\frac{5}{64}$	.078125	1.9844	$\frac{37}{64}$	.578125	14.6844
$\frac{3}{32}$	.09375	2.3813	$\frac{19}{32}$	.59375	15.0813
$\frac{7}{64}$	.109375	2.7781	$\frac{39}{64}$	.609375	15.4781
$\frac{1}{8}$	.1250	3.1750	$\frac{5}{8}$	.6250	15.8750
$\frac{9}{64}$	.140625	3.5719	$\frac{41}{64}$	.640625	16.2719
$\frac{5}{32}$	.15625	3.9688	$\frac{21}{32}$	.65625	16.6688
$\frac{11}{64}$	.171875	4.3656	$\frac{43}{64}$	.671875	17.0656
$\frac{3}{16}$	.1875	4.7625	$\frac{11}{16}$	.6875	17.4625
$\frac{13}{64}$	.203125	5.1594	$\frac{45}{64}$	.703125	17.8594
$\frac{7}{32}$	.21875	5.5563	$\frac{23}{32}$	.71875	18.2563
$\frac{15}{64}$	.234375	5.9531	$\frac{47}{64}$	.734375	18.6531
$\frac{1}{4}$	.2500	6.3500	$\frac{3}{4}$	.7500	19.0500
$\frac{17}{64}$	.265625	6.7469	$\frac{49}{64}$	.765625	19.4469
$\frac{9}{32}$	.28125	7.1438	$\frac{25}{32}$	.78125	19.8438
$\frac{19}{64}$	.296875	7.5406	$\frac{51}{64}$	.796875	20.2406
$\frac{5}{16}$	.3125	7.9375	$\frac{13}{16}$	.8125	20.6375
$\frac{21}{64}$	.328125	8.3344	$\frac{53}{64}$	.828125	21.0344
$\frac{11}{32}$	.34375	8.7313	$\frac{27}{32}$	.84375	21.4313
$\frac{23}{64}$	.359375	9.1281	$\frac{55}{64}$	.859375	21.8281
$\frac{3}{8}$	.3750	9.5250	$\frac{7}{8}$	.8750	22.2250
$\frac{25}{64}$	.390625	9.9219	$\frac{57}{64}$	.890625	22.6219
$\frac{13}{32}$	.40625	10.3188	$\frac{29}{32}$	.90625	23.0188
$\frac{27}{64}$	.421875	10.7156	$\frac{59}{64}$	.921875	23.4156
$\frac{7}{16}$	.4375	11.1125	$\frac{15}{16}$	.9375	23.8125
$\frac{29}{64}$	.453125	11.5094	$\frac{61}{64}$	.953125	24.2094
$\frac{15}{32}$	.46875	11.9063	$\frac{31}{32}$	.96875	24.6063
$\frac{31}{64}$	.484375	12.3031	$\frac{63}{64}$	.984375	25.0031
$\frac{1}{2}$	.5000	12.7000	1	1.0000	25.4000

# General Technical Data

## Electrical Symbols and Abbreviations

In Accordance with American National Standards Institute

### Electrical Symbols and Abbreviations

#### General Outlets

##### Ceiling Wall

○ -○	Lighting Outlet
Ⓟ -Ⓟ	Blanked outlet
Ⓣ	Deep cord
ⓔ -ⓔ	Electrical outlet: for use only when circle used alone might be confused with columns, plumbing symbols, etc.
ⓕ -ⓕ	Fan outlet
ⓙ -ⓙ	Junction box
Ⓛ -Ⓛ	Lamp holder
Ⓛ <sub>s</sub> -Ⓛ <sub>s</sub>	Lamp holder with pull switch
Ⓢ -Ⓢ	Pull switch
Ⓥ -Ⓥ	Outlet for vapor discharge lamp
ⓧ -ⓧ	Exit light outlet
Ⓒ -Ⓒ	Clock outlet (specify voltage)

#### Convenience Outlets

Ⓧ	Duplex convenience outlet
Ⓧ <sub>1</sub>	Convenience outlet other than duplex 1-single, 3-triplex, etc.
Ⓧ <sub>w</sub>	Weatherproof convenience outlet
Ⓧ <sub>r</sub>	Range outlet
Ⓧ <sub>s</sub>	Switch and convenience outlet
Ⓧ <sub>R</sub>	Radio and convenience outlet
Ⓧ <sub>sp</sub>	Special purpose outlet (Des. in Spec.)
Ⓧ <sub>f</sub>	Floor outlet

#### Switch Outlets

S	Single pole switch
S <sub>2</sub>	Double pole switch
S <sub>3</sub>	Three way switch
S <sub>4</sub>	Four way switch
S <sub>D</sub>	Automatic door switch
S <sub>E</sub>	Electroliner switch
S <sub>K</sub>	Key operated switch
S <sub>P</sub>	Switch and pilot lamp
S <sub>CB</sub>	Circuit breaker switch
S <sub>WCB</sub>	Weatherproof circuit breaker
S <sub>MC</sub>	Momentary contact switch
S <sub>RC</sub>	Remote control switch
S <sub>WP</sub>	Weatherproof switch
S <sub>F</sub>	Fused switch
S <sub>WF</sub>	Weatherproof fused switch

#### Special Outlets

Any standard symbol as given above with the addition of a lower case subscript letter may be used to designate some special variation of standard equipment of particular interest in a specific set of architectural plans.

○<sub>a,b,c,etc.</sub> When used they must be listed in the Key of Symbols on each drawing and if necessary further described in the specifications.



#### Panels, Circuits and Miscellaneous

■	Lighting panel
▨	Power panel
—	Branch circuit; concealed in ceiling or wall
---	Branch circuit; concealed in floor
.....	Branch circuit; exposed
→→	Home run to panel board. Indicated number of circuits by number of arrows.
<i>Note: Any circuit without further designation indicates a two-wire circuit. For a greater number of wires indicate as follows: ## (3 wires) ### (4 wires), etc.</i>	
—	Feeders
<i>Note: Use heavy lines and designate by number of corresponding to listing in feeder schedule.</i>	
Ⓜ	Underfloor duct and junction box. Triple system
<i>Note: For double or single systems eliminate one or two lines. This symbol is equally adaptable to auxiliary system layouts.</i>	
ⓐ	Generator
Ⓜ	Motor
ⓐ	Instrument
ⓐ	Power transformer (or draw to scale)
Ⓧ	Controller
Ⓧ	Isolating switch

#### Auxiliary Systems

Ⓧ	Push Button	Ⓧ	Buzzer
Ⓧ	Bell	Ⓧ	Annunciator
Ⓧ	Outside telephone		
Ⓧ	Interconnecting telephone		
Ⓧ	Telephone switchboard		
Ⓧ	Bell ringing transformer		
Ⓧ	Electric door opener		
Ⓧ	Fire alarm bell	Ⓧ	Fire alarm station
Ⓧ	City fire alarm station		
Ⓧ	Fire alarm central station		
Ⓧ	Automatic fire alarm device		
Ⓧ	Watchman's station		
Ⓧ	Watchman's central station		
Ⓧ	Horn		
Ⓧ	Nurse's signal plug	Ⓧ	Maid's signal plug
Ⓧ	Radio outlet		
Ⓧ	Signal central section		
Ⓧ	Interconnection box	Ⓧ	Battery
----	Auxiliary system circuits.		

*Note: Any line without further designation indicates a 2-wire system. For a greater number of wires designate with numerals in manner similar to --- 12-No. 18 W-3'4"C, or designate by number corresponding to listing in schedule.*

#### Special auxiliary outlets

Subscript letters refer to notes on plans or detailed description in specifications.



# General Technical Data

## Diameter Ranges of Jacketed Cord and Wire Charts

### Diameter Ranges of Jacketed Cord Chart - In Accordance with Standard UL62

Acceptable range in inches (mm) of the average overall diameter of round, jacketed heater cords and non-retractile vacuum cleaner and service cords.

Type of Cord	AWG Size	2 Conductor	3 Conductor	4 Conductor	5 Conductor
SV, SVE, SVEO, SVOO	18	.22"-.26" (5.6-6.6)	.23"-.27" (5.8-6.9)	—	—
SVO, SVT, SVTOO, SVTO	16	.25"-.28" (6.2-7.1)	.26"-.30" (6.6-7.5)	—	—
SJ, SJE, SJOO, SJO, SJEO,	18	.28"-.32" (7.1-8.1)	.30"-.34" (7.6-8.6)	.33"-.37" (8.4-9.4)	—
SJEOOSJT, SJTO, SJTOO,	16	.31"-.34" (7.9-8.6)	.33"-.36" (8.4-9.1)	.35"-.40" (8.9-10.2)	—
SJEW, SJOOW, SJOW,	14	.34"-.38" (8.6-9.7)	.36"-.40" (9.1-10.2)	.39"-.44" (9.9-11.2)	—
SJEOW, SJEOOW, SJTW,	12	.41"-.46" (10.4-11.7)	.43"-.48" (10.9-12.2)	.47"-.52" (11.9-13.2)	—
SJTOW, SJTOOW	10	.54"-.61" (13.7-15.5)	.57"-.64" (14.5-16.3)	.63"-.70" (16.0-17.8)	—
S, SE, SOO, SEO, SEOO, ST	18	.34"-.39" (8.6-9.9)	.36"-.40" (9.1-10.2)	.39"-.43" (9.9-10.9)	.46"-.51" (11.7-13.0)
STOO, STO, SEW, SOOW,	16	.37"-.41" (9.4-10.4)	.39"-.43" (9.9-10.9)	.41"-.46" (10.4-11.7)	.49"-.55" (12.4-14.0)
SOW, SEOW, SEOO, STW,	14	.50"-.55" (12.7-14.0)	.52"-.58" (13.2-14.7)	.56"-.62" (14.2-15.7)	.63"-.71" (16.0-18.0)
STOOW, STOW	12	.57"-.63" (14.5-16.0)	.59"-.66" (15.0-16.8)	.64"-.71" (16.3-18.0)	.70"-.77" (17.8-19.6)
	10	.62"-.69" (15.7-17.5)	.65"-.72" (16.5-18.3)	.70"-.78" (17.8-19.8)	.76"-.84" (19.3-21.3)
	8	.78"-.88" (19.8-22.4)	.83"-.93" (21.1-23.6)	.93"-.1.05" (23.6-26.7)	1.00"-.1.15" (25.4-29.2)
	6	.92"-.1.05" (23.4-26.7)	.97"-.1.10" (24.6-27.9)	1.05"-.1.20" (26.7-30.5)	1.18"-.1.33" (30.0-33.8)
	4	1.06"-.1.21" (26.9-30.7)	1.13"-.1.28" (28.7-32.5)	1.25"-.1.45" (31.8-36.8)	—
	2	1.21"-.1.40" (30.7-35.6)	1.30"-.1.50" (33.0-38.1)	1.45"-.1.65" (36.8-41.9)	—

### Nominal Diameters of Round Portable Power Cable - In Accordance with Standard CSA-C22.2 No. 96

Type of Cord	AWG Size	2 Conductor	3 Conductor	4 Conductor	5 Conductor
W, G, G-GC, G-BGC, PPC	6	.945" (24.0)	.984" (25.0)	1.102" (28.0)	1.220" (31.0)
	4	1.063" (27.0)	1.142" (29.0)	1.260" (32.0)	1.417" (36.0)
	3	1.181" (30.0)	1.220" (31.0)	1.339" (34.0)	1.496" (38.0)
	2	1.260" (32.0)	1.339" (34.0)	1.496" (38.0)	1.614" (41.0)
	1	1.339" (34.0)	1.496" (38.0)	1.654" (42.0)	1.890" (48.0)
	1/0	1.417" (36.0)	1.614" (41.0)	1.772" (45.0)	1.929" (49.0)
	2/0	1.535" (39.0)	1.732" (44.0)	1.929" (49.0)	2.047" (52.0)
	3/0	1.654" (42.0)	1.890" (48.0)	2.047" (52.0)	2.244" (57.0)
	4/0	1.772" (45.0)	2.008" (51.0)	2.244" (57.0)	2.441" (62.0)

### Wire Types Approximate Diameter in Inches (mm)\*

Size (AWG or kcmil)	THHN, THWN, THWN-2 Inches (mm)	TW, THHW, THW, THW-2 Inches (mm)	XHHW, ZW, XHHW-2, XHH Inches (mm)
12	.013 (3.302)	.152 (3.861)	.152 (3.861)
10	.164 (4.166)	.176 (4.470)	.176 (4.470)
8	.216 (5.486)	.236 (5.994)	.236 (5.994)
6	.254 (6.452)	.304 (7.722)	.274 (6.960)
4	.324 (8.230)	.352 (8.941)	.322 (8.179)
3	.352 (8.941)	.380 (9.652)	.350 (8.890)
2	.384 (9.754)	.412 (1.46)	.382 (9.703)
1	.446 (11.23)	.492 (12.50)	.442 (11.23)
1/0	.486 (12.34)	.532 (13.51)	.482 (12.34)
2/0	.532 (13.51)	.578 (14.68)	.528 (13.41)
3/0	.584 (14.83)	.630 (16.00)	.580 (14.73)
4/0	.642 (16.31)	.688 (17.48)	.638 (16.21)
250	.711 (18.06)	.765 (19.43)	.705 (17.91)
300	.766 (19.46)	.820 (2.83)	.760 (19.30)
350	.817 (2.75)	.871 (22.12)	.811 (20.60)
400	.864 (21.95)	.918 (23.32)	.858 (21.79)
500	.949 (24.10)	1.003 (25.48)	.943 (23.95)
600	1.051 (26.70)	1.113 (28.27)	1.053 (26.75)
700	1.122 (28.50)	1.184 (3.07)	1.124 (28.55)
750	1.156 (29.36)	1.218 (3.94)	1.158 (29.41)
800	1.188 (3.18)	1.250 (31.75)	1.190 (3.23)
900	1.252 (31.80)	1.314 (33.38)	1.254 (31.85)
1000	1.310 (33.27)	1.372 (34.85)	1.312 (33.32)

Note: \*Information sourced from the National Electrical Code.

# General Technical Data

## IEC Pin and Sleeve Terminal Identification

### IEC Pin and Sleeve Terminal Identification – Rear View

Description	Rating		Terminal Marking Pattern*			
	Domestic	International	Receptacle and Connector		Plug and Inlet	
			Domestic	International	Domestic	International
3 Wire	125V AC 277V AC	100-130V				
3 Wire	250V AC 480V AC 600V AC	200-250V 380-415V AC				
4 Wire	125/250V AC 1ØY 120/208V	—				
4 Wire	(3Ø Δ) 250V AC 480V AC 600V AC	380-415V AC				
5 Wire	(3ØY) 120/208V AC 277/480V AC 347/600V AC	220/380V 50Hz 250/440V 60Hz 200/346V to 240/415V 50 and 60Hz				

Note: \*Location of grounding contact position will change as clock positions assigned to specific voltages change.

★Pilot contacts supplied on 4 and 5 wire, 63 and 125 Amp international rated devices.

General Technical Data  
**Horsepower Ratings**  
*For IEC Pin and Sleeve*

**Horsepower Ratings for IEC Pin and Sleeve**

Catalog Number				AC Voltage Rating	HP Rating
HBL420R9W	HBL420P9W	HBL420C9W	HBL420B9W	3Ø 250	2
HBL420R7W	HBL420P7W	HBL420C7W	HBL420B7W	3Ø 480	5
HBL420R5W	HBL420P5W	HBL420C5W	HBL420B5W	3Ø 600	7.5
HBL520R9W	HBL520P9W	HBL520C9W	HBL520B9W	3ØY 120/208	0.5
HBL520R7W	HBL520P7W	HBL520C7W	HBL520B7W	3ØY 277/480	5
HBL520R5W	HBL520P5W	HBL520C5W	HBL520B5W	3ØY 347/600	7.5
HBL430R9W	HBL430P9W	HBL430C9W	HBL430B9W	3Ø 250	3
HBL430R7W	HBL430P7W	HBL430C7W	HBL430B7W	3Ø 480	7.5
HBL430R5W	HBL430P5W	HBL430C5W	HBL430B5W	3Ø 600	10
HBL530R9W	HBL530P9W	HBL530C9W	HBL530B9W	3ØY 120/208	2
HBL530R7W	HBL530P7W	HBL530C7W	HBL530B7W	3ØY 277/480	7.5
HBL530R5W	HBL530P5W	HBL530C5W	HBL530B5W	3ØY 347/600	10
HBL460R9W	HBL460P9W	HBL460C9W	HBL460B9W	3Ø 250	5
HBL460R7W	HBL460P7W	HBL460C7W	HBL460B7W	3Ø 480	10
HBL460R5W	HBL460P5W	HBL460C5W	HBL460B5W	3Ø 600	15
HBL560R9W	HBL560P9W	HBL560C9W	HBL560B9W	3ØY 120/208	3
HBL560R7W	HBL560P7W	HBL560C7W	HBL560B7W	3ØY 277/480	10
HBL560R5W	HBL560P5W	HBL560C5W	HBL560B5W	3ØY 347/600	15
HBL4100R9W	HBL4100P9W	HBL4100C9W	HBL4100B9W	3Ø 250	10
HBL4100R7W	HBL4100P7W	HBL4100C7W	HBL4100B7W	3Ø 480	30
HBL4100R5W	HBL4100P5W	HBL4100C5W	HBL4100B5W	3Ø 600	30
HBL5100R9W	HBL5100P9W	HBL5100C9W	HBL5100B9W	3ØY 120/208	10
HBL5100R7W	HBL5100P7W	HBL5100C7W	HBL5100B7W	3ØY 277/480	30
HBL5100R5W	HBL5100P5W	HBL5100C5W	HBL5100B5W	3ØY 347/600	30

# General Technical Data

## Network Cabling Requirements

### Supported Media - International

Designation	ANSI/TIA-568-C	ISO/IEC 11801 Amend 2: 2010	GENELEC EN-50173-1: 2002
Category 3 (16 MHz)	Supported	Supported: Class C	Supported: Class C
Category 5e (100 MHz)	Supported	Supported: Class D	Supported: Class D
Category 6 (250 MHz)	Supported	Supported: Class E	Supported: Class E
Category 6A (500 MHz)	Supported	Supported: Class EA	Supported: Class EA
Category 7 (600 MHz)	Not Recognized	Supported: Class F	Supported: Class F
Category 7A (1,000 MHz)	Not Recognized	Supported: Class FA*	Supported: Class FA*
Category 8 (2,000 MHz)	Not Recognized	Supported: Class FA*	Supported: Class FA*
50/125 - 62.5/125 Multimode	Supported	Supported	Supported
Singlemode Fiber	Supported	Supported	Supported
Singlemode Fiber to the Work Area	Not Supported	Supported	Supported
Work Area Outlet Configuration	4 Pairs T568A or B	4 Pairs T568A Only	4 Pairs T568A Only
Stranded Patch Cord Attenuation	120% of Horiz. Cable	150% of Horiz. Cable	150% of Horiz. Cable

Note: \*Category 8 proposed in TIA 568-C.2-1 for 40 GBASE-T. ISO/IEC and cenelec to be determined. ISO/IEC and cenelec considering expanding Class FA frequency in addition to a considering new Class.

- Strip back only as much cable jacket as is required for termination and maintain pair twists as close as possible to the point of mechanical termination
- At a minimum, never allow untwisting of pairs as specified:  
Category 5e and 6/6A: 0.5 inch max.

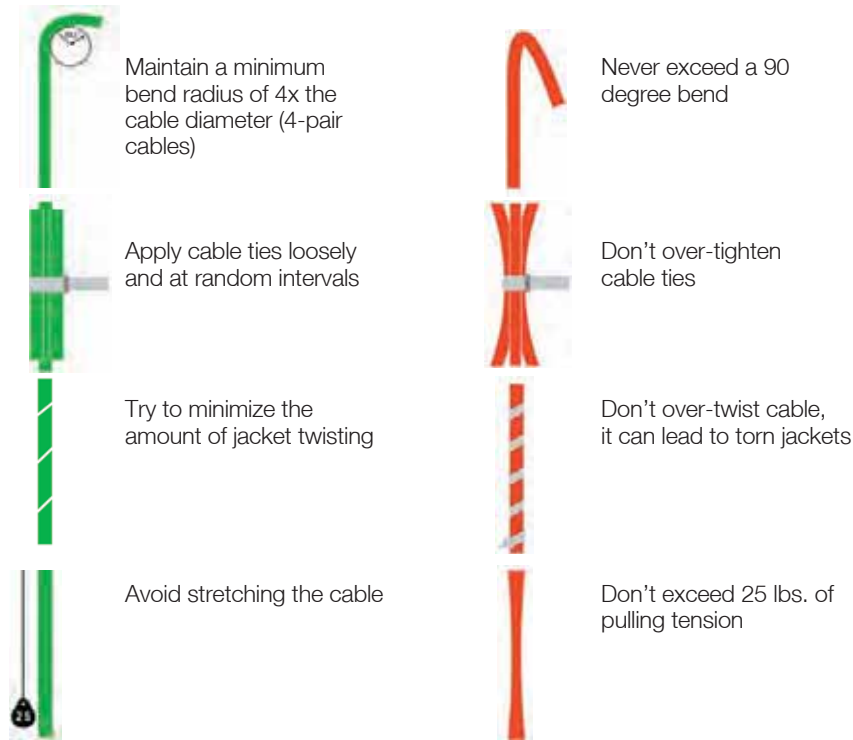

Use appropriate methods for dressing and securing cables:

- Cable ties
- Cable support bar
- Wire management panels
- Releasable straps

Don't use a staple gun to position cable

# Catalog Number Index

Catalog Number	Page	Catalog Number	Page	Catalog Number	Page	Catalog Number	Page
2172	A-7,L-7	02202005	V-29	02203041	V-30	02211040	V-37
2182	A-7,L-7	02202006	V-29	02203042	V-30	02211041	V-37
7452	N-21	02202007	V-29	02203043	V-30	02211042	V-37
8200	A-6,L-6	02202008	V-29	02203044	V-30	02211043	V-37
8300	A-6,L-6	02202009	V-29	02203045	V-30	02211061	V-37
15901	W-3	02202010	V-29	02203046	V-30	02211062	V-37
159010	W-3	02202011	V-29	02203047	V-30	02211063	V-37
01301008	V-14	02202012	V-29	02203048	V-30	02211072	V-37
01301013	V-14	02202013	V-28	02203064	V-31	02211073	V-37
01304009	V-14	02202014	V-28	02203065	V-31	02211100	V-37
01304010	V-14	02202015	V-28	02203066	V-31	02211101	V-37
01304011	V-14	02202017	V-28	02203068	V-31	02211106	V-37
01304013	V-14	02202018	V-28	02203069	V-31	02211107	V-37
01304015	V-14	02202019	V-28	02203070	V-31	02212003	V-38
01304017	V-14	02202020	V-28	02203071	V-31	02212007	V-38
01304029	V-14	02202021	V-28	02203072	V-31	02212010	V-38
01304037	V-14	02202022	V-28	02203073	V-31	02212012	V-38
01304054	V-14	02202023	V-28	02203074	V-31	02212013	V-38
01304055	V-14	02202024	V-28	02206001	V-33	02212017	V-38
01304064	V-14	02202037	V-30	02206002	V-33	02212018	V-38
02201001	V-29	02202038	V-30	02206003	V-33	02212023	V-38
02201002	V-29	02202039	V-30	02206004	V-33	02212024	V-38
02201003	V-29	02202041	V-30	02206005	V-33	02212025	V-38
02201005	V-29	02202042	V-30	02206006	V-33	02212026	V-38
02201006	V-29	02202043	V-30	02206007	V-33	02212033	V-38
02201007	V-29	02202044	V-30	02206008	V-33	02212034	V-38
02201008	V-29	02202045	V-30	02206009	V-33	02212040	V-38
02201009	V-29	02202046	V-30	02206010	V-32	02212041	V-38
02201010	V-29	02202047	V-30	02206011	V-32	02212042	V-38
02201011	V-29	02202048	V-30	02206012	V-32	02212043	V-38
02201012	V-29	02202050	V-31	02206013	V-32	02212061	V-38
02201013	V-28	02202051	V-31	02207001	V-33	02212073	V-38
02201014	V-28	02202052	V-31	02207002	V-33	02213003	V-39
02201015	V-28	02202054	V-31	02207003	V-33	02213007	V-39
02201017	V-28	02202055	V-31	02207004	V-33	02213009	V-39
02201018	V-28	02202056	V-31	02207005	V-33	02213012	V-39
02201019	V-28	02202057	V-31	02207006	V-33	02213013	V-39
02201020	V-28	02202058	V-31	02207007	V-33	02213017	V-39
02201021	V-28	02202059	V-31	02207008	V-33	02213018	V-39
02201022	V-28	02202061	V-31	02207009	V-33	02213023	V-39
02201023	V-28	02203001	V-29	02207010	V-32	02213024	V-39
02201024	V-28	02203002	V-29	02207011	V-32	02213025	V-39
02201037	V-30	02203003	V-29	02207012	V-32	02213026	V-39
02201038	V-30	02203005	V-29	02207013	V-32	02213033	V-39
02201039	V-30	02203006	V-29	02208009	V-33	02213041	V-39
02201041	V-30	02203007	V-29	02209009	V-33	02213042	V-39
02201042	V-30	02203008	V-29	02211001	V-37	02216001	V-34
02201043	V-30	02203009	V-29	02211002	V-37	02216002	V-34
02201044	V-30	02203010	V-29	02211003	V-37	02216003	V-34
02201045	V-30	02203011	V-29	02211006	V-37	02216004	V-34
02201046	V-30	02203012	V-29	02211007	V-37	02216005	V-34
02201047	V-30	02203013	V-28	02211009	V-37	02216006	V-34
02201048	V-30	02203014	V-28	02211010	V-37	02216007	V-34
02201050	V-31	02203015	V-28	02211012	V-37	02216008	V-34
02201051	V-31	02203017	V-28	02211013	V-37	02216009	V-34
02201052	V-31	02203018	V-28	02211017	V-37	02216010	V-34
02201053	V-31	02203019	V-28	02211018	V-37	02216011	V-34
02201054	V-31	02203020	V-28	02211019	V-37	02216012	V-34
02201055	V-31	02203021	V-28	02211022	V-37	02216013	V-34
02201056	V-31	02203022	V-28	02211023	V-37	02216014	V-34
02201057	V-31	02203023	V-28	02211024	V-37	02216015	V-34
02201058	V-31	02203024	V-28	02211025	V-37	02216016	V-35
02202001	V-29	02203037	V-30	02211026	V-37	02216017	V-35
02202002	V-29	02203038	V-30	02211033	V-37	02216018	V-35
02202003	V-29	02203039	V-30	02211034	V-37	02216019	V-35

# Catalog Number Index

Catalog Number	Page	Catalog Number	Page	Catalog Number	Page	Catalog Number	Page
02216020	V-35	02401041	V-30	02403042	V-30	03301013	V-8
02216021	V-35	02401042	V-30	02403043	V-30	03301014	V-8
02216022	V-35	02401043	V-30	02403044	V-30	03301016	V-8
02216023	V-35	02401044	V-30	02403045	V-30	03301017	V-8
02216024	V-35	02401045	V-30	02403047	V-30	03301018	V-8
02216025	V-35	02401051	V-31	02403065	V-31	03301019	V-8
02216026	V-35	02401052	V-31	02403066	V-31	03301020	V-8
02216027	V-35	02401053	V-31	02403068	V-31	03301021	V-8
02216028	V-35	02401054	V-31	02403069	V-31	03301024	V-8
02216029	V-35	02401055	V-31	02403070	V-31	03301025	V-8
02216030	V-35	02401056	V-31	02406001	V-33	03301026	V-8
02217001	V-34	02401057	V-31	02406002	V-33	03301027	V-8
02217002	V-34	02401058	V-31	02406003	V-33	03301028	V-8
02217003	V-34	02402002	V-29	02406004	V-33	03301029	V-8
02217004	V-34	02402003	V-29	02406005	V-33	03301030	V-8
02217005	V-34	02402005	V-29	02406006	V-33	03301031	V-8
02217006	V-34	02402006	V-29	02406007	V-33	03301039	V-8
02217007	V-34	02402007	V-29	02406010	V-32	03301045	V-8
02217008	V-34	02402008	V-29	02406011	V-32	03301047	V-8
02217009	V-34	02402009	V-29	02406012	V-32	03302016	V-7
02217010	V-34	02402013	V-28	02406013	V-32	03302018	V-7
02217011	V-34	02402014	V-28	02407001	V-33	03302020	V-7
02217012	V-34	02402015	V-28	02407002	V-33	03302022	V-7
02217013	V-34	02402017	V-28	02407003	V-33	03302024	V-7
02217014	V-34	02402018	V-28	02407004	V-33	03302026	V-7
02217015	V-34	02402019	V-28	02407005	V-33	03302028	V-7
02217016	V-35	02402020	V-28	02407006	V-33	03302044	V-7
02217017	V-35	02402021	V-28	02407007	V-33	03302046	V-7
02217018	V-35	02402022	V-28	02407008	V-33	03302048	V-7
02217019	V-35	02402023	V-28	02407009	V-33	03302050	V-7
02217020	V-35	02402024	V-28	02407010	V-32	03302052	V-7
02217021	V-35	02402037	V-30	02407011	V-32	03302054	V-7
02217022	V-35	02402038	V-30	02407012	V-32	03302056	V-7
02217023	V-35	02402039	V-30	02407013	V-32	03302066	V-7
02217024	V-35	02402041	V-30	02416001	V-34	03302097	V-7
02217025	V-35	02402042	V-30	02416002	V-34	03303001	V-12
02217026	V-35	02402043	V-30	02416003	V-34	03303002	V-12
02217027	V-35	02402044	V-30	02416004	V-34	03303003	V-12
02217028	V-35	02402045	V-30	02416005	V-34	03303004	V-12
02217029	V-35	02402046	V-30	02416006	V-34	03303005	V-12
02217030	V-35	02402047	V-30	02416007	V-34	03303006	V-12
02401001	V-29	02402051	V-31	02416008	V-34	03303007	V-12
02401002	V-29	02403002	V-29	02416009	V-34	03303008	V-12
02401003	V-29	02403003	V-29	02416010	V-34	03303010	V-12
02401005	V-29	02403005	V-29	02416011	V-34	03303011	V-12
02401006	V-29	02403006	V-29	02416013	V-34	03303012	V-12
02401007	V-29	02403007	V-29	02416014	V-34	03303013	V-12
02401008	V-29	02403008	V-29	02416015	V-34	03303015	V-12
02401009	V-29	02403009	V-29	02417001	V-34	03303016	V-12
02401010	V-29	02403010	V-29	02417002	V-34	03303017	V-12
02401011	V-29	02403011	V-29	02417003	V-34	03303018	V-12
02401012	V-29	02403013	V-28	02417004	V-34	03303019	V-12
02401013	V-28	02403014	V-28	02417005	V-34	03303029	V-12
02401014	V-28	02403015	V-28	02417006	V-34	03305001	V-12
02401015	V-28	02403017	V-28	02417007	V-34	03305002	V-12
02401017	V-28	02403018	V-28	02417008	V-34	03305003	V-12
02401018	V-28	02403019	V-28	02417009	V-34	03305004	V-12
02401019	V-28	02403020	V-28	02417012	V-34	03305005	V-12
02401020	V-28	02403021	V-28	02417013	V-34	03305006	V-12
02401021	V-28	02403022	V-28	02417014	V-34	03305011	V-12
02401022	V-28	02403023	V-28	02417015	V-34	03308003	V-10
02401023	V-28	02403037	V-30	03301001	V-8	03308004	V-10
02401037	V-30	02403038	V-30	03301002	V-8	03308005	V-10
02401038	V-30	02403039	V-30	03301011	V-8	03308006	V-10
02401039	V-30	02403041	V-30	03301012	V-8	03308007	V-10

# Catalog Number Index

Catalog Number	Page	Catalog Number	Page	Catalog Number	Page	Catalog Number	Page
03308008	V-10	07401025	V-58,V-65,F-24	022291018	V-50	073031208	V-63
03308009	V-10	07401026	V-58,V-65	022291019	V-50	073031209	V-63
03308010	V-10	07401027	V-58,V-65	022291020	V-50	073031210	V-63
03308011	V-10	07401028	V-58,V-65	022291021	V-50	073031211	V-63
03309003	V-11	07401029	V-58,V-65	022291022	V-50	073031212	V-63
03309004	V-11	07401030	V-58,V-65	033011017	V-8	073031213	V-63
03309005	V-11	07401031	V-58,V-65	033021030	V-7	073031214	V-63
03309006	V-11	07401032	V-58,V-65	033021031	V-7	073031215	V-63
03309007	V-11	07401033	V-58	033021078	V-7	073041276	V-36
03309008	V-11	07401034	V-58	033021079	V-7	073041277	V-36
03309009	V-11	07401035	V-58	033021080	V-7	073041278	V-36
03309015	V-11	07401043	V-59	033021081	V-7	073041279	V-36
03309016	V-11	07401045	V-59	033041082	V-9	073041280	V-36
03309017	V-11	07401052	V-59	033041083	V-9	073041281	V-36
03309018	V-11	07401053	V-59	033041084	V-9	073041282	V-36
03309019	V-11	07401071	V-59	033041085	V-9	073041284	V-36
03310001	V-11	07401072	V-59	033041086	V-9	073041285	V-36
03310002	V-11	07401073	V-59	033041087	V-9	073041286	V-36
03310003	V-11	07401074	V-59	033041088	V-9	073041287	V-36
03310004	V-11	07401076	V-59	033041089	V-9	073041288	V-36
03310005	V-11	07401078	V-59	033041090	V-9	073041289	V-36
03310006	V-11	07401080	V-59	033041091	V-9	074011021	V-59
03310007	V-11	07401081	V-59	033041092	V-9	074011028	V-58
03310008	V-11	07401083	V-59	033041093	V-9	074011029	V-58
03310009	V-11	07401084	V-59	033041094	V-9	074011030	V-58
03310010	V-11	07401085	V-59	033041095	V-9	074011031	V-58
03310011	V-11	07401087	V-59	033041096	V-9	074011032	V-58
03316001	V-13	07401089	V-59	033041097	V-9	074011033	V-58
03316002	V-13	07401091	V-59	033051114	V-12	074011034	V-58
03316003	V-13	07401108	V-59	033271037	V-6	074011036	V-58
03316004	V-13	07401137	V-59	033271038	V-6	074011037	V-58
03316006	V-13	07406079	V-67	033271039	V-6	074011038	V-58
03317001	V-13	07406080	V-67	033271040	V-6	074011039	V-58
03317002	V-13	07406081	V-67	033271041	V-6	074011042	V-59
03317003	V-13	07406082	V-67	033271042	V-6	074011045	V-59
03317004	V-13	07406083	V-67	033291000	V-48	074011046	V-59
03317005	V-13	013041234	V-14	033291001	V-48	074011047	V-59
03317006	V-13	013041330	V-14	033291002	V-48	074011049	V-59
03628001	V-10	013041333	V-14	033291003	V-48	074011051	V-59
03628002	V-10	20302001	V-36	033291004	V-48	074011055	V-59
03628003	V-10	20302002	V-36	033291005	V-48	074011057	V-59
03628004	V-10	20320047	V-15	033291008	V-48	074011059	V-59
03628005	V-10	20320048	V-15	033291009	V-48	074011060	V-59
03628006	V-10	20320050	V-15	033291010	V-48	074011178	V-58
07310001	V-64	20320051	V-15	033291011	V-48	074011186	V-58
07310002	V-64	20320052	V-15	033291012	V-48	074011187	V-58
07310003	V-64	20320053	V-15	033291015	V-49	074011188	V-58
07310004	V-64	20320054	V-15	033291016	V-49	074011189	V-58
07310005	V-64	20509001	V-84	033291017	V-49	074011195	V-58,V-65
07310006	V-64	20509002	V-84	033291018	V-49	074011199	V-59
07401001	V-58,V-65	20509003	V-84	033291193	V-49	074011229	V-59
07401002	V-58,V-65	20509004	V-84	033291194	V-49	074011230	V-59
07401003	V-58,V-65	20509005	V-84	033291195	V-49	074011233	V-59
07401004	V-58,V-65	20509006	V-84	033291196	V-49	074011234	V-59
07401006	V-58,V-65	20509007	V-84	033291197	V-49	074011236	V-59
07401008	V-58,V-65	20509008	V-84	033291198	V-49	074011237	V-59
07401010	V-58,V-65	022291000	V-50	033291199	V-49	074011239	V-59
07401011	V-58,V-65	022291001	V-50	073031200	V-63,V-65	074011244	V-59
07401013	V-58,V-65	022291002	V-50	073031201	V-63,V-65	074011246	V-59
07401015	V-58,V-65	022291003	V-50	073031202	V-63,V-65	074011247	V-58
07401017	V-58,V-65	022291004	V-50	073031203	V-63,V-65	074011248	V-58
07401018	V-58,V-65	022291005	V-50	073031204	V-63,V-65	074011249	V-58
07401019	V-58,V-65	022291006	V-50	073031205	V-63,V-65	074011250	V-58
07401021	V-58,V-65	022291016	V-50	073031206	V-63	074011251	V-58,V-65
07401023	V-58,V-65,F-24	022291017	V-50	073031207	V-63	074011252	V-58

# Catalog Number Index

Catalog Number	Page	Catalog Number	Page	Catalog Number	Page	Catalog Number	Page
074011253	V-58	074093526	V-66	074PG36028	V-62	1224BK	D-8
074011254	V-58	074093541	V-66	1201AL	D-8	1224GY	D-8
074011255	V-58	074093542	V-66	1201B	D-8	1224I	D-8
074011256	V-58	074093543	V-66	1201BK	D-8	1224LA	D-8
074011257	V-58	074093544	V-66	1201GY	D-8	1224PWAL	D-8
074011258	V-58	074093545	V-66	1201I	D-8	1224PWB	D-8
074011259	V-58	074093546	V-66	1201LA	D-8	1224PWBK	D-8
074011260	V-58	074093548	V-66	1201W	D-8	1224PWGY	D-8
074011261	V-58	074093550	V-66	1203AL	D-8	1224PWI	D-8
074011262	V-58	074093552	V-66	1203B	D-8	1224PWLA	D-8
074011263	V-58	074093561	V-67	1203BK	D-8	1224PWR	D-8
074011264	V-58	074093562	V-67	1203GY	D-8	1224R	D-8
074011265	V-58	074093563	V-67	1203I	D-8	1224W	D-8
074011266	V-58	074093564	V-67	1203LA	D-8	1224WW	D-8
074011275	V-59	074093565	V-67	1203W	D-8	14S10	W-9
074011331	V-60	074093566	V-67	1221AL	D-8	14W07H	C-6
074011332	V-60	074093568	V-67	1221B	D-8	14W33H	C-6
074011333	V-60	091041000	V-65	1221BK	D-8	14W47H	C-6
074011334	V-60	091041001	V-65	1221GY	D-8	14W47HBK	C-6
074011335	V-60,C-11,H-13	091041002	V-65	1221I	D-8	14W48H	C-6
074011336	V-60,C-11,H-13	091041003	V-65	1221LA	D-8	14W49H	C-6
074011337	V-60,C-11,H-13	091041004	V-65	1221PWAL	D-8	15GC10	W-3
074011338	V-60	091041005	V-65	1221PWB	D-8	15ST10	W-3
074011341	V-60	091041006	V-65	1221PWBK	D-8	15W07H	C-6
074011342	V-60	091041007	V-65	1221PWGY	D-8	15W33H	C-6
074011343	V-60	091041008	V-65	1221PWI	D-8	15W47H	C-6
074011344	V-60	091041009	V-65	1221PWLA	D-8	15W47HBK	C-6
074011346	V-60	091041010	V-65	1221PWR	D-8	15W48H	C-6
074011347	V-60	091041011	V-65	1221R	D-8	15W49H	C-6
074011348	V-60	091041012	V-65	1221W	D-8	20308001A	V-16
074011349	V-60	091041013	V-65	1221WW	D-8	20308002A	V-16
074011350	V-60	091041014	V-65	1222AL	D-8	20308003A	V-16
074011351	V-60	091041015	V-65	1222B	D-8	20308004A	V-16
074093401	V-66	091041016	V-65	1222BK	D-8	20308005A	V-16
074093402	V-66,G-11,G-32	091041017	V-65	1222GY	D-8	2172BK	A-7,L-7,O-7,P-15
074093403	V-66,G-11,G-32	091041019	V-65	1222I	D-8	2172BKL	A-7,L-7
074093404	V-66,G-11,G-32	091061043	V-6	1222LA	D-8	2172BKLTR	A-7,L-7
074093405	V-66,G-11,G-32	091061044	V-6	1222PWAL	D-8	2172BKTR	A-7,L-7
074093406	V-66,G-11,G-32	091061045	V-6	1222PWB	D-8	2172GY	A-7,L-7
074093408	V-66	091061046	V-6	1222PWBK	D-8	2172GYL	A-7,L-7
074093410	V-66	091061047	V-6	1222PWGY	D-8	2172GYLTR	A-7,L-7
074093412	V-66	091061048	V-6	1222PWI	D-8	2172GYTR	A-7,L-7
074093421	V-66	00322001LPK50	V-84	1222PWLA	D-8	2172IV	A-7,L-7
074093422	V-66	00322002LPK50	V-84	1222PWR	D-8	2172IVL	A-7,L-7
074093423	V-66	00322003LPK50	V-84	1222R	D-8	2172IVLTR	A-7,L-7
074093424	V-66	00322004LPK50	V-84	1222W	D-8	2172IVTR	A-7,L-7
074093425	V-66	00322005LPK50	V-84	1222WW	D-8	2172L	A-7,L-7
074093426	V-66	073PG291204	V-63	1223AL	D-8	2172LA	A-7,L-7
074093428	V-66	074M20010	V-62	1223B	D-8	2172LAL	A-7,L-7
074093441	V-67	074M25017	V-62	1223BK	D-8	2172LALTR	A-7,L-7
074093442	V-67	074M251247	V-62	1223GY	D-8	2172LATR	A-7,L-7
074093443	V-67	074M251248	V-62	1223I	D-8	2172LTR	A-7,L-7
074093444	V-67	074M32021	V-62	1223LA	D-8	2172RED	A-7,L-7
074093445	V-67	074M32023	V-62	1223PWAL	D-8	2172REDL	A-7,L-7
074093446	V-67	074M32025	V-62	1223PWB	D-8	2172REDLTR	A-7,L-7
074093448	V-67	074M321028	V-62	1223PWBK	D-8	2172REDTR	A-7,L-7
074093511	V-66	074M321250	V-62	1223PWGY	D-8	2172TR	A-7,L-7
074093512	V-65,V-66	074PG16010	V-62	1223PWI	D-8	2172W	A-7,L-7
074093513	V-65,V-66	074PG21010	V-62	1223PWLA	D-8	2172WL	A-7,L-7
074093514	V-65,V-66	074PG211247	V-62	1223PWR	D-8	2172WLTR	A-7,L-7
074093515	V-65,V-66	074PG211248	V-62	1223R	D-8	2172WTR	A-7,L-7
074093516	V-65,V-66	074PG29021	V-62	1223W	D-8	2182BK	A-7,L-7
074093518	V-66	074PG29023	V-62	1223WW	D-8	2182BKL	A-7,L-7
074093520	V-66	074PG29025	V-62	1224AL	D-8	2182BKLTR	A-7,L-7
074093522	V-66	074PG291028	V-62	1224B	D-8	2182BKTR	A-7,L-7



# Catalog Number Index

Catalog Number	Page	Catalog Number	Page	Catalog Number	Page	Catalog Number	Page
2182GY	A-7,L-7	29W75H	C-9	3SFBCBRA	O-14	67W08H	C-8
2182GYL	A-7,L-7	29W76H	C-9	3SFBCGYA	O-14	67W09H	C-8
2182GYLTR	A-7,L-7	29W77H	C-9	3SFBCIA	O-14	67W47H	C-7
2182GYTR	A-7,L-7	29W78H	C-9	3SFBDS	O-14	67W48H	C-7
2182IV	A-7,L-7	3000H	C-10	3SFBIM	O-14	67W49H	C-7
2182IVL	A-7,L-7	3051H	C-10	3SFBRP	O-14	67W74H	C-8
2182IVLTR	A-7,L-7	3052H	C-10	3SFBS	O-14	67W75H	C-8
2182IVTR	A-7,L-7	3054H	C-10	3SFBSS	O-14	67W76H	C-8
2182L	A-7,L-7	3055H	C-10	3SFBTP	O-14	6800H	C-10
2182LA	A-7,L-7	3056H	C-10	5252AAL	A-17	69W08H	C-9
2182LAL	A-7,L-7	3057H	C-10	5252AB	A-17	69W47H	C-8
2182LALTR	A-7,L-7	3058H	C-10	5252ABLK	A-17	69W48H	C-8
2182LATR	A-7,L-7	3059H	C-10	5252AG	A-17	69W49H	C-8
2182LTR	A-7,L-7	3060H	C-10	5252AI	A-17	69W74H	C-9
2182RED	A-7,L-7	3061H	C-10	5252ALA	A-17	69W75H	C-9
2182REDL	A-7,L-7	3090FH	C-10	5252AOW	A-17	69W76H	C-9
2182REDLTR	A-7,L-7	3099H	C-10	5252AR	A-17	69W77H	C-9
2182REDTR	A-7,L-7	30MIFRS	G-21, G-37	5252AW	A-17	8200BK	A-6,L-6
2182TR	A-7,L-7	30MISRS	G-37	5262AL	A-17	8200BKL	A-6,L-6
2182W	A-7,L-7	31518101BPK100	V-84	5262B	A-17	8200BKLTR	A-6,L-6
2182WL	A-7,L-7	31518102BPK100	V-84	5262BKWR	A-17	8200BKTR	A-6,L-6
2182WLTR	A-7,L-7	31518103BPK100	V-84	5262BLK	A-17	8200GY	A-6,L-6
2182WTR	A-7,L-7	31518104BPK100	V-84	5262G	A-17	8200GYL	A-6,L-6
24W34H	C-7	31518105BPK100	V-84	5262GYWR	A-17	8200GYLTR	A-6,L-6
24W47H	C-7	31518106BPK100	V-84	5262I	A-17	8200GYTR	A-6,L-6
24W49H	C-7	31518110BPK100	V-84	5262IWR	A-17	8200IV	A-6,L-6
25W34H	C-7	31518111BPK100	V-84	5262LA	A-17	8200IVL	A-6,L-6
25W47H	C-7	31518112BPK100	V-84	5262OW	A-17	8200IVLTR	A-6,L-6
25W49H	C-7	31518113BPK100	V-84	5262R	A-17	8200IVTR	A-6,L-6
26W08H	C-8	31518116BPK100	V-84	5262W	A-17	8200L	A-6,L-6
26W09H	C-8	31518117BPK100	V-84	5262WR	A-17	8200LA	A-6,L-6
26W47H	C-7	31518118BPK100	V-84	5262WWR	A-17	8200LAL	A-6,L-6
26W48H	C-7	31518119BPK100	V-84	5352AAL	A-17	8200LALTR	A-6,L-6
26W49H	C-7	31518123BPK100	V-84	5352AB	A-17	8200LATR	A-6,L-6
26W74H	C-8	31518124BPK100	V-84	5352ABLK	A-17	8200LTR	A-6,L-6
26W75H	C-8	31518125BPK100	V-84	5352AG	A-17	8200RED	A-6,L-6
26W75HBK	C-8	31518126BPK100	V-84	5352AI	A-17	8200REDL	A-6,L-6
26W76H	C-8	31518127BPK100	V-84	5352ALA	A-17	8200REDLTR	A-6,L-6
26W76HBK	C-8	31605010GPK100	V-84	5352AOW	A-17	8200REDTR	A-6,L-6
27W08H	C-8	31605015GPK100	V-84	5352AR	A-17	8200TR	A-6,L-6
27W09H	C-8	31622001LPK50	V-84	5352AW	A-17	8200WHI	A-6,L-6
27W47H	C-7	31622002LPK50	V-83, V-84	5362AL	A-17	8200WL	A-6,L-6
27W48H	C-7	31622003LPK50	V-83, V-84	5362B	A-17	8200WLTR	A-6,L-6
27W49H	C-7	31622007LPK50	V-83, V-84	5362BKWR	A-17	8200WTR	A-6,L-6
27W74H	C-8	31622008LPK50	V-83, V-84	5362BL	A-17	8300BK	A-6,L-6
27W75H	C-8	31648035GPK100	V-84	5362BLK	A-17	8300BKL	A-6,L-6
27W75HBK	C-8	31648036GPK100	V-84	5362G	A-17, I-4	8300BKLTR	A-6,L-6
27W76H	C-8	31648037GPK100	V-84	5362GYWR	A-17	8300BKTR	A-6,L-6
27W76HBK	C-8	31648038GPK100	V-84	5362I	A-17	8300GY	A-6,L-6
28W08H	C-9	31648039GPK100	V-84	5362IWR	A-17	8300GYL	A-6,L-6
28W09H	C-9	31648042GPK100	V-84	5362LA	A-17	8300GYLTR	A-6,L-6
28W47H	C-8	31648043GPK100	V-84	5362OW	A-17	8300GYTR	A-6,L-6
28W48H	C-8	31648044GPK100	V-84	5362R	A-17	8300IV	A-6,L-6
28W49H	C-8	31648045GPK100	V-84	5362W	A-17	8300IVL	A-6,L-6
28W74H	C-9	31648046GPK100	V-84	5362WR	A-17	8300IVLTR	A-6,L-6
28W75H	C-9	31648047GPK100	V-84	5362WWR	A-17	8300IVTR	A-6,L-6
28W76H	C-9	31648048GPK100	V-84	60W33H	C-6	8300L	A-6,L-6
28W77H	C-9	31648050GPK100	V-84	60W47H	C-6	8300LA	A-6,L-6
28W78H	C-9	31648051GPK100	V-84	60W48H	C-6	8300LALM	A-6,L-6
29W08H	C-9	31648052GPK100	V-84	60W49H	C-6	8300LALTR	A-6,L-6
29W09H	C-9	31648053GPK100	V-84	6500H	C-10	8300LATR	A-6,L-6
29W47H	C-8	31648054GPK100	V-84	65W34H	C-7	8300LTR	A-6,L-6
29W48H	C-8	3SFBB	O-14	65W47H	C-7	8300RED	A-6,L-6
29W49H	C-8	3SFBC	O-14	65W49H	C-7	8300REDL	A-6,L-6
29W74H	C-9	3SFBCBA	O-14	6700H	C-10	8300REDLTR	A-6,L-6

# Catalog Number Index

Catalog Number	Page	Catalog Number	Page	Catalog Number	Page	Catalog Number	Page
8300REDTR	A-6,L-6	AFB401BK	O-30	ATD2000CRP	E-7	B2200	V-98
8300TR	A-6,L-6	AFB401GNT	O-30	ATD500C	E-7	B2414	O-12
8300WHI	A-6,L-6	AFB501BK	O-30	ATD500CRP	E-7	B2421	O-13
8300WL	A-6,L-6	AFB501GNT	O-30	ATP120HB	E-8	B2422	O-13
8300WLTR	A-6,L-6	AFB801BK	O-30	ATP120HBRP	E-8	B2423	O-13
8300WTR	A-6,L-6	AFB801GNT	O-30	ATP1500C	E-7	B2427	O-13
9053A	Z-2	AFBPW101	O-31	ATP1500CL	E-7	B2429	O-13
9054A	Z-2	AFBPW301	O-31	ATP1500CRP	E-7	B2431	O-13
9GC10	W-3	AFBPW401	O-31	ATP1600W	E-8	B2432	O-13
9ST10	W-3	AFBPW501	O-31	ATP1600WRP	E-8	B2433	O-13
A460P9	G-24	AFBPW801	O-31	ATP2000GY	E-6	B2436	O-12
A460R9	G-24	AHP1500CRP	E-11	ATP2000I	E-6	B243641	O-12
A5100P9	G-24	AHP1600WRP	E-11	ATP2000LA	E-6	B2437	O-12
A560P9	G-24	AP2000BK1	E-5	ATP2000NGY	E-6	B2481	O-20
AA20045	G-30,G-31,G-32	AP2000BK1N	E-5	ATP2000NI	E-6	B2482	O-20
AA203055	B-54,C-4,G-10	AP2000BK2	E-5	ATP2000NLA	E-6	B2483	O-20
AA2030PS	B-54,C-4,G-10	AP2000BK2N	E-5	ATP2000NW	E-6	B2503	O-9
AA6010055	G-10	AP2000GY1	E-5	ATP2000W	E-6	B2506	O-9
AAB08	I-34	AP2000GY1N	E-5	ATP2004I	E-6	B2506415	O-9
AAB12	I-34	AP2000GY2	E-5	ATP2004NI	E-6	B2527	O-9
AAB18	I-34	AP2000GY2N	E-5	ATP2004NW	E-6	B2529	O-9
AAB22	I-34	AP2000I1	E-5	ATP2004W	E-6	B2536	O-9
AAB30	I-34	AP2000I1N	E-5	ATP600C	E-7	B253641	O-9
AAR	E-8	AP2000I2	E-5	ATP600CL	E-7	B2537	O-9
AAR10C120	E-9	AP2000I2N	E-5	ATP600CRP	E-7	B2588	O-20
AAR10C277	E-9	AP2000LA1	E-5	ATU1000C	E-7	B2588275	O-20
AARBL2	E-9	AP2000LA1N	E-5	ATU1000CL	E-7	B4214	O-12
AARBL3	E-9	AP2000LA2	E-5	ATU1000CRP	E-7	B4233	O-12
AB12	I-34	AP2000LA2N	E-5	ATU2000C	E-7	B423341	O-12
AB18	I-34	AP2000W1	E-5	ATU2000CL	E-7	B4314	O-12
AB203055	B-54,C-4,G-10	AP2000W1N	E-5	ATU2000CRP	E-7	B4333	O-12
AB30	I-34	AP2000W2	E-5	ATU500C	E-7	B433361	O-12
ACFSNC	F-12,G-21,G-37	AP2000W2N	E-5	ATU500CRP	E-7	BA2414	O-12
ACFSNO	F-12,G-21,G-37	AP22	P-21	AU2000BK1	E-5	BA2421	O-13
ACIPE	E-6, E-11	AP2GY	P-21	AU2000BK1N	E-5	BA2422	O-13
ACMG	E-6	AP2I	P-21	AU2000BK2	E-5	BA2423	O-13
ACMRA	E-6	AP42	P-21	AU2000BK2N	E-5	BA2431	O-13
AD2000BK1	E-5	AR101	D-16	AU2000GY1	E-5	BA2432	O-13
AD2000BK1N	E-5	AR103	D-16	AU2000GY1N	E-5	BA2433	O-13
AD2000BK2	E-5	AR151	D-16	AU2000GY2	E-5	BA2436	O-12
AD2000BK2N	E-5	AR1BE	D-16	AU2000GY2N	E-5	BA2527	O-9
AD2000GY1	E-5	AR1W	D-16	AU2000I1	E-5	BA2529	O-9
AD2000GY1N	E-5	AR201	D-16	AU2000I1N	E-5	BA2536	O-9
AD2000GY2	E-5	AR2BE	D-16	AU2000I2	E-5	BA2537	O-9
AD2000GY2N	E-5	AR2W	D-16	AU2000I2N	E-5	BA4214	O-12
AD2000I1	E-5	AR61	D-16	AU2000LA1	E-5	BA4233	O-12
AD2000I1N	E-5	AR63	D-16	AU2000LA1N	E-5	BA4333	O-12
AD2000I2	E-5	AS103	D-16	AU2000LA2	E-5	BB1001W	G-7,G-8,G-10
AD2000I2N	E-5	AS153	D-16	AU2000LA2N	E-5	BB1001W	Y-18,Y-20
AD2000LA1	E-5	AS1I	D-16	AU2000W1	E-5	BB1002W	G-7,G-8,G-10
AD2000LA1N	E-5	AS1W	D-16	AU2000W1N	E-5	BB1002W	Y-18,Y-20
AD2000LA2	E-5	AS203	D-16	AU2000W2	E-5	BB100N	G-7,G-8,G-10
AD2000LA2N	E-5	AS2I	D-16	AU2000W2N	E-5	BB100N	Y-18,Y-20
AD2000W1	E-5	AS2W	D-16	AVCE1H	O-38	BB201W	B-54,G-6,Y-24
AD2000W1N	E-5	AS63	D-16	AVCE1H	W-15	BB2030N	B-54,G-6,G-10
AD2000W2	E-5	AT1277I	E-6	AVCE1P	W-15	BB301W	B-54,G-6,Y-24
AD2000W2N	E-5	AT1277W	E-6	AWMG	E-6	BB601W	G-7,H-11,Y-24
AFB301	O-29	ATB	Q-2	AWSG	E-6	BB602W	G-7,G-10
AFB3014	O-29	ATD1000C	E-7	B2025	V-98	BB60N	G-7,G-10
AFB3014A	O-29	ATD1000CL	E-7	B2038	V-98	BCSM12	I-33
AFB3014AE	O-29	ATD1000CRP	E-7	B2050	V-98	BCSM18	I-33
AFB3014AEH	O-29	ATD1600W	E-8	B2075	V-98	BCSM30	I-33
AFB3014AEHZ	O-29	ATD1600WRP	E-8	B2100	V-98	BCSM8	I-33
AFB301BK	O-30	ATD2000C	E-7	B2125	V-98	BM08M	I-35
AFB301GNT	O-30	ATD2000CL	E-7	B2150	V-98	BM08N	I-35

# Catalog Number Index

Catalog Number	Page	Catalog Number	Page	Catalog Number	Page	Catalog Number	Page
BM12M	I-35	BR20LATR	A-20	CFB8FC1	O-19	CR15LATR	A-22,Y-40
BM12N	I-35	BR20LAWR	A-20	CFB8FC2	O-19	CR15LATRTP1	A-22
BM16N	I-35	BR20LAWRTR	A-20	CFB8JBC1	O-19	CR15LATRTP2	A-22
BM18M	I-35	BR20OW	A-20	CFB8JBC2	O-19	CR15OW	A-22
BM18N	I-35	BR20R	A-20	CFBOGPAN4	O-14,O-18	CR15P1	A-22
BM20N	I-35	BR20RTR	A-20	CG304NM	V-61	CR15P2	A-22
BM22N	I-35	BR20TR	A-20	CG305NM	V-61	CR15TR	A-22,Y-40
BM30M	I-35	BR20WHI	A-20	CG306NM	V-61	CR15TRTP1	A-22
BM30N	I-35	BR20WHITR	A-20	CG404NM	V-61	CR15TRTP2	A-22
BR106AL	W-6,R-45	BR20WHIWR	A-20	CG404SST	V-61	CR15WHI	A-22,Y-40
BR106B	W-6	BR20WHIWRTR	A-20	CG40690NM	V-61	CR15WHITR	A-22,Y-40
BR106C	W-6,R-45,R-63	BR20WR	A-20	CG406NM	V-61	CR15WP1	A-22
BR106E	W-6	BR20WRTR	A-20	CG406SST	V-61	CR15WP2	A-22
BR106G	W-6	BRS2RCA	P-18	CG40890NM	V-61	CR15WTRP1	A-22
BR106LA	W-6	BTPB3TF	R-60	CG408NM	V-61	CR15WTRP2	A-22
BR106W	W-6	C2400	O-24	CG408SST	V-61	CR16277	Y-12
BR15	A-20	C2500	O-24	CG410SST	V-61	CR16279	Y-14
BR15AL	A-20	C2504	O-24	CG60890NM	V-61	CR16914	Y-30
BR15ALTR	A-20	C4200	O-24	CG608NM	V-61	CR20	A-22
BR15BL	A-20	C4300	O-24	CG608SST	V-61	CR20AL	A-22
BR15BLK	A-20	CA100	G-11,Y-18,Y-20	CG61090NM	V-61	CR20ALTR	A-22
BR15BLKTR	A-20	CA100MI	G-18	CG610NM	V-61	CR20BLK	A-22
BR15BLKWR	A-20	CA320	G-11	CG610SST	V-61	CR20BLKP1	A-22
BR15BLKWRTR	A-20,Y-40	CA3430	G-11	CG61290NM	V-61	CR20BLKP2	A-22
BR15BLTR	A-20	CA3430MI	G-18,G-21	CG612NM	V-61	CR20BLKTR	A-22
BR15GRY	A-20	CA420	G-11	CG612SST	V-61	CR20BLKTRTP1	A-22
BR15GRYTR	A-20	CA420MI	G-18	CG614SST	V-61	CR20BLKTRTP2	A-22
BR15GRYWR	A-20	CA520	G-11	CG810NM	V-61	CR20GRY	A-22
BR15GRYWRTR	A-20,Y-40	CA530	G-11	CG810SST	V-61	CR20GRYP1	A-22
BR15I	A-20	CA530MI	G-18,G-21	CG81290NM	V-61	CR20GRYP2	A-22
BR15ITR	A-20	CA60	G-11	CG812NM	V-61	CR20GRYTR	A-22
BR15IWR	A-20	CA60MI	G-18,G-21	CG812SST	V-61	CR20GRYTRTP1	A-22
BR15IWRTR	A-20,Y-40	CC100	G-11,G-32,Y-18	CG81490NM	V-61	CR20GRYTRTP2	A-22
BR15LA	A-20	CC201	G-32	CG814NM	V-61	CR20I	A-22
BR15LATR	A-20	CC320	G-11	CG814SST	V-61	CR20IP1	A-22
BR15LAWR	A-20	CC3430	G-11,G-32	CG816NM	V-61	CR20IP2	A-22
BR15LAWRTR	A-20,Y-40	CC420	G-11	CG816SST	V-61	CR20ITR	A-22
BR15OW	A-20	CC520	G-11	CMBR	W-11	CR20ITRP1	A-22
BR15R	A-20	CC530	G-11	CPB20	F-23	CR20ITRP2	A-22
BR15RTR	A-20	CC60	G-11,G-32	CPB21	F-23	CR20LA	A-22
BR15TR	A-20	CCF1C	I-3	CPB22	F-23	CR20LAP1	A-22
BR15WHI	A-20	CCFAC	I-3	CR15	A-22,Y-40	CR20LAP2	A-22
BR15WHITR	A-20	CCFBC	I-2,I-3	CR15AL	A-22,Y-40	CR20LATR	A-22
BR15WHIWR	A-20	CCFCC	I-3	CR15ALTR	A-22,Y-40	CR20LATRTP1	A-22
BR15WHIWRTR	A-20,Y-40	CCM1C	I-3	CR15BLK	A-22,Y-40	CR20LATRTP2	A-22
BR15WR	A-20	CCMAC	I-3	CR15BLKP1	A-22	CR20OW	A-22
BR15WRTR	A-20,Y-40	CCMBC	I-2,I-3	CR15BLKP2	A-22	CR20P1	A-22
BR20	A-20	CCMCC	I-3	CR15BLKTR	A-22,Y-40	CR20P2	A-22
BR20AL	A-20	CCPS1	V-47	CR15BLKTRTP1	A-22	CR20TR	A-22
BR20ALTR	A-20	CCPS2	V-47	CR15BLKTRTP2	A-22	CR20TRP1	A-22
BR20BL	A-20	CCPS3	V-47	CR15GRY	A-22,Y-40	CR20TRP2	A-22
BR20BLK	A-20	CFB11CVRALU	O-18	CR15GRYP1	A-22	CR20WHI	A-22
BR20BLKTR	A-20	CFB11CVRBRS	O-18	CR15GRYP2	A-22	CR20WHITR	A-22
BR20BLKWR	A-20	CFB11G4	O-18	CR15GRYTR	A-22,Y-40	CR20WP1	A-22
BR20BLKWRTR	A-20	CFB11G6	O-18	CR15GRYTRTP1	A-22	CR20WP2	A-22
BR20BLTR	A-20	CFB11TALU	O-18	CR15GRYTRTP2	A-22	CR20WTRP1	A-22
BR20GRY	A-20	CFB11TBRS	O-18	CR15I	A-22,Y-40	CR20WTRP2	A-22
BR20GRYTR	A-20	CFB7CVRALU	O-18	CR15IP1	A-22	CR5252IG	A-17,M-15
BR20GRYWR	A-20	CFB7CVRBRS	O-18	CR15IP2	A-22	CR5252IGBK	A-17,M-15
BR20GRYWRTR	A-20	CFB7G4	O-18	CR15ITR	A-22,Y-40	CR5252IGGY	A-17,M-15
BR20I	A-20	CFB7G6	O-18	CR15ITRP1	A-22	CR5252IGI	A-17,M-15
BR20ITR	A-20	CFB7TALU	O-18	CR15ITRP2	A-22	CR5252IGOW	A-17,M-15
BR20IWR	A-20	CFB7TBRS	O-18	CR15LA	A-22,Y-40	CR5252IGW	A-17,M-15
BR20IWRTR	A-20	CFB8CVRALU1	O-19	CR15LAP1	A-22	CR5352IG	A-17,M-15
BR20LA	A-20	CFB8CVRALU2	O-19	CR15LAP2	A-22	CR5352IGBK	A-17,M-15

# Catalog Number Index

Catalog Number	Page	Catalog Number	Page	Catalog Number	Page	Catalog Number	Page
CR5352IGBL	A-17,M-15	CS75IT5	Y-17	CSB415GY	D-10	CSL415BK	D-9
CR5352IGGY	A-17,I-4,M-15	CS8164C	B-57	CSB415I	D-10	CSL415GY	D-9
CR5352IGI	A-17,M-15	CS8165C	B-57	CSB415LA	D-10	CSL415I	D-9
CR5352IGOW	A-17,M-15	CS8169	B-57	CSB415W	D-10	CSL415LA	D-9
CR5352IGW	A-17,M-15	CS8175	B-57	CSB420AL	D-10	CSL415OW	D-9
CRF15	A-22	CS8264C	B-56	CSB420	D-10	CSL415W	D-9
CRF15AL	A-22	CS8265C	B-56	CSB420BK	D-10	CSL420	D-9
CRF15BLK	A-22	CS8269	B-56	CSB420GY	D-10	CSL420AL	D-9
CRF15GRY	A-22	CS8275	B-56	CSB420I	D-10	CSL420BK	D-9
CRF15I	A-22	CS8364C	B-57	CSB420LA	D-10	CSL420GY	D-9
CRF15LA	A-22	CS8365C	B-57	CSB420R	D-10	CSL420I	D-9
CRF15OW	A-22	CS8369	B-57	CSB420W	D-10	CSL420LA	D-9
CRF15WHI	A-22	CS8375	B-57	CSL115	D-9	CSL420OW	D-9
CRF20	A-22	CS8464C	B-56	CSL115AL	D-9	CSL420R	D-9
CRF20AL	A-22	CS8465C	B-56	CSL115BK	D-9	CSL420W	D-9
CRF20BLK	A-22	CS8469	B-56	CSL115GY	D-9	CSM12LP	I-33
CRF20GRY	A-22	CS8475	B-56	CSL115I	D-9	CSM18	I-33
CRF20I	A-22	CSB115AL	D-10	CSL115LA	D-9	CSM30	I-33
CRF20LA	A-22	CSB115	D-10	CSL115OW	D-9	CSM8	I-33
CRF20OW	A-22	CSB115BK	D-10	CSL115W	D-9	CU300A	E-8
CRF20WHI	A-22	CSB115GY	D-10	CSL120	D-9	CU300HD	E-8, E-11, E-15
CS1004	Y-17	CSB115I	D-10	CSL120AL	D-9	CU300M	E-8
CS100IT4	Y-17	CSB115LA	D-10	CSL120BK	D-9	CU347A	E-8
CS100IT5	Y-17	CSB115W	D-10	CSL120GY	D-9	CW100IT4	Y-17
CS115	D-10,Y-41	CSB120AL	D-10	CSL120I	D-9	CW100IT4W	Y-17
CS115AL	D-10,Y-41	CSB120	D-10	CSL120LA	D-9	CW100IT5	Y-17
CS115BK	D-10,Y-41	CSB120BK	D-10	CSL120OW	D-9	CW125IT4	Y-17
CS115GY	D-10,Y-41	CSB120GY	D-10	CSL120R	D-9	CW125IT5	Y-17
CS115I	D-10,Y-41	CSB120I	D-10	CSL120W	D-9	CW754	Y-17
CS115LA	D-10,Y-41	CSB120LA	D-10	CSL215	D-9	CWP1CR	Y-45
CS115W	D-10,Y-41	CSB120R	D-10	CSL215AL	D-9	CWP26CR	Y-39,Y-45
CS120AL	D-10	CSB120W	D-10	CSL215BK	D-9	CWP26CRW	Y-39,Y-45
CS120	D-10	CSB215AL	D-10	CSL215GY	D-9	CWP8CR	Y-45
CS120BK	D-10	CSB215	D-10	CSL215I	D-9	DHADC	E-9
CS120GY	D-10	CSB215BK	D-10	CSL215LA	D-9	DHAP	E-9
CS120I	D-10	CSB215GY	D-10	CSL215OW	D-9	DHCM	E-9
CS120LA	D-10	CSB215I	D-10	CSL215W	D-9	DHIP	E-9
CS120W	D-10	CSB215LA	D-10	CSL220	D-9	DHOP	E-9
CS315	D-10,Y-41	CSB215W	D-10	CSL220AL	D-9	DHSP	E-9
CS315AL	D-10,Y-41	CSB220AL	D-10	CSL220BK	D-9	DHT	E-9
CS315BK	D-10,Y-41	CSB220	D-10	CSL220GY	D-9	DHTD	E-9
CS315GY	D-10,Y-41	CSB220BK	D-10	CSL220I	D-9	DR15	A-21,Y-40
CS315I	D-10,Y-41	CSB220GY	D-10	CSL220LA	D-9	DR15AL	A-21,Y-40
CS315LA	D-10,Y-41	CSB220I	D-10	CSL220OW	D-9	DR15ALTR	A-21,Y-40
CS315W	D-10,Y-41	CSB220LA	D-10	CSL220R	D-9	DR15BLK	A-21,Y-40
CS320AL	D-10	CSB220R	D-10	CSL220W	D-9	DR15BLKP1	A-21
CS320	D-10	CSB220W	D-10	CSL315	D-9	DR15BLKP2	A-21
CS320BK	D-10	CSB315AL	D-10	CSL315AL	D-9	DR15BLKTR	A-21,Y-40
CS320GY	D-10	CSB315	D-10	CSL315BK	D-9	DR15BLKTRP1	A-21
CS320I	D-10	CSB315BK	D-10	CSL315GY	D-9	DR15BLKTRP2	A-21
CS320LA	D-10	CSB315GY	D-10	CSL315I	D-9	DR15BLKWTR	A-21,Y-40
CS320W	D-10	CSB315I	D-10	CSL315LA	D-9	DR15GRY	A-21,Y-40
CS50EXT4	Y-17	CSB315LA	D-10	CSL315OW	D-9	DR15GRYP1	A-21
CS50EXT5	Y-17	CSB315W	D-10	CSL315W	D-9	DR15GRYP2	A-21
CS6360C	B-56	CSB320AL	D-10	CSL320	D-9	DR15GRYTR	A-21,Y-40
CS6361C	B-56	CSB320	D-10	CSL320AL	D-9	DR15GRYTRP1	A-21
CS6364C	B-57	CSB320BK	D-10	CSL320BK	D-9	DR15GRYTRP2	A-21
CS6365C	B-57	CSB320GY	D-10	CSL320GY	D-9	DR15GRYWTR	A-21,Y-40
CS6369	B-57,H-11	CSB320I	D-10	CSL320I	D-9	DR15I	A-21,Y-40
CS6370	B-56	CSB320LA	D-10	CSL320LA	D-9	DR15IP1	A-21
CS6375	B-57	CSB320R	D-10	CSL320OW	D-9	DR15IP2	A-21
CS6375M2	B-57	CSB320W	D-10	CSL320R	D-9	DR15ITR	A-21,Y-40
CS6377	B-56	CSB415AL	D-10	CSL320W	D-9	DR15ITRP1	A-21
CS754	Y-17	CSB415	D-10	CSL415	D-9	DR15ITRP2	A-21
CS75IT4	Y-17	CSB415BK	D-10	CSL415AL	D-9	DR15IWRTR	A-21,Y-40

# Catalog Number Index

Catalog Number	Page	Catalog Number	Page	Catalog Number	Page	Catalog Number	Page
DR15LA	A-21,Y-40	DR20WRTR	A-21	DS320	D-11	DSL320LA	D-9
DR15LAP1	A-21	DRUB1221AC	A-44,I-44	DS320AL	D-11	DSL320OW	D-9
DR15LAP2	A-21	DRUB15	A-44,I-44	DS320BK	D-11	DSL320W	D-9
DR15LATR	A-21,Y-40	DRUB15CB5	A-44,I-44	DS320GY	D-11	DSL420	D-9
DR15LATRP1	A-21	DRUB15H	A-44,I-44	DS320I	D-11	DSL420AL	D-9
DR15LATRP2	A-21	DRUB15HCB5	A-44,I-44	DS320IL	D-11	DSL420BK	D-9
DR15LAWRTR	A-21,Y-40	DRUB20	A-44,I-44	DS320ILBK	D-11	DSL420GY	D-9
DR15P1	A-21	DRUB20AC	A-44,I-44	DS320ILW	D-11	DSL420I	D-9
DR15P2	A-21	DRUB20ACCB5	A-44,I-44	DS320LA	D-11	DSL420LA	D-9
DR15R	A-21	DRUB5462	A-44,I-44	DS320OW	D-11	DSL420OW	D-9
DR15TR	A-21,Y-40	DRUB6404	A-44,I-44	DS320R	D-11	DSL420W	D-9
DR15TRP1	A-21	DRUBGFI15	A-44,I-44	DS320W	D-11	DSM30I1	E-8
DR15TRP2	A-21	DRUBGFI15AC	A-44,I-44	DS420	D-11	DSM30I2	E-8
DR15WHI	A-21,Y-40	DRUBGFI15CB5	A-44,I-44	DS420AL	D-11	DSM30W1	E-8
DR15WHIP1	A-21	DRUBGFI15H	A-44,I-44	DS420BK	D-11	DSM30W2	E-8
DR15WHIP2	A-21	DRUBGFI15HCB5	A-44,I-44	DS420GY	D-11	DT2000W	E-6
DR15WHITR	A-21,Y-40	DRUBGFI20	A-44,I-44	DS420I	D-11	DT5012I	E-6
DR15WHITRP1	A-21	DRUBGFI20AC	A-44,I-44	DS420LA	D-11	DT5012LA	E-6
DR15WHITRP2	A-21	DRUBGFI20BFAC	A-44,I-44	DS420OW	D-11	DT5012W	E-6
DR15WHIWRTR	A-21	DRUBIG15	A-44,I-44	DS420R	D-11	DT5030I	E-6
DR15WRTR	A-21,Y-40	DRUBKIT	A-44,I-44	DS420W	D-11	DT5030LA	E-6
DR20	A-21	DRUBKITAC	A-44,I-44	DSL115	D-9	DT5030W	E-6
DR20AL	A-21	DRUBKITACCB5	A-44,I-44	DSL115AL	D-9	DT5060I	E-6
DR20ALTR	A-21	DRUBKITCB5	A-44,I-44	DSL115BK	D-9	DT5060LA	E-6
DR20BLK	A-21	DRUBTVSS15	A-44,I-44	DSL115GY	D-9	DT5060W	E-6
DR20BLKP1	A-21	DS115	D-11	DSL115I	D-9	DVI1	W-7
DR20BLKP2	A-21	DS115AL	D-11	DSL115LA	D-9	DVI151	W-7
DR20BLKTR	A-21	DS115BK	D-11	DSL115OW	D-9	DVIHDMI1	W-7
DR20BLKTRP1	A-21	DS115GY	D-11	DSL115W	D-9	EC08	I-35
DR20BLKTRP2	A-21	DS115I	D-11	DSL120	D-9	EC08N	I-35
DR20BLKWRTR	A-21	DS115LA	D-11	DSL120AL	D-9	EC12	I-35
DR20GRY	A-21	DS115OW	D-11	DSL120BK	D-9	DSL12N	I-35
DR20GRYP1	A-21	DS115W	D-11	DSL120GY	D-9	EC18	I-35
DR20GRYP2	A-21	DS120	D-11	DSL120I	D-9	EC18N	I-35
DR20GRYTR	A-21	DS120AL	D-11	DSL120IL	D-9	EC30	I-35
DR20GRYTRP1	A-21	DS120BK	D-11	DSL120ILW	D-9	EC30N	I-35
DR20GRYTRP2	A-21	DS120GY	D-11	DSL120LA	D-9	EXT13	P-21
DR20GRYWRTR	A-21	DS120I	D-11	DSL120OW	D-9	EXT33201FO8W	O-29
DR20I	A-21	DS120IL	D-11	DSL120W	D-9	EXT33201MO8W	O-29
DR20IP1	A-21	DS120ILBK	D-11	DSL120W	D-9	EXT33205FO8W	O-29
DR20IP2	A-21	DS120ILW	D-11	DSL220	D-9	EXT33205MO8W	O-29
DR20ITR	A-21	DS120LA	D-11	DSL220AL	D-9	EXT33215FO8W	O-29
DR20ITRP1	A-21	DS120OW	D-11	DSL220BK	D-9	EXT33215MO8W	O-29
DR20ITRP2	A-21	DS120PLBK	D-11	DSL220GY	D-9	EXT332xxFF8W	O-29
DR20IWRTR	A-21	DS120PLI	D-11	DSL220I	D-9	EXT42201FO8W	O-29
DR20LA	A-21	DS120PLW	D-11	DSL220LA	D-9	EXT42201MO8W	O-29
DR20LAP1	A-21	DS120R	D-11	DSL220OW	D-9	EXT42205FO8W	O-29
DR20LAP2	A-21	DS120W	D-11	DSL220W	D-9	EXT42205MO8W	O-29
DR20LATR	A-21	DS220AL	D-11	DSL30I1	E-8	EXT42215FO8W	O-29
DR20LATRP1	A-21	DS220B	D-11	DSL30W1	E-8	EXT42215MO8W	O-29
DR20LATRP2	A-21	DS220BK	D-11	DSL315	D-9	EXT422xxFF8W	O-29
DR20LAWRTR	A-21	DS220GY	D-11	DSL315AL	D-9	F1339	O-25
DR20P1	A-21	DS220I	D-11	DSL315BK	D-9	F1340	O-25
DR20P2	A-21	DS220LA	D-11	DSL315GY	D-9	F1539	O-25
DR20R	A-21	DS220OW	D-11	DSL315I	D-9	F2025	V-100
DR20TR	A-21	DS220R	D-11	DSL315LA	D-9	F3185	O-25
DR20TRP1	A-21	DS220W	D-11	DSL315OW	D-9	FASCMPB6	R-63
DR20TRP2	A-21	DS315	D-11	DSL315W	D-9	FASTSCMPB6	R-63
DR20WHI	A-21	DS315AL	D-11	DSL320	D-9	FB12	I-34
DR20WHIP1	A-21	DS315BK	D-11	DSL320AL	D-9	FB18	I-34
DR20WHIP2	A-21	DS315GY	D-11	DSL320BK	D-9	FB30	I-34
DR20WHITR	A-21	DS315I	D-11	DSL320GY	D-9	FDS30	F-12
DR20WHITRP1	A-21	DS315LA	D-11	DSL320I	D-9	FDS60	F-12
DR20WHITRP2	A-21	DS315OW	D-11	DSL320IL	D-9	FF2BK	P-19
DR20WHIWRTR	A-21	DS315W	D-11	DSL320ILW	D-9	FF2BRS	P-19



# Catalog Number Index

Catalog Number	Page	Catalog Number	Page	Catalog Number	Page	Catalog Number	Page
GFR5362SGR	K-2	GFR8300HLA	K-4,L-14	GFTR15U	K-7	H050CNK	V-68
GFR5362SGW	K-2	GFR8300HLAA	K-4,L-14	GFTR15W	K-3,X-18	H075	V-101
GFR5362TR	K-2	GFR8300HLALU	K-7,L-14	GFTR15W3	K-3	H0751	V-101
GFR5362WTR	K-2	GFR8300HLATR	K-3,L-13	GFTR15WP1	K-6	H0754	V-101
GFR8200BKTR	K-2,L-12	GFR8300HLATRU	K-7,L-13	GFTR15WP2	K-6	H07541	V-101
GFR8200GYTR	K-2,L-12	GFR8300HLU	K-7,L-14	GFTR15WU	K-7	H0759	V-101
GFR8200HBKLA	K-4,L-14	GFR8300HRLA	K-4,L-14	GFTR20	K-3,X-18	H07591	V-101
GFR8200HBKLU	K-7,L-14	GFR8300HRLU	K-7,L-14	GFTR20BK	K-3,X-18	H0759CNK	V-68
GFR8200HBKTR	K-3,L-13	GFR8300HRTR	K-3,L-13	GFTR20BKU	K-7	H075CNK	V-68
GFR8200HBKTRU	K-7,L-13	GFR8300HRTRU	K-7,L-13	GFTR20GY	K-3,X-18	H100	V-101
GFR8200HGYLA	K-4,L-14	GFR8300HTR	K-3,L-13	GFTR20GYP1	K-6	H1001	V-101
GFR8200HGYLU	K-7,L-14	GFR8300HTRU	K-7,L-13	GFTR20GYP2	K-6	H1004	V-101
GFR8200HGYTR	K-3,L-13	GFR8300HWLA	K-4,L-14	GFTR20GYU	K-7	H10041	V-101
GFR8200HGYTRU	K-7,L-13	GFR8300HWLU	K-7,L-14	GFTR20I	K-3,X-18	H1009	V-101
GFR8200HILA	K-4,L-14	GFR8300HWTR	K-3,L-13	GFTR20I3	K-3	H10091	V-101
GFR8200HILU	K-7,L-14	GFR8300HWTRU	K-7,L-13	GFTR20IP1	K-6	H1009CNK	V-68
GFR8200HITR	K-3,L-13	GFR8300ITR	K-2,L-12	GFTR20IP2	K-6	H100CNK	V-68
GFR8200HITRU	K-7,L-13	GFR8300RTR	K-2,L-12	GFTR20IU	K-7	H125	V-101
GFR8200HLA	K-4,L-14	GFR8300SG	K-2,L-12	GFTR20LA	K-3,X-18	H1251	V-101
GFR8200HLAA	K-4,L-14	GFR8300SGBK	K-2,L-12	GFTR20LA3	K-3	H1254	V-101
GFR8200HLALU	K-7,L-14	GFR8300SGGY	K-2,L-12	GFTR20LAU	K-7	H12541	V-101
GFR8200HLATR	K-3,L-13	GFR8300SGI	K-2,L-12	GFTR20R	K-3,X-18	H1259	V-101
GFR8200HLATRU	K-7,L-13	GFR8300SGR	K-2,L-12	GFTR20RU	K-7	H12591	V-101
GFR8200HLU	K-7,L-14	GFR8300SGW	K-2,L-12	GFTR20SNAPBKNA	K-9	H1259CNK	V-68
GFR8200HRLA	K-4,L-14	GFR8300SNAPBKNA	K-9,L-15	GFTR20SNAPGYNA	K-9	H125CNK	V-68
GFR8200HRLU	K-7,L-14	GFR8300SNAPGYNA	K-9,L-15	GFTR20SNAPINA	K-9	H150	V-101
GFR8200HRTR	K-3,L-13	GFR8300SNAPINA	K-9,L-15	GFTR20SNAPLANA	K-9	H1501	V-101
GFR8200HRTRU	K-7,L-13	GFR8300SNAPLANA	K-9,L-15	GFTR20SNAPNA	K-9	H1504	V-101
GFR8200HTR	K-3,L-13	GFR8300SNAPNA	K-9,L-15	GFTR20SNAPRNA	K-9	H15041	V-101
GFR8200HTRU	K-7,L-13	GFR8300SNAPRNA	K-9,L-15	GFTR20SNAPWNA	K-9	H1509	V-101
GFR8200HWLA	K-4,L-14	GFR8300SNAPWNA	K-9,L-15	GFTR20U	K-7	H15091	V-101
GFR8200HWLU	K-7,L-14	GFR8300TR	K-2,L-12	GFTR20W	K-3,X-18	H1509CNK	V-68
GFR8200HWTR	K-3,L-13	GFR8300WTR	K-2,L-12	GFTR20W3	K-3	H150CNK	V-68
GFR8200HWTRU	K-7,L-13	GFSM120A	K-10	GFTR20WP1	K-6	H200	V-101
GFR8200ITR	K-2,L-12	GFSM120M	K-10	GFTR20WP2	K-6	H2001	V-101
GFR8200RTR	K-2,L-12	GFSM240A	K-10	GFTR20WU	K-7	H2004	V-101
GFR8200SG	K-2,L-12	GFSM240M	K-10	GFTR8200SNAPBKNA	K-9	H20041	V-101
GFR8200SGBK	K-2,L-12	GFSP15IC	K-5	GFTR8200SNAPGYNA	K-9	H2009	V-101
GFR8200SGGY	K-2,L-12	GFSP15LAC	K-5	GFTR8200SNAPINA	K-9	H20091	V-101
GFR8200SGI	K-2,L-12	GFSP15WC	K-5	GFTR8200SNAPLANA	K-9	H2009CNK	V-68
GFR8200SGR	K-2,L-12	GFT2G	K-12,Y-38	GFTR8200SNAPNA	K-9	H200CNK	V-68
GFR8200SGW	K-2,L-12	GFTR15	K-3,X-18	GFTR8200SNAPRNA	K-9	H250	V-101
GFR8200SNAPBKNA	K-9,L-15	GFTR15BK	K-3,X-18	GFTR8200SNAPWNA	K-9	H2501	V-101
GFR8200SNAPGYNA	K-9,L-15	GFTR15BKU	K-7	GFTR8300SNAPBKNA	K-9	H2509	V-101
GFR8200SNAPINA	K-9,L-15	GFTR15GY	K-3,X-18	GFTR8300SNAPGYNA	K-9	H25091	V-101
GFR8200SNAPLANA	K-9,L-15	GFTR15GYP1	K-6	GFTR8300SNAPINA	K-9	H300	V-101
GFR8200SNAPRNA	K-9,L-15	GFTR15GYP2	K-6	GFTR8300SNAPLANA	K-9	H3001	V-101
GFR8200SNAPWNA	K-9,L-15	GFTR15GYU	K-7	GFTR8300SNAPNA	K-9	H3009	V-101
GFR8200TR	K-2,L-12	GFTR15I	K-3,X-18	GFTR8300SNAPRNA	K-9	H30091	V-101
GFR8200WTR	K-2,L-12	GFTR15I3	K-3	GFTR8300SNAPWNA	K-9	H320B	A-36
GFR8300BKTR	K-2,L-12	GFTR15IP1	K-6	H038	V-101	H320BL	A-36
GFR8300GYTR	K-2,L-12	GFTR15IP2	K-6	H0381	V-101	H320C	A-36
GFR8300HBKLA	K-4,L-14	GFTR15IU	K-7	H0384	V-101	H320P	A-36
GFR8300HBKLU	K-7,L-14	GFTR15LA	K-3,X-18	H03841	V-101	H320R	A-36
GFR8300HBKTR	K-3,L-13	GFTR15LA3	K-3	H0389	V-101	H320RRT	A-36
GFR8300HBKTRU	K-7,L-13	GFTR15LAU	K-7	H03891	V-101	H350	V-101
GFR8300HGYLA	K-4,L-14	GFTR15R	K-3,X-18	H0389CNK	V-68	H3501	V-101
GFR8300HGYLU	K-7,L-14	GFTR15RU	K-7	H038CNK	V-68	H400	V-101
GFR8300HGYTR	K-3,L-13	GFTR15SNAPBKNA	K-9	H050	V-101	H4001	V-101
GFR8300HGYTRU	K-7,L-13	GFTR15SNAPGYNA	K-9	H0501	V-101	H4009	V-101
GFR8300HGYTRU	K-7,L-13	GFTR15SNAPINA	K-9	H0504	V-101	H40091	V-101
GFR8300HILA	K-4,L-14	GFTR15SNAPLANA	K-9	H05041	V-101	H660A	B-68
GFR8300HILU	K-7,L-14	GFTR15SNAPNA	K-9	H0509	V-101	H661A	B-68
GFR8300HITR	K-3,L-13	GFTR15SNAPRNA	K-9	H05091	V-101	H662A	B-68
GFR8300HITRU	K-7,L-13	GFTR15SNAPWNA	K-9	H0509CNK	V-68	HAP1	E-11

# Catalog Number Index

Catalog Number	Page	Catalog Number	Page	Catalog Number	Page	Catalog Number	Page
HAP2	E-11	HBL1204LW	D-6	HBL1224LI	D-6	HBL1556GY	D-7
HAP3	E-11	HBL1204W	D-6	HBL1224LW	D-6	HBL1556I	D-7
HAP4	E-11	HBL1209	D-6,D-7,D-12	HBL1224OW	D-6	HBL1556L	D-7
HBL100RNB	F-6,G-18	HBL1209RKL	D-6	HBL1224R	D-6	HBL1556LG	D-7
HBL105GF	Y-28	HBL1220RJ	D-13	HBL1224RKL	D-6	HBL1556LI	D-7
HBL10CM22S	Y-47	HBL1221	D-6	HBL1224W	D-6	HBL1556LW	D-7
HBL10CM23S	Y-47	HBL1221BK	D-6	HBL123	D-18	HBL1556R	D-7
HBL10CM35S	Y-47	HBL1221GHCS	D-8	HBL123MM	D-18	HBL1556W	D-7
HBL10CM36S	Y-47	HBL1221GY	D-6	HBL123SP	D-18	HBL1557	D-7
HBL10CM37S	Y-47	HBL1221I	D-6	HBL123SPMM	D-18	HBL1557GY	D-7
HBL10CM41S	Y-47	HBL1221IHCS	D-8	HBL1259I	D-12	HBL1557I	D-7
HBL10P120B	M-5	HBL1221IL	D-7,Y-41	HBL1281	D-12,Y-41	HBL1557L	D-7
HBL10P120BM	M-5	HBL1221ILC	D-7	HBL1281I	D-12,Y-41	HBL1557LG	D-7
HBL10P160A	M-4	HBL1221ILR	D-7	HBL1281MC	D-12	HBL1557LI	D-7
HBL10P160DA	M-4	HBL1221L	D-6	HBL1281MO	D-12	HBL1557LW	D-7
HBL10P320A	M-4	HBL1221LA	D-6	HBL1282	D-12	HBL1557W	D-7
HBL10P320DA	M-4	HBL1221LG	D-6	HBL1282I	D-12	HBL15BW	H-4
HBL10W100C	M-6	HBL1221LI	D-6	HBL1283	D-12,Y-41	HBL15CF	H-4
HBL11	D-18	HBL1221LW	D-6	HBL1283I	D-12,Y-41	HBL15DFBK	H-4
HBL112	Z-3	HBL1221OW	D-6	HBL1284	D-12	HBL15DFBL	H-4
HBL118	D-18	HBL1221PL	D-7,I-4,Y-41	HBL1284I	D-12	HBL15DFGN	H-4
HBL11M	D-18	HBL1221PLC	D-7	HBL1287I	D-12	HBL15DFR	H-4
HBL11PBWL	D-19	HBL1221PLG	D-7	HBL1288I	D-12	HBL15DFW	H-4
HBL11SP	D-18	HBL1221R	D-6	HBL1297	D-12	HBL15DMBK	H-4
HBL11SPM	D-18	HBL1221RKL	D-6	HBL1298	D-12	HBL15DMBL	H-4
HBL11W100C	M-6	HBL1221W	D-6	HBL12BS	J-3	HBL15DMGN	H-4
HBL11WL	D-18	HBL1221WHCS	D-8	HBL12SP	D-18	HBL15DMR	H-4
HBL12	D-18	HBL1222	D-6	HBL1370	F-18	HBL15DMW	H-4
HBL1201	D-6	HBL1222BK	D-6	HBL1372D	F-18,F20	HBL15F2	H-4
HBL1201BK	D-6	HBL1222GY	D-6	HBL1379D	F-18,F20	HBL15F4	H-4
HBL1201GY	D-6	HBL1222I	D-6	HBL1381	D-7	HBL15FBBK	H-4
HBL1201I	D-6	HBL1222L	D-6	HBL1381I	D-7	HBL15FBBL	H-4
HBL1201IL	D-7	HBL1222LA	D-6	HBL1382	D-7	HBL15FBGN	H-4
HBL1201L	D-6	HBL1222LG	D-6	HBL1382I	D-7	HBL15FBK	H-3
HBL1201LA	D-6	HBL1222LI	D-6	HBL1385	D-7	HBL15FBL	H-3
HBL1201LG	D-6	HBL1222LW	D-6	HBL1385I	D-7	HBL15FBR	H-4
HBL1201LI	D-6	HBL1222OW	D-6	HBL1385W	D-7	HBL15FBW	H-4
HBL1201LW	D-6	HBL1222PL	D-7	HBL1386	D-7	HBL15FCAPBK	H-3
HBL1201PL	D-7	HBL1222R	D-6	HBL1386I	D-7	HBL15FCAPBL	H-3
HBL1201R	D-6	HBL1222RKL	D-6	HBL1386L	D-7	HBL15FCAPGN	H-3
HBL1201W	D-6	HBL1222W	D-6	HBL1388	D-7	HBL15FCAPR	H-3
HBL1202	D-6	HBL1223	D-6	HBL1388I	D-7	HBL15FCAPW	H-3
HBL1202I	D-6	HBL1223BK	D-6	HBL1389D	F-18,F20	HBL15FGN	H-3
HBL1202L	D-6	HBL1223GY	D-6	HBL1389MQ5	F-9,I-7	HBL15FR	H-3
HBL1202LG	D-6	HBL1223I	D-6	HBL1389MQR	F-9,I-7	HBL15FRBK	H-3
HBL1202LI	D-6	HBL1223IL	D-7,Y-41	HBL1389MQR2	F-9,I-7	HBL15FRBL	H-3
HBL1202LW	D-6	HBL1223ILC	D-7	HBL1390	F-18	HBL15FRGN	H-3
HBL1203	D-6	HBL1223L	D-6	HBL1392D	F-18,F20	HBL15FRR	H-3
HBL1203BK	D-6	HBL1223LA	D-6	HBL13R12D	F-19,F20	HBL15FRSBK	H-3
HBL1203GY	D-6	HBL1223LG	D-6	HBL13R13D	F-19,F20	HBL15FRSBL	H-3
HBL1203I	D-6	HBL1223LI	D-6	HBL13R22D	F-19,F20	HBL15FRSGN	H-3
HBL1203IL	D-7	HBL1223LW	D-6	HBL13R23D	F-19,F20	HBL15FRSR	H-3
HBL1203L	D-6	HBL1223OW	D-6	HBL13R89D	F-19,F20	HBL15FRSW	H-3
HBL1203LG	D-6	HBL1223PL	D-7,Y-41	HBL13R90	F-19	HBL15FRW	H-3
HBL1203LI	D-6	HBL1223PLC	D-7	HBL13R92D	F-19,F20	HBL15FW	H-3
HBL1203LW	D-6	HBL1223R	D-6	HBL13S33D	F-20,F22	HBL15MBBK	H-4
HBL1203PL	D-7	HBL1223RKL	D-6	HBL13X33D	F-20,F22	HBL15MBBL	H-4
HBL1203W	D-6	HBL1223W	D-6	HBL1433	A-28	HBL15MBGN	H-4
HBL1204	D-6	HBL1224	D-6	HBL1447	A-28	HBL15MBK	H-3
HBL1204BK	D-6	HBL1224BK	D-6	HBL14PB	J-2	HBL15MBL	H-3
HBL1204GY	D-6	HBL1224GY	D-6	HBL14W33	A-28	HBL15MBR	H-4
HBL1204I	D-6	HBL1224I	D-6	HBL14W47	A-28	HBL15MBW	H-4
HBL1204L	D-6	HBL1224L	D-6	HBL1533	A-29	HBL15MCAPBK	H-3
HBL1204LG	D-6	HBL1224LA	D-6	HBL1547	A-29	HBL15MCAPBL	H-3
HBL1204LI	D-6	HBL1224LG	D-6	HBL1556	D-7	HBL15MCAPGN	H-3



# Catalog Number Index

Catalog Number	Page	Catalog Number	Page	Catalog Number	Page	Catalog Number	Page
HBL15MCAPR	H-3	HBL18221ICN	D-12	HBL2089IV	R-11	HBL2172R	A-3,L-3
HBL15MCAPW	H-3	HBL18223CN	D-12	HBL20C215GY	R-12	HBL2172WA	A-3,L-3
HBL15MGN	H-3	HBL18223ICN	D-12	HBL20C215IV	R-12	HBL2182	A-3,L-3
HBL15MR	H-3	HBL18224ICN	D-12	HBL20C315GY	R-12	HBL2182GY	A-3,L-3
HBL15MRBK	H-3	HBL1PI750	M-9	HBL20C315IV	R-12	HBL2182I	A-3,L-3
HBL15MRBL	H-3	HBL1PI750C	M-9	HBL20GB306GY	R-12	HBL2182OW	A-3,L-3
HBL15MRGN	H-3	HBL1PI750M	M-9	HBL20GB306GYTR	R-12	HBL2182R	A-3,L-3
HBL15MRR	H-3	HBL2000B5GY	R-10	HBL20GB306GYTR	R-12	HBL2182WA	A-3,L-3
HBL15MRSBK	H-3	HBL2000B5IV	R-10	HBL20GB306IV	R-12	HBL21CM28	Y-28
HBL15MRSBL	H-3	HBL2000BCAGY	R-10	HBL20GB306IVTR	R-12	HBL21CM29	Y-28
HBL15MRSNG	H-3	HBL2000BCAIV	R-10	HBL20GB306IVTR	R-12	HBL21CM414B	B-65
HBL15MRSR	H-3	HBL2000BCGY	R-10	HBL20GB506GY	R-12	HBL21CM415B	B-64
HBL15MRSW	H-3	HBL2000BCIV	R-10	HBL20GB506IV	R-12	HBL21SP	D-19
HBL15MRW	H-3	HBL2000CAGY	R-10	HBL20GB512GY	R-12	HBL22	D-19
HBL15MW	H-3	HBL2000CAIV	R-10	HBL20GB512GYTR	R-12	HBL223	D-19
HBL15NCBK	H-3	HBL2000CGY	R-10	HBL20GB512GYTR	R-12	HBL223MM	D-19
HBL15NCBL	H-3	HBL2000CIV	R-10	HBL20GB512IV	R-12	HBL223SP	D-19
HBL15NCGN	H-3	HBL2000TFGY	R-11	HBL20GB512IVTR	R-12	HBL223SPMM	D-19
HBL15NCR	H-3	HBL2000TFIV	R-11	HBL20GB512IVTR	R-12	HBL2270	Z-2
HBL15NCW	H-3	HBL2000WC	R-11	HBL20GB606GY	R-12	HBL2271	Z-2
HBL15PK	H-4	HBL2000WCA	R-11	HBL20GB606IV	R-12	HBL2274	Z-2
HBL15PTBK	H-4	HBL2001C	R-11,R-12	HBL20GB609GY	R-12	HBL22CM427	B-65
HBL15PTBL	H-4	HBL2003SC	R-11,R-12	HBL20GB609IV	R-12	HBL22CM428	B-64
HBL15PTGN	H-4	HBL2006GY	R-11,R-12	HBL20GB612GY	R-12	HBL22SP	D-19
HBL15PTR	H-4	HBL2006IV	R-11,R-12	HBL20GB612IV	R-12	HBL23000G	B-63
HBL15PTW	H-4	HBL2009GC	R-11	HBL20GB618GY	R-12	HBL23000HG	L-17
HBL15RCF	H-4	HBL2010A2GY	R-11,R-12	HBL20GB618IV	R-12	HBL23001HGB	L-17
HBL15RCM	H-4	HBL2010A2IV	R-11,R-12	HBL20GBA512GY	R-12	HBL23002GB	B-63
HBL15RS	H-4	HBL2010A3GY	R-11,R-12	HBL20GBA512IV	R-12	HBL23004HG	L-17
HBL15TBK	H-4	HBL2010A3IV	R-11,R-12	HBL20GBA609GY	R-12	HBL23005GB	B-63
HBL15TBL	H-4	HBL2010BGY	R-11,R-12	HBL20GBA609IV	R-12	HBL23007	B-62,B-63
HBL15TGN	H-4	HBL2010BIV	R-11,R-12	HBL20GBA612GY	R-12	HBL23014HGB	L-17
HBL15TR	H-4	HBL2011BRGY	R-10	HBL20GBA612IV	R-12	HBL23030	B-62
HBL15TS25	H-4	HBL2011BRIV	R-10	HBL20GBA618GY	R-12	HBL23032B	B-62
HBL15TS375	H-4	HBL2011GY	R-10,R-12	HBL20GBA618IV	R-12	HBL23035B	B-62
HBL15TW	H-4	HBL2011IV	R-10,R-12	HBL20IG306GY	R-12	HBL2310	B-19
HBL15W33	A-29	HBL2015BRGY	R-10	HBL20IG306IV	R-12	HBL2310AR	B-19
HBL15W47	A-29	HBL2015BRIV	R-10	HBL20IG512GY	R-12	HBL2310M7	B-19
HBL160M120A	M-4	HBL2015GY	R-10,R-12	HBL20IG512IV	R-12	HBL2310RT	B-19
HBL160M240A	M-4	HBL2015IV	R-10,R-12	HBL20IG606GY	R-12	HBL2310SR	B-19,C-11,H-13
HBL160M480A	M-4	HBL2017BRGY	R-10	HBL20IG606IV	R-12	HBL2310SR2	B-19
HBL160M600A	M-4	HBL2017BRIV	R-10	HBL21	D-19	HBL2310SW	B-19,B-39,C-3
HBL16BS	J-4	HBL2017TC	R-10,R-12	HBL2128	Z-2	HBL2311	B-18,B-40
HBL16FLR	J-4	HBL2018BRGY	R-10	HBL2129	Z-2	HBL2311BK	B-18
HBL16INR	J-4	HBL2018BRIV	R-10	HBL21414B	B-65	HBL2311EBK	B-18
HBL16LEDR	J-4	HBL2018CGY	R-10,R-12	HBL21415B	B-64	HBL2311S	B-18
HBL16PB	J-2	HBL2018CIV	R-10,R-12	HBL21420	B-65	HBL2311SW	B-18,B-39,C-3
HBL16R90	F-19	HBL2030AP	B-54,C-4,G-10	HBL21447	B-64	HBL2311VBK	B-18
HBL16R92D	F-19,F21	HBL20403	B-65	HBL2152	A-13	HBL2311VY	B-18
HBL16R93D	F-19,F21	HBL20405	B-65,B-68,N-21	HBL2152AL	A-13	HBL2313	B-19
HBL16S63D	F-21,F22	HBL20406	N-21	HBL2152BK	A-13	HBL2313BK	B-19
HBL16X63D	F-21,F22	HBL20418	B-64	HBL2152GY	A-13	HBL2313EBK	B-19
HBL1750	D-13,N-24	HBL20424B	B-68	HBL2152I	A-13	HBL2313SW	B-19,C-3
HBL1785	D-13,N-24	HBL20425B	B-68	HBL2152OW	A-13	HBL2313VBK	B-19
HBL1795	D-13,N-24,Y-41	HBL20443	B-65	HBL2152WA	A-13	HBL2313VY	B-19
HBL17CM50	D-13,N-24,Y-41	HBL20444B	B-65	HBL2162	A-13	HBL2315	B-18
HBL17CM85	D-13,N-24	HBL20445B	B-64	HBL2162AL	A-13	HBL2315SW	B-18,C-3
HBL18201CN	D-12	HBL20446	B-65,B-68,N-21	HBL2162BK	A-13	HBL2316	B-19
HBL18201ICN	D-12	HBL20482GY	R-10,R-12	HBL2162GY	A-13	HBL2320	B-19
HBL18201LCN	D-12	HBL20482IV	R-10,R-12	HBL2162I	A-13	HBL2320AR	B-19
HBL18203CN	D-12	HBL2048GY	R-10,R-12	HBL2162OW	A-13	HBL2320M4	B-19
HBL18203ICN	D-12	HBL2048IV	R-10,R-12	HBL2162WA	A-13	HBL2320RT	B-19
HBL18203LCN	D-12	HBL2051HGY	R-11	HBL2172	A-3,L-3	HBL2320SR	B-19,C-11,H-13
HBL18204ICN	D-12	HBL2051HIV	R-11	HBL2172GY	A-3,L-3	HBL2320SR2	B-19
HBL18221CN	D-12	HBL2089EIV	R-11	HBL2172I	A-3,L-3	HBL2320SW	B-19,B-39,C-3

# Catalog Number Index

Catalog Number	Page	Catalog Number	Page	Catalog Number	Page	Catalog Number	Page
HBL2321	B-18,B-40	HBL2401C	R-15	HBL2435	B-20	HBL2510SR	B-25
HBL2321BK	B-18	HBL2401DC	R-15	HBL2435SW	B-20,C-3	HBL2510SR2	B-25
HBL2321EBK	B-18	HBL2406IV	R-15	HBL2436	B-21	HBL2510SW	B-25,B-39,C-3
HBL2321S	B-18	HBL2409GC	R-15	HBL2440	B-23	HBL2511	B-24,B-40
HBL2321SW	B-18,B-39,C-3	HBL2410	B-21	HBL2441	B-23	HBL2511BK	B-24
HBL2321VBK	B-18	HBL24106DRK	R-16	HBL2443	B-23	HBL2511FC	B-24
HBL2321VY	B-18	HBL24106RRK	R-16	HBL24442IV	R-14	HBL2511S	B-24
HBL2323	B-19	HBL2410AIV	R-15	HBL2444D2AIV	R-14	HBL2511SW	B-24,B-39,C-3
HBL2323BK	B-19	HBL2410AR	B-21	HBL2444DIV	R-14	HBL2513	B-25
HBL2323EBK	B-19	HBL2410BDIV	R-15	HBL2444IV	R-14	HBL2513BK	B-25
HBL2323SW	B-19,C-3	HBL2410BIV	R-15	HBL2445	B-23	HBL2513FC	B-25
HBL2323VBK	B-19	HBL2410CIV	R-15	HBL2446	B-23	HBL2513SW	B-25,C-3
HBL2323VY	B-19	HBL2410DFOIV	R-15	HBL2447	B-10	HBL2515	B-24
HBL2325	B-18	HBL2410FCIV	R-15	HBL24482IV	R-14	HBL2515SW	B-24,C-3
HBL2325SW	B-18,C-3	HBL2410RT	B-21	HBL2448IV	R-14	HBL2516	B-25
HBL2325SWR	B-18	HBL2410SR	B-21	HBL2450	B-23	HBL2520	B-25
HBL2326	B-19	HBL2410SR2	B-21	HBL2451	B-23	HBL2521	B-24,B-40
HBL2330	B-19	HBL2410SW	B-21,B-39,C-3	HBL2451HIV	R-15	HBL2523	B-25
HBL2330AR	B-19	HBL2411	B-20,B-40	HBL2453	B-23	HBL2525	B-24
HBL2330SR	B-19,C-11	HBL2411BK	B-20	HBL2455	B-23	HBL25250	B-65
HBL2330SR2	B-19	HBL2411DFOIV	R-14	HBL2456	B-23	HBL2526	B-25
HBL2330SW	B-19,B-39,C-3	HBL2411IV	R-14	HBL2460	B-23	HBL2530	B-25
HBL2331	B-18,B-40	HBL2411S	B-20	HBL2461	B-23	HBL2531	B-24,B-40
HBL2331S	B-18	HBL2411SW	B-20,B-39,C-3	HBL2463	B-23	HBL2533	B-25
HBL2331SW	B-18,B-39,C-3	HBL2413	B-21	HBL2465	B-23	HBL2535	B-24
HBL2331VBK	B-18	HBL2413BK	B-21	HBL2466	B-23	HBL2536	B-25
HBL2331VY	B-18	HBL2413SW	B-21,C-3	HBL2475DBRIV	R-15	HBL25403	B-65
HBL2333	B-19	HBL2415	B-20	HBL2489IV	R-15	HBL25414B	B-65
HBL2333SW	B-19,C-3	HBL2415DFOIV	R-14	HBL24CM11	B-20	HBL25415B	B-64
HBL2333VBK	B-19	HBL2415IV	R-14	HBL24CM13	B-21	HBL2547	B-11
HBL2335	B-18	HBL2415SW	B-20,C-3	HBL24CM21	B-20	HBL25503	L-18
HBL2335SW	B-18,C-3	HBL2416	B-21	HBL24CM23	B-21	HBL25505	L-18
HBL2336	B-19	HBL2417DFOIV	R-14	HBL24CM31	B-20	HBL25509	L-18
HBL2340	B-22	HBL2417IV	R-14	HBL24CM33	B-21	HBL25515	L-18
HBL2340SW	B-22	HBL2418DFOIV	R-14	HBL24DRK	R-16	HBL25525	L-18
HBL2341	B-22,B-40	HBL2418IV	R-14	HBL24GB306GY	R-12	HBL25603	L-18
HBL2343	B-22	HBL2420	B-21	HBL24GB306GYTR	R-12	HBL25605	L-18
HBL2345	B-22	HBL2420AR	B-21	HBL24GB306GYTR	R-12	HBL25615	L-18
HBL2346	B-22	HBL2420REDIV	R-15	HBL24GB306IV	R-12	HBL25625	L-18
HBL2350	B-22	HBL2420RT	B-21	HBL24GB306IVTR	R-12	HBL25CM11	B-24
HBL2351	B-22,B-40	HBL2420SR	B-21	HBL24GB306IVTR	R-12	HBL25CM13	B-25
HBL2353	B-22	HBL2420SR2	B-21	HBL24GB506GY	R-12	HBL25W47	B-11
HBL2355	B-22	HBL2420SW	B-21,B-39,C-3	HBL24GB506IV	R-12	HBL260	O-39
HBL2356	B-22	HBL2421	B-20,B-40	HBL24GB512GY	R-12	HBL2610	B-27
HBL2360	B-22	HBL2421S	B-20	HBL24GB512GYTR	R-12	HBL2610AR	B-27
HBL2361	B-22	HBL2421SW	B-20,B-39,C-3	HBL24GB512GYTR	R-12	HBL2610M6	B-27
HBL2363	B-22	HBL2423	B-21	HBL24GB512IV	R-12	HBL2610RT	B-27
HBL2365	B-22	HBL2423SW	B-21,C-3	HBL24GB512IVTR	R-12	HBL2610SR	B-27,C-11
HBL2366	B-22	HBL2425	B-20	HBL24GB512IVTR	R-12	HBL2610SR2	B-27
HBL23901HG	L-17	HBL2425SW	B-20,C-3	HBL24GB606GY	R-12	HBL2610SW	B-27,B-39,C-3
HBL23909HG	L-17	HBL2426	B-21	HBL24GB606IV	R-12	HBL2611	B-26,B-40
HBL23CM10	B-19,Y-36	HBL2426IV	R-16	HBL24GB612GY	R-12	HBL2611BK	B-26
HBL23CM11	B-18,Y-36	HBL2430	B-21	HBL24GB612IV	R-12	HBL2611F	B-26
HBL23CM11V	B-18,Y-36	HBL24300RKD	L-17	HBL24GB618GY	R-12	HBL2611S	B-26
HBL23CM13	B-19,Y-36	HBL24300RKS	L-17	HBL24GB618IV	R-12	HBL2611SW	B-26,B-39,C-3
HBL23CM21	B-18	HBL2430AR	B-21	HBL24GBA512GY	R-12	HBL2611VBK	B-26
HBL23CM23	B-19	HBL2430SR	B-21	HBL24GBA512IV	R-12	HBL2611VY	B-26
HBL2400B10IV	R-14	HBL2430SR2	B-21	HBL24GBA612GY	R-12	HBL2613	B-27
HBL2400BCIV	R-14	HBL2430SW	B-21,B-39,C-3	HBL24GBA612IV	R-12	HBL2613BK	B-27
HBL2400BDIV	R-14	HBL2431	B-20,B-40	HBL24GBA618GY	R-12	HBL2613F	B-27
HBL2400BIV	R-14	HBL24312	L-17	HBL24GBA618IV	R-12	HBL2613SR	B-27,B-39
HBL2400CIV	R-14	HBL2431S	B-20	HBL24SRK	R-16	HBL2613SW	B-27,C-3
HBL2400DTFIV	R-15	HBL2431SW	B-20,B-39,C-3	HBL24W47	B-10	HBL2613VBK	B-27
HBL2400TFIV	R-15	HBL2433	B-21	HBL2510	B-25	HBL2613VY	B-27
HBL2400WVC	R-15	HBL2433SW	B-21,C-3	HBL2510AR	B-25	HBL2615	B-26

# Catalog Number Index

Catalog Number	Page	Catalog Number	Page	Catalog Number	Page	Catalog Number	Page
HBL2615F	B-26	HBL26CM10	B-27,Y-10	HBL2740SW	B-31,B-39,C-3	HBL2899	B-50
HBL2615M3	B-26	HBL26CM11	B-26	HBL2741	B-30,B-40	HBL28CM11	B-32
HBL2615SW	B-26,C-3	HBL26CM11	Y-10	HBL2741S	B-30	HBL28CM13	B-33
HBL2615SWR	B-26,B-39	HBL26CM11V	B-26	HBL2741SW	B-30,B-39,C-3	HBL3000BGY	R-18
HBL2616	B-27	HBL26CM11V	Y-11	HBL2743	B-31	HBL3000BIV	R-18
HBL2616F	B-27	HBL26CM11VB	Y-11	HBL2743SW	B-31,C-3	HBL3000C075GY	R-18
HBL2620	B-27	HBL26CM13	Y-10	HBL2745	B-30	HBL3000C075IV	R-18
HBL2620AR	B-27	HBL26CM13	Y-10	HBL2745SW	B-30,C-3	HBL3000C195GY	R-18
HBL2620M6	B-27	HBL26CM13V	B-27	HBL2746	B-31	HBL3000C195IV	R-18
HBL2620RT	B-27	HBL26CM13V	Y-11	HBL2750	B-34	HBL3000CEGY	R-18
HBL2620SR	B-27,C-11	HBL26CM20	B-27	HBL2751	B-34	HBL3000CEIV	R-18
HBL2620SR2	B-27	HBL26CM21	B-26	HBL2753	B-34	HBL3000TFGY	R-19
HBL2620SW	B-27,B-39,C-3	HBL26CM23	B-27	HBL2755	B-34	HBL3000TFIV	R-19
HBL2621	B-26,B-40	HBL2710	B-29	HBL2756	B-34	HBL3000WCGY	R-19
HBL2621BK	B-26	HBL2710AR	B-29	HBL2760	B-34	HBL3001AGY	R-19
HBL2621F	B-26	HBL2710RT	B-29	HBL2761	B-34	HBL3001GY	R-19
HBL2621S	B-26	HBL2710SR	B-29	HBL2763	B-34	HBL3003GY	R-19
HBL2621SW	B-26,B-39,C-3	HBL2710SR2	B-29	HBL2765	B-34	HBL3003IV	R-19
HBL2621VBK	B-26	HBL2710SW	B-29,B-39,C-3	HBL2766	B-34	HBL3006EGY	R-19
HBL2621VY	B-26	HBL2711	B-28,B-40	HBL2770	B-34	HBL3006EIV	R-19
HBL2623	B-27	HBL2711BK	B-28	HBL2771	B-34	HBL3007CGY	R-20
HBL2623BK	B-27	HBL2711S	B-28	HBL2773	B-34	HBL300FBK	H-6
HBL2623F	B-27	HBL2711SW	B-28,B-39,C-3	HBL2775	B-34	HBL300FBL	H-6
HBL2623SW	B-27,C-3	HBL2713	B-29	HBL2776	B-34	HBL300FBN	H-6
HBL2623VBK	B-27	HBL2713BK	B-29	HBL27CM11	B-28	HBL300FGN	H-6
HBL2623VY	B-27	HBL2713SR	B-29,B-39	HBL27CM13	B-29	HBL300FO	H-6
HBL2625	B-26	HBL2713SW	B-29,C-3	HBL27CM21	B-28	HBL300FR	H-6
HBL2625F	B-26	HBL2715	B-28	HBL27CM23	B-29	HBL300FW	H-6
HBL2625SW	B-26,C-3	HBL2715M3	B-28	HBL27CM31	B-30	HBL300FY	H-6
HBL2626	B-27	HBL2715SW	B-28,C-3	HBL27CM33	B-31	HBL300MBK	H-6
HBL2626F	B-27	HBL2715SWR	B-28,B-39	HBL27CM41	B-30	HBL300MBL	H-6
HBL263	O-39	HBL2716	B-29	HBL27CM43	B-31	HBL300MBN	H-6
HBL2630	B-27	HBL2720	B-29	HBL2810	B-33	HBL300MGN	H-6
HBL2631	B-26,B-40	HBL2720AR	B-29	HBL2810AR	B-33	HBL300MO	H-6
HBL2633	B-27	HBL2720RT	B-29	HBL2810RT	B-33	HBL300MR	H-6
HBL2635	B-26	HBL2720SR	B-29	HBL2810SR	B-33	HBL300MW	H-6
HBL2636	B-27	HBL2720SR2	B-29	HBL2810SR2	B-33	HBL300MY	H-6
HBL2640	B-35	HBL2720SW	B-29,B-39,C-3	HBL2810SW	B-33,B-39,C-3	HBL300RCF	H-7
HBL26401	B-67,B-68	HBL2721	B-28,B-37,B-40	HBL2811	B-32,B-40	HBL300RCM	H-7
HBL26402	B-67,B-68	HBL2721S	B-28	HBL2811BK	B-32	HBL3010AEGY	R-19
HBL26404	B-67,B-68	HBL2721SW	B-28,B-39,C-3	HBL2811FC	B-32	HBL3010AEIV	R-19
HBL2641	B-35,B-40	HBL2723	B-29	HBL2811S	B-32	HBL3010BGY	R-19
HBL26410	B-67	HBL2723SR	B-39	HBL2811SW	B-32,B-39,C-3	HBL3010BIV	R-19
HBL26418	B-67	HBL2723SW	B-29,C-3	HBL2813	B-33	HBL3010CGY	R-19
HBL26419	B-66	HBL2725	B-28	HBL2813BK	B-33	HBL3010CIV	R-19
HBL26420	B-67	HBL2725SW	B-28,C-3	HBL2813FC	B-33	HBL3011EGY	R-18
HBL26421	B-67	HBL2725SWR	B-39	HBL2813SW	B-33,C-3	HBL3011EIV	R-18
HBL26422	B-66	HBL2726	B-29	HBL2815	B-32	HBL3014CGY	R-19
HBL2643	B-35	HBL2730	B-31	HBL2815SW	B-32,C-3	HBL3014CIV	R-19
HBL2645	B-35	HBL2730AR	B-31	HBL2816	B-33	HBL3015EGY	R-18
HBL2646	B-35	HBL2730SR	B-31	HBL2820	B-33	HBL3015EIV	R-18
HBL2650	B-35	HBL2730SR2	B-31	HBL2820SW	B-33,B-39	HBL3017TCEGY	R-18
HBL2651	B-35,B-40	HBL2730SW	B-31,B-39,C-3	HBL2821	B-32,B-40	HBL3017TCEIV	R-18
HBL26516	B-67	HBL2731	B-30,B-37,B-40	HBL2821SW	B-32,B-39	HBL3018AEGY	R-18
HBL26519	B-66	HBL2731S	B-30	HBL2823	B-33	HBL3018AEIV	R-18
HBL26520	B-67	HBL2731SW	B-30,B-39,C-3	HBL2823SW	B-33	HBL3027AEGY	R-20
HBL26521	B-67	HBL2733	B-31	HBL2825	B-32	HBL3027AEIV	R-20
HBL26522	B-66	HBL2733SW	B-31,C-3	HBL2826	B-33	HBL3028GY	R-18
HBL2653	B-35	HBL2735	B-30	HBL2830	B-33	HBL3028IV	R-18
HBL2655	B-35	HBL2735SW	B-30,C-3	HBL2830SW	B-33,B-39	HBL3031	D-6
HBL2656	B-35	HBL2736	B-31	HBL2831	B-32,B-40	HBL3031I	D-6
HBL2660	B-29	HBL2740	B-31	HBL2831SW	B-32,B-39	HBL3031PL	D-7
HBL2661	B-28	HBL2740AR	B-31	HBL2833	B-33	HBL3032	D-6
HBL2663	B-29	HBL2740SR	B-31	HBL2835	B-32	HBL3032I	D-6
HBL2665	B-28	HBL2740SR2	B-31	HBL2836	B-33	HBL3032PL	D-7

# Catalog Number Index

Catalog Number	Page	Catalog Number	Page	Catalog Number	Page	Catalog Number	Page
HBL3032W	D-6	HBL3125B6W	G-7	HBL330PS2W	G-30	HBL360PS1W	G-30
HBL3033	D-6	HBL3125C6W	G-7	HBL330PS2WR	G-31	HBL360PS1WR	G-31
HBL3033I	D-6	HBL3125P6W	G-7	HBL330R4W	G-6	HBL360PS2W	G-30
HBL3033JEGY	R-20	HBL3125R6W	G-7	HBL330R6W	G-6	HBL360PS2WR	G-31
HBL3033JEIV	R-20	HBL316B4W	G-6	HBL330R7W	G-6	HBL360R4W	G-7
HBL3036HEGY	R-20	HBL316B6W	G-6,Y-24	HBL330R8WDC	G-9	HBL360R6W	G-7
HBL3036HEIV	R-20	HBL316C4W	G-6	HBL330RS1W	G-30	HBL360R7W	G-7
HBL303INT	Y-7	HBL316C6W	G-6,Y-24	HBL330RS1WR	G-31	HBL360R8WDC	G-9
HBL303NM	Y-7	HBL316CRCX	Y-24	HBL330RS2W	G-30	HBL360RS1W	G-30
HBL303NMELCI	Y-5	HBL316CSW	Y-24	HBL330RS2WR	G-31	HBL360RS1WR	G-31
HBL303NMELCIS	Y-5	HBL316CSW25	Y-24	HBL3325C	B-42	HBL360RS2W	G-30
HBL303SS	Y-7	HBL316NM	Y-24	HBL3326C	B-43	HBL360RS2WR	G-31
HBL303SSELCI	Y-5	HBL316P4W	G-6	HBL332B4W	G-6	HBL363B6W	G-7,Y-24
HBL303SSELICIS	Y-5	HBL316P6W	G-6,Y-24	HBL332B6W	G-6,Y-24	HBL363C6W	G-7,Y-24
HBL303SSO	Y-7	HBL316R4W	G-6	HBL332C4W	G-6	HBL363CRC	Y-25
HBL3040CEGY	R-20	HBL316R6W	G-6,Y-24	HBL332C6W	G-6,Y-24	HBL363CRP	Y-25
HBL3040CEIV	R-20	HBL316SSX	Y-24	HBL332CRCX	Y-24	HBL363CRR	Y-25
HBL3043BEGY	R-20	HBL317SBK	O-35	HBL332CSW	Y-24	HBL363P6W	G-7,Y-24
HBL3043BEIV	R-20	HBL317SGY	O-15,O-30,O-40	HBL332NM	Y-24	HBL363R6W	G-7,Y-24
HBL30442GY	R-18	HBL31CM28	Y-28	HBL332P4W	G-6	HBL363SSX	Y-25
HBL30442IV	R-18	HBL31CM29	Y-28,Z-2	HBL332P6W	G-6,Y-24	HBL3720	B-22
HBL3046BEGY	R-20	HBL3200CS2W	G-30	HBL332R4W	G-6	HBL3721	B-22
HBL3046BEIV	R-20	HBL3200CS2WR	G-31	HBL332R6W	G-6,Y-24	HBL3723	B-22
HBL3046H2GY	R-19	HBL3200PS2W	G-30	HBL332SSX	Y-24	HBL3725	B-22
HBL3046H2IV	R-19	HBL3200PS2WR	G-31	HBL3330	B-45	HBL3726	B-22
HBL3048RGY	R-20	HBL3200REDGY	R-19	HBL3330G	B-45	HBL3762C	B-58
HBL3048RIV	R-20	HBL3200REDIV	R-19	HBL3331C	B-44	HBL3763C	B-58
HBL3051LEGY	R-20	HBL3200RS2W	G-30	HBL3331GC	B-44	HBL3764C	B-59
HBL3051LEIV	R-20	HBL3200RS2WR	G-31	HBL3333C	B-45	HBL3765C	B-59
HBL3082GY	R-19	HBL320B4W	G-6	HBL3333GC	B-45	HBL3767	B-58
HBL3086GY	R-19	HBL320B6W	G-6	HBL3334C	B-44	HBL3768	B-59
HBL3086IV	R-19	HBL320B7W	G-6	HBL3335C	B-45	HBL3769	B-59
HBL30MIFRS	G-21,G-37	HBL320C4W	G-6	HBL3393	N-22	HBL3771	B-58
HBL30MIRS	G-18	HBL320C6W	G-6	HBL3394	N-22	HBL3775	B-59
HBL30MISRS	G-37	HBL320C7W	G-6	HBL340PB	J-3	HBL3777	B-58
HBL30RGB	B-39,F-6,G-18	HBL320P4W	G-6	HBL3430	B-45	HBL3P120B	M-5
HBL30RNB	B-39,F-6,G-18	HBL320P6W	G-6	HBL3430G	B-45	HBL3P120BM	M-5
HBL3100B4W	G-7	HBL320P7W	G-6	HBL3431C	B-44	HBL3P160A	M-4
HBL3100B6W	G-7	HBL320R4W	G-6	HBL3431GCB	B-44	HBL3P160DA	M-4
HBL3100B7W	G-7	HBL320R6W	G-6	HBL3433C	B-45	HBL3P320A	M-4
HBL3100C4W	G-7	HBL320R7W	G-6	HBL3433GCB	B-45	HBL3P320DA	M-4
HBL3100C6W	G-7	HBL3226	B-17	HBL3435CM2	B-45	HBL3PI750	M-9
HBL3100C7W	G-7	HBL328DCC	Y-32	HBL3520	B-46	HBL3W100C	M-6
HBL3100C8V0DC	G-9	HBL328DCP	Y-32	HBL3521C	B-46	HBL3W50	M-7
HBL3100CS1W	G-30	HBL328DCR	Y-32	HBL3523C	B-46	HBL3WAA	B-51
HBL3100CS1WR	G-31	HBL330B4W	G-6	HBL3524C	B-46	HBL400FBK	H-6
HBL3100CS2W	G-30	HBL330B6W	G-6	HBL3525C	B-46	HBL400FBL	H-6
HBL3100CS2WR	G-31	HBL330B7W	G-6	HBL360B4W	G-7	HBL400FBN	H-6
HBL3100MI6W	G-17	HBL330C4W	G-6	HBL360B6W	G-7	HBL400FGN	H-6
HBL3100P4W	G-7	HBL330C6W	G-6	HBL360B7W	G-7	HBL400FO	H-6
HBL3100P6W	G-7,G-17	HBL330C7W	G-6	HBL360C4W	G-7	HBL400FR	H-6
HBL3100P7W	G-7	HBL330C8V0DC	G-9	HBL360C6W	G-7	HBL400FW	H-6
HBL3100P8V0DC	G-9	HBL330CS1W	G-30	HBL360C7W	G-7	HBL400FY	H-6
HBL3100PS1W	G-30	HBL330CS1WR	G-31	HBL360C8V0DC	G-9	HBL400MBK	H-6
HBL3100PS1WR	G-31	HBL330CS2W	G-30	HBL360CS1W	G-30	HBL400MBL	H-6
HBL3100PS2W	G-30	HBL330CS2WR	G-31	HBL360CS1WR	G-31	HBL400MBN	H-6
HBL3100PS2WR	G-31	HBL330MI4W	G-17	HBL360CS2W	G-30	HBL400MGN	H-6
HBL3100R4W	G-7	HBL330MI6W	G-17	HBL360CS2WR	G-31	HBL400MO	H-6
HBL3100R6W	G-7	HBL330MI7W	G-17	HBL360MI4W	G-17	HBL400MR	H-6
HBL3100R7W	G-7	HBL330P4W	G-6,G-17	HBL360MI6W	G-17	HBL400MW	H-6
HBL3100R8WDC	G-9	HBL330P6W	G-6,G-17	HBL360MI7W	G-17	HBL400MY	H-6
HBL3100RS1W	G-30	HBL330P7W	G-6,G-17	HBL360P4W	G-7,G-17	HBL400RCF	H-7
HBL3100RS1WR	G-31	HBL330P8V0DC	G-9	HBL360P6W	G-7,G-17	HBL400RCM	H-7
HBL3100RS2W	G-30	HBL330PS1W	G-30	HBL360P7W	G-7,G-17	HBL4100B12W	G-7
HBL3100RS2WR	G-31	HBL330PS1WR	G-31	HBL360P8V0DC	G-9	HBL4100B5W	G-7

# Catalog Number Index

Catalog Number	Page	Catalog Number	Page	Catalog Number	Page	Catalog Number	Page
HBL4100B7W	G-7	HBL4200PS2WR	G-31	HBL430MIS2W	G-37	HBL4585	B-11
HBL4100B9W	G-7	HBL4200RS1W	G-30	HBL430P12W	G-6,G-17,G-21	HBL4585C	B-11
HBL4100C12W	G-7	HBL4200RS1WR	G-31	HBL430P5W	G-6,G-17,G-21	HBL4586	B-10
HBL4100C5W	G-7	HBL4200RS2W	G-30	HBL430P5WR	G-17	HBL4586C	B-10
HBL4100C7W	G-7	HBL4200RS2WR	G-31	HBL430P6V02	G-9	HBL45905	B-47
HBL4100C9W	G-7	HBL420B12W	G-6	HBL430P7W	G-6,G-17,G-21	HBL45915	B-47
HBL4100CS1W	G-30	HBL420B5W	G-6	HBL430P7WR	G-17	HBL45935	B-47
HBL4100CS1WR	G-31	HBL420B7W	G-6	HBL430P9W	G-6,G-17,G-21	HBL45985CL	B-47
HBL4100CS2W	G-30	HBL420B9W	G-6	HBL430P9WR	G-17	HBL45CM70C	B-10
HBL4100CS2WR	G-31	HBL420BK	A-23	HBL430PS1W	G-30	HBL45CM79C	B-11
HBL4100MI12W	G-17	HBL420C12W	G-6	HBL430PS1WR	G-31	HBL45WAA	B-53
HBL4100MI12WR	G-17	HBL420C5W	G-6	HBL430PS2W	G-30,G-37	HBL460B12W	G-7
HBL4100MI5W	G-17	HBL420C7W	G-6	HBL430PS2WR	G-31	HBL460B5W	G-7
HBL4100MI5WR	G-17	HBL420C9W	G-6	HBL430R12W	G-6	HBL460B6V02	G-9
HBL4100MI7W	G-17	HBL420GY	A-23	HBL430R5W	G-6	HBL460B7W	G-7
HBL4100MI7WR	G-17	HBL420H	A-8,L-8	HBL430R6V02	G-9	HBL460B9W	G-7
HBL4100MI9W	G-17	HBL420HGY	A-8,L-8	HBL430R7W	G-6	HBL460C12W	G-7
HBL4100MI9WR	G-17	HBL420HI	A-8,L-8	HBL430R9W	G-6	HBL460C5W	G-7
HBL4100P12W	G-7,G-17	HBL420HIS	L-16,M-11	HBL430RS1W	G-30	HBL460C6V02	G-9
HBL4100P12WR	G-17	HBL420HR	A-8,L-8	HBL430RS1WR	G-31	HBL460C7W	G-7
HBL4100P5W	G-7,G-17	HBL420HRS	L-16,M-11	HBL430RS2W	G-30	HBL460C9W	G-7
HBL4100P5WR	G-17	HBL420HS	L-16,M-11	HBL430RS2WR	G-31	HBL460CS1W	G-30
HBL4100P7W	G-7,G-17	HBL420HW	A-8,L-8	HBL432B3W	G-6	HBL460CS1WR	G-31
HBL4100P7WR	G-17	HBL420I	A-23	HBL432B6W	G-6	HBL460CS2W	G-30
HBL4100P9W	G-7,G-17	HBL420IS	A-23,M-11	HBL432C6W	G-6	HBL460CS2WR	G-31
HBL4100P9WR	G-17	HBL420MI12W	G-17	HBL432MI3W	G-17	HBL460MI12W	G-17
HBL4100PS1W	G-30	HBL420MI5W	G-17	HBL432P3W	G-6,G-17	HBL460MI12WR	G-17
HBL4100PS1WR	G-31	HBL420MI7W	G-17	HBL432P6W	G-6	HBL460MI5W	G-17
HBL4100PS2W	G-30	HBL420MI9W	G-17	HBL432R3W	G-6	HBL460MI5WR	G-17
HBL4100PS2WR	G-31	HBL420P12W	G-6,G-17	HBL432R6W	G-6	HBL460MI7W	G-17
HBL4100R12W	G-7	HBL420P5W	G-6,G-17	HBL45105	B-47	HBL460MI7WR	G-17
HBL4100R5W	G-7	HBL420P7W	G-6,G-17	HBL45115	B-47	HBL460MI9W	G-17
HBL4100R7W	G-7	HBL420P9W	G-6,G-17	HBL45123	J-3	HBL460MI9WR	G-17
HBL4100R9W	G-7	HBL420R12W	G-6	HBL45123C	J-3	HBL460MIF12W	G-21
HBL4100RS1W	G-30	HBL420R5W	G-6	HBL45123C20	J-3	HBL460MIF5W	G-21
HBL4100RS1WR	G-31	HBL420R7W	G-6	HBL45123C20W	J-3	HBL460MIF7W	G-21
HBL4100RS2W	G-30	HBL420R9W	G-6	HBL45123GF15	J-3	HBL460MIF9W	G-21
HBL4100RS2WR	G-31	HBL420S	A-23,M-11	HBL45123GF20	J-3	HBL460MIFS2W	G-37
HBL4125B6W	G-7	HBL420W	A-23	HBL45123R	J-3	HBL460MIS2W	G-37
HBL4125C6W	G-7	HBL430B12W	G-6	HBL45123R20	J-3	HBL460P12W	G-7,G-17,G-21
HBL4125P6W	G-7	HBL430B5W	G-6	HBL45123R20W	J-3	HBL460P12WR	G-17
HBL4125R6W	G-7	HBL430B6V02	G-9	HBL45123R20WM1	J-3	HBL460P5W	G-7,G-17,G-21
HBL415	A-23	HBL430B7W	G-6	HBL45123R220	J-3	HBL460P5WR	G-17
HBL415BK	A-23	HBL430B9W	G-6	HBL45123R220W	J-3	HBL460P6V02	G-9
HBL415GY	A-23	HBL430C12W	G-6	HBL45123TL20	J-3	HBL460P7W	G-7,G-17,G-21
HBL415H	A-8,L-8	HBL430C5W	G-6	HBL45123TL20W	J-3	HBL460P7WR	G-17
HBL415HI	A-8,L-8	HBL430C6V02	G-9	HBL45135	B-47	HBL460P9W	G-7,G-17,G-21
HBL415HR	A-8,L-8	HBL430C7W	G-6	HBL45205	B-47	HBL460P9WR	G-17
HBL415HW	A-8,L-8	HBL430C9W	G-6	HBL45215	B-47	HBL460PS1W	G-30
HBL415I	A-23	HBL430CS1W	G-30	HBL45235	B-47	HBL460PS1WR	G-31
HBL415IS	A-23,M-11	HBL430CS1WR	G-31	HBL45305	B-47	HBL460PS2W	G-30,G-37
HBL415S	A-23,M-11	HBL430CS2W	G-30	HBL45315	B-47	HBL460PS2WR	G-31
HBL415W	A-23	HBL430CS2WR	G-31	HBL45335	B-47	HBL460R12W	G-7
HBL416B6W	G-6	HBL430MI12W	G-17	HBL4550	B-11	HBL460R5W	G-7
HBL416C6W	G-6	HBL430MI5W	G-17	HBL4550RT	B-11	HBL460R6V02	G-9
HBL416P6W	G-6	HBL430MI5WR	G-17	HBL4560	B-11	HBL460R7W	G-7
HBL416R6W	G-6	HBL430MI7W	G-17	HBL4560RT	B-11	HBL460R9W	G-7
HBL420	A-23	HBL430MI7WR	G-17	HBL4563	B-11	HBL460RS1W	G-30
HBL4200CS1W	G-30	HBL430MI9W	G-17	HBL4570C	B-10	HBL460RS1WR	G-31
HBL4200CS1WR	G-31	HBL430MI9WR	G-17	HBL4570CA	B-10	HBL460RS2W	G-30
HBL4200CS2W	G-30	HBL430MIF12W	G-21	HBL4573VBK	B-10	HBL460RS2WR	G-31
HBL4200CS2WR	G-31	HBL430MIF5W	G-21	HBL4573VY	B-10	HBL463B6W	G-7
HBL4200PS1W	G-30	HBL430MIF7W	G-21	HBL4579C	B-11	HBL463C6W	G-7
HBL4200PS1WR	G-31	HBL430MIF9W	G-21	HBL4579VBK	B-11	HBL463P6W	G-7
HBL4200PS2W	G-30	HBL430MIFS2W	G-37	HBL4579VY	B-11	HBL463R6W	G-7

# Catalog Number Index

Catalog Number	Page	Catalog Number	Page	Catalog Number	Page	Catalog Number	Page
HBL4700	B-11,I-4	HBL47472RRXXGY	R-26	HBL4775DKITIV	R-24	HBL506IV	R-7
HBL4700I	B-11	HBL47472RRXXIV	R-26	HBL4779C	B-11	HBL506W	R-7
HBL4700RT	B-11	HBL4747AXGY	R-25	HBL4779VBK	B-11	HBL50SC	B-60,N-21
HBL4710	B-11	HBL4747AXIV	R-25	HBL4779VY	B-11	HBL50SD	J-6
HBL4710BGY	R-24	HBL4747BBGY	R-25	HBL4785	B-11	HBL50SDN	J-6
HBL4710BIV	R-24	HBL4747BBIV	R-25	HBL4785C	B-11	HBL50YSD	J-6
HBL4710DFOGY	R-24	HBL4747BFGY	R-25	HBL4786	B-10	HBL5100B5W	G-7
HBL4710DFOIV	R-24	HBL4747BFIV	R-25	HBL4786AGY	R-24	HBL5100B7W	G-7
HBL4710GY	R-24	HBL4747BRGY	R-25	HBL4786AIV	R-24	HBL5100B9W	G-7
HBL4710IV	R-24	HBL4747BRIV	R-25	HBL4786C	B-10	HBL5100C5W	G-7
HBL4710RT	B-11	HBL4747BSGY	R-25	HBL4792	A-45	HBL5100C7W	G-7
HBL4711	B-11	HBL4747BSIV	R-25	HBL4794	A-45	HBL5100C8V0DC	G-9
HBL4711DFOGY	R-23	HBL4747BTGY	R-25	HBL4795	A-45	HBL5100C9W	G-7
HBL4711DFOIV	R-23	HBL4747BTIV	R-25	HBL47CM00	B-11,Y-34	HBL5100CS1W	G-30
HBL4711GY	R-23	HBL4747BXGY	R-25	HBL47CM15	B-11,Y-34	HBL5100CS1WR	G-31
HBL4711IV	R-23	HBL4747BXIV	R-25	HBL47CM16	B-10	HBL5100MI9W	G-17
HBL4712TXGY	R-23	HBL4747C1GY	R-25	HBL47CM20C	B-10	HBL5100P5W	G-7
HBL4712TXIV	R-23	HBL4747C1IV	R-25	HBL47CM29C	B-11,Y-34	HBL5100P7W	G-7
HBL4713	B-11	HBL4747C2GY	R-25	HBL47CM70C	B-10	HBL5100P8V0DC	G-9
HBL4714AGY	R-24	HBL4747C2IV	R-25	HBL47CM79C	B-11	HBL5100P9W	G-7,G-17
HBL4714AIV	R-24	HBL4747CVM2GY	R-25	HBL4889	B-6	HBL5100PS1W	G-30
HBL4715	B-11	HBL4747CVM2IV	R-25	HBL4890	B-6	HBL5100PS1WR	G-31
HBL4715C	B-11	HBL4747CVMGY	R-25	HBL4892	B-60	HBL5100R5W	G-7
HBL4715DFOGY	R-23	HBL4747CVMIV	R-25	HBL4AP	A-8,A-23,L-8	HBL5100R7W	G-7
HBL4715DFOIV	R-23	HBL4747JXGY	R-25	HBL4APBL	A-23,L-16,M-11	HBL5100R8WDC	G-9
HBL4715GY	R-23	HBL4747JXIV	R-25	HBL4APGY	A-8,A-23,L-8	HBL5100R9W	G-7,G-24
HBL4715IV	R-23	HBL4747RFGY	R-25	HBL4API	A-8,L-8,M-11	HBL5100RS1W	G-30
HBL4716	B-10	HBL4747RFIV	R-25	HBL4APO	A-23	HBL5100RS1WR	G-31
HBL4716C	B-10	HBL4747RXGY	R-25	HBL4APR	A-8,L-8,M-11	HBL511IV	R-6
HBL4717DFOGY	R-23	HBL4747RXIV	R-25	HBL4APW	A-8,A-23,L-8	HBL511W	R-6
HBL4717DFOIV	R-23	HBL4750	B-11	HBL4P120B	M-5	HBL5125B6W	G-7
HBL4717GY	R-23	HBL4750B10GY	R-22	HBL4P120BM	M-5	HBL5125C6W	G-7
HBL4717IV	R-23	HBL4750B10IV	R-22	HBL4P160A	M-4	HBL5125P6W	G-7
HBL4717NGY	R-23	HBL4750BP	R-22	HBL4P160DA	M-4	HBL5125R6W	G-7
HBL4717NIV	R-23	HBL4750C075GY	R-22	HBL4P320A	M-4	HBL512IV	R-6
HBL4717TCAGY	R-22	HBL4750C075IV	R-22	HBL4P320DA	M-4	HBL515CVO	A-29
HBL4718DFOGY	R-23	HBL4750C135GY	R-22	HBL4PB	A-23	HBL515PVO	A-28
HBL4718DFOIV	R-23	HBL4750C135IV	R-22	HBL4PBBK	A-23	HBL516B6W	G-6
HBL4718GY	R-23	HBL4750C195GY	R-22	HBL4PBI	A-23,L-16,M-11	HBL516C6W	G-6
HBL4718IV	R-23	HBL4750C195IV	R-22	HBL4PS1050USB	M-9	HBL516P6W	G-6
HBL4720C	B-10	HBL4750C315GY	R-22	HBL4W100C	M-6	HBL516R6W	G-6
HBL4720CA	B-10	HBL4750C315IV	R-22	HBL50010IV	R-4	HBL517IV	R-6
HBL4720CBK	B-10	HBL4750CGY	R-22	HBL50010W	R-4	HBL517W	R-6
HBL4723VBK	B-10	HBL4750CIV	R-22	HBL5005IV	R-4	HBL518IV	R-6
HBL4723VY	B-10	HBL4750DGY	R-22	HBL500TFIV	R-7	HBL518W	R-6
HBL4724REDIV	R-15,R-24	HBL4750GY	R-25,R-45	HBL501032W	J-2	HBL5200	Y-38,Z-3
HBL4729C	B-11	HBL4750IV	R-25,R-45	HBL501032WM1	J-2	HBL5200CS1W	G-30
HBL4729CA	B-11	HBL4750TFGY	R-24	HBL501042W	J-2	HBL5200CS1WR	G-31
HBL4729CBK	B-11	HBL4750TFIV	R-24	HBL501232W	J-2	HBL5200PS1W	G-30
HBL4729VBK	B-11	HBL4750WCGY	R-22	HBL501232WM1	J-2	HBL5200PS1WR	G-31
HBL4729VY	B-11	HBL4751AC	R-22	HBL501242W	J-2	HBL5200RS1W	G-30
HBL4746H2GY	R-24	HBL4751DA	R-22	HBL501431W	J-2	HBL5200RS1WR	G-31
HBL4746H2IV	R-24	HBL4756AGY	R-24	HBL50162FL	J-4	HBL5201	N-25
HBL47472BBBBBGY	R-26	HBL4756AIV	R-24	HBL50162LED	J-4	HBL5205WO	A-46,B-48,N-25
HBL47472BBBBBIV	R-26	HBL4760	B-11	HBL50163	J-3	HBL5206WO	A-46,B-48,N-25
HBL47472BBBFFGY	R-26	HBL4760C	B-11	HBL50163IN	J-4	HBL520B5W	G-6
HBL47472BBBFFIV	R-26	HBL4761	B-11	HBL502B	R-7	HBL520B7W	G-6
HBL47472BBRRGY	R-26	HBL4763	B-11	HBL503NM	Y-12	HBL520B9W	G-6
HBL47472BBRRIV	R-26	HBL4770C	B-10	HBL503SS	Y-12	HBL520C5W	G-6
HBL47472BBSSGY	R-26	HBL4770CA	B-10	HBL504IV	R-7	HBL520C7W	G-6
HBL47472BBSSIV	R-26	HBL4773VBK	B-10	HBL504NM	Y-14	HBL520C9W	G-6
HBL47472BBTTGY	R-26	HBL4773VY	B-10	HBL504SS	Y-14	HBL520P5W	G-6
HBL47472BBTTIV	R-26	HBL4774AGY	R-24	HBL504SSELCI	Y-5	HBL520P7W	G-6
HBL47472BBXXGY	R-26	HBL4774AIV	R-24	HBL504SSELCIH	Y-5	HBL520P9W	G-6
HBL47472BBXXIV	R-26	HBL4775DKITGY	R-24	HBL504W	R-7	HBL520R5W	G-6

# Catalog Number Index

Catalog Number	Page	Catalog Number	Page	Catalog Number	Page	Catalog Number	Page
HBL520R7W	G-6	HBL5269C	A-29	HBL5352BK	A-13	HBL5462GY	A-31
HBL520R9W	G-6	HBL5269CBL	A-29	HBL5352BL	A-13	HBL5462I	A-31
HBL5221	A-46,B-48,N-25	HBL5269EBK	A-29	HBL5352GY	A-13	HBL5462R	A-31
HBL5221	Y-34,Y-37,Y-45	HBL5273L	Y-28	HBL5352I	A-13	HBL5464VY	A-32
HBL5222	A-46,B-48,N-25	HBL5273L	Z-2	HBL5352R	A-13	HBL5466C	A-32
HBL5222	Y-34,Y-37,Y-45	HBL5278C	A-30	HBL5352W	A-13	HBL5466CA	A-32
HBL5235	A-45	HBL5279	A-30	HBL5357	A-12	HBL5469C	A-33
HBL5236	A-45	HBL5279C	A-30	HBL5358	A-13	HBL5469VY	A-33
HBL5236M2	A-45	HBL5280C	A-28	HBL5360ISA	M-11	HBL5478C	A-32
HBL5263PLUG	A-45	HBL5282	A-12	HBL5360OWSA	M-11	HBL5479C	A-33
HBL5240	A-30	HBL5284	A-12	HBL5360SA	M-11	HBL5492	A-45
HBL5242	A-13	HBL5289	Z-2	HBL5360WSA	M-11	HBL5492I	A-45
HBL5242GY	A-13	HBL5292	A-45	HBL5361	A-12,Y-40	HBL54CM66C	A-32
HBL5242I	A-13	HBL5292I	A-45	HBL5361BK	A-12	HBL5552B	A-34
HBL5242RT	A-13	HBL5299	A-28	HBL5361GRY	A-12	HBL560B5W	G-7
HBL5242W	A-13	HBL52CM21	A-46,B-48,N-25	HBL5361GRYWR	A-12	HBL560B6V02	G-9
HBL5251	A-13,Y-40	HBL52CM21W	B-48,N-25,Y-34	HBL5361I	A-12,Y-40	HBL560B7W	G-7
HBL5251I	A-13,Y-40	HBL52CM22	A-46,B-48,N-25	HBL5361IWR	A-12	HBL560B9R	H-11
HBL5252	A-13	HBL52CM61	A-12,Y-35	HBL5361RT	A-12	HBL560B9W	G-7
HBL5252BK	A-13	HBL52CM62	A-12,Y-35,Y-40	HBL5361W	A-12	HBL560C5W	G-7
HBL5252GY	A-13	HBL52CM62I	A-12,Y-35,Y-40	HBL5361WR	A-12	HBL560C6V02	G-9
HBL5252I	A-13	HBL52CM66C	A-28,Y-35	HBL5362	A-12	HBL560C7W	G-7
HBL5252R	A-13	HBL52CM66V	Y-35	HBL5362ALSA	M-11	HBL560C9W	G-7
HBL5252W	A-13	HBL52CM69C	A-29,Y-35	HBL5362BK	A-12	HBL560CS1W	G-30
HBL5253	A-13	HBL52CM69V	Y-35	HBL5362BKWR	A-12	HBL560CS1WR	G-31
HBL5256	A-30	HBL52CM80C	A-28,Y-35	HBL5362BL	A-12	HBL560MI5W	G-17
HBL5258	A-13	HBL5302	A-34	HBL5362GY	A-12	HBL560MI7W	G-17
HBL5258I	A-13	HBL530B5W	G-6	HBL5362GYSA	I-4,M-11	HBL560MI9W	G-17
HBL5260ISA	M-11	HBL530B6V02	G-9	HBL5362GYWR	A-12	HBL560MIF9W	G-21
HBL5260OWSA	M-11	HBL530B7W	G-6	HBL5362I	A-12	HBL560P5W	G-7,G-17
HBL5260SA	M-11	HBL530B9W	G-6	HBL5362ISA	M-11	HBL560P6V02	G-9
HBL5260WSA	M-11	HBL530C5W	G-6	HBL5362IWR	A-12	HBL560P7W	G-7,G-17
HBL5261	A-12	HBL530C6V02	G-9	HBL5362M4	A-12	HBL560P9W	G-7,G-17,G-21
HBL5261BK	A-12	HBL530C7W	G-6	HBL5362OWSA	M-11	HBL560P9W	H-11
HBL5261GRYWR	A-12	HBL530C9W	G-6	HBL5362R	A-12	HBL560P9WR	H-11
HBL5261I	A-12	HBL530CS1W	G-30	HBL5362RWR	A-12	HBL560PS1W	G-30
HBL5261IWR	A-12	HBL530CS1WR	G-31	HBL5362SA	M-11	HBL560PS1WR	G-31
HBL5261RT	A-12	HBL530MI5W	G-17	HBL5362W	A-12	HBL560R5W	G-7
HBL5261WR	A-12	HBL530MI7W	G-17	HBL5362WR	A-12	HBL560R6V02	G-9
HBL5261WRT	A-12	HBL530MI9W	G-17	HBL5362WSA	M-11	HBL560R7W	G-7
HBL5261YRT	A-12	HBL530MIF5W	G-21	HBL5362WWR	A-12	HBL560R9W	G-7,G-24,H-11
HBL5262	A-12	HBL530MIF7W	G-21	HBL5364VBK	A-28	HBL560RS1W	G-30
HBL5262ALSA	M-11	HBL530P5W	G-6,G-17,G-21	HBL5364VY	A-28	HBL560RS1WR	G-31
HBL5262BK	A-12	HBL530P6V02	G-9	HBL5366C	A-28	HBL563B6W	G-7
HBL5262BKWR	A-12	HBL530P7W	G-6,G-17,G-21	HBL5366CA	A-28	HBL563C6W	G-7
HBL5262GY	A-12	HBL530P9W	G-6,G-17	HBL5366EBK	A-28	HBL563P6W	G-7
HBL5262GYSA	M-11	HBL530PS1W	G-30	HBL5369C	A-29	HBL563R6W	G-7
HBL5262GYWR	A-12	HBL530PS1WR	G-31	HBL5369EBK	A-29	HBL5652I	A-31
HBL5262I	A-12	HBL530R5W	G-6	HBL5369VBK	A-29	HBL5656	A-33
HBL5262ISA	M-11	HBL530R6V02	G-9	HBL5369VY	A-29	HBL5658	A-31
HBL5262ISA	Y-39	HBL530R7W	G-6	HBL5378C	A-30	HBL5661	A-31
HBL5262IWR	A-12	HBL530R9W	G-6	HBL5379C	A-30	HBL5661I	A-31
HBL5262OWSA	M-11	HBL530RS1W	G-30	HBL5392	A-45	HBL5661RT	A-31
HBL5262R	A-12	HBL530RS1WR	G-31	HBL53CM61	A-12,Y-37	HBL5662	A-31
HBL5262RWR	A-12	HBL5324	A-34	HBL53CM62	A-12,I-4,Y-37	HBL5662I	A-31
HBL5262SA	M-11	HBL532B6W	G-6	HBL53CM66C	A-28,Y-37	HBL5666C	A-32
HBL5262W	A-12	HBL532C6W	G-6	HBL53CM69C	A-29,Y-37	HBL5666CA	A-32
HBL5262WR	A-12	HBL532P6W	G-6	HBL53R61	H-11	HBL5666VY	A-32
HBL5262WSA	M-11	HBL532R6W	G-6	HBL5461	A-31	HBL5669C	A-33
HBL5262WWR	A-12	HBL5342	A-13	HBL5461GY	A-31	HBL5669VY	A-33
HBL5266C	A-28	HBL5342GY	A-13	HBL5461I	A-31	HBL5678C	A-32
HBL5266CA	A-28	HBL5342I	A-13	HBL5461R	A-31	HBL5679C	A-33
HBL5266CAT	A-28	HBL5342RT	A-13	HBL5461W	A-31	HBL5684	A-31
HBL5266CBL	A-28	HBL5342W	A-13	HBL5462	A-31	HBL56CM66C	A-32
HBL5266EBK	A-28	HBL5352	A-13	HBL5462BK	A-31		

# Catalog Number Index

Catalog Number	Page	Catalog Number	Page	Catalog Number	Page	Catalog Number	Page
HBL5700FIV	R-7	HBL5748SIV	R-5	HBL6080OS	Y-46	HBL61CM72	Y-28
HBL5701C	R-8	HBL5748SW	R-5	HBL6081	Y-46	HBL620BCK	R-11
HBL5703IV	R-7	HBL5748W	R-4	HBL6082	Y-46	HBL620C	R-11
HBL5703W	R-7	HBL57512IV	R-4	HBL6085	Y-47	HBL6236	A-45
HBL5709	R-8	HBL57513IV	R-4	HBL6087	Y-46	HBL624BCK	R-16
HBL5709GC	R-8	HBL5751AIV	R-4	HBL60CM17	A-47,Y-35,Y-37	HBL624CUT	R-16
HBL5711BRIV	R-6	HBL5751AW	R-4	HBL60CM18	A-47,Y-35,Y-37	HBL630B	R-20
HBL5711LHIV	R-6	HBL5751IV	R-4	HBL60CM19	A-47,Y-37	HBL630BDK	R-20
HBL5711LHW	R-6	HBL5751W	R-4	HBL60CM23	B-49,Y-34	HBL630C	R-20
HBL5711RHIV	R-6	HBL5752IV	R-5	HBL60CM24	B-49,Y-34	HBL630CDK	R-20
HBL5711RHW	R-6	HBL5752R	R-5	HBL60CM31	B-51,Y-10,Y-36	HBL6375S	B-57,H-11
HBL5715BRIV	R-6	HBL5753IV	R-5	HBL60CM31V	B-51,Y-11,Y-36	HBL63CM60	Y-12
HBL5715IV	R-6	HBL5753R	R-5	HBL60CM31W	Y-10,Y-36	HBL63CM61	Y-13
HBL5715W	R-6	HBL5760IV	R-4	HBL60CM32	B-51,Y-10,Y-36	HBL63CM64	Y-14
HBL5717BRIV	R-6	HBL5780	R-8	HBL60CM32V	B-51,Y-11,Y-36	HBL63CM65	Y-15
HBL5718BRIV	R-6	HBL5781	R-8	HBL60CM33	Y-10,Y-24	HBL63CM69	Y-15
HBL5719IV	R-7	HBL5781A	R-8	HBL60CM33V	Y-11	HBL63CM70	Y-13
HBL5719W	R-7	HBL5782A	R-8	HBL60CM33W	Y-10,Y-24	HBL640B	R-26
HBL57242IV	R-5	HBL5782C	R-8	HBL60CM35	B-53	HBL640BDK	R-26
HBL57242W	R-5	HBL5783IV	R-7	HBL60CM36	B-53	HBL640C	R-26
HBL5731IV	R-5	HBL5784IV	R-7	HBL60CM75	Y-7	HBL640CDK	R-26
HBL5733IV	R-5	HBL5785IV	R-7	HBL60CM83	Y-46	HBL64CM54	Y-29
HBL5735IV	R-5	HBL5785W	R-7	HBL60CM84	Y-46	HBL64CM55	Y-29
HBL5736IV	R-5	HBL5786AIV	R-7	HBL60CM88	Y-46	HBL64CM56	Y-29
HBL5736W	R-5	HBL5786AW	R-7	HBL60MIFRS	G-21,G-37	HBL64CM57	Y-29
HBL5737AIV	R-5	HBL5786IV	R-7	HBL60MISRS	G-37	HBL64CM59	Y-29
HBL5737AW	R-5	HBL5786W	R-7	HBL60RNB	F-6,G-18	HBL660B	R-32
HBL5737IV	R-5	HBL5790B	R-8	HBL6187	N-20	HBL660BDK	R-32
HBL5737W	R-5	HBL5791	R-8	HBL61CM03	Y-8	HBL660C	R-32
HBL5738AFIV	R-5	HBL5865VY	A-34	HBL61CM03LED	Y-9	HBL660CDK	R-32
HBL5738AFW	R-5	HBL5866VY	A-34	HBL61CM03W	Y-8	HBL6710BGY	R-30
HBL5738AIV	R-5	HBL5867VBK	A-34	HBL61CM03WLED	Y-9	HBL6710BIV	R-30
HBL5738AW	R-5	HBL5869VY	A-34	HBL61CM05	Y-8	HBL6710DFOGY	R-30
HBL5738IV	R-5	HBL5921	A-28	HBL61CM05LED	Y-9	HBL6710DFOIV	R-30
HBL5738W	R-5	HBL5929	A-34	HBL61CM05WLED	Y-9	HBL6710GY	R-30
HBL5739AABIV	R-5	HBL5963VBK	A-29	HBL61CM08	Y-8	HBL6710IV	R-30
HBL5739AABW	R-5	HBL5963VY	A-29	HBL61CM08LED	Y-9	HBL6711DFOGY	R-29
HBL5739AIV	R-5	HBL5965VBLK	A-28	HBL61CM08W	Y-8	HBL6711DFOIV	R-29
HBL5739IV	R-5	HBL5965VGY	A-28	HBL61CM08WLED	Y-9	HBL6711GY	R-29
HBL5739W	R-5	HBL5965VY	A-28	HBL61CM100	Y-28	HBL6711IV	R-29
HBL57442IV	R-4	HBL5966VBLK	A-28	HBL61CM22	Y-28	HBL6712TXGY	R-29
HBL57442W	R-4	HBL5966VY	A-28	HBL61CM22W	Y-28	HBL6712TXIV	R-29
HBL57443IV	R-4	HBL5969VBLK	A-29	HBL61CM25	Y-28	HBL6714AGY	R-30
HBL5744IV	R-4	HBL5969VGY	A-29	HBL61CM42	Y-15	HBL6714AIV	R-30
HBL5744S2IV	R-4	HBL5969VY	A-29	HBL61CM42LED	Y-15,Y-16	HBL6715DFOGY	R-29
HBL5744S2W	R-4	HBL5W100C	M-6	HBL61CM42W	Y-15	HBL6715DFOIV	R-29
HBL5744S3IV	R-4	HBL600B	R-8	HBL61CM42WLED	Y-15,Y-16	HBL6715GY	R-29
HBL5744SIV	R-4	HBL60100RGB	F-6,G-18	HBL61CM43	Y-13	HBL6715IV	R-29
HBL5744SW	R-4	HBL6017	A-47	HBL61CM43LED	Y-13,Y-16	HBL6717DFOGY	R-29
HBL5744W	R-4	HBL6018	A-47	HBL61CM52	Y-15	HBL6717DFOIV	R-29
HBL5745IV	R-5	HBL6019	A-47	HBL61CM52LED	Y-15,Y-16	HBL6717GY	R-29
HBL5745W	R-5	HBL6023	B-49	HBL61CM52W	Y-15	HBL6717IV	R-29
HBL57472IV	R-4	HBL6024	B-49	HBL61CM52WLED	Y-15,Y-16	HBL6717NGY	R-29
HBL57472W	R-4	HBL6027	B-47	HBL61CM53	Y-13	HBL6717NIV	R-29
HBL57473IV	R-4	HBL6028	B-47	HBL61CM53LED	Y-13,Y-16	HBL6717TCAGY	R-28
HBL5747IV	R-4	HBL6031	B-51	HBL61CM53W	Y-13	HBL6718DFOGY	R-29
HBL5747W	R-4	HBL6032	B-51	HBL61CM53WLED	Y-13,Y-16	HBL6718DFOIV	R-29
HBL57482IV	R-4	HBL6035	B-53	HBL61CM54	Y-28	HBL6718GY	R-29
HBL57482W	R-4	HBL6036	B-53	HBL61CM55	Y-28	HBL6718IV	R-29
HBL57483IV	R-4	HBL605CUT	R-8	HBL61CM56	Y-28	HBL6746HHHGY	R-30
HBL57483W	R-4	HBL605K	R-8	HBL61CM59	Y-28	HBL6746HHHIV	R-30
HBL57484IV	R-4	HBL6079	Y-41	HBL61CM64	A-30,Y-35	HBL67473BBBBBBGY	R-32
HBL57485IV	R-4	HBL607CUT	R-8	HBL61CM64BK	A-30,Y-35	HBL67473BBBBBBIV	R-32
HBL57486IV	R-4	HBL607K	R-8	HBL61CM65	A-30,Y-37	HBL67473BBBBBFFGY	R-32
HBL5748IV	R-4	HBL6080	Y-32,Y-46	HBL61CM71	Y-28	HBL67473BBBBBFFIV	R-32



# Catalog Number Index

Catalog Number	Page	Catalog Number	Page	Catalog Number	Page	Catalog Number	Page
HBL67473BBBBSSGY	R-32	HBL6P120B	M-5	HBL7428WOG	B-65,B-68,N-22	HBL7596	B-5
HBL67473BBBBSSIV	R-32	HBL6P120BM	M-5	HBL7428WOR	B-65,B-68,N-22	HBL7596N	B-5
HBL67473BBBBTTGY	R-32	HBL6P160A	M-4	HBL7428WOY	B-65,B-68,N-22	HBL7598	B-5
HBL67473BBBBTTIV	R-32	HBL6P160DA	M-4	HBL7432	B-4	HBL7716C	B-60
HBL67473BBBBXXGY	R-32	HBL6P320A	M-4	HBL7433	B-5	HBL7717C	B-60
HBL67473BBBBXXIV	R-32	HBL6P320DA	M-4	HBL7440V	B-6	HBL7764C	B-59
HBL67473BBRRRRRGY	R-32	HBL6PPS	M-9	HBL7459V	B-6	HBL7765C	B-59
HBL67473BBRRRRRIV	R-32	HBL6PS	M-9	HBL7464V	B-5	HBL7770	B-60,N-21
HBL67473RRRRXXGY	R-32	HBL6PS1050MA	M-9	HBL7465V	B-4	HBL7774WO	B-60,N-21
HBL67473RRRRXXIV	R-32	HBL6PS35015A	M-9	HBL7466	B-4	HBL7774WO	Y-13,Y-15,Y-45
HBL6747AXXGY	R-31	HBL6PS35025A	M-9	HBL7467	B-4	HBL7777	N-21
HBL6747AXXIV	R-31	HBL6PS350A	M-9	HBL7468	B-5	HBL7777A	A-49,N-21
HBL6747BBBGY	R-31	HBL6PS350YL	M-9	HBL7484	B-5	HBL7780	N-23
HBL6747BBBIV	R-31	HBL6PSHG	M-9,L-16	HBL7484V	B-5	HBL77CM15	Y-12,Y-14,Y-25
HBL6747BBFGY	R-31	HBL6RSPS2100	M-9	HBL7485	B-4	HBL77CM15W	Y-12,Y-14,Y-25
HBL6747BBFIV	R-31	HBL6W100C	M-6	HBL7485V	B-4	HBL77CM16	Y-13,Y-15,Y-25
HBL6747BBSGY	R-31	HBL702B	R-7	HBL7486	B-4	HBL77CM16W	Y-13,Y-15,Y-25
HBL6747BBSIV	R-31	HBL704IV	R-7	HBL7486N	B-4	HBL77CM17	Y-12,Y-14
HBL6747BBTGY	R-31	HBL704W	R-7	HBL7487	B-5	HBL77CM67	Y-12,Y-14
HBL6747BBTIV	R-31	HBL706IV	R-7	HBL7487N	B-5	HBL77CM74WO	B-60,N-21
HBL6747BRRGY	R-31	HBL706W	R-7	HBL7489	B-5	HBL77CM77A	A-49,N-21
HBL6747BRRIV	R-31	HBL7101C	B-17	HBL7490V	B-6	HBL7810D	F-17,F20
HBL6747BXXGY	R-31	HBL7102C	B-17	HBL7495V	B-6	HBL7810DS	F-17,F20
HBL6747BXXIV	R-31	HBL711IV	R-6	HBL7498	B-9	HBL7832D	F-17,F20
HBL6747C1GY	R-31	HBL711W	R-6	HBL74CM23WO	B-48,N-22	HBL7832DS	F-17,F20
HBL6747C1IV	R-31	HBL712IV	R-6	HBL74CM24WO	N-22,Y-10	HBL7832DX	F-17,F20
HBL6747C2GY	R-31	HBL717IV	R-6	HBL74CM25WOA	B-50,N-22	HBL7842D	F-17,F21
HBL6747C2IV	R-31	HBL717W	R-6	HBL74CM25WOAW	N-22,Y-10	HBL7843D	F-17,F21
HBL6747JXXGY	R-31	HBL718IV	R-6	HBL75010IV	R-4	HBL7852D	F-17,F21
HBL6747JXXIV	R-31	HBL718W	R-6	HBL75010W	R-4	HBL7853D	F-17,F21
HBL6747RRFGY	R-31	HBL7210B	B-17	HBL7505IV	R-4	HBL7862D	F-17,F21
HBL6747RRFIV	R-31	HBL7217B	B-17	HBL7506C	B-9	HBL7862FWD	F-17,F21
HBL6747RXXGY	R-31	HBL7250	A-35	HBL750TFIV	R-7	HBL7863D	F-17,F21
HBL6747RXXIV	R-31	HBL7251C	A-35	HBL7513C	A-41	HBL7863FWD	F-17,F21
HBL6750B10GY	R-28	HBL7301A	A-43	HBL7515C	A-41	HBL7882D	F-17,F21
HBL6750B10IV	R-28	HBL7302C	A-43	HBL7524C	B-9	HBL7883D	F-17,F21
HBL6750C075GY	R-28	HBL7303C	A-43	HBL7526	B-9	HBL792	O-39
HBL6750C075IV	R-28	HBL7310B	B-43	HBL7526C	B-9	HBL793	O-39
HBL6750C135GY	R-28	HBL7310BG	B-43	HBL7529A	B-49	HBL794	O-39
HBL6750C135IV	R-28	HBL7314C	B-43	HBL7535	B-9	HBL7940	A-41
HBL6750C195GY	R-28	HBL7314GCB	B-43	HBL7540	B-9	HBL7958	B-59
HBL6750C195IV	R-28	HBL7320	N-22	HBL7545C	B-9	HBL7962	A-41
HBL6750C315GY	R-28	HBL7341	N-29	HBL7551	B-4	HBL7968	B-59
HBL6750C315IV	R-28	HBL7341SS	N-17	HBL7555	B-41	HBL7977	A-41
HBL6750CGY	R-28	HBL7342RKL	N-17	HBL7555G	B-41	HBL7DBBK	H-7
HBL6750CGY	R-28	HBL7349	N-21	HBL7556	B-41	HBL7DBBL	H-7
HBL6750CIV	R-28	HBL7371	A-45	HBL7556G	B-41	HBL7DBBN	H-7
HBL6750DAGY	R-28	HBL7372RKL	N-17	HBL7557	B-41	HBL7DBGN	H-7
HBL6750GY	R-31,R-45	HBL7379	B-59	HBL7557G	B-41	HBL7DBO	H-7
HBL6750IV	R-31,R-45	HBL7382	B-60	HBL7565C	B-41	HBL7DBR	H-7
HBL6750TFGY	R-30	HBL7383	B-60	HBL7565CY	B-41	HBL7DBW	H-7
HBL6750TFIV	R-30	HBL73CM14C	B-43	HBL7567C	B-41	HBL7DBY	H-7
HBL6750WCGY	R-28	HBL7408C	B-42	HBL7567CY	B-41	HBL7PS105015A	M-9
HBL6751A	R-28	HBL7409C	B-43	HBL7570	B-4	HBL7PS1050A	M-9
HBL6751DAGY	R-28	HBL7410B	B-43	HBL7571	B-5	HBL7PS1050MA	M-9
HBL6756AGY	R-30	HBL7410BG	B-43	HBL7580	B-41	HBL8013V	A-9,L-10
HBL6756AIV	R-30	HBL7411C	B-42	HBL7580G	B-41	HBL8115V	A-9,L-10
HBL6774AGY	R-30	HBL7411GCB	B-42	HBL7582	B-41	HBL8119V	A-9,L-10
HBL6774AIV	R-30	HBL7413C	B-43	HBL7582G	B-41	HBL8200	A-3,L-3
HBL6786GY	R-30	HBL7413GCB	B-43	HBL7593	B-5	HBL8200BK	A-3,L-3
HBL6786IV	R-30	HBL7417B	B-43	HBL7593V	B-5	HBL8200GY	A-3,L-3
HBL6810	A-35	HBL7420	A-46,B-48,N-22	HBL7594	B-4	HBL8200H	A-3,L-3
HBL6MPS	M-9	HBL7423WO	A-46,B-48,N-22	HBL7594V	B-4	HBL8200HG	A-3,L-3
HBL6MPS1050	M-9	HBL7424WO	N-22,Y-10,Y-45	HBL7595	B-4	HBL8200HI	A-3,L-3
		HBL7425WOA	B-50,C-11,N-22	HBL7595N	B-4	HBL8200HLA	A-3,L-3

# Catalog Number Index

Catalog Number	Page	Catalog Number	Page	Catalog Number	Page	Catalog Number	Page
HBL8200HRED	A-3,L-3	HBL8300WMRI	A-3,L-3	HBL9333	A-39	HBLALU2051H	R-35
HBL8200HW	A-3,L-3	HBL8310	A-8,L-8	HBL9337C	A-39	HBLALU20GB306	R-36
HBL8200I	A-3,L-3	HBL8310AL	A-8,L-8	HBL9350	A-39	HBLALU20GB306TR	R-36
HBL8200ILGY	A-3,L-3	HBL8310GY	A-8,L-8	HBL9360	A-41	HBLALU20GB306TR	R-36
HBL8200ILI	A-3,L-3,Y-40	HBL8310I	A-8,L-8	HBL9361	A-41	HBLALU20GB506	R-36
HBL8200ILR	A-3,L-3	HBL8310R	A-8,L-8	HBL9365	A-41	HBLALU20GB512	R-36
HBL8200ILW	A-3,L-3	HBL8310W	A-8,L-8	HBL9367	A-41	HBLALU20GB512TR	R-36
HBL8200IMRI	A-3,L-3	HBL8315C	A-9,L-10	HBL9368	A-41	HBLALU20GB512TR	R-36
HBL8200LA	A-3,L-3	HBL8315CAT	A-9,L-10	HBL9379	A-41	HBLALU20GB606	R-36
HBL8200LAMRI	A-3,L-3	HBL8315CT	A-9,L-10	HBL9395	A-39	HBLALU20GB612	R-36
HBL8200RED	A-3,L-3	HBL8319C	A-9,L-10	HBL9419	N-21	HBLALU20GB618	R-36
HBL8200RMRI	A-3,L-3	HBL8319CT	A-9,L-10	HBL9420	A-48,N-21	HBLALU20GBA606	R-36
HBL8200SGA	A-3,L-3	HBL8330A	A-40	HBL9425	A-48	HBLALU20GBA612	R-36
HBL8200SGGYA	A-3,L-3	HBL8331C	A-40	HBL9430A	A-40	HBLALU20GBA618	R-36
HBL8200SGIA	A-3,L-3	HBL8350A	A-42	HBL9431C	A-40	HBLALU20IG306	R-36
HBL8200SGLA	A-3,L-3	HBL8352C	A-42	HBL9432C	A-40	HBLALU20IG506	R-36
HBL8200SGRA	A-3,L-3	HBL8362ALSA	L-16,M-11	HBL9450A	A-42	HBLALU20IG606	R-36
HBL8200SGWA	A-3,L-3	HBL8362GYSA	I-4,L-16,M-11	HBL9451C	A-42	HBLALU24GB306	R-36
HBL8200W	A-3,L-3	HBL8362ISA	L-16,M-11	HBL9452C	A-42	HBLALU24GB306TR	R-36
HBL8200WMRI	A-3,L-3	HBL8362RSA	L-16,M-11	HBL9460A	A-43	HBLALU24GB306TR	R-36
HBL8210	A-8,L-8	HBL8362SA	L-16,M-11	HBL9461C	A-43	HBLALU24GB506	R-36
HBL8210GY	A-8,L-8	HBL8362WSA	L-16,M-11	HBL9462C	A-43	HBLALU24GB512	R-36
HBL8210I	A-8,L-8	HBL8364V	A-9,L-10	HBL96061	D-13,N-24	HBLALU24GB512TR	R-36
HBL8210R	A-8,L-8	HBL8384I	A-8,L-8	HBL96061DCH	D-13,N-24	HBLALU24GB512TR	R-36
HBL8210W	A-8,L-8	HBL8400	A-10,L-11	HBL96062	D-13,N-24	HBLALU24GB606	R-36
HBL8215C	A-9,L-10	HBL8400I	A-10,L-11	HBL96067	N-20	HBLALU24GB612	R-36
HBL8215CAT	A-9,L-10	HBL8410	A-35	HBL9758VY	A-34	HBLALU24GB618	R-36
HBL8215CT	A-9,L-10	HBL8411C	A-35	HBL981	O-39	HBLALU24GBA606	R-36
HBL8219C	A-9,L-10	HBL8420	A-35	HBL9965C	B-42	HBLALU24GBA612	R-36
HBL8219CT	A-9,L-10	HBL8421C	A-35	HBL9965GCB	B-42	HBLALU24GBA618	R-36
HBL8262ALSA	L-16,M-11	HBL8430A	A-40	HBL9977C	A-35	HBLALU24IG306	R-36
HBL8262GYSA	L-16,M-11	HBL8431C	A-40	HBL99CM65C	B-42	HBLALU24IG506	R-36
HBL8262ISA	L-16,M-11	HBL8432C	A-40	HBL9W100C	M-6	HBLALU24IG606	R-36
HBL8262RSA	L-16,M-11	HBL8450A	A-42	HBLAC1	B-37,F-5,G-18	HBLALU2C57	R-42,R-43
HBL8262SA	L-16,M-11	HBL8451C	A-42	HBLAC2	B-37,F-5,G-18	HBLALU34DRBM	R-40
HBL8262WSA	L-16,M-11	HBL8452C	A-42	HBLACFSNC	G-21, G-37	HBLALU34EBM	R-40
HBL8284	A-8,L-8	HBL8460A	A-43	HBLACFSNO	G-21, G-37	HBLALU34FBM	R-40
HBL8284I	A-8,L-8	HBL8461C	A-43	HBLAFB101BK	O-30	HBLALU34GBM	R-40
HBL8300	A-3,L-3	HBL8462C	A-43	HBLAFB101GNT	O-30	HBLALU34JBM	R-40
HBL8300BL	A-3,L-3	HBL8464V	A-10,L-11	HBLAFB101TCBK	O-30	HBLALU34NBM	R-40
HBL8300GY	A-3,L-3	HBL8469V	A-10,L-11	HBLAFB101TCGNT	O-30	HBLALU3800B10	R-38
HBL8300H	A-3,L-3	HBL8600	A-10,L-11	HBLALU01	R-38,R-39	HBLALU3806	R-38
HBL8300HG	A-3,L-3	HBL8600I	A-10,L-11	HBLALU09	R-38,R-39	HBLALU3810B	R-38
HBL8300HGN	A-3,L-3	HBL8666V	A-10,L-11	HBLALU17A	R-38,R-39	HBLALU3810B1	R-38
HBL8300HI	A-3,L-3	HBL8809C	B-17	HBLALU2000B10	R-34	HBLALU3811	R-38
HBL8300HLA	A-3,L-3	HBL8815C	B-17	HBLALU2000B5	R-34	HBLALU3815	R-38
HBL8300HRED	A-3,L-3	HBL8ESPS1050C	M-9	HBLALU2000C5	R-34	HBLALU3817	R-38
HBL8300HW	A-3,L-3	HBL8ESPS1050M	M-9	HBLALU2000WC	R-35	HBLALU3817N	R-38
HBL8300I	A-3,L-3	HBL8P120B	M-5	HBLALU2001	R-35,R-36	HBLALU3818	R-38
HBL8300ILGY	A-3,L-3	HBL8P120BM	M-5	HBLALU2003	R-35,R-36	HBLALU4800B10	R-39
HBL8300ILI	A-3,L-3	HBL8P160A	M-4	HBLALU2006	R-35,R-36	HBLALU4806	R-39
HBL8300ILR	A-3,L-3	HBL8P160DA	M-4	HBLALU2009	R-35	HBLALU4810B	R-39
HBL8300ILW	A-3,L-3	HBL8P320A	M-4	HBLALU2010A	R-35,R-36	HBLALU4810B2	R-39
HBL8300IMRI	A-3,L-3	HBL8P320DA	M-4	HBLALU2010B	R-35,R-36	HBLALU4811	R-39
HBL8300LA	A-3,L-3	HBL8PS2100DA	M-9	HBLALU2011	R-34,R-36	HBLALU4815	R-39
HBL8300LAMRI	A-3,L-3	HBL8PS2100MA	M-9	HBLALU2015	R-34,R-36	HBLALU4817	R-39
HBL8300RED	A-3,L-3	HBL8PS350YL	M-9	HBLALU2017	R-34,R-36	HBLALU4817N	R-39
HBL8300RMRI	A-3,L-3	HBL8W100C	M-6	HBLALU2018	R-34,R-36	HBLALU4818	R-39
HBL8300SGA	A-3,L-3	HBL9259	A-45	HBLALU2038	R-34,R-36	HBLALU5000B10	R-42
HBL8300SGGYA	A-3,L-3	HBL9308	A-39	HBLALU2040A	R-35,R-36	HBLALU5006	R-42
HBL8300SGIA	A-3,L-3	HBL9309	A-39	HBLALU2043	R-35	HBLALU5010B	R-42
HBL8300SGLA	A-3,L-3	HBL9315	A-39	HBLALU2044	R-34,R-36	HBLALU5010B2	R-42
HBL8300SGRA	A-3,L-3	HBL9319	A-39	HBLALU20442	R-34,R-36	HBLALU5011	R-42
HBL8300SGWA	A-3,L-3	HBL9330	A-39	HBLALU2047	R-34,R-36	HBLALU5015	R-42
HBL8300W	A-3,L-3	HBL9331	A-39	HBLALU20472	R-34,R-36	HBLALU5017	R-42

# Catalog Number Index

Catalog Number	Page	Catalog Number	Page	Catalog Number	Page	Catalog Number	Page
HBLALU5017N	R-42	HBLC40123TT	J-5	HBLDS6	F-5	HBLFRW	H-6
HBLALU5018	R-42	HBLC40163FL	J-4	HBLDS60100RS	F-6,G-18	HBLFRY	H-6
HBLALU5701	R-42,R-43	HBLC40182AFL	J-4	HBLDS6AC	F-5	HBLGWEP	R-11,R-20,R-26
HBLALU5709	R-42,R-43	HBLCBINM	Y-7	HBLDS6RC	F-6	HBLHR2535	J-6
HBLALU5717A	R-42,R-43	HBLCBISS	Y-7	HBLDS6SS	F-5	HBLHR2550	J-6
HBLALU57ABRT	R-44	HBLCF	H-7	HBLDS6SSAC	F-5	HBLHR3825	J-6
HBLALU57BL	R-44	HBLCFB301BASE	O-15	HBLDS6SSRC	F-6	HBLHR3850	J-6
HBLALU57DR	R-44	HBLCFB401BASE	O-15	HBLDS6SSVFD	F-5	HBLHR3870	J-6
HBLALU57DRBM	R-44	HBLCFB401CB	O-15	HBLDS6VFD	F-5	HBLHR5035	J-6
HBLALU57E	R-44	HBLCFB501BASE	O-15	HBLF3MBK	H-7	HBLHR5050	J-6
HBLALU57EBM	R-44	HBLCORDCLAMPBL	A-29	HBLF3MBL	H-7	HBLIMFSBK	O-35
HBLALU57F	R-44	HBLCORDCLAMPGN	A-29	HBLF3MBN	H-7	HBLIMFSGY	O-15
HBLALU57FBM	R-44	HBLCORDCLAMPOR	A-29	HBLF3MGN	H-7	HBLIWEP	R-8,R-11,R-16
HBLALU57G	R-44	HBLCORDCLAMPP	A-29	HBLF3MO	H-7	HBLKR314SGY	O-15
HBLALU57GBM	R-44	HBLCORDCLAMPY	A-29	HBLF3MR	H-7	HBLLT309SGY	O-15
HBLALU57KP2G	R-44	HBLCON2	O-35	HBLF3MSGN	H-7	HBLM3FBK	H-7
HBLALU57LPB	R-44	HBLCON3	O-35	HBLF3MW	H-7	HBLM3FBL	H-7
HBLALU57N	R-44	HBLCON3	O-35	HBLF3MY	H-7	HBLM3FBN	H-7
HBLALU57NBM	R-44	HBLCCK	B-60	HBLFBBK	H-7	HBLM3FGN	H-7
HBLALU57WC	R-42,R-43	HBLDE301SBK	O-35	HBLFBBL	H-7	HBLM3FO	H-7
HBLALU7606	R-43	HBLDE301SGY	O-15	HBLFBBN	H-7	HBLM3FR	H-7
HBLALU7610B	R-43	HBLDFBK	H-7	HBLFBGN	H-7	HBLM3FSBK	H-7
HBLALU7610B2	R-43	HBLDFBL	H-7	HBLFBO	H-7	HBLM3FW	H-7
HBLALU7611	R-43	HBLDFBN	H-7	HBLFBR	H-7	HBLM3FY	H-7
HBLALU7615	R-43	HBLDFGN	H-7	HBLFBW	H-7	HBLMAR2	O-35
HBLALU7617	R-43	HBLDFO	H-7	HBLFBY	H-7	HBLMAR3	O-35
HBLALU7617N	R-43	HBLDFR	H-7	HBLFCAPBK	H-6	HBLMBBK	H-7
HBLALU7618	R-43	HBLDFW	H-7	HBLFCAPBL	H-6	HBLMBBL	H-7
HBLALU7620B10	R-43	HBLDFY	H-7	HBLFCAPBN	H-6	HBLMBBN	H-7
HBLALUABRT	R-40	HBLDMBK	H-7	HBLFCAPGN	H-6	HBLMBGN	H-7
HBLALUBL	R-40	HBLDMBL	H-7	HBLFCAPO	H-6	HBLMBO	H-7
HBLALUC5	R-38,R-39	HBLDMBN	H-7	HBLFCAPR	H-6	HBLMBR	H-7
HBLALUC57	R-42,R-43	HBLDMGN	H-7	HBLFCAPW	H-6	HBLMBW	H-7
HBLALUDR	R-40	HBLDMO	H-7	HBLFCAPY	H-6	HBLMBY	H-7
HBLALUE	R-40	HBLDMR	H-7	HBLFG30	F-17,F-21,F-22	HBLMCAPBK	H-6
HBLALUF	R-40	HBLDMW	H-7	HBLFRBBK	H-6	HBLMCAPBL	H-6
HBLALUG	R-40	HBLDMY	H-7	HBLFRBBL	H-6	HBLMCAPBN	H-6
HBLALUJ	R-40	HBLDS10	F-5	HBLFRBBR	H-6	HBLMCAPGN	H-6
HBLALULPB	R-40	HBLDS10AC	F-5	HBLFRBGN	H-6	HBLMCAPO	H-6
HBLALULPBA	R-40	HBLDS10RC	F-6	HBLFRBK	H-6	HBLMCAPR	H-6
HBLALUN	R-40	HBLDS10SS	F-5	HBLFRBL	H-6	HBLMCAPW	H-6
HBLALUWC	R-38,R-39	HBLDS10SSAC	F-5	HBLFRBN	H-6	HBLMCAPY	H-6
HBLAM303SGY	O-15	HBLDS10SSRC	F-6	HBLFRBO	H-6	HBLMIR2	O-35
HBLAMP313SGY	O-15	HBLDS10SSVFD	F-5	HBLFRBR	H-6	HBLMIR4	O-35
HBLAT5A	U-3	HBLDS10VFD	F-5	HBLFRBW	H-6	HBLMITL	B-39,C-3
HBLAT5ERA	U-3	HBLDS3	F-5	HBLFRBY	H-6	HBLMRBBK	H-6
HBLAT5KITA	U-3	HBLDS33ACNK	F-5	HBLFRGN	H-6	HBLMRBBL	H-6
HBLAT5RAMPA	U-3	HBLDS33ACRS	F-6	HBLFRO	H-6	HBLMRBBR	H-6
HBLAT5RAMPERA	U-3	HBLDS3AC	F-5	HBLFRR	H-6	HBLMRBGN	H-6
HBLAUX	F-21,F-22	HBLDS3AC2	F-5	HBLFRSBK	H-6	HBLMRBK	H-6
HBLB7NFD13A	F-15	HBLDS3ACNK	F-5	HBLFRSBL	H-6	HBLMRBL	H-6
HBLB7NFD13AA	F-15	HBLDS3MQ5	F-9,I-7	HBLFRSBN	H-6	HBLMRBN	H-6
HBLB7NFD21A	F-15	HBLDS3MQR	F-9,I-7	HBLFRSCBK	H-6	HBLMRBO	H-6
HBLB7NFD21AA	F-15	HBLDS3MQR2	F-9,I-7	HBLFRSCBL	H-6	HBLMRBR	H-6
HBLB7NFD26A	F-15	HBLDS3NK	F-5	HBLFRSCBN	H-6	HBLMRBW	H-6
HBLB7NFD26AA	F-15	HBLDS3RC	F-6	HBLFRSCGN	H-6	HBLMRBY	H-6
HBLBL300SBK	O-35	HBLDS3RS	B-39,F-6,G-18	HBLFRSCO	H-6	HBLMRGN	H-6
HBLBL300SGY	O-15	HBLDS3SS	F-5	HBLFRSCR	H-6	HBLMRO	H-6
HBLBW	H-7	HBLDS3SSAC	F-5	HBLFRSCW	H-6	HBLMRR	H-6
HBLC25143IN	J-4	HBLDS3SSMQ5	F-9,I-7	HBLFRSCY	H-6	HBLMRSBK	H-6
HBLC25163	J-5	HBLDS3SSMQR	F-9,I-7	HBLFRSGN	H-6	HBLMRSBL	H-6
HBLC25163AIN	J-4	HBLDS3SSMQR2	F-9,I-7	HBLFRSO	H-6	HBLMRSBN	H-6
HBLC25163C	J-5	HBLDS3SSRC	F-6	HBLFRSR	H-6	HBLMRSCBK	H-6
HBLC30163TT	J-5	HBLDS3SSVFD	F-5	HBLFRSW	H-6	HBLMRSCBL	H-6
HBLC40123	J-5	HBLDS3VFD	F-5	HBLFRSY	H-6	HBLMRSCBN	H-6

# Catalog Number Index

Catalog Number	Page	Catalog Number	Page	Catalog Number	Page	Catalog Number	Page
HBLMRSCGN	H-6	HBLPTBL	H-7	HBLTRIM1WI	O-40	HBMS06501	I-11
HBLMRSCO	H-6	HBLPTBN	H-7	HBLTRIM1WWA	O-40	HBMS07501	I-15
HBLMRSCR	H-6	HBLPTGN	H-7	HBLTRIM2W	O-40	HBMS08501	I-15
HBLMRSCW	H-6	HBLPTO	H-7	HBLTRIM2WBK	O-40	HBMS09501	I-15
HBLMRSCY	H-6	HBLPTR	H-7	HBLTRIM2WGY	O-40	HBMS10501	I-15
HBLMRSGN	H-6	HBLPTW	H-7	HBLTRIM2WI	O-40	HBMS12501	I-15
HBLMRSO	H-6	HBLPTY	H-7	HBLTRIM2WWA	O-40	HBNS02501	I-11
HBLMRSR	H-6	HBLRFT1	B-37,B-39,F-6,I-5	HBLTRIM3W	O-40	HBNS03501	I-11
HBLMRSW	H-6	HBLRFT2	F-6,F12,G-18	HBLTRIM3WBK	O-40	HBNS04501	I-11
HBLMRSY	H-6	HBLRRELCI	Y-5	HBLTRIM3WGY	O-40	HBNS05501	I-11
HBLMRW	H-6	HBLRS	H-7	HBLTRIM3WI	O-40	HBNS06501	I-11
HBLMRY	H-6	HBLSCBK	H-6	HBLTRIM3WWA	O-40	HBT0204	T-4
HBLNCBK	H-6	HBLSCBL	H-6	HBLTRIM4W	O-40	HBT0204BK	T-4
HBLNCBL	H-6	HBLSCBN	H-6	HBLTRIM4WBK	O-40	HBT0204S	T-5
HBLNCBN	H-6	HBLSCCBK	H-6	HBLTRIM4WGY	O-40	HBT0204S04	T-6
HBLNCGN	H-6	HBLSCCBL	H-6	HBLTRIM4WI	O-40	HBT0204S16	T-6
HBLNCO	H-6	HBLSCCBN	H-6	HBLTRIM4WWA	O-40	HBT0204SBK	T-5
HBLNCR	H-6	HBLSCCGN	H-6	HBLTRIM6W	O-40	HBT0206	T-4
HBLNCW	H-6	HBLSCCO	H-6	HBLTRIM6WBK	O-40	HBT0206BK	T-4
HBLNCY	H-6	HBLSCCR	H-6	HBLTRIM6WGY	O-40	HBT0206S	T-5
HBLNO309SGY	O-15	HBLSCCUBPD	O-32	HBLTRIM6WI	O-40	HBT0206S04	T-6
HBLOR306SGY	O-15	HBLSCCUBPDSS	O-32	HBLTRIM6WWA	O-40	HBT0206S16	T-6
HBLORT322SGY	O-15	HBLSCCUBPDW	O-32	HBLTS	H-7	HBT0206SBK	T-5
HBLP14FS	C-11,H-13	HBLSCCUBPDWSS	O-32	HBLTSR	H-7	HBT0208	T-4
HBLP26FS	C-11,H-13	HBLSCCUBW	O-32	HBLTT2B	U-4	HBT0208BK	T-4
HBLP720FS	C-11,H-13	HBLSCCUBWSS	O-32	HBLTT3B	U-4	HBT0208S	T-5
HBLP7FS	C-11,H-13	HBLSCCW	H-6	HBLTT3ECB	U-4	HBT0208S04	T-6
HBLP8FS	C-11,H-13	HBLSCCY	H-6	HBLTT545LB	U-4	HBT0208S16	T-6
HBLP8FSY	C-11,H-13	HBLSCGN	H-6	HBLTT545RB	U-4	HBT0208SBK	T-5
HBLPA308SGY	O-15	HBLSCO	H-6	HBLTT5B	U-4	HBT0212	T-4
HBLPHA2	O-35	HBLSCR	H-6	HBLTT5ECB	U-4	HBT0212BK	T-4
HBLPHA2BSS	O-35	HBLSCSBW	O-40	HBLTVSS	Y-30	HBT0212S	T-5
HBLPHA4	O-35	HBLSCW	H-6	HBLTW	H-7	HBT0212S04	T-6
HBLPHA4BSS	O-35	HBLSCY	H-6	HBLTY	H-7	HBT0212S16	T-6
HBLPHTVNM	Y-30	HBLSDSA36	M-7	HBLVCGBK	A-47	HBT0212SBK	T-5
HBLPHTVSS	Y-30	HBLSDSA40	M-7	HBLVP3385	F-15	HBT0216	T-4
HBLPK	H-7	HBLSHA2	O-35	HBLVP3485	F-15	HBT0216BK	T-4
HBLPKL520	B-49	HBLSHA2BSS	O-35	HBLVP6385	F-15	HBT0216S	T-5
HBLPOB1	C-11,H-13	HBLSI305SGY	O-15	HBLVP6485	F-15	HBT0216S04	T-6
HBLPOB1BK	C-11,H-13	HBLSI315SGY	O-15	HBLVQ3023	F-15	HBT0216S16	T-6
HBLPOB1D	C-11,H-13	HBLSS3	B-40	HBLVQ3034	F-15	HBT0216SBK	T-5
HBLPOB1DY	C-11,H-13	HBLSS45	B-40	HBLVQ6023	F-15	HBT0218	T-4
HBLPP10A	Q-2	HBLST302SBK	O-35	HBLVQ6034	F-15	HBT0218BK	T-4
HBLPP10AAL	Q-2	HBLST302SGY	O-15	HBLWLC	N-24	HBT0218S	T-5
HBLPP10AI	Q-2	HBLTBK	H-7	HBLWPBS	J-2	HBT0218S04	T-6
HBLPP10IGA	Q-2	HBLTBL	H-7	HBLWSCS1	O-40	HBT0218S16	T-6
HBLPP10IGAI	Q-2	HBLTBN	H-7	HBLWSCS2A	O-40	HBT0218SBK	T-5
HBLPP10SA	Q-2	HBLTCGNT	O-30	HBLWSCS3A	O-40	HBT0220	T-4
HBLPP10SAI	Q-2	HBLTCGNTBK	O-30	HBLWSCS4A	O-40	HBT0220BK	T-4
HBLPP12A	Q-2	HBLTCGNTBKSW	O-15	HBLWSCS6A	O-40	HBT0220S	T-5
HBLPP12AAL	Q-2	HBLTCGNTSW	O-15	HBLWWEF	R-8	HBT0220S04	T-6
HBLPP12AI	Q-2	HBLTGN	H-7	HBMA02501	I-11	HBT0220S16	T-6
HBLPP15A	Q-2	HBLTL318SGY	O-15	HBMA03501	I-11	HBT0220SBK	T-5
HBLPP15AAL	Q-2	HBLTL319SGY	O-15	HBMA04501	I-11	HBT0222	T-4
HBLPP15AI	Q-2	HBLTO	H-7	HBMA05501	I-11	HBT0222BK	T-4
HBLPPO12A	Q-2	HBLTO310SGY	O-15	HBMA06501	I-11	HBT0222S	T-5
HBLPPO12AAL	Q-2	HBLTR	H-7	HBMF02501	I-11	HBT0222S04	T-6
HBLPPO12AI	Q-2	HBLTRED5B	U-5	HBMF03501	I-11	HBT0222S16	T-6
HBLPPO15A	Q-2	HBLTRED5ECB	U-5	HBMF04501	I-11	HBT0222SBK	T-5
HBLPPO15AAL	Q-2	HBLTRED5ECFB	U-5	HBMF05501	I-11	HBT0224	T-4
HBLPPO15AI	Q-2	HBLTRED5XB	U-5	HBMF06501	I-11	HBT0224BK	T-4
HBLPPOA	Q-2	HBLTRED5YB	U-5	HBMS02501	I-11	HBT0224S	T-5
HBLPPOAAL	Q-2	HBLTRIM1W	O-40	HBMS03501	I-11	HBT0224S04	T-6
HBLPPOAI	Q-2	HBLTRIM1WBK	O-40	HBMS04501	I-11	HBT0224S16	T-6
HBLPTBK	H-7	HBLTRIM1WGY	O-40	HBMS05501	I-11	HBT0224SBK	T-5

# Catalog Number Index

Catalog Number	Page	Catalog Number	Page	Catalog Number	Page	Catalog Number	Page
HBT0226	T-4	HBT0420SBK	T-5	HBT0808S16	T-6	HBTINSM06	T-8
HBT0226BK	T-4	HBT0422	T-4	HBT0808SBK	T-5	HBTINSM08	T-8
HBT0226S	T-5	HBT0422BK	T-4	HBT0812	T-4	HBTINSM12	T-8
HBT0226S04	T-6	HBT0422S	T-5	HBT0812BK	T-4	HBTINSM16	T-8
HBT0226S16	T-6	HBT0422S04	T-6	HBT0812S	T-5	HBTINSM18	T-8
HBT0226SBK	T-5	HBT0422S16	T-6	HBT0812S04	T-6	HBTINSM20	T-8
HBT0228	T-4	HBT0422SBK	T-5	HBT0812S16	T-6	HBTINSM24	T-8
HBT0228BK	T-4	HBT0424	T-4	HBT0812SBK	T-5	HBTINSNM04	T-8
HBT0228S	T-5	HBT0424BK	T-4	HBT0816	T-4	HBTINSNM06	T-8
HBT0228S04	T-6	HBT0424S	T-5	HBT0816BK	T-4	HBTINSNM08	T-8
HBT0228S16	T-6	HBT0424S04	T-6	HBT0816S	T-5	HBTINSNM12	T-8
HBT0228SBK	T-5	HBT0424S16	T-6	HBT0816S04	T-6	HBTINSNM16	T-8
HBT0230	T-4	HBT0424SBK	T-5	HBT0816S16	T-6	HBTINSNM18	T-8
HBT0230BK	T-4	HBT0428	T-4	HBT0816SBK	T-5	HBTINSNM20	T-8
HBT0230S	T-5	HBT0428BK	T-4	HBT0818	T-4	HBTINSNM24	T-8
HBT0230S04	T-6	HBT0428S	T-5	HBT0818BK	T-4	HBTLB12	T-7
HBT0230S16	T-6	HBT0428S04	T-6	HBT0818S	T-5	HBTLB16	T-7
HBT0230SBK	T-5	HBT0428S16	T-6	HBT0818S04	T-6	HBTLB18	T-7
HBT0232	T-4	HBT0428SBK	T-5	HBT0818S16	T-6	HBTLB20	T-7
HBT0232BK	T-4	HBT0608	T-4	HBT0818SBK	T-5	HBTLB24	T-7
HBT0232S	T-5	HBT0608BK	T-4	HBT0820	T-4	HBTLB4	T-7
HBT0232S04	T-6	HBT0608S	T-5	HBT0820BK	T-4	HBTLB6	T-7
HBT0232S16	T-6	HBT0608S04	T-6	HBT0820S	T-5	HBTLB8	T-7
HBT0232SBK	T-5	HBT0608S16	T-6	HBT0820S04	T-6	HBTLC	T-7
HBT0404	T-4	HBT0608SBK	T-5	HBT0820S16	T-6	HBTRA	T-8
HBT0404BK	T-4	HBT0612	T-4	HBT0820SBK	T-5	HBTRD12	T-7
HBT0404S	T-5	HBT0612BK	T-4	HBTBS	T-8,T-9	HBTRD4	T-7
HBT0404S04	T-6	HBT0612S	T-5	HBTCA3	T-8	HBTRD6	T-7
HBT0404S16	T-6	HBT0612S04	T-6	HBTCB12	T-7	HBTSC	T-7
HBT0404SBK	T-5	HBT0612S16	T-6	HBTCB18	T-7	HBTSSK	T-8,T-9
HBT0406	T-4	HBT0612SBK	T-5	HBTCB4	T-7	HBTSS12	T-7
HBT0406BK	T-4	HBT0616	T-4	HBTCB8	T-7	HBTSS16	T-7
HBT0406S	T-5	HBT0616BK	T-4	HBTCLGS	T-7	HBTSS18	T-7
HBT0406S04	T-6	HBT0616S	T-5	HBTCLGS12	T-7	HBTSS20	T-7
HBT0406S16	T-6	HBT0616S04	T-6	HBTCLGS16	T-7	HBTSS24	T-7
HBT0406SBK	T-5	HBT0616S16	T-6	HBTCLGS18	T-7	HBTSS4	T-7
HBT0408	T-4	HBT0616SBK	T-5	HBTCLGS20	T-7	HBTSS6	T-7
HBT0408BK	T-4	HBT0618	T-4	HBTCLGS24	T-7	HBTSS8	T-7
HBT0408S	T-5	HBT0618BK	T-4	HBTCS	T-8,T-9	HBTSS12	T-7
HBT0408S04	T-6	HBT0618S	T-5	HBTCTRS12	T-7	HBTSS16	T-7
HBT0408S16	T-6	HBT0618S04	T-6	HBTCTRS16	T-7	HBTSS18	T-7
HBT0408SBK	T-5	HBT0618S16	T-6	HBTCTRS18	T-7	HBTSS20	T-7
HBT0412	T-4	HBT0618SBK	T-5	HBTCTRS20	T-7	HBTSS24	T-7
HBT0412BK	T-4	HBT0620	T-4	HBTCTRS24	T-7	HBTSS4	T-7
HBT0412S	T-5	HBT0620BK	T-4	HBTCTRS4	T-7	HBTSS6	T-7
HBT0412S04	T-6	HBT0620S	T-5	HBTCTRS6	T-7	HBTSS8	T-7
HBT0412S16	T-6	HBT0620S04	T-6	HBTCTRS8	T-7	HBTSS12	T-7
HBT0412SBK	T-5	HBT0620S16	T-6	HBTCTRS12	T-7	HBTSS16	T-7
HBT0416	T-4	HBT0620SBK	T-5	HBTCTRS16	T-7	HBTSS18	T-7
HBT0416BK	T-4	HBT0622	T-4	HBTCTRS18	T-7	HBTSS20	T-7
HBT0416S	T-5	HBT0622BK	T-4	HBTCTRS20	T-7	HBTSS24	T-7
HBT0416S04	T-6	HBT0622S	T-5	HBTCTRS24	T-7	HBTSS4	T-7
HBT0416S16	T-6	HBT0622S04	T-6	HBTCTRS4	T-7	HBTSS6	T-7
HBT0416SBK	T-5	HBT0622S16	T-6	HBTCTRS6	T-7	HBTSS8	T-7
HBT0418	T-4	HBT0622SBK	T-5	HBTCTRS8	T-7	HBTSS12	T-7
HBT0418BK	T-4	HBT0624	T-4	HBTCTRS12	T-7	HBTSS16	T-7
HBT0418S	T-5	HBT0624BK	T-4	HBTCTRS16	T-7	HBTSS18	T-7
HBT0418S04	T-6	HBT0624S	T-5	HBTCTRS18	T-7	HBTSS20	T-7
HBT0418S16	T-6	HBT0624S04	T-6	HBTCTRS20	T-7	HBTSS24	T-7
HBT0418SBK	T-5	HBT0624S16	T-6	HBTCTRS24	T-7	HBTSS4	T-7
HBT0420	T-4	HBT0624SBK	T-5	HBTCTRS4	T-7	HBTSS6	T-7
HBT0420BK	T-4	HBT0808	T-4	HBTCTRS6	T-7	HBTSS8	T-7
HBT0420S	T-5	HBT0808BK	T-4	HBTCTRS8	T-7	HBTSS12	T-7
HBT0420S04	T-6	HBT0808S	T-5	HBTCTRS12	T-7	HBTSS16	T-7
HBT0420S16	T-6	HBT0808S04	T-6	HBTCTRS16	T-7	HBTSS18	T-7
				HBTCTRS18	T-7	HBTSS20	T-7
				HBTCTRS20	T-7	HBTSS24	T-7
				HBTCTRS24	T-7	HBTSS4	T-7
				HBTCTRS4	T-7	HBTSS6	T-7
				HBTCTRS6	T-7	HBTSS8	T-7
				HBTCTRS8	T-7	HBTSS12	T-7
				HBTCTRS12	T-7	HBTSS16	T-7
				HBTCTRS16	T-7	HBTSS18	T-7
				HBTCTRS18	T-7	HBTSS20	T-7
				HBTCTRS20	T-7	HBTSS24	T-7
				HBTCTRS24	T-7	HBTSS4	T-7
				HBTCTRS4	T-7	HBTSS6	T-7
				HBTCTRS6	T-7	HBTSS8	T-7
				HBTCTRS8	T-7	HBTSS12	T-7
				HBTCTRS12	T-7	HBTSS16	T-7
				HBTCTRS16	T-7	HBTSS18	T-7
				HBTCTRS18	T-7	HBTSS20	T-7
				HBTCTRS20	T-7	HBTSS24	T-7
				HBTCTRS24	T-7	HBTSS4	T-7
				HBTCTRS4	T-7	HBTSS6	T-7
				HBTCTRS6	T-7	HBTSS8	T-7
				HBTCTRS8	T-7	HBTSS12	T-7
				HBTCTRS12	T-7	HBTSS16	T-7
				HBTCTRS16	T-7	HBTSS18	T-7
				HBTCTRS18	T-7	HBTSS20	T-7
				HBTCTRS20	T-7	HBTSS24	T-7
				HBTCTRS24	T-7	HBTSS4	T-7
				HBTCTRS4	T-7	HBTSS6	T-7
				HBTCTRS6	T-7	HBTSS8	T-7
				HBTCTRS8	T-7	HBTSS12	T-7
				HBTCTRS12	T-7	HBTSS16	T-7
				HBTCTRS16	T-7	HBTSS18	T-7
				HBTCTRS18	T-7	HBTSS20	T-7
				HBTCTRS20	T-7	HBTSS24	T-7
				HBTCTRS24	T-7	HBTSS4	T-7
				HBTCTRS4	T-7	HBTSS6	T-7
				HBTCTRS6	T-7	HBTSS8	T-7
				HBTCTRS8	T-7	HBTSS12	T-7
				HBTCTRS12	T-7	HBTSS16	T-7
				HBTCTRS16	T-7	HBTSS18	T-7
				HBTCTRS18	T-7	HBTSS20	T-7
				HBTCTRS20	T-7	HBTSS24	T-7
				HBTCTRS24	T-7	HBTSS4	T-7
				HBTCTRS4	T-7	HBTSS6	T-7
				HBTCTRS6	T-7	HBTSS8	T-7
				HBTCTRS8	T-7	HBTSS12	T-7
				HBTCTRS12	T-7	HBTSS16	T-7
				HBTCTRS16	T-7	HBTSS18	T-7
				HBTCTRS18	T-7	HBTSS20	T-7
				HBTCTRS20	T-7	HBTSS24	T-7
				HBTCTRS24	T-7	HBTSS4	T-7
				HBTCTRS4	T-7	HBTSS6	T-7
				HBTCTRS6	T-7	HBTSS8	T-7
				HBTCTRS8	T-7	HBTSS12	T-7
				HBTCTRS12	T-7	HBTSS16	T-7
				HBTCTRS16	T-7	HBTSS18	T-7
				HBTCTRS18	T-7	HBTSS20	T-7
				HBTCTRS20	T-7	HBTSS24	T-7
				HBTCTRS24	T-7	HBTSS4	T-7
				HBTCTRS4	T-7	HBTSS6	T-7
				HBTCTRS6	T-7	HBTSS8	T-7
				HBTCTRS8	T-7	HBTSS12	T-7
				HBTCTRS12	T-7	HBTSS16	T-7
				HBTCTRS16	T-7	HBTSS18	T-7
				HBTCTRS18	T-7	HBTSS20	T-7
				HBTCTRS20	T-7	HBTSS24	T-7
				HBTCTRS24	T-7	HBTSS4	T-7
				HBTCTRS4	T-7	HBTSS6	T-7
				HBTCTRS6	T-7	HBTSS8	T-7
				HBTCTRS8	T-7	HBTSS12	T-7
				HBTCTRS12	T-7	HBTSS16	T-7
				HBTCTRS16	T-7	HBTSS18	T-7
				HBTCTRS18	T-7	HBTSS20	T-7
				HBTCTRS20	T-7	HBTSS24	T-7
				HBTCTRS24	T-7	HBTSS4	T-7
				HBTCTRS4	T-7	HBTSS6	T-7
				HBTCTRS6	T-7	HBTSS8	T-7
				HBTCTRS8	T-7	HBTSS12	T-7
				HBTCTRS12	T-7	HBTSS16	T-7
				HBTCTRS16	T-7	HBTSS18	T-7
				HBTCTRS18	T-7	HBTSS20	T-7
				HBTCTRS20	T-7	HBTSS24	T-7
				HBTCTRS24	T-7	HBTSS4	T-7
				HBTCTRS4	T-7	HBTSS6	T-7
				HBTCTRS6	T-7	HBTSS8	T-7
				HBTCTRS8	T-7	HBTSS12	T-7
				HBTCTRS12	T-7	HBTSS16	T-7
				HBTCTRS16	T-7	HBTSS18	T-7
				HBTCTRS18	T-7	HBTSS20	T-7
				HBTCTRS20	T-7	HBTSS24	T-7
				HBTCTRS24	T-7	HBTSS4	T-7
				HBTCTRS4	T-7	HBTSS6	T-7
				HBTCTRS6	T-7	HBTSS8	T-7
				HBTCTRS8	T-7	HBTSS12	T-7
				HBTCTRS12	T-7	HBTSS16	T-7
				HBTCTRS16	T-7	HBTSS18	T-7
				HBTCTRS18	T-7	HBTSS20	T-7
				HBTCTRS20	T-7	HBTSS24	T-7
				HBTCTRS24	T-7	HBTSS4	T-7
				HBTCTRS4	T-7	HBTSS6	T-7
				HBTCTRS6	T-7	HBTSS8	T-7
				HBTCTRS8	T-7	HBTSS12	T-7
				HBTCTRS12	T-7	HBTSS16	T-7
				HBTCTRS16	T-7	HBTSS18	T-7
				HBTCTRS18	T-7	HBTSS20	T-7
				HBTCTRS20	T-7	HBTSS24	T-7
				HBTCTRS24	T-7	HBTSS4	T-7
				HBTCTRS4	T-7	HBTSS6	T-7
				HBTCTRS6	T-7	HBTSS8	T-7
				HBTCTRS8	T-7	HBTSS12	T-7
				HBTCTRS12	T-7	HBTSS16	T-7
				HBTCTRS16	T-7	HBTSS18	T-7
				HBTCTRS18	T-7	HBTSS20	T-7
				HBTCTRS20	T-7	HBTSS24	T-7
				HBTCTRS24	T-7	HBTSS4	T-7
				HBTCTRS4	T-7	HBTSS6	T-7
				HBTCTRS6	T-7	HBTSS8	T-7
				HBTCTRS8	T-7	HBTSS12	T-7
				HBTCTRS12	T-7	HBTSS16	T-7
				HBTCTRS16	T-7	HBTSS18	T-7
				HBTCTRS18	T-7	HBTSS20	T-7
				HBTCTRS20	T-7	HBTSS24	T-7
				HBTCTRS24	T-7	HBTSS4	T-7
				HBTCTRS4	T-7	HBTSS6	T-7
				HBTCTRS6	T-7	HBTSS8	T-7
				HBTCTRS8	T-7	HBTSS12	T-7
				HBTCTRS12	T-7	HBTSS16	T-7
				HBTCTRS16	T-7	HBTSS18	T-7
				HBTCTRS18	T-7	HBTSS20	T-7
				HBTCTRS20	T-7	HBTSS24	T-7
				HBTCTRS24	T-7	HBTSS4	T-7
				HBTCTRS4	T-7	HBTSS6	T-7
				HBTCTRS6	T-7	HBTSS8	T-7
				HBTCTRS8	T-7	HBTSS12	T-7
				HBTCTRS12	T-7	HBTSS16	T-7
				HBTCTRS16	T-7	HBTSS18	T-7
				HBTCTRS18	T-7	HBTSS20	T-7

# Catalog Number Index

Catalog Number	Page	Catalog Number	Page	Catalog Number	Page	Catalog Number	Page
HC5ER03	W-20	HCMA05F9	I-17	HCMS101	I-13	HIMS03F13	I-17
HC5ER05	W-20	HCMA061	I-9	HCMS10103	I-13	HIMS03F9	I-17
HC5ER07	W-20	HCMA06103	I-9	HCMS10106	I-13	HIMS04F13	I-17
HC5ER10	W-20	HCMA06106	I-9	HCMS10112	I-13	HIMS04F16	I-17
HC5ER15	W-20	HCMA06112	I-9	HCMS121	I-13	HIMS04F9	I-17
HC5ER20	W-20	HCMA071	I-13	HCMS12103	I-13	HIMS05F13	I-17
HC5ER25	W-20	HCMA07103	I-13	HCMS12106	I-13	HIMS05F16	I-17
HC5EY01	W-20	HCMA07106	I-13	HCMS12112	I-13	HIMS05F9	I-17
HC5EY03	W-20	HCMA07112	I-13	HCT101141	I-38	HISF11	I-44
HC5EY05	W-20	HCMA081	I-13	HCT10114K	I-38	HISF12	I-44
HC5EY07	W-20	HCMA08103	I-13	HCT102191	I-38	HISF22	I-44
HC5EY10	W-20	HCMA08106	I-13	HCT10219K	I-38	HISF24	I-44
HC5EY15	W-20	HCMA08112	I-13	HCT161191	I-38	HJ1001BPK25	V-86
HC5EY20	W-20	HCMA091	I-13	HCT16119K	I-38	HJ1001GPK25	V-86
HC5EY25	W-20	HCMA09103	I-13	HCT161341	I-38	HJ1002BPK25	V-86
HC6B01	W-20	HCMA09106	I-13	HCT16134K	I-38	HJ1002GPK25	V-86
HC6B03	W-20	HCMA09112	I-13	HCT162191	I-38	HJ1003BPK25	V-86
HC6B05	W-20	HCMA101	I-13	HCT16219K	I-38	HJ1003GPK25	V-86
HC6B07	W-20	HCMA10103	I-13	HCT162341	I-38	HJ1004BPK25	V-86
HC6B10	W-20	HCMA10106	I-13	HCT16234K	I-38	HJ1004GPK25	V-86
HC6B15	W-20	HCMA10112	I-13	HCT163341	I-38	HJ1005BPK25	V-86
HC6B20	W-20	HCMA121	I-13	HCT16334K	I-38	HJ1005GPK25	V-86
HC6B25	W-20	HCMA12103	I-13	HCT164341	I-38	HJ1006BPK25	V-86
HC6GY01	W-20	HCMA12106	I-13	HCT16434K	I-38	HJ1006GPK25	V-86
HC6GY03	W-20	HCMA12112	I-13	HCT251341	I-38	HJ1010BPK25	V-86
HC6GY05	W-20	HCMS021	I-9	HCT25134K	I-38	HJ1010GPK25	V-86
HC6GY07	W-20	HCMS02103	I-9	HCT252341	I-38	HJ1011BPK25	V-86
HC6GY10	W-20	HCMS02106	I-9	HCT25234K	I-38	HJ1011GPK25	V-86
HC6GY15	W-20	HCMS02112	I-9	HCT252471	I-38	HJ1012BPK25	V-86
HC6GY20	W-20	HCMS031	I-9	HCT25247K	I-38	HJ1012GPK25	V-86
HC6GY25	W-20	HCMS03103	I-9	HCT253471	I-38	HJ1013BPK25	V-86
HC6R01	W-20	HCMS03106	I-9	HCT25347K	I-38	HJ1013GPK25	V-86
HC6R03	W-20	HCMS03112	I-9	HCTBK101	I-39	HJ1014BPK25	V-86
HC6R05	W-20	HCMS03F13	I-17	HCTBK102	I-39	HJ1014GPK25	V-86
HC6R07	W-20	HCMS03F9	I-17	HCTBK161	I-39	HJ1015BPK25	V-86
HC6R10	W-20	HCMS041	I-9	HCTBK162	I-39	HJ1015GPK25	V-86
HC6R15	W-20	HCMS04103	I-9	HCTBK163	I-39	HJ1038BPK25	V-86
HC6R20	W-20	HCMS04106	I-9	HCTBK164	I-39	HJ1038GPK25	V-86
HC6R25	W-20	HCMS04112	I-9	HCTBK251	I-39	HJ1039BPK25	V-86
HC6Y01	W-20	HCMS04F13	I-17	HCTBK252	I-39	HJ1039GPK25	V-86
HC6Y03	W-20	HCMS04F16	I-17	HCTBK253	I-39	HJ1040BPK25	V-86
HC6Y05	W-20	HCMS04F9	I-17	HCTSP16PK12	I-39	HJ1040GPK25	V-86
HC6Y07	W-20	HCMS051	I-9	HCTSP25PK12	I-39	HJ1041BPK25	V-86
HC6Y10	W-20	HCMS05103	I-9	HDCXXBK	W-15	HJ1041GPK25	V-86
HC6Y15	W-20	HCMS05106	I-9	HDHXXBK	W-15	HJ1042BPK25	V-86
HC6Y20	W-20	HCMS05112	I-9	HDLXXBK	W-15	HJ1042GPK25	V-86
HC6Y25	W-20	HCMS05F13	I-17	HDMIC1	W-7	HJ1043BPK25	V-86
HCMA021	I-9	HCMS05F16	I-17	HDMIC14	W-7	HJ1043GPK25	V-86
HCMA02103	I-9	HCMS05F9	I-17	HDMIT14	W-7	HJ1044BPK25	V-86
HCMA02106	I-9	HCMS061	I-9	HDPC03BK	W-15	HJ1044GPK25	V-86
HCMA02112	I-9	HCMS06103	I-9	HDPC06BK	W-15	HJ1055BPK25	V-86
HCMA031	I-9	HCMS06106	I-9	HI5E	I-44	HJ1055GPK25	V-86
HCMA03103	I-9	HCMS06112	I-9	HI5EC	I-44	HJ1056BPK25	V-86
HCMA03106	I-9	HCMS071	I-13	HI6	I-44	HJ1056GPK25	V-86
HCMA03112	I-9	HCMS07103	I-13	HI6C	I-44	HJ1057BPK25	V-86
HCMA03F9	I-17	HCMS07106	I-13	HI6XXAA	I-44	HJ1057GPK25	V-86
HCMA041	I-9	HCMS07112	I-13	HI6XXAE	I-44	HJ1058BPK25	V-86
HCMA04103	I-9	HCMS081	I-13	HI6XEE	I-44	HJ1058GPK25	V-86
HCMA04106	I-9	HCMS08103	I-13	HIC	I-44	HJ1059BPK25	V-86
HCMA04112	I-9	HCMS08106	I-13	HICH	I-44	HJ1059GPK25	V-86
HCMA04F9	I-17	HCMS08112	I-13	HIDRUBCKIT	A-44	HJ1060BPK25	V-86
HCMA051	I-9	HCMS091	I-13	HIDRUBCKIT	I-41	HJ1060GPK25	V-86
HCMA05103	I-9	HCMS09103	I-13	HIMA03F9	I-17	HJMS021	I-9
HCMA05106	I-9	HCMS09106	I-13	HIMA04F9	I-17	HJMS02103	I-9
HCMA05112	I-9	HCMS09112	I-13	HIMA05F9	I-17	HJMS02106	I-9

# Catalog Number Index

Catalog Number	Page	Catalog Number	Page	Catalog Number	Page	Catalog Number	Page
HJMS02112	I-9	HMQR2	I-14, I-16	HPMS051	I-9	HRNS03501	I-11
HJMS031	I-9	HMQR3	I-14, I-16	HPMS05103	I-9	HRNS04501	I-11
HJMS03103	I-9	HPCAP1	I-10, I-12	HPMS05106	I-9	HRNS05501	I-11
HJMS03106	I-9	HPCAP2	I-14, I-16	HPMS05112	I-9	HRNS06501	I-11
HJMS03112	I-9	HPCAP3	I-14, I-16	HPMS05F13	I-17	HS1001BPK25	V-86
HJMS041	I-9	HPMA021	I-9	HPMS05F16	I-17	HS1001GPK25	V-86
HJMS04103	I-9	HPMA02103	I-9	HPMS05F9	I-17	HS1002BPK25	V-86
HJMS04106	I-9	HPMA02106	I-9	HPMS061	I-9	HS1002GPK25	V-86
HJMS04112	I-9	HPMA02112	I-9	HPMS06103	I-9	HS1003BPK25	V-86
HJMS051	I-9	HPMA031	I-9	HPMS06106	I-9	HS1003GPK25	V-86
HJMS05103	I-9	HPMA03103	I-9	HPMS06112	I-9	HS1004BPK25	V-86
HJMS05106	I-9	HPMA03106	I-9	HPMS071	I-13	HS1004GPK25	V-86
HJMS05112	I-9	HPMA03112	I-9	HPMS07103	I-13	HSLDPK2	D-13
HJMS061	I-9	HPMA03F9	I-17	HPMS07106	I-13	HSLDPK2	Z-3
HJMS06103	I-9	HPMA041	I-9	HPMS07112	I-13	HXJ5EAL	R-46,W-2
HJMS06106	I-9	HPMA04103	I-9	HPMS081	I-13	HXJ5EAL25	W-2
HJMS06112	I-9	HPMA04106	I-9	HPMS08103	I-13	HXJ5EB	W-2
HJMS071	I-13	HPMA04112	I-9	HPMS08106	I-13	HXJ5EB25	W-2
HJMS07103	I-13	HPMA04F9	I-17	HPMS08112	I-13	HXJ5EBK	W-2
HJMS07106	I-13	HPMA051	I-9	HPMS091	I-13	HXJ5EBK25	W-2
HJMS07112	I-13	HPMA05103	I-9	HPMS09103	I-13	HXJ5EEI	W-2
HJMS081	I-13	HPMA05106	I-9	HPMS09106	I-13	HXJ5EEI25	W-2
HJMS08103	I-13	HPMA05112	I-9	HPMS09112	I-13	HXJ5EGN	W-2
HJMS08106	I-13	HPMA05F9	I-17	HPMS101	I-13	HXJ5EGN25	W-2
HJMS08112	I-13	HPMA061	I-9	HPMS10103	I-13	HXJ5EGY	W-2
HJMS091	I-13	HPMA06103	I-9	HPMS10106	I-13	HXJ5EGY25	W-2
HJMS09103	I-13	HPMA06106	I-9	HPMS10112	I-13	HXJ5ELA	W-2
HJMS09106	I-13	HPMA06112	I-9	HPMS121	I-13	HXJ5ELA25	W-2
HJMS09112	I-13	HPMA071	I-13	HPMS12103	I-13	HXJ5EOR	W-2
HJMS101	I-13	HPMA07103	I-13	HPMS12106	I-13	HXJ5EOR25	W-2
HJMS10103	I-13	HPMA07106	I-13	HPMS12112	I-13	HXJ5EOW	R-63,W-2
HJMS10106	I-13	HPMA07112	I-13	HPS1347BK	N-9	HXJ5EOW25	W-2
HJMS10112	I-13	HPMA081	I-13	HPS1347GY	N-9	HXJ5ER	W-2
HJMS121	I-13	HPMA08103	I-13	HPS1347I	N-9	HXJ5ER25	W-2
HJMS12103	I-13	HPMA08106	I-13	HPS1347W	N-9	HXJ5EW	W-2
HJMS12106	I-13	HPMA08112	I-13	HPS2347BK	N-9	HXJ5EW25	W-2
HJMS12112	I-13	HPMA091	I-13	HPS2347GY	N-9	HXJ5EY	W-2
HKLD	Z-3	HPMA09103	I-13	HPS2347I	N-9	HXJ5EY25	W-2
HKLDPK2	Z-3	HPMA09106	I-13	HPS2347W	N-9	HXJ6AL	R-46,W-2
HLD	A-47,B-49,Z-3	HPMA09112	I-13	HPS3347I	N-9	HXJ6AL25	W-2
HLD2	A-48,B-51,Z-3	HPMA101	I-13	HPS3347W	N-9	HXJ6B	W-2
HLDKIT	Z-3	HPMA10103	I-13	HRCAP1	I-10, I-12	HXJ6B25	W-2
HLDMP	A-47,B-49,Z-3	HPMA10106	I-13	HRCAP2	I-14, I-16	HXJ6BK	W-2
HMHB21U	E-9	HPMA10112	I-13	HRCAP3	I-14, I-16	HXJ6BK25	W-2
HMHB21UP	E-9	HPMA121	I-13	HRMA02501	I-11	HXJ6EI	W-2
HMHB21UPCW	E-11	HPMA12103	I-13	HRMA03501	I-11	HXJ6EI25	W-2
HMHB22U	E-9	HPMA12106	I-13	HRMA04501	I-11	HXJ6GN	W-2
HMHB22UP	E-9	HPMA12112	I-13	HRMA05501	I-11	HXJ6GN25	W-2
HMHB22UPCW	E-11	HPMS021	I-9	HRMA06501	I-11	HXJ6GY	W-2
HMHB23A	E-9	HPMS02103	I-9	HRMF02501	I-11	HXJ6GY25	W-2
HMHB23AP	E-9	HPMS02106	I-9	HRMF03501	I-11	HXJ6LA	W-2
HMHB23APCW	E-11	HPMS02112	I-9	HRMF04501	I-11	HXJ6LA25	W-2
HMHB23B	E-9	HPMS031	I-9	HRMF05501	I-11	HXJ6OR	W-2
HMHB23BP	E-9	HPMS03103	I-9	HRMF06501	I-11	HXJ6OR25	W-2
HMHB23BPCW	E-11	HPMS03106	I-9	HRMS02501	I-11	HXJ6OW	R-63,W-2
HMHB2LV	E-9	HPMS03112	I-9	HRMS03501	I-11	HXJ6OW25	W-2
HMHB2LVP	E-9	HPMS03F13	I-17	HRMS04501	I-11	HXJ6R	W-2
HMHB2LVPCW	E-11	HPMS03F9	I-17	HRMS05501	I-11	HXJ6R25	W-2
HMHBEP	E-9	HPMS041	I-9	HRMS06501	I-11	HXJ6W	W-2
HMHBL180	E-11	HPMS04103	I-9	HRMS07501	I-15	HXJ6W25	W-2
HMHBL360	E-11	HPMS04106	I-9	HRMS08501	I-15	HXJ6Y	W-2
HMHBLA	E-11	HPMS04112	I-9	HRMS09501	I-15	HXJ6Y25	W-2
HMHBLEA	E-11	HPMS04F13	I-17	HRMS10501	I-15	HXJUAL	R-46,W-2
HMHBSA	E-9	HPMS04F16	I-17	HRMS12501	I-15	HXJUB	W-2
HMQR1	I-10	HPMS04F9	I-17	HRNS02501	I-11	HXJUBK	W-2

# Catalog Number Index

Catalog Number	Page	Catalog Number	Page	Catalog Number	Page	Catalog Number	Page
HXJUEI	W-2	IFP212OW	R-63,W-5	IG5252I	A-17,M-16	IG8362GYSA	L-16,M-11
HXJUGN	W-2	IFP212W	W-5	IG5252ITR	A-17,M-16	IG8362ISA	L-16,M-11
HXJUGY	W-2	IFP26AL	W-5	IG5252LA	A-17,M-16	IG8362OSA	L-16,M-11
HXJULA	W-2	IFP26BK	W-5	IG5252TR	A-17,M-16	IG8362RSA	L-16,M-11
HXJUOR	W-2	IFP26EI	W-5	IG5252W	A-17,M-16	IG8362SA	L-16,M-11
HXJUOW	R-63,W-2	IFP26GY	W-5	IG5252WTR	A-17,M-16	IG8362WSA	L-16,M-11
HXJUOW25	W-2	IFP26LA	W-5	IG5261	A-12,M-15	IG9308	A-39,M-16
HXJUR	W-2	IFP26OW	R-63,W-5	IG5261WR	A-12,M-15	IG9330	A-39,M-16
HXJUW	W-2	IFP26W	W-5	IG5262	A-12,M-15	IGN100	W-2
HXJUY	W-2	IFP29BK	W-5	IG5262GY	A-12,M-15	IGN100C	W-2
IB100	W-2	IFP29EI	W-5	IG5262GYSA	M-11	IGN100T	W-2
IB100C	W-2	IFP29GY	W-5	IG5262GYWR	A-12,M-15	IGY100	W-2
IB100T	W-2	IFP29LA	W-5	IG5262I	A-12,M-15	IGY100C	W-2
IBK100	W-2	IFP29OW	R-63,W-5	IG5262ISA	M-11	IGY100T	W-2
IBK100C	W-2	IFP29W	W-5	IG5262IWR	A-12,M-15	ILR1	G-32
IBK100T	W-2	IG15CR	A-20,M-16	IG5262OSA	M-11	ILR2	G-32
IBN100	W-2	IG15CRAL	A-20,M-16	IG5262OWSA	M-11	ILR3	G-32
IBN100C	W-2	IG15CRGRY	A-20,M-16	IG5262R	A-12,M-15	ILR4	G-32
IBN100T	W-2	IG15CRI	A-20,M-16	IG5262RWR	A-12,M-15	ILR5	G-32
IEI100	W-2	IG15CRLA	A-20,M-16	IG5262SA	M-11	IM1IA15AL	R-46
IEI100C	W-2	IG15CRWHI	A-20,M-16	IG5262WR	A-12,M-15	IM1IA15BK	W-9
IEI100T	W-2	IG15DR	A-20,M-16	IG5262WSA	M-11	IM1IA15EI	W-9,R-46
IFP11AL	W-5	IG15DRAL	A-20,M-16	IG5352	A-17,M-16	IM1IA15GY	W-9
IFP11BK	W-5	IG15DRGRY	A-20,M-16	IG5352AL	A-17,M-16	IM1IA15OW	W-9
IFP11EI	W-5	IG15DRI	A-20,M-16	IG5352GY	A-17,M-16	IM1IA15W	W-9
IFP11GY	W-5	IG15DRLA	A-20,M-16	IG5352I	A-17,M-16	IM1K1AL	W-9,R-46
IFP11LA	W-5	IG15DRWHI	A-20,M-16	IG5352ITR	A-17,M-16	IM1K1BK	W-9
IFP11OW	W-5	IG20CR	A-20,M-16	IG5352LA	A-17,M-16	IM1K1EI	W-9
IFP11W	W-5	IG20CRAL	A-20,M-16	IG5352TR	A-17,M-16	IM1K1GY	W-9,R-46
IFP126AL	R-45,W-5	IG20CRGRY	A-20,M-16	IG5352W	A-17,M-16	IM1K1OW	W-9
IFP126OW	R-63,W-5	IG20CRI	A-20,M-16	IG5352WTR	A-17,M-16	IM1K1W	W-9
IFP12AL	R-45,W-5	IG20CRLA	A-20,M-16	IG5361	A-12,M-15	IM1KA15AL	W-9,R-46
IFP12BK	W-5	IG20CRWHI	A-20,M-16	IG5361WR	A-12,M-15	IM1KA15BK	W-9
IFP12EI	W-5	IG20DR	A-20,M-16	IG5362	A-12,M-15	IM1KA15EI	W-9
IFP12GY	R-45,W-5	IG20DRAL	A-20,M-16	IG5362GY	A-12,M-15	IM1KA15GY	W-9,R-46
IFP12LA	W-5	IG20DRGRY	A-20,M-16	IG5362GYSA	M-11	IM1KA15OW	W-9
IFP12OW	R-63,W-5	IG20DRI	A-20,M-16	IG5362GYWR	A-12,M-15	IM1KA15W	W-9
IFP12W	W-5	IG20DRLA	A-20,M-16	IG5362I	A-12,M-15	IM1SCA15AL	R-46
IFP13AL	R-45,W-5	IG20DRWHI	A-20,M-16	IG5362ISA	M-11	IM1SCA15BK	W-9
IFP13BK	W-5	IG2152	A-13,M-15	IG5362IWR	A-12,M-15	IM1SCA15EI	W-9
IFP13EI	W-5	IG2162	A-13,M-15	IG5362OSA	M-11	IM1SCA15GY	W-9,R-46
IFP13GY	R-45,W-5	IG2162GY	A-13,M-15	IG5362OWSA	M-11	IM1SCA15OW	W-9
IFP13LA	W-5	IG2182	A-3,L-3,M-15	IG5362R	A-12,M-15	IM1SCA15W	W-9
IFP13OW	R-63,W-5	IG2182I	A-3,L-3,M-15	IG5362RWR	A-12,M-15	IM2IA15AL	R-46
IFP13W	W-5	IG2182WA	A-3,L-3,M-15	IG5362SA	M-11	IM2IA15BK	W-9
IFP14AL	R-45,W-5	IG2310	B-19,M-18	IG5362W	A-12,M-15	IM2IA15EI	W-9
IFP14BK	W-5	IG2320	B-19,M-18	IG5362WR	A-12,M-15	IM2IA15GY	W-9,R-46
IFP14EI	W-5	IG2340	B-22,M-18	IG5362WSA	M-11	IM2IA15OW	W-9
IFP14GY	R-45,W-5	IG2410	B-21,M-18	IG5362WWR	A-12,M-15	IM2IA15W	W-9
IFP14LA	W-5	IG2420	B-21,M-18	IG5461	A-31,M-16	IM2K1AL	W-9,R-46
IFP14OW	R-63,W-5	IG2510	B-25,M-18	IG5462	A-31,M-16	IM2K1BK	W-9
IFP14W	W-5	IG2610	B-27,M-18	IG5661	A-31,M-16	IM2K1EI	W-9
IFP16AL	R-45,W-5	IG2620	B-27,M-18	IG5662	A-31,M-16	IM2K1GY	W-9,R-46
IFP16BK	W-5	IG2710	B-29,M-18	IG8200	A-3,L-3,M-15	IM2K1OW	W-9
IFP16EI	W-5	IG2720	B-29,M-18	IG8200R	A-3,L-3,M-15	IM2K1W	W-9
IFP16GY	R-45,W-5	IG2810	B-33,M-18	IG8210	A-8,L-8,M-15	IM2KA15AL	W-9,R-46
IFP16LA	W-5	IG415	A-23,M-15	IG8262GYSA	L-16,M-11	IM2KA15BK	W-9
IFP16OW	R-63,W-5	IG420	A-23,M-15	IG8262ISA	L-16,M-11	IM2KA15EI	W-9
IFP16W	W-5	IG4550A	B-11,M-18	IG8262OSA	L-16,M-11	IM2KA15GY	W-9,R-46
IFP18AL	R-45,W-5	IG4560	B-11,M-18	IG8262RSA	L-16,M-11	IM2KA15OW	W-9
IFP18OW	R-63,W-5	IG4700A	B-11,J-4,M-18	IG8262SA	L-16,M-11	IM2KA15W	W-9
IFP212BK	W-5	IG4710	B-11,M-18	IG8262WSA	L-16,M-11	IM2SCA2AL	R-46
IFP212EI	W-5	IG5252	A-17,M-16	IG8300	A-3,L-3,M-15	IM2SCA2BK	W-9
IFP212GY	W-5	IG5252AL	A-17,M-16	IG8300R	A-3,L-3,M-15	IM2SCA2EI	W-9
IFP212LA	W-5	IG5252GY	A-17,M-16	IG8310	A-8,L-8,M-15	IM2SCA2GY	W-9,R-46



# Catalog Number Index

Catalog Number	Page	Catalog Number	Page	Catalog Number	Page	Catalog Number	Page
IM2SCA2OW	W-9	IMCRS1OW	W-8	IN330FS1	G-30,G-31	IN560EFS	G-7
IM2SCA2W	W-9	IMCRS1W	W-8	IN330FS2	G-30,G-31	IN560EM	G-7
IM3RF1AL	W-8	IMF1AL	W-9,R-46	IN330MS1	G-30,G-31	IN560EMS	G-7
IM3RF1BK	W-8	IMF1BK	W-9	IN330MS2	G-30,G-31	IN560FS1	G-30,G-31
IM3RF1EI	W-8	IMF1EI	W-9	IN360AF	G-7	IN560MS1	G-30,G-31
IM3RF1GY	W-8	IMF1GY	W-9,R-46	IN360AM	G-7	IOR100	W-2
IM3RF1OW	W-8	IMF1OW	W-9,R-63	IN360BF	G-7	IOR100C	W-2
IM3RF1W	W-8	IMF1W	W-9,W-14,O-38	IN360BFS	G-7	IOR100T	W-2
IM3RS1AL	W-8	IMF2AL	W-9,R-46	IN360BM	G-7	IP100	W-2
IM3RS1BK	W-8	IMF2BK	W-9	IN360BMS	G-7	IP100C	W-2
IM3RS1EI	W-8	IMF2EI	W-9	IN360FS1	G-30,G-31	IP100T	W-2
IM3RS1GY	W-8	IMF2GY	W-9,R-46	IN360FS2	G-30,G-31	IR100	W-2
IM3RS1OW	W-8	IMF2OW	W-9,R-63	IN360MS1	G-30,G-31	IR100C	W-2
IM3RS1W	W-8	IMF2W	W-9	IN360MS2	G-30,G-31	IR100T	W-2
IMAR1101AL	W-7	IMR1101AL	W-7	IN4100CF	G-7	ISB12EI	W-10
IMAR1101BK	W-7	IMR1101BK	W-7	IN4100CM	G-7	ISB12OW	W-10
IMAR1101EI	W-7	IMR1101EI	W-7	IN4100DF	G-7	ISB12W	W-10
IMAR1101GY	W-7	IMR1101GY	W-7	IN4100DFS	G-7	ISB1EI	W-10,W-26
IMAR1101OW	W-7	IMR1101OW	W-7	IN4100DM	G-7	ISB1OW	W-10
IMAR1101W	W-7	IMR1101W	W-7	IN4100DMS	G-7	ISB1W	W-10,W-26
IMAVB15XX	W-9	IMRSJ1AL	W-8	IN4100FS1	G-30,G-31	ISB2EI	W-10,W-26
IMB05AL	W-9,R-46	IMRSJ1BK	W-8	IN4100FS2	G-30,G-31	ISB2OW	W-10
IMB05BK	W-9	IMRSJ1EI	W-8	IN4100MS1	G-30,G-31	ISB2W	W-10,W-26
IMB05EI	W-9	IMRSJ1GY	W-8	IN4100MS2	G-30,G-31	ISB4EI	W-10
IMB05GY	W-9,R-46	IMRSJ1OW	W-8	IN4200FS1	G-30,G-31	ISB4OW	W-10
IMB05OW	W-9	IMRSJ1W	W-8	IN4200FS2	G-30,G-31	ISB4W	W-10
IMB05W	W-9	IMSP1AL	W-8	IN4200MS1	G-30,G-31	ISB6EI	W-10
IMB15AL	W-9,R-46	IMSP1BK	W-8	IN4200MS2	G-30,G-31	ISB6OW	W-10
IMB15BK	W-9	IMSP1EI	W-8	IN420CF	G-6	ISB6W	W-10
IMB15EI	W-9	IMSP1GY	W-8	IN420CM	G-6	ISF2AL	W-6,R-45
IMB15GY	W-9,R-46	IMSP1OW	W-8	IN420DF	G-6	ISF2BK	W-6
IMB15OW	W-9	IMSP1W	W-8	IN420DM	G-6	ISF2EI	W-6
IMB15W	W-9	IMSR1101AL	W-7	IN430CF	G-6	ISF2GY	W-6,R-45
IMB1AL	W-9,R-46	IMSR1101BK	W-7	IN430CM	G-6	ISF2OW	W-6,R-63
IMB1BK	W-9	IMSR1101EI	W-7	IN430DF	G-6	ISF2W	W-6
IMB1EI	W-9	IMSR1101GY	W-7	IN430DM	G-6	ISF3AL	W-6,R-45
IMB1GY	W-9,R-46	IMSR1101OW	W-7	IN430FS1	G-30,G-31	ISF3BK	W-6
IMB1OW	W-9	IMSR1101W	W-7	IN430FS2	G-30,G-31	ISF3EI	W-6
IMB1W	W-9	IMSV351101AL	W-7	IN430MS1	G-30,G-31	ISF3GY	W-6,R-45
IMBDS1XX	W-9	IMSV351101BK	W-7	IN430MS2	G-30,G-31	ISF3OW	W-6,R-63
IMBDSA15XX	W-9	IMSV351101EI	W-7	IN460CF	G-7	ISF3W	W-6
IMBDVI1015XX	W-9	IMSV351101GY	W-7	IN460CM	G-7	ISF4AL	W-6,R-45
IMBDVI15XX	W-9	IMSV351101OW	W-7	IN460DF	G-7	ISF4BK	W-6
IMCR1101AL	W-7	IMSV351101W	W-7	IN460DFS	G-7	ISF4EI	W-6
IMCR1101BK	W-7	IN16494	L-18	IN460DM	G-7	ISF4GY	W-6,R-45
IMCR1101EI	W-7	IN3100AF	G-7	IN460DMS	G-7	ISF4OW	W-6,R-63
IMCR1101GY	W-7	IN3100AM	G-7	IN460FS1	G-30,G-31	ISF4W	W-6
IMCR1101OW	W-7	IN3100BF	G-7	IN460FS2	G-30,G-31	ISF6AL	W-6,R-45
IMCR1101W	W-7	IN3100BFS	G-7	IN460MS1	G-30,G-31	ISF6BK	W-6
IMCRF1AL	W-8	IN3100BM	G-7	IN460MS2	G-30,G-31	ISF6EI	W-6
IMCRF1BK	W-8	IN3100BMS	G-7	IN5100EF	G-7	ISF6GY	W-6,R-45
IMCRF1EI	W-8	IN3100FS1	G-30,G-31	IN5100EFS	G-7	ISF6OW	W-6,R-63
IMCRF1GY	W-8	IN3100FS2	G-30,G-31	IN5100EM	G-7	ISF6W	W-6
IMCRF1OW	W-8	IN3100MS1	G-30,G-31	IN5100EMS	G-7	ISFB15AL	W-6
IMCRF1W	W-8	IN3100MS2	G-30,G-31	IN5100FS1	G-30,G-31	ISFB15BK	W-6
IMCRS15AL	W-8	IN3200FS2	G-30,G-31	IN5100MS1	G-30,G-31	ISFB15EI	W-6
IMCRS15BK	W-8	IN3200MS2	G-30,G-31	IN5200FS1	G-30,G-31	ISFB15GY	W-6
IMCRS15EI	W-8	IN320AF	G-6	IN5200MS1	G-30,G-31	ISFB15LA	W-6
IMCRS15GY	W-8	IN320AM	G-6	IN520EF	G-6	ISFB15OW	W-6
IMCRS15OW	W-8	IN320BF	G-6	IN520EM	G-6	ISFB15W	W-6
IMCRS15W	W-8	IN320BM	G-6	IN530EF	G-6	ISFB215BK	W-6
IMCRS1AL	W-8	IN330AF	G-6	IN530EM	G-6	ISFB215EI	W-6
IMCRS1BK	W-8	IN330AM	G-6	IN530FS1	G-30,G-31	ISFB215GY	W-6
IMCRS1EI	W-8	IN330BF	G-6	IN530MS1	G-30,G-31	ISFB215OW	W-6
IMCRS1GY	W-8	IN330BM	G-6	IN560EF	G-7	ISFB215W	W-6

# Catalog Number Index

Catalog Number	Page	Catalog Number	Page	Catalog Number	Page	Catalog Number	Page
ISFBR15BK	W-6	LCFBCALC	O-16	M005SGGF0	I-6	MBMS13350	I-21
ISFBR15EI	W-6	LCFBCALT	O-16	M005SGGFP	I-6	MBMS14314	I-21
ISFBR15GY	W-6	LCFBCALTC	O-16	M11LRGSP	Y-33	MBMS14350	I-21
ISFBR15OW	W-6	LCFBCBKA	O-16	M11LRSP	Y-33	MBMS15314	I-21
ISFBR15W	W-6	LCFBCBKC	O-16	M11LTR	Y-33	MBMS15350	I-21
ISM1EI	W-26	LCFBCBKT	O-16	M11LTRM	Y-33	MBMS22325	I-25
ISM1W	W-26	LCFBCBKTC	O-16	M11MSP	Y-33	MBMS22350	I-25
ISM2EI	W-26	LCFBCBRA	O-16	M11SP	Y-33	MBMS23325	I-25
ISM2W	W-26	LCFBCBRSC	O-16	M123LTR	Y-33	MBMS23350	I-25
IW100	W-2	LCFBCBRST	O-16	M123MMSP	Y-33	MBMS24325	I-25
IW100C	W-2	LCFBCBRSTC	O-16	M123MSP	Y-33	MBMS24350	I-25
IW100T	W-2	LCFBCGYA	O-16	M123SP	Y-33	MBMS25325	I-25
IY100	W-2	LCFBCGYC	O-16	M21SP	Y-33	MBMS25350	I-25
IY100C	W-2	LCFBCGYT	O-16	M223JSP	Y-33	MBMS26325	I-25
IY100T	W-2	LCFBCGYTC	O-16	M223MMSP	Y-33	MBMS26350	I-25
KP1	R-63	LCFBCIA	O-16	M223SP	Y-33	MCMA131	I-19
KP14	R-63	LCFBIM	O-16	M3R002SG000	I-5	MCMA1312	I-19
KP14AL	R-45	LCFBP14	O-16	M3R002SG00P	I-5	MCMA1314	I-19
KP14GY	R-45	LCFBP26	O-16	M3R002SGGF0	I-5	MCMA1315	I-19
KP1AL	R-45	LCFBP720	O-16	M3R002SGGFP	I-5	MCMA131DC	I-28
KP1GY	A-44,I-41,R-45	LCFBP8	O-16	M3RSL1SG000	I-5	MCMA141	I-19
KP2	R-63	LCFBS1R8ADAPT	O-17	M3RSL1SG00P	I-5	MCMA1412	I-19
KP212	R-63	LCFBSSA	O-16	M3RSL1SGGF0	I-5	MCMA1414	I-19
KP212AL	R-45	LN12BPK100	V-83	M3RSL1SGGFP	I-5	MCMA1415	I-19
KP212GY	R-45	LN16BPK100	V-83	M4100B12R	G-8,Y-18	MCMA14F7	I-27
KP2140	R-63	LN20BPK100	V-83	M4100C12	G-8,Y-19	MCMA14F9	I-27
KP2140AL	R-45	LN25BPK100	V-83	M4100C12R	G-8,G-31,Y-18	MCMA14IDC	I-28
KP2140GY	R-45	LN32BPK100	V-83	M4100P12	G-8,Y-19	MCMA151	I-19
KP2162	R-63	LN40BPK100	V-83	M4100R12	G-8,Y-19	MCMA1512	I-19
KP2162AL	R-45	LNP11BPK100	V-83	M4L2003PB0	I-5	MCMA1514	I-19
KP2162GY	R-45	LNP13BPK100	V-83	M4L2003PBP	I-5	MCMA1515	I-19
KP2163	R-63	LNP16BPK100	V-83	M5100B7R	G-8,Y-20	MCMA15F7	I-27
KP2163AL	R-45	LNP21BPK100	V-83	M5100B9R	G-8,Y-20	MCMA15F9	I-27
KP2163GY	R-45	LNP29BPK25	V-83	M5100C7	G-8,Y-21	MCMA221	I-23
KP24	R-63	LNP36BPK25	V-83	M5100C7R	G-8,Y-20	MCMA2212	I-23
KP26	R-63	LNP7BPK100	V-83	M5100C9	G-8,Y-21	MCMA2214	I-23
KP262	R-63	LNP9BPK100	V-83	M5100C9R	G-8,Y-20	MCMA2215	I-23
KP26AL	R-45	LR100	G-11,Y-18,Y-20	M5100P7	G-8,Y-21	MCMA231	I-23
KP26GY	A-44,I-41,R-45	LR320	G-11	M5100P9	G-8,Y-21	MCMA2312	I-23
KP7	R-63	LR3430	G-11	M5100R7	G-8,Y-21	MCMA2314	I-23
KP720	R-63	LR420	G-11	M5100R9	G-8,Y-21	MCMA2315	I-23
KP720AL	R-45	LR520	G-11	M5200BS1R	G-31,Y-22	MCMA23F7	I-27
KP720GY	A-44,I-41,R-45	LR530	G-11	M5200CS1	G-30,Y-23	MCMA23F9	I-27
KP7AL	R-45	LR60	G-11	M5200CS1R	G-31,Y-22	MCMA241	I-23
KP7GY	A-44,I-41,R-45	LVPR1500R	E-7	M5200PS1	G-30,Y-23	MCMA2412	I-23
KP8	R-63	M001L1000	I-6	M5200RS1	G-30,Y-23	MCMA2414	I-23
KP82	R-63	M001L100P	I-6	MB2003W	G-30,G-31,Y-23	MCMA2415	I-23
KP8AL	R-45	M001SG000	I-6	MB2004W	G-30,G-31,Y-23	MCMA251	I-23
KP8GY	A-44,I-41,R-45	M001SG00P	I-6	MB301W	G-32	MCMA2512	I-23
KPIMBZAL	W-9,R-45	M001SGGF0	I-6	MB302W	G-32	MCMA2514	I-23
KPIMBZGY	W-9,R-45	M001SGGFP	I-6	MB303W	G-32	MCMA2515	I-23
KPIMBZOW	W-9,R-63	M002SG000	I-6	MB304W	G-32	MCMA261	I-23
KPORTAL	R-45	M002SG00P	I-6	MB601002W	G-32	MCMA2612	I-23
KPORTGY	R-45	M002SGGF0	I-6	MB601003W	G-32	MCMA2614	I-23
KPORTOW	R-63	M002SGGFP	I-6	MB601004W	G-32	MCMA2615	I-23
KPPANAL	R-45	M003SG000	I-6	MB601006W	G-32	MCMS131	I-19
KPPANGY	R-45	M003SG00P	I-6	MB601007W	G-32	MCMS1312	I-19
KPPANOW	R-63	M003SGGF0	I-6	MB601008W	G-32	MCMS1314	I-19
L420P9	G-24	M003SGGFP	I-6	MB601W	G-32	MCMS1315	I-19
L420R9	G-24	M004SG000	I-6	MB602W	G-32	MCMS131DC	I-28
L430P12	G-24	M004SG00P	I-6	MB603W	G-32	MCMS131DCL	I-28
L430P9	G-24	M004SGGF0	I-6	MB604W	G-32	MCMS141	I-19
L430R12	G-24	M004SGGFP	I-6	MB605W	G-32	MCMS1412	I-19
L430R9	G-24	M005SG000	I-6	MB606W	G-32	MCMS1414	I-19
LCFBCA	O-16	M005SG00P	I-6	MBMS13314	I-21	MCMS1415	I-19

# Catalog Number Index

Catalog Number	Page	Catalog Number	Page	Catalog Number	Page	Catalog Number	Page
MCMS14F7	I-27	MEMS241	I-23	MIMS2415	I-23	MR223SP	Y-33
MCMS14F9	I-27	MEMS2412	I-23	MIMS251	I-23	MRCM1	I-20, I-22
MCMS14IDC	I-28	MEMS2414	I-23	MIMS2512	I-23	MRCM2	I-24, I-26
MCMS14IDCL	I-28	MEMS2415	I-23	MIMS2514	I-23	MRMS22325	I-25
MCMS151	I-19	MEMS251	I-23	MIMS2515	I-23	MRMS22350	I-25
MCMS1512	I-19	MEMS2512	I-23	MIMS261	I-23	MRMS23325	I-25
MCMS1514	I-19	MEMS2514	I-23	MIMS2612	I-23	MRMS23350	I-25
MCMS1515	I-19	MEMS2515	I-23	MIMS2614	I-23	MRMS24325	I-25
MCMS15F7	I-27	MEMS261	I-23	MIMS2615	I-23	MRMS24350	I-25
MCMS15F9	I-27	MEMS2612	I-23	MLWF2010	I-5	MRMS25325	I-25
MCMS221	I-23	MEMS2614	I-23	MLWF201P	I-5	MRMS25350	I-25
MCMS2212	I-23	MEMS2615	I-23	MLWF2020	I-5	MRMS26325	I-25
MCMS2214	I-23	MFMS13325	I-21	MLWF202P	I-5	MRMS26350	I-25
MCMS2215	I-23	MFMS14325	I-21	MPCM1	I-20, I-22	MS2	F-24
MCMS231	I-23	MFMS15325	I-21	MPCM2	I-24, I-26	MS5	F-24
MCMS2312	I-23	MFMS22325	I-25	MPMA221	I-23	MSB1	Y-33
MCMS2314	I-23	MFMS23325	I-25	MPMA2212	I-23	NBCS3D	I-30
MCMS2315	I-23	MFMS24325	I-25	MPMA2214	I-23	NBCS4D	I-30
MCMS23F7	I-27	MFMS25325	I-25	MPMA2215	I-23	NCSA31	I-30
MCMS23F9	I-27	MFMS26325	I-25	MPMA231	I-23	NCSA3102	I-30
MCMS241	I-23	MH11	Y-33	MPMA2312	I-23	NCSA3105	I-30
MCMS2412	I-23	MHB11	Y-33	MPMA2314	I-23	NCSA41	I-30
MCMS2414	I-23	MICPK30	F-12, G-18, G-21	MPMA2315	I-23	NCSA4102	I-30
MCMS2415	I-23	MICPK60	F-12, G-18, G-21	MPMA241	I-23	NCSA4105	I-30
MCMS251	I-23	MIMA13IDC	I-28	MPMA2412	I-23	NCSS31	I-30
MCMS2512	I-23	MIMA14F7	I-27	MPMA2414	I-23	NCSS3102	I-30
MCMS2514	I-23	MIMA14F9	I-27	MPMA2415	I-23	NCSS3105	I-30
MCMS2515	I-23	MIMA14IDC	I-28	MPMA251	I-23	NCSS41	I-30
MCMS261	I-23	MIMA15F7	I-27	MPMA2512	I-23	NCSS4102	I-30
MCMS2612	I-23	MIMA15F9	I-27	MPMA2514	I-23	NCSS4105	I-30
MCMS2614	I-23	MIMA23F7	I-27	MPMA2515	I-23	NCTA31	I-30
MCMS2615	I-23	MIMA23F9	I-27	MPMA261	I-23	NCTA3102	I-30
MCWF2010	I-5	MIMS131	I-19	MPMA2612	I-23	NCTA3105	I-30
MCWF2020	I-5	MIMS1312	I-19	MPMA2614	I-23	NCTA41	I-30
MCWF2030	I-5	MIMS1314	I-19	MPMA2615	I-23	NCTA4102	I-30
MCWF2040	I-5	MIMS1315	I-19	MPMS221	I-23	NCTA4105	I-30
MCWF2050	I-5	MIMS131DC	I-28	MPMS2212	I-23	NCTS13IDC	I-32
MCWF2060	I-5	MIMS131DCL	I-28	MPMS2214	I-23	NCTS14IDC	I-32
MCWF2070	I-5	MIMS141	I-19	MPMS2215	I-23	NCTS31	I-30
MCWF2080	I-5	MIMS1412	I-19	MPMS231	I-23	NCTS3102	I-30
MCWF2090	I-5	MIMS1414	I-19	MPMS2312	I-23	NCTS3105	I-30
MCWF2100	I-5	MIMS1415	I-19	MPMS2314	I-23	NCTS41	I-30
MCWF2110	I-5	MIMS14F7	I-27	MPMS2315	I-23	NCTS4102	I-30
MCWF2120	I-5	MIMS14F9	I-27	MPMS241	I-23	NCTS4105	I-30
MCWF2130	I-5	MIMS14IDC	I-28	MPMS2412	I-23	NHC1010	V-81
MEMS131	I-19	MIMS14IDCL	I-28	MPMS2414	I-23	NHC1011	V-81
MEMS1312	I-19	MIMS151	I-19	MPMS2415	I-23	NHC1012	V-81
MEMS1314	I-19	MIMS1512	I-19	MPMS251	I-23	NHC1020	V-81
MEMS1315	I-19	MIMS1514	I-19	MPMS2512	I-23	NHC1020CR	V-81
MEMS141	I-19	MIMS1515	I-19	MPMS2514	I-23	NHC1021	V-81
MEMS1412	I-19	MIMS15F7	I-27	MPMS2515	I-23	NHC1021CR	V-81
MEMS1414	I-19	MIMS15F9	I-27	MPMS261	I-23	NHC1021ZP	V-81
MEMS1415	I-19	MIMS221	I-23	MPMS2612	I-23	NHC1022	V-81
MEMS151	I-19	MIMS2212	I-23	MPMS2614	I-23	NHC1022CR	V-81
MEMS1512	I-19	MIMS2214	I-23	MPMS2615	I-23	NHC1022ZP	V-81
MEMS1514	I-19	MIMS2215	I-23	MR11LRSP	Y-33	NHC1023	V-81
MEMS1515	I-19	MIMS231	I-23	MR11MSP	Y-33	NHC1023CR	V-81
MEMS221	I-23	MIMS2312	I-23	MR11SP	Y-33	NHC1023ZP	V-81
MEMS2212	I-23	MIMS2314	I-23	MR123LRSP	Y-33	NHC1024	V-81
MEMS2214	I-23	MIMS2315	I-23	MR123MMSP	Y-33	NHC1024CR	V-81
MEMS2215	I-23	MIMS23F7	I-27	MR123MSP	Y-33	NHC1024ZP	V-81
MEMS231	I-23	MIMS23F9	I-27	MR123SP	Y-33	NHC1035	V-81
MEMS2312	I-23	MIMS241	I-23	MR21SP	Y-33	NHC1035CR	V-81
MEMS2314	I-23	MIMS2412	I-23	MR223LRSP	Y-33	NHC1035ZP	V-81
MEMS2315	I-23	MIMS2414	I-23	MR223MMSP	Y-33	NHC1036	V-81

# Catalog Number Index

Catalog Number	Page	Catalog Number	Page	Catalog Number	Page	Catalog Number	Page
NHC1036CR	V-81	NP1262	N-13,X-7	NP18AL	N-11	NP263R	D-15,N-10
NHC1036ZP	V-81	NP1262BK	N-13,X-7	NP18BK	N-11,Y-42	NP263W	D-15,N-10,X-6
NHC1037	V-81	NP1262GY	N-13,X-7	NP18GY	N-11,Y-42	NP264	N-10,X-6
NHC1037CR	V-81	NP1262I	N-13,X-7	NP18I	N-11,Y-42	NP264AL	N-10
NHC1037ZP	V-81	NP1262LA	N-13,X-7	NP18LA	N-11	NP264BK	N-10,X-6
NHC1038	V-81	NP1262W	N-13,X-7	NP18OW	N-11	NP264GY	N-10,X-6
NHC1038CR	V-81	NP126AL	N-11	NP18R	N-11	NP264I	N-10,X-6
NHC1038ZP	V-81	NP126BK	N-11,X-7,Y-42	NP18W	N-11,Y-42	NP264LA	N-10,X-6
NHC1040	V-81	NP126GY	N-11,X-7,Y-42	NP1AL	D-15,N-5	NP264OW	N-10
NHC1041	V-81	NP126I	N-11,X-7,Y-42	NP1BK	D-15,N-5,Y-42	NP264W	N-10,X-6
NHC1041CR	V-81	NP126LA	N-11,X-7	NP1GY	D-15,N-5,Y-42	NP265	N-10,X-6
NHC1041ZP	V-81	NP126W	N-11,X-7,Y-42	NP1I	D-15,N-5,Y-42	NP265BK	N-10,X-6
NHC1042	V-81	NP128	N-11	NP1LA	D-15,N-5	NP265GY	N-10,X-6
NHC1042CR	V-81	NP128BK	N-11	NP1OW	D-15,N-5	NP265I	N-10,X-6
NHC1043	V-81	NP128GY	N-11	NP1R	D-15,N-5	NP265LA	N-10,X-6
NHC1043CR	V-81	NP128I	N-11	NP1W	D-15,N-5,Y-42	NP265W	N-10,X-6
NHC1044	V-81	NP128W	N-11	NP2	D-15,N-5,Y-42	NP266	N-10,X-6
NHC1051	V-81	NP12AL	N-15	NP21	N-15	NP266BK	N-10,X-6
NHC1052	V-81	NP12BK	N-15	NP21BK	N-15	NP266GY	N-10,X-6
NHC1053	V-81	NP12GY	N-15	NP21GY	N-15	NP266I	N-10,X-6
NHC1054	V-81	NP12I	N-15	NP21I	N-15	NP266LA	N-10,X-6
NHC1057	V-81	NP12W	N-15	NP21W	N-15	NP266W	N-10,X-6
NHC1059	V-81	NP13	N-8,Y-42	NP226	N-13,X-7	NP26AL	A-46,D-15,N-10,W-5
NHC1066	V-81	NP1326	N-12,X-7	NP2262	N-14,X-7	NP26BK	A-46,D-15,N-10,X-6
NHC2022CR	V-81	NP1326BK	N-12,X-7	NP2262BK	N-14,X-7	NP26GY	A-46,D-15,N-10,X-6
NHC2023CR	V-81	NP1326GY	N-12,X-7	NP2262GY	N-14,X-7	NP26I	A-46,D-15,N-10,X-6
NHC2024CR	V-81	NP1326I	N-12,X-7	NP2262I	N-14,X-7	NP26LA	A-46,D-15,N-10,X-6
NHC2041CR	V-81	NP1326LA	N-12,X-7	NP2262LA	N-14,X-7	NP26OIG	N-18
NHC2042CR	V-81	NP1326W	N-12,X-7	NP2262W	N-14,X-7	NP26OW	A-46,D-15,N-10
NHC2043CR	V-81	NP138	N-12	NP226BK	N-13,X-7	NP26R	A-46,D-15,N-10
NITS13IDC	I-32	NP138BK	N-12	NP226GY	N-13,X-7	NP26W	A-46,D-15,N-10,X-6
NITS14IDC	I-32	NP138GY	N-12	NP226I	N-13,X-7	NP28	N-13
NP1	D-15,N-5,Y-42	NP138I	N-12	NP226LA	N-13,X-7	NP28GY	N-13
NP11	N-15	NP138LA	N-12	NP226W	N-13,X-7	NP28I	N-13
NP112	N-11	NP138W	N-12	NP23	N-8	NP28LA	N-13
NP112BK	N-11	NP13AL	N-8	NP23AL	N-8	NP28W	N-13
NP112GY	N-11	NP13BK	N-8,Y-42	NP23BK	N-8	NP2AL	D-15,N-5
NP112I	N-11	NP13GY	N-8,Y-42	NP23GY	N-8	NP2BK	D-15,N-5,Y-42
NP112OW	N-11	NP13I	N-8,Y-42	NP23I	N-8	NP2GY	D-15,N-5,Y-42
NP112W	N-11	NP13LA	N-8	NP23LA	N-8	NP2I	D-15,N-5,Y-42
NP113	N-12	NP13OW	N-8	NP23W	N-8	NP2LA	D-15,N-5
NP113BK	N-12	NP13W	N-8,Y-42	NP24	N-8	NP2OW	D-15,N-5
NP113GY	N-12	NP14	N-8	NP24BK	N-8	NP2R	D-15,N-5
NP113I	N-12	NP147	N-12	NP24GY	N-8	NP2W	D-15,N-5,Y-42
NP113LA	N-12	NP147BK	N-12	NP24I	N-8	NP3	D-15,N-5
NP113W	N-12	NP147GY	N-12	NP24OW	N-8	NP326	N-14,X-7
NP11AL	N-15	NP147I	N-12	NP24R	N-8	NP326BK	N-14,X-7
NP11BK	N-15	NP147W	N-12	NP24W	N-8	NP326GY	N-14,X-7
NP11GY	N-15	NP14BK	N-8	NP26	A-46,D-15,N-10,X-6	NP326I	N-14,X-7
NP11I	N-15	NP14GY	N-8	NP262	D-15,N-10,X-6,Y-42	NP326LA	N-14,X-7
NP11LA	N-15	NP14I	N-8	NP262AL	D-15,N-10,W-5	NP326W	N-14,X-7
NP11R	N-15	NP14OW	N-8	NP262BK	D-15,N-10,W-5,X-6	NP33	N-8
NP11W	N-15	NP14R	N-8	NP262GY	D-15,N-10,W-5,X-6	NP33I	N-8
NP12	N-15	NP14W	N-8,W-14	NP262I	D-15,N-10,W-5,X-6	NP33W	N-8
NP1214	N-12	NP17	N-12	NP262LA	D-15,N-10,W-5,X-6	NP34	N-8
NP1214BK	N-12	NP17BK	N-12	NP262OW	D-15,N-10	NP34I	N-8
NP1214GY	N-12	NP17GY	N-12	NP262R	D-15,N-10	NP34W	N-8
NP1214I	N-12	NP17I	N-12	NP262W	D-15,N-10,W-5,X-6	NP38	N-14
NP1214W	N-12	NP17W	N-12	NP263	D-15,N-10,X-6	NP38I	N-14
NP1226	N-11	NP18	N-11,Y-42	NP263AL	D-15,N-10	NP38LA	N-14
NP1226BK	N-11	NP182	N-13	NP263BK	D-15,N-10,X-6	NP38W	N-14
NP1226GY	N-11	NP182BK	N-13	NP263GY	D-15,N-10,X-6	NP3AL	D-15,N-5
NP1226I	N-11	NP182GY	N-13	NP263I	D-15,N-10,X-6	NP3BK	D-15,N-5
NP1226W	N-11	NP182I	N-13	NP263LA	D-15,N-10,X-6	NP3GY	D-15,N-5
NP126	N-11,X-7,Y-42	NP182W	N-13	NP263OW	D-15,N-10	NP3I	D-15,N-5

# Catalog Number Index

Catalog Number	Page	Catalog Number	Page	Catalog Number	Page	Catalog Number	Page
NP3LA	D-15,N-5	NP71	A-46,B-48,N-6,Y-42	NPJ13BK	N-8,Y-42	NPJ26BL	N-10
NP3OW	D-15,N-5	NP7LA	A-46,N-6	NPJ13GY	N-8,Y-42	NPJ26C	N-18
NP3W	D-15,N-5	NP7OIG	N-18	NPJ13I	N-8,Y-42	NPJ26CBL	N-18
NP4	N-5	NP7OW	A-46,N-6,Y-42	NPJ13LA	N-8	NPJ26GY	N-10,X-6,Y-42
NP43	N-8	NP7R	A-46,N-6	NPJ13OW	N-8	NPJ26I	N-10,X-6,Y-42
NP43I	N-8	NP7W	A-46,N-6,Y-42	NPJ13W	N-8,Y-42	NPJ26LA	N-10,X-6
NP43W	N-8	NP8	A-46,B-48,N-6,Y-42	NPJ18	N-11,Y-42	NPJ26OW	N-10
NP44	N-8	NP82	N-6,Y-42	NPJ18AL	N-11	NPJ26R	N-10
NP44I	N-8	NP826	N-11,X-7	NPJ18BK	N-11,Y-42	NPJ26W	N-10,X-6,Y-42
NP44W	N-8	NP826AL	N-11	NPJ18GY	N-11,Y-42	NPJ28	N-13
NP48	N-14	NP826BK	N-11,X-7	NPJ18I	N-11,Y-42	NPJ28I	N-13
NP48I	N-14	NP826GY	N-11,X-7	NPJ18LA	N-11	NPJ28LA	N-13
NP48W	N-14	NP826I	N-11,X-7	NPJ18OW	N-11	NPJ28W	N-13
NP4BK	N-5	NP826LA	N-11,X-7	NPJ18R	N-11	NPJ2AL	N-5
NP4GY	N-5	NP826OW	N-11	NPJ18W	N-11,Y-42	NPJ2BK	N-5,Y-42
NP4I	N-5	NP826W	N-11,X-7	NPJ1AL	N-5	NPJ2GY	N-5,Y-42
NP4LA	N-5	NP82BK	N-6,Y-42	NPJ1BK	N-5,Y-42	NPJ2I	N-5,Y-42
NP4OW	N-5	NP82GY	N-6,Y-42	NPJ1GY	N-5,Y-42	NPJ2LA	N-5
NP4W	N-5	NP82I	N-6,Y-42	NPJ1I	N-5,Y-42	NPJ2OW	N-5
NP5	N-5	NP82OR	N-6	NPJ1LA	N-5	NPJ2R	N-5
NP5BK	N-5	NP82OW	N-6	NPJ1OW	N-5	NPJ2W	N-5,Y-42
NP5GY	N-5	NP82R	N-6	NPJ1R	N-5	NPJ3	N-5
NP5I	N-5	NP82W	N-6,Y-42	NPJ1RME	N-17	NPJ3AL	N-5
NP5LA	N-5	NP83	N-6	NPJ1W	N-5,Y-42	NPJ3BK	N-5
NP5W	N-5	NP83I	N-6	NPJ2	N-5,Y-42	NPJ3GY	N-5
NP6	N-5	NP83W	N-6	NPJ226	N-13,X-7	NPJ3I	N-5
NP6GY	N-5	NP84	N-6	NPJ226BK	N-13,X-7	NPJ3LA	N-5
NP6I	N-5	NP84I	N-6	NPJ226GY	N-13,X-7	NPJ3OW	N-5
NP6LA	N-5	NP84W	N-6	NPJ226I	N-13,X-7	NPJ3R	N-5
NP6W	N-5	NP8AL	A-46,N-6,W-5	NPJ226LA	N-13,X-7	NPJ3W	N-5
NP7	A-46,B-48,N-6,Y-42	NP8BK	A-46,N-6,W-5,Y-42	NPJ226W	N-13,X-7	NPJ4	N-5
NP703	N-7	NP8GY	A-46,N-6,W-5,Y-42	NPJ23	N-8	NPJ4BK	N-5
NP703BK	A-48,N-7	NP8I	A-46,B-48,N-6,W-5	NPJ23AL	N-8	NPJ4GY	N-5
NP703GY	N-7	NP8LA	A-46,N-6,W-5	NPJ23I	N-8	NPJ4I	N-5
NP703I	N-7,X-19	NP8OIG	N-18	NPJ23LA	N-8	NPJ4LA	N-5
NP703W	N-7,X-19	NP8OR	A-46,N-6,N-18	NPJ23W	N-8	NPJ4OW	N-5
NP720	N-7	NP8OW	A-46,N-6	NPJ26	N-10,X-6,Y-42	NPJ4W	N-5
NP720BK	B-50,B-52	NP8R	A-46,N-6	NPJ262	N-10,X-6,Y-42	NPJ7	N-6,Y-42
NP720BK	N-7	NP8W	A-46,N-6,W-5,Y-42	NPJ262AL	N-10	NPJ703	N-7
NP720GY	N-7	NPJ1	N-5,Y-42	NPJ262BK	N-10,X-6,Y-42	NPJ703BK	N-7
NP720I	N-7	NPJ11	N-15	NPJ262GY	N-10,X-6,Y-42	NPJ703GY	N-7
NP720OIG	N-18	NPJ113	N-12	NPJ262I	N-10,X-6,Y-42	NPJ703I	N-7,X-19
NP720OW	N-7	NPJ113I	N-12	NPJ262LA	N-10,X-6	NPJ703W	N-7,X-19
NP720R	N-7	NPJ11AL	N-15	NPJ262OW	N-10	NPJ724	N-7
NP720W	N-7	NPJ11I	N-15	NPJ262R	N-10	NPJ724BK	N-7
NP724	N-7	NPJ11LA	N-15	NPJ262W	N-10,X-6,Y-42	NPJ724GY	N-7
NP724BK	A-48,N-7	NPJ11W	N-15	NPJ263	N-10,X-6	NPJ724I	N-7,X-19
NP724GY	N-7	NPJ126	N-11,X-7,Y-42	NPJ263AL	N-10	NPJ724W	N-7,X-19
NP724I	N-7,X-19	NPJ126AL	N-11	NPJ263BK	N-10,X-6	NPJ7BK	N-6,Y-42
NP724W	N-7,X-19	NPJ126BK	N-11,X-7,Y-42	NPJ263GY	N-10,X-6	NPJ7GY	N-6,Y-42
NP730	N-15	NPJ126GY	N-11,X-7,Y-42	NPJ263I	N-10,X-6	NPJ7I	N-6,Y-42
NP730I	N-15	NPJ126I	N-11,X-7,Y-42	NPJ263LA	N-10,X-6	NPJ7LA	N-6
NP730W	N-15	NPJ126LA	N-11,X-7	NPJ263OW	N-10	NPJ7OW	N-6
NP737	N-15	NPJ126W	N-11,X-7,Y-42	NPJ263R	N-10	NPJ7R	N-6
NP737AL	N-15	NPJ13	N-8,Y-42	NPJ263W	N-10,X-6	NPJ7W	N-6,Y-42
NP737I	N-15	NPJ1326	N-12,X-7	NPJ264	N-10,X-6	NPJ8	N-6,Y-42
NP737W	N-15	NPJ1326BK	N-12	NPJ264AL	N-10	NPJ82	N-6,Y-42
NP78	N-11	NPJ1326GY	N-12	NPJ264BK	N-10,X-6	NPJ826	N-11,X-7
NP78AL	N-11	NPJ1326I	N-12,X-7	NPJ264GY	N-10,X-6	NPJ826AL	N-11
NP78GY	N-11	NPJ1326LA	N-12,X-7	NPJ264I	N-10,X-6	NPJ826BK	N-11,X-7
NP78I	N-11	NPJ1326W	N-12,X-7	NPJ264LA	N-10,X-6	NPJ826GY	N-11,X-7
NP78W	N-11	NPJ138	N-12	NPJ264OW	N-10	NPJ826I	N-11,X-7
NP7AL	A-46	NPJ138I	N-12	NPJ264W	N-10,X-6	NPJ826LA	N-11,X-7
NP7BK	A-46,N-6,Y-42	NPJ138W	N-12	NPJ26AL	N-10	NPJ826W	N-11,X-7
NP7GY	A-46,N-6,Y-42	NPJ13AL	N-8	NPJ26BK	N-10,X-6,Y-42	NPJ826BK	N-6,Y-42

# Catalog Number Index

Catalog Number	Page	Catalog Number	Page	Catalog Number	Page	Catalog Number	Page
NPJ82CO	N-18	NS726SS	W-26	NS784BK	W-24,X-10	NSJ6GN25	W-22,X-9
NPJ82GY	N-6,Y-42	NS730	W-25	NS784GY	W-24,X-10	NSJ6GY	W-22,X-9,Y-43
NPJ82I	N-6,Y-42	NS730I	W-25	NS784I	W-24,X-10	NSJ6GY25	W-22,X-9
NPJ82LA	N-6	NS730LA	W-25	NS784LA	W-24,X-10	NSJ6I	W-22,X-9,Y-43
NPJ82OW	N-6	NS730W	W-25	NS784W	W-24,X-10	NSJ6I25	W-22,X-9
NPJ82R	N-6	NS732	W-25	NS785	W-24,X-10	NSJ6LA	W-22,X-9
NPJ82W	N-6,Y-42	NS732I	W-25	NS785BK	W-24,X-10	NSJ6LA25	W-22,X-9
NPJ8AL	N-6	NS732LA	W-25	NS785GY	W-24,X-10	NSJ6OR	W-22,X-9
NPJ8BK	N-6,Y-42	NS732W	W-25	NS785I	W-24,X-10	NSJ6OR25	W-22,X-9
NPJ8BL	N-6	NS735	W-25	NS785LA	W-24,X-10	NSJ6R	W-22,X-9
NPJ8C	N-18	NS735I	W-25	NS785W	W-24,X-10	NSJ6R25	W-22,X-9
NPJ8CO	N-18	NS735LA	W-25	NS790	W-25	NSJ6W	W-14,W-22,X-9
NPJ8GY	N-6,Y-42	NS735W	W-25	NS790BK	W-25	NSJ6W25	W-22,X-9
NPJ8I	N-6,Y-42	NS742I	W-25	NS790GY	W-25	NSJ6Y	W-22,X-9
NPJ8LA	N-6	NS742LA	W-25	NS790I	W-25	NSJ6Y25	W-22,X-9
NPJ8OW	N-6	NS742W	W-25	NS790LA	W-25	NSJUB	W-22,X-9
NPJ8R	N-6	NS744I	W-25	NS790W	W-25	NSJUBK	W-22,X-9,Y-43
NPJ8RMEV	N-17	NS744W	W-25	NS801AL	W-6	NSJUGN	W-22,X-9
NPJ8W	N-6,Y-42	NS745I	W-25	NS801BK	W-6,W-15	NSJUGY	W-22,X-9,Y-43
NS5E12U	W-20	NS745W	W-25	NS801GY	W-6,W-15	NSJUI	W-22,X-9,Y-43
NS5E24U	W-20	NS747I	W-25	NS801I	W-6,W-15	NSJULA	W-22,X-9
NS5E48U	W-20	NS747LA	W-25	NS801LA	W-6,W-15	NSJUOR	W-22,X-9
NS612BK	W-23,X-8,Y-43	NS747W	W-25	NS801W	O-38,W-6,W-15	NSJUR	W-22,X-9
NS612GY	W-23,X-8,Y-43	NS748I	W-25	NS802AL	W-6	NSJUW	W-22,X-9,Y-43
NS612I	W-23,X-8,Y-43	NS748LA	W-25	NS802BK	W-6,W-15	NSJUY	W-22,X-9
NS612LA	W-23,X-8	NS748W	W-25	NS802GY	W-6,W-15	NSO6P1DM	W-18
NS612U	W-20	NS750I	W-25	NS802I	W-6,W-15	NSOAM8	W-19
NS612W	W-23,X-8,Y-43	NS750LA	W-25	NS802LA	W-6,W-15	NSOBM	W-19
NS613BK	W-23,X-8,Y-43	NS750W	W-25	NS802M	O-38,W-6,W-15	NSOBNK14	W-17
NS613GY	W-23,X-8,Y-43	NS751I	W-25	NSAV62M	O-38,W-14	NSOBOX14	W-17
NS613I	W-23,X-8,Y-43	NS751LA	W-25	NSAV6BW	W-14	NSOBOX14B	W-17
NS613LA	W-23,X-8	NS751W	W-25	NSAV6C	O-38,W-14	NSOBOX14BC	W-17
NS613W	W-23,X-8,Y-43	NS752I	W-25	NSAV6CB	W-14	NSOBOX14C	W-17
NS614BK	W-23,X-8	NS752LA	W-25	NSAV6NW	W-14	NSOBOX14D	W-17
NS614GY	W-23,X-8	NS752W	W-25	NSAVIMFW	W-14	NSOBOX14DL	W-17
NS614I	W-23,X-8	NS755I	W-25	NSF70BK	W-22,X-9	NSOBOX14X2	W-17
NS614LA	W-23,X-8	NS755LA	W-25	NSF70GY	W-22,X-9	NSOBOX28	W-17
NS614W	W-23,X-8	NS755W	W-25	NSF70I	W-22,X-9	NSOBOX28B	W-17
NS616BK	W-23,X-8	NS760I	W-26	NSF70LA	W-22,X-9	NSOBOX28BC	W-17
NS616GY	W-23,X-8	NS760W	W-26	NSF70W	W-14,W-22,X-9	NSOBOX28C	W-17
NS616I	W-23,X-8	NS761I	W-26	NSJ5EB	W-22,X-9	NSOBOX28D	W-17
NS616LA	W-23,X-8	NS761W	W-26	NSJ5EB25	W-22,X-9	NSOBOX28DL	W-17
NS616W	W-23,X-8	NS770	W-24,X-10	NSJ5EBK	W-22,X-9,Y-43	NSOBOX28X2	W-17
NS620AL	W-6	NS770BK	W-24,X-10	NSJ5EBK25	W-22,X-9	NSOBOX48	W-17
NS620BK	W-23,X-8	NS770GY	W-24,X-10	NSJ5EGN	W-22,X-9	NSOBX10	W-17
NS620GY	W-23,X-8	NS770I	W-24,X-10	NSJ5EGN25	W-22,X-9	NSOBX10B	W-17
NS620I	N-29,W-23,X-8	NS770LA	W-24,X-10	NSJ5EGY	W-22,X-9,Y-43	NSOBX10BC	W-17
NS620LA	N-29,W-23,X-8	NS770W	W-24,X-10	NSJ5EGY25	W-22,X-9	NSOBX10C	W-17
NS620W	N-29,W-23,X-8	NS771	W-24,X-10	NSJ5EI	W-22,X-9,Y-43	NSOBX10D	W-17
NS621AL	W-6	NS771I	W-24,X-10	NSJ5EI25	W-22,X-9	NSODK6	W-18
NS621BK	W-23,X-8	NS771LA	W-24,X-10	NSJ5ELA	W-22,X-9	NSODM8	W-18
NS621GY	W-23,X-8	NS771W	W-24,X-10	NSJ5ELA25	W-22,X-9	NSODM8C6	W-18
NS621I	N-29,W-23,X-8	NS772I	W-24,X-10	NSJ5EOR	W-22,X-9	NSOETM8	W-18
NS621LA	N-29,W-23,X-8	NS772LA	W-24,X-10	NSJ5EOR25	W-22,X-9	NSOFSB	W-21
NS621W	N-29,W-23,X-8	NS772W	W-24,X-10	NSJ5ER	W-22,X-9	NSOKA	W-21
NS624U	W-20	NS780I	W-24,X-10	NSJ5ER25	W-22,X-9	NSOKPS	W-14,W-21
NS648U	W-20	NS780LA	W-24,X-10	NSJ5EW	W-22,X-9,Y-43	NSOKPTR	W-14,W-21
NS721I	W-26	NS780W	W-24,X-10	NSJ5EW25	W-22,X-9	NSOMTM24	W-18
NS721W	W-26	NS782I	W-24,X-10	NSJ5EY	W-22,X-9	NSOPTM8	W-18
NS722I	W-26	NS782LA	W-24,X-10	NSJ5EY25	W-22,X-9	NSORAVC	W-21
NS722W	W-26	NS782W	W-24,X-10	NSJ6B	W-22,X-9	NSOSAVC	W-21
NS723SS	W-26	NS783I	W-24,X-10,Y-43	NSJ6B25	W-22,X-9	NSOTVDM6	W-18
NS725I	W-26	NS783LA	W-24,X-10	NSJ6BK	W-22,X-9,Y-43	NSOTVM6	W-18
NS725LA	W-26	NS783W	W-24,X-10,Y-43	NSJ6BK25	W-22,X-9	NSOVAMP	W-19
NS725W	W-26	NS784	W-24,X-10	NSJ6GN	W-22,X-9	NSOVM4	W-19

# Catalog Number Index

Catalog Number	Page	Catalog Number	Page	Catalog Number	Page	Catalog Number	Page
NSOVM42G	W-19	NVA15GHGA	Y-47	OKR/D24-3C	S-4	OWI45/D10S	S-6
NSOVM6	W-19	NVBA	Y-47	OKR/D24-4C	S-4	OWI45/D12F	S-6
NSOVM62G	W-19	NVGA	Y-47	OKR/D9-1C	S-4	OWI45/D12S	S-6
NSOVM8	W-19	NVX15GHGA	Y-47	OKR/D9-2C	S-4	OWI45/D18F	S-6
NSOVM82G	W-19	OK/DSD-x	S-4	OKSK	S-3	OWI45/D18S	S-6
NSP101BK	W-23	OK/F-x	S-4	OKT/B12-2C	S-3	OWL/D10F	S-6
NSP101GY	W-23	OK/VVV	S-4	OKT/B18-3C	S-3	OWL/D10S	S-6
NSP101I	W-23	OK/VWI	S-4	OKT/B24-3C	S-3	OWL/D12F	S-6
NSP101LA	W-23	OKA/B12-2C-1/4	S-3	OKT/B9-1C	S-3	OWL/D12S	S-6
NSP101W	W-23	OKA/B18-3C-1/4	S-3	OKT/C12-3C	S-3	OWL/D18F	S-6
NSP102BK	W-23	OKA/B24-3C-1/4	S-3	OKT/C18-4C	S-3	OWL/D18S	S-6
NSP102GY	W-23	OKA/B9-1C-1/4	S-3	OKT/C24-4C	S-3	OWP/D10	S-8
NSP102I	W-23	OKA/C12-3C-1/4	S-3	OKT/C9-2C	S-3	OWR/D10F	S-7
NSP102LA	W-23	OKA/C18-4C-1/4	S-3	OKX/B12-2C	S-4	OWR/D10S	S-7
NSP102W	W-23	OKA/C24-4C-1/4	S-3	OKX/B18-3C	S-4	OWR/D12-10F	S-7
NSP103BK	W-23	OKA/C9-2C-1/4	S-3	OKX/B24-3C	S-4	OWR/D12-10S	S-7
NSP103GY	W-23	OKARED/B12-9-3C	S-4	OKX/B9-1C	S-4	OWR/D12F	S-7
NSP103I	W-23	OKARED/B18-12-3C	S-4	OKX/C12-3C	S-4	OWR/D12S	S-7
NSP103LA	W-23	OKARED/B24-18-4C	S-4	OKX/C18-4C	S-4	OWR/D18F	S-7
NSP103W	W-23	OKARED/B9-6-2C	S-4	OKX/C24-4C	S-4	OWR/D18S	S-7
NSP104BK	W-23	OKB/B12-2C	S-3	OKX/C9-2C	S-4	OWSC/10F	S-8
NSP104GY	W-23	OKB/B18-3C	S-3	OWA/D10F	S-6	OWSC/10S	S-8
NSP104I	W-23	OKB/B24-3C	S-3	OWA/D10S	S-6	OWSC/12F	S-8
NSP104LA	W-23	OKB/B9-1C	S-3	OWA/D12F	S-6	OWSC/12S	S-8
NSP104W	W-23	OKB/C12-3C	S-3	OWA/D12S	S-6	OWSC/18F	S-8
NSP106BK	W-23	OKB/C18-4C	S-3	OWA/D18F	S-6	OWSC/18S	S-8
NSP106GY	W-23	OKB/C24-4C	S-3	OWA/D18S	S-6	OWSWI/D10F	S-6
NSP106I	W-23	OKB/C9-2C	S-3	OWB/D10-10	S-7	OWSWI/D10S	S-6
NSP106LA	W-23	OKC/12-3/4A	S-3	OWB/D12-18	S-7	OWSWI/D12F	S-6
NSP106W	W-23	OKC/12-3/4C	S-3	OWB/D18-12	S-7	OWSWI/D12S	S-6
NSP11BK	W-23	OKC/18-3/4A	S-3	OWB/D18-18	S-7	OWSWI/D18F	S-6
NSP11GY	W-23	OKC/18-3/4C	S-3	OWC/D10	S-8	OWSWI/D18S	S-6
NSP11I	W-23	OKC/24-3/4A	S-3	OWC/D12	S-8	OWSWP/D	S-8
NSP11LA	W-23	OKC/24-3/4C	S-3	OWC/D18	S-8	OWSWR/D10F	S-7
NSP11W	W-23	OKC/9-3/4A	S-3	OWC/PD	S-8	OWSWR/D10S	S-7
NSP12BK	W-23	OKC/9-3/4C	S-3	OWD/D (18-10)	S-8	OWSWR/D12-10F	S-7
NSP12GY	W-23	OKE/B12	S-4	OWD/D (18-12)	S-8	OWSWR/D12-10S	S-7
NSP12I	W-23	OKE/B18	S-4	OWE/D10F	S-8	OWSWR/D12F	S-7
NSP12LA	W-23	OKE/B24	S-4	OWE/D10S	S-8	OWSWR/D12S	S-7
NSP12W	W-23	OKE/B9	S-4	OWE/D12F	S-8	OWSWR/D18F	S-7
NSP13BK	W-23	OKE/C12	S-4	OWE/D12S	S-8	OWSWR/D18S	S-7
NSP13GY	W-23	OKE/C18	S-4	OWE/D18F	S-8	OWT/D10F	S-7
NSP13I	W-23	OKE/C24	S-4	OWE/D18S	S-8	OWT/D10S	S-7
NSP13LA	W-23	OKE/C9	S-4	OWF/D10	S-8	OWT/D12F	S-7
NSP13W	W-23	OKL/B12-2C	S-3	OWF/D12	S-8	OWT/D12S	S-7
NSP14BK	W-23	OKL/B12-2Cx45	S-3	OWF/D18	S-8	OWT/D18F	S-7
NSP14GY	W-23	OKL/B18-3C	S-3	OWH/D10F	S-6	OWT/D18S	S-7
NSP14I	W-23	OKL/B18-3Cx45	S-3	OWH/D10S	S-6	OWW/D10	S-8
NSP14LA	W-23	OKL/B24-3C	S-3	OWH/D12F	S-6	OWW/D12	S-4,S-8
NSP14W	W-14,W-23	OKL/B24-3Cx45	S-3	OWH/D12S	S-6	OWW/D18	S-4,S-8
NSP16BK	W-23	OKL/B9-1C	S-3	OWH/D18F	S-6	OWW/D24	S-4
NSP16GY	W-23	OKL/B9-1Cx45	S-3	OWH/D18S	S-6	OWW/D9	S-4
NSP16I	W-23	OKL/C12-3C	S-3	OWH45/D10F	S-6	OWVT/D10F	S-7
NSP16LA	W-23	OKL/C12-3Cx45	S-3	OWH45/D10S	S-6	OWVT/D10S	S-7
NSP16W	W-23	OKL/C18-4C	S-3	OWH45/D12F	S-6	OWVT/D12F	S-7
NSP24BK	W-23	OKL/C18-4Cx45	S-3	OWH45/D12S	S-6	OWVT/D12S	S-7
NSP24GY	W-23	OKL/C24-4C	S-3	OWH45/D18F	S-6	OWVT/D18F	S-7
NSP24I	W-23	OKL/C24-4Cx45	S-3	OWH45/D18S	S-6	OWVT/D18S	S-7
NSP24LA	W-23	OKL/C9-2C	S-3	OWI/D10F	S-6	OWX/D10F	S-7
NSP24W	W-23	OKL/C9-2Cx45	S-3	OWI/D10S	S-6	OWX/D10S	S-7
NSP26BK	W-23	OKP/x	S-4	OWI/D12F	S-6	OWX/D12F	S-7
NSP26GY	W-23	OKR/D12-2C	S-4	OWI/D12S	S-6	OWX/D12S	S-7
NSP26I	W-23	OKR/D12-3C	S-4	OWI/D18F	S-6	OWX/D18F	S-7
NSP26LA	W-23	OKR/D18-3C	S-4	OWI/D18S	S-6	OWX/D18S	S-7
NSP26W	W-23	OKR/D18-4C	S-4	OWI45/D10F	S-6	P0389NBK	V-100

# Catalog Number Index

Catalog Number	Page	Catalog Number	Page	Catalog Number	Page	Catalog Number	Page
P0389NGY	V-100	PB3FCIB3G	R-60	PFBRFBL3	O-10	PP1ABC7	R-55
P038NBKA	V-100	PB3FE	R-60	PFBRFBR1	O-10	PP1BC5	R-55
P038NGYA	V-100	PB3FEBCA	R-59,R-60	PFBRFBR2	O-10	PP1BC7	R-55
P0509NBK	V-100	PB3IE	R-60	PFBRFBR3	O-10	PP1EC	R-55
P0509NGY	V-100	PB3IEBCA	R-59,R-60	PFBRFGY1	O-10	PP1EE	R-55
P050NBKA	V-100	PB3IND	R-60	PFBRFGY2	O-10	PP1EEBC	R-55
P050NGYA	V-100	PB3IND2G	R-60	PFBRFGY3	O-10	PP1FE	R-55
P0759NBK	V-100	PB3REDA	R-59,R-60	PFBRFI1	O-10	PP1FEBC	R-55
P0759NGY	V-100	PB3SC	R-59,R-60	PFBRFI2	O-10	PP1IE	R-55
P075NBKA	V-100	PB3SPCA	R-59,R-60	PFBRFI3	O-10	PP1IEBC	R-55
P075NGYA	V-100	PB3SS	R-59,R-60	PFBRFRA	O-10	PP1SC	R-55
P1009NBK	V-100	PB3TCBCA	R-59,R-60	PFBRG1	O-10,O-11	PP1SS	R-55
P1009NGY	V-100	PB3TRBC	R-59,R-60	PFBRG2	O-10,O-11	PP1TC	R-55
P100NBKA	V-100	PB3WC	R-60	PFBRG3	O-10,O-11	PP1TCBC	R-55
P100NGYA	V-100	PBS2	F-23	PFBRMC	O-10	PPTRIM1	Q-2
P1259NBK	V-100	PBS22	F-23	PFBT1A	O-8	PR20	I-43
P1259NGY	V-100	PBS4	F-23	PFBYA1	O-8	PR205E	I-43
P125NBK	V-100	PBS42	F-23	PFOLT312	V-47	PR205EB	I-43
P125NGY	V-100	PBS6	F-23	PG2	F-24	PR205EDB9B	I-43
P150NBK	V-100	PBS62	F-23	PG6	F-24	PR205ESBA2	I-43
P150NGY	V-100	PBS8	F-23	PH2030C	F-9,I-7	PR205ESBA2VGA	I-43
P155E	I-43	PBS82	F-23	PH3004PAxxx	F-9,I-7	PR205EUSBA	I-43
P155E2	I-43	PBSBC	F-24	PH6595	Y-31	PR4X205E	I-43
P155EB	I-43	PBSLP	F-24	PH6596	Y-31	PR4X205EB	I-43
P15DB9MFC10	I-43	PBSPL1	F-24	PH6597	Y-31	PS0389NBK	V-100
P15DH485C10	I-43	PC100	G-7G-11,Y-19	PH6597TV	Y-31	PS0389NGY	V-100
P15ML8F8MC10	I-43	PC320	G-6,G-11,Y-24	PH6598	Y-30	PS0509NBK	V-100
P200NBK	V-100	PC3430	G-6,G-11,Y-24	PH6598W	Y-30	PS0509NGY	V-100
P200NGY	V-100	PC420	G-6,G-11	PH6599	Y-30	PS05GYKIT	V-100
P205EDB9	I-43	PC520	G-6,G-11	PH6599W	Y-30	PS0759NBK	V-100
P20DH5E	I-43	PC530	G-6,G-11	PH6619	Y-31,Y-46	PS0759NGY	V-100
P4X155E	I-43	PC60	G-7,G-11,Y-24	PH6621	Y-31	PS07GYKIT	V-100
P4X155EB	I-43	PDB12D	R-55,R-58,R-62	PH6624	Y-30	PS1009NBK	V-100
P4X5E	I-43	PDB12LF	R-55,R-58,R-62	PH6625	Y-30	PS1009NGY	V-100
P4XUSBA2C3	I-43	PDB12LP	R-55,R-58,R-62	PH7440	Y-30	PS3BC10	R-61
P5E	I-43	PDB12S	R-55,R-58,R-62	PH7499	Y-30	PS3BC5	R-61
P5E12U	W-11	PDB12TGD	R-55,R-58,R-62	PHPS1AL	N-10,R-45	PS3CACF	R-61
P5E24UE	W-11	PDB12TGLV	R-55,R-56,R-58	PHPS1G	N-10,R-45	PS3EC	R-61
P5E48UE	W-11	PDB1DIV	R-58	PHPS2AL	N-10,R-45	PS3EE	R-61
P5E96UE	W-11	PDB2DIV	R-58	PHPS2G	N-10,R-45	PS3EEBC	R-61
P612U	W-11	PDB9	I-43	PHPS3AL	N-10,R-45	PS3FCIB	R-61
P630S1GJ6	W-5	PDB9MF	I-43	PHPS4AL	N-10,R-45	PS3FCIB2G	R-61
P630S1GJ8	W-5	PDCS332	O-29	PHPS5AL	N-10,R-45	PS3FCIB3G	R-61
P630SR1GJ6	W-5	PDCS42222	O-29	PHPS6AL	N-10,R-45	PS3FE	R-61
P630SR1GJ8	W-5	PDCS42231	O-29	PJS126AL	N-11,R-45	PS3FEBC	R-61
P6E24U	W-11	PDH5E	I-43	PJS126G	N-11,R-45	PS3IE	R-61
P6E48U	W-11	PF3004PAxxx	F-9,I-7	PJS226G	N-13,R-45	PS3IEBC	R-61
P6E96U	W-11	PFB1	O-8	PL1ABC5	R-56	PS3IND	R-61
PB2B10	R-59	PFBA1A	O-8	PL1ABC7	R-56	PS3RED	R-61
PB2B5	R-59	PFBCBLA	O-8	PL1BC5	R-56	PS3SC	R-61
PB2C10	R-59	PFBCBRA	O-8	PL1BC7	R-56	PS3SPC	R-61
PB2C5	R-59	PFBCGYA	O-8	PL1EC	R-56,R-62	PS3SS	R-61
PB2CACF	R-59	PFBCIA	O-8	PL1EE	R-56,R-62	PS3TCBC	R-61
PB2IND2G	R-59	PFBP1	O-8	PL1EEBC	R-56,R-62	PS3WC	R-61
PB2SPL10	R-59	PFBR826BLA	O-10	PL1FE	R-56,R-62	PT12CA	R-54
PB2SPL5	R-59	PFBR826BRA	O-10	PL1FEBC	R-56,R-62	PT12DBA	R-54
PB2WC	R-59	PFBR826GYA	O-10	PL1IE	R-56,R-62	PT12LFB	R-54
PB3BC10	R-60	PFBR826IA	O-10	PL1IEBC	R-56,R-62	PT12LPB	R-54
PB3BC5	R-60	PFBRAC	O-11	PL1MC	R-62	PT12SBA	R-54
PB3CACF	R-60	PFBRCLA	P-18	PL1SC	R-56,R-62	PT12TGB	R-54
PB3ECA	R-59,R-60	PFBRCBRA	P-18	PL1SS	R-56,R-62	PT153112P	R-62
PB3EE	R-60	PFBRCGYA	P-18	PL1TC	R-56,R-62	PT155112	R-62
PB3EEBCA	R-59,R-60	PFBRCLA	P-18	PL1TCBC	R-56,R-62	PT155112P	R-62
PB3FCIB	R-60	PFBRFBL1	O-10	PLP1CACF	R-56,R-62	PT155112TR	R-62
PB3FCIB2G	R-60	PFBRFBL2	O-10	PP1ABC5	R-55	PT155112TR	R-62



# Catalog Number Index

Catalog Number	Page	Catalog Number	Page	Catalog Number	Page	Catalog Number	Page
PT155115	R-62	PT2X2SFBR3	P-17	RA12IPK100	N-29	RC308	X-13
PT155130	R-62	PT2X2SFGY	P-17	RA12LAPK100	N-29	RC308I	X-13
PT155212	R-62	PT71SD	P-19	RA12PK100	N-29	RC308ITR	X-13
PT156112	R-62	PT73FFSDBK	P-19	RA12WPK100	N-29	RC308TR	X-13
PT156118	R-62	PT73FFSDGY	P-19	RA38ALPK100	N-29	RC308W	X-13
PT156124	R-62	PT73FFSDI	P-19	RA38BKPK100	N-29	RC308WTR	X-13
PT156212	R-62	PT73SD	P-18,P-19	RA38GYPK100	N-29	RC309	X-13
PT15RGYTR	R-16	PT7FFSDGY	P-19	RA38IPK100	N-29	RC309I	X-13
PT15RIVTR	R-16	PT7FFSDI	P-19	RA38LAPK100	N-29	RC309W	X-13
PT1ABC5	R-54	PT7FSD	P-18	RA38PK100	N-29	RCD101BK	X-4
PT1ABC7	R-54	PT7FSDBLA	P-18	RA38SSPK100	N-29	RCD101GY	X-4
PT1BC5	R-54	PT7FSDBRA	P-18	RA38WPK100	N-29	RCD101I	X-4
PT1BC7	R-54	PT7FSDBRS2A	P-18	RA40	N-29	RCD101LA	X-4
PT1EC	R-54	PT7FSDBRS3A	P-18	RA58SSPK100	N-29	RCD101W	X-4
PT1EE	R-54	PT7FSDGYA	P-18	RA756	N-29	RCD103BK	X-4
PT1FE	R-54	PT7FSDIA	P-18	RA756I	N-29	RCD103GY	X-4
PT1IE	R-54	PT7IGFSDBRSA	P-18	RA756W	N-29	RCD103I	X-4
PT1RCGY	R-35	PT7IGFSDGYA	P-18	RA88IPK100	N-29	RCD103LA	X-4
PT1RCIG	R-16,R-35	PT7IGFSDIA	P-18	RA88SSPK100	N-29	RCD103W	X-4
PT1RCIV	R-16	PT7XC	P-20,P-21	RA88WPK100	N-29	RCD108BK	X-4
PT1RGY	R-35	PW1ABC5	R-57	RAY103PI	X-22	RCD108BKTR	X-4
PT1RIG	R-16,R-35	PW1ABC7	R-57	RAY103PLA	X-22	RCD108GY	X-4
PT1RIV	R-16	PW1BC5	R-57	RAY103PW	X-22	RCD108GYTR	X-4
PT1SC	R-54	PW1BC7	R-57	RAY10PI	X-22	RCD108I	X-4
PT1TC	R-54	PW1CA	R-57	RAY10PLA	X-22	RCD108ITR	X-4
PT203112P	R-62	PW1DBA	R-57	RAY10PW	X-22	RCD108LA	X-4
PT205112	R-62	PW1EC	R-57	RAY2LFSQI	X-22	RCD108LATR	X-4
PT205112P	R-62	PW1EE	R-57	RAY2LFSQLA	X-22	RCD108W	X-4
PT205112TR	R-62	PW1FE	R-57	RAY2LFSQW	X-22	RCD108WTR	X-4
PT205112TR	R-62	PW1IE	R-57	RAY600PI	X-22	RCD109I	X-4
PT205115	R-62	PW1LFB	R-57	RAY600PLA	X-22	RCD109LA	X-4
PT205130	R-62	PW1LPB	R-57	RAY600PW	X-22	RCD109W	X-4
PT205212	R-62	PW1SBA	R-57	RAY603PI	X-22	RCD111I	X-4
PT205215	R-62	PW1SC	R-57	RAY603PLA	X-22	RCD111LA	X-4
PT206106	R-62	PW1TC	R-57	RAY603PW	X-22	RCD111W	X-4
PT206112	R-62	PW1TGB	R-57	RAYCL153PI	X-22	RCD303BK	X-4
PT206118	R-62	PW2ABC5	R-58	RAYCL153PLA	X-22	RCD303GY	X-4
PT206124	R-62	PW2ABC7	R-58	RAYCL153PW	X-22	RCD303I	X-4
PT206136	R-62	PW2BC5	R-58	RAYFSQFI	X-22	RCD303LA	X-4
PT206206	R-62	PW2BC7	R-58	RAYFSQFLA	X-22	RCD303W	X-4
PT206212	R-62	PW2CACF	R-58	RAYFSQFW	X-22	RCD308BK	X-4
PT206218	R-62	PW2EC	R-58	RC101	X-13	RCD308BKTR	X-4
PT206224	R-62	PW2EE	R-58	RC101I	X-13	RCD308GY	X-4
PT20RGYTR	R-16	PW2EEBC	R-58	RC101LA	X-13	RCD308GYTR	X-4
PT20RIVTR	R-16	PW2FE	R-58	RC101W	X-13	RCD308I	X-4
PT27A	P-20	PW2FEBC	R-58	RC103	X-13	RCD308ITR	X-4
PT2FIT	P-19	PW2IE	R-58	RC103I	X-13	RCD308LA	X-4
PT2R	R-16	PW2IEBC	R-58	RC103LA	X-13	RCD308LATR	X-4
PT2RC	R-16	PW2RED	R-58	RC103W	X-13	RCD308W	X-4
PT2RCIG	R-16	PW2SC	R-58	RC108	X-13	RCD308WTR	X-4
PT2RIG	R-16	PW2SS	R-58	RC108I	X-13	RCD309I	X-4
PT2X2BL	P-17	PW2TC	R-58	RC108ITR	X-13	RCD309LA	X-4
PT2X2BRS	P-17	PW2TCBC	R-58	RC108LA	X-13	RCD309W	X-4
PT2X2BRS3	P-17	Q106AL	R-45,W-6	RC108LATR	X-13	RCW1I	N-4,X-6
PT2X2CBL	P-17	Q106B	W-6	RC108TR	X-13	RCW1LA	N-4,X-6
PT2X2CBRS	P-17	Q106E	W-6	RC108W	X-13	RCW1W	N-4,X-6
PT2X2CGY	P-17	Q106G	R-45,W-6	RC108WTR	X-13	RCW2I	N-4,X-6
PT2X2FIT	P-17	Q106LA	W-6	RC109	X-13	RCW2LA	N-4,X-6
PT2X2GY	P-17	Q106O	R-63,W-6	RC109I	X-13	RCW2W	N-4,X-6
PT2X2IGBL	P-17	Q106W	W-6	RC109LA	X-13	RCW3I	N-4,X-6
PT2X2IGBRS	P-17	R28032401	X-22	RC109W	X-13	RCW3LA	N-4,X-6
PT2X2IGBRS3	P-17	R28032406	X-22	RC303	X-13	RCW3W	N-4,X-6
PT2X2IGGY	P-17	RA12ALPK100	N-29	RC303I	X-13	RCW4I	N-4,X-6
PT2X2SFB	P-17	RA12BKPK100	N-29	RC303LA	X-13	RCW4LA	N-4,X-6
PT2X2SFBR3	P-17	RA12GYPK100	N-29	RC303W	X-13	RCW4W	N-4,X-6

# Catalog Number Index

Catalog Number	Page	Catalog Number	Page	Catalog Number	Page	Catalog Number	Page
RCW5I	N-4,X-6	RF506BN	O-23,X-24	RL122	Z-8	RP102W	Z-9
RCW5LA	N-4,X-6	RF506BP	O-23,X-24	RL124	Z-8	RP123I	Z-9
RCW5W	N-4,X-6	RF506BR	O-23,X-24	RL124H	Z-8	RP123PI	Z-9
RCW6I	N-4,X-6	RF506CH	O-23,X-24	RL125	Z-8	RP123PW	Z-9
RCW6LA	N-4,X-6	RF506CU	O-23,X-24	RL150	Z-8	RP123W	Z-9
RCW6W	N-4,X-6	RF506NI	O-23,X-24	RL152	Z-7	RP646	Z-9
RD600PDK	X-22	RF506SS	O-23,X-24	RL153	Z-7	RP648	Z-9
RD600RI	X-22	RF507AL	X-24	RL154	Z-8	RP649	Z-9
RD600RW	X-22	RF507BK	X-24	RL156	Z-7	RPL30P	Y-8,Y-9,Y-11
RD603PDK	X-22	RF507BN	X-24	RL157	Z-7	RR15	X-15
RDS30	X-20	RF507BP	X-24	RL158	Z-7	RR151	X-15
RDS50	X-20	RF507BR	X-24	RL159	Z-7	RR151BK	X-15
RDV103PI	X-21	RF507CH	X-24	RL160	Z-7	RR151BKTR	X-15
RDV103PLA	X-21	RF507CU	X-24	RL161	Z-7	RR151BKWRTR	X-15
RDV103PW	X-21	RF507NI	X-24	RL162	Z-7	RR151CHBSTR	X-20
RDV10PI	X-21	RF507SS	X-24	RL163	Z-7	RR151CHITR	X-20
RDV10PLA	X-21	RF509BR	O-23,X-24	RL164	Z-7	RR151CHSSTR	X-20
RDV10PW	X-21	RF515AL	O-23,X-24	RL200	Z-8	RR151CHWTR	X-20
RDV600PI	X-21	RF515BK	O-23,X-24	RL201	Z-8	RR151GY	X-15
RDV600PLA	X-21	RF515BN	O-23,X-24	RL202	Z-8	RR151GYTR	X-15
RDV600PW	X-21	RF515BP	O-23,X-24	RL305	Z-6	RR151GYWRTR	X-15
RDV603PI	X-21	RF515BR	O-23,X-24	RL306	Z-6	RR151I	X-15
RDV603PLA	X-21	RF515CH	O-23,X-24	RL307	Z-6	RR151ITR	X-15
RDV603PW	X-21	RF515CU	O-23,X-24	RL308	Z-6	RR151IWRTR	X-15
RDVCL153PI	X-22	RF515NI	O-23,X-24	RL310	Z-6	RR151LA	X-15
RDVCL153PLA	X-22	RF515SS	O-23,X-24	RL311	Z-6	RR151LATR	X-15
RDVCL153PW	X-22	RF6500BR	X-25	RL320	Z-6	RR151LAWRTR	X-15
RDVELV300PI	X-21	RFS5I	X-22	RL325	Z-6	RR151TR	X-15
RDVELV300PLA	X-21	RFS5LA	X-22	RL325B	Z-6	RR151W	X-15
RDVELV300PW	X-21	RFS5W	X-22	RL356	Z-6	RR151WRTR	X-15
RDVELV303PI	X-21	RFSQ2FDK	X-22	RL357	Z-6	RR151WTR	X-15
RDVELV303PLA	X-21	RFW1I	N-4	RL3742	Z-7	RR151WWRTR	X-15
RDVELV303PW	X-21	RFW1W	N-4	RL413HSI	Z-6	RR155	X-15
RDVFSQFBK	X-21	RFW2I	N-4	RL413HSM	Z-6	RR155BK	X-15
RDVFSQFI	X-21	RFW2W	N-4	RL4221	Z-7	RR155BKWR	X-15
RDVFSQFLA	X-21	RFW3I	N-4	RL426G24	Z-6	RR155GY	X-15
RDVFSQFW	X-21	RFW3W	N-4	RL42G11H9	Z-6	RR155GYWR	X-15
RDVLV600PI	X-21	RJ600	X-20,X-29	RL42G11HSM	Z-6	RR155I	X-15
RDVLV600PLA	X-21	RJ620BKTR	X-20,X-27,X-29	RL479HSM	Z-6	RR155IWR	X-15
RDVLV600PW	X-21	RJ620GYTR	X-20,X-27,X-29	RL5221	Z-7	RR155LA	X-15
RDVLV603PI	X-21	RJ620ITR	X-20,X-27,X-29	RL8504	Z-5	RR155LAWR	X-15
RDVLV603PLA	X-21	RJ620LATR	X-20,X-27,X-29	RL8506	Z-5	RR155W	X-15
RDVLV603PW	X-21	RJ620WTR	X-20,X-27,X-29	RL8512	Z-5	RR155WR	X-15
RF151D	X-25	RJ62BKTR	X-20,X-27,X-29	RL8516	Z-5	RR155WWR	X-15
RF151DTR	X-25	RJ62GYTR	X-20,X-27,X-29	RL8804	Z-5	RR15BK	X-15
RF151R	O-23,X-25	RJ62ITR	X-20,X-27,X-29	RL8806	Z-5	RR15EBKTR	X-15
RF151TR	X-25	RJ62LATR	X-20,X-27,X-29	RL8812	Z-5	RR15EGYTR	X-15
RF201R	O-23,X-25	RJ62WTR	X-20,X-27,X-29	RL8816	Z-5	RR15EITR	X-15
RF3004PA001	F-9,I-7	RJ650BKTR	X-20,X-27,X-29	RL8822	Z-5	RR15ELATR	X-15
RF400	O-22,X-27	RJ650GYTR	X-20,X-27,X-29	RM3004PA001	F-9,I-7	RR15EQBKTR	X-14
RF406AL	O-22,X-27	RJ650ITR	X-20,X-27,X-29	RMS120I	X-23	RR15EQITR	X-14
RF406BK	O-22,X-27	RJ650LATR	X-20,X-27,X-29	RMS120ILI	X-23	RR15EQLATR	X-14
RF406BN	O-22,X-27	RJ650WTR	X-20,X-27,X-29	RMS120ILLA	X-23	RR15EQTR	X-14
RF406BR	O-22,X-27	RJ65BKTR	X-20,X-27,X-29	RMS120ILW	X-23	RR15EQWTR	X-14
RF406GY	O-22,X-27	RJ65GYTR	X-20,X-27,X-29	RMS120LA	X-23	RR15ETR	X-15
RF407AL	O-22,X-27	RJ65ITR	X-20,X-27,X-29	RMS120W	X-23	RR15EWTR	X-15
RF407BK	O-22,X-27	RJ65LATR	X-20,X-27,X-29	RMS121I	X-23	RR15I	X-15
RF407BN	O-22	RJ65WTR	X-20,X-27,X-29	RMS121ILI	X-23	RR15K	X-15
RF407BR	O-22,X-27	RL100	Z-5	RMS121ILLA	X-23	RR15KI	X-15
RF407GY	O-22	RL101	Z-5	RMS121ILW	X-23	RR15KITR	X-15
RF408	O-22,X-27	RL102	Z-5	RMS121LA	X-23	RR15KLATR	X-15
RF409BR	O-22,X-27	RL105	Z-5	RMS121W	X-23	RR15KTR	X-15
RF500	O-23,X-24	RL106	Z-5	RP101BK	Z-9	RR15KW	X-15
RF506AL	O-23,X-24	RL120	Z-8	RP101W	Z-9	RR15KWTR	X-15
RF506BK	O-23,X-24	RL121	Z-8	RP102BK	Z-9	RR15LA	X-15

# Catalog Number Index

Catalog Number	Page	Catalog Number	Page	Catalog Number	Page	Catalog Number	Page
RR15QBKTR	X-14	RR430PM	X-19	RRD15W	X-5	RS600PI	X-21
RR15QITR	X-14	RR435P	X-19	RRD201	X-5	RS600PLA	X-21
RR15QLATR	X-14	RR450	X-19	RRD201BK	X-5	RS600PW	X-21
RR15QTR	X-14	RR450F	X-19	RRD201BKTR	X-5	RS600W	X-21
RR15QWTR	X-14	RR450FW	X-19	RRD201GY	X-5	RS603PI	X-21
RR15S	X-15	RR450PM	X-19	RRD201GYTR	X-5	RS603PLA	X-21
RR15SBK	X-15	RRD15	X-5	RRD201I	X-5	RS603PW	X-21
RR15SBKTR	X-15	RRD151	X-5	RRD201ITR	X-5	RS613PI	X-21
RR15SBKWRTR	X-15	RRD151BK	X-5	RRD201LA	X-5	RS613PLA	X-21
RR15SI	X-15	RRD151BKTR	X-5	RRD201LATR	X-5	RS613PW	X-21
RR15SITR	X-15	RRD151GY	X-5	RRD201TR	X-5	RSD115	X-3
RR15SIWRTR	X-15	RRD151GYTR	X-5	RRD201W	X-5	RSD115BK	X-3
RR15SLA	X-15	RRD151I	X-5	RRD201WTR	X-5	RSD115GY	X-3
RR15SLATR	X-15	RRD151ITR	X-5	RRD205	X-5	RSD115I	X-3
RR15SLAWRTR	X-15	RRD151LA	X-5	RRD205BK	X-5	RSD115ILI	X-3
RR15STR	X-15	RRD151LATR	X-5	RRD205GY	X-5	RSD115ILLA	X-3
RR15SW	X-15	RRD151TR	X-5	RRD205I	X-5	RSD115ILW	X-3
RR15SWRTR	X-15	RRD151W	X-5	RRD205LA	X-5	RSD115IM	X-3
RR15SWTR	X-15	RRD151WTR	X-5	RRD205W	X-5	RSD115LA	X-3
RR15SwwRTR	X-15	RRD155	X-5	RRKDK	X-22	RSD115LAM	X-3
RR15W	X-15	RRD155BK	X-5	RS100W	X-20	RSD115PLI	X-3
RR201	X-15	RRD155GY	X-5	RS101I	X-20	RSD115PLLA	X-3
RR201BK	X-15	RRD155I	X-5	RS101W	X-20	RSD115PLW	X-3
RR201BKTR	X-15	RRD155LA	X-5	RS103PI	X-21	RS115W	X-3
RR201BKWRTR	X-15	RRD155W	X-5	RS103PLA	X-21	RSD115WM	X-3
RR201CHBSTR	X-20	RRD15BK	X-5	RS103PW	X-21	RSD215	X-3
RR201CHITR	X-20	RRD15EBKTR	X-5	RS10PI	X-21	RSD215BK	X-3
RR201CHSSTR	X-20	RRD15EGYTR	X-5	RS10PLA	X-21	RSD215GY	X-3
RR201CHWTR	X-20	RRD15EITR	X-5	RS10PW	X-21	RSD215I	X-3
RR201GY	X-15	RRD15ELATR	X-5	RS115	X-12	RSD215LA	X-3
RR201GYTR	X-15	RRD15ETR	X-5	RS115BK	X-12	RSD215W	X-3
RR201GYWRTR	X-15	RRD15EWTR	X-5	RS115I	X-12	RSD315	X-3
RR201I	X-15	RRD15GY	X-5	RS115ILC	X-12	RSD315BK	X-3
RR201ITR	X-15	RRD15I	X-5	RS115ILI	X-12	RSD315GY	X-3
RR201IWRTR	X-15	RRD15K	X-5	RS115ILLA	X-12	RSD315I	X-3
RR201LA	X-15	RRD15KBK	X-5	RS115ILW	X-12	RSD315ILI	X-3
RR201LATR	X-15	RRD15KBKTR	X-5	RS115LA	X-12	RSD315ILLA	X-3
RR201LAWRTR	X-15	RRD15KGY	X-5	RS115S	X-12	RSD315ILW	X-3
RR201TR	X-15	RRD15KGYTR	X-5	RS115SI	X-12	RSD315LA	X-3
RR201W	X-15	RRD15KI	X-5	RS115SLA	X-12	RSD315W	X-3
RR201WRTR	X-15	RRD15KITR	X-5	RS115SW	X-12	RSD415	X-3
RR201WTR	X-15	RRD15KLA	X-5	RS115W	X-12	RSD415GY	X-3
RR201WWRTR	X-15	RRD15KLATR	X-5	RS2LFSQI	X-21	RSD415I	X-3
RR205	X-15	RRD15KTR	X-5	RS2LFSQLA	X-21	RSD415LA	X-3
RR205BK	X-15	RRD15KW	X-5	RS2LFSQW	X-21	RSD415W	X-3
RR205BKWR	X-15	RRD15KWTR	X-5	RS315	X-12	RSELV300PI	X-21
RR205GY	X-15	RRD15LA	X-5	RS315BK	X-12	RSELV300PLA	X-21
RR205GYWR	X-15	RRD15S	X-5	RS315I	X-12	RSELV300PW	X-21
RR205I	X-15	RRD15SBK	X-5	RS315ILC	X-12	RSELV303PI	X-21
RR205IWR	X-15	RRD15SBKTR	X-5	RS315ILI	X-12	RSELV303PLA	X-21
RR205LA	X-15	RRD15SBKWRTR	X-5	RS315ILLA	X-12	RSELV303PW	X-21
RR205LAWR	X-15	RRD15SGY	X-5	RS315ILW	X-12	RSFSQFI	X-21
RR205W	X-15	RRD15SGYTR	X-5	RS315LA	X-12	RSFSQFLA	X-21
RR205WR	X-15	RRD15SGYWRTR	X-5	RS315S	X-12	RSFSQFW	X-21
RR205WWR	X-15	RRD15SI	X-5	RS315SI	X-12	RSKI	X-21
RR330	X-19	RRD15SITR	X-5	RS315SLA	X-12	RSKLA	X-21
RR330F	X-19	RRD15SIWRTR	X-5	RS315SW	X-12	RSKW	X-21
RR335P	X-19	RRD15SLA	X-5	RS315W	X-12	RSLV600PI	X-21
RR350	X-19	RRD15SLATR	X-5	RS415	X-12	RSLV600PLA	X-21
RR350F	X-19	RRD15SLAWRTR	X-5	RS415BK	X-12	RSLV600PW	X-21
RR374	Z-8	RRD15STR	X-5	RS415I	X-12	RSLV603PI	X-21
RR374W	Z-8	RRD15SW	X-5	RS415LA	X-12	RSLV603PLA	X-21
RR430	X-19	RRD15SWRTR	X-5	RS415W	X-12	RSLV603PW	X-21
RR430F	X-19	RRD15SWTR	X-5	RS600I	X-21	RT100W	Z-9
RR430FW	X-19	RRD15SwwRTR	X-5	RS600LA	X-21	RT200	Z-9

# Catalog Number Index

Catalog Number	Page	Catalog Number	Page	Catalog Number	Page	Catalog Number	Page
RT300I	Z-9	S1PT4X4BRS3	P-13	S1R6PTWZBRZ	P-11	S1R8PT3NKL	P-10
RT300W	Z-9	S1PT4X4BRS3J	P-13	S1R6PTWZBNKL	P-11	S1R8PTFIT1	P-6
RT303	Z-9	S1PT4X4BRSJ	P-13	S1R6SPA	P-9	S1R8PTFIT1CHI	P-6
RT600I	Z-9	S1PT4X4FIT	P-14	S1R6SPB	P-9	S1R8PTFIT2	P-6
RT600W	Z-9	S1PT4X4FITJ	P-14	S1R6SPC	P-9	S1R8PTFIT2CHI	P-6
RU100SS	X-28	S1PT4X4GY	P-13	S1R6SPD	P-9	S1R8PTFIT3	P-6
RU100W	X-28	S1PT4X4GYJ	P-13	S1R6SPE	P-9	S1R8PTFIT3CHI	P-6
RU170W	X-28	S1PTAL	P-13	S1R6SPF	P-9	S1R8PTZZ1ALU	P-10
RU200SS	X-28	S1PTALJ	P-13	S1R6SPG	P-9	S1R8PTZZ1BLK	P-10
RU200W	X-28	S1PTAVFIT	P-14	S1R6SPH	P-9	S1R8PTZZ1BRS	P-10
RU270W	X-28	S1PTAVFITJ	P-14	S1R6SPI	P-9	S1R8PTZZ1BRZ	P-10
RW51020	N-26	S1PTBL	P-13	S1R6SPJ	P-9	S1R8PTZZ1NKL	P-10
RW51040	N-26	S1PTBLJ	P-13	S1R6SPK	P-9	S1R8PTZZ2ALU	P-10
RW51320	N-26	S1PTBRS	P-13	S1R6SPM	P-9	S1R8PTZZ2BLK	P-10
RW51330	N-26	S1PTBRSJ	P-13	S1R6SPV	P-9	S1R8PTZZ2BRS	P-10
RW51380	N-26	S1PTFFAL	P-13	S1R6SPW	P-9	S1R8PTZZ2BRZ	P-10
RW51450	N-26	S1PTFFALJ	P-13	S1R6SPX	P-9	S1R8PTZZ2NKL	P-10
RW51470	N-26	S1PTFFBL	P-13	S1R6SPY	P-9	S1R8PTZZ3ALU	P-10
RW51520	N-26	S1PTFFBLJ	P-13	S1R6SPZ	P-9	S1R8PTZZ3BLK	P-10
RW51550	N-26	S1PTFFBRS	P-13	S1R6SPZ25	P-9	S1R8PTZZ3BRS	P-10
RW51810	N-26	S1PTFFBRSJ	P-13	S1R8ADMTBK	P-7	S1R8PTZZ3BRZ	P-10
RW57300	N-28,Y-44	S1PTFFGY	P-13	S1R8CSPA	P-7	S1R8PTZZ3NKL	P-10
RW57350	N-28,Y-44	S1PTFFGYJ	P-13	S1R8CSPB	P-7	S1RFFFIT075	P-9
RW57400	N-28,Y-44	S1PTFIT	P-14	S1R8CSPC	P-7	S1RFFFIT2	P-9
RW57750	N-28,Y-44	S1PTFITJ	P-14	S1R8CSPD	P-7	S1RPLUG075ALU	P-9
RW57900	N-28,Y-44	S1PTGY	P-13	S1R8CSPD	P-7	S1RPLUG075BLK	P-9
RW57950	N-28,Y-44	S1PTGYJ	P-13	S1R8CSPE	P-7	S1RPLUG075BRS	P-9
S1AP4BL	O-6,P-14	S1R6ADMTBK	P-9	S1R8CSPEXT	P-7	S1RPLUG075BRZ	P-9
S1AP4GY	O-6,P-14	S1R6CVRALU	P-9	S1R8CSPG	P-7	S1RPLUG075NKL	P-9
S1AVHUB15	O-6	S1R6CVRBLK	P-9	S1R8CSPI	P-7	S1RPLUG2ALU	P-9
S1CFB	O-6	S1R6CVRBRS	P-9	S1R8CSPJ	P-7	S1RPLUG2BLK	P-9
S1CFCAL	O-6,P-14	S1R6CVRBRZ	P-9	S1R8CSPK	P-7	S1RPLUG2BRS	P-9
S1CFCBL	O-6,P-14	S1R6CVRNKL	P-9	S1R8CSPL	P-7	S1RPLUG2BRZ	P-9
S1CFCBRS	O-6,P-14	S1R6DIV	P-9	S1R8CSPM	P-7	S1RPLUG2NKL	P-9
S1CFCGY	O-6,P-14	S1R6FFCVRALU	P-9	S1R8CSPN	P-7	S1SFB	O-6
S1CFCI	O-6,P-14	S1R6FFCVRBLK	P-9	S1R8CVRALU	O-17,P-7	S1SFAV	O-6
S1DFMAX	O-7,P-15	S1R6FFCVRBRS	P-9	S1R8CVRBLK	O-17,P-7	S1SP	O-7,P-15
S1DFTRAC	O-7,P-15	S1R6FFCVRBRZ	P-9	S1R8CVRBRS	O-17,P-7	S1SP3IM	O-7,P-15
S1DIV1	O-6	S1R6FFCVRNKL	P-9	S1R8CVRBRZ	O-17,P-7	S1SP4IM	O-7,P-15
S1FBCLIP5PK	O-6	S1R6PPT	P-9	S1R8CVRNKL	O-17,P-7	S1SP4X4	O-7,P-15
S1FP15AL	O-7,P-15	S1R6PTACEGNKL	P-11	S1R8DIV	P-7	S1SP4X415	O-7,P-15
S1FP15BL	O-7,P-15	S1R6PTACEHALU	P-11	S1R8JNC1	P-7	S1SP4X430	O-7,P-15
S1FP15BRS	O-7,P-15	S1R6PTACEHBLK	P-11	S1R8JNC2	P-7	S1SP4X4PA	O-7,P-15
S1FP15GY	O-7,P-15	S1R6PTACEHBRZ	P-11	S1R8JNC3	P-7	S1SP4X4SYS	O-7,P-15
S1FP34AL	O-7,P-15	S1R6PTACEHBRZ	P-11	S1R8PPT	P-7	S1SPAMM20	O-7,P-15
S1FP34BL	O-7,P-15	S1R6PTALU	P-11	S1R8PSPJ	P-7	S1SPDU	O-7,P-15
S1FP34BRS	O-7,P-15	S1R6PTBLK	P-11	S1R8PSPV	P-7	S1SPDU2IM	O-7,P-15
S1FP34GY	O-7,P-15	S1R6PTBRS	P-11	S1R8PSPW	P-7	S1SPDUSL	O-7,P-15
S1FRP4BL	P-14	S1R6PTBRZ	P-11	S1R8PSPX	P-7	S1SPEXT1	O-7,P-15
S1FRP4GY	P-14	S1R6PTDEHALU	P-11	S1R8PSPY	P-7	S1SPEXT2	O-7,P-15
S1FRPTJB	P-7,P-9,P-14	S1R6PTDEHBLK	P-11	S1R8PSPZ	P-7	S1SPEXT3	O-7,P-15
S1PFB	O-6	S1R6PTDEHBRS	P-11	S1R8PT1ALU	P-10	S1SPEXT4	O-7,P-15
S1PT3IMAL	P-13	S1R6PTDEHBRZ	P-11	S1R8PT1BLK	P-10	S1SPFFAL	O-7,P-15
S1PT3IMALJ	P-13	S1R6PTDEHNKL	P-11	S1R8PT1BRS	P-10	S1SPFFBL	O-7,P-15
S1PT3IMBL	P-13	S1R6PTFFALU	P-11	S1R8PT1BRZ	P-10	S1SPFFBRS	O-7,P-15
S1PT3IMBLJ	P-13	S1R6PTFFBLK	P-11	S1R8PT1NKL	P-10	S1SPFFGY	O-7,P-15
S1PT3IMBRS	P-13	S1R6PTFFBRS	P-11	S1R8PT2ALU	P-10	S1SPFFTAL	O-7,P-15
S1PT3IMBRSJ	P-13	S1R6PTFFBRZ	P-11	S1R8PT2BLK	P-10	S1SPFFTBL	O-7,P-15
S1PT3IMGY	P-13	S1R6PTFFNKL	P-11	S1R8PT2BRS	P-10	S1SPFFTBRS	O-7,P-15
S1PT3IMGYJ	P-13	S1R6PTFIT	P-8	S1R8PT2BRZ	P-10	S1SPFFTGY	O-7,P-15
S1PT4X4AL	P-13	S1R6PTFITCHI	P-8	S1R8PT2NKL	P-10	S1SPMAX	O-7,P-15
S1PT4X4ALJ	P-13	S1R6PTNKL	P-11	S1R8PT3ALU	P-10	S1SPORT	O-7,P-15
S1PT4X4BL	P-13	S1R6PTWZALU	P-11	S1R8PT3BLK	P-10	S1SPSL2IM	O-7,P-15
S1PT4X4BLJ	P-13	S1R6PTWZBLK	P-11	S1R8PT3BRS	P-10	S1SPTL	O-7,P-15
S1PT4X4BRS	P-13	S1R6PTWZBRS	P-11	S1R8PT3BRZ	P-10	S1SPTRAC	O-7,P-15

# Catalog Number Index

Catalog Number	Page	Catalog Number	Page	Catalog Number	Page	Catalog Number	Page
S1TFCAL	O-6,P-14	SA5013	O-24	SBP771	N-18	SECP13GA	V-83
S1TFCBL	O-6,P-14	SA5016	O-8,O-24	SBP8	N-6	SECP16BA	V-83
S1TFCBRS	O-6,P-14	SA5017A	O-24	SBP82	N-6	SECP16GA	V-83
S1TFCGY	O-6,P-14	SA5017G	O-11,O-24	SBSB1A	H-10	SECP21BA	V-83
S1TFCI	O-6,P-14	SA5020	O-24	SBSB2	H-10	SECP21GA	V-83
S2425	O-11,O-13,O-20	SA5025	O-24	SBT1A	H-10	SECP29BA	V-83
S2525	O-8,O-9,O-20	SA6685	O-21	SBTL2	H-10	SECP29GA	V-83
S2625	O-11,O-13,O-20	SA6686	O-21	SC10	W-9	SECP36BA	V-83
S2725	O-8,O-9,O-20	SA6687	O-21	SC3098A	O-21	SECP36GA	V-83
S2825	O-11,O-13,O-20	SA6688	O-21	SC3099A	O-21	SECP7BA	V-83
S2925	O-8,O-9,O-20	SA7	A-46,B-48,N-6	SCB100	H-11	SECP7GA	V-83
S3061	O-25	SA720	N-7	SCB50	H-11	SECP9BA	V-83
S3079	O-9	SA723	A-48,N-7	SCBC	H-11	SECP9GA	V-83
S3082	O-8,O-9,O-20	SA8	A-46,B-48,N-6	SCC06	H-11	SEHBL3	B-37,B-68
S3083	O-12,O-13	SA82	N-6	SCC50	H-11	SETL3	B-37
S3084	O-12,O-13	SAA12	G-11	SCH1	N-5	SF15ST	W-3
S3085	O-12,O-13	SAA34	G-11	SCH12	N-15	SF2525	O-8,O-9,O-20
S3182	O-9,O-20	SAB100	G-11,G-32	SCH13	N-8	SF2725	O-8,O-9,O-20
S3325	O-8,O-9,O-20	SAB12	B-68,G-11,G-32	SCH18	N-11	SF2925	O-8,O-9,O-20
S3425	O-20	SAB34	B-68,G-11,G-32	SCH2	N-5	SF35FFBK	W-4
S3525	O-8,O-9,O-20	SAC100	G-11,G-32	SCH23	N-8	SF35FFEI	W-4
S3625	O-11,O-13,O-20	SAC125	G-11,G-32	SCH26	N-10,X-6	SF35FFGY	W-4
S3725	O-8,O-9,O-20	SAC34	G-11	SCH262	N-10,X-6	SF35FFLA	W-4
S3813	O-11,O-13,O-20	SAD125	G-11,G-32	SCH3	N-5	SF35FFOW	W-4
S3825	O-11,O-13,O-20	SAD150	G-11,G-32	SCH7	N-6	SF35FFW	W-4
S3826	O-11,O-13,O-20	SB1	D-15,N-5,Y-42	SCH702	N-7	SF35SJ	W-4
S3925	O-8,O-9,O-20	SB12	N-15	SCH723	N-7,X-19	SF35SJAL	R-46
S5002	O-24	SB126	N-11,X-7,Y-42	SCH8	N-6	SF35SJBK	W-4
S5003	O-24	SB13	N-8,Y-42	SCH82	N-6	SF35SJEI	W-4
S5007	O-24	SB14	N-8,Y-42	SCSB0	H-10	SF35SJGY	R-46,W-4
S5010	O-24	SB18	Y-42	SCSB0M2	H-10	SF35SJLA	W-4
S5012	O-24	SB2	D-15,N-5,Y-42	SCTL0	H-10	SF35SJW	W-4
S5013	O-24	SB23	N-8	SCTL0M2	H-10	SF35STBK	W-4
S5016	O-8,O-24	SB26	A-46,D-15,N-10,X-6	SDSB1A	H-10	SF35STEI	W-4
S5017A	O-24	SB262	D-15,N-10,X-6,Y-42	SE2720A	B-37	SF35STGY	W-4
S5017G	O-11,O-24	SB3	N-5	SE2730A	B-37	SF35STLA	W-4
S5020	O-24	SB3083	O-11,O-12,O-13	SEC100BA	V-83	SF35STOW	W-4
S5025	O-24	SB3083W	O-11,O-20	SEC100BSMH9	V-84	SF35STW	W-4
S5030	O-24	SB3084	O-11,O-12,O-13	SEC100GA	V-83	SF3925	O-8,O-9,O-20
SA1	D-15,N-5	SB3084W	O-11,O-20	SEC125BSMH13	V-84	SF39253A	O-8
SA13A	N-8	SB3085	O-11,O-12,O-13	SEC38BA	V-83	SFB10	R-63,W-4
SA2	D-15,N-5	SB3085W	O-11,O-20	SEC38GA	V-83	SFBAL	R-46
SA23	N-8	SB4	N-5	SEC50B252	V-84	SFBAL10	R-46,W-4
SA2425	O-11,O-13,O-20	SB5	N-5	SEC50B356	V-84	SFBB10	W-4
SA2525	O-8,O-9,O-20	SB6	N-5	SEC50BA	V-83	SFBBK	W-4
SA2625	O-11,O-13,O-20	SB7	A-46,B-48,N-6,Y-42	SEC50GA	V-83	SFBE10	W-4
SA2725	O-8,O-9,O-20	SB701	A-49	SEC75B352	V-84	SFBEI	W-4
SA2925	O-8,O-9,O-20	SB720	B-50,B-52,N-7	SEC75B452	V-84	SFBG10	R-46,W-4
SA3082	O-8,O-9,O-20	SB771	N-18	SEC75BA	V-83	SFBGBK	W-4
SA3083	O-11,O-12,O-13	SB8	A-46,B-48,N-6,Y-42	SEC75GA	V-83	SFBGEI	W-4
SA3083W	O-11,O-20	SB82	N-6,Y-42	SECM12B	V-83	SFBGGY	W-4
SA3084	O-11,O-12,O-13	SB826	N-11,X-7	SECM12G	V-83	SFBGLA	W-4
SA3084W	O-11,O-20	SBP1	N-5	SECM16B	V-83	SFBGOW	W-4
SA3085	O-11,O-12,O-13	SBP12	N-15	SECM16G	V-83	SFBGW	W-4
SA3085W	O-11,O-20	SBP126	N-11,X-7	SECM20B	V-83	SFBGY	R-46,W-4
SA3182	O-9,O-20	SBP13	N-8	SECM20G	V-83	SFBLA	W-4
SA3625	O-11,O-13,O-20	SBP18	N-11	SECM25B	V-83	SFBLA10	W-4
SA3725	O-8,O-9,O-20	SBP2	N-5	SECM25G	V-83	SFBOW	R-63,W-4
SA3813	O-11,O-13,O-20	SBP26	N-10,X-6	SECM32B	V-83	SFBW	W-4
SA3825	O-11,O-13,O-20	SBP262	N-10,X-6	SECM32G	V-83	SFBW10	W-4
SA3826	O-11,O-13,O-20	SBP263	N-10,X-6	SECM40B	V-83	SFC5EBK	W-4
SA3925	O-8,O-9,O-20	SBP28	N-13	SECM40G	V-83	SFC5EW	W-4
SA5007	O-24	SBP3	D-15,N-5	SECP11BA	V-83	SFC6EBK	W-4
SA5010	O-24	SBP4	N-5	SECP11GA	V-83	SFC6EW	W-4
SA5012	O-24	SBP7	N-6	SECP13BA	V-83	SFFALX	R-46,W-3

# Catalog Number Index

Catalog Number	Page	Catalog Number	Page	Catalog Number	Page	Catalog Number	Page
SFFBX	W-3	SFRCORRXX	W-3	SFST	R-63	SHC1023ZP	V-78
SFFEX	W-3	SFRCORXX	W-3	SFSV110AL	R-46	SHC1024	V-78
SFFGAL	R-46,W-3	SFRCR	W-3	SFSV110BK	R-63,W-3	SHC1024CR	V-78
SFFGBK	W-3,X-9,Y-43	SFRCRFF	W-3	SFSV110GY	R-46	SHC1024SS	V-78
SFFGEI	W-3,X-9,Y-43	SFRCRFFAL	R-46	SFSVAL	R-46	SHC1024ZP	V-78
SFFGGY	R-46,W-3,X-9	SFRCRFFBK	W-22,X-9	SFSVBK	W-3	SHC1025	V-78
SFFGLA	W-3,X-9	SFRCRFFEI	W-22,X-9	SFSVGY	R-46	SHC1026	V-78
SFFGOW	W-3	SFRCRFFGY	R-46,W-22,X-9	SFUSBAA3BK	W-4	SHC1027	V-78
SFFGW	W-3,X-9,Y-43	SFRCRFFLA	W-22,X-9	SFUSBAAB	W-4	SHC1027ZP	V-78
SFFGX	R-46,W-3	SFRCRFFW	W-22,X-9	SFUSBAAOW	W-4	SHC1028	V-78
SFFLAX	W-3	SFRCRFFX	W-3	SFUSBAAW	W-4	SHC1028ZP	V-78
SFFWX	W-3	SFRCRRBK	W-22,X-9	SFUSBAB3BK	W-4	SHC1029	V-79
SFFX	R-63,W-3	SFRCRREI	W-22,X-9	SFUSBABB	W-4	SHC1030	V-79
SFGRFAL	W-3	SFRCRRGY	W-22,X-9	SFUSBABOW	W-4	SHC1030ZP	V-79
SFGRFBK	W-3,W-22,X-9	SFRCRRLA	W-22,X-9	SFUSBABW	O-38,W-4,W-14	SHC1031	V-79
SFGRFEI	W-3,W-22,X-9	SFRCRRW	W-22,X-9	SHC1001CR	V-78	SHC1031ZP	V-79
SFGRFGY	W-3,W-22,X-9	SFRCRRXX	W-3	SHC1002	V-78	SHC1032	V-79
SFGRFLA	W-22,X-9	SFRCRXX	W-3	SHC1002CR	V-78	SHC1032ZP	V-79
SFGRFOW	W-3	SFRCRW	W-3	SHC1003	V-78	SHC1033	V-79
SFGRFW	W-3,W-22,X-9	SFRCWFF	W-3	SHC1003CR	V-78	SHC1033ZP	V-79
SFHC14BK	W-7,W-14	SFRCWFFAL	R-46	SHC1003SS	V-78	SHC1034	V-79
SFHC14W	O-38,W-7,W-14	SFRCWFFBK	W-22,X-9	SHC1004	V-78	SHC1034ZP	V-79
SFRC	W-3	SFRCWFFEI	W-22,X-9	SHC1004CR	V-78	SHC1035CR	C-11,H-13,V-79
SFRC110B	W-3	SFRCWFFGY	R-46	SHC1004SS	V-78	SHC1035SS	V-79
SFRC110GN	W-3	SFRCWFFGY	W-22,X-9	SHC1005	V-78	SHC1035ZP	V-79
SFRC110R	R-46,R-63,W-3	SFRCWFFLA	W-22,X-9	SHC1005CR	V-78	SHC1036	V-79
SFRC110W	R-46,W-3	SFRCWFFW	W-22,X-9	SHC1006CR	V-78	SHC1036CR	C-11,H-13,V-79
SFRC110Y	R-46,W-3	SFRCWFFX	W-3	SHC1007	V-78	SHC1036SS	V-79
SFRCBFFBK	W-22,X-9	SFRCWRBK	W-22,X-9	SHC1008	V-78	SHC1037	V-79
SFRCBFFEI	W-22,X-9	SFRCWREI	W-22,X-9	SHC1008CR	V-78	SHC1037CR	C-11,H-13,V-79
SFRCBFFGY	W-22,X-9	SFRCWRGY	W-22,X-9	SHC1008ZP	V-78	SHC1037SS	V-79
SFRCBFFLA	W-22,X-9	SFRCWRLA	W-22,X-9	SHC1009	V-78	SHC1037ZP	V-79
SFRCBFFOW	W-3	SFRCWRW	W-22,X-9	SHC1009CR	V-78	SHC1038	V-79
SFRCBFFW	W-22,X-9	SFRCWRXX	W-3	SHC1009SS	V-78	SHC1038CR	V-79
SFRCBFFX	W-3	SFRCWXX	W-3	SHC1010	V-78	SHC1038SS	V-79
SFRCBKFF	W-3	SFRCY	W-3	SHC1010CR	V-78	SHC1038ZP	V-79
SFRCBKFFX	W-3	SFRCYFF	W-3	SHC1010ZP	V-78	SHC1039	V-79
SFRCBKRX	W-3	SFRCYFFAL	R-46	SHC1011	V-78	SHC1039CR	V-79
SFRCBKXX	W-3	SFRCYFFBK	W-22,X-9	SHC1011CR	V-78	SHC1040	V-79
SFRCBOW	W-3	SFRCYFFEI	W-22,X-9	SHC1011SS	V-78	SHC1040CR	V-79
SFRCBRBK	W-22,X-9	SFRCYFFGY	R-46,W-22,X-9	SHC1012	V-78	SHC1041	V-79
SFRCBREI	W-22,X-9	SFRCYFFLA	W-22,X-9	SHC1012CR	V-78	SHC1041CR	V-79
SFRCBRGY	W-22,X-9	SFRCYFFW	W-22,X-9	SHC1012SS	V-78	SHC1041SS	V-79
SFRCBRLA	W-22,X-9	SFRCYFFX	W-3	SHC1012ZP	V-78	SHC1042	V-79
SFRCBRW	W-22,X-9	SFRCYRBK	W-22,X-9	SHC1015	V-78	SHC1042CR	V-79
SFRCBRXX	W-3	SFRCYREI	W-22,X-9	SHC1016	V-78	SHC1042SS	V-79
SFRCBXX	W-3	SFRCYRGY	W-22,X-9	SHC1017	V-78	SHC1043	V-79
SFRCGNFFBK	W-22,X-9	SFRCYRLA	W-22,X-9	SHC1018	V-78	SHC1043CR	V-79
SFRCGNFFEI	W-22,X-9	SFRCYRW	W-22,X-9	SHC1019	V-78	SHC1043SS	V-79
SFRCGNFFGY	W-22,X-9	SFRCYRXX	W-3	SHC1019CR	V-78	SHC1043ZP	V-79
SFRCGNFFLA	W-22,X-9	SFRCYXX	W-3	SHC1020	V-78	SHC1044	V-79
SFRCGNFFOW	W-3	SFRFGBK	W-3	SHC1020CR	V-78	SHC1044CR	V-79
SFRCGNFFW	W-22,X-9	SFRFGEI	W-3	SHC1020SS	V-78	SHC1044SS	V-79
SFRCGNFFX	W-3	SFRFGGY	W-3	SHC1020ZP	V-78	SHC1046	V-80
SFRCGNOW	W-3	SFRFGOW	W-3	SHC1021	V-78	SHC1047	V-80
SFRCGNRBK	W-22,X-9	SFRFGW	W-3	SHC1021CR	V-78	SHC1048	V-80
SFRCGNREI	W-22,X-9	SFSBAL10	W-4	SHC1021SS	V-78	SHC1049	V-80
SFRCGNRGY	W-22,X-9	SFSBBK10	W-4,W-22,X-9	SHC1021ZP	V-78	SHC1050	V-80
SFRCGNRLA	W-22,X-9	SFSBEI10	W-4,W-22,X-9	SHC1022	V-78	SHC1051	V-80
SFRCGNRW	W-22,X-9	SFSBGY10	W-4,W-22,X-9	SHC1022CR	V-78	SHC1052	V-80
SFRCGNRX	W-3	SFSBLA10	W-4,W-22,X-9	SHC1022SS	V-78	SHC1052ZP	V-80
SFRCGNXX	W-3	SFSBOW10	W-4	SHC1022ZP	V-78	SHC1053	V-80
SFRCORFFOW	W-3	SFSBW10	W-4,W-22,X-9	SHC1023	V-78	SHC1053ZP	V-80
SFRCORFFX	W-3	SFSPGBK	R-46,W-4	SHC1023CR	V-78	SHC1054	V-80
SFRCOROW	W-3	SFSPGR	R-46,W-4	SHC1023SS	V-78	SHC1054ZP	V-80

# Catalog Number Index

Catalog Number	Page	Catalog Number	Page	Catalog Number	Page	Catalog Number	Page
SHC1055	V-80	SHCM301037	V-82	SNAP2101ILWNA	D-5	SNAP2152L	A-16
SHC1056	V-80	SK2	B-51	SNAP2101INA	D-5	SNAP2152LAA	A-16
SHC1057	V-80	SK3	B-53	SNAP2101LANA	D-5	SNAP2152LAL	A-16
SHC1057ZP	V-80	SLK	H-11	SNAP2101PLBKNA	D-5	SNAP2152LALTR	A-16
SHC1058	V-80	SLKG	H-11	SNAP2101PLINA	D-5	SNAP2152LATR	A-16
SHC1058ZP	V-80	SNAP1201BKNA	D-4	SNAP2101PLRNA	D-5	SNAP2152LTR	A-16
SHC1059	V-80	SNAP1201BRNA	D-4	SNAP2101PLWNA	D-5	SNAP2152RA	A-16
SHC1059ZP	V-80	SNAP1201GYNA	D-4	SNAP2101RNA	D-5	SNAP2152RL	A-16
SHC1061	V-80	SNAP1201ILBKNA	D-4	SNAP2101WNA	D-5	SNAP2152RLTR	A-16
SHC1062	V-80	SNAP1201ILINA	D-4	SNAP2103BKNA	D-5	SNAP2152RTR	A-16
SHC1063	V-80	SNAP1201ILRNA	D-4	SNAP2103BRNA	D-5	SNAP2152TR	A-16
SHC1064	V-80	SNAP1201ILWNA	D-4	SNAP2103GYNA	D-5	SNAP2152WA	A-16
SHC1065	V-80	SNAP1201INA	D-4	SNAP2103ILBKNA	D-5	SNAP2152WL	A-16
SHC1066	V-80	SNAP1201LANA	D-4	SNAP2103ILINA	D-5	SNAP2152WLTR	A-16
SHC1067	V-80	SNAP1201PLBKNA	D-4	SNAP2103ILRNA	D-5	SNAP2152WTR	A-16
SHC1068	V-80	SNAP1201PLINA	D-4	SNAP2103ILWNA	D-5	SNAP2162A	A-16
SHC1069	V-80	SNAP1201PLRNA	D-4	SNAP2103INA	D-5	SNAP2162BKA	A-16
SHC1070	V-80	SNAP1201PLWNA	D-4	SNAP2103LANA	D-5	SNAP2162BKL	A-16
SHC1071	V-80	SNAP1201RNA	D-4	SNAP2103RNA	D-5	SNAP2162BKLTR	A-16
SHC1072	V-80	SNAP1201WNA	D-4	SNAP2103WNA	D-5	SNAP2162BKTR	A-16
SHC1073	V-80	SNAP1203BKNA	D-4	SNAP2121BKNA	D-5	SNAP2162BLL	A-16
SHC1074	V-80	SNAP1203BRNA	D-4	SNAP2121BRNA	D-5	SNAP2162BLLTR	A-16
SHC1076	V-80	SNAP1203GYNA	D-4	SNAP2121GYNA	D-5	SNAP2162BLTR	A-16
SHC1077	V-80	SNAP1203ILBKNA	D-4	SNAP2121ILBKNA	D-5	SNAP2162GYA	A-16
SHC1078	V-80	SNAP1203ILINA	D-4	SNAP2121ILINA	D-5	SNAP2162GYL	A-16
SHC1079	V-80	SNAP1203ILRNA	D-4	SNAP2121ILRNA	D-5	SNAP2162GYLTR	A-16
SHC1080	V-80	SNAP1203ILWNA	D-4	SNAP2121ILWNA	D-5	SNAP2162GYTR	A-16
SHC1081	V-80	SNAP1203INA	D-4	SNAP2121INA	D-5	SNAP2162IA	A-16
SHC1086	V-80	SNAP1203LANA	D-4	SNAP2121LANA	D-5	SNAP2162IGL	M-13
SHC1088	V-80	SNAP1203RNA	D-4	SNAP2121PLBKNA	D-5	SNAP2162IGLTR	M-13
SHC1089	V-80	SNAP1203WNA	D-4	SNAP2121PLINA	D-5	SNAP2162IGTR	M-13
SHC1090	V-80	SNAP1221BKNA	D-4	SNAP2121PLRNA	D-5	SNAP2162IL	A-16
SHC1091	V-80	SNAP1221BRNA	D-4	SNAP2121PLWNA	D-5	SNAP2162ILTR	A-16
SHC1092	V-80	SNAP1221GYNA	D-4	SNAP2121RNA	D-5	SNAP2162ITR	A-16
SHC1093	V-80	SNAP1221ILBKNA	D-4	SNAP2121WNA	D-5	SNAP2162L	A-16
SHC1094	V-80	SNAP1221ILINA	D-4	SNAP2123BKNA	D-5	SNAP2162LAA	A-16
SHC1095	V-80	SNAP1221ILRNA	D-4	SNAP2123BRNA	D-5	SNAP2162LAL	A-16
SHC1097ZP	V-79	SNAP1221ILWNA	D-4	SNAP2123GYNA	D-5	SNAP2162LALTR	A-16
SHC1098ZP	V-79	SNAP1221INA	D-4	SNAP2123ILBKNA	D-5	SNAP2162LATR	A-16
SHC1099ZP	V-79	SNAP1221LANA	D-4	SNAP2123ILINA	D-5	SNAP2162LTR	A-16
SHC2005CR	V-78	SNAP1221PLBKNA	D-4	SNAP2123ILRNA	D-5	SNAP2162RA	A-16
SHC2008CR	V-78	SNAP1221PLINA	D-4	SNAP2123ILWNA	D-5	SNAP2162RL	A-16
SHC2010CR	V-78	SNAP1221PLRNA	D-4	SNAP2123INA	D-5	SNAP2162RLTR	A-16
SHC2011CR	V-78	SNAP1221PLWNA	D-4	SNAP2123LANA	D-5	SNAP2162RTR	A-16
SHC2012CR	V-78	SNAP1221RNA	D-4	SNAP2123RNA	D-5	SNAP2162TR	A-16
SHC2021CR	V-78	SNAP1221WNA	D-4	SNAP2123WNA	D-5	SNAP2162WA	A-16
SHC2022CR	V-78	SNAP1223BKNA	D-4	SNAP2152A	A-16	SNAP2162WL	A-16
SHC2023CR	V-78	SNAP1223BRNA	D-4	SNAP2152BKA	A-16	SNAP2162WLTR	A-16
SHC2024CR	V-78	SNAP1223GYNA	D-4	SNAP2152BKL	A-16	SNAP2162WTR	A-16
SHC2035CR	V-79	SNAP1223ILBKNA	D-4	SNAP2152BKLTR	A-16	SNAP2172A	A-5,L-5
SHC2036CR	V-79	SNAP1223ILINA	D-4	SNAP2152BKTR	A-16	SNAP2172BKA	A-5,L-5
SHC2037CR	V-79	SNAP1223ILRNA	D-4	SNAP2152BLL	A-16	SNAP2172BKL	A-5,L-5
SHC2038CR	V-79	SNAP1223ILWNA	D-4	SNAP2152BLLTR	A-16	SNAP2172BKLTR	A-5,L-5
SHC2040CR	V-79	SNAP1223INA	D-4	SNAP2152BLTR	A-16	SNAP2172BKTR	A-5,L-5
SHC2041CR	V-79	SNAP1223LANA	D-4	SNAP2152GYA	A-16	SNAP2172GYA	A-5,L-5
SHC2042CR	V-79	SNAP1223RNA	D-4	SNAP2152GYL	A-16	SNAP2172GYL	A-5,L-5
SHC2043CR	V-79	SNAP1223WNA	D-4	SNAP2152GYLTR	A-16	SNAP2172GYLTR	A-5,L-5
SHC2044CR	V-79	SNAP1RA	A-4,K-9,M-13	SNAP2152GYTR	A-16	SNAP2172GYTR	A-5,L-5
SHCM161011	V-82	SNAP1RNA	A-4,K-9,L-4	SNAP2152IA	A-16	SNAP2172IA	A-5,L-5
SHCM201017	V-82	SNAP2101BKNA	D-5	SNAP2152IGL	M-13	SNAP2172IGL	L-5
SHCM201022	V-82	SNAP2101BRNA	D-5	SNAP2152IGLTR	M-13	SNAP2172IGL	A-5,M-13
SHCM201023	V-82	SNAP2101GYNA	D-5	SNAP2152IGTR	M-13	SNAP2172IGLTR	L-5
SHCM201024	V-82	SNAP2101ILBKNA	D-5	SNAP2152IL	A-16	SNAP2172IGLTR	A-5,M-13
SHCM251033	V-82	SNAP2101ILINA	D-5	SNAP2152ILTR	A-16	SNAP2172IGTR	L-5
SHCM251034	V-82	SNAP2101ILRNA	D-5	SNAP2152ITR	A-16	SNAP2172IGTR	A-5,M-13

# Catalog Number Index

Catalog Number	Page	Catalog Number	Page	Catalog Number	Page	Catalog Number	Page
SNAP2172IL	A-5,L-5	SNAP5262BKL	A-15	SNAP5362RA	A-15	SNAP8300GYTR	A-4,L-4
SNAP2172ILTR	A-5,L-5	SNAP5262BKLTR	A-15	SNAP5362RL	A-15	SNAP8300IA	A-4,L-4
SNAP2172ITR	A-5,L-5	SNAP5262BKTR	A-15	SNAP5362RLTR	A-15	SNAP8300IGL	L-4
SNAP2172L	A-5,L-5	SNAP5262BLL	A-15	SNAP5362RTR	A-15	SNAP8300IGL	A-4,M-13
SNAP2172LAA	A-5,L-5	SNAP5262BLLTR	A-15	SNAP5362S	M-13	SNAP8300IGLTR	L-4
SNAP2172LAL	A-5,L-5	SNAP5262BLTR	A-15	SNAP5362TR	A-15	SNAP8300IGLTR	A-4,M-13
SNAP2172LALTR	A-5,L-5	SNAP5262GYA	A-15	SNAP5362WA	A-15	SNAP8300IGTR	L-4
SNAP2172LATR	A-5,L-5	SNAP5262GYL	A-15	SNAP5362WL	A-15	SNAP8300IGTR	A-4,M-13
SNAP2172LTR	A-5,L-5	SNAP5262GYLTR	A-15	SNAP5362WLTR	A-15	SNAP8300IL	A-4,L-4
SNAP2172RA	A-5,L-5	SNAP5262GYS	M-13	SNAP5362WS	M-13	SNAP8300ILTR	A-4,L-4
SNAP2172RIGL	L-5	SNAP5262GYTR	A-15	SNAP5362WTR	A-15	SNAP8300ITR	A-4,L-4
SNAP2172RIGL	A-5,M-13	SNAP5262IA	A-15	SNAP8200A	A-4,L-4	SNAP8300L	A-4,L-4
SNAP2172RIGLTR	L-5	SNAP5262IGL	M-13	SNAP8200BKA	A-4,L-4	SNAP8300LAA	A-4,L-4
SNAP2172RIGLTR	A-5,M-13	SNAP5262IGLTR	M-13	SNAP8200BKL	A-4,L-4	SNAP8300LAL	A-4,L-4
SNAP2172RIGTR	A-5,M-13	SNAP5262IGTR	M-13	SNAP8200BKLTR	A-4,L-4	SNAP8300LALTR	A-4,L-4
SNAP2172RIGTR	A-5,M-13	SNAP5262IL	A-15	SNAP8200BKTR	A-4,L-4	SNAP8300LATR	A-4,L-4
SNAP2172RL	A-5,L-5	SNAP5262ILTR	A-15	SNAP8200GYA	A-4,L-4	SNAP8300LTR	A-4,L-4
SNAP2172RLTR	A-5,L-5	SNAP5262IS	M-13	SNAP8200GYL	A-4,L-4	SNAP8300RA	A-4,L-4
SNAP2172RTR	A-5,L-5	SNAP5262ITR	A-15	SNAP8200GYLTR	A-4,L-4	SNAP8300RIGL	L-4
SNAP2172TR	A-5,L-5	SNAP5262L	A-15	SNAP8200GYTR	A-4,L-4	SNAP8300RIGL	A-4,M-13
SNAP2172WA	A-5,L-5	SNAP5262LAA	A-15	SNAP8200IA	A-4,L-4	SNAP8300RIGLTR	L-4
SNAP2172WL	A-5,L-5	SNAP5262LAL	A-15	SNAP8200IGL	L-4	SNAP8300RIGLTR	A-4,M-13
SNAP2172WLTR	A-5,L-5	SNAP5262LALTR	A-15	SNAP8200IGL	A-4,M-13	SNAP8300RIGTR	L-4
SNAP2172WTR	A-5,L-5	SNAP5262LAS	M-13	SNAP8200IGLTR	L-4	SNAP8300RIGTR	A-4,M-13
SNAP2182A	A-5,L-5	SNAP5262LATR	A-15	SNAP8200IGLTR	A-4,M-13	SNAP8300RL	A-4,L-4
SNAP2182BKA	A-5,L-5	SNAP5262LTR	A-15	SNAP8200IGTR	L-4	SNAP8300RLTR	A-4,L-4
SNAP2182BKL	A-5,L-5	SNAP5262RA	A-15	SNAP8200IGTR	A-4,M-13	SNAP8300RTR	A-4,L-4
SNAP2182BKLTR	A-5,L-5	SNAP5262RL	A-15	SNAP8200IGTR	A-4,M-13	SNAP8300TR	A-4,L-4
SNAP2182BKTR	A-5,L-5	SNAP5262RLTR	A-15	SNAP8200IL	A-4,L-4	SNAP8300WA	A-4,L-4
SNAP2182GYA	A-5,L-5	SNAP5262RTR	A-15	SNAP8200ILTR	A-4,L-4	SNAP8300WL	A-4,L-4
SNAP2182GYL	A-5,L-5	SNAP5262S	M-13	SNAP8200ITR	A-4,L-4	SNAP8300WTR	A-4,L-4
SNAP2182GYLTR	A-5,L-5	SNAP5262TR	A-15	SNAP8200L	A-4,L-4	SNAP8362GYL	L-16,M-13
SNAP2182GYTR	A-5,L-5	SNAP5262WA	A-15	SNAP8200LAA	A-4,L-4	SNAP8362IS	L-16,M-13
SNAP2182IA	A-5,L-5	SNAP5262WA	A-15	SNAP8200LAL	A-4,L-4	SNAP8362LAS	L-16,M-13
SNAP2182IGL	A-5,M-13	SNAP5262WL	A-15	SNAP8200LALTR	A-4,L-4	SNAP8362RS	L-16,M-13
SNAP2182IGLTR	A-5,M-13	SNAP5262WLTR	A-15	SNAP8200LATR	A-4,L-4	SNAP8362S	L-16,M-13
SNAP2182IGTR	A-5,M-13	SNAP5262WS	M-13	SNAP8200LTR	A-4,L-4	SNAP8362WS	L-16,M-13
SNAP2182IL	A-5,L-5	SNAP5262WTR	A-15	SNAP8200RA	A-4,L-4	SNAPS1NA	D-4,D-5
SNAP2182ILTR	A-5,L-5	SNAP5362A	A-15	SNAP8200RIGL	L-4	SNAPS2NA	D-4,D-5
SNAP2182ITR	A-5,L-5	SNAP5362BKA	A-15	SNAP8200RIGL	A-4,M-13	SNAPSPP1NA	D-4,D-5
SNAP2182L	A-5,L-5	SNAP5362BKLTR	A-15	SNAP8200RIGLTR	L-4	SNAPSPP2NA	D-4,D-5
SNAP2182LAA	A-5,L-5	SNAP5362BKTR	A-15	SNAP8200RIGTR	A-4,M-13	SNAPSWJUMP	D-4,D-5
SNAP2182LAL	A-5,L-5	SNAP5362BLL	A-15	SNAP8200RIGTR	A-4,M-13	SP14AL	N-8,R-45
SNAP2182LALTR	A-5,L-5	SNAP5362BLLTR	A-15	SNAP8200RL	A-4,L-4	SP14BAL	N-8,R-45
SNAP2182LATR	A-5,L-5	SNAP5362BLTR	A-15	SNAP8200RLTR	A-4,L-4	SP14BG	N-8,R-45
SNAP2182LTR	A-5,L-5	SNAP5362GYA	A-15	SNAP8200RTR	A-4,L-4	SP14G	N-8,R-45
SNAP2182RA	A-5,L-5	SNAP5362GYL	A-15	SNAP8200TR	A-4,L-4	SP18AL	N-11,R-45
SNAP2182RIGL	A-5,M-13	SNAP5362GYLTR	A-15	SNAP8200WA	A-4,L-4	SP18G	N-11,R-45
SNAP2182RIGLTR	A-5,M-13	SNAP5362GYS	M-13	SNAP8200WL	A-4,L-4	SP1AL	N-5,R-45
SNAP2182RIGTR	A-5,M-13	SNAP5362GYTR	A-15	SNAP8200WLTR	A-4,L-4	SP1G	N-5,R-45
SNAP2182RL	A-5,L-5	SNAP5362IA	A-15	SNAP8200WTR	A-4,L-4	SP24AL	N-8,R-45
SNAP2182RLTR	A-5,L-5	SNAP5362IGL	M-13	SNAP8262GYS	L-16,M-13	SP24BAL	N-8,R-45
SNAP2182RTR	A-5,L-5	SNAP5362IGLTR	M-13	SNAP8262IS	L-16,M-13	SP24BG	N-8,R-45
SNAP2182TR	A-5,L-5	SNAP5362IGTR	M-13	SNAP8262LAS	L-16,M-13	SP24G	N-8,R-45
SNAP2182WA	A-5,L-5	SNAP5362IGTR	M-13	SNAP8262RS	L-16,M-13	SP28AL	N-13,R-45
SNAP2182WL	A-5,L-5	SNAP5362IL	A-15	SNAP8262S	L-16,M-13	SP28G	N-13,R-45
SNAP2182WLTR	A-5,L-5	SNAP5362ILTR	A-15	SNAP8262WS	L-16,M-13	SP2AL	N-5,R-45
SNAP2182WTR	A-5,L-5	SNAP5362IS	M-13	SNAP8300A	A-4,L-4	SP2G	N-5,R-45
SNAP2RA	A-4,A-15,K-9	SNAP5362ITR	A-15	SNAP8300BKA	A-4,L-4	SP34AL	N-8,R-45
SNAP2RNA	A-4,A-15,K-9	SNAP5362L	A-15	SNAP8300BKL	A-4,L-4	SP34BAL	N-8,R-45
SNAP3W1NA	D-4,D-5	SNAP5362LAA	A-15	SNAP8300BKLTR	A-4,L-4	SP3AL	N-5,R-45
SNAP3W2NA	D-4,D-5	SNAP5362LAL	A-15	SNAP8300BKTR	A-4,L-4	SP4AL	N-5,R-45
SNAP3WJUMP	D-4,D-5	SNAP5362LALTR	A-15	SNAP8300GYA	A-4,L-4	SP5AL	N-5,R-45
SNAP5262A	A-15	SNAP5362LAS	M-13	SNAP8300GYL	A-4,L-4	SP6AL	N-5,R-45
SNAP5262BKA	A-15	SNAP5362LATR	A-15	SNAP8300GYLTR	A-4,L-4		
		SNAP5362LTR	A-15				



# Catalog Number Index

Catalog Number	Page	Catalog Number	Page	Catalog Number	Page	Catalog Number	Page
SP7AL	N-6,R-45	SS2309SGYA	P-20	SS748	N-6	TB5	F-24
SP7G	N-6,R-45	SS2309SLBKA	P-20	SS749	N-7	TPC100	H-12
SP82AL	N-6,R-45	SS2309SLGYA	P-20	SS750	B-60,Y-13,Y-15	TPC50	H-12
SP82G	N-6,R-45	SS2309TBKA	P-20	SS771	N-18	TPDL	H-12
SP83AL	N-6,R-45	SS2309TGYA	P-20	SS78	N-11	TPDS	H-12
SP8AL	N-6,R-45	SS23L	N-8	SS7L	B-48,B-63,N-6	TPF1BK	W-6
SP8G	N-6,R-45	SS24	N-8	SS8	A-46,B-48,N-6	TPF1GY	W-6
SPB1	H-14	SS24L	N-8	SS8147	N-13	TPF1OW	W-6
SPB2	H-14	SS26	A-46,D-15,N-10	SS82	N-6,O-21,Y-42	TPF1W	W-6
SPLITTER332	O-29	SS262	D-15,N-10,O-21,X-6	SS826	N-11,X-7	TTBDS1AL	O-35
SPLITTER422	O-29	SS262L	D-15,N-10,X-6	SS82L	N-6	TTBDS1BK	O-35
SPOWI/D10S	S-7	SS263	D-15,N-10,X-6	SS82MEV	N-17	TTBDS1BR	O-35
SPOWI/D12S	S-7	SS264	N-10,X-6	SS83	N-6	TTBDS2AL	O-35
SPOWI/D18S	S-7	SS265	N-10,X-6	SS84	N-6	TTBDS2BK	O-35
SPOWSWI/D10S	S-7	SS266	N-10,X-6	SS8720	N-11	TTBDS2BR	O-35
SPOWSWI/D12S	S-7	SS26L	D-15,N-10,X-6	SS8L	B-48,N-6	TTBKSAL	O-35
SPOWSWI/D18S	S-7	SS26L	N-10,X-6	SS8MEV	N-17	TTBKSBK	O-35
SPPBK10	W-4,W-8	SS28	N-13	SSB1	D-19	TTBKSBR	O-35
SPPR10	W-4,W-8	SS2C	N-9	SSF11	W-5	TTBXLRAL	O-35
SR3050	Y-7,Y-12,Y-14	SS2L	D-15,N-5	SSF12	W-5	TTBXLRBK	O-35
SR50	H-11	SS3	D-15,N-5	SSF13	W-5	TTBXLRBR	O-35
SS1	D-15,N-5,Y-43	SS309B	O-21,P-21	SSF14	W-5	TV97	Y-31
SS11	N-15	SS309BF	O-21,P-21	SSF16	W-5	TV98	Y-31
SS113	N-12	SS309D	O-21,P-21	SSF204	W-5	TV98W	Y-31
SS114	N-12	SS309DS	O-21,P-21	SSF206	W-5	TV99	Y-31
SS11L	N-15	SS309S	O-21,P-21	SSF209	W-5	TV99W	Y-31
SS12	N-15	SS309SF	O-21,P-21	SSF212	W-5	TW25F1	H-14
SS126	N-11,X-7,Y-42	SS309T	O-21,P-21	SSFL11	W-5	TW25F2	H-14
SS126L	N-11,X-7	SS320	N-7	SSFL12	W-5	TWBP	H-14
SS12L	N-15	SS326	N-14,X-7	SSFL13	W-5	TWH	H-14
SS12RKL	N-17	SS33	N-8	SSFL14	W-5	TWLW20F	H-14
SS12RKLM	N-17	SS330	N-7	SSFL16	W-5	TWPF1GY	W-6
SS13	N-8,O-21,Y-42	SS34	N-8	SSJ1	N-16	TX0304000304T00	I-3
SS138	N-12	SS38	N-14	SSJ11	N-16	TX1002001002T00	I-3
SS13L	N-8	SS3C	N-9	SSJ126	N-16	TX1003001003T00	I-3
SS14	N-8	SS3L	D-15,N-5	SSJ13	N-16	TX1004001004T00	I-3
SS1426	N-12,X-7	SS4	N-5	SSJ18	N-16	TX1005001005T00	I-3
SS148	N-12	SS43	N-8	SSJ2	N-16	TX1006001006T00	I-3
SS14L	N-8	SS44	N-8	SSJ26	N-16	TX2002002002T00	I-2,R-68
SS17	N-12	SS4C	N-9	SSJ262	N-16	TX2003002003T00	I-2,R-68
SS18	N-11,Y-42	SS4L	N-5	SSJ7	N-16	TX2004002004T00	I-2,R-68
SS182	N-13	SS5	N-5	SSJ723	N-16	TX2005002005T00	I-2,R-68
SS18L	N-11	SS5C	N-9	SSJ8	N-16	TX2304002304T00	I-2,R-68
SS1C	N-9	SS6	N-5	SSJ82	N-16	TX2306002304A00	I-2,R-68
SS1L	D-15,N-5	SS607	N-5	SSK	H-11	TX2306002304B00	I-2,R-68
SS1ME	N-17	SS608	N-5	SSK60	H-11	TX2306002304C00	I-2,R-68
SS2	D-15,N-5,Y-42	SS6C	N-9	SWB1	A-37	TX2306002306T00	I-2,R-68
SS211	N-13	SS7	A-46,B-48,N-6	SWB2	A-37	TX3004003004T00	I-2,R-68
SS213	N-13	SS701	A-49,N-7,O-21	SWB4	A-37	UB12	I-36
SS22	N-15	SS702	N-7	SWB5	A-37	UB12E	I-36
SS226	N-13,X-7	SS703	A-48,N-7,O-21,X-19	SWP1	N-19	UB18	I-36
SS22RKL	N-17	SS703L	N-7	SWP12	N-19	UB18E	I-36
SS22RKLM	N-17	SS716	N-7	SWP126	N-19	UB30	I-36
SS23	N-8,O-21	SS72	N-6,N-20,O-21	SWP13	N-19	UB30E	I-36
SS2309BALA	P-20	SS720	B-50,N-7,O-21	SWP18	N-19	UDX1289	W-11
SS2309BBKA	P-20	SS723	A-48,N-7,X-19	SWP2	N-19	UDX24E	W-11
SS2309BGYA	P-20	SS723L	N-7	SWP23	N-19	UDX48E	W-11
SS2309DBKA	P-20	SS725	B-47,N-7,Y-10	SWP26	N-19	UFC0001	V-82
SS2309DGYA	P-20	SS737	B-65,B-68	SWP262	N-19	UFC0001CR	V-82
SS2309F1BKA	P-20	SS737	N-7	SWP28	N-19	UFC0001ZP	V-82
SS2309F1GYA	P-20	SS738	N-15	SWP8	N-19	UFC0002	V-82
SS2309FALA	P-20	SS739	N-15	SWP812	N-19	UFC0003	V-82
SS2309FBKA	P-20	SS740	N-5	SWP813	N-19	UFC0003CR	V-82
SS2309FGYA	P-20	SS741	N-15	SWP82	N-19	UFC2001CR	V-82
SS2309SBKA	P-20	SS747	N-6	TB2	F-24	UFC2003CR	V-82

# Catalog Number Index

Catalog Number	Page	Catalog Number	Page	Catalog Number	Page	Catalog Number	Page
UGP15231	A-37	WLP2500W	E-13	WSBFGROMSV	O-37		
UGP20231	A-37	WLP3000W	E-13	WSBG43UBAL	O-37		
UGRA20231	A-37	WLP450C	E-13	WSBG43UBBA	O-37		
UGRO20231	A-37	WLS1278I	E-13	WSBG43UBK	O-37		
USB10	W-9	WLS1278W	E-13	WSBG43USV	O-37		
USB15X2	A-18,X-17,Y-39	WP1	A-47,B-48,N-23	WSBH42U	O-37		
USB15X2BK	A-18,X-17,Y-39	WP2	B-50,B-52,N-23	WSBHTRBK	O-37		
USB15X2GY	A-18,X-17,Y-39	WP262E	N-27	WSBHTRBSS	O-37		
USB15X2I	A-18,X-17,Y-39	WP268E	N-27	WSBPLATE1	O-37		
USB15X2LA	A-18,X-17,Y-39	WP26E	N-27	WSBPLATE2	O-37		
USB15X2W	A-18,X-17,Y-39	WP26EH	N-27	XLR10	W-9		
USB20X2	A-18,X-17	WP26H	N-25	XLRST10	W-9		
USB20X2BK	A-18,X-17	WP26V	N-25	YC306250	Y-13		
USB20X2GY	A-18,X-17	WP700E	N-27	YC310250	Y-8		
USB20X2I	A-18,X-17	WP82E	N-27	YC312250	Y-36		
USB20X2LA	A-18,X-17	WP8E	N-27	YC314250	Y-34		
USB20X2W	A-18,X-17	WP8EH	N-27	YC406250	Y-15		
USB4	X-17	WP8H	N-25	YQ100PLUS	Y-26		
USB4BK	X-17	WP8V	N-25	YQ230	Y-26		
USB4GY	X-17	WS1000I	E-6,X-23				
USB4I	X-17	WS1000NI	E-6,X-23				
USB4LA	X-17	WS1000NW	E-6,X-23				
USB4W	X-17	WS1000W	E-6,X-23				
USB8200	A-8,L-9,X-17	WS1001I	E-6,X-23				
USB8200BK	A-8,L-9,X-17	WS1001NI	E-6,X-23				
USB8200GY	A-8,L-9,X-17	WS1001NW	E-6,X-23				
USB8200I	A-8,L-9,X-17	WS1001W	E-6,X-23				
USB8200LA	A-8,L-9,X-17	WS2000GY	E-6,X-23				
USB8200R	A-8,L-9,X-17	WS2000I	E-6,X-23				
USB8200W	A-8,L-9,X-17	WS2000LA	E-6,X-23				
USB8300	A-8,L-9,X-17	WS2000NGY	E-6,X-23				
USB8300BK	A-8,L-9,X-17	WS2000NI	E-6,X-23				
USB8300GY	A-8,L-9,X-17	WS2000NLA	E-6,X-23				
USB8300I	A-8,L-9,X-17	WS2000NW	E-6,X-23				
USB8300LA	A-8,L-9,X-17	WS2000W	E-6,X-23				
USB8300R	A-8,L-9,X-17	WS2004I	E-6,X-23				
USB8300W	A-8,L-9,X-17	WS2004NI	E-6,X-23				
VCGP100	Y-47	WS2004NW	E-6,X-23				
VHC1021	V-81	WS2004W	E-6,X-23				
VHC1022	V-81	WSBA11BK	O-36				
VHC1022ZP	V-81	WSBA11BSS	O-36				
VHC1023	V-81	WSBA2BK	O-36				
VHC1023ZP	V-81	WSBA2BSS	O-36				
VHC1024	V-81	WSBB23UBAL	O-36				
VHC1024ZP	V-81	WSBB23UBK	O-36				
VHC1035	V-81	WSBB23UBSS	O-36				
VHC1036	V-81	WSBB43UBAL	O-36				
VHC1037	V-81	WSBB43UBK	O-36				
VHC1041	V-81	WSBB43UBSS	O-36				
VHC1042	V-81	WSBBHWBK	O-36				
VHC1052	V-81	WSBC21UBK	O-36				
VHC1053	V-81	WSBC21USV	O-36				
WC310280	Y-8	WSBD21UBK	O-36				
WLAS120I	E-13	WSBE11BK	O-36				
WLAS120W	E-13	WSBE11SV	O-36				
WLAS277I	E-13	WSBE22BK	O-36				
WLAS277W	E-13	WSBE22SV	O-36				
WLC301	E-15	WSBE31UBK	O-36				
WLC302	E-15	WSBE31USV	O-36				
WLC316R	E-13	WSBECLAMP	O-36				
WLC402W	E-15	WSBF22BK	O-37				
WLCA	E-15	WSBF22SV	O-37				
WLCU301	E-15	WSBFGROMBAL	O-37				
WLDH	E-13	WSBFGROMBK	O-37				
WLP150H	E-13	WSBFGROMBSS	O-37				

# HUBBELL INCORPORATED WORLDWIDE LOCATIONS

Wiring Device - Kellems

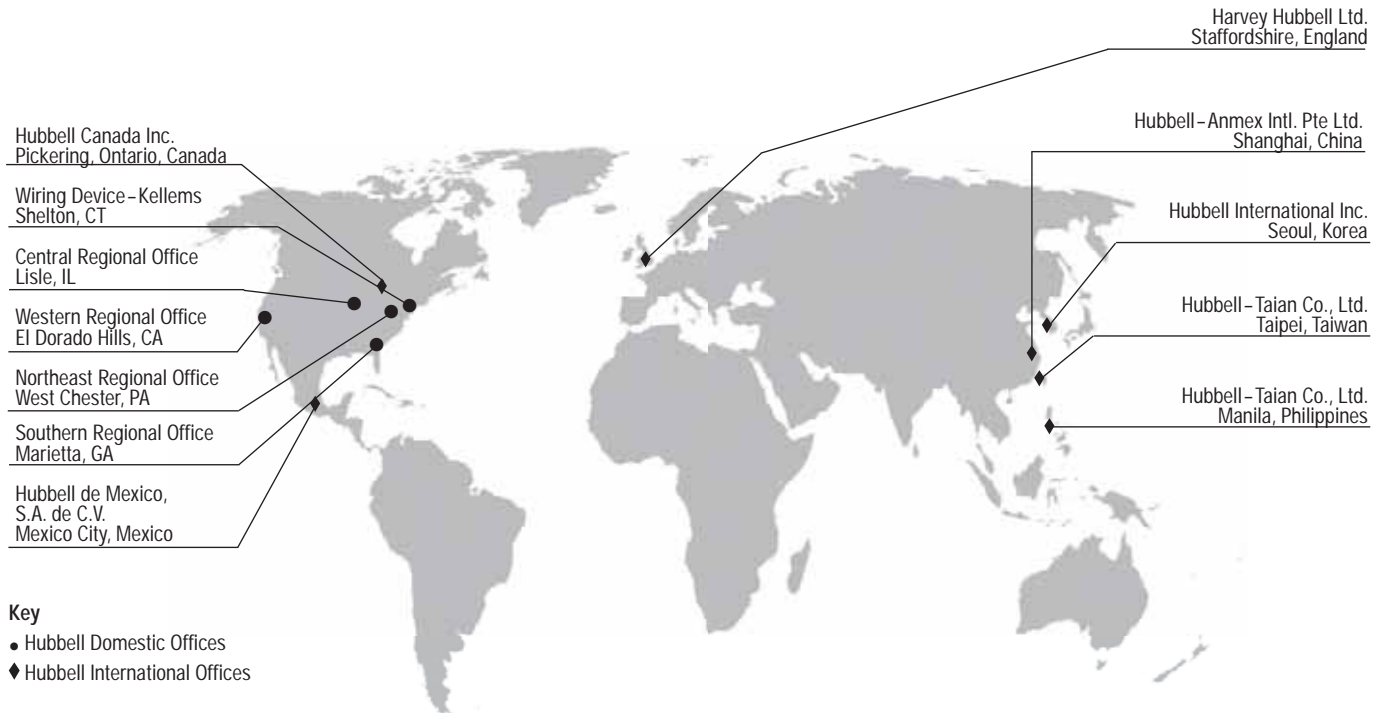

## US Offices

**Wiring Device-Kellems**  
 40 Waterview Drive  
 Shelton, CT 06484  
 Phone: (800) 288-6000  
 Fax: (800) 255-1031

**Northeast Regional Office**  
 103 S. High Street  
 West Chester, PA 19382  
 Phone: (610) 436-9652  
 (610) 436-9653  
 Fax: (610) 436-9654

**Central Regional Office**  
 801 Warrenville Road  
 Suite 245  
 Lisle, IL 60532-3601  
 Phone: (630) 810-4901  
 Fax: (630) 810-5732

**Southern Regional Office**  
 1511 Johnson Ferry Rd  
 Suite 100  
 Marietta, GA 30062  
 Phone: (770) 565-2183  
 Fax: (770) 565-3801

**Western Regional Office**  
 4960 Robert J Mathews Pkwy  
 Suite A  
 El Dorado Hills, CA 95762-5721  
 Phone: (916) 673-1980  
 Fax: (916) 673-1983

## International Offices

◆ **Hubbell Wiring Systems, Europe**  
 Brunel Drive  
 Stretton Park  
 Burton upon Trent  
 Staffordshire DE13-OBZ  
 England  
 011 (441) 283-500500 (Phone)  
 011 (441) 283-500400 (FAX)  
 www.hubbell.co.uk  
 email: sales@hubbell.co.uk

◆ **Hubbell de Mexico, S.A. de C.V.**  
 Av. Insurgentes Sur No. 1228, Piso 8  
 Col. Tlacoquemecatl del Valle  
 Mexico, D. F. 03200  
 Mexico  
 52-55-9151-9999 (Phone)  
 52-55-9151-9989 (FAX)  
 www.hubbell.com.mx  
 email: vtasdf@hubbell.com.mx

◆ **Hubbell-Taian Co., Ltd.**  
 Unit 2410 Jollibee Plaza  
 Emerald Avenue, Ortigas Center  
 San Antonio, Pasig City  
 Philippines  
 011 (632) 635-4192 to 93 (Phone)  
 011 (632) 631-2636 (FAX)  
 email:  
 sales-mktg@hubbell-taian.com.ph

◆ **Hubbell International, Inc.,  
 Korea Branch**  
 Suite 512 Hyosung Intellian 681-3  
 Deungchon Dong, Kangseo-Ku  
 Seoul 157-030, Korea  
 011 (82) 2-2607-1363 (Phone)  
 011 (82) 2-2603-7386 (FAX)  
 email: hubbell@unitel.co.kr

◆ **Hubbell Canada Inc.**  
 870 Brock Road South  
 Pickering, Ontario, Canada  
 L1W 1Z8  
 (905) 839-1138 (Phone)  
 (905) 839-9108 (FAX)  
 www.hubbell-canada.com  
 email: info@hubbell-canada.com

◆ **Hubbell-Taian Co., Ltd.**  
 6F, 156-1 Sung Chiang Rd  
 Taipei, Taiwan  
 011 (8862) 2522-1862 (Phone)  
 011 (8862) 2522-1872 (FAX)  
 email: hubbell@ms9.hinet.net

◆ **Hubbell-Anmex Intl. Pte Ltd.**  
 27-10 Millenin Tower  
 1 Temasek Ave.  
 Shanghai, 039192, China  
 011 (8621) 6275-9113 (Phone)  
 011 (8621) 6270-3959 (FAX)  
 email: hubanm@online.sh.cn

# HUBBELL

WIRING DEVICE-KELLEMS

## Hubbell Wiring Device-Kellems Your complete online resource

Find what you need quickly with our multi-functional online value-added catalog, print, zoom, search and download required information anytime, anywhere.



[www.hubbell-wiring.com](http://www.hubbell-wiring.com)

Hubbell Wiring Device-Kellems  
Hubbell Incorporated (Delaware)  
40 Waterview Drive, Shelton CT 06484  
Phone: (800) 288-6000  
Fax: (800) 255-1031  
[www.hubbell-wiring.com](http://www.hubbell-wiring.com)

Hubbell De Mexico, S.A. de C.V.  
Ave. Coyoacan No. 1051  
Col. Del Valle C.P. 03100 Mexico D. F.  
Phone: (01 55) 91 51 99 99  
Fax (01 55) 91 51 99 88  
[www.hubbell.com.mx](http://www.hubbell.com.mx)

Hubbell Canada LP  
870 Brock Road South  
Pickering, Ontario L1W 1Z8  
Phone: (800) 263-4622  
(905) 839-1138  
Fax (905) 839-9108  
[www.hubbell-canada.com](http://www.hubbell-canada.com)

**HUBBELL**<sup>®</sup>  
Wiring Systems

[www.hubbell-wiring.com](http://www.hubbell-wiring.com)



WCF2013 Printed In U.S.A. Copyright 2013, Hubbell Incorporated • Specifications subject to change without notice.

® Registered Trademark of Hubbell Incorporated. • ™ Trademark of Hubbell Incorporated.