

passive  
components  
**SELECTION GUIDE**



**KOA<sup>®</sup>**  
KOA SPEER ELECTRONICS, INC.



From  
**Concept to Reality**

Our wide range of passive component solutions will help you make the leap

Whether you're designing the car of tomorrow or connecting the Internet of Things, you need cutting-edge product solutions to bring your design to fruition. At KOA Speer, we're the ideal partner to help you do just that. Our constantly expanding line of passive components will give you the solution to make your concept a reality!

**Quality 1<sup>st</sup>**



You expect product quality from any component that makes it into one of your designs. But in today's competitive global marketplace, there's so more to the quality equation. At KOA Speer, our Quality 1st initiative reinforces our organization wide focus on serving you at the highest possible level.



Our commitment to quality in everything we do is paying off... in the past two years we've received ten major customer quality awards. We're the industry's most recognized and awarded supplier for achieving the highest product quality, on-time delivery and responsive customer service.

**ISO 9001:2015** CERTIFIED **IATF16949:2016** CERTIFIED

# KOA SPEER... More Than Just Resistors

PAGES **4-7**



## Resistors

Precision • Surge • Wide Terminal  
High Voltage • Thin Film  
High Temperature • Embedded • General Purpose  
Networks • Anti-Sulfur • Fusing • Melf

PAGES **8-9**



## Low Resistance Current Sense/Shunts

Metal Plate • Thick Film • Power Shunt  
Molded • Wide Terminal

PAGES **10-12**

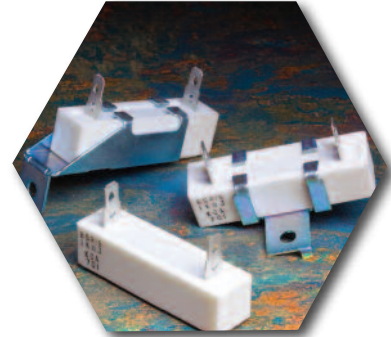

## Leaded Resistors

General Purpose Carbon Film  
Precision Metal Film • High Voltage • Power  
Wirewound • Current Sense • Networks  
Fusing • Jumpers

PAGES **13-14**

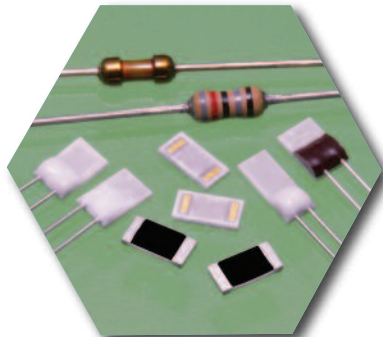

## Thermistors/Thermal Sensors

Platinum Thin Film  
Thin Film Linear PTC  
Thick Film Linear PTC  
NTC Thermistors • PTC Thermistors

PAGE **14**

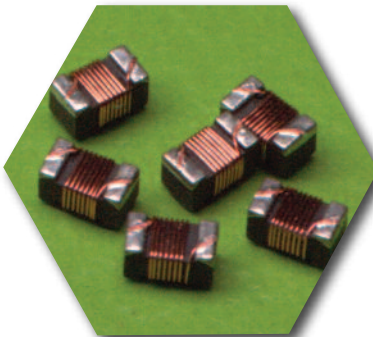

## Inductors

Chip Inductors • Power Inductors

PAGE **15**

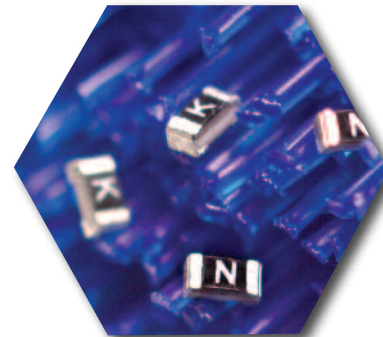

## Fuses

Thin Film • Automotive • Anti-Pulse  
Fast Blow • Anti-Surge

PAGE **15**



## Varistors

Chip Varistors • Automotive Varistors

PAGE **16**

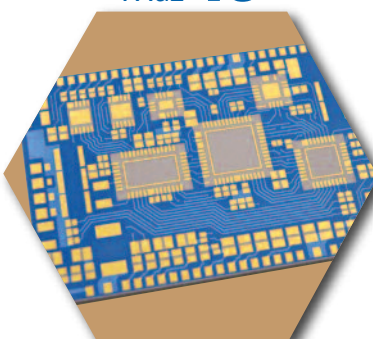

## LTCC Substrates

LTCC Substrates • Hybrid IC

PAGE **16-18**

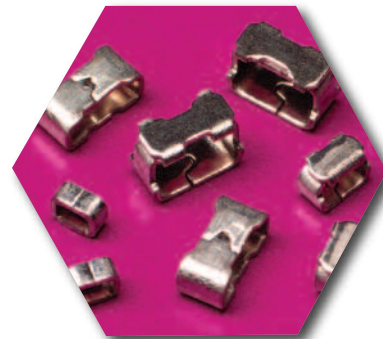

## Other Products

Check Terminal • Lab Kits

# RESISTORS

## Precision Thick Film

### RK73F-Ultra Precision Grade **NEW**

#### Low TCR Thick Film

- TCR:  $\pm 25\text{ppm}/^\circ\text{C}$
- Resistance range:  $10 \sim 1\text{M}\Omega$
- Size: 0603, 0805
- Tolerance:  $\pm 0.25\%$ ,  $\pm 0.5\%$

### RS73-Ultra Precision High **NEW**

#### Reliability Thick Film

- Excellent long-term stability with  $\Delta R$  of  $\pm 0.2\%$  &  $\pm 0.4\%$  in the reliability test
- Low TCR:  $\pm 25\text{ppm}/^\circ\text{C}$ ,  $\pm 50\text{ppm}/^\circ\text{C}$
- Tolerance:  $\pm 0.1\%$ ,  $\pm 0.25\%$ ,  $\pm 0.5\%$ ,  $\pm 1\%$
- Resistance range:  $100 \sim 1\text{M}\Omega$

### RS73-RT Anti-Sulfur **NEW**

#### version of RS73

- Excellent anti-sulfur characteristics (see page 7)
- Passes ASTM-809 anti-sulfuration testing

### RK73G High Precision Thick Film

- Resistive film applies a metal glaze thick film to achieve excellent heat resistance
- TCR:  $\pm 50\text{ppm}/^\circ\text{C}$
- Resistance range:  $10 \sim 1\text{M}\Omega$
- Tolerance:  $\pm 0.25\%$ ,  $\pm 0.5\%$ ,  $\pm 1\%$
- Sizes available: 0201  $\sim$  1206

### RK73G-RT Anti-Sulfur

#### version of RK73G

- Excellent anti-sulfur characteristics (see page 7)
- Passes ASTM-809 anti-sulfuration testing

## Surge Current Thick Film

### SG73G Endured Pulse Power **NEW**

- Ultra precision grade
- TCR:  $\pm 50\text{ppm}/^\circ\text{C}$
- Resistance range:  $10 \sim 1\text{M}\Omega$
- Sizes: 0603  $\sim$  1206
- Tolerance:  $\pm 0.25\%$ ,  $\pm 0.5\%$

### SG73 Pulse/Surge

- Superior to RK73 series in surge/pulse withstanding voltage
- Resistance range:  $1 \sim 1\text{M}\Omega$
- Sizes available: 0603  $\sim$  2512
- Tolerance:  $\pm 10\%$ ,  $\pm 20\%$



## Excellent Surge & Pulse Withstanding Voltages

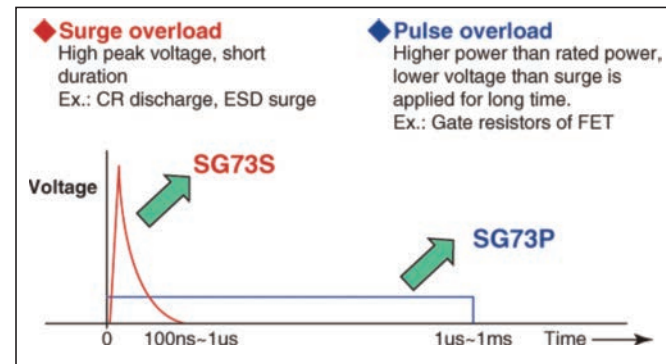

### SG73-RT Anti-Sulfur version of SG73

- Excellent anti-sulfur characteristics (see page 7)
- Passes ASTM-809 anti-sulfuration testing

### SG73P Pulse Precision

- Provides higher pulse ratings than standard RK73
- Resistance range:  $1 \sim 10\text{M}\Omega$
- Sizes available: 0402  $\sim$  1210
- 0.75W (1210), 1W (1210) **NEW**
- Tolerances:  $\pm 0.5\%$ ,  $\pm 1\%$ ,  $\pm 2\%$ ,  $\pm 5\%$

### SG73P-RT Anti-Sulfur version of SG73P

- Excellent anti-sulfur characteristics (see page 7)
- Passes ASTM-809 anti-sulfuration testing

### SG73S Surge Protection

- Endures the ESD limiting voltage
- Resistance range:  $1 \sim 10\text{M}\Omega$
- Sizes available: 0402  $\sim$  1210
- 0.75W (1210), 1W (1210) **NEW**
- Tolerances:  $\pm 0.5\%$ ,  $\pm 1\%$ ,  $\pm 2\%$ ,  $\pm 5\%$

### SG73S-RT Anti-Sulfur version of SG73S

- Excellent anti-sulfur characteristics (see page 7)
- Passes ASTM-809 anti-sulfuration testing

## Wide Terminal Thick Film

### WG73 Surge Current Wide Terminal **NEW**

- Superior to WK73 in pulse withstanding voltage
- Power rating: 1W (0612, 1020), 2W (1225)
- Resistance range:  $560\text{m} \sim 1\text{K}\Omega$
- Tolerance:  $\pm 10\%$ ,  $\pm 20\%$

### WK73R Wide Terminal

- Offers excellent heat radiation & achieves rated power
- Power rating: 0.33W  $\sim$  2W
- Higher power rating: 1W (0508), 1.5W (0612), 2W (1020), 3W (1225) **NEW**
- Sizes available: 0204  $\sim$  1225
- Resistance range:  $10 \sim 1\text{M}\Omega$



### WK73R-RT Anti-Sulfur version of WK73R

- Excellent anti-sulfur characteristics (see page 7)
- Passes ASTM-809 anti-sulfuration testing

Wide Terminal Type (WK73) Heat Dissipation Image

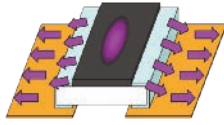

Nominal Terminal Type (RK73) Heat Dissipation Image

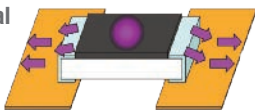

## High Voltage

### HV73-High Voltage

- Maximum working voltage as high as 800V (1206), 3000V D.C. (2512)
- Superior to RK73 in maximum working voltage
- Resistance range: 10K ~ 100MΩ
- Sizes: 0603 ~ 2512

### HV73-RT Anti-Sulfur version of HV73

- Excellent anti-sulfur characteristics (see page 7)
- Passes ASTM-809 anti-sulfuration testing

### Use Fewer Resistors for High-Voltage

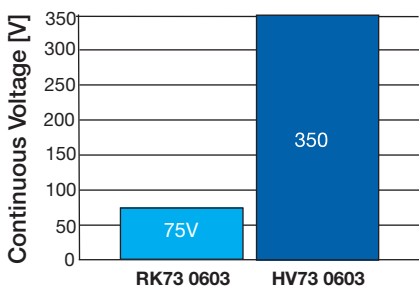

- Anti-Sulfuration Version - HV73RT - Only company to offer High Voltage resistor with sulfur proof terminations

### HV73V-High Voltage for Automotive

- AEC-Q200 Qualified
- Maximum working voltage as high as 350V (0603), 800V (1206)
- Superior to RK73 in maximum working voltage
- Working voltage: 350V ~ 800V
- Resistance range: 10K ~ 51MΩ
- Sizes: 0603 ~ 1206

### HV73V-RT Anti-Sulfur version of HV73V

- Excellent anti-sulfur characteristics (see page 7)
- Passes ASTM-809 anti-sulfuration testing

## Thin Film

### RN73R-High Reliability Thin Film



- Improved moisture resistance with high humidity coating
- High precision tolerance:  $\pm 0.05\% \sim \pm 1\%$
- High performance TCR:  $\pm 5 \sim \pm 100\text{ppm}/^\circ\text{C}$
- Resistance range: 10 ~ 1MΩ
- Sizes: 0402 ~ 1206
- AEC-Q200 Qualified

### RN73H-Thin Film for Automotive

- Improved moisture resistance by special protective coating
- High precision tolerance:  $\pm 0.05\% \sim \pm 1\%$
- High performance TCR:  $\pm 5 \sim \pm 100\text{ppm}/^\circ\text{C}$
- Resistance range: 10 ~ 1MΩ
- Sizes: 0402 ~ 1210
- AEC-Q200 Qualified

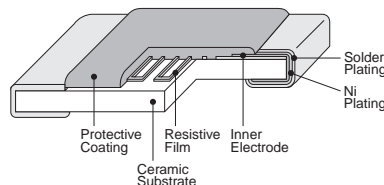

### RTX-Thin Film Network

- Available in SCSI & PECL terminations
- Resistance range: 51 ~ 40KΩ
- Power rating: 50mW ~ 200mW
- TCR:  $\pm 25, \pm 50, \pm 100\text{ppm}/^\circ\text{C}$

### RTY-Precision Voltage DividerThin Film

- Ratio matching
- TCR:  $\pm 10, \pm 25, \pm 50, \pm 100\text{ppm}/^\circ\text{C}$
- TCR matching: 5, 10, 25, 50ppm/°C
- Power rating: 50mW

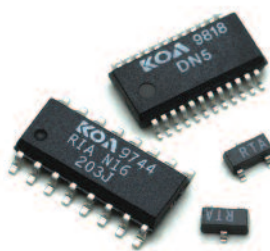

### CNN-Thin Film Chip Network

- Excellent in relative TCR (5ppm/°C)
- Pair resistors for high precision OP-amplifiers
- Custom products: any pairs between 1K ~ 100KΩ available upon request

## High Temperature

### HRK73-High Temperature Gold Terminations



- Maximum operating temperature: 200°C
- Flat chip resistor with gold terminations
- Metal glaze thick film ensures excellent heat and weather resistance
- Resistance range: 1 ~ 10MΩ
- Sizes available: 0603 ~ 1206
- AEC-Q200 Qualified

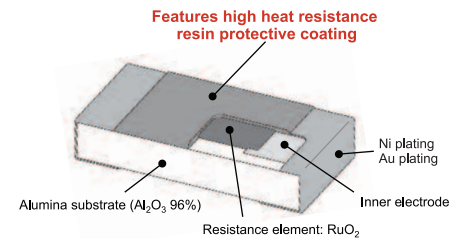

## Embedded

### XR73-Embedded Substrate Flat Chip Resistor

- Interlayer embedding in the multilayer substrates applicable from the height of 0.13 to 0.14mm
- Cu via hole connection is applicable
- Resistance range: 1 ~ 10MΩ, zero ohm offered
- Sizes available: 0201, 0402

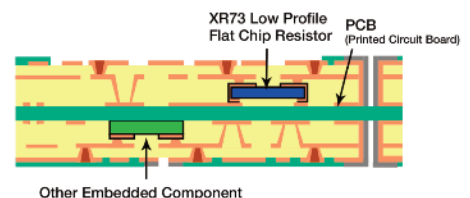

## General Purpose

### RK73B-General Purpose 2%, 5% Tolerance Thick Film Chip Resistor

#### RK73B-RT Anti-Sulfur version of RK73B

- Excellent anti-sulfur characteristics (see page 7)
- Passes ASTM-809 anti-sulfuration testing

### RK73H-Precision 0.5%, 1% Tolerance Thick Film Chip Resistor

#### RK73H-RT Anti-Sulfur version of RK73H

- Excellent anti-sulfur characteristics (see page 7)
- Passes ASTM-809 anti-sulfuration testing

### RK73Z-Zero ohm Jumper Thick Film Chip Resistor

#### RK73Z-RT Anti-Sulfur version of RK73Z

- Excellent anti-sulfur characteristics (see page 7)
- Passes ASTM-809 anti-sulfuration testing

## Networks

### CNN-Thin Film Chip Network

- Excellent in relative TCR (5ppm/°C)
- Pair resistors for high precision OP-amplifiers
- Custom products: any pairs between 1K ~ 100KΩ available upon request

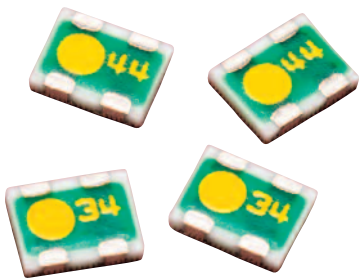

### HVD-High Voltage Divider- Precision Type NEW

- Max. resistance value 11.5MΩ
- Max. working voltage 1000V
- Max. resistance Ratio 1:1000
- Relative tolerance: 0.1%
- TCR tracking: 10ppm/°C
- TCR: ±25, ±50ppm/°C
- Absolute resistance tolerance: ±0.1% ~ ±1%

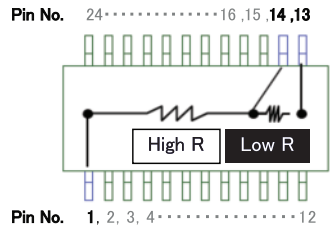

### RTX-Thin Film Network

- Available in SCIS & PECL termination
- Resistance range: 51 ~ 40KΩ
- Power rating: 50mW, 200mW
- TCR: ±25, ±50, ±100ppm/°C

### RTY-Precision Voltage DividerThin Film

- Ratio matching
- TCR: ±10, ±25, ±50, ±100ppm/°C
- TCR matching: 5, 10, 25, 50ppm/°C
- Power rating: 50mW

### RBA, RBB-Bussed Resistor Network

- TCR: ±25, ±50, ±100ppm/°C
- Resistance range: 10 ~ 100KΩ
- Absolute tolerance: ±1% ~ ±5%

### RNX-High Precision Custom Resistor Network

- Number of pins: 8, 14, 16, 20, 24
- Resistance range: 10 ~ 510KΩ
- TCR tracking: 5, 10, 25, 50ppm/°C

### RIA-Isolated Resistor Network

- Number of pins: 8, 14, 16, 20, 24
- Absolute tolerance: ±0.1% ~ ±1%
- TCR tracking: 5, 10, 25, 50ppm/°C

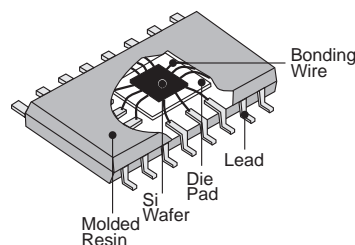

### TF(X)-Resistor/Capacitor Filter Network

- Thin Film Construction
- Stable resistor technology and high component density
- Resistance range: 10 ~ 1KΩ
- Capacitance range: 33 ~ 400pF

### DN(X)-Diode Terminator Network

- Fast reverse recovery and turn on time
- Low capacitance: 2pF
- Reverse breakdown voltage: 7.2V
- Forward voltage: 0.4V to 1.2V
- Number of pins: 3, 4, 6, 8, 20, 24

### AC(X)-AC Terminator Network

- Thin Film Construction
- Surface mount package with stable resistor technology and high component density
- Resistance range: 10 ~ 1KΩ
- Capacitance range (pF): 33 ~ 400pF
- Number of pins: 20, 24

## Fusing Resistors

### RF73-Fusing Resistor Performs Like RK73 under normal conditions

- Fuses when overloaded
- Fusing Power: 2.1W ~ 6.5W
- Fusing Time: 60 seconds, maximum
- Sizes available: 0603 ~ 2512

## Melf Resistors

### RD41-Fixed Carbon Film MELF Resistor

- Metal plate terminals
- Meets or exceeds IEC 60115-8, EIA RC-2131A
- TCR: +350 ~ -1300ppm/°C
- Power Rating: 0.25W

### RN41, RM41-Fixed Metal Film MELF Resistors

- Higher stability in short and long term tests
- TCR: ±25 ~ ±350ppm/°C
- Power Rating: 0.125W, 0.2W, 0.25W, 0.4W, 0.5W, 1W
- Resistance range: 0.22 ~ 5. 11MΩ

## Anti-Sulfur Chip Resistors

### Why Choose Anti-Sulfur?

Sulfuration is a phenomenon that occurs in most thick film resistors, with silver-based inner electrodes. When a resistor is used in a high-sulfur atmosphere, the sulfur molecules can migrate between the protective film and the outer electrode to the inner electrode, where they react to form silver sulfide. Silver sulfide is an insulator, and the resistance of the device increases toward an open circuit. KOA's product line includes resistors with sulfuration-resistant inner electrodes.

### Structural Chart of Flat Chip Resistor (Standard)

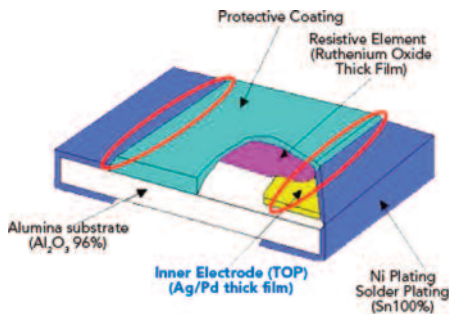

### Chip Resistor Disconnected by Sulfuration Needle Crystals of Silver Sulfide (Ag<sub>2</sub>S)



### General Purpose

#### RK73B-RT

- ±2%, ±5% General Purpose Flat Chip Resistor

#### RK73H-RT

- ±0.5%, ±1% High Precision Flat Chip Resistor

#### RK73Z-RT

- Zero ohm with max. resistance of 50mΩ

### High Precision

#### RS73-RT

- High reliability with ΔR of ±0.2%, ±0.4% in reliability test
- Low TCR: ±25ppm/°C

#### RK73F-RT

- ±0.25%, ±0.5% Ultra Precision
- Low TCR: ±25ppm/°C

#### RK73G-RT

- ±0.5%, ±1% Ultra Precision Flat Chip Resistor
- Low TCR: ±50ppm/°C

### Wide Terminal

#### WK73R-RT/WK73S-RT

- Power rating: 0.75W (0508, 0612), 1W (0508, 0612, 1020, 1218), 1.5W (1225), 2W (1225)

#### WK73R-RT/WK73S-RT **NEW**

- Higher power rating: 1.5W (0612), 2W (1020), 3W (1225)

### High Voltage

#### HV73-RT

- High Voltage Flat Chip Resistor
- Max working voltage as high as 800V (1206), 3000V DC (2512)

#### HV73V-RT

- High Voltage Flat Chip Resistor for Automotive
- AEC-Q200 Qualified

### Anti-Surge

#### SG73-RT

- Superior to RK73 series in surge withstanding voltage and pulse withstanding voltage
- Power rating: 0.1W, 0.125W, 0.33W, 0.5W, 0.75W, 1W

#### SG73P-RT

- Able to select resistance from +0.5%
- Power rating: 0.75W, 1W **NEW**

#### SG73S-RT

- Surge Precision
- Low Resistance (0.1Ω)
- Power rating: 0.75W, 1W **NEW**

#### SR73-RT

- Low Resistance (0.1Ω)

### Anti-Sulfur Performance Comparison

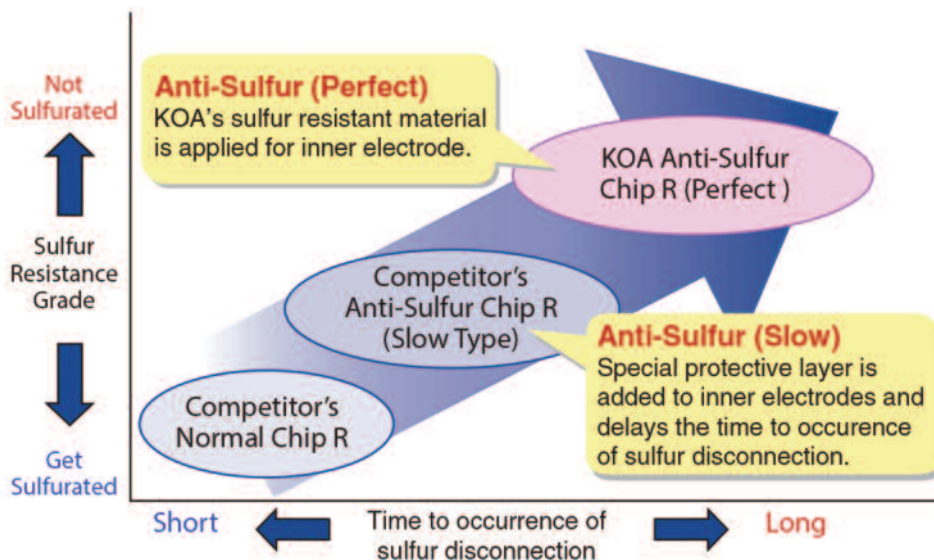

## Metal Plate

### TLR-Current Sensing, Small Type, Low Resistance

- Power rating: 0402-0.2W, 1206-0.5W, 2010-1W, 2512-1W
- Resistance range: 1 ~ 20mΩ
- Rated Terminal Part Temperature: 105°C
- Tolerance: ±1%, ±2%, ±5%

### TLR-Current Sensing, Low Resistance

- Power rating: 1206-1W, 2010-2W, 2512-2W
- Resistance range: 0.5 ~ 20mΩ
- TCR: ±50, ±150ppm/°C
- Tolerance: ±1%

### TLR-Current Sensing, Higher Power, Low Resistance

- Power rating: 0805-1W, 1206-1.5W, 2512-3W
- Resistance range: 0.5 ~ 20mΩ
- TCR: ±50, ±75, ±100ppm/°C
- Tolerance: ±1%



KOA Current Sense Resistor Lineup

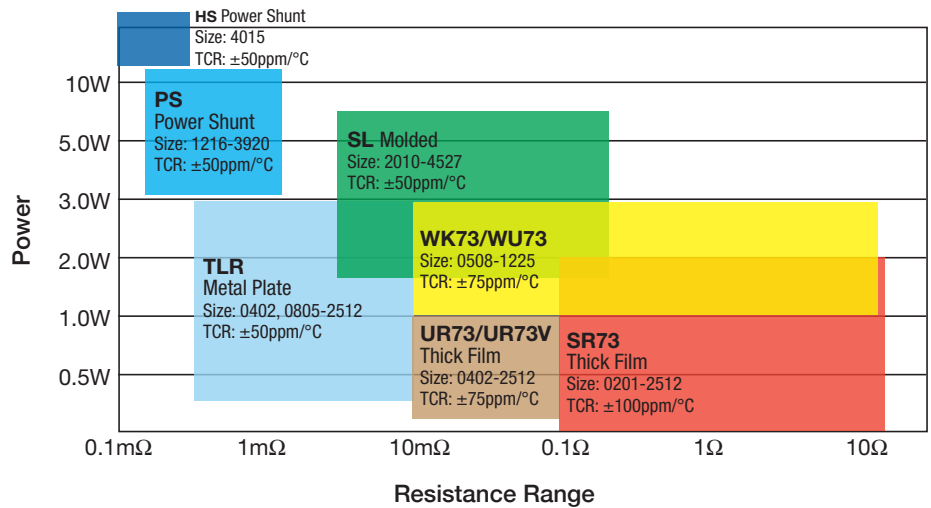

### TLRH-Current Sensing, Extended Resistance Range, Low Resistance

- Power rating: 0805-0.25W, 0.33W, 0.5W, 2512-2W, 4W, 5W
- Resistance range: 6 ~ 270mΩ
- TCR: ±50, ±75ppm/°C
- Tolerance: ±1%

### TLRZ-Current Sensing, Zero Ohm Jumper

- Current Ratings: 0402-10A, 0603-26A, 0805-31.6A, 1206-50A
- Ultra low resistance not to exceed 0.2mΩ
- Operating temperature: -55 ~ +170°C

### KOA's Metal Plate

LARGE Pulse Capability Due to NO Trim Lines

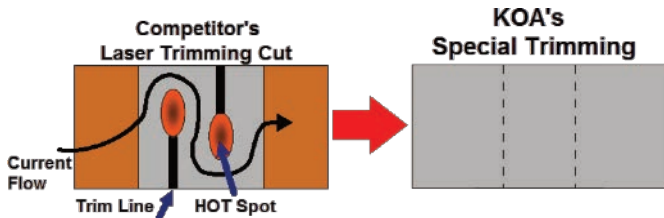

### LR72-Custom Milliohm

- Flexible leads allow for thermal expansion
- Unique open-center shapes for cooler operation
- Resistance values: 2 ~ 8mΩ

## Thick Film Current Sense

### SR73-Low Resistance

- Resistance range: 24m ~ 10Ω
- Power rating: 0201-0.1W ~ 2512-2W
- TCR: 0~±400 ~ ±1000ppm/°C
- Tolerance: ±0.5%, ±1%, ±2%, ±5%

### SR73-RT-Anti-Sulfur Version of SR73

- Excellent anti-sulfur characteristics (see page 7)
- Passes ASTM-809 anti-sulfuration testing

### UR73-Low Resistance, Low TCR

- Resistance range: 10m ~ 100mΩ
- TCR: ±100 ~ ±500ppm/°C
- Power rating: 0402-0.125W ~ 2512-1W

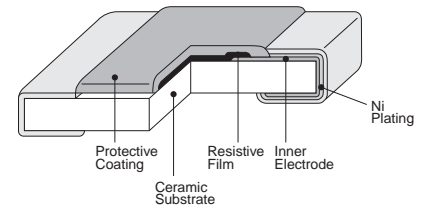

### UR73V-High Heat, Low Resistance, Low TCR

- Operating temp range: -55°C ~ +155°C
- Resistance range: 10m ~ 100mΩ
- TCR: ±75, 0 ~ +150, 0 ~ +250 ~ ±100ppm/°C
- AEC-Q200 Qualified



## Wide Terminal Thick Film

### WK73S-Low Resistance, Wide Terminal

- Power rating: **NEW** 0508-1W, 0612-0.75W, 1.5W, 1020-1W, 2W, 1218-1W, 2512-1.5W, 2W, 3W
- Resistance range: 10m ~ 9.76Ω
- Tolerance: ±0.5%, ±1%, ±5%

### WK73S-RT-Anti-Sulfur Version of WK73S

- Excellent anti-sulfur characteristics (see page 7)
- Passes ASTM-809 anti-sulfuration testing

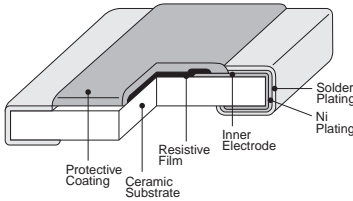

### WU73-Low Resistance, Wide Terminal

- Power rating: 0612-1W, 1.5W
- Resistance range: 10m ~ 100mΩ
- Tolerance: ±1%
- Low TCR: ±75, ±100ppm/°C

## Power Shunts

### PSL2-Large Current Sensing, Ultra Low Resistance, 2-Terminal **NEW**

- Resistance range: 0.2, 0.3, 0.5mΩ
- Power rating: 8W, 9W
- TCR: ±115, ±175, 250 ~ ±100ppm/°C
- Tolerance: ±1%

### PSF4-Large Current Sensing, Ultra Low Resistance, 4-Terminal, Low TCR **NEW**

- Resistance range: 0.5, 1mΩ
- Power rating: 3W, 5W
- TCR: ±50ppm/°C
- Tolerance: ±1%

### PSJ2-Large Current Sensing, Ultra Low Resistance, 2-Terminal **NEW**

- Resistance range: 0.2, 0.5, 1, 2, 3, 4mΩ
- Power rating: 5W, 6W, 8W, 10W, 12W
- TCR: ±50, ±75, ±100, ±200ppm/°C
- Tolerance: ±1%

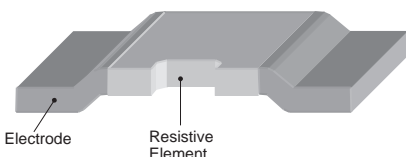

### PSG4-Large Current Sensing, Ultra Low Resistance, 4-Terminal, Low TCR

- Resistance range: 0.5, 1mΩ
- Power rating: 8W, 10W
- TCR: ±50ppm/°C
- Tolerance: ±1%

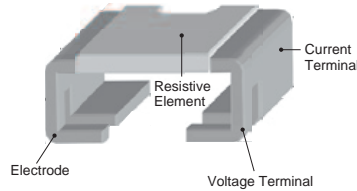

### PSB-Large Current Sensing, Ultra Low Resistance

- Resistance range: 0.2, 0.75, 1mΩ
- Power rating: 6W, 12.5W **NEW**
- TCR: ±75, ±100ppm/°C
- Tolerance: ±1%

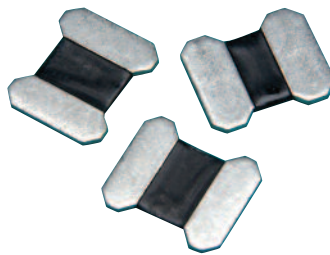

### PSI-Large Current Sensing, Ultra Low Resistance

- Resistance range: 3, 4mΩ
- Power rating: 3W
- TCR: ±50ppm/°C
- Tolerance: ±1%

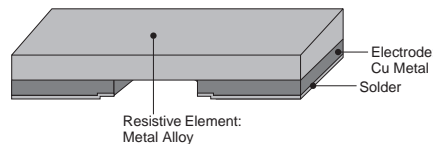

### PSE-Large Current Sensing, Ultra Low Resistance

- Resistance range: 0.5, 1, 1.5, 2mΩ
- Power rating: 3W, 5W
- TCR: ±150ppm/°C
- Tolerance: ±1%, ±5%

### HS-Large Current Sensing, Ultra Low Resistance

- Resistance Range: 0.1, 0.2mΩ
- Power Rating: 18W, 36W
- Size: 4015 (mm)
- Tolerance: ±5%
- TCR: 50±25ppm/°C

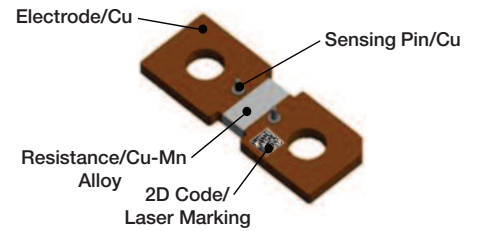

## Molded Plate

### SL-Current Sensing, Low Resistance

- Power rating: 2010-0.75W, 2512-1W, 4527-2W, 3W
- Resistance range: 3m ~ 22MΩ
- Tolerance: ±0.5%, ±1%, ±2%, ±5%
- TCR: ±50, ±75, ±180ppm/°C

### SL-Higher Power Current Sensing

- Power rating: 2010-1W, 2512-1.5W
- TCR: ±50, ±75ppm/°C
- Resistance range: 3 ~ 200mΩ
- Tolerance: ±0.5%, ±1%, ±5%

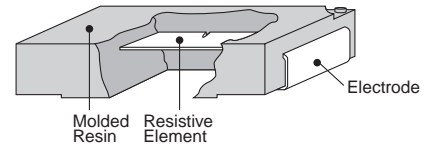

### SLN-SLW-Higher Power Current Sensing

- Power rating: 2010-1W, 2512-1.5W, 4527-2W, 3W, 7W
- TCR: ±50, ±75, ±100, ±180ppm/°C
- Resistance range: 5 ~ 200mΩ
- Tolerance: ±0.5%, ±1%, ±2%, ±5%

### TSL-Low Profile Current Sensing

- Power rating: 2512-1W
- Resistance range: 5~100mΩ
- Operating temperature: -55 ~ +180°C
- Tolerance: ±0.5%, ±1%, ±5%

### CSR-Current Sensing, 4-Terminal, Molded

- Power rating: 1W, 2W
- Resistance values: 5 ~ 50mΩ
- Tolerance: ±0.5%, ±1%

### BLR-Ceramic, Custom

- Power rating: 1W, 2W, 15W
- Resistance range: 8m ~ 50mΩ
- Tolerance: ±5%, ±10%



# LEADED RESISTORS

## General Purpose Leaded

### CF-Carbon Film

- Flameproof coating available (CFP)
- Reduced body size offered (CFS, CFPS)
- Resistance range: 1 ~ 5.1M $\Omega$
- Power rating: 0.25W, 0.5W
- Tolerance:  $\pm 2\%$ ,  $\pm 5\%$

## Precision Leaded

### MF-Precision Metal Film

- Meets requirements of MIL-R-22684
- MFS two times the power rating of the standard body type
- Resistance range: 0.51 ~ 5.11M $\Omega$
- Power rating: 0.25W, 0.5W, 1W

### MRS-Plate Shaped High Precision Metal Film

- Ultra precision TCR up to  $\pm 2.5\text{ppm}/^\circ\text{C}$
- Low tolerance:  $\pm 0.01\%$ ,  $\sim \pm 0.5\%$
- Wide resistance range: 10 ~ 1M $\Omega$

### RNS-High Precision Metal Film

- Excellent long term stability in resistance value
- Resistance range: 0.2 ~ 6.8M $\Omega$
- High precision resistance:  $+0.1\%$  ~ 1%
- Power rating: 0.125W, 0.25W, 0.5W, 1W

## High Voltage Circuit Leaded

### RK92-L-High Voltage SIP Discharge Resistor NEW

- Excellent overload capability and high stability life and aging even in insulating oil
- Thin SIP shape suitable for space saving mounting
- Custom type three-terminal product is available
- Power rating: 4W
- Resistance range: 1.2M, 3M, 4M, 5M, 8M, 12M, 16M $\Omega$

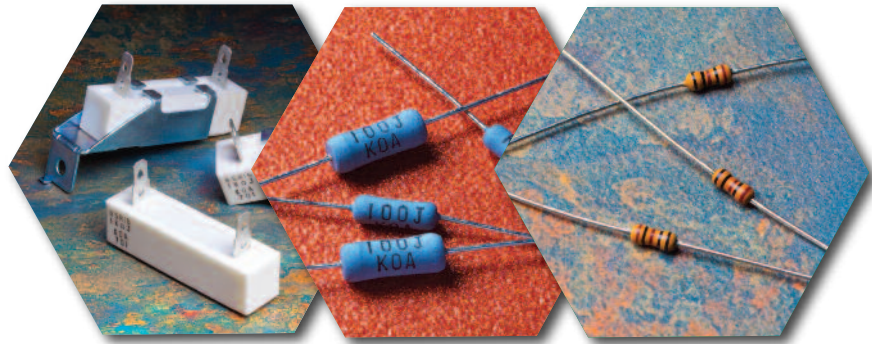
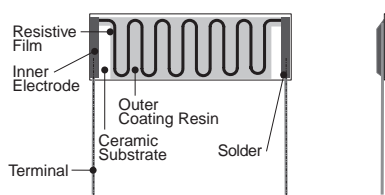

### RK92-High Voltage SIP Resistor

- High resistance resistor for high voltage circuits
- Flame retardant coats corresponding to UL94V-0 are used
- Thick film resistors (RuO<sub>2</sub>) ensure high stability in life and change in aging
- Resistance range: 1M ~ 1G $\Omega$

### RK-Metal Glaze Discharge Path Resistors

- Responsible to resistance tolerance  $\pm 1\%$  and TCR  $\pm 100\text{ppm}/^\circ\text{C}$
- Highly stable against environmental conditions and overload
- Power rating: 0.25W, 0.5W, 1W
- RK1/2G: Discharge path resistor UL1676 available

### RCR-Anti-Surge Resistor

- Excellent anti-surge characteristics
- Stable characteristics of moisture resistance up to 100M $\Omega$  resistance range
- RCR50+, RCR50EN (1M ~ 12M $\Omega$ ), RCR60 (1M ~ 12M $\Omega$ ) are conductive-path and discharge path resistors recognized by UL1676 and c-UL (CSA-C22.2 No. 1-M94)
- RCR25EN, RCR50EN (100k ~ 33M $\Omega$ ), RCR60 (100k ~ 56M $\Omega$ ) are approved by EN6268-1 G.10 safety

### GS-High Voltage, High Resistance Thick Film

- Miniature construction can endure to high power voltage (up to 40kV)
- High power rating up to 12W
- Excellent anti-surge characteristics
- Wide resistance range: 500K ~ 10G $\Omega$

### PCF-Ceramic Resistor for Anti-Pulse Surge

- KOA original bulk ceramic resistor
- Coated with UL94V0 flameproof material
- Excellent in anti-pulse characteristics
- Power rating: 0.5W, 1E, 2W
- Resistance range: 3.3 ~ 390k $\Omega$

#### PCF Series One Pulse Limit Power Curve

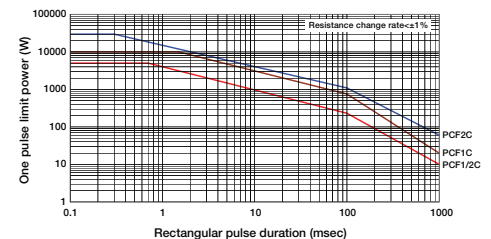

### HPC-Ceramic Resistor for Anti-Pulse Surge

- KOA original bulk ceramic resistor
- Higher reliability against disconnection compared to wirewound resistors and film resistors
- Power rating: 0.5W ~ 5W
- Resistance range: 3.3 ~ 390K $\Omega$

### CPCN-Fixed Ceramic Resistor

- Suitable for noise suppression of engine ignition systems
- Reliable in pulse/transient applications
- Power rating: 0.5W, 1W, 1.5W, 2W
- TCR:  $-1200 \pm 300\text{ppm}/^\circ\text{C}$



### P-High Voltage Power Resistor

- PSN is higher power (up to 250W) and for high voltage surge (up to 400kV)
- PSO is a completely moisture resistant version of PSN
- PN is non-inductive type and can be used for high frequency
- PWW are non-inductive wirewound resistors for high voltage with resistance wires wound on insulation pipes
- PAP are non-inductive wirewound resistors with inductance less than PWW, can be used for pulse wave measurement
- Wide power rating: 2W, 5W, 10W, 25W, 50W, 125W, 250W

#### PSN • PV

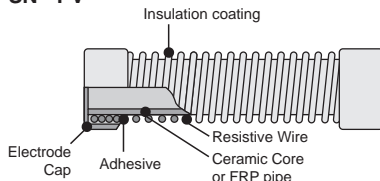

## Power Leded

### BGRV-Cemet Case Wirewound, Glass Core for Automotive

NEW

- Uses flame retardant insulated ceramic case
- Excellent in anti-pulse and inrush current
- Power rating: 7W, 10W, 15W, 20W, 30W, 40W
- Resistance range: 5.1 ~ 390Ω



### BSRV-Rectangular Type Metal Oxide Film for Automotive

NEW

- Uses flame retardant insulated ceramic case
- Excellent in anti-pulse and in rush current
- Power rating: 5W, 7W, 10W, 15W, 20W
- Resistance range: 430 ~ 56kΩ

### MOS/MOSX-Reduced Size Metal Oxide Power Type

- MOS/MOSX Small size power type resistor
- Coated with UL94V0 equivalent flameproof material
- Power rating: 0.5W, 1W, 2W, 3W, 5W
- Resistance range: MOS- 10 ~ 100kΩ, MOSX - low resistance range: 0.1 ~ 9.1Ω
- TCR:  $\pm 300$ ppm/°C

### SPR-Power Carbon Film

- Coated with UL94V0 equivalent flameproof material
- High reliability performance
- SPRX - small size fixed metal film resistor available
- Power rating: 0.25W, 0.5W, 1W, 2W, 3W, 5W

### BGR, BWR, BSR-High Power Resistors

- BGR - rectangular type wirewound resistor with glass core
- BWR - rectangular type wirewound resistor with ceramic core
- BSR - rectangular type metal oxide film resistor
- Uses flame retardant insulated ceramic case
- Power rating: BWR - 1W ~ 20W, BGR-5W ~ 40W, BSR - 2W ~ 20W

## Wirewound Leded

### CWFS-Coat Insulated Wirewound Resistor with Fusing Function

NEW

- Fail-safe mains fusing at AC 250V (CWFS23: 4.7 ~ 9.1: AC 200V)
- Flameproof retardant coating
- Power rating: 3W, 5W
- Fusing power: 90W, 150W
- Fusing time: 30 S. Max

### CW-Coat Insulated Wirewound Resistor

- Flameproof silicone coating equivalent (UL94V0)
- CW1SS- UL1412 approval (file No. E320246)
- CW\_X - power type & CW\_S - small type available
- Power rating: 0.25W, 0.5W, 1W, 2W, 3W, 5W
- Resistance range: 0.1 ~ 390Ω

### CWH-Miniature Wirewound Leded Resistor

- Meets MIL-PRF-26 (U characteristics)
- High precision resistor with TCR  $\pm 20$ ,  $\pm 50$ ppm/°C
- Power rating: 1W, 2W, 3W
- Resistance range: 0.1 ~ 3kΩ

### CWP-Precision Coat Insulated Wirewound Resistor

- Flameproof silicone coating equivalent (UL94V0)
- Power rating: 1W, 2W, 3W
- Resistance range: 0.1 ~ 390Ω
- TCR:  $\pm 50$ ,  $\pm 90$ ppm/°C
- Tolerance:  $\pm 0.25\%$ ,  $\pm 0.5\%$ ,  $\pm 1\%$

### RW-Coat-Insulated Miniature Precision Power Wirewound Resistor

- Meets MIL-R-26E (U and V characteristics) and surface temperature (hot spot) 350°C max.
- Wide resistance range: 0.1 ~ 62kΩ
- RW\_N are non-inductive wound and can be used in high frequency applications
- Operating temperature range: U: -55°C ~ +275°C, V: -55°C ~ +350°C
- TCR: -90 ~ +400ppm/°C
- Tolerance:  $\pm 0.5\%$ ,  $\pm 1\%$ ,  $\pm 3\%$ ,  $\pm 5\%$

## Current Sense Leded

### BPR-Rectangular Metal Plate Resistor

- Power type current detecting resistor with flame retardant ceramic case
- Automatic insertion for a 5mm pitch between terminals is applicable (26 type, 58 type)
- Low resistance range: 0.01 ~ 1Ω
- TCR:  $\pm 350$ ppm/°C
- Low inductance

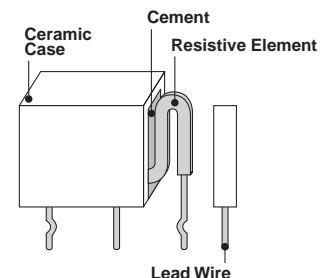

## LR-Custom Milliohm Resistor

- The super low resistance ( $3m \sim 100m\Omega$ ) is suitable for high power current detection
- Pitches and heights are adjustable according to mounting conditions
- All custom made parts
- Max. current rating:  $3A \sim 21A$

## Leaded Resistor Networks/ Resistor Arrays

### MRP-Precision Metal Film SIP Network

- Custom design network
- Ultra-precision performance for precision analog circuits
- Absolute TCR:  $\pm 25, \pm 50ppm/^{\circ}C$
- Tracking TCR: 2, 5, 10
- Power rating: (mW): element-100, package-200

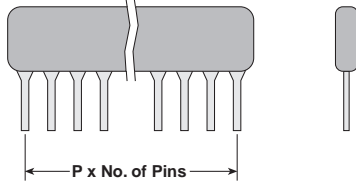

### RKC, RKH, RKL-Thick Film SIP Resistor Network

- Various type of standard circuits in different sizes and power (seated height 0.20", 0.26", 0.42")
- Higher temperature soldering of the leads prevents terminals from loosening during board assembly
- Number of resistors:  $3 \sim 16$
- Tolerance:  $\pm 1\%, \pm 2\%, \pm 5\%$
- Resistance range:  $22 \sim 2.2M\Omega$

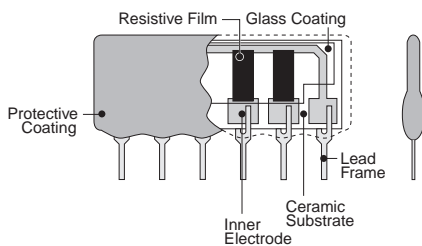

## Fusing Leaded

### RF-Coat Insulated Fusing Resistor

- Functions as a resistor in normal conditions
- Quick fusing protects circuit from excessive overload at an abnormal time
- Fusing time: 30S max, 60S max
- Flame-retardant coating equivalent to UL94V0
- Fusing power:  $2.5W \sim 36W$

### RF25CC-Coat-Insulated Fusing Resistor

- Constant current fuse type
- Fuse with 60 sec in case of over-current
- Fuse in low magnification at 5 times or 10 times the power rating
- Flame retardant coating equivalent to UL94V-0
- Fusing power:  $2.5W, 1.25W$

## Jumper Leaded

### Z-Jumper (Coating Type)

- Size compatible with  $1/8, 1/4, 1/2$  watt resistors
- Max. Amperage: 1.5A, 2.5A, 15A
- Resistance:  $20m\Omega$  or less

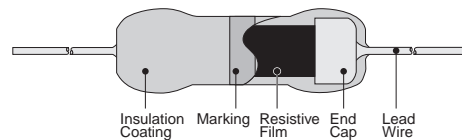

### J-Molded Jumper

- Max. allowable current: 8A, 10A
- Operating temperature range:  $-55^{\circ}C \sim +125^{\circ}C$

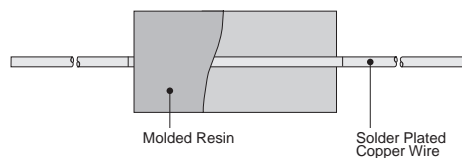

### JL-Jumper Wire

- Suitable for automatic machine insertion
- No rating
- Max. current rating: 8A, 10A, 12A

# THERMAL SENSORS

## Platinum Thin Film Thermal Sensors

### SDT310VASP-Small Type **NEW** Platinum Thin Film Thermal Sensor

- Small heater element type with operating temperature range:  $-55^{\circ}\text{C}$  ~  $+600^{\circ}\text{C}$
- Small as quarter volume convenience type 3.2 second thermal time constant
- Excellent heat resistance
- Applies axial lead type suitable to use as heater element
- TCR:  $+3850 \pm 25 \text{ ppm}/^{\circ}\text{C}$

### SDT101-Axial Platinum Thin Film Thermal Series

- Stable characteristics even in use for a long time with an excellent environment resistance
- Operating temperature range: SDT101A:  $-55^{\circ}\text{C}$  ~  $+150^{\circ}\text{C}$ , SDT101B:  $-55^{\circ}\text{C}$  ~  $+300^{\circ}\text{C}$
- Stationary temperature:  $0^{\circ}\text{C}$ ,  $25^{\circ}\text{C}$
- TCR:  $+3500 \text{ ppm}/^{\circ}\text{C}$

### SDT310HCTP-Small Type Platinum Thin Film Thermal Sensor

- Characteristics are equivalent with IEC 60751-2008, JISC 1604-2013
- Small package of 1.2mm x 3mm with  $100\Omega$  resistance
- Operating temperature range:  $-55^{\circ}\text{C}$  ~  $+300^{\circ}\text{C}$ ,  $-55^{\circ}\text{C}$  ~  $+400^{\circ}\text{C}$
- Specified current: 1mA Max.

### SDT310-Small Type Platinum Thin Film Thermal Sensor

- TCR:  $+3850 \text{ ppm}/^{\circ}\text{C}$  is in accordance with JIS-DIN standards IEC
- Small package with a real ability of  $1\text{k}\Omega$  resistance
- Thermal time constant is improved with the small package
- Operating temperature range:  $-55^{\circ}\text{C}$  ~  $155^{\circ}\text{C}$ ,  $-55^{\circ}\text{C}$  ~  $400^{\circ}\text{C}$ ,  $-55^{\circ}\text{C}$  ~  $650^{\circ}\text{C}$

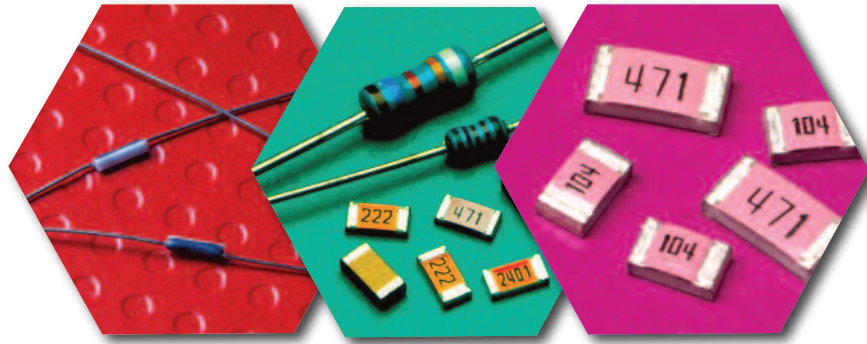
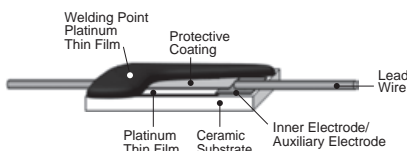

### ST-Custom Thermal Sensor

- All ST-series thermal sensors are designed in various shapes in accordance with your application
- TCR:  $+3500 \text{ ppm}/^{\circ}\text{C}$ ,  $+3850 \text{ ppm}/^{\circ}\text{C}$
- Resistance values at  $0^{\circ}\text{C}$ : 100, 500,  $1\text{k}\Omega$

### AFS-Air Flow Sensors

- Realized high and long-term stability
- Small platinum thin film thermal sensor and an even temperature differential operating circuit ensure a quick response
- Built-in temperature compensation circuit assures correct values regardless of air temperature
- Products have no rotating mechanism and are resistant to vibration



## Platinum Thin Film Surface Mount Thermal Sensors

### SDT73H-General Purpose Chip Series

- SMD platinum thin film thermal sensor
- TCR:  $+3850 \text{ ppm}/^{\circ}\text{C}$  is in accordance with JIS-DIN standards IEC
- 1206 Size
- Operating temperature range:  $-55^{\circ}\text{C}$  ~  $+155^{\circ}\text{C}$
- Thermal dissipation constant:  $2.4 \text{ mW}/^{\circ}\text{C}$

### SDT73S-Heat Resistant Chip Series

- SMD platinum thin film thermal sensor
- TCR:  $+3850 \text{ ppm}/^{\circ}\text{C}$  is in accordance with JIS-DIN standards IEC
- Operating temperature range:  $-55^{\circ}\text{C}$  ~  $+250^{\circ}\text{C}$
- Thermal time constant 6.5 seconds

### SDT73V-Automotive Platinum Thin Film Chip Series

- AEC-Q200 Qualified
- SMD platinum thin film thermal sensor
- TCR:  $+3850 \text{ ppm}/^{\circ}\text{C}$  is in accordance with JIS-DIN standards IEC
- Operating temperature range:  $-55^{\circ}\text{C}$  ~  $+155^{\circ}\text{C}$
- Thermal dissipation constant:  $2.4 \text{ mW}/^{\circ}\text{C}$

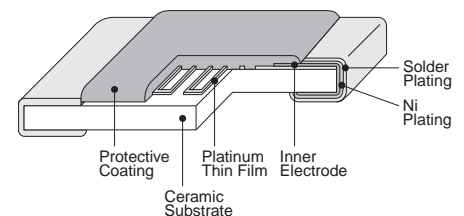

# THERMAL SENSORS & INDUCTORS

## Linear PTC Resistors Thin Film Linear PTC Thermistors

### Thermistor Styles

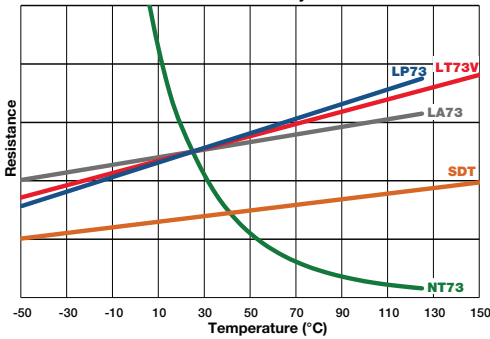

### LP73-Thin Film Thermal Sensors of SMD Type

- Resistance tolerance  $\pm 1\%$ ,  $\pm 2\%$ ,  $\pm 5\%$
- Wide range of TCR's:  $+3000 \sim +5000\text{ppm}/^\circ\text{C}$
- Suitable for control of temperatures in various industrial equipment
- Sizes: 0603, 0805, 1206
- TCR tolerance:  $\pm 5\%$

### LT73-Linear Positive Tempco Thermistor

- Anti-leaching nickel barrier terminations
- Twenty-five specifiable temperature characteristics
- Sizes: 0805, 1206
- Thermal time constant: 1 second, 1.5 seconds

### LT73V-Linear Positive Tempco Flat Chip for Automotive

- AEC-Q200 Qualified
- Various TCR:  $+150 \sim +4500\text{ppm}/^\circ\text{C}$  are available
- Operating temperature range:  $-55^\circ\text{C} \sim +155^\circ\text{C}$
- Sizes: 0805, 1206
- Rated ambient temperature:  $+85^\circ\text{C}$

### LP-High TCR Thin Film Resistance Thermal Sensor

- High TCR:  $+5000\text{ppm}/^\circ\text{C}$
- Accommodates resistance tolerance  $\pm 1\%$ ,  $\pm 2\%$ ,  $\pm 5\%$
- Power rating: 0.063W, 0.125W
- Resistance range:  $1 \sim 30\text{k}\Omega$

## Thermal Sensors – Thick Film Linear PTC Thermistors

### LA73-Thick Film Linear

- Twenty-five specifiable temperature characteristics
- Sizes: 0603, 0805, 1206
- Thermal dissipation constant ( $\text{mW}/^\circ\text{C}$ ): 7.6, 8.2, 9.0
- Max. working voltage: 25V, 50V

## Negative Tempco Thermistors

### NT73-Temperature Compensation Thick Film

- Twelve standard resistance values
- Sizes: 0603, 0805, 1206
- B constant @  $25^\circ\text{C}/75^\circ\text{C}$ : 3200K  $\sim$  4100K
- B constant tolerance:  $\pm 3\%$ ,  $\pm 5\%$ ,  $\pm 10\%$

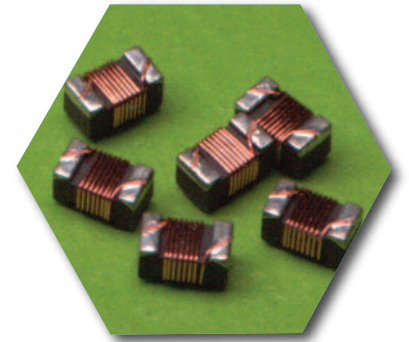

## Inductors

### KQC-High Current Inductor

- Low DC resistance and high allowable DC current
- Low profile style of 0.027 inches (0.7mm) typical
- Nominal inductance range: 1.2  $\sim$  27nH
- Tolerance:  $\pm 0.1 \sim \pm 5\%$
- Sizes: 0402, 0603

### KQ/KQT-High Q Inductor

- Ideal for low loss, high output power consumption
- Q factor min.: 16  $\sim$  65
- Inductance range: 1  $\sim$  10000nH
- Tolerance:  $\pm 0.1n \sim \pm 20\%$

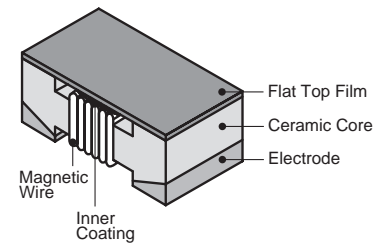

### LPC-Power Chip Inductor

- Low DC resistance and high allowable current due to proprietary construction & wiring technology
- DC current max.: 0.07  $\sim$  3.66A
- Inductance range: 0.82  $\sim$  2200 $\mu\text{H}$
- Tolerance:  $\pm 10\%$ ,  $\pm 20\%$
- Sizes: 4045, 4235, 4545

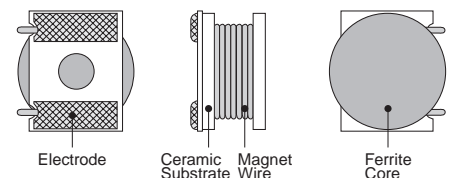

# FUSES & VARISTORS

## Fuses – Flat Chip

### TF16VN - Chip Current Fuse for Automotive

- Small and light for the secondary circuit
- Current rating: 0.04 ~ 3.15A
- Temperature cycle (-55°C ~ 125°C), 1000 cycle
- Anti-pulse type in 0603 size
- AEC-Q200 Qualified

### Fusing Characteristics

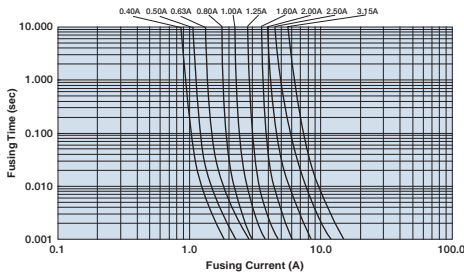

### RF73-Fusing Flat Chip Resistor

- Fuses when overloaded
- Resistance range: 0.2 ~ 510Ω
- Tolerance: ±5%
- Sizes available: 0603 ~ 2512
- UL1412 Approved (0805 ~ 2512 sizes)

### TF-Thin Film Chip Fuse

- Special manufacturing method stabilizes fusing characteristics
- Low power consumption and less voltage drop due to low internal resistance
- Rated current from 0.20 ~ 5A
- Sizes available: 0402, 0603

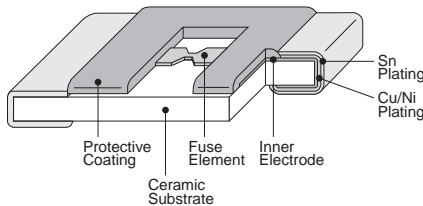

### CCP-Fast Blow Chip Fuse

- Immediate cut-off of excessive heat
- No generation of heat
- UL94V0 epoxy case
- Current rating: 0.75 ~ 5A
- Sizes available: 1206, 1210



### CCF1N-Anti-Surge Chip Fuse

- Ceramic case provides excellent mechanical strength
- Current rating: 400mA ~ 15A
- UL248, 14, c-UL(CAS)C22.2 approved
- Up to 125V AC and 160V DC

### CCF1F-Anti Surge, Anti-Sulfur Chip Fuse

- Meets IEC60127-4 specifications (7A or less)
- Stable fusing characteristics due to proprietary technology
- Current rating: 0.4 ~ 15A
- Size: 2410

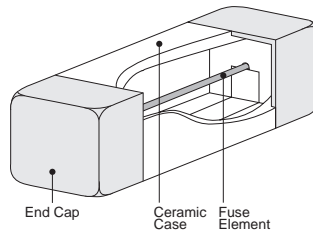

## Varistors

### NV73-Metal Oxide Varistor

- Multilayer structure with high surge current
- Protector against static electricity, switching and incoming surges
- Varistor Voltage: 6.8 ~ 120V
- Sizes available: 0201 ~ 2220
- Max. Energy: 0.001J ~ 14J

### NV73DL-Metal Oxide Varistor for Automotive

- Ideal for countermeasures against ESD (conforming to IEC61000-4-2)
- Max. energy type up to 1.5J
- High resistance to cyclic temperature stress
- Varistor voltage: 10 ~ 90V1mA
- Sizes available: 0603 ~ 1206
- AEC-Q200 Qualified

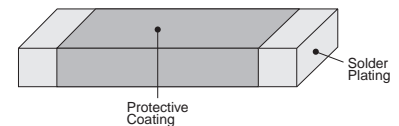

### NV73DS - Load Dump Surge Metal Oxide Varistor

- Symmetrical non-linearity V-I characteristics absorb positive and negative surge
- Meets JASO load dump surge test requirements
- Max. load dump surge energy: 63 ~ 70J
- Operating temperature: up to +125°C
- Sizes available: 2420
- AEC-Q200 Qualified

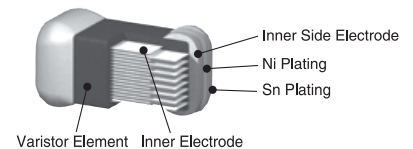

# LTCC SUBSTRATES & OTHER PRODUCTS

## LTCC Substrates

### KLC-LTCC Multilayer Substrates

- Stack accuracy <math><20\mu\text{m}</math>
- Line width as low as - Special shapes of substrates and cavity (circle, polygonal, concave or convex shape available)
- Line-to-line spacing as low as - Cavity flatness:  $<25\mu\text{m}</math>$
- Cavity width: - Cavity depth: - Cavity wall thickness: - Flexural/bonding strength: - Thermal conductivity: - Min. insulation resistance: - Density: - Fired layer thickness: - Via diameter:

## Hybrid IC

### KA-Hybrid IC

- High density mounting by bonding (COB)
- Adjusted processes are decreased by function and ratio trimmings
- Substrate materials:  $\text{Al}_2\text{O}_3$  alumina and glass epoxy
- Printing: Conductor Resistance: Ag-Pd: \text{RuO}\_2: +100 \times 10^{-6}/\text{K}</math>

### MCM-Multi-chip Module

- SMD (Hybrid IC)
- Multiple semiconductors in one package offers downsized system with high performance and standardization
- High precision modules by function trimming
- Terminal pitch: - Mountable device: SMD, bare chip, printed resistor (trimmable)



## Other Products

### RC-Test Point Chip

- Surface-mountable chip type test terminal
- Rated Current: 2A
- Standard resistance: - Sizes available: 0603, 0805, 1206
- AEC-Q200 Qualified

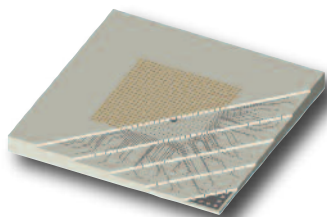
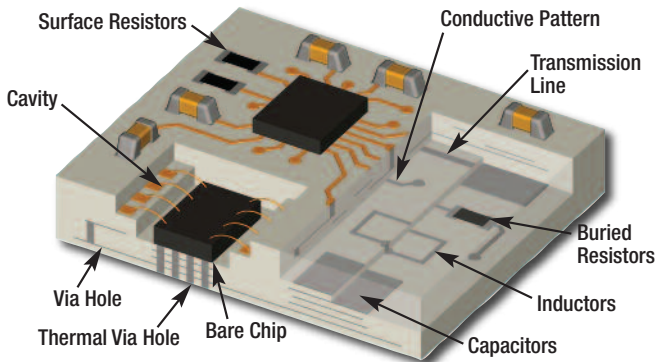
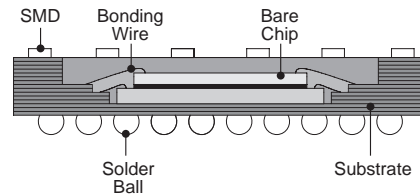

Interposer

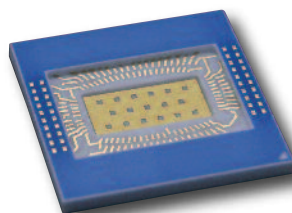

Semiconductor Package

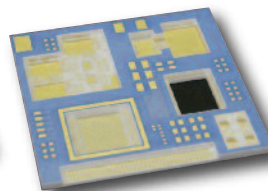

Multi-Cavity



## Surface Mount Inductors

### Open Core Wirewound Chip Inductors

#### KQT0402TK001Kit

Lead-free, 47 values 10 pcs each

#### KQ0603TK001Kit

Lead-free, 52 values 10 pcs each

#### KQ0805TK001Kit

Lead-free, 36 values 10 pcs each

#### KQ1008TK001Kit

Lead-free, 40 values 10 pcs each

#### KQC0402TK001Kit

Lead-free, 12 values 20 pcs each

#### KQC0603TK001Kit

Lead-free, 12 values 20 pcs each

### High Current Chip Inductors

#### LPC4045AK001kit

Lead-free, 19 values 25 pcs each

#### LPC4235AK001kit

Lead-free, 17 values 25 pcs each



NOTE: Reference product data pages for available values.

## Surface Mount Resistors

### Anti-Sulfur Precision Flat Chip Resistors

#### RK73H1ERT-Kit1 (0402 chip size) **NEW**

122 values, 100 pcs each.

#### RK73H1JRT-Kit1 (0603 chip size) **NEW**

122 values, 100 pcs each.

### Precision Flat Chip Resistors

#### RK73H1FTK001Kit (01005 chip size)

38 values, Lead-free, 25 pcs each (10R0 ~ 620K = ±1%).

#### RK73H1HTK001Kit (0201 chip size)

217 values, Lead-free, 50 pcs each (0, 10R0 ~ 1M00 = ±1%).

#### RK73H1ETK001Kit (0402 chip size)

122 values, Lead-free, 50 pcs each (0, 10R0 ~ 1M00 = ±1%) E-24.

#### RK73H1JTK001Kit (0603 chip size)

122 values, Lead-free, 50 pcs each (0, 10R0 ~ 1M00 = ±1%) E-24.

#### RK73H2ATK001Kit (0805 chip size)

122 values, Lead-free, 50 pcs each (0, 10R0 ~ 1M00 = ±1%).

#### RK73H2BTK001Kit (1206 chip size)

122 values, Lead-free, 50 pcs each (0, 10R0 ~ 1M00 = ±1%).

### General Purpose Flat Chip Resistors

#### RK73B1FTK001Kit (01005 chip size)

51 values, Lead-free, 25 pcs each (0, 10 ~ 1M = ±5%).

#### RK73B1HTK001Kit (0201 chip size)

139 values, Lead-free, 50 pcs each (0, 2R2 ~ 2M2 = ±5%).

### High Voltage Flat Chip Resistors

#### HV73TK001Kit (0603, 0805, 1206, 2010 chip sizes)

156 values, Lead-free, 25 pcs each (10k ~ 10M = +1%).

### Varistors

#### NV73TK001Kit (0201, 0402, 0603, 0805, 1206, 1210, 1812, 2220 chip sizes)

Lead-free, 122 values, 10 pcs each size

#### NV73DLTK001Kit (0603, 0805, 1206 chip sizes)

17 values, Lead-free, 10 pcs each size

### Surge Current Flat Chip Resistors

#### SG73TK001Kit (0603, 0805, 1206, 1210, 2010, 2512 chip sizes)

204 values, ±10%, Lead-free, 25 pcs each

#### SG73STK001Kit (0603, 0805, 1206, 1210 chip sizes)

101 values, ±1%, Lead-free, 25 pcs each

#### SG73PTK001Kit (0603, 0805, 1206, 1210 chip sizes)

97 values, ±1%, Lead-free, 25 pcs each

### Wide Terminal Flat Chip Resistors

#### WK73TK001Kit (0612, 1020, 1218 & 1225 chip sizes)

79 values, Lead-free, 25 pcs each (±1%, ±5%)

#### WU73TK001Kit (0612 chip sizes)

17 values, 20 pcs each (±1%)

NOTE: Reference product data pages for available values.

## Surface Mount Resistors (continued)

### Ultra Precision Flat Chip Resistor

#### RN73H1ET-Kit (0402 chip size)

49 values, Lead-free, 50 pcs each ( $\pm 0.1\%$ , 25ppm $^{\circ}\text{C}$ )

#### RN73H1JT-Kit (0603 chip size)

67 values, Lead-free, 50 pcs each ( $\pm 0.1\%$ , 25ppm $^{\circ}\text{C}$ )

#### RN73H2AT-Kit (0805 chip size)

73 values, Lead-free, 50 pcs each ( $\pm 0.1\%$ , 25ppm $^{\circ}\text{C}$ )

### Circuit Protection - Thermal Sensors

#### NT73TK001Kit (0603, 0805, 1206 chip sizes)

Lead-free, 53 values (1J, 2A, 2B), 10 pcs each size

### Circuit Protection - Fuses

#### CCFTK001Kit (2410 chip size)

18 values, Lead-free, 20 pcs each

#### CCPTK001Kit (1206, 1210 chip sizes)

35 values, Lead-free, 20 pcs each

#### FuseKit-TF10BN (0402 chip size)

12 values, Lead-free, 100 pcs each

#### FuseKit-TF16SN (0603 chip size)

14 values, Lead-free, 100 pcs each

#### FuseKit-TF16AT (0603 chip size)

13 values, Lead-free, 100 pcs each

NOTE: Reference product data pages for available values.

## Current Sense Resistors

### Surface Mount Molded

#### SLW07TK001Kit (2010, 1W size)

27 values, 20 pcs each ( $\pm 1\%$ ).

#### SLW1TK001Kit (2512, 1.5W size)

25 values, 20 pcs each ( $\pm 0.5\%$ ).

#### SL1TK001Kit (2512, 1W size)

58 values, 20 pcs each ( $\pm 1\%$ ).

#### SL2TK001Kit (4528, 2W size)

45 values, 20 pcs each ( $\pm 1\%$ ).

#### SL3TK001Kit (4528, 3W size)

33 values, 20 pcs each ( $\pm 1\%$ ).

#### SLN3TK001Kit (4528, 3W size)

32 values, 20 pcs each ( $\pm 0.5\%$ ).

#### SLN5TK001Kit (4528, 5W size)

21 values, 10 pcs each ( $\pm 0.5\%$ ).

#### TSL1TK001Kit (2512, 1W size)

33 values, Lead-free, 20 pcs each ( $\pm 1\%$ ).

#### PowerShuntTK001Kit (PSB, PSE, PSI)

9 values, Lead-free, 25 pcs each.

### Metal Plate

#### TLR2ATK001Kit (0805 chip size)

9 values, complete range, 20 pcs each ( $\pm 1\%$ ).

#### TLR2BWD-Kit (1206 chip size)

18 values, 15 pcs each ( $\pm 1\%$ ).

#### TLR2HWD-Kit (2010 chip size)

10 values, 15 pcs each ( $\pm 1\%$ ).

#### TLR3APD-Kit (2512 chip size)

10 values, 20 pcs each ( $\pm 1\%$ ).

#### TLRDK001Kit (1206, 1210, 2512 chip sizes)

40 values, Lead-free, complete range, 20 pcs each ( $\pm 1\%$ ).

### Chip Resistors

#### UR73TK001Kit (0402, 0603, 0805, 1206, 2512 chip sizes)

144 values, Lead-free, 20 pcs each ( $\pm 1\%$ ).

#### UR73VTK001Kit (1206 chip sizes)

8 values, 20 pcs each ( $\pm 1\%$ ).

### Thick Film

#### SR731HTK001Kit (0201 chip size)

29 values, Lead-free, 50 pcs each (R47 ~ 10R0,  $\pm 1\%$ ,  $\pm 5\%$ ).

#### SR731ETK001Kit (0402 chip size)

49 values, Lead-free, 50 pcs each (R100 ~ 1R00,  $\pm 1\%$ ).

#### SR731JTK001Kit (0603 chip size)

49 values, Lead-free, 50 pcs each (R100 ~ 10R0,  $\pm 1\%$ ).

#### SR732ATK001Kit (0805 chip size)

49 values, Lead-free, 50 pcs each (R100 ~ 10R0,  $\pm 1\%$ ).

#### SR732BTK001Kit (1206 chip size)

49 values, Lead-free, 50 pcs each (R100 ~ 10R0,  $\pm 1\%$ ).

#### SR732ETK001Kit (1210 chip size)

49 values, Lead-free, 50 pcs each (R100 ~ 10R0,  $\pm 1\%$ ).

#### SR732HTK001Kit (2010 chip size)

49 values, Lead-free, 50 pcs each (R100 ~ 10R0,  $\pm 1\%$ ).

#### SR733ATK001Kit (2512 chip size)

49 values, Lead-free, 50 pcs each (R100 ~ 10R0,  $\pm 1\%$ ).

NOTE: Reference product data pages for available values.

# STANDARD VALUES

## Significant Figures of Nominal Resistance

E-12 Decade Values					
10	12	15	18	22	27
33	39	47	56	68	82

E-24 Decade Values					
10	11	12	13	15	16
18	20	22	24	27	30
33	36	39	43	47	51
56	62	68	75	82	91

E-96 Decade Values					
100	102	105	107	110	113
115	118	121	124	127	130
133	137	140	143	147	150
154	158	162	165	169	174
178	182	187	191	196	200
205	210	215	221	226	232
237	243	249	255	261	267
274	280	287	294	301	309
316	324	332	340	348	357
365	374	383	392	402	412
422	432	442	453	464	475
487	499	511	523	536	549
562	576	590	604	619	634
649	665	681	698	715	732
750	768	787	806	825	845
866	887	909	931	953	976

E-192 Decade Values					
100	101	102	104	105	106
107	109	110	111	113	114
115	117	118	120	121	123
124	126	127	129	130	132
133	135	137	138	140	142
143	145	147	149	150	152
154	156	158	160	162	164
165	167	169	172	174	176
178	180	182	184	187	189
191	193	196	198	200	203
205	208	210	213	215	218
221	223	226	229	232	234
237	240	243	246	249	252
255	258	261	264	267	271
274	277	280	284	287	291
294	298	301	305	309	312
316	320	324	328	332	336
340	344	348	352	357	361
365	370	374	379	383	388
392	397	402	407	412	417
422	427	432	437	442	448
453	459	464	470	475	481
487	493	499	505	511	517
523	530	536	542	549	556
562	569	576	583	590	597
604	612	619	626	634	642
649	657	665	673	681	690
698	706	715	723	732	741
750	759	768	777	787	796
806	816	825	835	845	856
866	876	887	898	909	920
931	942	953	965	976	988



199 Bolivar Drive  
Bradford, PA 16701  
Phone: 814-362-5536 • Fax: 814-362-8883  
[www.KOASpeer.com](http://www.KOASpeer.com)