

# NTC Thermistor : TTC3 Series



## Φ3 mm Lead Type for Temperature Sensing/Compensation

### ■ Features

1. RoHS compliant
2. Halogen-Free(HF) series are available
3. Body size: Φ3mm
4. Radial lead resin coated
5. Operating temperature range: -40°C ~ +125°C
6. Wide resistance range
7. Cost effective
8. Agency recognition: UL / cUL / TUV / CQC

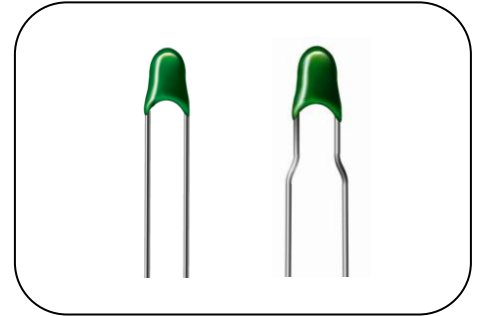

### ■ Recommended Applications

1. Home appliances
2. Computers
3. Digital meters
4. Switch mode power supplies
5. Adapters

### ■ Part Number Code

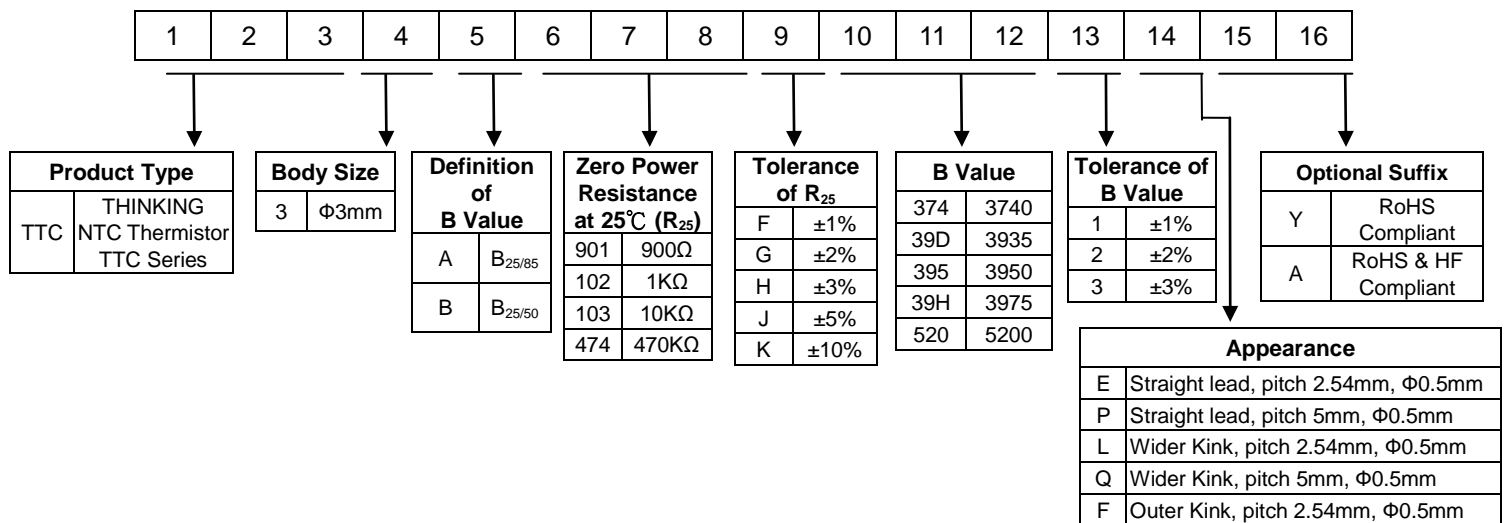

# NTC Thermistor : TTC3 Series



## Φ3 mm Lead Type for Temperature Sensing/Compensation

### Structure and Dimensions

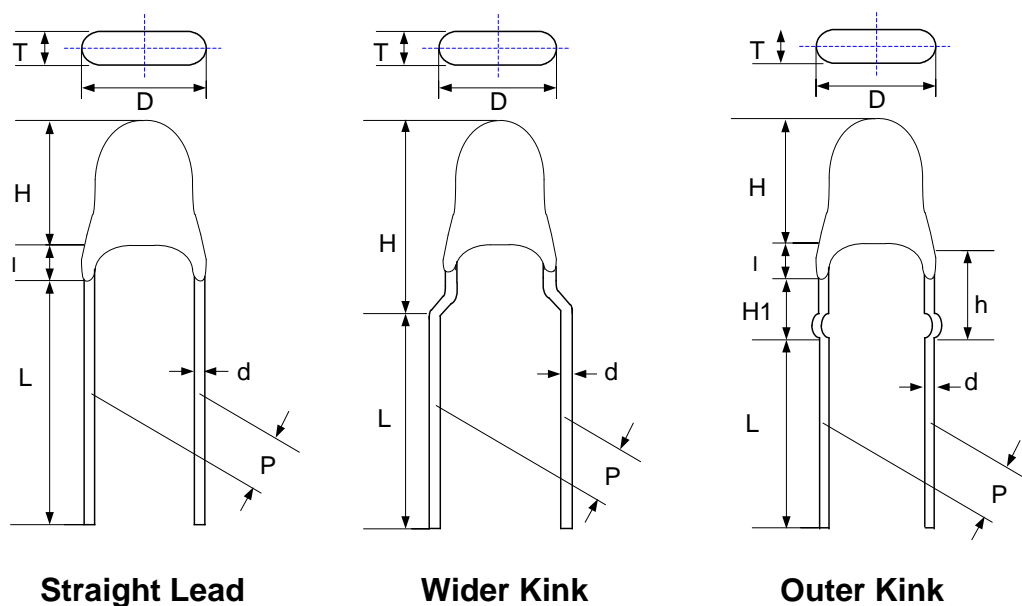

(Unit: mm)

Lead Type	P	D	T	A <sub>max.</sub>	I <sub>max.</sub>	h	L	d
Straight Lead	2.54±0.5	2.5~4.0	1.5~3.0	5	3	Note*	30~40	0.5±0.02
	5±0.5	2.0~6.5	1.5~5.0	7	3			
Wider Kink	2.54±0.5	2.0~4.0	1.5~3.0	6	--	--	30~40	0.5±0.02
	5±0.5	2.0~4.0	1.5~3.0	10	--			
Outer Kink	2.54±0.5	2.0~4.0	1.5~3.0	13.5	--	5~7	24.5~34.5	

Note\*:

Caution : It should keep the minimum distance as 6mm between the bottom of the thermistor body and PCB surface to prevent component damage.

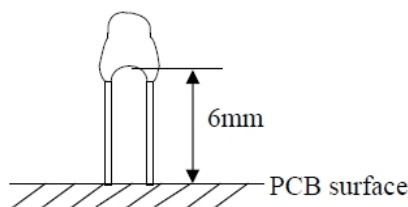

# NTC Thermistor : TTC3 Series



Φ3 mm Lead Type for Temperature Sensing/Compensation

## Electrical Characteristics

Part No.	Zero Power Resistance at 25°C	Tolerance of R <sub>25</sub> (±%)	B Value (K)	Tolerance of B value (±%)	Max. Power Dissipation at 25°C P <sub>max</sub> (mW)	Dissipation Factor δ(mW/°C)	Thermal Time Constant τ (Sec.)	Operating Temperature Range T <sub>L</sub> ~T <sub>U</sub> (°C)	Safety Approvals		
	R <sub>25</sub> (KΩ)								UL cUL	TUV	CQC
TTC3A901□39D*	0.9	1, 2, 3, 5	25/85	2, 3	150	≥ 2.5	≤ 18	-40~+125	√	√	√
TTC3A102□39D*	1								√	√	√
TTC3A152□39D*	1.5								√	√	√
TTC3A202□39H*	2								√	√	√
TTC3A222□39H*	2.2								√	√	√
TTC3A272□39H*	2.7								√	√	√
TTC3A302□39H*	3								√	√	√
TTC3A332□39H*	3.3								√	√	√
TTC3A472□39H*	4.7								√	√	√
TTC3A482□395*	4.8								√	√	
TTC3A482□39H*	4.8			√					√		
TTC3A502□39H*	5			√					√	√	
TTC3A682□39H*	6.8			√					√	√	
TTC3A103□34D*	10			√					√	√	
TTC3A103□374*	10			√					√	√	
TTC3A103□39H*	10			√					√	√	
TTC3A123□374*	12			√					√	√	
TTC3A153□374*	15			√					√	√	
TTC3A203□374*	20			√					√	√	
TTC3A203□426*	20			√					√	√	
TTC3A223□374*	22		√	√					√		
TTC3A333□409*	33		√	√					√		
TTC3A473□409*	47		√	√					√		
TTC3A503□39H*	50		√	√					√		
TTC3A503□406*	50		√	√					√		
TTC3A683□419*	68		√	√					√		
TTC3A104□419*	100		√	√					√		
TTC3A104□436*	100		√	√					√		
TTC3A154□437*	150		√	√					√		
TTC3A204□385*	200		√	√							
TTC3A224□437*	220		√	√					√		
TTC3A334□457*	330		√	√					√		
TTC3A474□457*	470	√	√	√							
TTC3A474□520*	470	√	√	√							
TTC3B202□350*	2	25/50	3500	2, 3	√	√	√				
TTC3B473□39D*	47		3935	1, 2, 3	√	√	√				
TTC3B503□440*	50		4400	2, 3	√	√	√				
TTC3B434□507*	430		5070		√	√					
TTC3B474□520*	470		5200	3	√	√	√				

Note 1: □ = Tolerance of R<sub>25</sub>

\* = Tolerance of B value

Note 2: UL/cUL File No: E138827, TUV File No: R50050155

CQC File No: CQC04001011945, CQC04001011966

Note 3: Special specifications are available upon request.

# NTC Thermistor : TTC3 Series



## Φ3 mm Lead Type for Temperature Sensing/Compensation

### Max. Power Dissipation Derating Curve

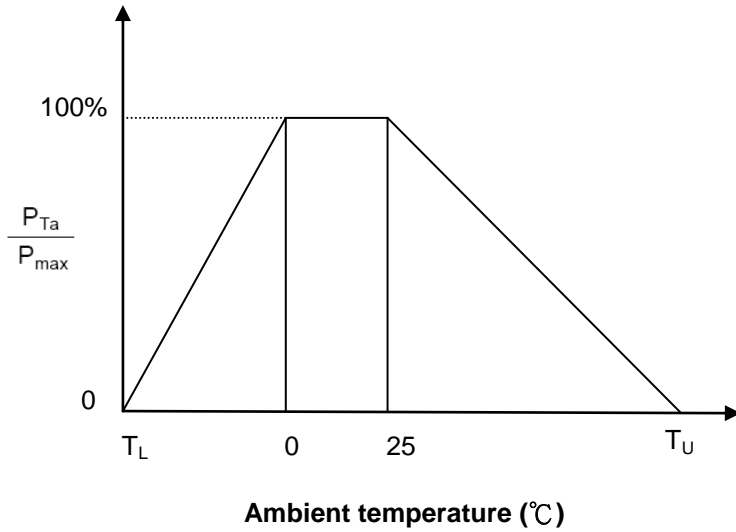

$T_U$  : Maximum operating temperature (°C)

$T_L$  : Minimum operating temperature (°C)

For example:

Ambient temperature( $T_a$ ) = 55°C

Maximum operating temperature( $T_U$ ) = 125°C

$$P_{Ta} = (T_U - T_a) / (T_U - 25) \times P_{max} = 70\% P_{max}$$

### R-T Characteristic Curves

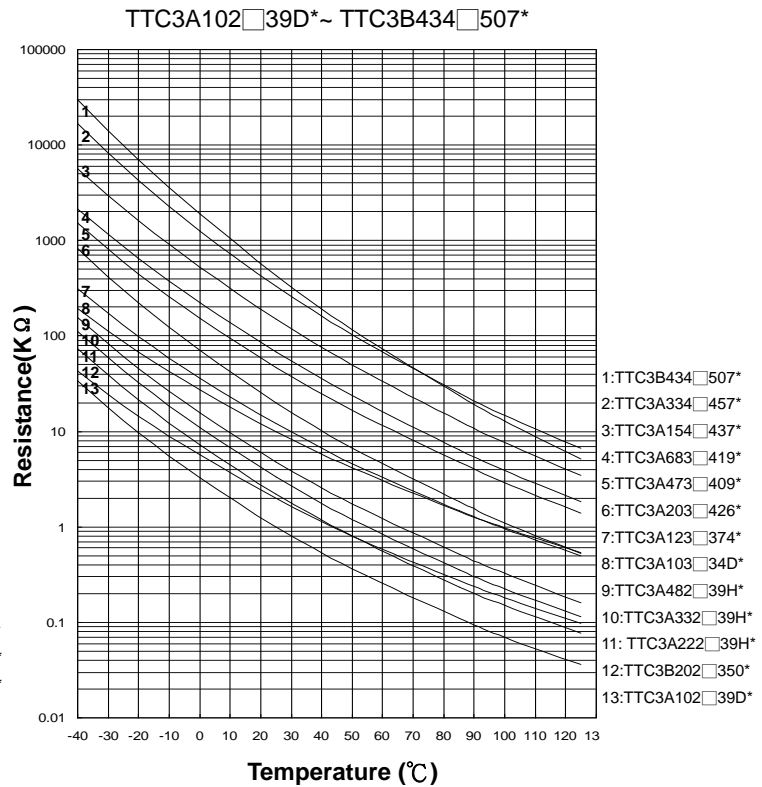
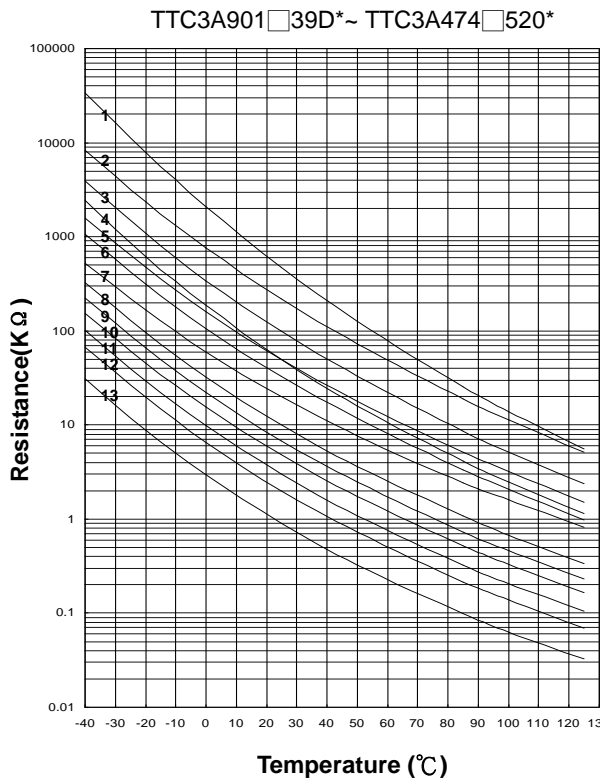

# NTC Thermistor : TTC3 Series



Φ3 mm Lead Type for Temperature Sensing/Compensation

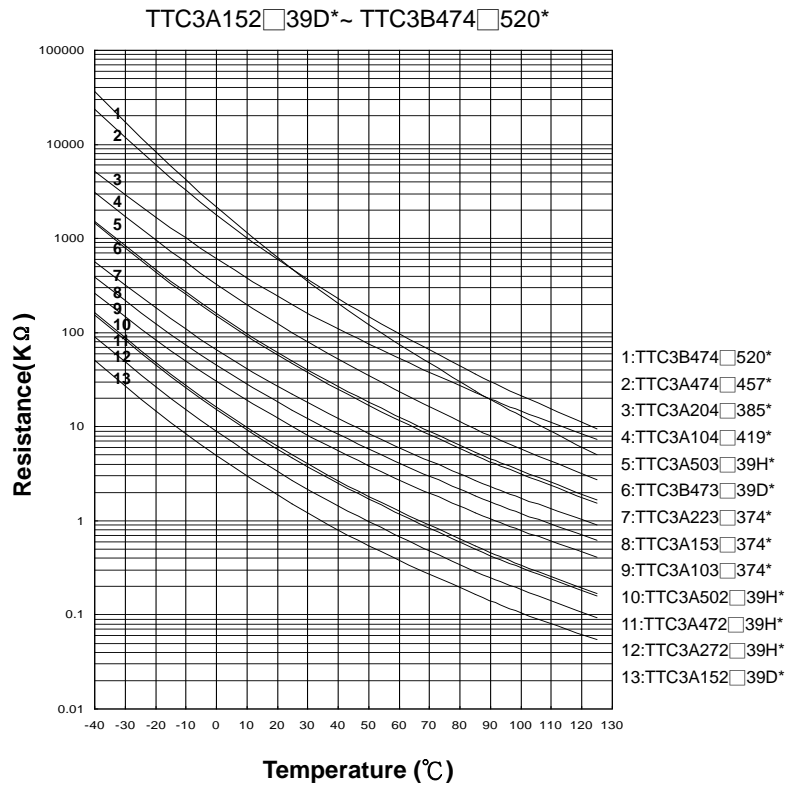

## ■ Soldering Recommendation

### ● Wave Soldering Profile

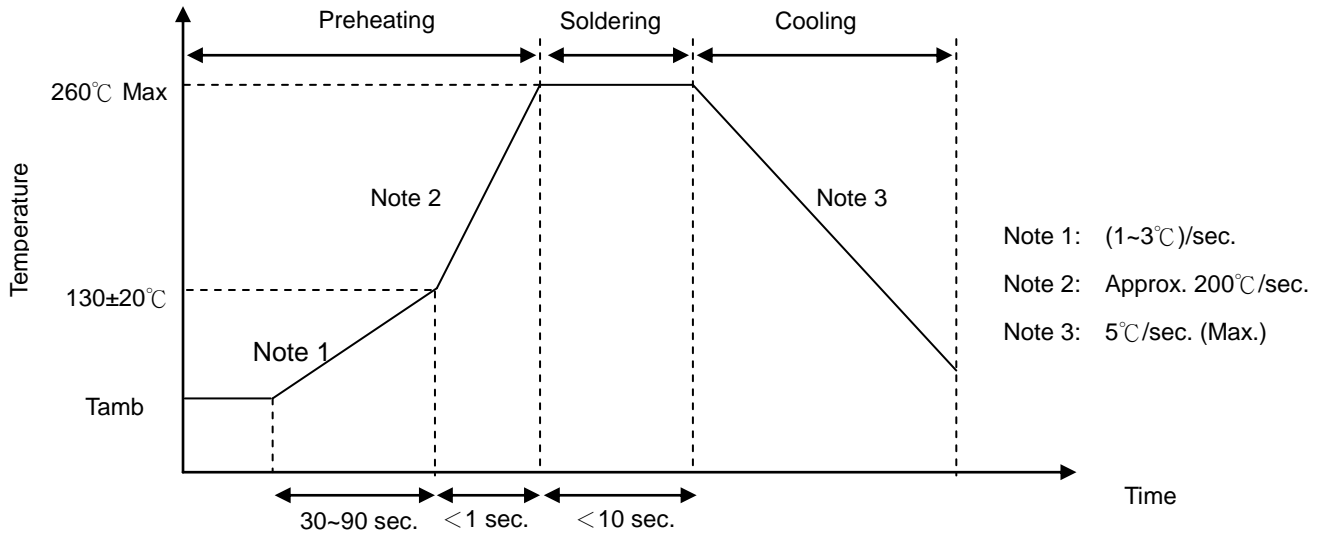

### ● Recommended Reworking Conditions with Soldering Iron

Item	Conditions
Temperature of Soldering Iron-tip	360°C (max.)
Soldering Time	3 sec. (max.)
Distance from Thermistor	2 mm (min.)

# NTC Thermistor : TTC3 Series



## Φ3 mm Lead Type for Temperature Sensing/Compensation

### ■ Reliability

Item	Standard	Test conditions / Methods	Specifications															
Tensile Strength of Terminations	IEC 60068-2-21	<p>Gradually apply the specified force and keep the unit fixed for 10±1 sec.</p> <table border="0"> <tr> <td style="text-align: center;">Terminal diameter (mm)</td> <td style="text-align: center;">Force (Kg)</td> </tr> <tr> <td style="text-align: center;"><u>0.3&lt;d≤0.5</u></td> <td style="text-align: center;"><u>0.5</u></td> </tr> </table>	Terminal diameter (mm)	Force (Kg)	<u>0.3&lt;d≤0.5</u>	<u>0.5</u>	No visible damage											
Terminal diameter (mm)	Force (Kg)																	
<u>0.3&lt;d≤0.5</u>	<u>0.5</u>																	
Bending Strength of Terminations	IEC 60068-2-21	<p>Hold specimen and apply the force specified below to each lead. Bend the specimen to 90°, and then return to the original position. Repeat the procedure in the opposite direction.</p> <table border="0"> <tr> <td style="text-align: center;">Terminal diameter (mm)</td> <td style="text-align: center;">Force (Kg)</td> </tr> <tr> <td style="text-align: center;"><u>0.3&lt;d≤0.5</u></td> <td style="text-align: center;"><u>0.25</u></td> </tr> </table>	Terminal diameter (mm)	Force (Kg)	<u>0.3&lt;d≤0.5</u>	<u>0.25</u>	No visible damage											
Terminal diameter (mm)	Force (Kg)																	
<u>0.3&lt;d≤0.5</u>	<u>0.25</u>																	
Solderability	IEC 60068-2-20	245±3 °C, 3±0.3 sec.	Inspection shall be carried out with the assistance of a magnifier capable of giving a magnification of 4x to 10x. At least 95% of terminal electrode is covered by new solder. The dipped surface shall be covered with a smooth and bright solder coating with no more than small amounts of scattered imperfections such as pin-holes or unwetted or de-wetted areas. These imperfections shall not be concentrated in one area.															
Resistance to Soldering Heat	IEC 60068-2-20	260 ± 3°C, 10 ± 1 sec.	No visible damage   Δ R <sub>25</sub> /R <sub>25</sub>   ≤ 3 %															
High Temperature Storage	IEC 60068-2-2	125 ± 5°C, 1000 ± 24 hrs	No visible damage   Δ R <sub>25</sub> /R <sub>25</sub>   ≤ 5 %															
Damp Heat, Steady State	IEC 60068-2-78	40 ± 2°C, 90~95% RH, 1000 ± 24 hrs	No visible damage   Δ R <sub>25</sub> /R <sub>25</sub>   ≤ 3 %															
Rapid Change of Temperature	IEC 60068-2-14	<p>The conditions shown below shall be repeated 5 cycles</p> <table border="1"> <thead> <tr> <th>Step</th> <th>Temperature (°C)</th> <th>Period (minutes)</th> </tr> </thead> <tbody> <tr> <td>1</td> <td style="text-align: center;">-40 ± 5</td> <td style="text-align: center;">30 ± 3</td> </tr> <tr> <td>2</td> <td style="text-align: center;">Room temperature</td> <td style="text-align: center;">5 ± 3</td> </tr> <tr> <td>3</td> <td style="text-align: center;">125 ± 5</td> <td style="text-align: center;">30 ± 3</td> </tr> <tr> <td>4</td> <td style="text-align: center;">Room temperature</td> <td style="text-align: center;">5 ± 3</td> </tr> </tbody> </table>	Step	Temperature (°C)	Period (minutes)	1	-40 ± 5	30 ± 3	2	Room temperature	5 ± 3	3	125 ± 5	30 ± 3	4	Room temperature	5 ± 3	No visible damage   Δ R <sub>25</sub> /R <sub>25</sub>   ≤ 3 %
Step	Temperature (°C)	Period (minutes)																
1	-40 ± 5	30 ± 3																
2	Room temperature	5 ± 3																
3	125 ± 5	30 ± 3																
4	Room temperature	5 ± 3																
Max. Power Dissipation	IEC 60539-1 4.26.3	25 ± 5°C, Pmax., 1000 ± 24 hrs	No visible damage   Δ R <sub>25</sub> /R <sub>25</sub>   ≤ 5 %															

# NTC Thermistor : TTC3 Series



## Φ3 mm Lead Type for Temperature Sensing/Compensation

### ■ Packaging

#### ● Taping Specification

#### Straight Lead

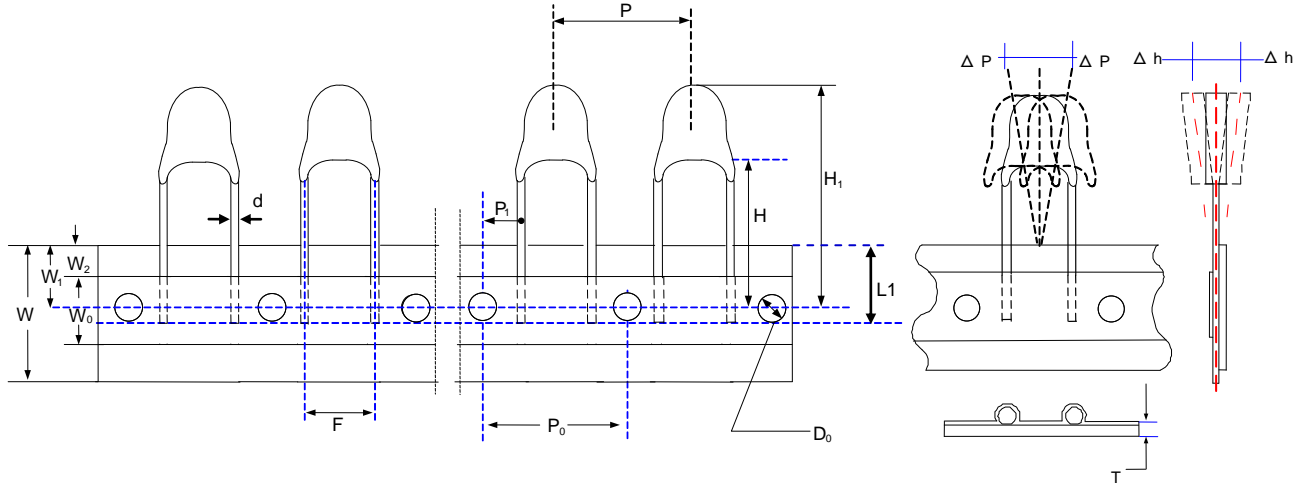

(Unit: mm)

Taping Dimension	P <sub>0</sub>	F	P	P <sub>1</sub>	H	H <sub>1</sub>	d	W <sub>0</sub>	W <sub>1</sub>	W <sub>2</sub>	W	ΔP	Δh	L <sub>1</sub>	D <sub>0</sub>	T
	±0.3	±0.5	±1	±0.7	+2/-0	Max.	±0.02	±1.5	+0.75 /-0.5	Max.	+1/ -0.5	Max.	Max.	±1	±0.2	±0.2
P <sub>0</sub> =12.7	12.7	2.54	12.7	5.08	18	25	0.5	12	9	3	18	1	2	10	4	0.6
	12.7	5.00	12.7	3.85	18	25	0.5	12	9	3	18	1	2	10	4	0.6
P <sub>0</sub> =15.0	15.0	2.54	15.0	6.23	18	25	0.5	12	9	3	18	1	2	10	4	0.6
	15.0	5.00	15.0	5.00	18	25	0.5	12	9	3	18	1	2	10	4	0.6

#### Wider Kink

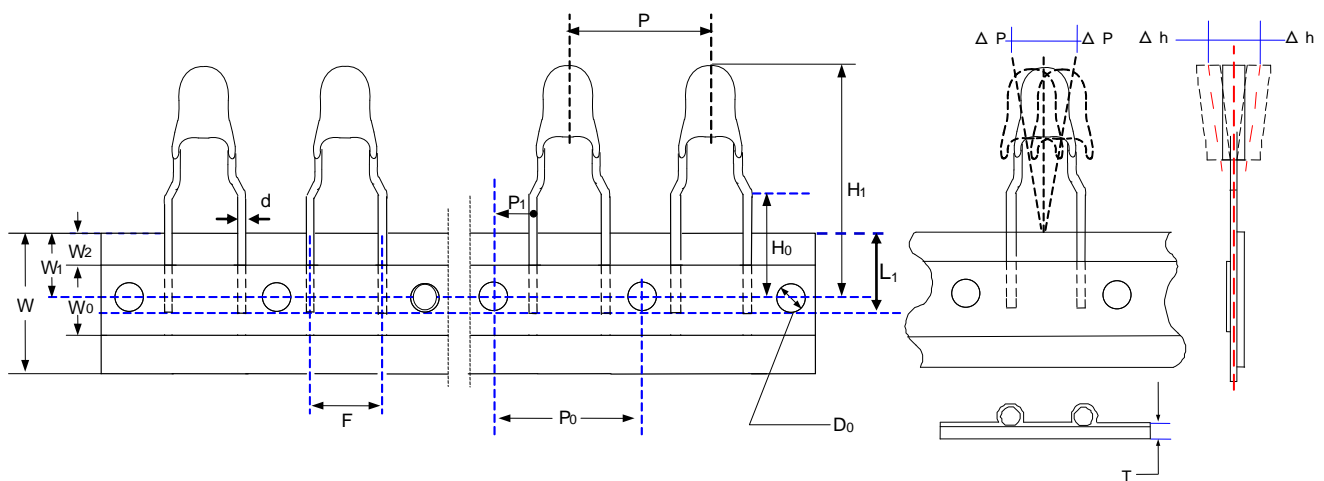

(Unit: mm)

Taping Dimension	P <sub>0</sub>	F	P	P <sub>1</sub>	H <sub>0</sub>	H <sub>1</sub>	d	W <sub>0</sub>	W <sub>1</sub>	W <sub>2</sub>	W	ΔP	Δh	L <sub>1</sub>	D <sub>0</sub>	T
	±0.3	±0.5	±1	±0.7	±0.5	Max.	±0.02	±1.5	+0.75 /-0.5	Max.	+1/ -0.5	Max.	Max.	±1	±0.2	±0.2
P <sub>0</sub> =12.7	12.7	2.54	12.7	5.08	16	26	0.5	12	9	3	18	1	2	10	4	0.6
	12.7	5.00	12.7	3.85	16	26	0.5	12	9	3	18	1	2	10	4	0.6

# NTC Thermistor : TTC3 Series



## Φ3 mm Lead Type for Temperature Sensing/Compensation

### Outer Kink

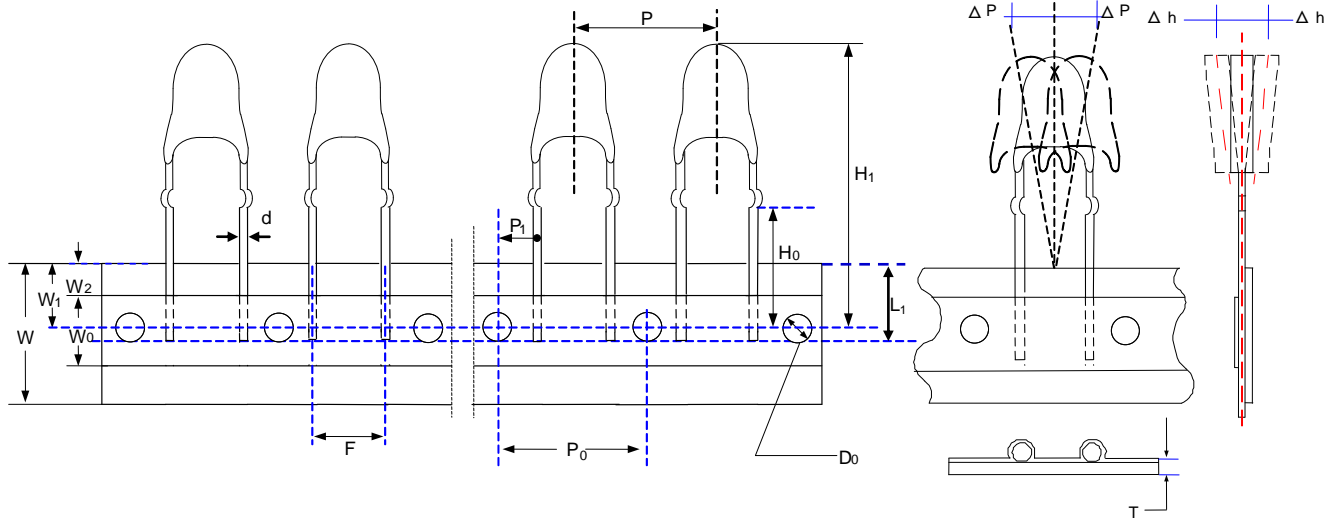

(Unit: mm)

Taping Dimension	P <sub>0</sub>	F	P	P <sub>1</sub>	H <sub>0</sub>	H <sub>1</sub>	d	W <sub>0</sub>	W <sub>1</sub>	W <sub>2</sub>	W	ΔP	Δh	L <sub>1</sub>	D <sub>0</sub>	T
	±0.3	±0.5	±1	±0.7	±0.5	Max.	±0.02	±1.5	+0.75 /-0.5	Max.	+1/ -0.5	Max.	Max.	±1	±0.2	±0.2
P <sub>0</sub> =12.7	12.7	2.54	12.7	5.08	16	26	0.5	12	9	3	18	1	2	10	4	0.6

### Quantity

#### ● Bulk Packing

Series	Quantity (pcs/bag)
TTC3	500

#### ● Reel Packing

Series	Quantity (pcs/reel)
TTC3	2,500

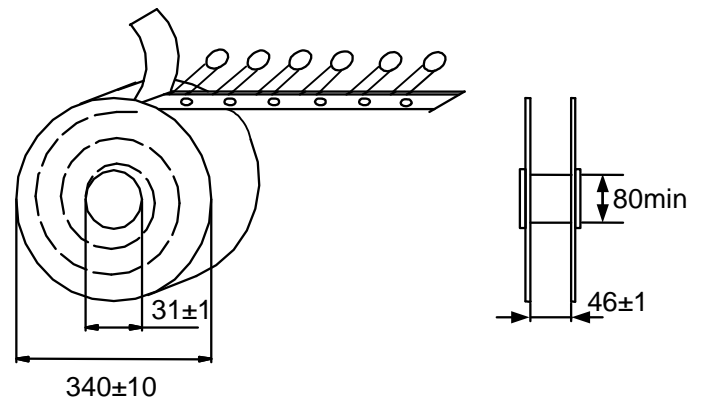

(Unit: mm)

#### ● Ammo Packing

Series	Quantity (pcs/box)
TTC3	2,500

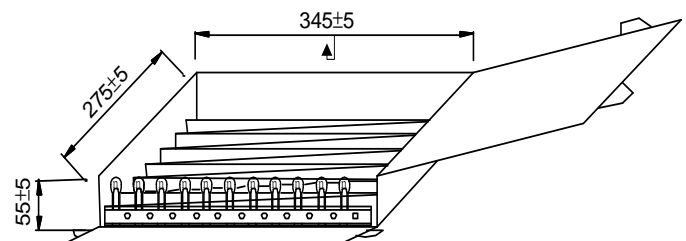

### Warehouse Storage Conditions of Products

#### ● Storage Conditions:

1. Storage Temperature: -10°C ~ +40°C
2. Relative Humidity: ≤ 75%RH
3. Keep away from corrosive atmosphere and sunlight.

#### ● Period of Storage : 1 year