

# Vicfuse

*Circuit Protection Products*

*..... Safe & Green.....*



Semiconductor Protection Fuses  
DC Fuses  
Special Purpose Fuses  
General Purpose Fuses  
Fuse Holders/Fuse Bases  
Fuse Switch Disconnectors  
Little Fuses And Accessories  
ESD/GDTs/SPDs



Product Cross Reference Chart

	VICFUSE	BUSSMANN	MERSEN	SIBA	Ampere Rating	Voltage Rating	
Semiconductor Protection Fuses	VRA	FWA	A15QS	*	70A-6000A	150V AC/DC	
	VRX	FWX	A30QS	*	35A-4500A	300V AC/DC	
	VRH	FWH	A50QS	*	35A-1600A	500V AC/DC	
	VRP	FWP	A70QS	*	5A-1200A	700V AC/DC	
	VRJ	FWJ	A100P	*	35A-2000A	1000V AC/DC	
	VRK	FWK	A120X	*	0.5A-30A	1200V AC/1000V DC	
	VRL	FWL/FWS	A150X	*	10A-1000A	1500V AC/1000V DC	
	VR10F/T	KTK	A60Q	60033/60034	0.1A-30A	600V AC/DC	
	VSP	170M	PSC	20***	40A-8000A	600V/1000V/1250V AC	
	VBS1028	LCT	URE	50076	5A-32A	250V AC/150V DC	
	VBS1727	LET	URGS/URZ	50053	7A-180A	250V AC	
	VBS3627	LMT	URGG	50054	7A-525A	250V AC	
	VBS1051	CT	URE	50077	5A-20A	690V AC/600V DC	
	VBS1749	ET/FE	URS	50073	12A-90A	690V AC	
	VBS3655	FM/MT	URR/URGL	50074	50A-400A	690V AC	
	2xVBS3627	LMMT	URGH	50071	300A-1050A	250V AC	
	2xVBS1749	EET/FEE	URT	*	65A-160A	690V AC	
	2xVBS3655	MMT	URGM	50071	175A-800A	690V AC	
	DC Fuses	VC10	FWA/FWC	FR10GR	*	5A-32A	150V AC/DC,700V AC/DC
		VC14	FWA/FWJ/FWP	URC	50***	1A-60A	150V-1000V
VC20		FWK/FWP/FWJ	*	*	2A-30A	750VAC/DC,1000V DC	
VC22		FWP	URS	50***	20A-100A	700V AC	
VC25		FWK	URGD/URQ/URS/URB	50***	35A-60A	750V AC	
TPS		*	*	*	2A-600A	80V DC	
VD		170E/170F	DC Series	90***	6A-200A	750V DC-4200V DC	
VDC14		FWH	FD14GB	51***	2A-50A	440V DC	
VDC20		FWK	FD20GB	90080	0.8A-63A	100V DC/1500V DC	
VDC22		FWP	FD22GB	51***	50A-100A	440V DC	
VDC27		*	FD27GB	*	0.8A-160A	440V DC/660V DC	
VDC36		*	FD36GB	90094	0.8A-100A	1000V-4000V DC	
Special Purpose Fuses		PV10/14/160/355 /630/NH/XL	PV	HP10M/A150X	5021**/20028 **/20031**	1A-160A	1000V DC or less
	VT1/2/3/4/5	TPS/TPN/TPL	TGS/TGN/TGL	*	1A-800A	170V DC	
General Purpose Fuses	NT/NH	NT/NH	NH	NH	2A-1600A	500V/690VAC,250V/440VDC	
	VGC8/10/14/22	C08G/C10G/C14G/C22G	150**/160**/170** /180**	*	0.5A-125A	250V/400V/500V/600V/690V AC	
	VCF/VCT	FNQ-R/KTK-P/LP-CC	ATMR/ATDR	*	0.5A-30A	600V AC,300V/600V DC	
	VJF/VJT	LPJ-SP/JKS	A4J/HSJ	*	1A-600A	600V AC,175V/200V DC	
	VLT	KLU/KRP/KTU	A4BY/A4BT	*	200A-6000A	600V AC,300V AC	
	VKF/VKT	KTN-R/KTS-R/LPN-RK-SP	A2D/A6D	*	1A-600A	250V/600V AC	
	VTF	JJS/JJN	A3T/A6T	*	1A-1200A	300V/600V AC	
	VGT	SC	AG	*	0.5A-60A	480V/600V AC	
	VRK5	DLN/DLS/FRN/FRS /KWS	OT/OTN/OTS	*	0.1A-600A	250V/600V AC	
	BS88 0B/1B/2B/3B/4B	EFS	BS88-2 B1X/B1/B2/B3/B4	*	2A-800A	415V/550V AC,250V DC	
	BS881A/2A/3A/4A	*	BS88-2A1/A2/A3/A4 /A4X	*	2A-800A	415V/550V AC,250V DC	
	BS88 1F/2F	SSD/NSD/ESD*	BS88-2 F1/F2	*	2A-800A	415V/550V AC,250V DC	
	BS88 1C/2C/3C	*	BS88-C1/C2/C3	*	2A-800A	415V/550V AC,250V DC	

■ **Fuses:**

Device that by the fusing of one more of its specially designed and proportioned components opens the circuit in which it is inserted by breaking the current when this exceeds a given value for a sufficient time . The fuse comprises all the parts that form the complete device.

■ **熔断器:**

一种装置，当通过该装置的电流超过规定值持续足够的时间，该装置中的一个或多个经特殊设计，特殊配比的元件熔断，断开其接入的电路，从而切断电流。熔断器包括构成整个装置的所有零件。

■ **Low voltage fuses:**

This kind of fuse with rated breaking capacities of not less than 6kA is intended for protecting power-frequency a.c. circuits of nominal voltages not exceeding 1000V or d.c. circuits of nominal voltages not exceeding 1500V.

■ **低压熔断器:**

该熔断器可作为保护标称电压不超过 1000V 的交流工频电路或者电压不超过 1500V 的直流电路用，并且其额定分断能力不小于 6KA。

IEC 60269 has four main chapters

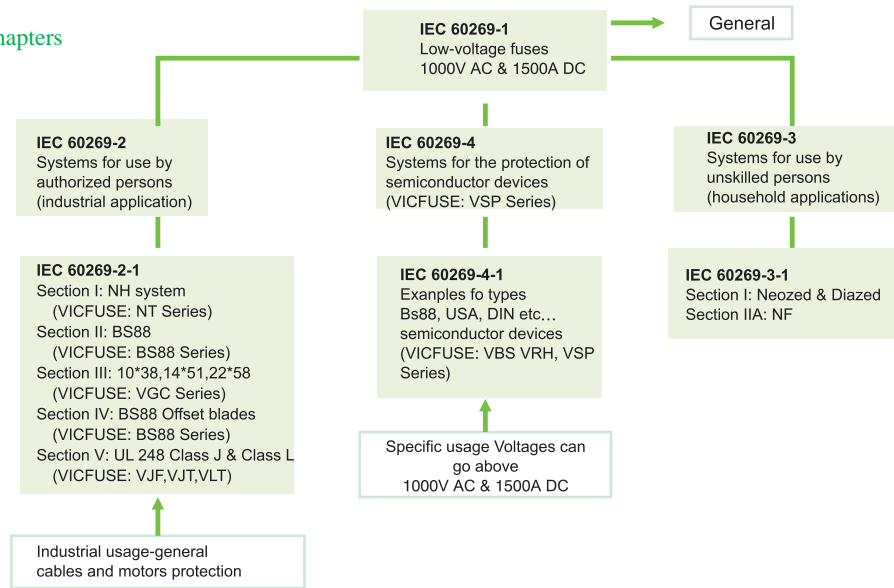

■ **Two large family of fuses:**

“a” type fuses: designed for short circuits only, They are not able to interrupt low overloads. They have a “partial” operating range.

“g” type fuses: designed to interrupt overloads and short circuits. They have a full operating range.

■ **熔断器的分断范围与使用类别:**

第一个字母表示分断范围；第二个字母表示使用类别。

“a” 类别熔断器：局部范围分断能力熔断器；常做短路保护；

“g” 类型熔断器：全范围分断能力熔断器；用来做干线保护，有过载保护和短路保护功能。

Fuse TYPE	TYPICAL INDUSTRIAL APPLICATIONS	OPERATING RANGE
aM	Motor circuits protection against short circuit only	PARTIAL RANGE
aR	IEC 269-4 fuse for semiconductor protection	
gG	General purpose fuse essentially protection	Full RANGE
gM	Motor protection	
gN	North American fast acting fuse for general purpose applications, mainly for conductor protection. As per UL 248 class J and class L fuses.	
gD	North American general purpose time-delay fuse for motor Protection and conductor protection. (for example: fuse class VJT, VRK5 and ect).	
gTR	Transformer protection	
gR , gS	IEC 269-4 semiconductor protection and conductor protection.	
gL , gF, gL	Former type of fuses for conductor protection replaced Today by the gG fuses.	

### Selection Guide

#### ■ Selection guide for semiconductor protection fuses and DC fuses

Semiconductor protection fuses are very fast specifically designed for the protection of power semiconductors such as IGBT, IGCT, GTO, SCR and etc. Generally, semiconductor devices have a very expensive and very limited over-load capacities. Therefore, it is worth to produce fuses which are more sensitive to overloads and more sensitive to overloads and which can operate more quickly than the conventional designs.

Semiconductor protection fuses have lower let-through  $I^2t$  and arc voltage than do traditional fuses. These fuses in accordance with IEC 60269-4 have traditionally been “partial range” or “back-up” fuses and are given the designation or utilization category of “aR”. As protection solutions and practice have developed, there is a growing need for fuses with “full range” breaking capacity. Therefore, two kinds of full range breaking capacity classifications were introduced into IEC 60269-4 namely “gR” and “gS” in 2002. gR fuses are optimized to low  $I^2t$  and “gS” optimized to low power dissipation.

The follower figure shows a typical semiconductor protection fuse. Usually, pure silver strips are serving as fuse element (or elements). Recently, some manufactures are also trying to take bimetal strips as alternatives. These strips have some regions of reduced crosssectional area, often named notches. Fuse elements embedded in the fuses body with sands are wedding to the contacts. The structure formed by fuse bodies and terminal plate provide a confined space for arc extinguish

### 选型指南

#### ■ 半导体保护熔断器及直流熔断器的选型指南

半导体保护熔断器是专为功率半导体器件如 IGBT、IGCT、GTO、SCR 等提供保护的快速熔断器，半导体产品非常昂贵，但承受过载能力非常有限。因此，必须制造过载更灵敏，分断更迅速的熔断器对其提供保护。

相对于传统的熔断器，半导体保护熔断器具有较低的  $I^2t$  及弧电压。其设计符合标准 IEC60269-4，常被成为“局部范围”或“后备”保护熔断器，现归类为“aR”型熔断器。随着被保护产品功率的提高及性能的发展，“全范围”保护熔断器的使用需求呼声越来越高。因此，2002年“gR”和“gS”两类具有全范围分断能力的熔断器划分到了 IEC 60269-4 中。其中，gR 类在低  $I^2t$  上占优势，而 gS 类在低功率耗方面占优势。

下图是典型的半导体保护熔断器示意图。熔体由片状纯银带构成。近年来，一些制造商也致力于采取铜银复合带作为替代品。这些片状熔体在狭径部分为银，链接部位是铜。熔体焊接在触刀上，而熔体与石英砂都处于管体内部。管体和两端盖板构成一个封闭的空间灭弧

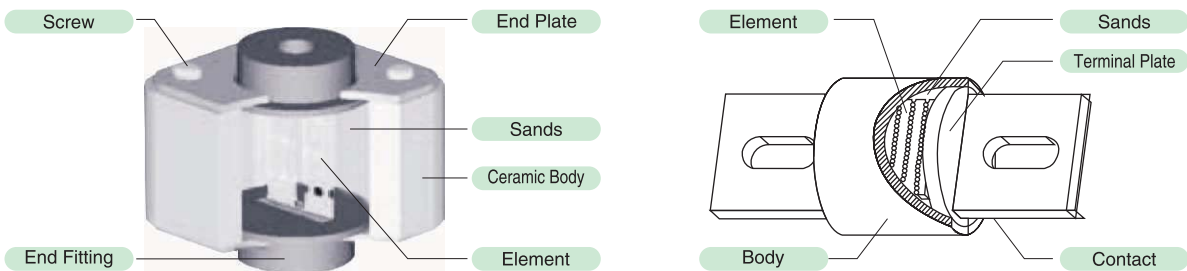

## Rated voltage $U_n$

- 1) IEC requires AC voltage tests to be performed at 110% of the rated voltage and power factors between 10 and 20 percent.
- 2) UL requires all fuses should be tested at their rated voltage and power factors between 15 and 20 percent.
- 3) But in AC/DC combinations, like the six-pulse bridge, if the converter is regenerative meaning that It's able to return energy to the supply to cope with this increase in voltage. The rated voltage of the fuse should be  $U_n \geq 1.8U_{ac}$

## 额定电压 $U_n$

- 1) IEC 规定熔断器交流电压在额定电压的 110%，功率因素在 10-20%进行测试。
- 2) UL 标准规定所有熔断器在额定电压，功率因素在 15-20%进行测试。
- 3) 在 AC/DC 设备中，如 6 相整流桥中，如果发生短路，DC 端的电压在瞬间增加在 AC 端，故此时保险丝的额定电压须为  $U_n \geq 1.8U_{ac}$

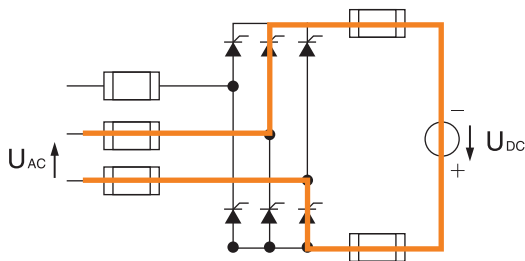

## Arc Voltage $U_L$

This curve gives the peak arc voltage,  $U_L$ , which may appear across the fuse during its operation as a function of the applied working voltage,  $U_g$ , (RMS) at a power factor of 15%

## 电弧电压 $U_L$

熔断器熔断时将产生电弧电压，电弧电压峰值一般为故障电路电压（RMS）的 2 倍，最高不超过 2.5 倍。不应超过半导体元件的瞬态阻断电压。

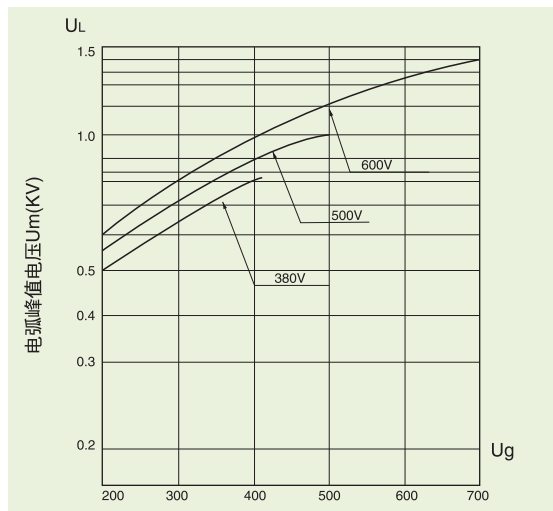

工作电压  $U_g$  (V)  
≤660V 的电弧峰值电压曲线

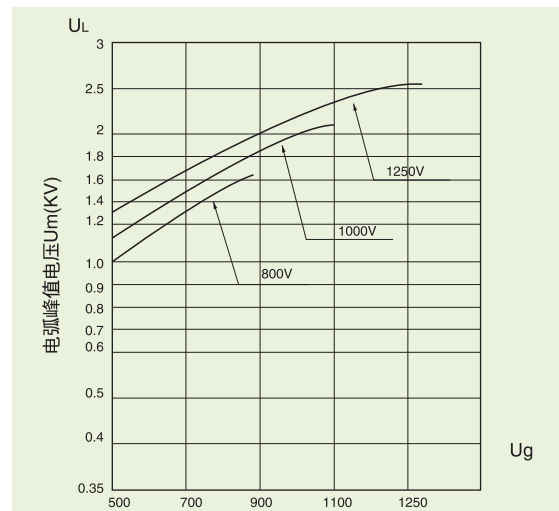

工作电压  $U_g$  (V)  
≥800V 的电弧峰值电压曲线

■ **Temperature Correction Curve Kc**

The rated current value of our fuses is based on the ambient temperature in the space below the fuse of fuse of 25°C up to 30°C max. The following graph gives correction factors Kc for a range of temperatures -40°C to +80°C.

Altitude: IEC defines normal atmospheric operating conditions. Regarding the altitude, it's generally below 2000M.

For altitude above 2000M, the fuse's rated current is derated by 0.5% every 100M.

■ **温度折减率曲线 Kc**

熔断器的额定电流定义在温度为 20°C 最大不超过 30°C，左图给出了从 -40°C 到 +80°C 时的温度修正曲线。

高海拔对熔断器的使用影响：IEC 标准规定，熔断器在海拔 2000 米下使用性能不受影响；高过 2000 米海拔高度，每升高 100 米，熔断器的额定电流减少 5%。

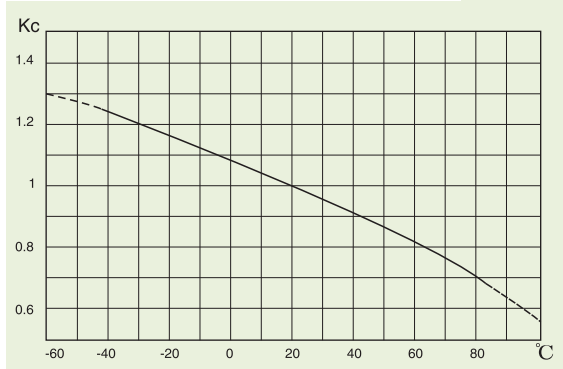

温度修正曲线

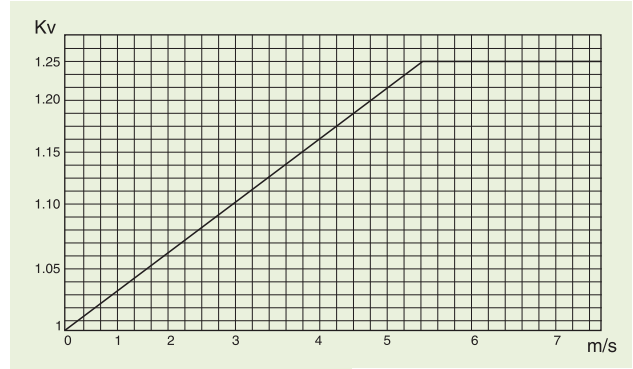

风速修正系数曲线

■ **Forced cooling correction**

IF forced air is used to cool the the fuse in working, the continuous current rating of the fuse may be increased, by multiplying the rated current by a coefficient Kv. The value of the correction coefficient used by vicfuse is shown in the right chart above. Kv increases linearly with air speed up to 5m/s. Further increase in air speed does not improve the fuse cooling. The limiting value Kv is typically 1.25, Often , box mounted fuses are given an additional Kv factor of 0.8.

■ **冷却时间 Kv**

如果采用风冷方式对工作中的熔断器进行降温，则熔断器的负载在风速为 5 米/秒时的系数为 1.25，高过此风速对熔断器的额定负载无影响，通常封闭环境内的 Kv=0.8

■ **High-Frequency effect coeffent Kf**

The stated AC rated voltage of vicfuse's fuses are valid at frequencies from 45HZ to 1000HZ. Below or over this scope will be corrected from the following fig.

If even lower frequencies tends behave more like DC, the rated voltage, rated current and melting time are depend on the time constant L/R.

■ **频率条件 Kf**

半导体熔断器在交流电流中工作的额定频率为 50 或 60HZ 最宜，当工作频率达到 45Hz 以下或者 1KHz 以上时，须按图示频率进行修正。

如果半导体熔断器用于直流电路时，其额定电压，额定电流及熔断时间与该电路中的时间常数 L/R 有关。

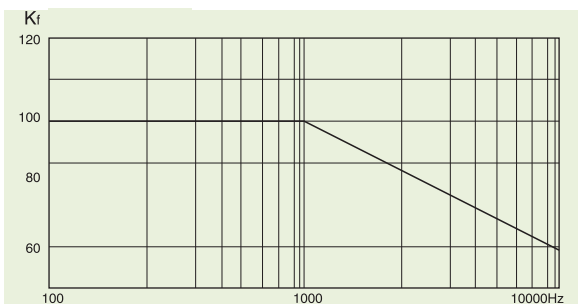

频率修正系数曲线

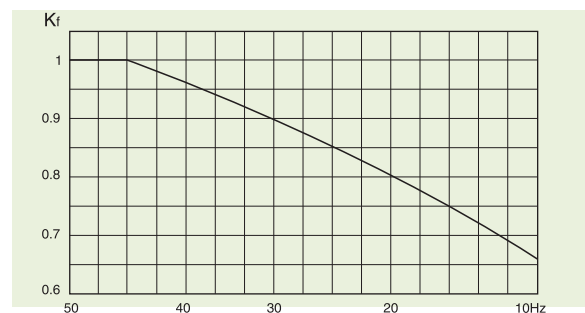

低频率修正系数曲线

■ **Overload Current of Circuit I<sub>max</sub>**

“Overload” is generally used for excess current flowing in a circuit which is electrically sound. Overload currents are usually not much greater than the normal fullload current of the system. As a rough rule, the overload is less than 8 or 10 times the current rating.

The imposed max overload current I<sub>max</sub> is related with the duration and the frequency of occurrence. While select a fuse for the application, it is helpful to utilize the time/current curve of the fuse and the formula “I<sub>max</sub> < factor%×I<sub>t</sub>”. It can be read from the time/current curve for a certain t. The general guidelines are listed as follow:

■ **过载电流 I<sub>max</sub>**

“过载”通常针对于正常工作电路中出现的过电流。通常过载电流都不会太大于系统的正常满载电流。一般情况下，过载电流约小于8或10倍额定电流。

电路中允许的最大过载电流 I<sub>max</sub> 与持续电流 I<sub>t</sub> 及发生频率相关。在熔断器选型时，熔断器的时间/电流曲线以及公式 “I<sub>max</sub> < factor% × I<sub>t</sub>” 是非常有用的。持续电流 I<sub>t</sub> 可以从时间/电流曲线上的特定时间 t 的对应点得到，基本原则如下：

Frequency of Occurrence	Overloads 过载	
	> 1 sec	< 1 sec
Less than once per month	I <sub>max</sub> < 80%×I <sub>t</sub>	I <sub>max</sub> < 70%×I <sub>t</sub>
Less than twice per week	I <sub>max</sub> < 70%×I <sub>t</sub>	I <sub>max</sub> < 60%×I <sub>t</sub>
Several times per day	I <sub>max</sub> < 60%×I <sub>t</sub>	I <sub>max</sub> < 70%×I <sub>t</sub>

■ **Total Clearing I<sup>2</sup>t**

The total clearing I<sup>2</sup>t at rated voltage and power factor of 15% are given in the electrical characteristics, as shown in the left chart following. Generally, total I<sup>2</sup>t and melting I<sup>2</sup>t. For other voltages, the clearing I<sup>2</sup>t is found by multiplying by correction factor, K, given as a function of applied working voltage, U<sub>v</sub>, (RMS).

■ **熔断 I<sup>2</sup>t**

熔断 I<sup>2</sup>t 是指在额定电压及预期额定分流电流 (RMS) 如 50KA、100KA、200KA 及实验回路总的 COS=0.15 时，熔断实验所测得的熔断能量积分值。由弧前 I<sup>2</sup>t 和熔断 I<sup>2</sup>t 组成。熔断 I<sup>2</sup>t 随电路电压的降低而减少，不同电压下的熔断 I<sup>2</sup>t 修正系数如下：

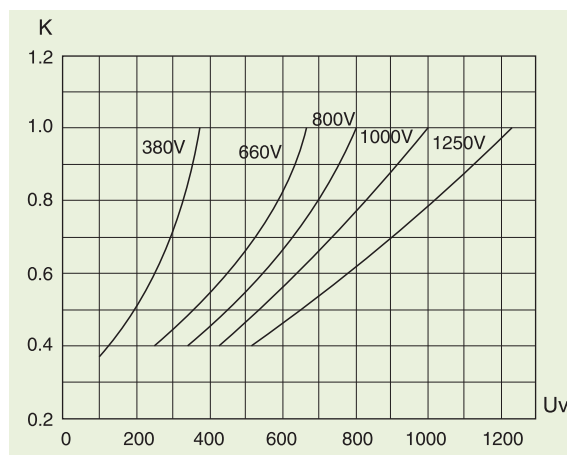

I<sup>2</sup>t 修正曲线



## Power Losses P

Watts loss at rated current is given in the electrical characteristics. The curve allows the calculation of the power losses at load currents lower than the rated current. The correction factor,  $K_p = \frac{P}{P_n}$ , is given as a function of the RMS load current,  $I_b = \frac{I}{I_n}$ .

## 功耗 P

熔断器的额定耗散功率是指在额定电流下耗散功率。熔断器通过电流时温度升高，熔体的电阻变大，耗散功率随之增大。熔断器实际电流的耗散功率  $P = K_p I_a^2 R$ 。  $K_p = P/P_n = F(I/I_n)$  耗散功率修正系数如下。

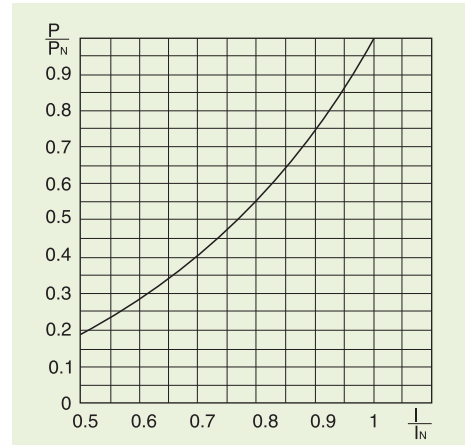

耗散功率与电流修正曲线

## Short-circuit Current Rating (SCCR)

SCCRs on components and equipment represent the maximum level of short-circuit current that the component of equipment can withstand and is used for determining compliance with NEC® 110.10. This rating can be marked on individual components or assemblies

## 短路电流 (SCCR)

根据 NEC® 110.10 的规定，熔断器和其他器件标示的短路电流等级表示它所能承受的最大短路电流。

## Conductor Size

The RMS current ratings of VICFUSE's fuses are based on standard sized conductor between 1A to 1.6A/mm<sup>2</sup>. Using smaller or larger conductors will affect the fuses' current rating.

## 连接线缆的线径

接线缆的线径选择电流密度标准为 1A-1.6A/mm<sup>2</sup>

## The A-A Curve

In the melting curve, there is an A-A curve which only for aR fuse types. Melting or loading beyond this curve is forbidden. It's due to the risk of thermal overload which might reduce the fuses' interrupting capacity.

## A-A 曲线说明

在 aR 类熔断器的 I-T 曲线内，特别给出了 A-A 曲线，熔断器不能超过该曲线使用。

## Fuses in Parallel

When fuses are in Parallel, the current rating can be two times the current rating of one fuse in case of two fuses, but it becomes 90% the rating of 1 body multiplied by the number of fuses for 3 or more fuses in parallel once the following conditions are full filled:

Distance between the two same length fuses must be 10 mm at least but less than 30mm and keep the fuses' resistance within 5%

## 熔断器并联

当两个或 3-4 个等长的熔断器满足：

熔断器的安装间距至少 10mm 但低于 30mm；熔断器的冷态电阻差别小于 5%时，2 个熔断器并联的流通能力是单个熔断器的 2 倍；3-4 个熔断器并联的单个流通能力仅能达到单个熔断器的 90%。



### ■ AC Fuses in DC Circuits

If AC Fuses are Used in DC motor and drive circuits, The inductance in a DC circuit limits the rate of current rise. The time spent for the current to reach 63 percent of the final value is called the time constant, also referred to in terms of L/R. The dimensioning parameters will be the system DC-voltage, the minimum short-circuit current and the associated maximum time constant(L/R).

Many circuits have the time constant of between 10 and 20 milliseconds and thus IEC specifications require testing between these values. Time constants longer than 20milliseconds are not often found outside of traction third rail applications, where long rail lengths give extremely high inductance to resistance ratios.

For further information, please contact us.

### ■ 交流熔断器在直流电压下的应用

如果交流熔断器使用在直流电机或直流驱动电路中，直流电路中产生的电感会阻碍电流变大。电流变化达到最终有效值的 63% 所耗费的时间被称作时间常数 (L/R)，它和电路中的直流电压和短路电流有关。

大多数电路中的时间常数为 10 到 20 毫秒，这也是 IEC 规定要求测试的数据。超过 20ms 的电路除了轨道交通（长线路导致产生额外的高电感）外非常少见。

需要了解直流熔断器的更多信息，请联系我们。

### ■ Selection criteria of a semiconductor fuse:

Voltage Rating:  $V_{fuse} > V_{fault}$

Current Rating:  $I_{fuse} > I_{RMS}$

Total clearing  $I^2t$ :  $I^2t_{total} < I^2t_{semiconductor(junction or case)}$

Interrupting:  $IR_{fuse} > IR_{fault}$

Arc Voltage:  $V_{fuse arc} < V_{semiconductor}$

### ■ 半导体保护熔断器选型需考虑:

额定电压:  $V_{fuse} > V_{fault}$

额定电流:  $I_{fuse} > I_{RMS}$

总  $I^2t$ :  $I^2t_{total} < I^2t_{semiconductor(junction or case)}$

分断能力:  $IR_{fuse} > IR_{fault}$

电弧电压:  $V_{fuse arc} < V_{semiconductor}$

### ■ Example

Considering a circuit should withstand some occurrence of overload current and need for short-circuit current protection. Then the VSP 400A700V FS-K would be taken as an example.

VSP 400A700V FS-K is designed according to IEC 60269(690V), and it is certificated by UL (700V). The total  $I^2t$  is  $103.6 \times 10^3 A^2s$ , the breaking capacity is 100KA(700V), the max arc voltage is about 1300V while the applied voltage is 700V.

Therefore, the  $U_{ac max}$  in a circuit should be less than 700V;

The R.M.S. value in the circuit  $I_{R.M.S} < 400A$ ;

The total  $I^2t$  of the the semiconductor junction or the semiconductor case rupture should be larger than  $103.6 \times 10^3 A^2s$ ;

The short circuit current  $I_{fault}$  should be less than 100kA;

The max reverse voltage of the semiconductor should be less than 1300V while the applied voltage is 700V;

The imposed max overload current  $I_{max}$  should be less than 570A while an overload occurs one time per hour and last for 60 sec. It is calculated from the expression  $I_{max} < 60\% \times I_t$  with  $I_t$  read from the time/current curve of VSP 400A700V FS-K.

While all the situation in the circuit satisfying the above conditions, VSP 400A700V FS-K is the right fuse you are looking for .if not, try another one.

### ■ 举例:

考虑一个应能承受一定过载电流情况及需要短路保护的电路。这里以 VSP 400A700V FS-K 为例。

VSP 400A700V FS-K 是依据标准 IEC 60269 (690V) 设计的，通过了 UL (700V) 认证。总  $I^2t$  为  $103.6 \times 10^3 A^2s$ ，分断能力为 100KA (700V)，700V 时的最大弧电压约为 1300V。

此时，电路中的  $U_{ac max}$  应小于 700V；

电路中的 R. M. S 值  $I_{R.M.S} < 400A$ ；

该半导体总  $I^2t$  应该小于  $103.6 \times 10^3 A^2s$ ；

短路电流  $I_{fault}$  应小于 100KA；

700V 时，半导体的最大反向电压应小于 1300V；

若每小时发生一次持续 60S 的过载，允许的最大过载电流  $I_{max}$  应小于 570A。这个值可以有  $I_{max} < 60\% \times I_t$  进行计算， $I^2t$  可以从 VSP 400A700V FS-K 的时间电流曲线进行读取。

如果电路中的条件满足如上述情况，VSP 400A700V FS-K 是您要选择的熔断器。如果不是，请尝试另外一个规格。



**Description:**

VSP series square body fuses are designed for semiconductor protection. It can provide protection for semiconductor, rectifier, AC/DC drive and UPS, etc. VICFUSE fuses have been engineered to provide state-of-the-art protection for SCRS, diodes, thyristors, GTOS and IGBT devices. They have die-cut elements embedded in solidified sand which helps control arcing characteristics for low  $I^2t$  and high in interrupting rating. All contact surfaces are silver are silver paltes and all hardware is non-magnetic

**Features:**

- . Designed according to IEC60269, DIN43620 GB13539
- . Complying with CE and RoHS
- . UL/CUL certified (File No. E356490)
- . Multiple mounting configurations

- Terminal FS (Flush End)
- Terminal D11 (DIN 43653)
- Terminal FB (French Style)
- Terminal AB (US Style)
- Terminal BB (Buss-bar Style)
- Terminal D08 (DIN 43620)
- . Operating class: aR or gG

**Ratings:**

Voltage Rating: 690V-1250V  
Current Rating: 10A-7500A  
Interrupt Rating: 100kA-200kA

● **Terminal type:**

Terminal type code	Terminal type
FS	Terminal FS
D11	Terminal D11
FB	Terminal FB
AB	Terminal AB
BB	Terminal BB
D08	Terminal D08

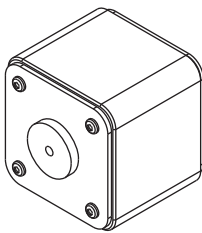

Terminal FS

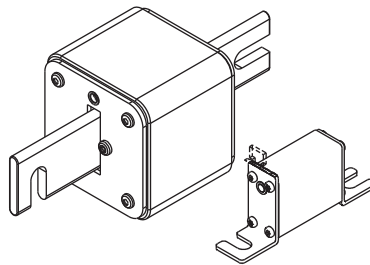

Terminal D11(L or LL)

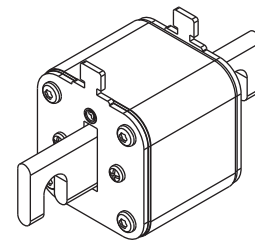

Terminal FB

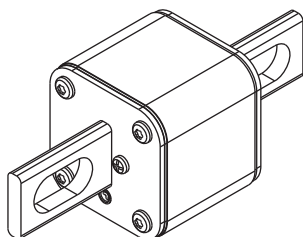

Terminal AB (L or LL)

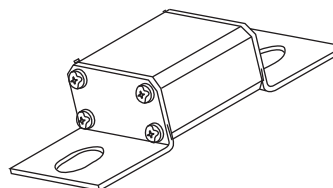

Terminal BB

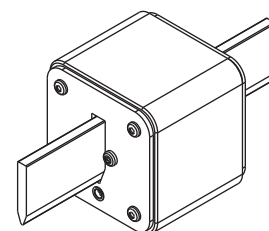

Terminal D08

### ● Electrical Specifications:

**Ordering Information:**

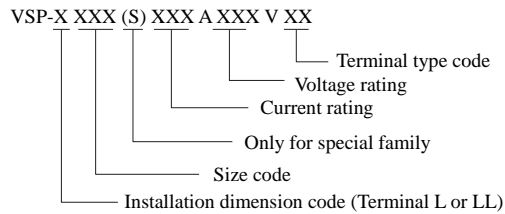

Size code	Maximum cross section size of body
000	21×36 □
00	30×47 □
0	30×65 □
A	45×45 □
B	53×53 □
C	61×61 □
D	68×68 □
E	76×76 □
F	78×78 □
G	85×85 □
H	105×105 □
I	118×118 □

**Notes:**

For size code, size B is defaulted

While terminal type is optional, the terminal type code should be indicated

Immediately behind the voltage rating, and the D11 type is default;

Indicator is optional and followed by a indicator code while indicator is necessary, such as V for visual Indicator (default), T for type T indicator, K for type K indicator.

While microswitch is necessary, the terminal type code should be followed by "M"

While gR / aR are optional, aR is default and gR should follow the indicator code.

Eg. VSP-A 200A690V FSM-K-gR

**V-Visual Indicator**

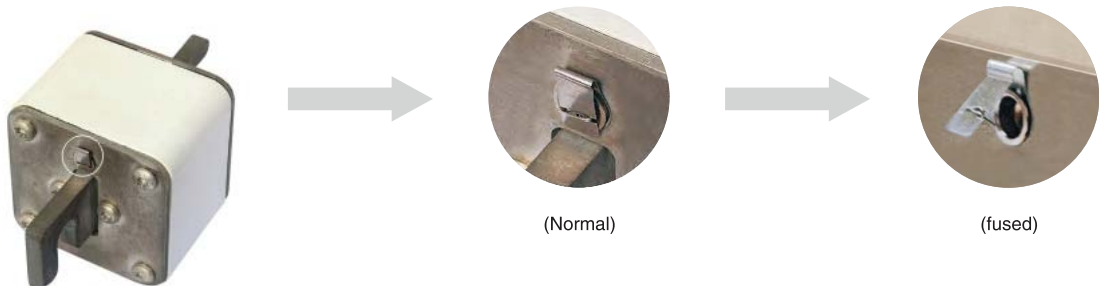

**Type T indicator**



● **Electrical Specifications:**

**Type K indicator**

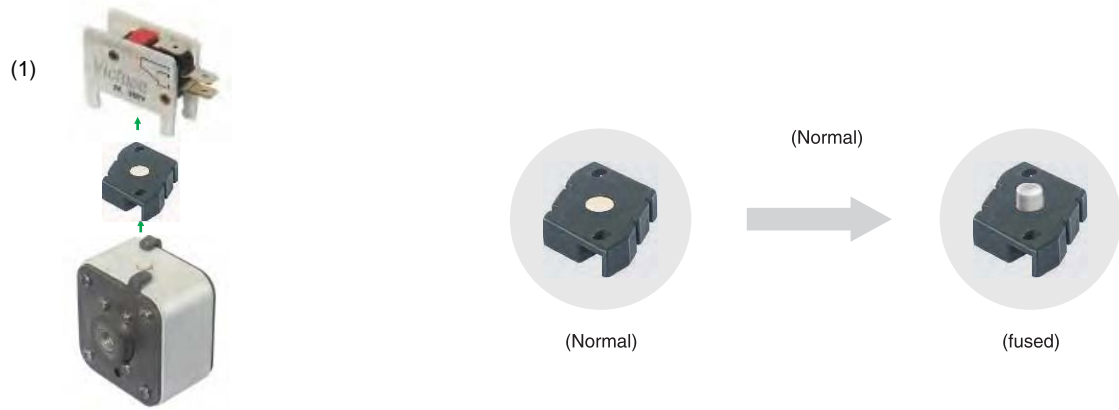

● **Mechanical Dimensions:**

(Micro Switch VMS-S)

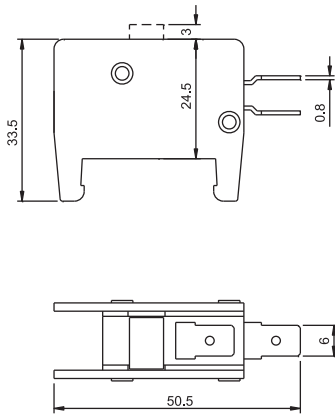

(Single)

(Micro Switch VMS-D)

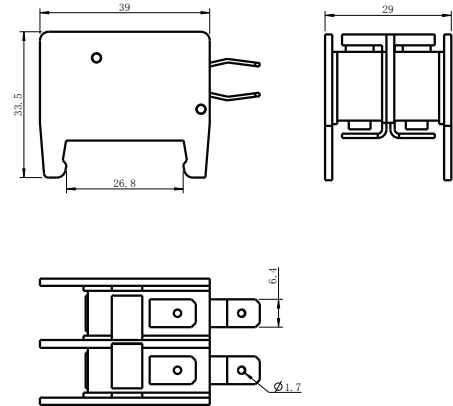

(Double)

(Micro Switch VTMS)

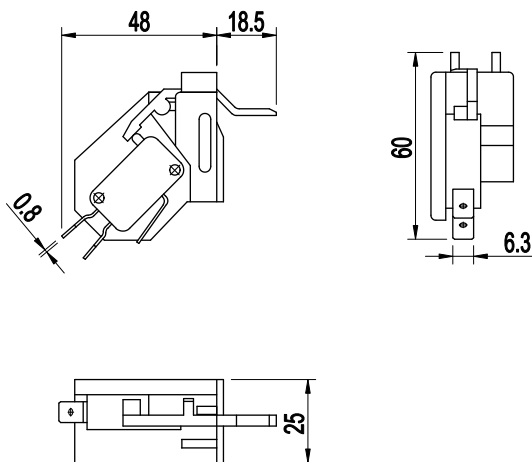

RoHS



**Ratings:**

Voltage Rating: 690V (IEC) AC  
700V (UL) AC  
Current Rating: 40A-4500A  
Interrupt Rating: 200kA

**Mechanical Dimensions:**

(Size A-E)

(Size H)

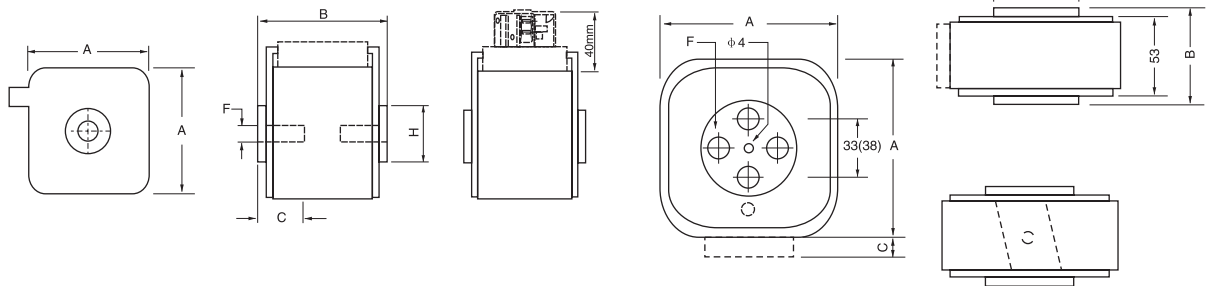

Size	Current Rating(A)	Mechanical Dimensions(mm)				
		A	B	C	H	F
A	40-630	45	51	5	F17	M8
B	200-900	53	51	8	F20	M8
C	400-1250	61	51	10	F24	M10
E	500-2000	76	53	10	F30	M12
H	1000-4000	105	67	15	F56	M10

**Electrical Characteristics:**

(Size A-E)

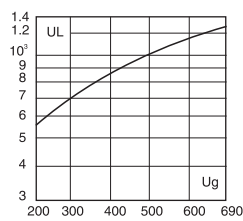

Arc Voltage

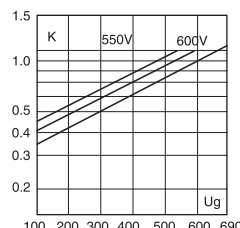

Total Clearing I<sup>2</sup>t

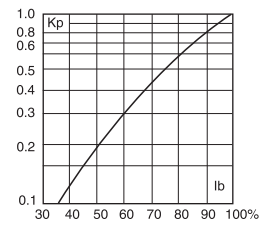

Power Losses

(Size H)

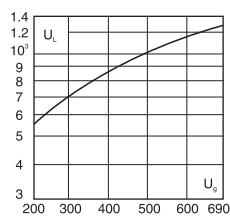

Arc Voltage

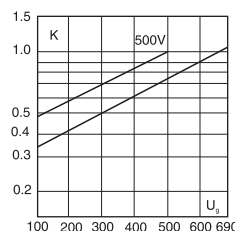

Total Clearing I<sup>2</sup>t

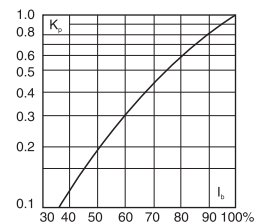

Power Losses

● Electrical Specifications:

Catalog Numbers	Current Rating(A)	Pre-arc I <sup>2</sup> t(A <sup>2</sup> S)	Clearing I <sup>2</sup> t(A <sup>2</sup> S,660V)	Power Loss (W)	Voltage Rating	Interrupt Rating	Remark
VSP-A	40	39	260	9	690V	200kA	aR
	50	74	490	11			
	63	110	735	14			
	80	176	1200	18			
	100	344	2350	20			
	125	524	3550	25			
	160	1050	7150	29			
	200	2010	14500	34			
	250	4000	27500	38			
	315	6660	44800	48			
	350	9500	65100	53			
	400	14300	99750	58			
	450	20000	133000	62			
	500	25800	171000	67			
550	32500	219000	72				
630	46100	309000	76				
VSP-B	200	1580	10925	43	690V	200kA	aR
	250	3000	19950	53			
	315	5900	39900	56			
	350	8100	56100	57			
	400	12900	87000	66			
	450	16200	114000	67			
	500	24000	162000	69			
	550	32500	219000	72			
	630	50000	332500	76			
	700	66100	441900	81			
800	100000	689000	91				
900	148000	809000	96	600V	200kA	aR	
VSP-C	400	10500	70800	62			690V
	450	14800	99750	67			
	500	20500	138000	72			
	550	26800	181000	77			
	630	39000	262000	86			
	700	58000	385000	91			
	800	82500	548000	100			
	900	120000	799000	105			
1000	175000	1190000	110				
1100	235000	1560000	116				
1250	349000	2300000	125				
VSP-E	500	13500	90500	91	690V	200kA	aR
	550	19000	129000	96			
	630	30000	199800	101			
	700	42500	289000	106			
	800	66500	443000	112			
	900	96000	638000	117			
	1000	135000	898000	120			
	1100	182000	1236000	126			
	1250	280000	1856000	133			
	1400	355000	2338000	148			
	1500	440000	2980000	153			
	1600	555000	3720000	154			
1800	838000	4990000	161	500V			
2000	1095000	6035000	170	500V			
VSP-H	1000	73000	480000	167	690V	200kA	aR
	1250	138000	923000	188			
	1400	198000	1350000	196			
	1600	293000	1960000	210			
	2000	580000	3780000	235			
	2500	1150000	7500000	265			
	3000	1930000	13000000	293			
	3500	3090000	21000000	312			
4000	4469000	26800000	340	500V			

RoHS



**Ratings:**

Voltage Rating: 690V (IEC) AC  
 700V (UL) AC  
 Current Rating: 1000A-7500A  
 Interrupt Rating: 200kA

**Mechanical Dimensions:**

(Size 2×E)

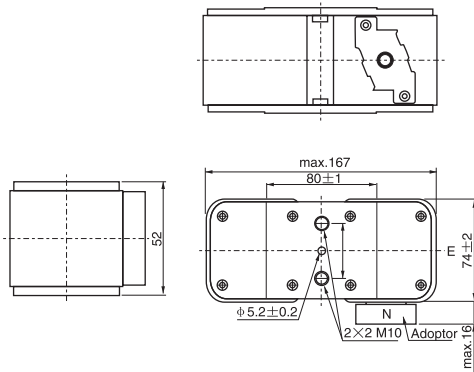

(Size 2×H)

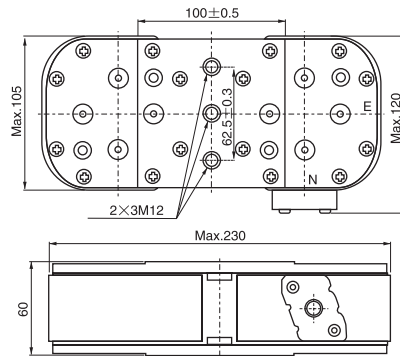

**Electrical Characteristics:**

(Size 2×E)

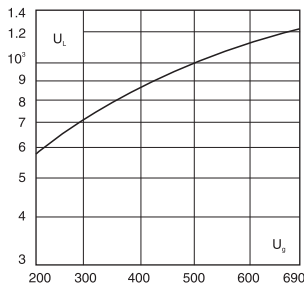

Arc Voltage

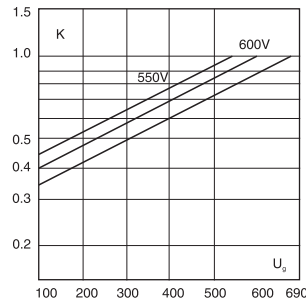

Total Clearing I<sup>2</sup>t

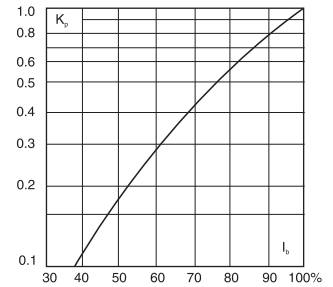

Power Losses

(Size 2×H)

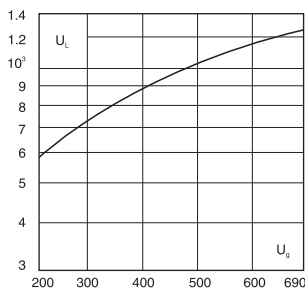

Arc Voltage

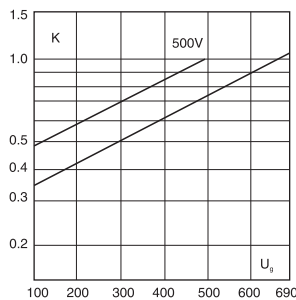

Total Clearing I<sup>2</sup>t

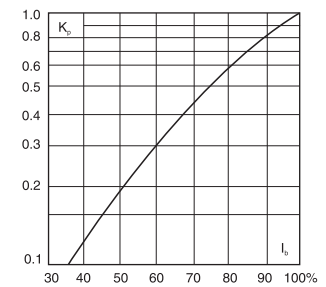

Power Losses



### ● Electrical Specifications

Catalog Numbers	Current Rating(A)	Pre-arc $I^2t(A^2S)$	Clearing $I^2t(A^2S)$	Power Loss (W)	Voltage Rating	Interrupt Rating	Remark
2×VSP-E	1000	79000	510000	163	660V	200kA	aR
	1100	91000	609000	179			
	1250	149000	999000	187			
	1400	191000	1290000	205			
	1500	232000	1580000	209			
	1600	310000	2060000	217			
	1800	430000	2900000	223			
	2000	610000	4000000	231			
	2200	770000	5190000	243			
	2500	1190000	8060000	254			
	3000	2150000	14900000	276			
	3500	3290000	20000000	306			
	4000	4800000	26500000	331			
2×VSP-H	2000	327000	2190000	327	690V	200kA	aR
	2500	620000	4170000	380			
	3000	1070000	7000000	411			
	3500	1730000	11800000	470			
	4000	2600000	17300000	500			
	4500	3690000	24600000	517			
	5000	5190000	34800000	533			
	5500	7090000	47800000	536			
	6000	9200000	61200000	555			
	6500	11900000	79000000	580			
	7000	14700000	96800000	611			
7500	17800000	89000000	632				
				500V			

### ● Electrical Characteristics

Time-Current Curve

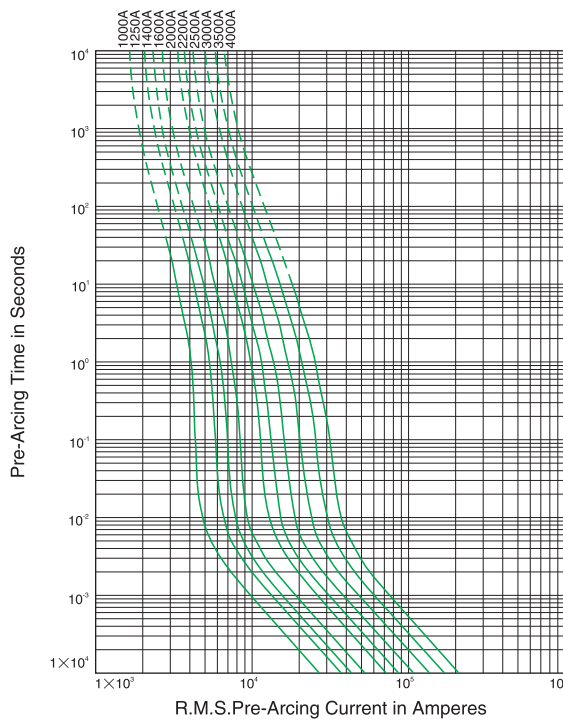

Peak Let-Through Curve

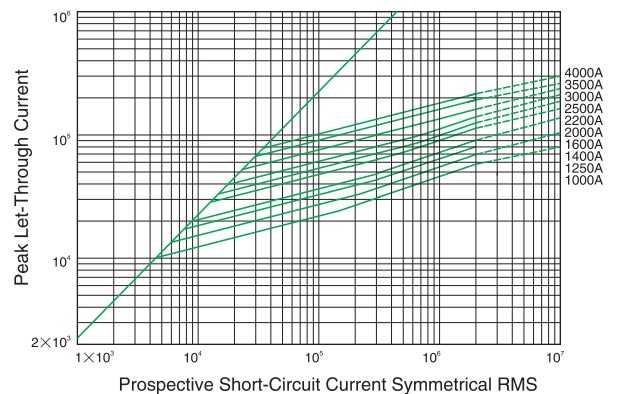

RoHS



**Ratings:**

Voltage Rating: 690V (IEC) AC  
700V (UL) AC  
Current Rating: 10A-2000A  
Interrupt Rating: 100kA-200kA

**Mechanical Dimensions:**

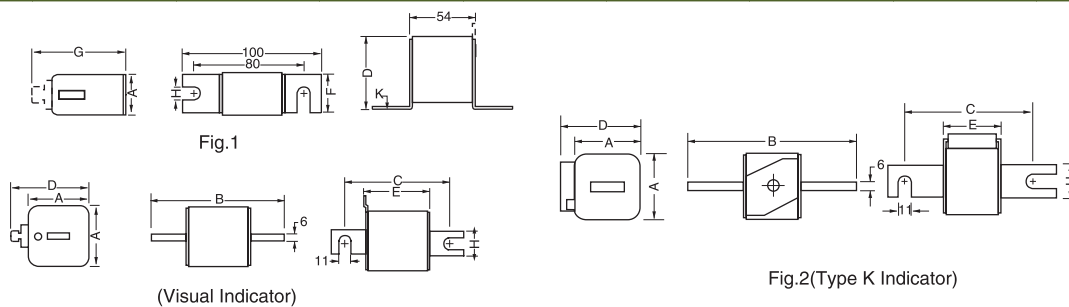

Size	Ref. Fig.	Mechanical Dimensions(mm)					
		A	D	F	G	H	K
000	1	21	40	20	51	8	2
00	1	30	51	28	67	10	2

Size	Ref. Fig.	Mechanical Dimensions(mm)							
		A	B(L)	B(LL)	C(L)	C(LL)	D	E	H
A	2	45	104	134	78	108	58	50	22
B	2	53	108	138	78	108	66	50	25
C	2	61	108	138	78	108	75	50	25
E	2	76	109	139	78	108	90	51	30

**Electrical Characteristics:**

(Size 00/000))

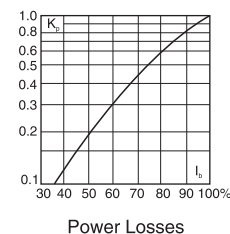
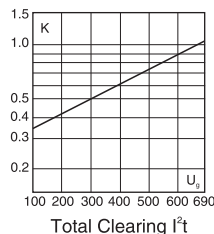
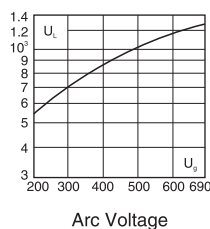

(Size A-E)

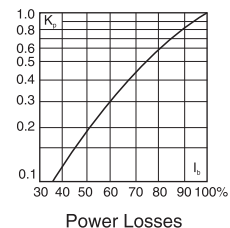
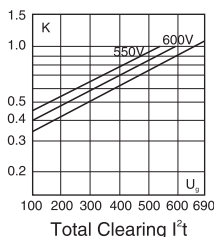
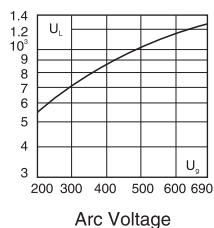

Semiconductor Protection Fuses

**Electrical Specifications:**

Catalog Numbers	Current Rating(A)	Pre-arc I <sup>2</sup> t(A <sup>2</sup> S)	Clearing I <sup>2</sup> t(A <sup>2</sup> S,660V)	Power Loss (W)	Voltage Rating	Interrupt Rating	Remark
VSP-A	40	39	260	9	690V	200kA	aR
	50	74	490	11			
	63	110	735	14			
	80	176	1200	18			
	100	344	2350	20			
	125	524	3550	25			
	160	1050	7150	29			
	200	2010	14500	34			
	250	4000	27500	38			
	315	6660	44800	48			
	350	9500	65100	53			
	400	14300	99750	58			
	450	20000	133000	62			
	500	25800	171000	67			
	550	33800	228000	74			
630	48100	324000	79				
VSP-B	200	1580	10925	43	550V	200kA	aR
	250	3000	19950	53			
	315	5900	39900	56			
	350	8100	56100	57			
	400	12900	87000	66			
	450	16200	114000	67			
	500	24000	162000	69			
	550	32500	219000	72			
	630	50000	332500	76			
	700	66100	441900	81			
VSP-C	400	10500	70800	62	690V	200kA	aR
	450	14800	99750	67			
	500	20500	138000	72			
	550	26800	181000	77			
	630	39000	262000	86			
	700	58000	385000	91			
	800	82500	548000	100			
	900	120000	799000	105			
	1000	175000	1190000	110			
	1100	243000	1595000	119			
	1250	361000	2385000	129			
	VSP-E	500	13500	90500			
550		19000	129000	96			
630		30000	199800	101			
700		42500	289000	106			
800		66500	443000	112			
900		96000	638000	117			
1000		135000	898000	120			
1100		182000	1236000	126			
1250		280000	1856000	133			
1400		355000	2328000	148			
1500		440000	2980000	153			
1600		570000	3850000	159			
1800		870000	5240000	163			
2000		1140000	6340000	172			

● **Electrical Characteristics:**

Catalog Numbers	Current Rating(A)	Pre-arc I <sup>2</sup> t(A <sup>2</sup> S)	Clearing I <sup>2</sup> t(A <sup>2</sup> S,660V)	Power Loss(W)	Voltage Rating	Interrupt Rating	Note
VSP-000	10	3.8	25.5	3.0	690V AC	200kA	aR
	16	7.2	47	5.5			
	20	11.5	77	7			
	25	19	129	9			
	32	39	265	10			
	40	68	450	12			
	50	114	760	15			
	63	214	1440	16			
	80	378	2510	19			
	100	690	4610	24			
	125	1192	8400	28			
	160	2289	15800	32			
	200	4150	27800	37			
	250	7700	51200	42			
315	11890	80100	51				
VSP-00	25	19	126	6	690V AC	200kA	aR
	32	28	191	7			
	40	49	355	9			
	50	94	631	10			
	60	168	1150	12			
	80	307	2070	15			
	100	617	4100	19			
	125	990	6900	24			
	160	1890	12800	29			
	200	3350	22400	34			
	250	6200	41600	44			
	315	9990	68100	54			
	350	13400	91200	59			
	400	17850	123000	67			

RoHS



**Ratings:**

Voltage Rating: 690V (IEC) AC

700V (UL) AC

Current Rating: 40A-1500A

Interrupt Rating:200kA

● **Mechanical Dimensions:**

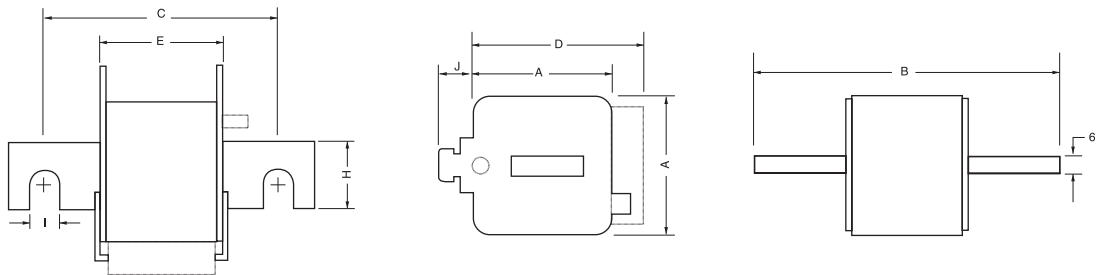
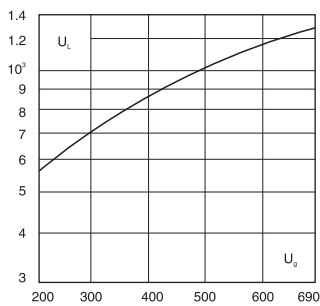

Fig.1

Size	Mechanical Dimensions(mm)							
	A	B	C	D	E	H	I	J
A	45	102	76	59	50	18	9	13
B	53	111	86	69	50	25	11	11
C	61	126	91	77	50	30	13	12
E	76	126	91	92	51	36	13	13

● **Electrical Characteristics:**



Arc Voltage

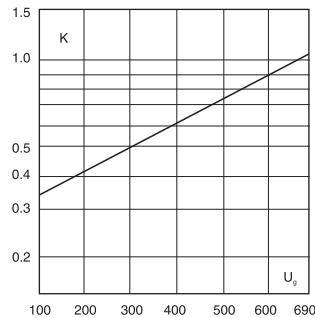

Total Clearing I<sup>2</sup>t

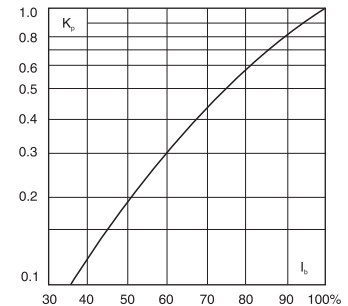

Power Losses

**● Electrical Specifications:**

Catalog Numbers	Current Rating(A)	Pre-arc $I^2t(A^2S)$	Clearing $I^2t(A^2S,660V)$	Power Loss (W)	Voltage Rating	Interrupt Rating	Note
VSP-A	40	39	260	9	690V	200kA	aR
	50	74	490	11			
	63	110	735	14			
	80	176	1200	18			
	100	344	2350	20			
	125	524	3550	25			
	160	1050	7150	29			
	200	2010	14500	34			
	250	4000	27500	38			
	315	6660	44800	48			
	350	9500	65100	53			
	400	14300	99750	58			
	450	20000	133000	62			
500	25800	171000	67				
VSP-B	200	1580	10925	43			
	250	3000	19950	53			
	315	5900	39900	56			
	350	8100	56100	57			
	400	12900	87000	66			
	450	16200	114000	67			
	500	24000	162000	69			
	550	32500	219000	72			
	630	50000	332500	76			
VSP-C	700	66100	441900	81			
	800	100000	689000	91			
	400	10500	70800	62			
	450	14800	99750	67			
	500	20500	138000	72			
	550	26800	181000	77			
	630	39000	262000	86			
	700	58000	385000	91			
	800	82500	548000	100			
VSP-E	900	120000	799000	105			
	1000	175000	1190000	110			
	500	13500	90500	91			
	550	19000	129000	96			
	630	30000	199800	101			
	700	42500	289000	106			
	800	66500	443000	112			
	900	96000	638000	117			
	1000	135000	898000	120			
	1100	182000	1236000	126			
	1250	280000	1856000	133			
1400	355000	2328000	148				
1500	440000	2980000	153				

RoHS



**Ratings:**  
Voltage Rating: 690V (IEC) AC  
700V (UL) AC  
Current Rating: 40A-2000A  
Interrupt Rating: 200kA

**Mechanical Dimensions:**

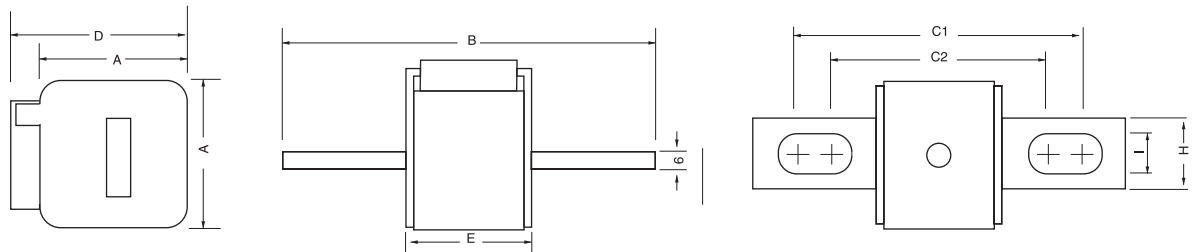
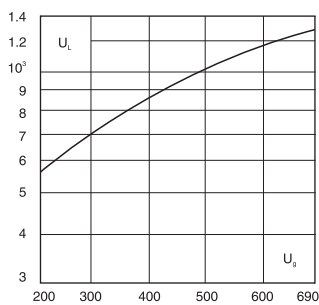

Fig.1

Size	Mechanical Dimensions(mm)										
	A	B(L)	B(LL)	C1(L)	C1(LL)	C2(L)	C2(LL)	D	E	H	I
A	45	110	148	85	126	72	110	59	50	20	10
B	53	136	157	104	126	78	100	69	50	25	14
C	61	135	159	105	125	78	99	77	50	25	14
E	76	135	155	106	125	77	97	92	51	36	16

**Electrical Characteristics:**



Arc Voltage

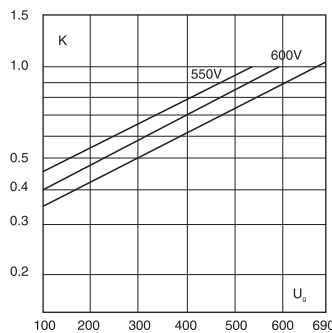

Total Clearing I<sup>2</sup>t

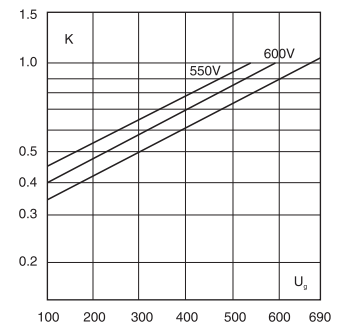

Power Losses

● **Electrical Specifications:**

Catalog Numbers	Current Rating(A)	Pre-arc I <sup>2</sup> t(A <sup>2</sup> S)	Clearing I <sup>2</sup> t (A <sup>2</sup> S,660V)	Power Loss (W)	Voltage Rating	Interrupt Rating	Remark
VSP-A	40	39	260	9	690V	200kA	aR
	50	74	490	11			
	63	110	735	14			
	80	176	1200	18			
	100	344	2350	20			
	125	524	3550	25			
	160	1050	7150	29			
	200	2010	14500	34			
	250	4000	27500	38			
	315	6660	44800	48			
	350	9500	65100	53			
	400	14300	99750	58			
	450	20000	133000	62			
	500	25800	171000	67			
VSP-B	550	32500	219000	72	690V	200kA	aR
	630	46100	309000	76			
	200	1580	10925	43			
	250	3000	19950	53			
	315	5900	39900	56			
	350	8100	56100	57			
	400	12900	87000	66			
	450	16200	114000	67			
	500	24000	162000	69			
	550	32500	219000	72			
VSP-C	630	50000	332500	76	690V	200kA	aR
	700	66100	441900	81			
	800	100000	689000	91			
	900	148000	809000	96			
	400	10500	70800	62			
	450	14800	99750	67			
	500	20500	138000	72			
	550	26800	181000	77			
	630	39000	262000	86			
	700	58000	385000	91			
VSP-E	800	82500	548000	100	690V	200kA	aR
	900	120000	799000	105			
	1000	175000	1190000	110			
	1100	235000	1560000	116			
	1250	349000	2300000	125			
	500	13500	90500	91			
	550	19000	129000	96			
	630	30000	199800	101			
	700	42500	289000	106			
	800	66500	443000	112			
	900	96000	638000	117			
	1000	135000	898000	120			
	1100	182000	1236000	126			
	1250	280000	1856000	133			
1400	355000	2338000	148				
1500	440000	2980000	153				
1600	555000	3720000	154				
1800	838000	4990000	161				
2000	1095000	6035000	170				
					600V		
					500V		



● **Size VSP-A (40A-630A: 690V)**

● **Size VSP-B (200A-900A:690V)**

Time-Current Curve

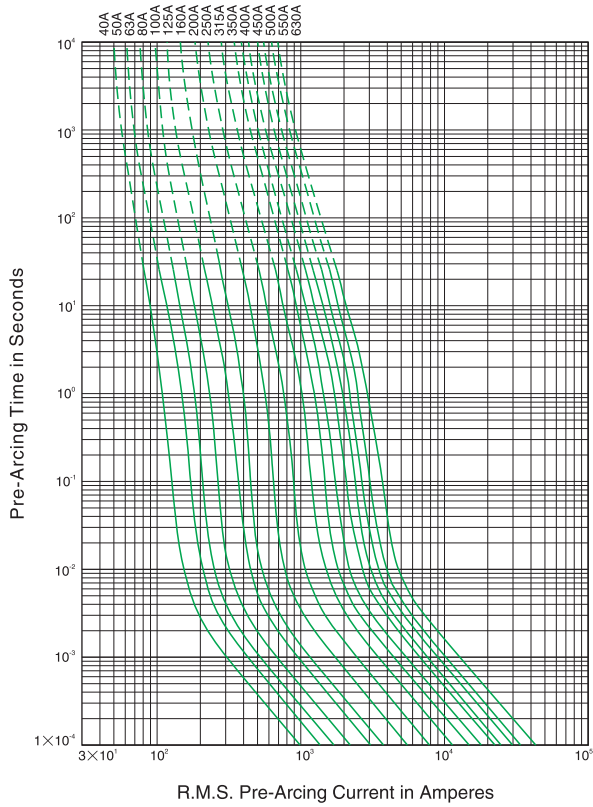

Time-Current Curve

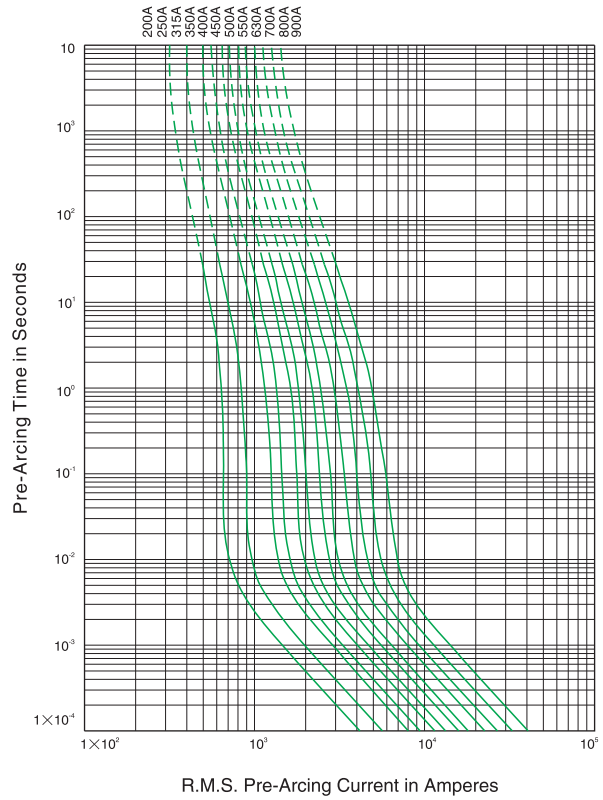

Peak Let-Through Curve

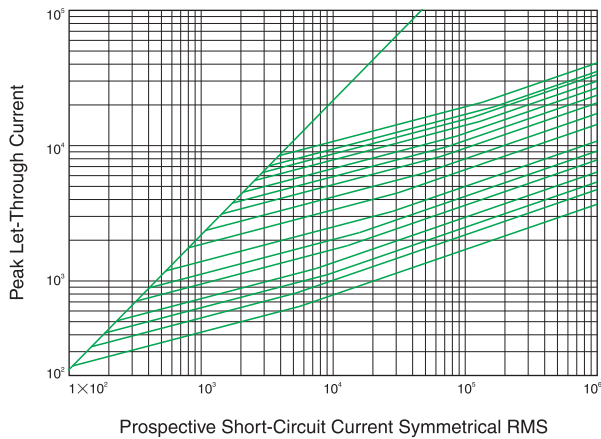

Peak Let-Through Curve

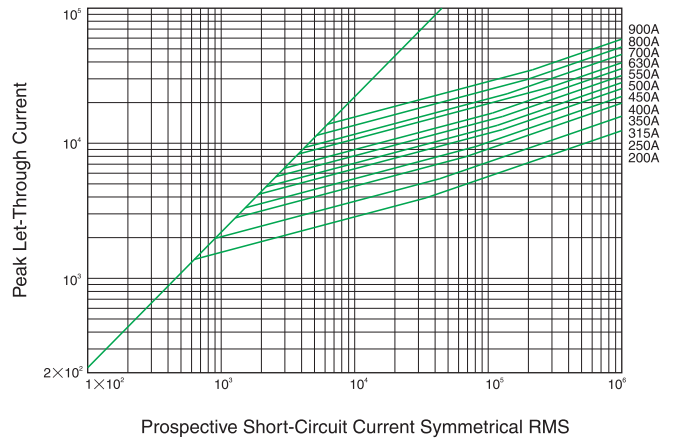

Semiconductor Protection Fuses

● **Size VSP-C (400A-1250A: 690V)**

● **Size VSP-E (500A-2000A: 690V)**

Time-Current Curve

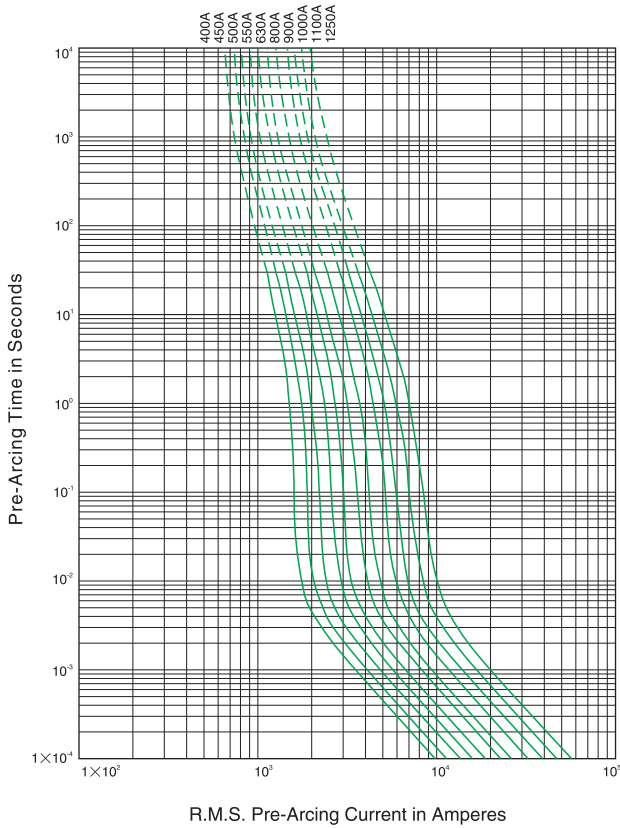

Time-Current Curve

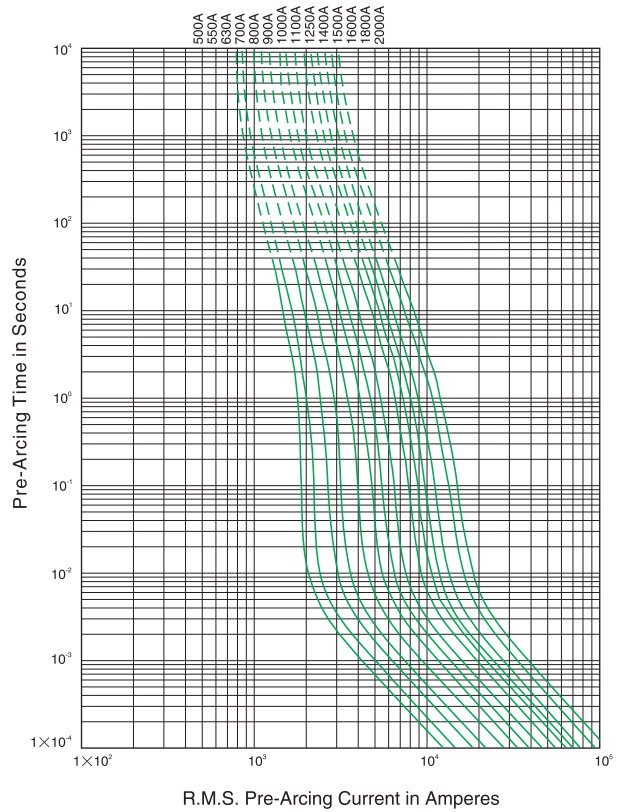

Peak Let-Through Curve

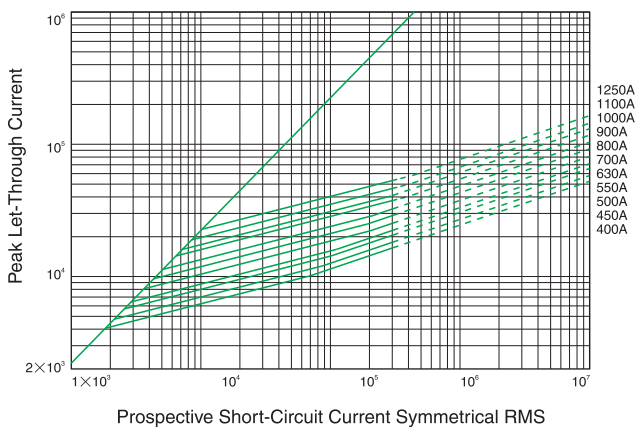

Peak Let-Through Curve

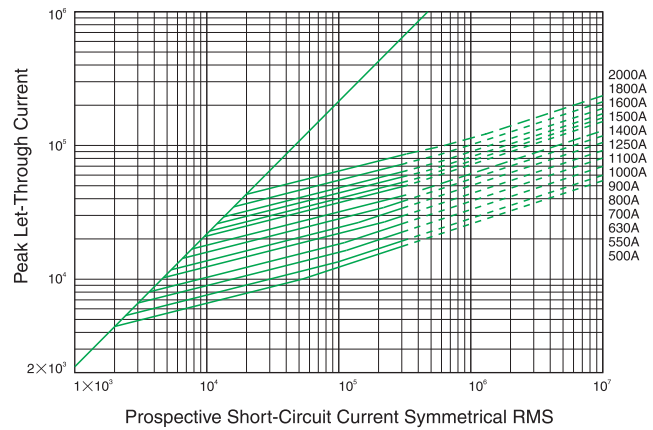

Semiconductor Protection Fuses

● Size 2×VSP-E (1000A-4000A: 690V)

● Size 2×VSP-H (2000A-7500A: 690V)

Time-Current Curve

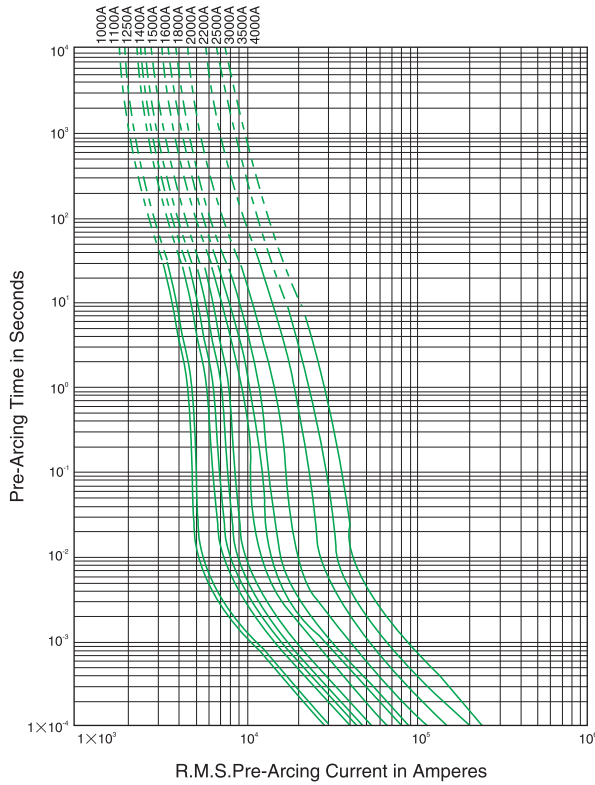

Time-Current Curve

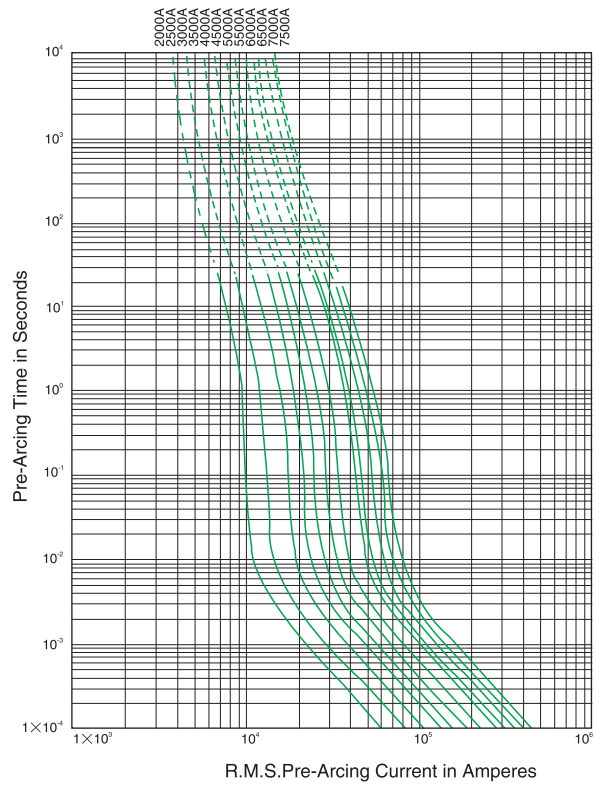

Peak Let-Through Curve

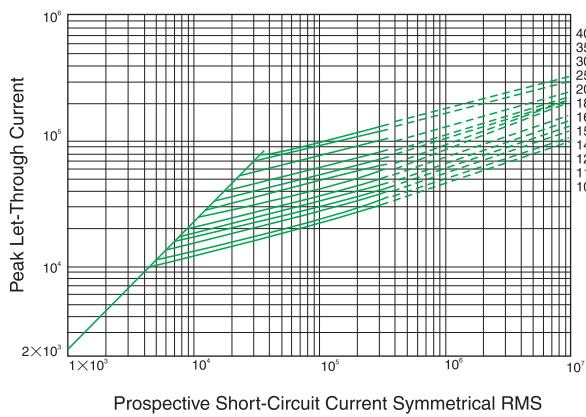

Peak Let-Through Curve

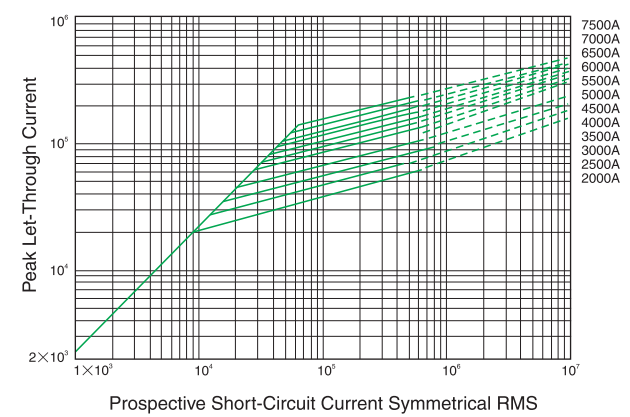

● **Size VSP-000 D11 (10A-315A: 690V)**

● **Size VSP-00 D11 (25A-400A: 690V)**

Time-Current Curve

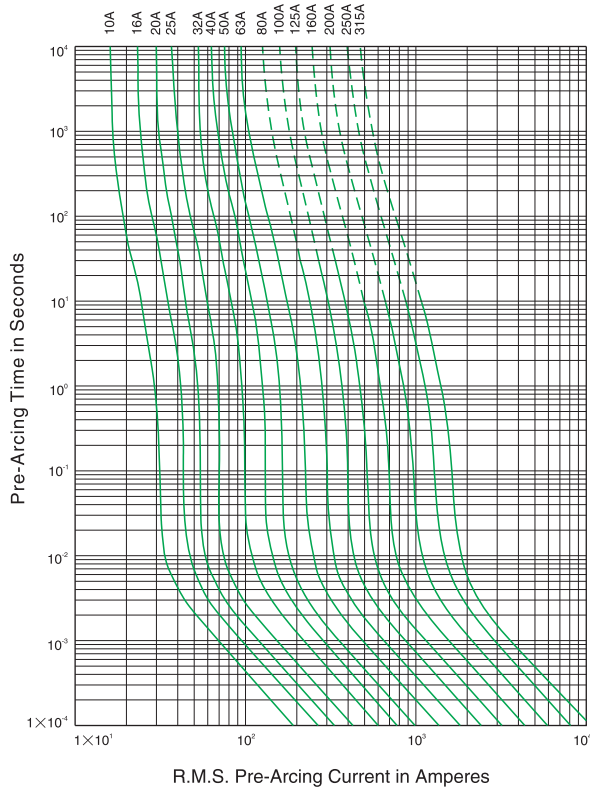

Time-Current Curve

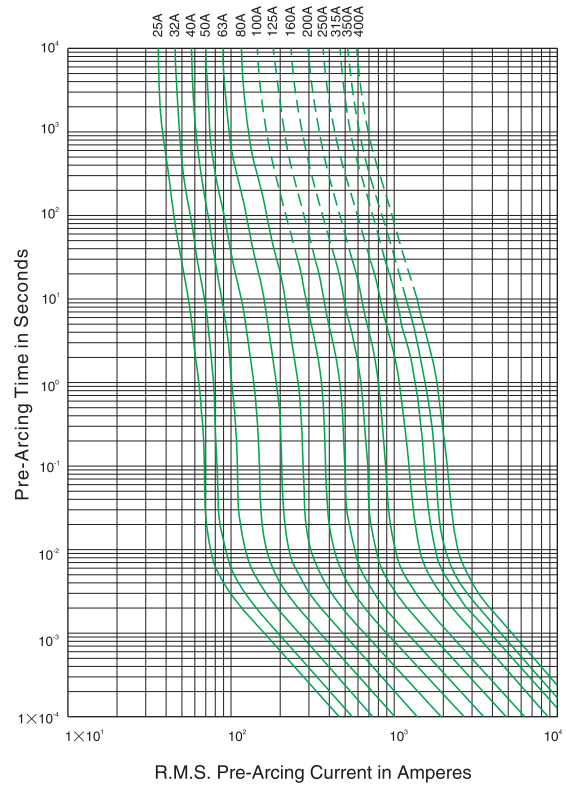

Peak Let-Through Curve

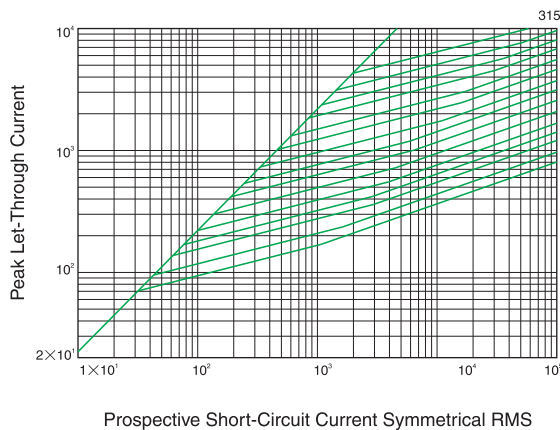

Peak Let-Through Curve

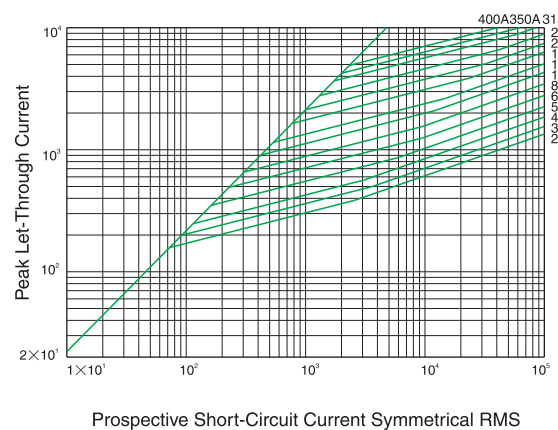

RoHS



**Ratings:**  
 Voltage Rating: 690V (IEC) AC  
 700V (UL) AC  
 Current Rating: 50A-500A  
 Interrupt Rating: 100kA-200kA

● Mechanical Dimensions:

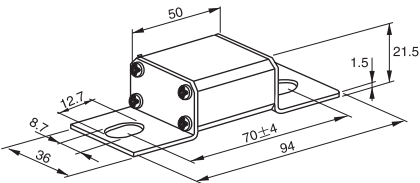

Fig.1

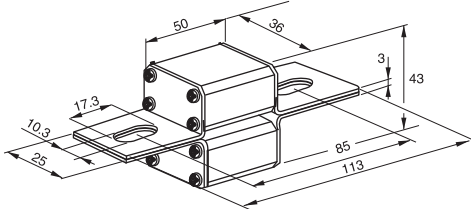

Fig.2

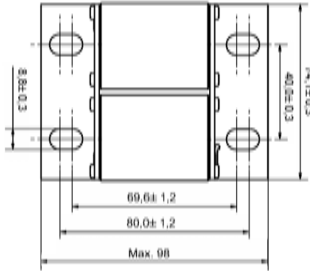
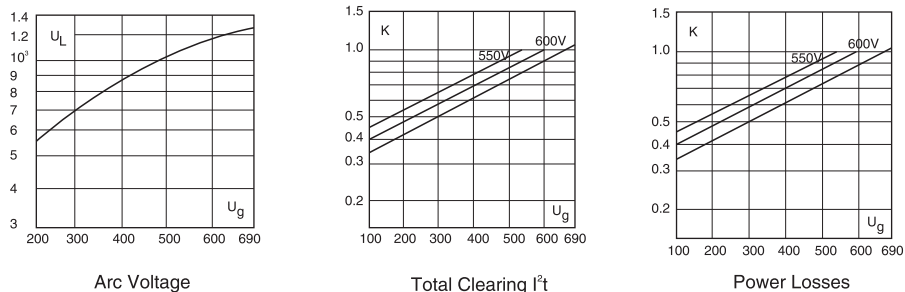

Fig.3

**● Electrical Characteristics:**



**● Electrical Specifications:**

Catalog Numbers	Ref.Fig.	Current Rating(A)	Pre-arc I <sup>2</sup> t(A <sup>2</sup> S)	Clearing I <sup>2</sup> t (A <sup>2</sup> S,660V)	Power Loss (W)	Voltage Rating	Interrupt Rating	Note
VSP-000	1	50	628	730	14	690V AC	200kA	gR
		65	1290	1500	16			
		75	2110	2500	17			
		85	2760	3300	19			
		90	3510	4200	24			
		110	7600	8900	25			
		150	13300	16000	26			
		180	26250	31500	27			
		200	42100	52000	28			
		250	66500	82000	32			
2×VSP-000	2	280	66500	82000	43	690V AC	200kA	gR
		350	9300	65000	51			
		175	14040	16800	33			
		200	21200	25000	37			
		235	30400	35600	44			
		300	53200	64000	52			
		325	77000	92400	53			
		355	105000	126000	54			
VSP-000 IGBT type	3	400	168400	208000	56	690V AC	200kA	aR
		450	170000	210000	60			
		500	266000	328000	64			
		100	365	1800	32			
		125	650	3500	44			
		160	1330	7800	49			
		200	2520	12700	51			
		250	5020	26700	59			
		315	9240	45900	68			
		350	11800	62300	79			
400	18100	93100	82					
450	27900	148000	88					
500	37000	181000	92					
550	47800	243000	98					
630	68000	349000	110					

● **Size VSP-000 BB (50A-280A: 690V)**

● **Size 2×VSP-000 BB (175A-500A: 690V)**

Time-Current Curve

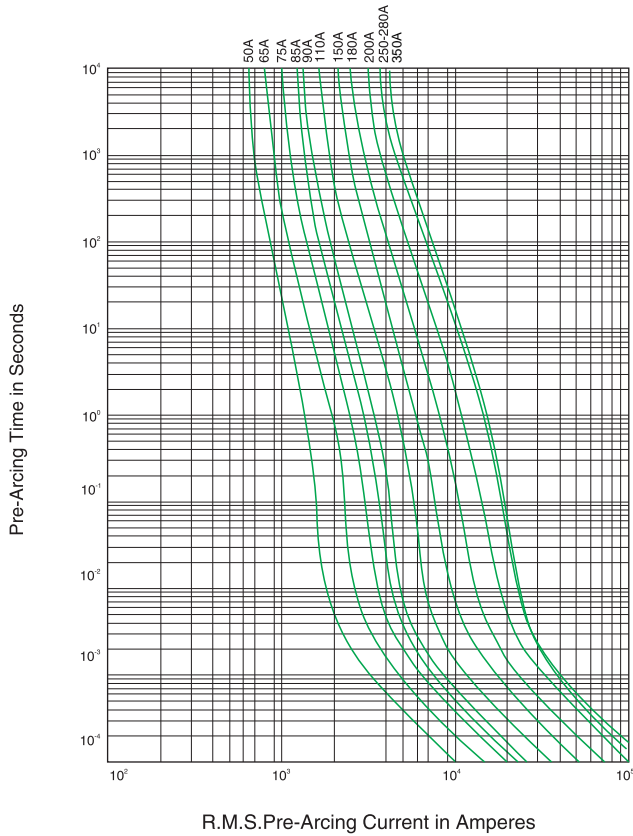

Time-Current Curve

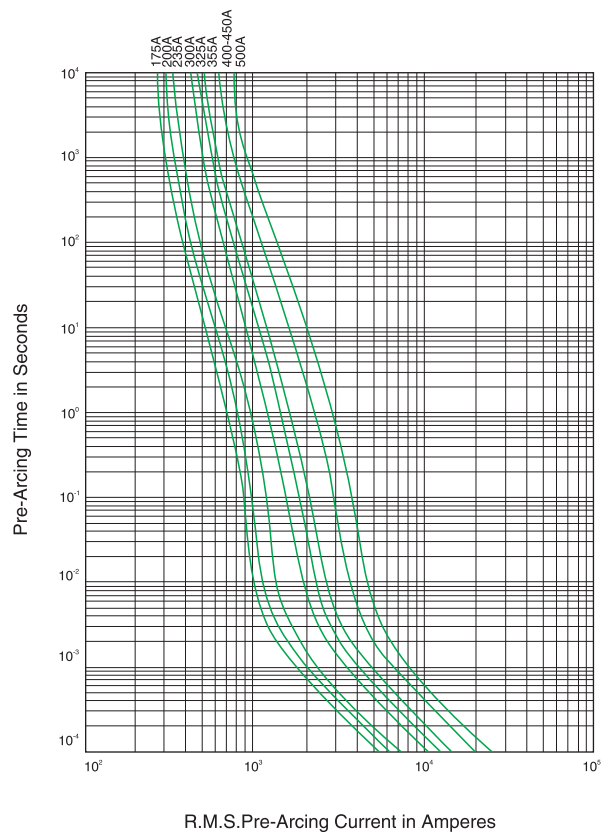

Peak Let-Through Curve

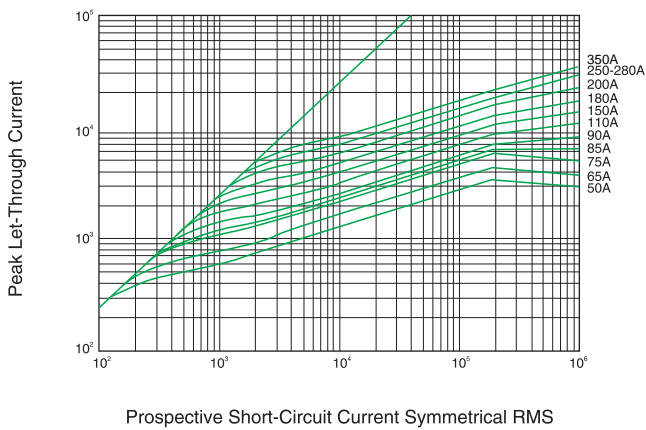

Peak Let-Through Curve

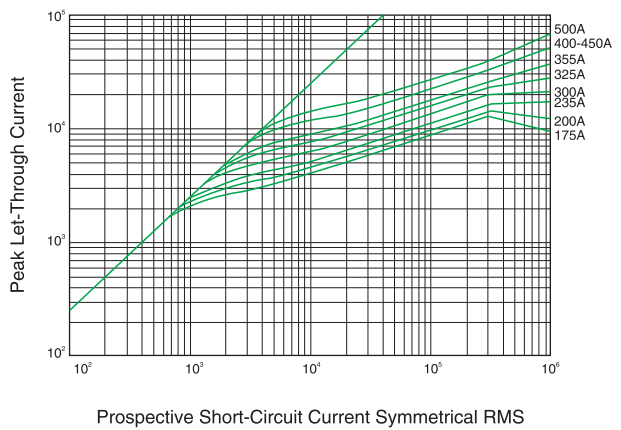

RoHS



**Ratings:**

Voltage Rating: 690V (IEC) AC  
700V (UL) AC

Current Rating: 10A-1600A

Interrupt Rating: 200kA

**Mechanical Dimensions:**

(Size 000 aR)

(Type T Indicator)

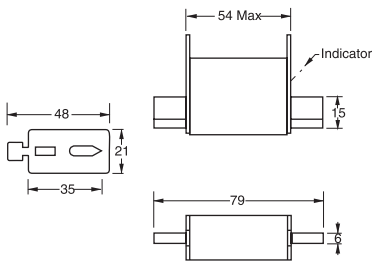

Fig.1

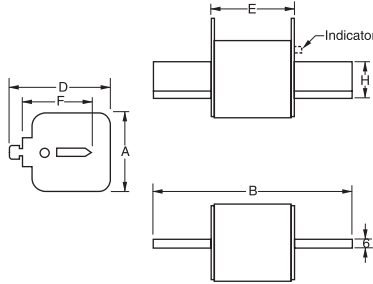

Fig.2

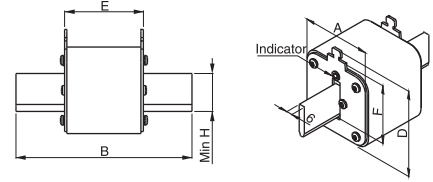

Fig.3

Size	Ref. Fig.	Mechanical Dimensions(mm)					
		A	B	D	E	F	H
A(aR)	2	45	135	58	69	40	20
C(aR)	2	55	150	71	69	48	26
E(aR)	2	76	150	88	68	60	33

Size	Ref. Fig.	Mechanical Dimensions(mm)					
		A	MAX B	MAX D	E	Min F	H
00(gR)	3	30	78.5	60	49	35	15
B(gR)	3	52	135	66	68	40	20
C(gR)	3	60	150	74	68	48	25
E(gR)	3	75	150	89	68	60	32

**Electrical Characteristics:**

(aR)

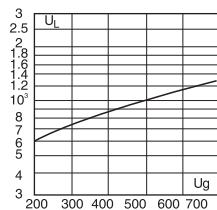

Arc Voltage

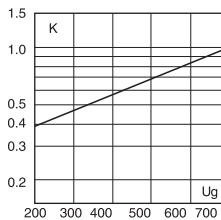

Total Clearing I<sup>2</sup>t

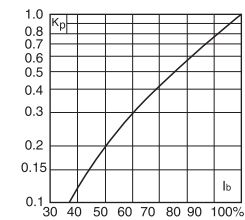

Power Losses

(gR)

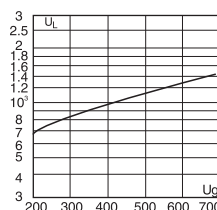

Arc Voltage

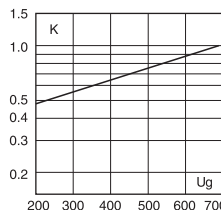

Total Clearing I<sup>2</sup>t

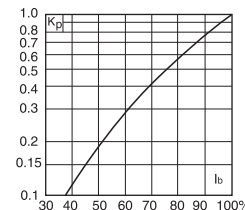

Power Losses



● Electrical Specifications:

Catalog Numbers	Current Rating(A)	Pre-arc I <sup>2</sup> t(A <sup>2</sup> S)	Clearing I <sup>2</sup> t(A <sup>2</sup> S,690V)	Power Loss (W)	Voltage Rating	Interrupt Rating	Note
VSP-A	40	39	273	4	690V	200kA	aR
	50	75	525	4.5			
	63	115	812	6.5			
	80	176	1300	8.5			
	100	344	2500	10			
	125	524	3750	10.5			
	160	1100	7900	11.5			
	200	2200	15800	12			
	250	4150	30000	15.5			
	315	7000	49600	19.5			
	350	9500	70000	21			
	400	15600	110000	58			
	450	21000	153000	26			
	500	26000	185000	28			
	550	30500	230000	32			
VSP-C	630	46500	330000	37			
	700	66200	481000	38			
	400	10500	76000	28			
	450	15500	110000	31			
	500	20500	150000	33			
	550	27800	210000	35			
	630	39000	262000	41			
	700	58000	410000	42			
VSP-E	800	82500	588000	46			
	900	120000	862000	50			
	1000	175000	1238000	51			
	1100	235000	1680000	55			
	500	13500	90500	42			
	550	19000	131000	43			
	630	30000	210800	44			
	700	42500	309000	45			
	800	66500	473000	47			
	900	96000	688000	49			
	1000	135000	968000	55			
	1100	182000	1376000	56			
VSP-000	1250	280000	2056000	60			
	1400	355000	2628000	78			
	1500	440000	3200000	71			
	1600	560000	4000000	73			
	10	4	26	2.5			
	16	7	50	4			
	20	11	81	5			
	25	18.5	137	6			
	32	39	280	7			
	40	63	481	8.5			
	50	112	811	9.5			
	63	213	1521	11			
	80	374	2640	14			
	100	678	4800	16			
125	1150	8100	21				
160	2180	16000	24				
200	4200	30000	28				
250	7620	54100	35				
315	11500	81000	44				

● **Electrical Specifications:**

Catalog Numbers	Current Rating(A)	Pre-arc I <sup>2</sup> t(A <sup>2</sup> S)	Clearing I <sup>2</sup> t(A <sup>2</sup> S,660V)	Power Loss (W)	Voltage Rating	Interrupt Rating	Note
VSP-00	10	3.8	20	3.5	690V	300kA	gR
	16	7.2	37	5.5			
	20	13	69	6			
	25	24	123	8			
	32	52	271	9			
	40	93	488	10			
	50	182	997	11			
	63	341	1788	14			
	80	690	3580	16			
	100	1234	6600	19			
	125	2289	11940	23			
160	4290	22450	29				
VSP-B	50	134	700	12			
	63	243	1250	15			
	80	497	2500	17			
	100	942	4800	20			
	125	1841	9450	23			
	160	3426	17550	28			
	200	6710	34400	31			
	250	12450	70200	35			
	315	25900	13400	41			
	350	33900	174000	45			
VSP-C	400	48400	245000	48			
	200	5610	28500	33			
	250	9990	52400	39			
	315	19100	101000	45			
	350	25400	134500	49			
	400	39100	201000	52			
	450	55400	286000	58			
	500	72500	372000	65			
	550	99990	512000	69			
VSP-E	630	148000	765000	78			
	350	22700	119000	54			
	400	33500	171000	58			
	450	48200	246000	61			
	500	63520	329000	66			
	550	84400	433000	69			
	630	123000	641000	84			
	700	158900	835000	92			
800	244000	1298000	98				

● Size VSP-000 D08 (10A-315A: 690V)

● Size VSP-A D08 (40A-700A: 690V)

Time-Current Curve

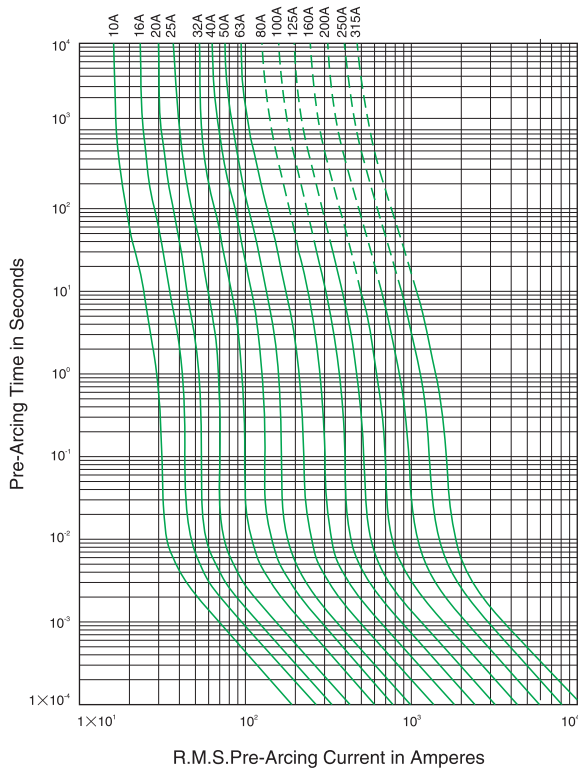

Time-Current Curve

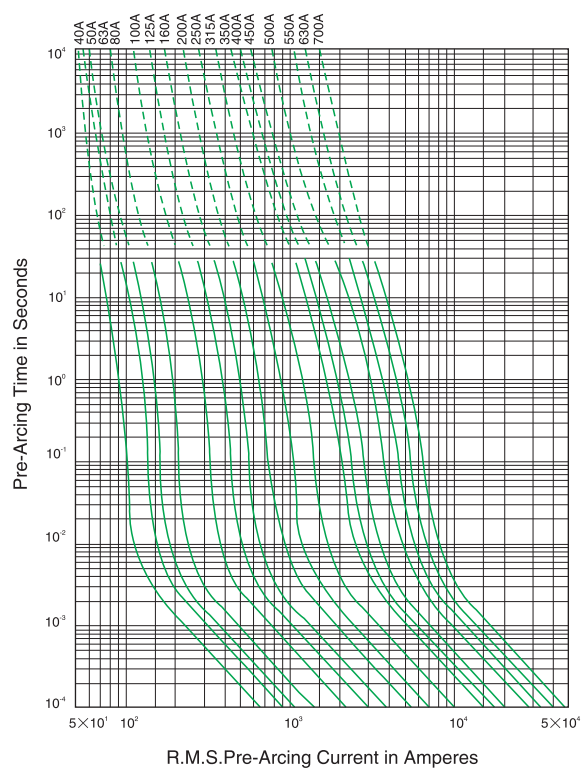

Peak Let-Through Curve

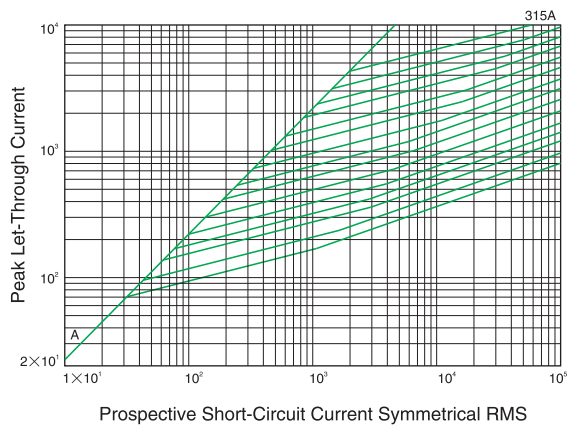

Peak Let-Through Curve

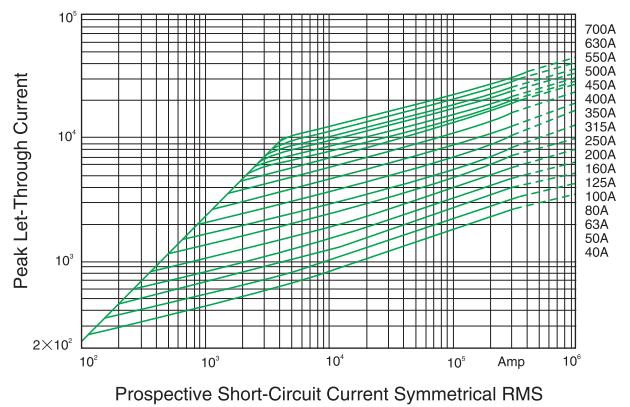

● Size VSP-C D08 (400A-1100A: 690V)

● Size VSP-E D08 (500A-1600A: 690V)

Time-Current Curve

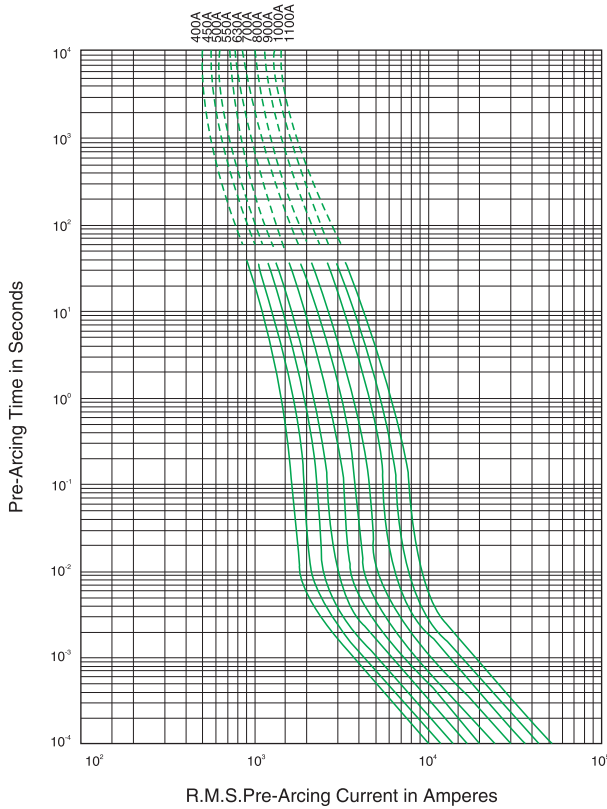

Time-Current Curve

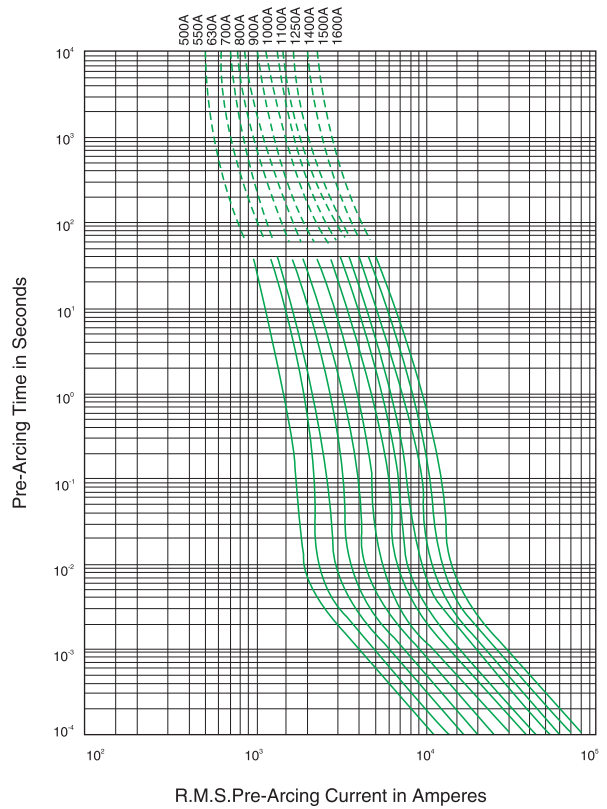

Peak Let-Through Curve

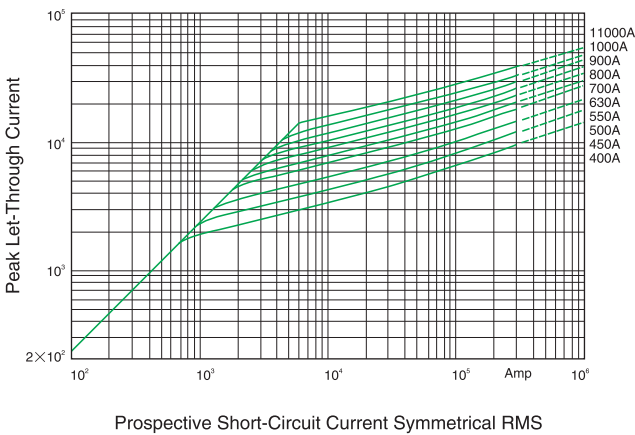

Peak Let-Through Curve

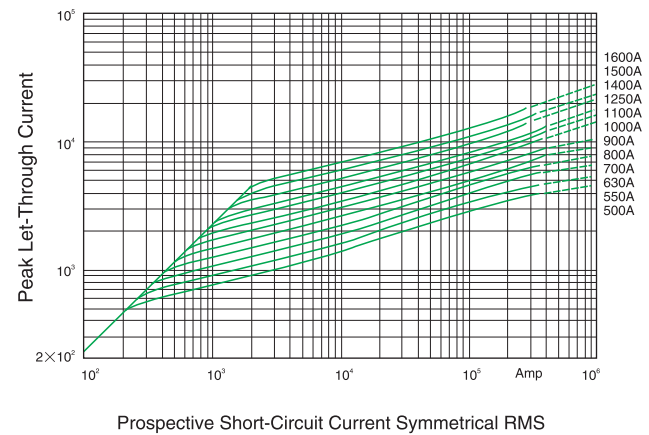

● **Size VSP-00 D08 (10A-160A: 690V gR)**

● **Size VSP-B D08 (50A-400A: 690V gR)**

Time-Current Curve

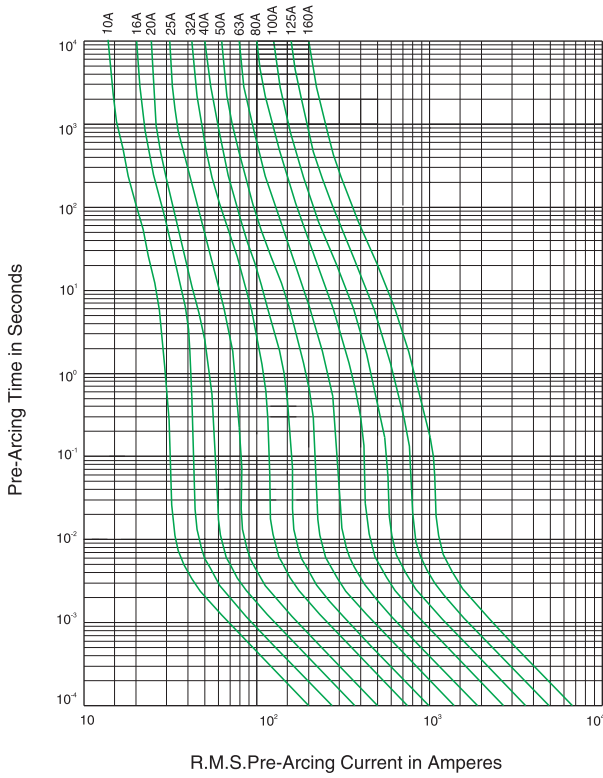

Time-Current Curve

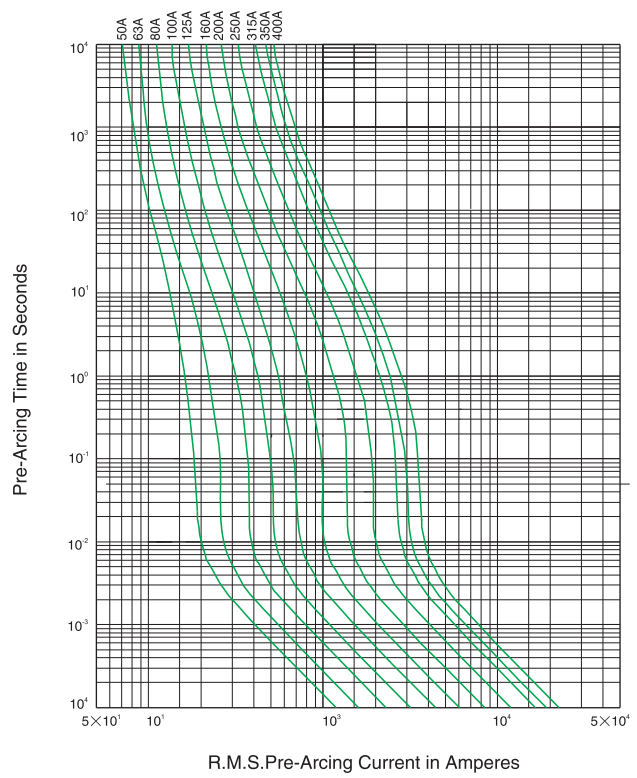

Peak Let-Through Curve

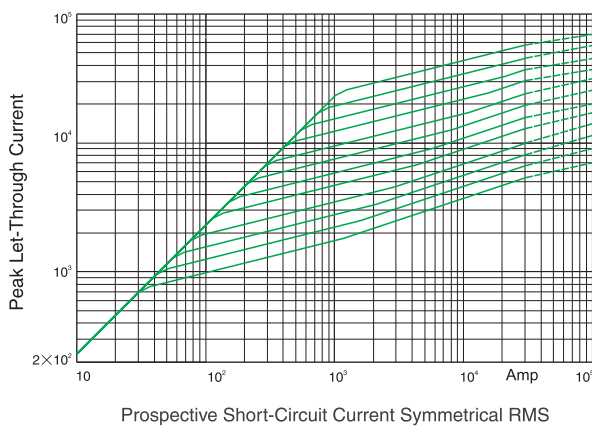

Peak Let-Through Curve

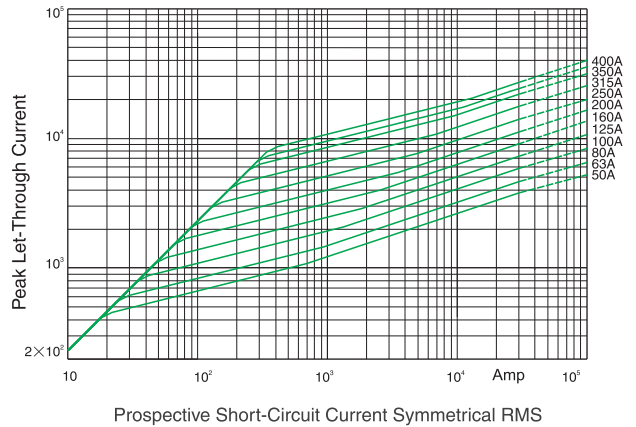

● Size VSP-C D08 (200A-630A: 690V gR)

● Size VSP-E D08 (350A-800A: 690V gR)

Time-Current Curve

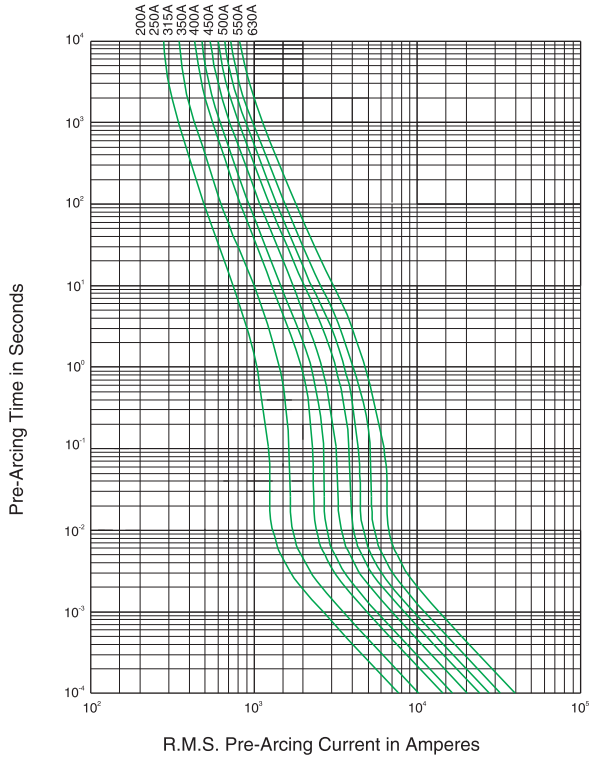

Time-Current Curve

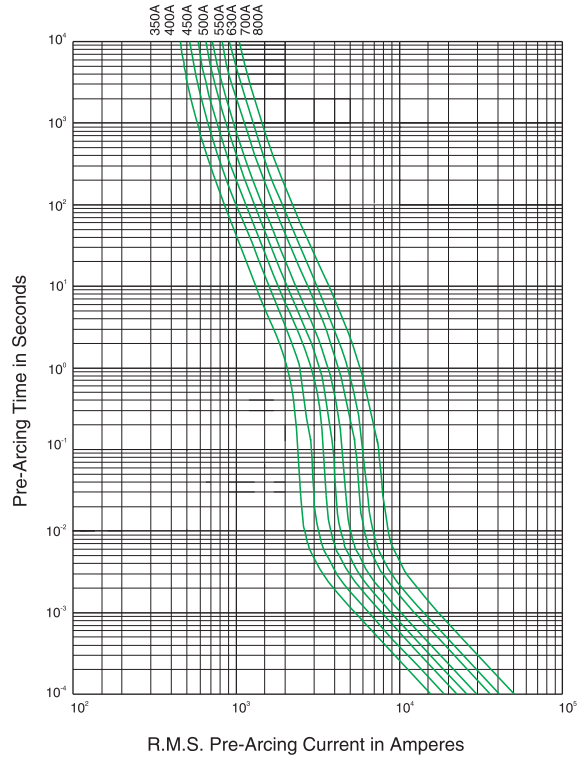

Peak Let-Through Curve

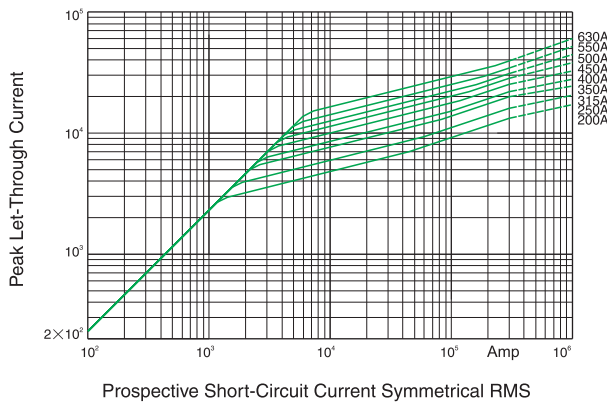

Peak Let-Through Curve

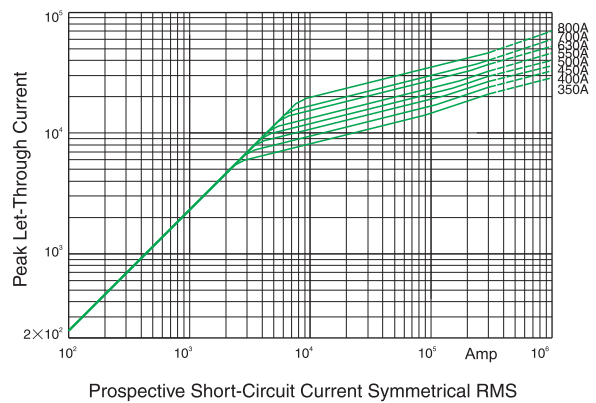

RoHS



**Ratings:**

Voltage Rating: 1000 AC  
1000V DC  
Current Rating: 25A-500A  
Interrupt Rating: 100kA

**Mechanical Dimensions:**

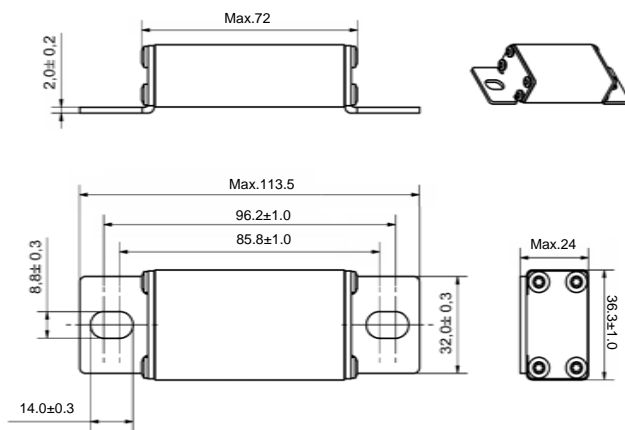

Fig.1

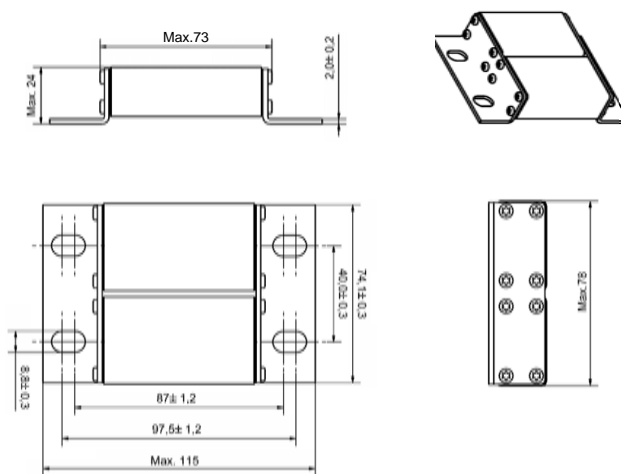

Fig.2

● **Electrical Specification:**

Catalog Numbers	Ref.Fig.	Current Rating(A)	Pre-arc $I^2t(A^2S)$	Clearing $I^2t(A^2S)$	Power Loss (W)	Voltage Rating	Interrupt Rating	Remark
VSP-000	1	25	20	85	13	1000V AC 1000V DC	100kA	aR
		32	32	160	18			
		40	58	310	22			
		50	137	650	20			
		63	240	1240	23			
		80	498	2550	26			
		100	1020	5050	31			
		125	1930	9460	33			
		160	4100	19800	38			
		200	8450	41000	44			
		225	12300	58700	46			
		250	15800	78600	49			
VSP-000 IGBT type	2	100	640	3130	36	1000V AC 1000V DC	100kA	aR
		125	1170	6120	41			
		160	2500	12900	48			
		200	4580	23500	53			
		250	9500	46400	61			
		315	17900	90400	69			
		350	24900	130000	74			
		400	38000	189000	79			
		450	53000	267000	85			
		500	70000	351000	94			



RoHS



**Ratings:**

Voltage Rating: 1000V (IEC) AC  
1100V (UL) AC

Current Rating: 50A-2700A

Interrupt Rating: 100kA

**Mechanical Dimensions:**

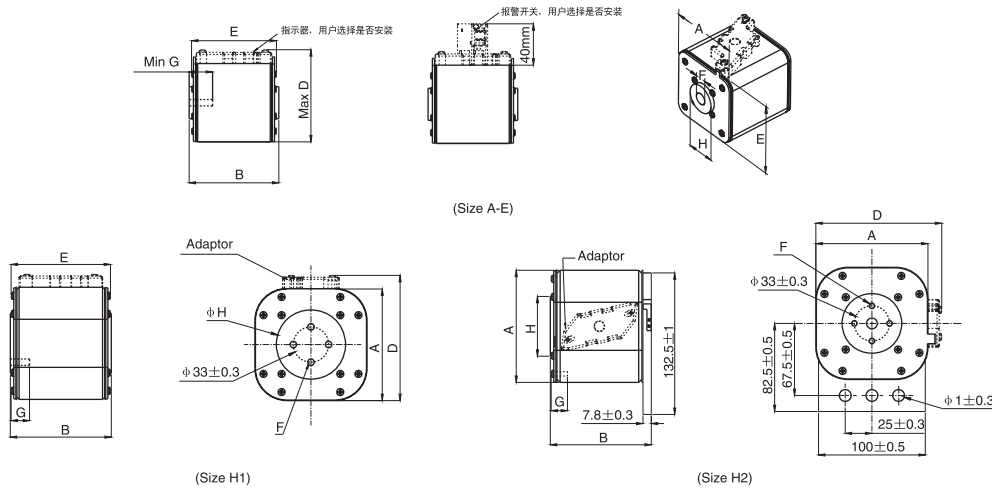

Size	Mechanical Dimensions(mm)						
	A	B	MAX D	E	F	MinG	H
A	43	74	61	72.5	M8	5	F17.5
B	52	74	69	73.2	M8	8	F20.0
C	60	74.5	77	73.2	M10	10	F24.0
E	74	75.5	92	73.3	M12	10	F30.0
E(1250/1400A)	74	91.5	92	80.3	M12	10	F30.0
H	105	94.6	120	93.2	M10	12	F56.0
H2	105	94.6	120	105(Max)	M10	12	F56.0

**Electrical Characteristics:**

(Size A-E)

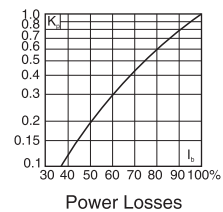
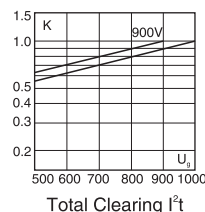
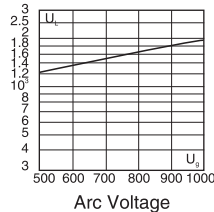

(Size H/H2)

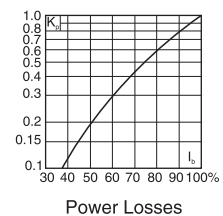
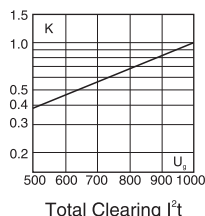
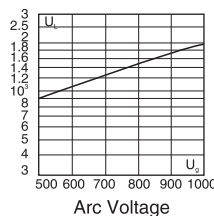

● **Electrical Specifications:**

Catalog Numbers	Current Rating(A)	Pre-arc I <sup>2</sup> t(A <sup>2</sup> S)	Clearing I <sup>2</sup> t(A <sup>2</sup> S,1000V)	Power Loss (W)	Voltage Rating	Interrupt Rating	Note
VSP-A	50	132	811	20	1000V	200kA	
	63	210	1250	24			
	80	455	2710	28			
	100	850	5050	34			
	125	1441	8460	39			
	160	2831	17150	43			
	200	4836	27500	46			
	250	9314	55800	48			
	315	21200	128000	58			
	350	27800	165100	63			
VSP-B	400	41000	245000	68	900V 800V 750V	100kA	
	160	2150	13200	39			
	200	4110	24100	42			
	250	7712	45100	51			
	315	16200	98000	56			
	350	21100	127000	63			
	400	30200	182000	69			
	450	44100	258000	77			
	500	61900	362000	82			
	550	94000	492000	88			
VSP-C	630	122000	732500	96	1000V	200kA	aR
	700	175000	990000	102			
	800	280000	1460000	109			
	900	435000	1999000	110			
	1000	520000	2250000	120			
	250	6630	39600	64			
	315	13400	81100	73			
	350	16100	98100	78			
VSP-E	400	25100	150000	81	900V	200kA	
	450	35200	210000	88			
	500	28500	284000	92			
	550	63300	381000	97			
	630	921000	542000	105			
	700	127000	755000	112			
	800	182500	1154800	123			
	315	9100	54400	89			
	350	12500	74800	91			
	400	18400	111000	103			
VSP-H	450	26300	145000	106	1000V		
	500	36100	200000	109			
	550	51200	301200	113			
	630	81300	481900	117			
	700	102500	689000	122			
	800	166500	1014000	132			
	900	243000	1456000	144			
	1000	312000	2008000	149			
	1100	450000	2636000	154			
	1250	563000	3316000	171			
VSP-H	1400	785000	4128000	182	1000V		
	1000	173000	1050000	187			
	1100	240000	1450000	193			
	1500	580000	3450000	241			
	1700	810000	4800000	252			
	2000	1380000	8210000	264			
	2200	1960000	11600000	271			
	2500	2900000	17500000	290			
2700	3550000	21000000	300				

RoHS



**Ratings:**

Voltage Rating: 1000V (IEC) AC  
 1100V (UL) AC  
 Current Rating: 2000A-5000A  
 Interrupt Rating: 200kA

**Mechanical Dimensions:**

(Size 2×H)

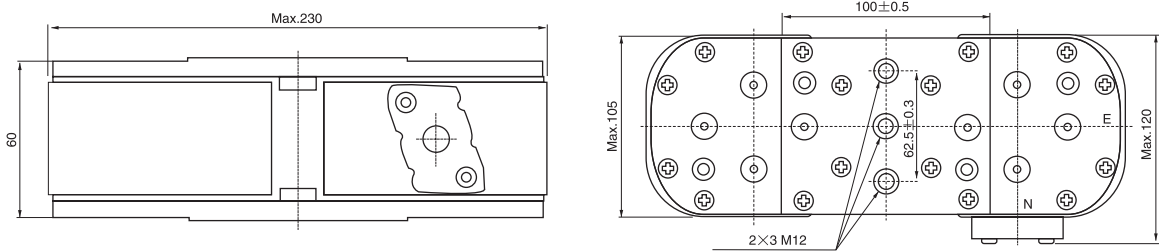

Catalog Numbers	Current Rating(A)	Pre-arc I <sup>2</sup> t(A <sup>2</sup> S)	Clearing I <sup>2</sup> t(A <sup>2</sup> S)	Power Loss (W)	Voltage Rating	Interrupt Rating	Note
2×VSP-H	2000	327000	2190000	327	1000V	300kA	aR
	3000	1070000	7000000	411			
	3200	1730000	11800000	470			
	3500	2600000	17300000	500			
	4000	3690000	24600000	517			
	4200	5190000	34800000	533			
	4500	7090000	47800000	536			
	5000	9200000	61200000	555			

**Electrical Characteristics:**

(Size 2×E)

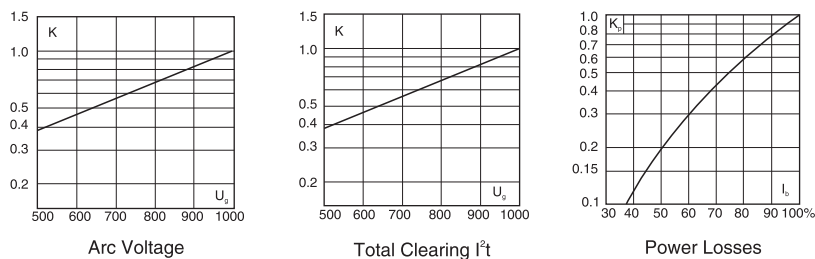

(Size 2×H)

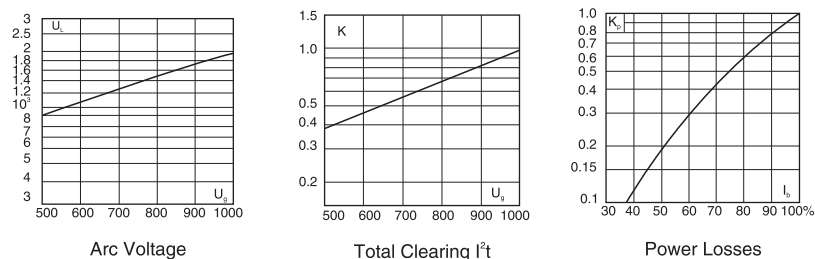

RoHS



**Ratings:**

Voltage Rating: 1000V (IEC) AC

1100V (UL) AC

Current Rating: 20A-1400A

Interrupt Rating: 150kA

● **Mechanical Dimensions:**

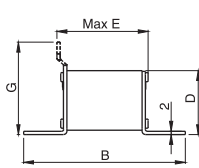

Fig.1 (Size 00)

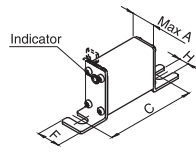

Fig.2 (Type K)

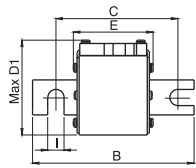
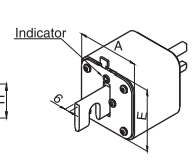
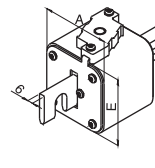

Fig.3 (Type T)



Size	Mechanical Dimensions(mm)							
	MAX A	B	C	D	MAX E	F	G	H
00	30	98	78	51	54	28	67(Optional)	10

Size	Mechanical Dimensions(mm)							
	A	B	C	MAXD1	E	G	H	I
A	45	138	108	61	80	6	22	11
B	53	138	108	69	80	6	25	11
C	61	138	108	77	80	6	25	11
E	76	139	108	92	81	6	30	11

● **Electrical Characteristics:**

Size 00

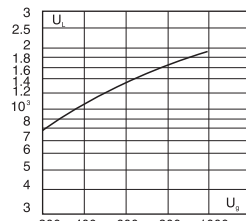

Arc Voltage

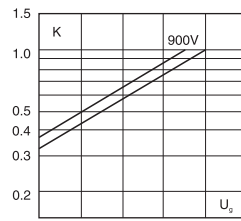

Total Clearing I<sup>2</sup>t

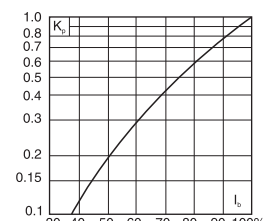

Power Losses

Size A/B/C/E

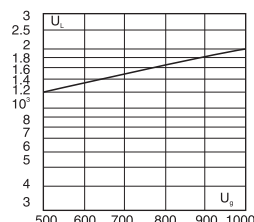

Arc Voltage

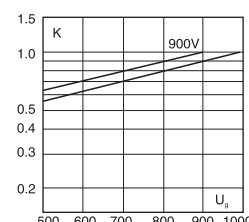

Total Clearing I<sup>2</sup>t

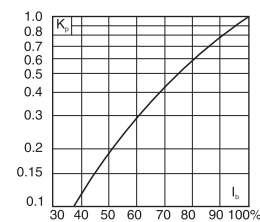

Power Losses

● Electrical Specifications:

Catalog Numbers	Current Rating(A)	Pre-arc I <sup>2</sup> t(A <sup>2</sup> S)	Clearing I <sup>2</sup> t(A <sup>2</sup> S,1000V)	Power Loss (W)	Voltage Rating	Interrupt Rating	Note
VSP-00	20	20	139	5	1000V		
	25	30	208	7			
	32	54	387	9			
	35	68	495	10			
	40	99	688	11			
	50	169	1188	13			
	63	278	1980	18			
	80	497	3490	22			
	100	940	6800	25			
	125	1490	11420	32			
	160	2950	21500	36			
	200	5560	40000	39			
	250	9990	73500	47			
	315	17900	114500	57			
VSP-A	50	132	811	20	1000V	150kA	aR
	63	210	1250	24			
	80	455	2710	28			
	100	850	5050	34			
	125	1441	8460	39			
	160	2831	17150	43			
	200	4900	29000	47			
	250	9314	55800	48			
	315	21200	128000	58			
	350	27800	165100	63			
VSP-B	160	2150	13200	39	1000V	150kA	aR
	200	4110	24100	42			
	250	7712	45100	51			
	315	16200	98000	56			
	350	21100	127000	63			
	400	30200	182000	69			
	450	44100	258000	77			
	500	61900	362000	82			
	550	84000	492000	88			
VSP-C	250	6630	39600	64	1000V	150kA	aR
	315	13400	81100	73			
	350	16100	98100	78			
	400	25100	150000	81			
	450	35200	210000	88			
	500	28500	284000	92			
	550	63300	381000	97			
	630	921000	542000	105			
	700	127000	755000	112			
VSP-E	315	9100	54400	89	1000V	150kA	aR
	350	12500	74800	91			
	400	18400	111000	103			
	450	26300	145000	106			
	500	36100	200000	109			
	550	51200	301200	113			
	630	81300	481900	117			
	700	102500	689000	122			
	800	166500	1014000	132			
	900	243000	1456000	144			
	1000	312000	2008000	149			
	1100	450000	2636000	154			
	1250	563000	3316000	171	900V		
	1400	785000	4128000	182			

RoHS



**Ratings:**

Voltage Rating: 1000V (IEC) AC  
1100V (UL) AC  
Current Rating: 50A-1400A  
Interrupt Rating: 150kA

● **Mechanical Dimensions:**

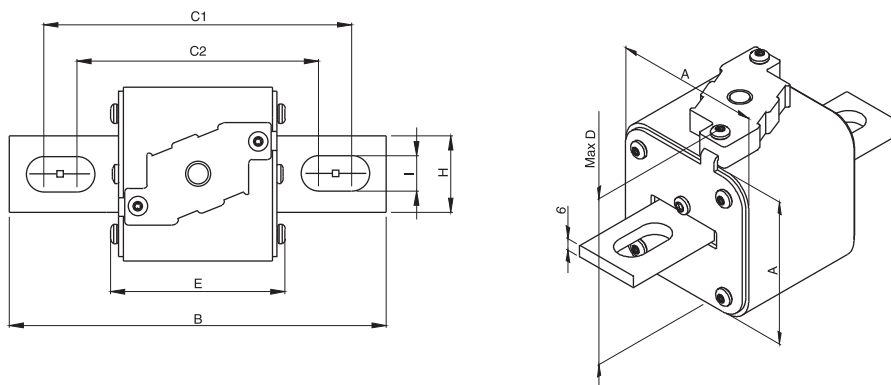
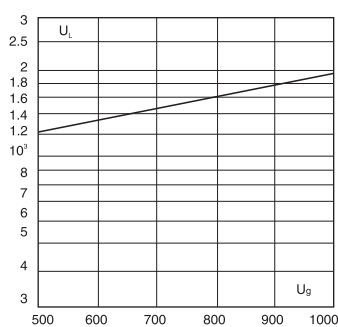

Fig.1

Size	Mechanical Dimensions(mm)							
	A	B	C1	C2	D	E	H	I
A	45	156	130	101	59	-	22	10
B	53	160	127	102	69	-	25	14
C	61	160	127	102	77	-	25	14
E	76	159	128	101	92	-	36	16

● **Electrical Characteristics:**



Arc Voltage

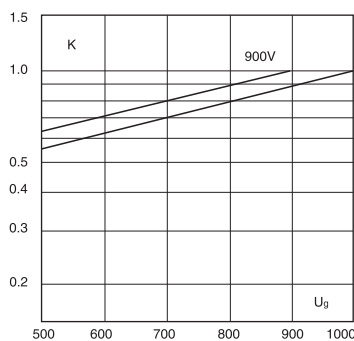

Total Clearing  $I^2t$

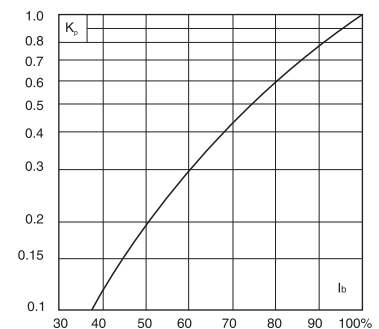

Power Losses

● Electrical Specifications:

Catalog Numbers	Current Rating(A)	Pre-arc $I^2t(A^2S)$	Clearing $I^2t(A^2S,1000V)$	Power Loss (W)	Voltage Rating	Interrupt Rating	Remark
VSP-A	50	132	811	20	690V	150kA	aR
	63	210	1250	24			
	80	455	2710	28			
	100	850	5050	34			
	125	1441	8460	39			
	160	2831	17150	43			
	200	4900	29000	46			
	250	9314	55800	48			
	315	21200	128000	58			
	350	27800	165100	63			
400	41000	245000	68				
VSP-B	160	2150	13200	39			
	200	4110	24100	42			
	250	7712	45100	51			
	315	16200	98000	56			
	350	21100	127000	63			
	400	30200	182000	69			
	450	44100	258000	77			
	500	61900	362000	82			
	550	840000	492000	88			
630	122000	732500	96				
VSP-C	250	6630	39600	64			
	315	13400	81100	73			
	350	16100	98100	78			
	400	25100	150000	81			
	450	35200	210000	88			
	500	28500	284000	92			
	550	63300	381000	97			
	630	92100	542000	105			
	700	127000	755000	112			
800	182500	1154800	123				
VSP-E	315	9100	54400	89			
	350	12500	74800	91			
	400	18400	111000	103			
	450	26300	145000	106			
	500	36100	200000	109			
	550	51200	301290	113			
	630	81300	481900	117			
	700	102500	689000	122			
	800	166500	1014000	132			
	900	243000	1456000	144			
	1000	312000	2008000	149			
	1100	450000	2636000	154			
	1250	563000	3316000	171			
1400	785000	4128000	182				

● Size VSP-00 D11(20A-315A: 1000V)

● Size VSP-H FS(1000A-2700A: 1000V)

Time-Current Curve

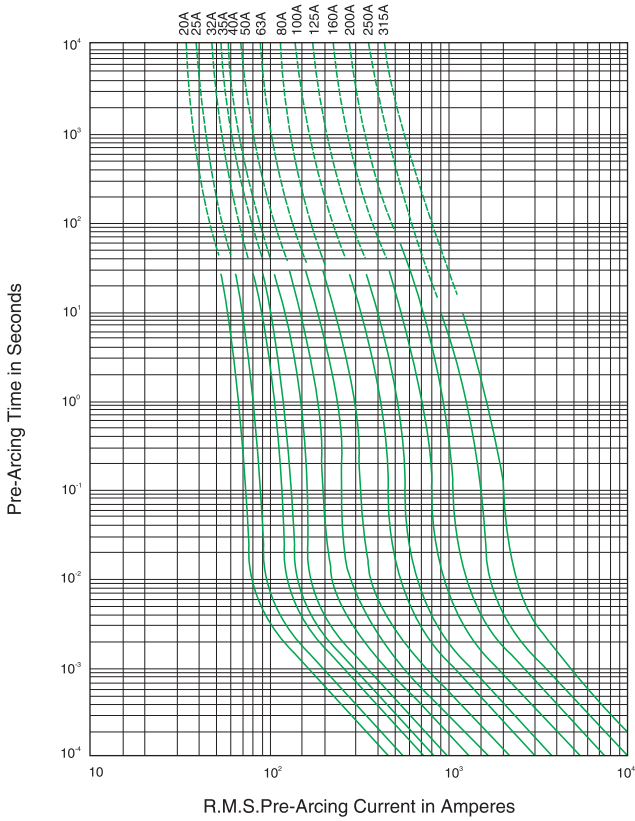

Time-Current Curve

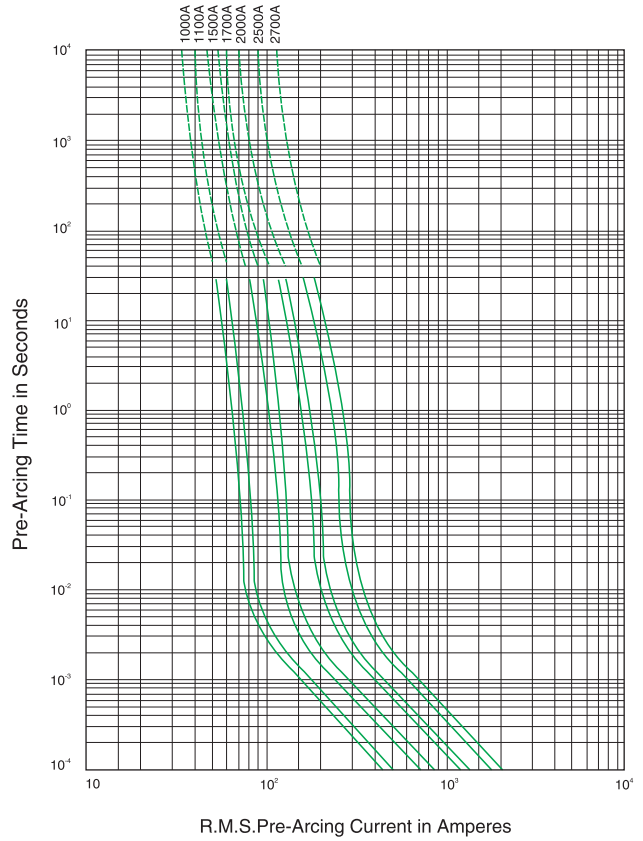

Peak Let-Through Curve

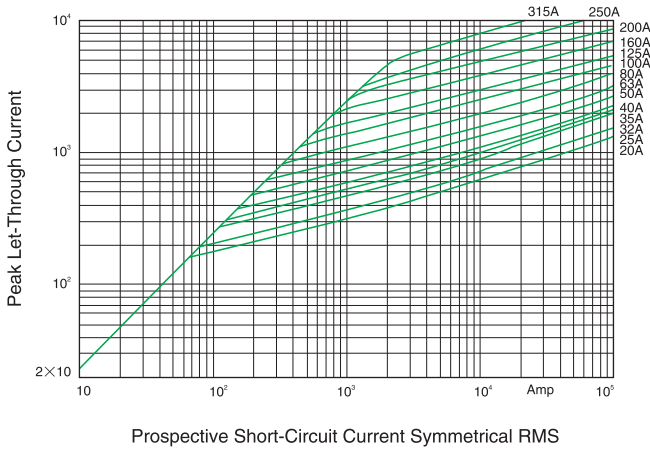

Peak Let-Through Curve

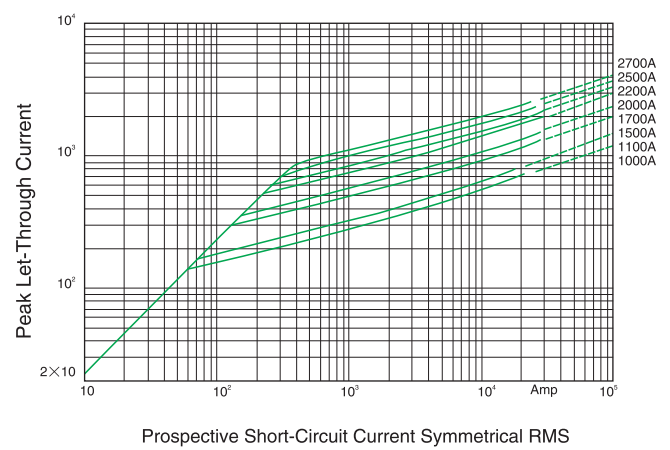



● Size VSP-A (50A-400A: 1000V)

● Size VSP-B(160A-630A: 1000V)

Time-Current Curve

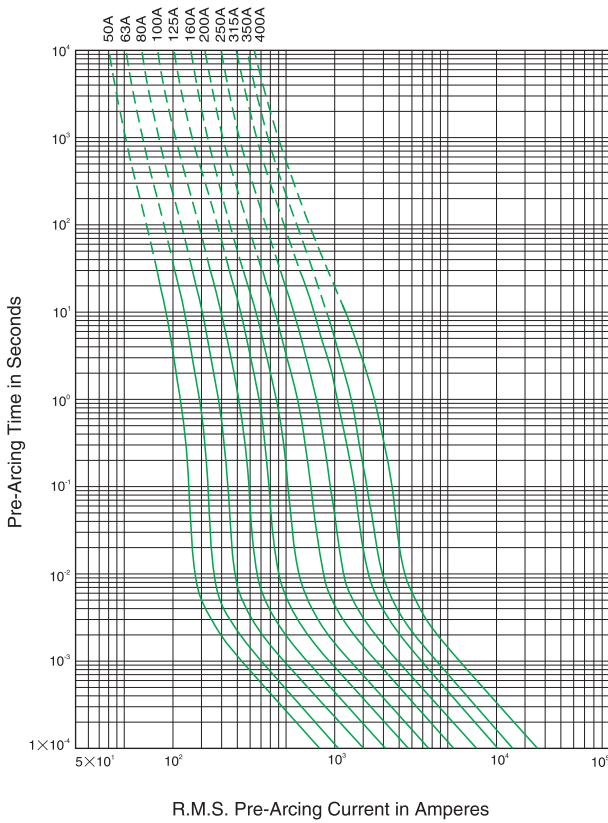

Time-Current Curve

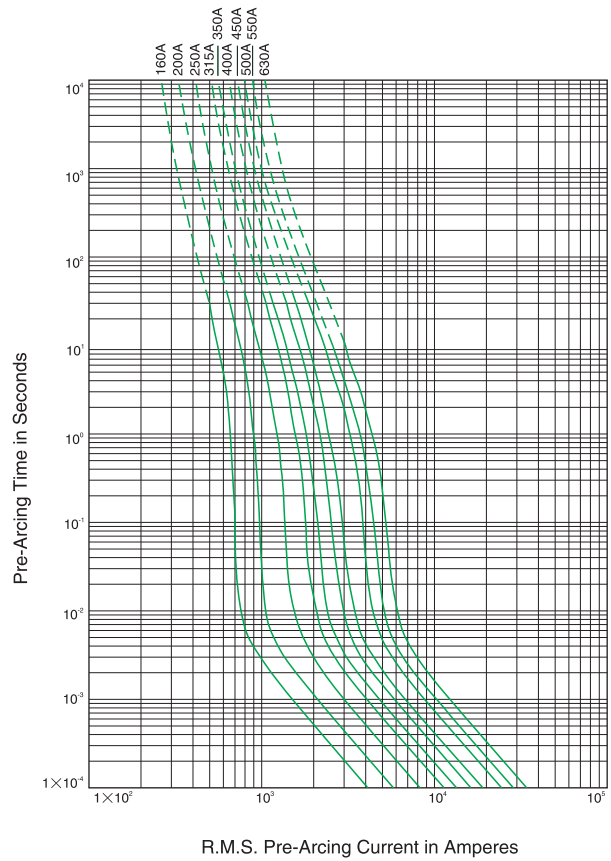

Peak Let-Through Curve

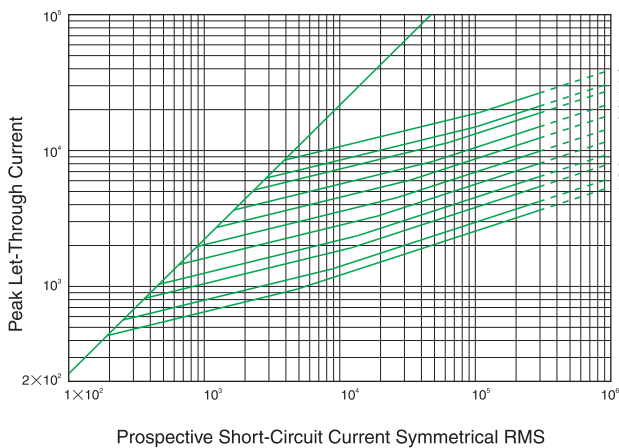

Peak Let-Through Curve

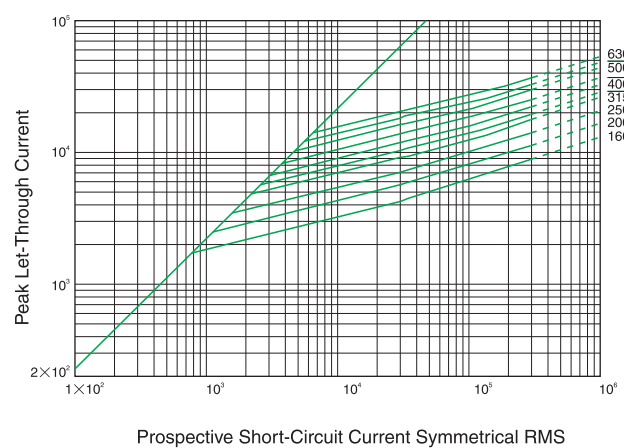

● Size VSP-C (250A-800A: 1000V)

● Size VSP-E (315A-1400A: 1000V)

Time-Current Curve

Time-Current Curve

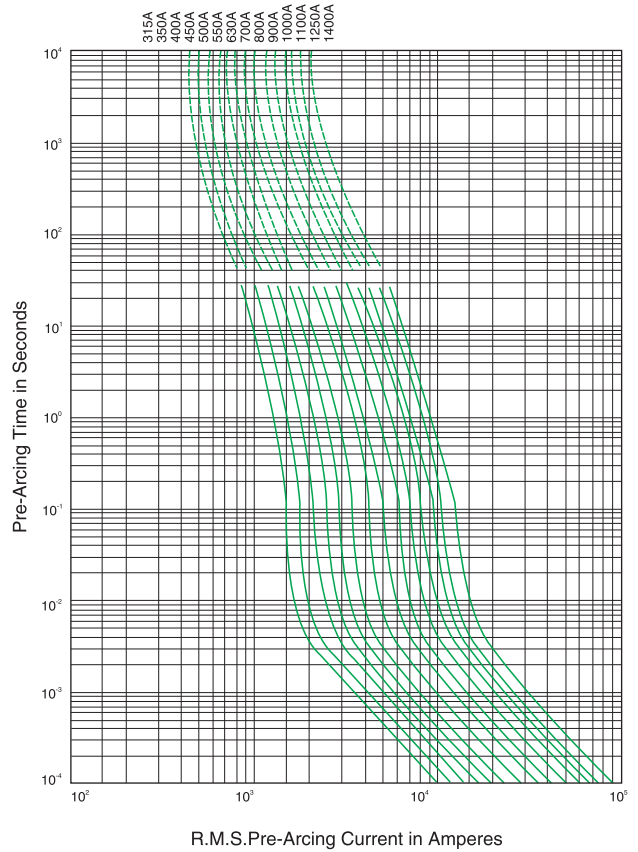
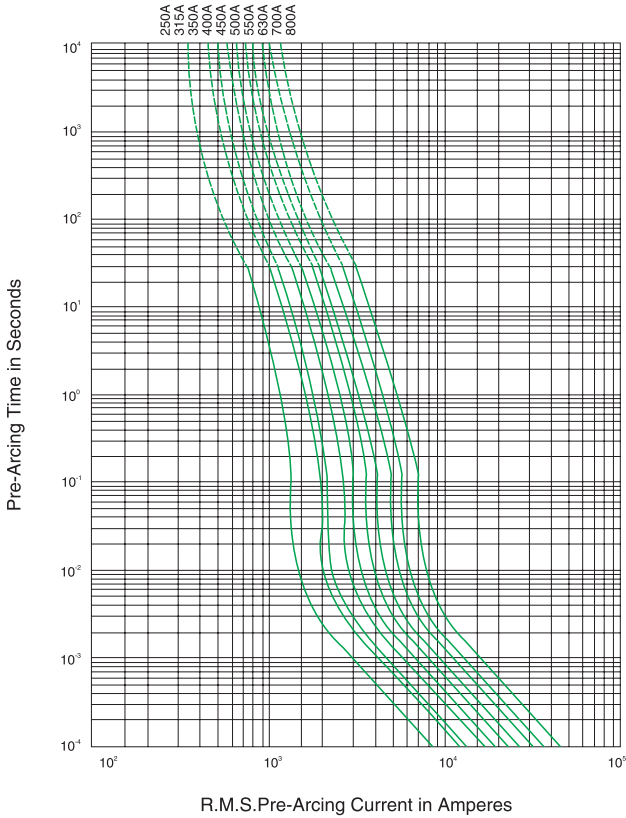

Peak Let-Through Curve

Peak Let-Through Curve

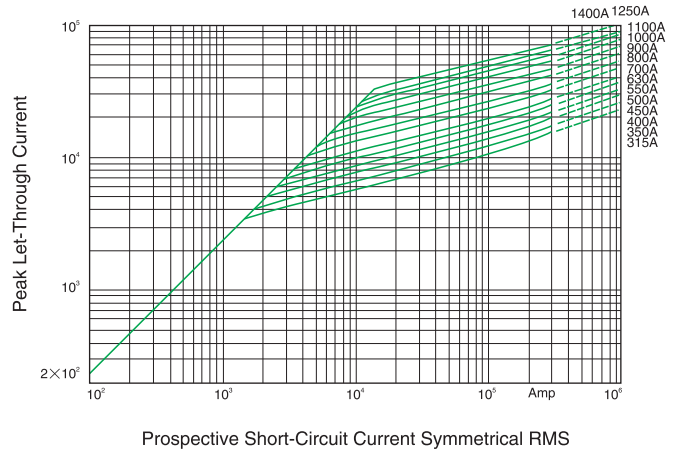
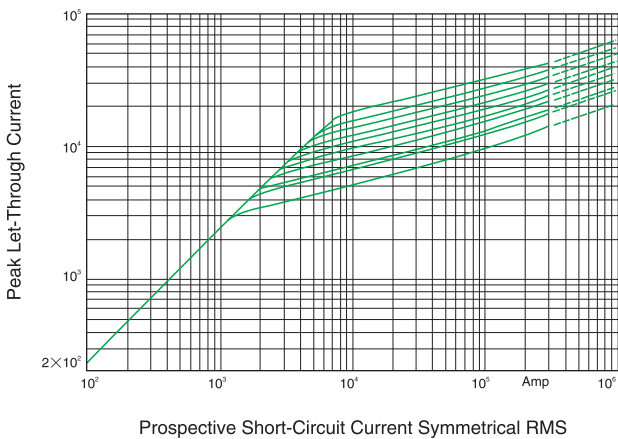

● Size 2×VSP-H FS(2000A-3500A: 1000V)

● Size 2×VSP-H FS(4200A-5000A: 1000V)

Time-Current Curve

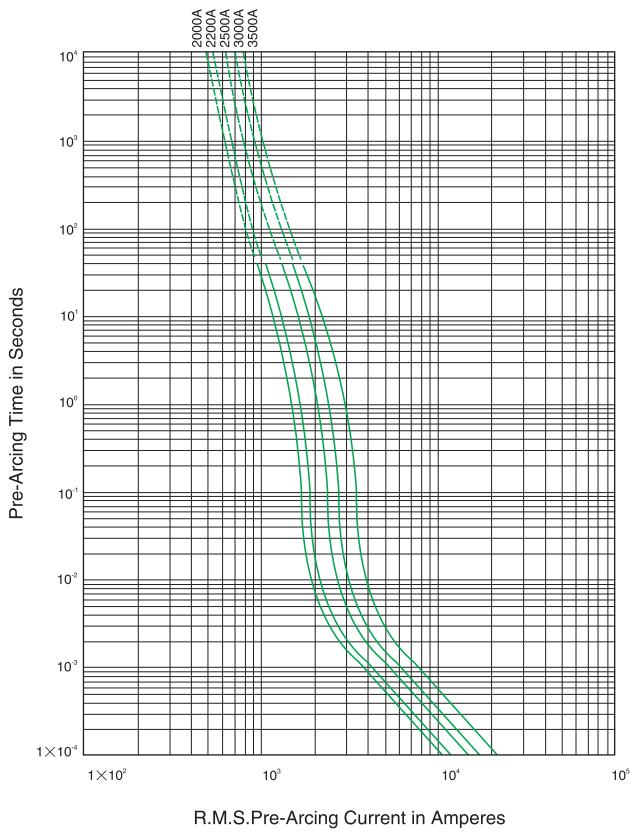

Time-Current Curve

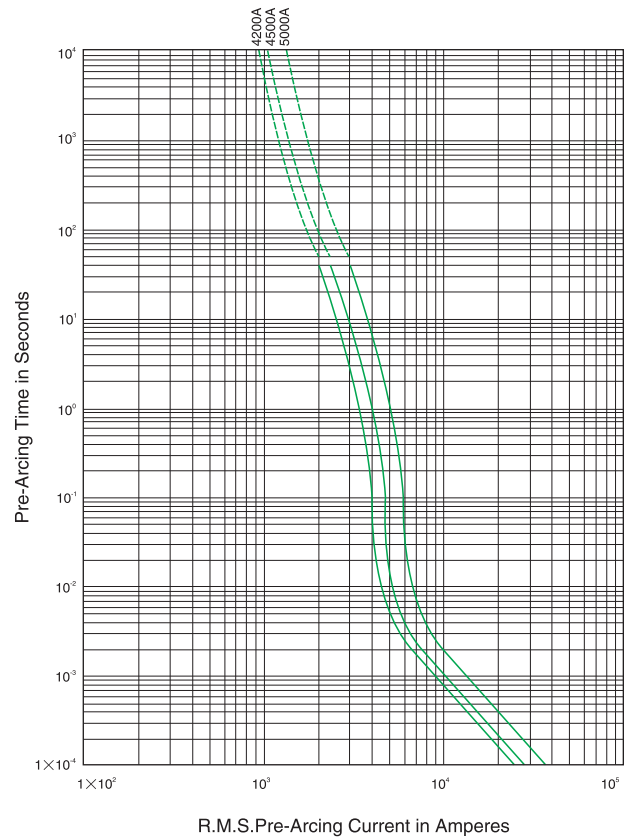

Peak Let-Through Curve

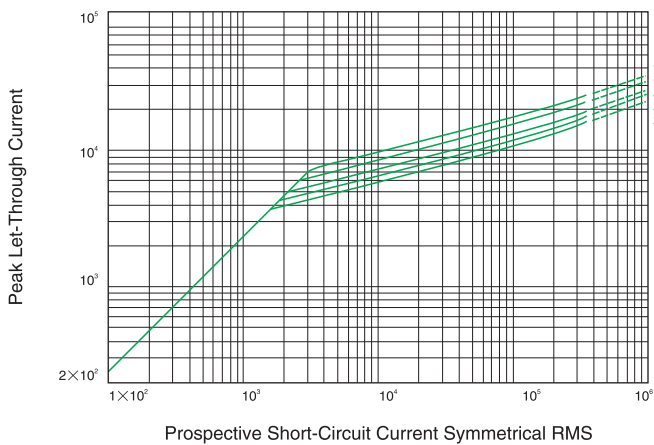

Peak Let-Through Curve

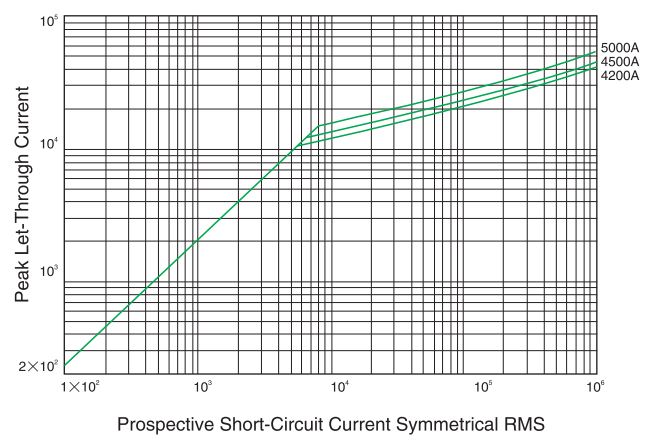

RoHS



**Ratings:**

Voltage Rating: 1250V (IEC) AC

1300V (UL) AC

Current Rating: 50A-2500A

Interrupt Rating: 100kA / 125kA

**Mechanical Dimensions:**

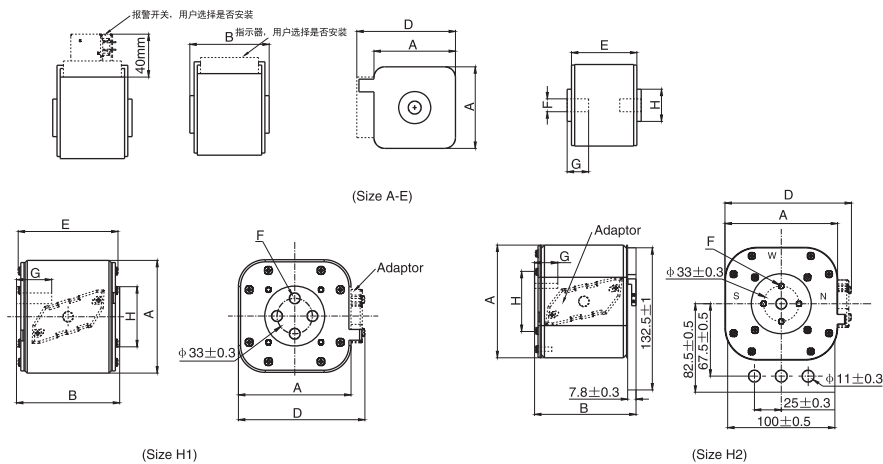

Size	Mechanical Dimensions(mm)						
	A	B	D	E	F	G	H
A	45	81	59	80	M8	5	F17.0
B	53	81	69	80	M8	8	F20.0
C	61	81	77	80	M10	10	F24.0
E	76	83	92	81	M12	10	F30.0
H1	105	106.6	120	93.2	M10	12	F56.0
H2	105	105.9	120	105(Max)	M10	12	F56.0

**Electrical Characteristics:**

(Size A-E)

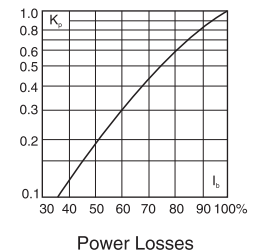
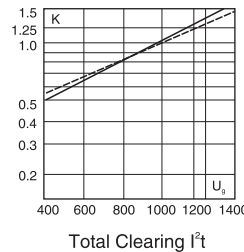
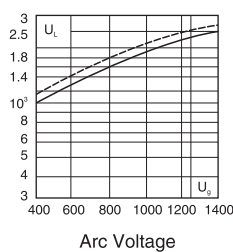

(Size H)

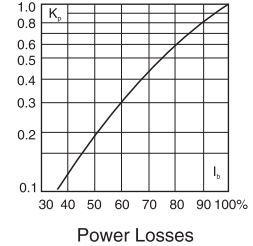
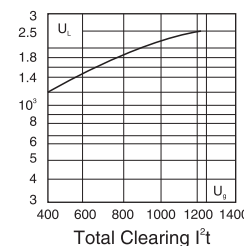
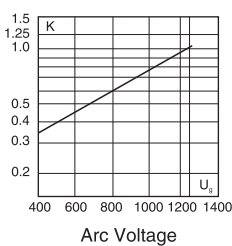

● Mechanical Dimensions:

Catalog Numbers	Current Rating(A)	Pre-arc I <sup>2</sup> t(A <sup>2</sup> S)	Clearing I <sup>2</sup> t(A <sup>2</sup> S,1000V)	Power Loss (W)	Voltage Rating	Interrupt Rating	Remark			
VSP-A	50	132	1050	15	1250V	100kA	aR			
	63	210	1700	20						
	80	415	3300	24						
	100	745	5900	28						
	125	1440	11000	34						
	160	2590	20500	39						
	200	5100	40500	43						
	250	9100	72500	48						
	315	18400	145000	58						
	350	26500	215000	63						
VSP-B	400	52500	330000	68	1250V	100kA	aR			
	160	1850	13200	43						
	200	3750	29000	49						
	250	7712	61000	56						
	315	14900	115000	63						
	350	19500	160000	69						
	400	29000	230000	74						
	450	41500	330000	77						
	500	69000	430000	82						
	550	94000	485000	88						
VSP-C	630	126000	-	96	1100V	100kA	aR			
	250	6430	51000	64						
	280	9320	74000	69						
	315	16000	100000	73						
	350	16100	130000	78						
	400	22100	175000	81						
	450	33200	265000	88						
	500	47500	375000	92						
	550	61300	485000	97						
	630	110000	725000	105						
VSP-E	700	155000	1000000	112	1250V	100kA	aR			
	800	244000	1500000	118						
	900	355000	-	123						
	1000	475000	-	131						
	315	9400	77100	84						
	350	13400	105000	89						
	400	19400	155000	94						
	450	30500	244000	99						
	500	38000	305000	104						
	550	54500	433000	109						
VSP-H	630	83400	663000	114	1100V	125kA	aR			
	700	11400	935000	119						
	800	203000	1250000	124						
	900	302000	1890000	129						
	1000	446000	2730000	134						
	1100	574000	3550000	139						
	1250	800000	-	144						
	1400	1240000	-	149						
	1400	775000	4500000	187				1250V	125kA	aR
	1500	950000	6150000	193						
1700	1350000	8650000	215							
1800	1650000	10500000	222							
2000	2250000	14000000	230							
2200	3050000	19000000	240							
2400	3950000	24500000	250							
2500	4450000	27500000	255							

RoHS



**Ratings:**

Voltage Rating: 1250V (IEC) AC  
 1300V (UL) AC  
 Current Rating: 630A-2800A  
 Interrupt Rating: 125kA

**Mechanical Dimensions:**

(Size 2×H)

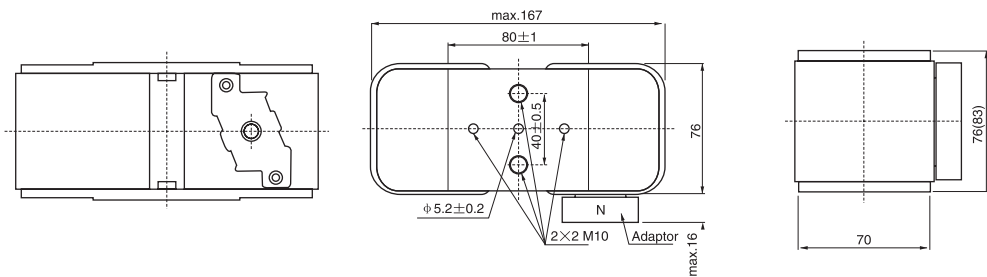

Catalog Numbers	Current Rating (A)	Pre-arc I <sup>2</sup> t (A <sup>2</sup> S)	Clearing I <sup>2</sup> t (A <sup>2</sup> S, 1250V)	Power Loss (W)	Voltage Rating	Interrupt Rating	Note
2×VSP-H	630	37500	305000	165	1250V	125kA	aR
	700	53500	435000	175			
	800	77500	635000	185			
	900	11500	975000	195			
	1000	150000	1200000	205			
	1100	215000	1700000	215			
	1250	325000	2650000	225			
	1400	455000	3750000	235			
	1600	815000	5150000	245			
	1800	1150000	7550000	255			
	2000	1750000	10500000	265			
	2200	2250000	14000000	275			
	2500	3150000	15500000	285	1100V		
2800	4950000	23500000	295				

**Electrical Characteristics:**

(Size 2×H)

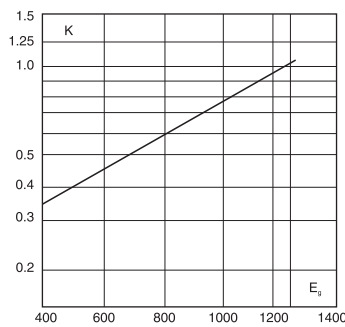

Arc Voltage

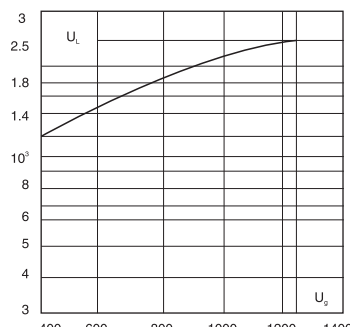

Total Clearing I<sup>2</sup>t

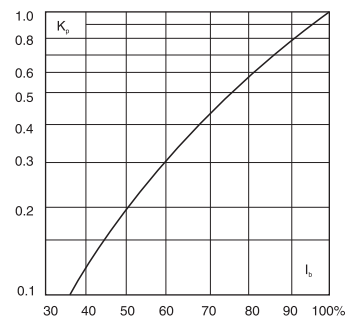

Power Losses

RoHS



**Ratings:**

Voltage Rating: 1250V (IEC) AC  
 1300V (UL) AC  
 Current Rating: 50A-1400A  
 Interrupt Rating: 100kA

● **Mechanical Dimensions:**

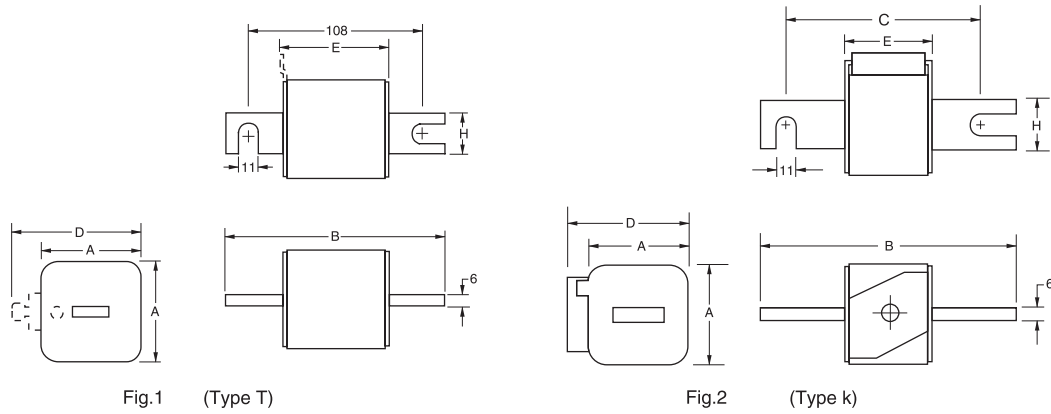

Size	Mechanical Dimensions(mm)						
	A	B	C	MAX D1	E	G	H
A	45	138	108	61	80	6	22
B	53	138	108	69	80	6	25
C	61	138	108	75	80	6	25
E	76	139	108	90	81	6	30

● **Electrical Characteristics:**

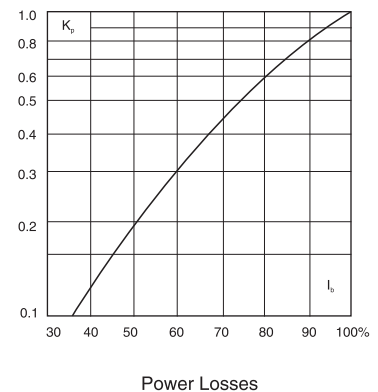
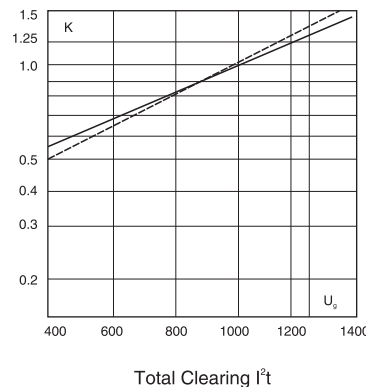
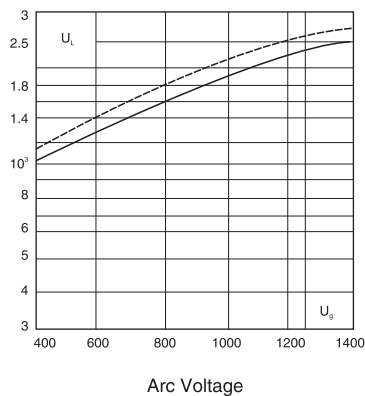

● Mechanical Dimensions:

Catalog Numbers	Current Rating(A)	Pre-arc I <sup>2</sup> t(A <sup>2</sup> S)	Clearing I <sup>2</sup> t(A <sup>2</sup> S,1250V)	Power Loss (W)	Voltage Rating	Interrupt Rating	Note			
VSP-A	50	132	1050	15	1250V	100kA	aR			
	63	210	1700	20						
	80	415	3300	24						
	100	745	5900	28						
	125	1440	11000	34						
	160	2590	20500	39						
	200	5100	40500	43						
	250	9100	72500	48						
	315	18400	145000	58						
	350	26500	215000	63						
VSP-B	400	52500	330000	68	1250V	100kA	aR			
	160	1850	13200	43						
	200	3750	29000	49						
	250	7712	61000	56						
	315	14900	115000	63						
	350	19500	160000	69						
	400	29000	230000	74						
	450	41500	330000	77						
	500	69000	430000	82						
	550	94000	485000	88						
VSP-C	630	126000	-	96	1100V	100kA	aR			
	250	6430	51000	64						
	280	9320	74000	69						
	315	16000	100000	73						
	350	16100	130000	78						
	400	22100	175000	81						
	450	33200	265000	88						
	500	47500	375000	92						
	550	61300	485000	97						
	630	110000	725000	105						
VSP-E	700	155000	1000000	112	1250V	100kA	aR			
	800	244000	1500000	118						
	900	355000	-	123						
	1000	475000	-	131						
	315	9400	77100	84				1100V	100kA	aR
	350	13400	105000	89						
	400	19400	155000	94						
	450	30500	244000	99						
	500	38000	305000	104						
	550	54500	433000	109						
630	83400	663000	114							
700	11400	935000	119							
800	203000	1250000	124							
900	302000	1890000	129							
1000	446000	2730000	134							
1100	574000	3550000	139							
1250	800000	-	144							
1400	1240000	-	149							



RoHS



**Ratings:**

Voltage Rating: 1250V (IEC) AC  
 1300V (UL) AC  
 Current Rating: 50A-1400A  
 Interrupt Rating: 100kA

**Mechanical Dimensions:**

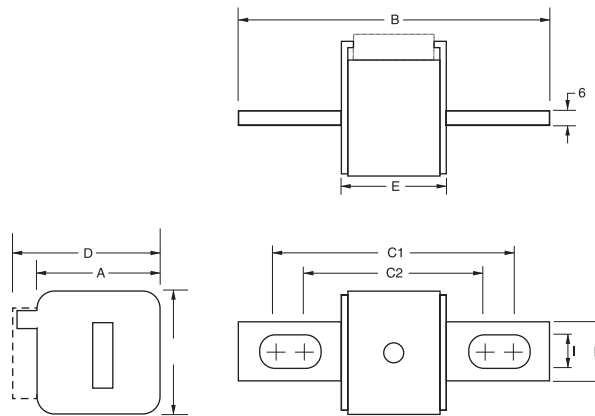
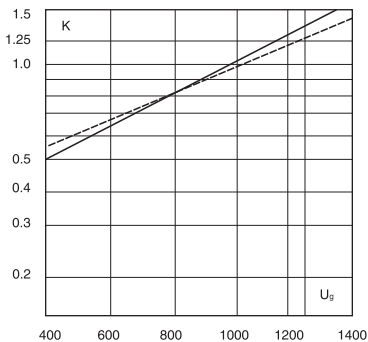

Fig.1

Size	Amps.	Mechanical Dimensions(mm)							
		A	B	C1	C2	D	E	H	I
A	400A	43	156	130	101	61	-	22	10
B	500-630A	51	160	127	102	69	-	25	14
C	630A-1000A	59	160	127	102	77	-	25	14
E	800-1400A	74	159	128	101	92	-	30	16

**Electrical Characteristics**



Arc Voltage

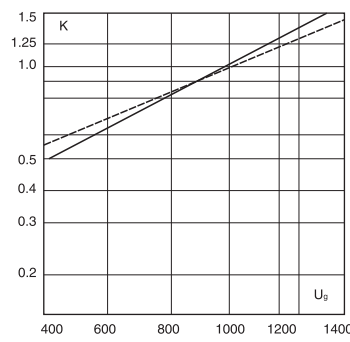

Total Clearing I<sup>2</sup>t

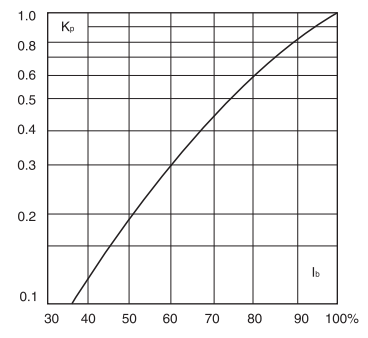

Power Losses

● Mechanical Dimensions:

Catalog Numbers	Current Rating(A)	Pre-arc $I^2t(A^2S)$	Clearing $I^2t(A^2S,1250V)$	Power Loss (W)	Voltage Rating	Interrupt Rating	Remark	
VSP-A	50	132	1050	15	1250V			
	63	210	1700	20				
	80	415	3300	24				
	100	745	5900	28				
	125	1440	11000	34				
	160	2590	20500	39				
	200	5100	40500	43				
	250	9100	72500	48				
	315	18400	145000	58				
	350	26500	215000	63				
VSP-B	160	1850	13200	43				
	200	3750	29000	49				
	250	7712	61000	56				
	315	14900	115000	63				
	350	19500	160000	69				
	400	29000	230000	74				
	450	41500	330000	77				
	500	69000	-	82				1100V
	550	94000	-	88				1100V
630	126000	-	96	1000V				
VSP-C	250	6430	51000	64	1250V	100kA	aR	
	280	9320	74000	69				
	315	16000	100000	73				
	350	16100	130000	78				
	400	22100	175000	81				
	450	33200	265000	88				
	500	47500	375000	92				
	550	61300	485000	97				
	630	110000	725000	105				
	700	155000	-	112				1100V
	800	244000	-	118				1100V
	900	355000	-	123				1100V
1000	475000	-	131					
VSP-E	315	9400	77100	84	1250V			
	350	13400	105000	89				
	400	19400	155000	94				
	450	30500	244000	99				
	500	38000	305000	104				
	550	54500	433000	109				
	630	83400	663000	114				
	700	11400	935000	119				
	800	203000	1250000	124				
	900	302000	1890000	129				
	1000	446000	-	134				1100V
	1100	574000	-	139				
	1250	800000	-	144				
	1400	1240000	-	149				

Semiconductor Protection Fuses

● **Size VSP-A (50A-400A: 1250V)**

● **Size VSP-B (160A-630A: 1250V)**

Time-Current Curve

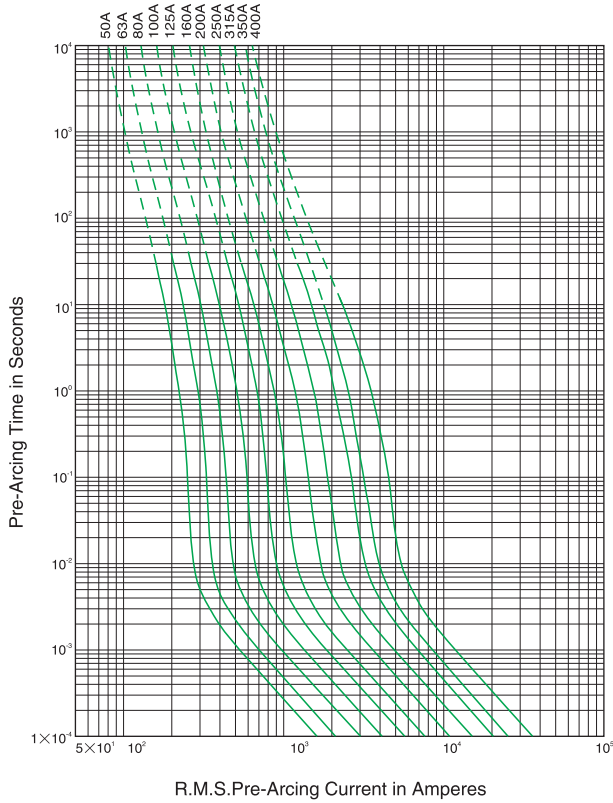

Time-Current Curve

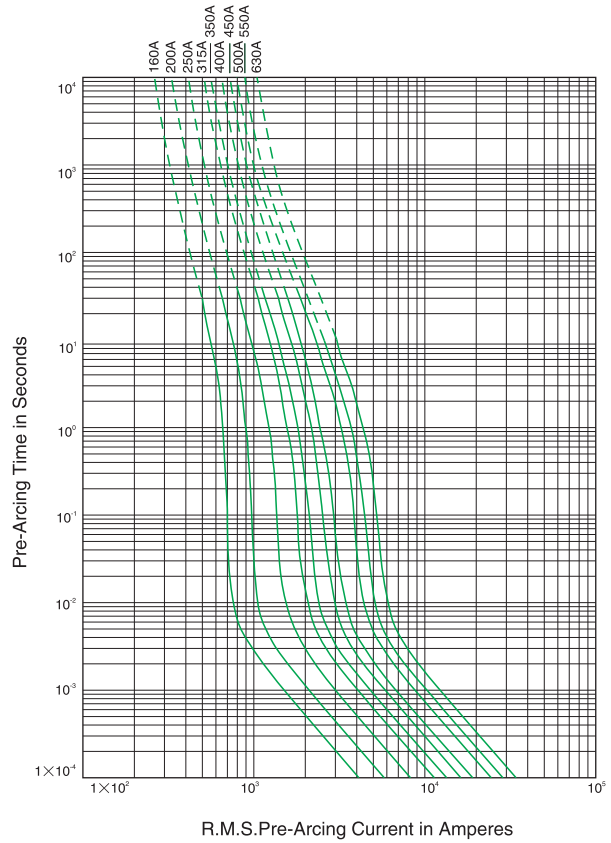

Peak Let-Through Curve

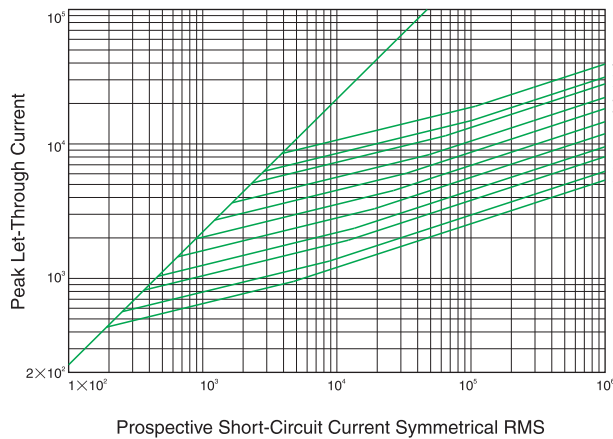

Peak Let-Through Curve

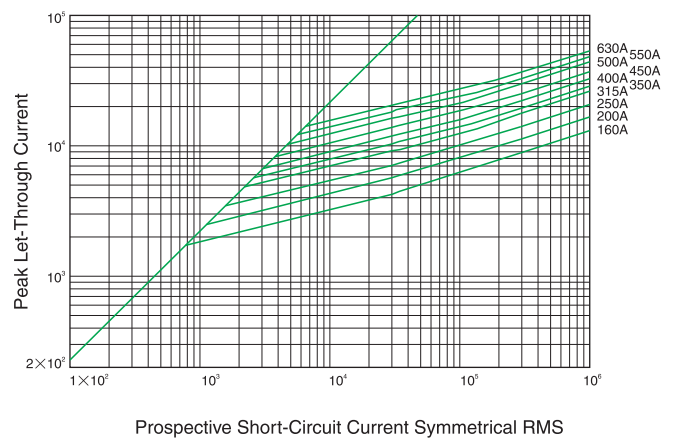

● **Size VSP-C (250A-1000A: 1250V)**

● **Size VSP-E (315A-1400A: 1250V)**

Time-Current Curve

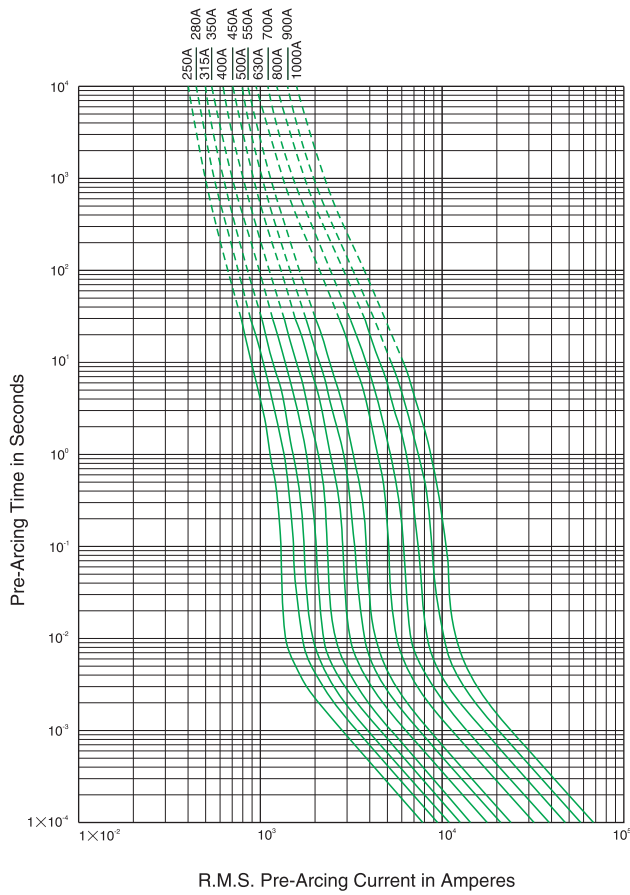

Time-Current Curve

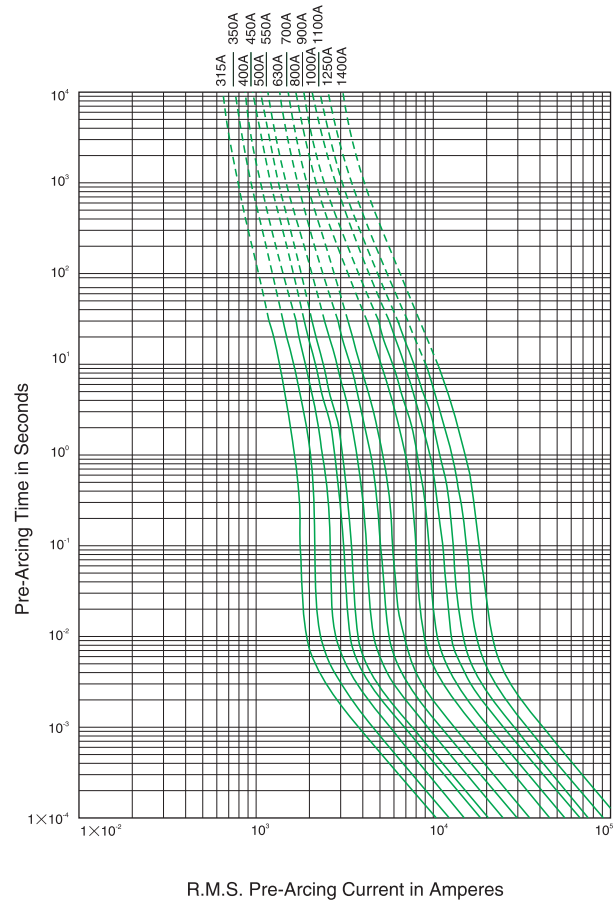

Peak Let-Through Curve

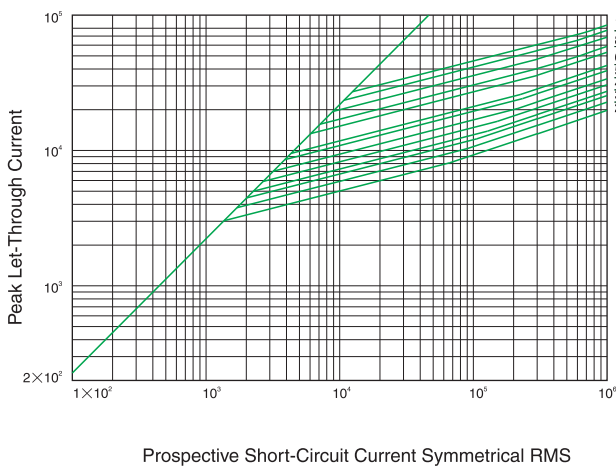

Peak Let-Through Curve

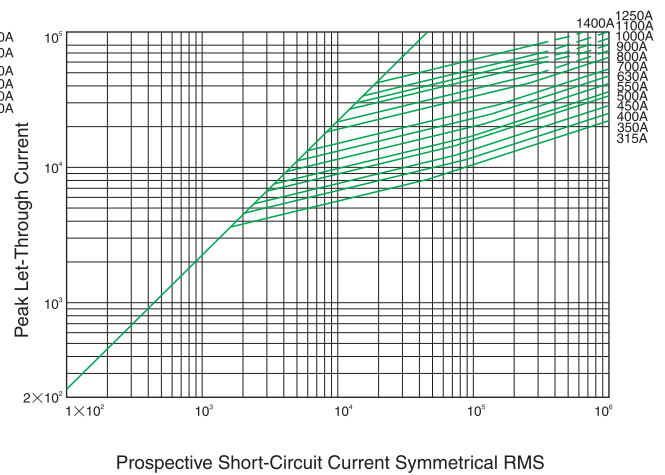

● **Size VSP-H FS(1400A-2400A: 1250V)**

Time-Current Curve

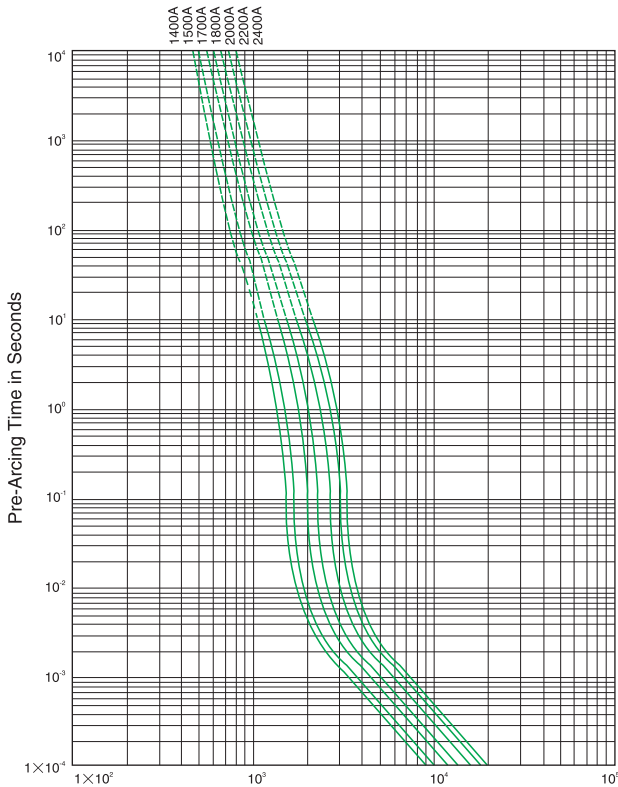

R.M.S. Pre-Arcing Current in Amperes

● **Size VSP-H FS (2400A-2500A: 1250V)**

Time-Current Curve

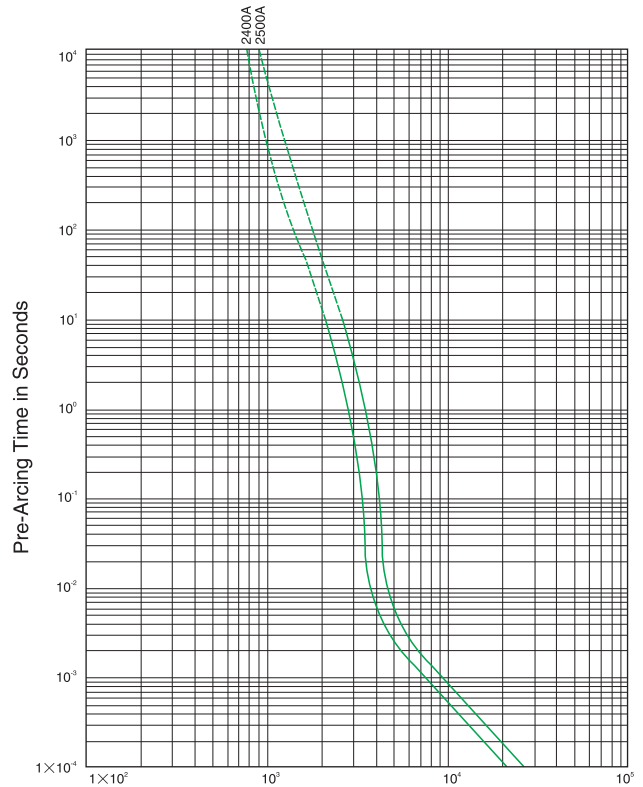

R.M.S. Pre-Arcing Current in Amperes

Peak Let-Through Curve

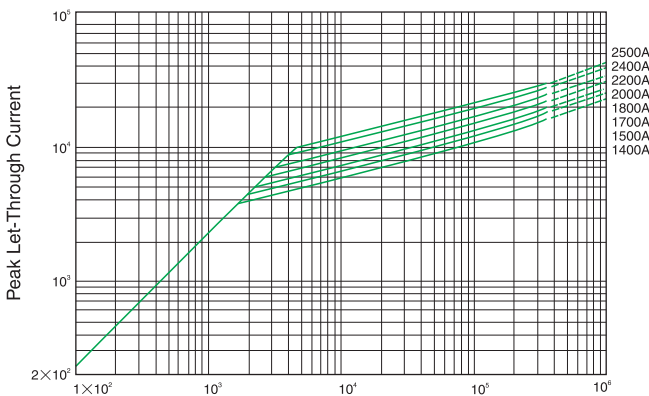

Prospective Short-Circuit Current Symmetrical RMS

Peak Let-Through Curve

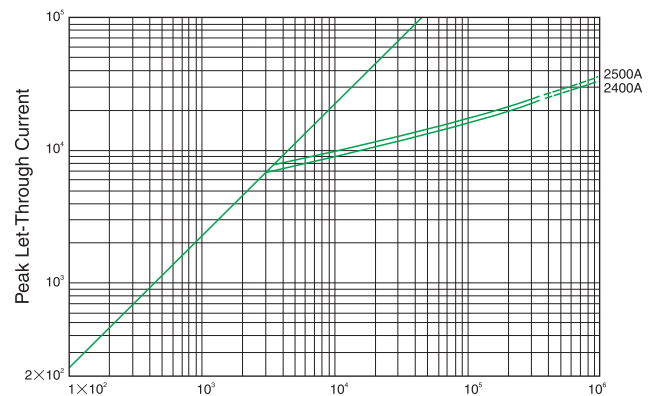

Prospective Short-Circuit Current Symmetrical RMS

● Size 2×VSP-H FS(630A-2800A: 1250V)

Time-Current Curve

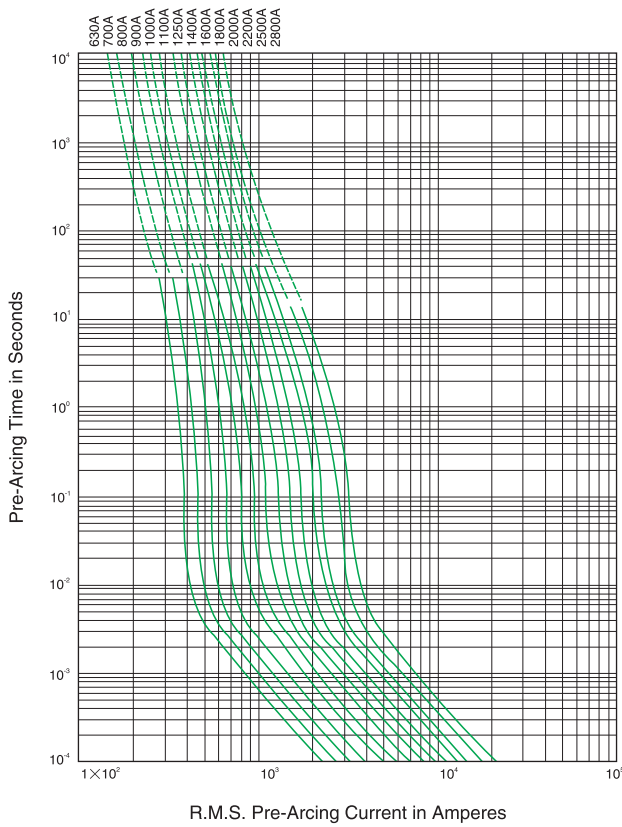

Peak Let-Through Curve

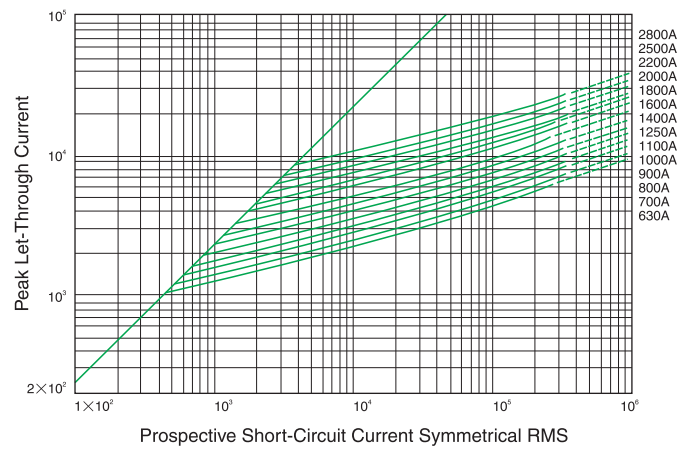

RoHS



**Ratings:**  
Voltage Rating: 1500V AC  
Current Rating: 500A-2000A  
Interrupt Rating: 100kA

● Mechanical Dimensions:

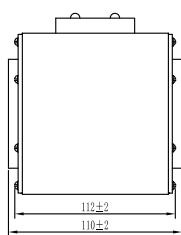

(size H1)

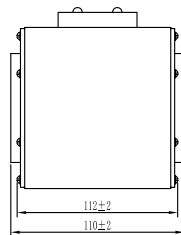
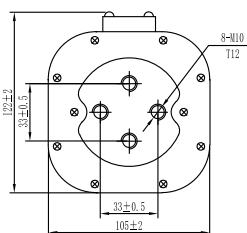

(size H2)

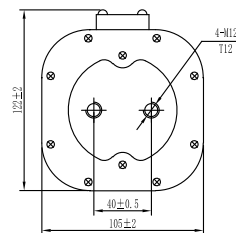

Size	Amps.	Mechanical Dimensions:
H1	500-2000A	size H1
H2	750A-2000A	size H2

● Electrical Characteristics:

(Size H)

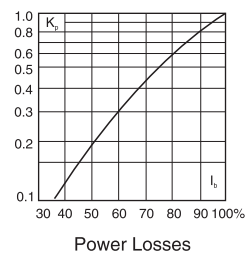
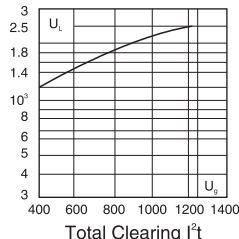
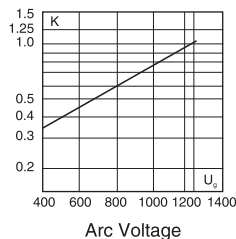

● **Electrical Specifications:**

Catalog Numbers	Current Rating(A)	Pre-arcing I <sup>2</sup> t(A <sup>2</sup> S)	Voltage Rating	Interrupt Rating	Note
VSP-H1	500	150	1500V	100kA	aR
	630	186			
	700	214			
	800	175			
	1000	198			
	1100	202			
	1250	218			
	1400	228			
	1600	235			
	1800	264			
VSP-H2	2000	280	1500V	100kA	aR
	750	263			
	800	254			
	900	290			
	1000	192			
	1250	217			
	1400	220			
	1500	312			
	1600	244			
	1800	265			
2000	280				

● **Size VSP-H (500A-2000A: 1500V)**



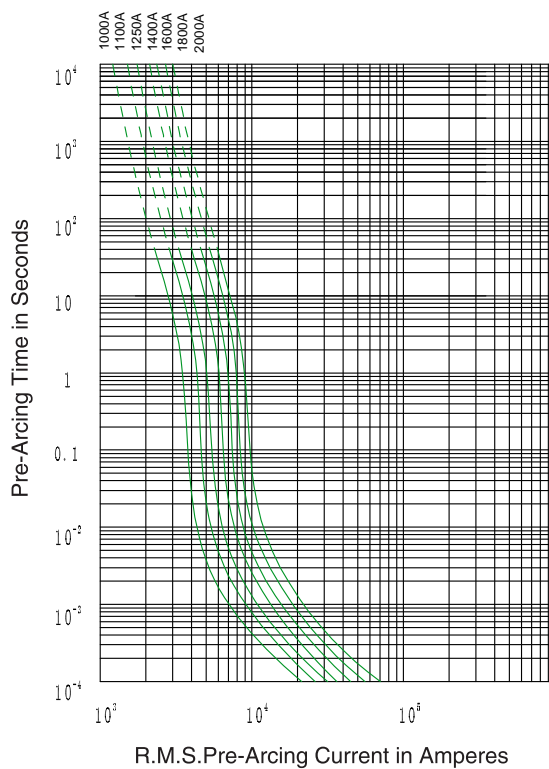



Time-Current Curve





● Basic Information



Products Pic.	Catalog Numbers	Referred Fuse	Current Rating(A)	Voltage Rating	Connection Style	Weight & Packaging
	NT00-SIST101	NT00C (RT16-00C) & NT00 (RT16-00)	160	500V AC 690V AC 250V C	One pole for double terminal connection	225g/PCS (app.) 3PCS/Carton
	NT0-SIST160	NT0			One pole for double terminal connection	410g/PCS (app.) 2PCS/Carton
	NT1-SIST201	NT1	250	AC 500V AC 690V DC 440V	One pole for double terminal connection	740g/PCS (app.) 1PCS/Carton
	NT2-SIST401	NT2	400		One pole for double terminal connection	1110g/PCS (app.) 1PCS/Carton
	NT3-SIST601	NT3	630		One pole for double terminal connection	1310g/PCS (app.) 1PCS/Carton
	NT4-SIST1001	NT4	1600		One pole for double terminal connection	2520g/PCS (app.) 1PCS/Carton

● Mechanical Dimensions:

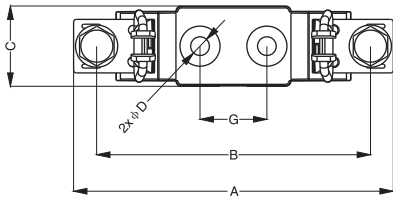

Fig.1

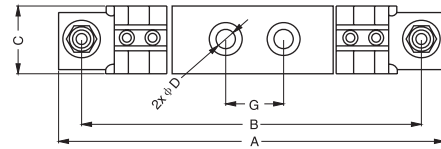

Fig.2

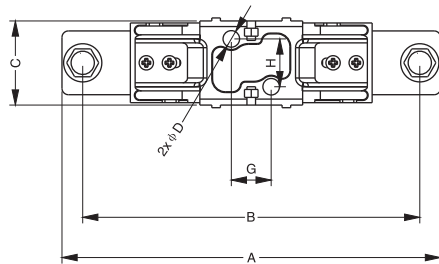
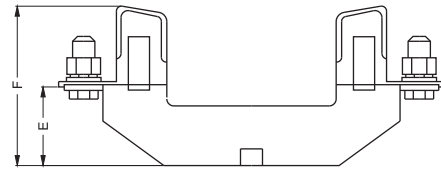
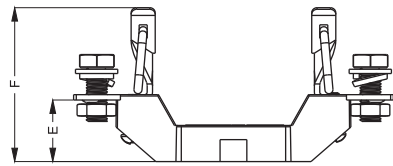

Fig.3

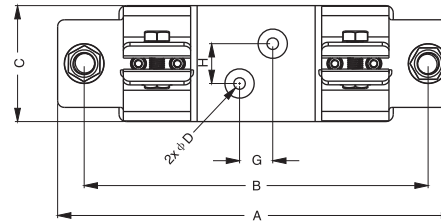
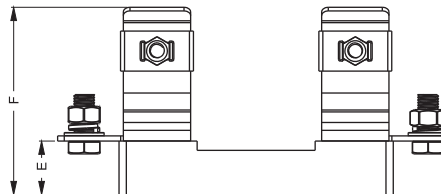
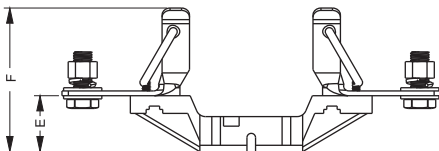

Fig.4



Catalog Numbers	Ref. Fig.	Current Rating(A)	Mechanical Dimensions (Tolerances: ±4mm)							
			A	B	C	D	E	F	G	H
NT00-SIS101	1	160	118	100	30	7	23	57	25	-
NT0-SIS160	2	160	170	150	30	7	35	73	25	-
NT1-SIS201	3	250	200	175	53	10	34	82	25	30
NT2-SIS401	3	400	225	200	53	10	35	95	25	30
NT3-SIS601	3	630	237	210	53	10	35	90	25	30
NT4-SIS1001	4	1600	300	260	87	8.5	40	141	25	30

# Vicfuse

深圳市威可特電子科技有限公司

SHENZHEN VICTORS INDUSTRIAL CO., LTD.

地址：深圳市龍崗區坂田街道上雪科技工業城北區3號B棟6樓

電話：0755-83952751/28309572

傳真：0755-82865705

郵箱：sales@vicfuse.com

網站：www.vicfuse.com www.vicfuse.com.cn

無錫 WUXI

地址：江蘇省無錫市高浪路尚錦城133#702

電話：13728658400

郵箱：Sales12@vicfuse.com

威可特電器配件(香港)有限公司

VICTORS INDUSTRIAL(H.K.)CO., LTD.

地址：香港九龍旺角彌敦道610號荷裏活商業中心1318-19室

電話：852-27108200 傳真：852-27108266

郵箱：saleshk@vicfuse.com



Most of our fuses and fuse holders have won CE, TÜV, UL approvals.

We have a full range of products to meet your requirements.

We can also simplify your specifications or develop products according to your requirements. Send us your inquires.

Your full satisfaction is our promise.

E. & OE. / 本資料僅用于參照

## 匠心 匠人 匠品

Ingenuity, Craftsmen, And Superior Products

All of products meet different safety standards,  
ideal for use in countries worldwide.