

Table of Contents

Compression Connectors

Connector Selector Chart.....	C-3
Compression Connectors Information.....	C-5
Ampacity Rating, Selection and Use, Tooling.....	C-5
Installation Hardware, Industry Standards.....	C-5
Telecommunications Connector Information.....	C-6
Wire Definitions.....	C-7
Plating Objective Table.....	C-7

Code Connectors Accommodating Flexible Wire

444S / 644 Series of Tools.....	C-8
4-POINT® 81K Series of Tools.....	C-9

Expanded Ranges

444S / 644 Series of Tools.....	C-10
4-POINT® 81K, 4PC Series of Tools.....	C-11

Copper Compression - Code

One Hole Standard Barrel.....	C-13
One Hole Standard Barrel Narrow Tongue.....	C-18
One Hole Long Barrel.....	C-21
One Hole Long Barrel w/ Inspection Window.....	C-25
Two Hole Standard Barrel.....	C-29
Two Hole Standard Barrel Narrow Tongue w/ Inspection Window.....	C-33
Two Hole Long Barrel.....	C-35
Two Hole Long Barrel Narrow Tongue.....	C-39
Two Hole Long Barrel w/ Inspection Window.....	C-43
Four Hole Long Barrel.....	C-47

Copper Compression - Flex

Copper Flex Wire Table.....	C-48
One Hole Standard Barrel.....	C-49
One Hole Standard Barrel Narrow Tongue.....	C-53
One Hole Standard Barrel No Window.....	C-56
One Hole Standard Barrel, Belled End.....	C-59
One Hole Long Barrel w/ Inspection Window.....	C-61
One Hole Long Barrel, Belled End, No Window.....	C-64
Two Hole Standard Barrel.....	C-67
Two Hole Standard Barrel Narrow Tongue.....	C-71
Two Hole Long Barrel w/ Inspection Window.....	C-74
Two Hole Long Barrel, Belled End, No Window.....	C-78
Two Hole Long Barrel Narrow Tongue.....	C-82
One Hole Standard Barrel, Tin-Zinc Plated.....	C-84
Two Hole Standard Barrel, Tin-Zinc Plated.....	C-87

Unique Feature Compression Connectors

Blank Tongue Long Barrel.....	C-90
Two Hole Standard Barrel, Slotted.....	C-93
Two Hole Long Barrel, Slotted.....	C-94
Two Hole Long Barrel, Slotted w/ Inspection Window.....	C-95
Two Hole Long Barrel, Slotted w/ Inspection Window (Flex).....	C-96
Split Tongue Standard Barrel.....	C-98
Split Tongue Long Barrel.....	C-100
Equipment Line, One & Two Hole Narrow Tongue.....	C-101

Metric Compression Connectors

One Hole Standard Barrel - Code.....	C-104
One Hole Long Barrel - Code.....	C-108
Two Hole Standard Barrel - Code.....	C-111
Two Hole Long Barrel - Code.....	C-114
One Hole Standard Barrel - Flex.....	C-118
One Hole Long Barrel - Flex.....	C-121
Two Hole Standard Barrel - Flex.....	C-124
Two Hole Long Barrel - Flex.....	C-127

Copper Adaptor Connectors

HYPLUG™ Compression.....	C-130
HYSTACK™ Stacking.....	C-134

Copper Compression Splices

Uninsulated Parallel Splice.....	C-136
Copper Compression Standard Barrel Splice.....	C-138
Copper Compression Long Barrel Splice.....	C-139
Reducing Adapter for Copper.....	C-140
Copper Compression Standard Barrel Belled Ends.....	C-141
High-Voltage Standard Barrel Tapered Ends.....	C-144
Copper Compression Long Barrel Belled Ends.....	C-145

Copper Compression In Line Splice Kits

Code/Flex Standard Barrel w/ Inspection Window.....	C-147
Reducing Splice Kit Code/Flex Standard Barrel w/ Inspection Window.....	C-149
Reducing Splice Kit Code/Flex Standard Barrel No Window.....	C-163
Reducing Splice Kit Code/Flex Long Barrel w/ Inspection Window.....	C-167
Reducing Splice Kit Code/Flex Long Barrel No Window.....	C-173

Compression Tap Connectors

Thin Wall Copper C-Tap.....	C-176
C-Tap.....	C-177
C-Tap CRIMPIT™.....	C-178
H-Tap CRIMPIT™.....	C-179
H-Tap Flame Retardant Cover (black).....	C-183
H-Tap Flame Retardant Cover (clear).....	C-183
Split H Copper CRIMPIT™.....	C-184

Copper Compression T-Coupler

Copper HYTEE™ Coupler.....	C-186
----------------------------	-------

Table of Contents

Aluminum Compression Connections

One Hole for Aluminum/Copper	C-187
Two and Four Hole for Aluminum/Copper	C-190
Transformer Lug Kit.....	C-193
YA-A Installation Tool Table Mechanical/Ratchet	C-194
YA-A Installation Tool Table Hydraulic (requiring dies)	C-195
YA-A Installation Tool Table Hydraulic (dieless)	C-196
YA-A Installation Instructions.....	C-197

Aluminum Adaptor Connectors

HYPLUG™ for Aluminum/Copper.....	C-198
----------------------------------	-------

Aluminum Compression Splices

HYLINK™ for Aluminum/Copper.....	C-200
Reducing Splice for Aluminum/Copper	C-202

Aluminum Compression Taps

H-Tap for Aluminum/Copper.....	C-203
--------------------------------	-------

Compression Battery Terminals

Straight Style Battery Post	C-204
T-Style Battery Post	C-205
One Hole Grounding/Starter Lugs.....	C-206

Compression Cable Pulling Heads

Compression Cable Pulling Heads Aluminum/Copper.....	C-207
--	-------

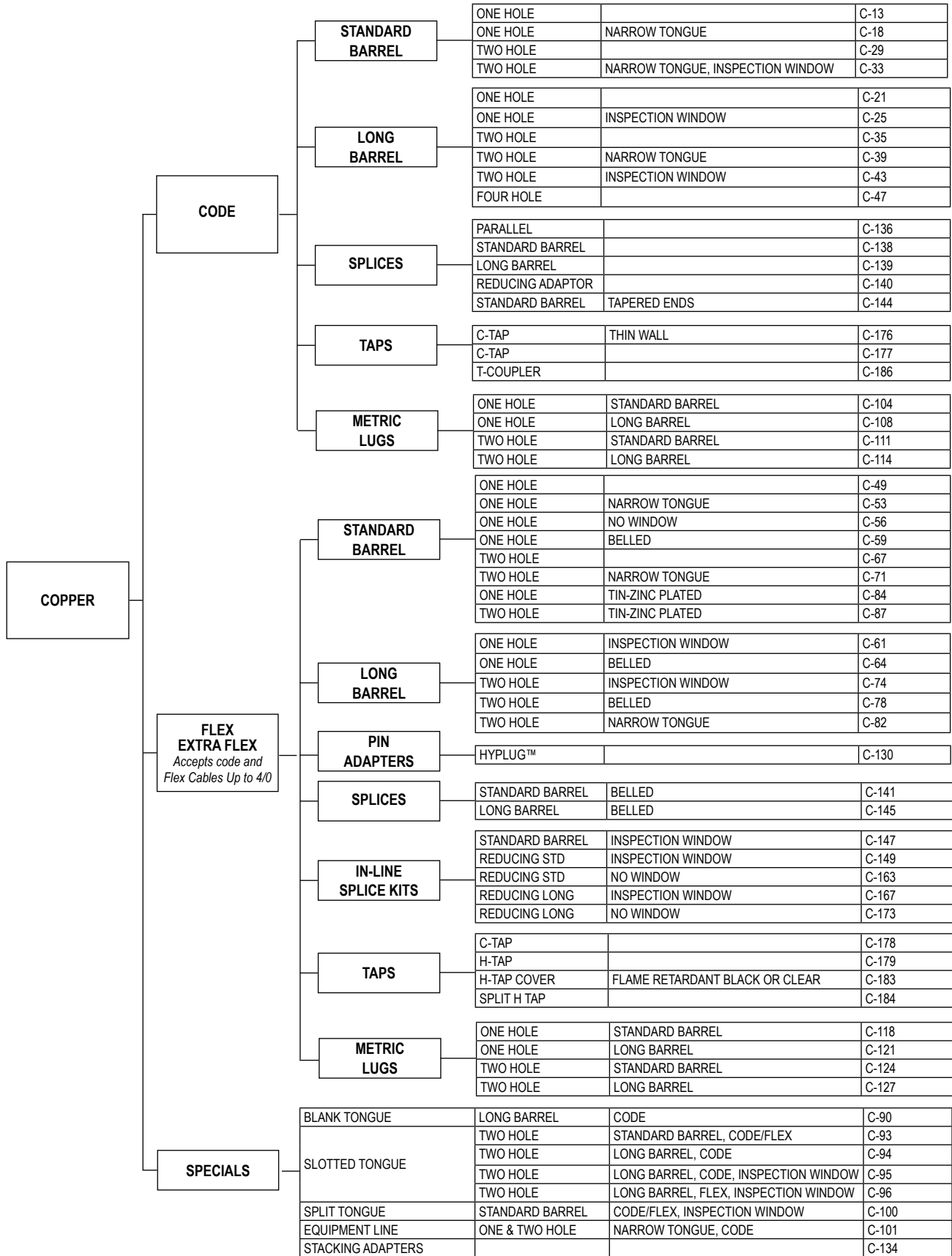

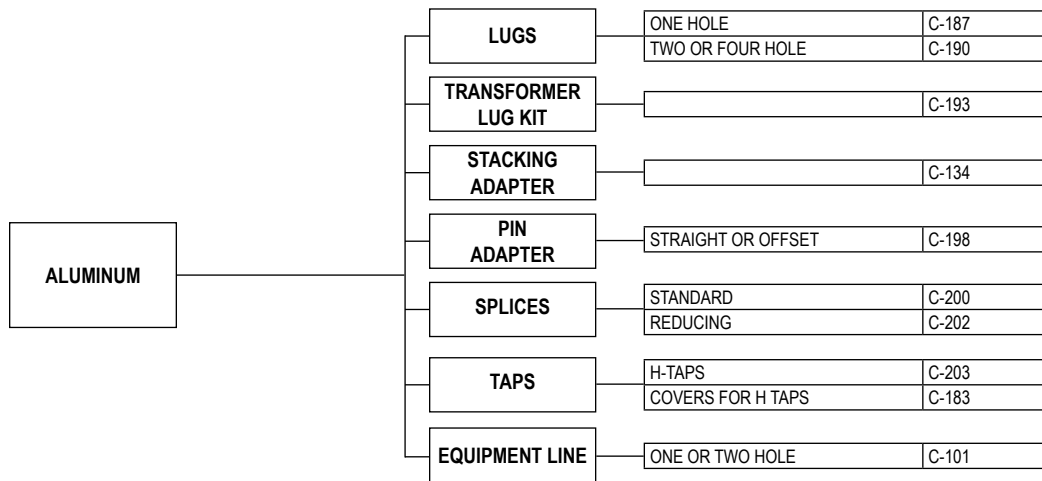

Compression Connectors

BURNDY® compression connectors are designed for reliable and controllable electrical connections. The complete installation is fully inspectable. They are high conductivity copper and operate cooler than the wire on which they are installed. The connectors withstand a wide range of electrical and environmental conditions, including current surges, temperatures, corrosion and vibrations, for a wide variety of applications. These features mean a consistently high quality connection at a low installed cost.

Copper compression connectors are manufactured from high-conductivity electrolytic copper. The connectors are normally tin-plated, lead-plated, or plated with proprietary BURNDY® brite finish to provide durable long-lasting corrosion resistance. The connector design has been matched to the cable size to provide the necessary physical strength requirements for reliable electrical performance.

Aluminum compression connectors are manufactured from high conductivity, high purity wrought aluminum. They are designed with sufficient mass and are electro-tin plated to minimize corrosion due to galvanic action between dissimilar metals. The connector barrels are pre-filled with PENETROX™, BURNDY oxide inhibiting compound.

PENETROX™ contains homogeneously suspended metallic particles which penetrate the wire's oxides to establish excellent continuity between the individual strands and the connector barrel for a low-resistance connection. PENETROX™ maintains an airtight connection. Each barrel end is covered with a color-coded plastic dust cap which prevents foreign matter from entering the connector before it is used. The connector design has been engineered to match the cable size to provide the necessary physical strength requirements for reliable electrical performance.

Connector Ampacity Rating

Per NEC 110.14(C) Provision (2) installed pressure connectors shall be used with conductors at the ampacities not exceeding the ampacity at the listed and identified temperature rating of the connector. Most BURNDY connector temperature ratings in this section, are rated 90°C, therefore the connector is rated to accommodate the ampacity of a conductor operating at or below 90°C.

Selection and Use

Copper compression connectors are recommended for use on copper conductors. Aluminum compression connectors are recommended for use on aluminum conductors. Dual-rated aluminum compression connectors may be used on both copper and aluminum conductors.

Two basic compression designs are available: Circumferential and indent. After compression, virtually all the air is removed leaving a tight homogeneous mass of connector and conductor.



Circumferential compression is solid and symmetrical. No sharp flash.

Indent Compression. The connector is swaged to the conductor.

The circumferential crimp design is recommended for color coded connectors in low and high voltage applications. Die index number embossment

provides an easy inspection where required to verify the use of the proper connector/die combination. It is also recommended for insulated connectors and for terminating flexible and welding cables.

The circumferential crimp design dies compress cable strands into polygonal shapes forming intimate contact with each other and the connector barrel. This compression forms a tight homogeneous mass with virtually no air pockets. The circumferential crimp provides an excellent electrical connection with high pull-out values. The circumferential crimp is ideal for high voltage applications leaving the connector barrel symmetrical, which is easier to insulate.

The indent type crimp can be used in virtually any application except polyvinylchloride (PVC) insulated terminals and splices. It is an excellent means of terminating flexible, extra flexible and welding cables. The indenter compresses the cable strands to form intimate contact with each other and the connector barrel. The result is an excellent electrical connection with high pull-out strength. Laboratory work testing curves established the proper depth and shape of indent for each type of connector and wire combination.

Tooling

Tooling systems are essential for proper installation of a compression connector. Since connectors and dies are designed as a unit for specific wire sizes, only the recommended tools and dies should be used. Most aluminum and copper HYLUG™ terminals and HYLINK™ splices are marked with a die index number and are color-coded to identify the correct installation die. Dies marked with the matching die index number and color can be used to install the connector.

BURNDY® tooling installs a wide range of connectors, is reliable, cost effective, and precision engineered for durable, long-lasting service and quality connections. The tools include small plier types, full cycle ratchet designs and hydraulically-powered HYPRESS™ heads and new Battery Actuated Tools. Some have permanent die grooves or adjustable dies, while others require a change of die sets or nest die for each connector size. BURNDY recommended tools achieve crimp performance consistent with UL and other industry standards. Since several tools are suitable for most connectors, the most economical and practical tool can be chosen for each application.

Installation Hardware

See the Hardware Section or Reference Section of the BURNDY Master Catalog for information on Recommended Hardware Materials and Tightening Torque Values.

Industry Standards

BURNDY compression terminals, splices, and tap connectors requiring third party testing and approval are listed by Underwriters Laboratories, Inc. (UL), and/or Canadian Standards Association (CSA), and all confirm to the applicable sections of the National Electrical Code (NEC).

Per UL486A-486B - Wire Connectors (1.3) standard, this standard is intended for connectors suitable for currents not exceeding the ampacity of insulated conductors rated 75°C or 90°C in accordance with the rating of the connector, if provided.

BURNDY® also offers connectors and splices which meet the (LOCA Seismic and Aging) requirements of IEEE standards 323, 383 and 344 for class 1E critical circuits for use in Nuclear Utility Applications. Certification to 10CFR50 and 10CFR21 available.

Detail catalog listings should be consulted to obtain the appropriate standards for each connector and splice.

Telecommunication Compression Connectors

The industry's first choice in compression connectors...

BURNDY® provides a complete selection of one and two hole compression's terminals, H-taps, C-taps, and other compression connection products specifically engineered to meet the demanding applications of both the Central Office and Wireless communications markets.

All of the BURNDY compression products are designed for reliable and controllable electrical connections. All connectors are made from high conductivity electrolytic copper and operate at cooler temperatures than the conductor on which they are installed. The connectors are normally tin-plated, lead-plated, or plated with a proprietary BURNDY® brite finish to provide the industry standard in long-lasting corrosion resistance.

The complete installation is fully inspectable and UL Listed when installed with BURNDY® dies. Every die in the system is color-coded and provides die index embossment for complete inspectability.

BURNDY® Tooling... the right choice for the job!

BURNDY® tooling installs a wide range of connectors, is reliable, cost effective, and precision engineered for durable, long-lasting service and quality connections. BURNDY compression tooling system ranges from full cycle ratchet hand tools to 12 and 15 ton hydraulically-powered HYPRESS™ heads. Hydraulic tools are available in self-contained, battery powered, and AC service electrically powered pump and remote head designs to meet all possible installation situations.

The Circumferential Crimp...

The BURNDY® circumferential crimp provides a solid, homogenous connection, with high pull out values and is rated for high voltage applications, more than sufficient for the 48V DC operating voltage common in the telecom market. In addition the circumferential crimp doesn't require the removal of the copper flash produced by other die systems. This not only saves time in installation but removes a potential safety hazard from the job.

All of the dies in the system are color-coded to match the connectors and feature die index and die number matching to the connector for ease of installation.



Circumferential compression is solid and symmetrical. No sharp flash.

NOTE: Field bending straight lugs to achieve an angular connection will void UL Listing / CSA Certifications and BURNDY will not be liable for the connection.

Wire Definitions

- Copper Code Stranded Wire, as listed in this section refers to: Class B (Concentric, Compressed, Compact) or Class C
- Copper Flexible Wire, as listed in this section refers to: Listed by Nominal Wire followed by the designated wire classes (G, H, I, K, M, and DLO)
- Aluminum Stranded Wire, as listed in this section refers to: Class B (Concentric, Compressed, Compact)
- Copper Clad Aluminum (CCA) Stranded Wire, as listed in this section refers to: CCA stranded wire

Objective	Plating			
	Electro-tin	Hot Tin Dip	Nickel	Silver*
Reduce galvanic corrosion (bimetallic)	X	X	—	—
Resist corrosive elements	X	X	—	—
Increase conductivity/lower contact resistance	—	—	—	X
Provide high, continuous service temperatures (maximum)	X (347°F/175°C)	—	X (650°F/343°C)	X (500°F/260°C)
*Note: Never connect an aluminum surface to a silver plated surface. Aluminum in contact with silver results in a highly corrosive joint, which will further result in a high resistance connection.				

Compression Connections

Code Connectors Accommodating Flexible Wire with 444S and 644 Series Dieless Tools

Code Connectors Accommodating Flexible Wire with Dieless Tools

The following code connectors can accommodate flexible wire when using the 644 or 444S series dieless platform of installation tools **ONLY**. See table for specific connector to wire combinations.

Example: YA2CN code connector that accommodates #2 AWG Class B,C, can also accommodate a #3 Class G, H, I, K, M, DLO flexible wire when using a 644 or 444S series tools with the number of crimps identified in the table below.



Catalog Number Designation		Wire Sizes		# Crimps*	
Terminal	Splice*	Copper Code Wire	Copper Flexible Wire and DLO (if applicable)	Standard Barrel	Long Barrel
YA1C-	YS1C-	#1 AWG	#2 FLEX G,H,I,K,M,DLO	1	1
YA25-	YS25-	1/0 AWG	#1 FLEX G,H,I,K,M,DLO	1	1
YA26-	YS26-	2/0 AWG	1/0 FLEX G,H,I,K,M,DLO	1	1
YA27-	YS27-	3/0 AWG	2/0 FLEX G,H,I,K,M,DLO	1	1
YA28-	YS28-	4/0 AWG	3/0 FLEX G,H,I,K,M,DLO	1	1
YA29-	YS29-	250 kcmil	4/0 FLEX G,H	1	1
YA30-	YS30-	300 kcmil	4/0 FLEX I,K,M,DLO 250 FLEX G,H	1	1
YA31-	YS31-	350 kcmil	250 FLEX I,K,M, 262 DLO	1	1
YA32-	YS32-	400 kcmil	300 FLEX G,H,I,K,M, 313 DLO	1	1
YA34-	YS34-	500 kcmil	350 FLEX G,H,I,K,M, 373 DLO	1	1
YA36-	YS36-	600 kcmil	450 FLEX I,K,M, 444 DLO 500 FLEX G,H	1	1
YA38-	YS38-	700 kcmil	500 FLEX I,K,M, 535 DLO 550 FLEX G,H	1	1
YA39-	YS39-	750 kcmil	600 FLEX G 550 FLEX M	1	1
YA40-	YS40-	800 kcmil	600 FLEX H,I,K,M 650 FLEX G, 646 DLO	1	1
YA44-	YS44-	1000 kcmil	650 FLEX I 750 FLEX G,H, 777 DLO	1	1

*Splices: # of crimps required for each side



Code Connectors Accommodating Flexible Wire with Dieless Tools

The following code connectors can accommodate flexible wire when using the 81K series 4-POINT® dieless platform of installation tools **ONLY**. See table for specific connector to wire combinations.

Example: YA2CN code connector that accommodates #2 AWG Class B,C, can also accommodate a #3 Class G, H, I, K, M, DLO flexible wire when using an 81K series tool with the number of crimps identified in the table below.



Catalog Number Designation		Wire Sizes		# Crimps*	
Terminal	Splice*	Copper Code Wire	Copper Flexible Wire and DLO (if applicable)	Standard Barrel	Long Barrel
YA8C-	YS8C-	#8 AWG	#8 FLEX G,H,I,K,M,DLO	1	1
YA4C-	YS4C-	#4 AWG	#6 FLEX G,H,I,K,M,DLO #5 FLEX G,H,I,K,M,DLO	1	1
YA3C-	YS3C-	#3 AWG	#4 FLEX G,H,I,K,M,DLO	1	1
YA2C-	YS2C-	#2 AWG	#3 FLEX G,H,I,K,M,DLO	1	1
YA1C-	YS1C-	#1 AWG	#2 FLEX G,H,I,K,M,DLO	1	1
YA25-	YS25-	1/0 AWG	#1 FLEX G,H,I,K,M,DLO	1	2
YA26-	YS26-	2/0 AWG	1/0 FLEX G,H,I,K,M,DLO	1	2
YA27-	YS27-	3/0 AWG	2/0 FLEX G,H,I,K,M,DLO	1	2
YA28-	YS28-	4/0 AWG	3/0 FLEX G,H,I,K,M,DLO	1	2
YA29-	YS29-	250 kcmil	4/0 FLEX G,H	1	2
YA30-	YS30-	300 kcmil	4/0 FLEX I,K,M,DLO 250 FLEX G,H	1	2
YA31-	YS31-	350 kcmil	250 FLEX I,K,M, 262 DLO	1	2
YA32-	YS32-	400 kcmil	300 FLEX G,H,I,K,M, 313 DLO	1	2
YA34-	YS34-	500 kcmil	350 FLEX G,H,I,K,M, 373 DLO	1	2
YA36-	YS36-	600 kcmil	450 FLEX I,K,M, 444 DLO 500 FLEX G,H	2	2
YA38-	YS38-	700 kcmil	500 FLEX I,K,M, 535 DLO	2	2
			550 FLEX G,H	2	2
YA39-	YS39-	750 kcmil	600 FLEX G	2	3
			550 FLEX M	2	3
YA40-	YS40-	800 kcmil	600 FLEX H,I,K,M	2	3
			650 FLEX G, 646 DLO	2	3
YA44-	YS44-	1000 kcmil	650 FLEX I	—	3
			750 FLEX G,H, 777 DLO	2	3

*Splices: # of crimps required for each side



Code Class B/C Terminal
(YA2CN shown)



Flexible Wire Accommodates
(#3 G,H,I,K,M,DLO)



UL Listed
CSA Certified

EXPANDED RANGES



The following list of connector types can accommodate a range of conductors when crimped using the 644 and 444S family of tools:

COPPER CONNECTORS

Copper HYLUG™ & HYLINK™ Connectors Types YA, YA-L, YAB, YS, YS-L, YSR, YST, YS-T, YSP-T			
Catalog No.		Copper Wire Size	Copper Expanded Wire Range
Terminal*	Splice**		
YA4C-	YS4C-	#4 AWG	#4 AWG
YA3C-	YS3C-	#3 AWG	#3 - #4 AWG
YA2C-	YS2C-	#2 AWG	#2 - #4 AWG
YA1C-	YS1C-	#1 AWG	#1 - #4 AWG
YA25-	YS25-	1/0 AWG	1/0 - #4 AWG
YA26-	YS26-	2/0 AWG	2/0 - #4 AWG
YA27-	YS27-	3/0 AWG	3/0 - #2 AWG
YA28-	YS28-	4/0 AWG	4/0 - #1 AWG
YA29-	YS29-	250 kcmil	250 kcmil - 1/0 AWG
YA30-	YS30-	300 kcmil	300 kcmil - 2/0 AWG
YA31-	YS31-	350 kcmil	350 kcmil - 3/0 AWG
YA32-	YS32-	400 kcmil	400 kcmil - 4/0 AWG
YA34-	YS34-	500 kcmil	500 kcmil - 4/0 AWG
YA36-	YS36-	600 kcmil	600 - 250 kcmil
YA39-	YS39-	750 kcmil	750 - 500 kcmil
YA40-	YS40-	800 kcmil	800 - 500 kcmil
YA44-	YS44-	1000 kcmil	1000 - 750 kcmil

* 1 Crimp
** 1 Crimp per side

ALUMINUM CONNECTORS

Aluminum HYLUG™ & HYLINK™ Connectors Types YA-A & YS-A			
Catalog No.		Copper or Aluminum Wire Size	Copper or Aluminum Expanded Wire Range
Terminal*	Splice**		
YA6CA-	YS6CA-	#6 AWG	#6 AWG
YA4CA-	YS4CA-	#4 AWG	#4 - #6 AWG
YA2CA-	YS2CA-	#2 AWG	#2 - #6 AWG
YA1CA-	YS1CA-	#1 AWG	#1 - #2 AWG
YA25A-	YS25A-	1/0 AWG	1/0 - #1 AWG
YA26A-	YS26A-	2/0 AWG	2/0 - #1 AWG
YA27A-	YS27A-	3/0 AWG	3/0 - #1 AWG
YA28A-	YS28A-	4/0 AWG	4/0 - #1 AWG
YA29A-	YS29A-	250 kcmil	250 kcmil - 1/0 AWG
YA30A-	YS30A-	300 kcmil	300 kcmil - 2/0 AWG
YA31A-	YS31A-	350 kcmil	350 kcmil - 3/0 AWG
YA32A-	YS32A-	400 kcmil	400 kcmil - 4/0 AWG
YA34A-	YS34A-	500 kcmil	500 kcmil - 4/0 AWG
YA36A-	YS36A-	600 kcmil	600 - 250 kcmil
YA39A-	YS39A-	750 kcmil	750 - 500 kcmil
YA40A-	YS40A-	800 kcmil	800 - 500 kcmil
YA42A- †	YS42A- ‡	900 kcmil ▲	900 - 600 kcmil
YA44A-	YS44A-	1000 kcmil	1000 - 750 kcmil

* 1 Crimp
** 1 Crimp per side
▲ 900 AL only
† 2 Crimps
‡ 2 Crimps per side

AYP/AYPO ALUMINUM CONNECTORS

(Aluminum Conductor Only)				
Wire Size	Expanded Range	Pin		# Crimps
		Straight	Offset	
#6 AWG	#6 AWG	AYP6	—	1
#4 AWG	#4 AWG	AYP4	—	1
#2 AWG	#4 - #2 AWG	AYP2	—	1
#1 AWG	#2 - #1 AWG	AYP1	—	1
1/0 AWG	#1 - 1/0 AWG	AYP1/0	—	1
2/0 AWG	#1 - 2/0 AWG	AYP2/0	AYPO2/0	2
3/0 AWG	#1 - 3/0 AWG	AYP3/0	AYPO3/0	2
4/0 AWG	#1 - 4/0 AWG	AYP4/0	AYPO4/0	2
250 kcmil	1/0 - 250 kcmil	AYP250	AYPO250	2
300 kcmil	2/0 - 300 kcmil	AYP300	AYPO300	2
350 kcmil	3/0 - 350 kcmil	AYP350	AYPO350	2
400 kcmil	4/0 - 400 kcmil	AYP400	AYPO400	2
500 kcmil	4/0 - 500 kcmil	AYP500	AYPO500	2
600 kcmil	250 - 600 kcmil	AYP600	AYPO600	3
750 kcmil	500 - 750 kcmil	AYP750	AYPO750	3



EXPANDED RANGES

The following list of connector types can accommodate a range of conductors when crimped using the 4-POINT® (81K or 4PC) family of tools:



COPPER CONNECTORS

Copper Conductor (Class B&C)**							
Copper Conductor		Standard Barrel			Long Barrel		
Wire Size	Expanded Range	Terminal	Splice	# of Crimps*	Terminal	Splice	# of Crimps*
#8 AWG	#8 AWG	YA8CL-	YS8CL-	1	YA8C-	YS8C-	1
#6 AWG	#6 AWG	YA6CL-	YS6CL-	1	YA6C-	YS6C-	1
#4 AWG	#6 - #4	YA4CL-	YS4CL-	1	YA4C-	YS4C-	1
#2 AWG	#6-#2	YA2CL-	YS2CL-	1	YA2C-	YS2C-	2
#1 AWG	#6-#1	YA1CL-	YS1CL-	1	YA1C-	YS1C-	2
1/0 AWG	#6-1/0	YA25L-	YS25L-	1	YA25-	YS25-	2
2/0 AWG	#4 - 2/0	YA26L-	YS26L-	1	YA26-	YS26-	2
3/0 AWG	#2 - 3/0	YA27L-	YS27L-	2	YA27-	YS27-	2
4/0 AWG	#1 - 4/0	YA28L-	YS28L-	2	YA28-	YS28-	2
250 kcmil	1/0 - 250	YA29L-	YS29L-	2	YA29-	YS29-	2
300 kcmil	2/0 - 300	YA30L-	YS30L-	2	YA30-	YS30-	3
350 kcmil	3/0 - 350	YA31L-	YS31L-	2	YA31-	YS31-	3
400 kcmil	4/0 - 400	YA32L-	YS32L-	2	YA32-	YS32-	3
500 kcmil	4/0 - 500	YA34L-	YS34L-	2	YA34-	YS34-	4
600 kcmil	250 - 600	YA36L-	YS36L-	2	YA36-	YS36-	4
700 kcmil	350-700	YA38L-	YS38L-	3	YA38-	YS38-	4
750 kcmil	500-750	YA39L-	YS39L-	3	YA39-	YS39-	4
800 kcmil	500-800	YA40L-	YS40L-	3	YA40-	YS40-	4
1000 kcmil	750-1000	YA44L-	YS44L-	3	YA44-	YS44-	4

ALUMINUM CONNECTORS

Aluminum & Copper Conductor (Class B & C)**				
Copper / Aluminum Conductor		Connector		
Wire Size	Expanded Range	Terminal	Splice	# Crimps
#8 AWG	#8 AWG	YA8CA-	YS8CA-	1
#6 AWG	#6 AWG	YA6CA-	YS6CA-	1
#4 AWG	#6 - #4 AWG	YA4CA-	YS4CA-	1
#2 AWG	#6-#2 AWG	YA2CA-	YS2CA-	2
#1 AWG	#6-#1 AWG	YA1CA-	YS1CA-	2
1/0 AWG	#6-1/0 AWG	YA25A-	YS25A-	2
2/0 AWG	#4 - 2/0 AWG	YA26A-	YS26A-	2
3/0 AWG	#2 - 3/0 AWG	YA27A-	YS27A-	2
4/0 AWG	#1 - 4/0 AWG	YA28A-	YS28A-	2
250 kcmil	1/0 - 250	YA29A-	YS29A-	2
300 kcmil	2/0 - 300	YA30A-	YS30A-	2
350 kcmil	3/0 - 350	YA31A-	YS31A-	3
400 kcmil	4/0 - 400	YA32A-	YS32A-	4
500 kcmil	4/0 - 500	YA34A-	YS34A-	4
600 kcmil	250 - 600	YA36A-	YS36A-	4
750 kcmil	500-750	YA39A-	YS39A-	4



PAT81KFTLI



PAT4PC834LI

* Same number of recommended crimps for both Standard and Expanded wire ranges

** Class B - Concentric, Compressed, or Compact



The following list of connector types can accommodate a range of conductors when crimped using the 4-POINT® (81K or 4PC) family of tools:



EXPANDED RANGES

COPPER CONNECTORS

Nom Flex Wire Size	Copper Conductor (Flex Only)							
	Standard Barrel				Long Barrel			
	Expanded Range	Terminal	Splice	# of Crimps	Expanded Range	Terminal	Splice	# of Crimps
#8 AWG	#8 AWG	YAV8CL-	YSV8CL-	1	#8 AWG	YAV8C-	YSV8C-	1
#6 AWG	#6 AWG	YAV6CL-	YSV6CL-	1	#6 AWG	YAV6C-	YSV6C-	1
#4 AWG	#6 - #4 AWG	YAV4CL-	YSV4CL-	1	#6 - #4 AWG	YAV4C-	YSV4C-	1
#2 AWG	#6 - #2 AWG	YAV2CL-	YSV2CL-	1	#6 - #2 AWG	YAV2C-	YSV2C-	1
#1 AWG	#4 - #1 AWG	YAV1CL-	YSV1CL-	1	#4 - #1 AWG	YAV1C-	YSV1C-	1
1/0 AWG	#4 - 1/0 AWG	YAV25L-	YSV25L-	1	#4 - 1/0 AWG	YAV25-	YSV25-	2
2/0 AWG	#2 - 2/0 AWG	YAV26L-	YSV26L-	1	#4 - 2/0 AWG	YAV26-	YSV26-	2
3/0 AWG	#1 - 3/0 AWG	YAV27L-	YSV27L-	1	#2 - 3/0 AWG	YAV27-	YSV27-	2
4/0 AWG	1/0 - 4/0 AWG	YAV28L-	YSV28L-	1	#1 - 4/0 AWG	YAV28-	YSV28-	2
250 kcmil	3/0 AWG - 250 kcmil	YAV29L-	YS29L-	1	1/0 AWG - 250 kcmil	YAV29-	YS29-	2
300 kcmil	4/0 AWG - 313.1 kcmil	YA32L-	YS32L-	1	2/0 AWG - 313.1 kcmil	YA32-	YS32-	2
350 kcmil	262.2 - 373.7 kcmil	YA34L-	YS34L-	1	3/0 AWG - 373.7 kcmil	YA34-	YS34-	2
450 kcmil	373.7 - 444.4 kcmil	YA36L-	YS36L-	1	262.2 - 444.4 kcmil	YA36-	YS36-	2
450 kcmil	262.2 - 444.4 kcmil	YA36L-	YS36L-	2				
500 kcmil	444.4 - 535.3 kcmil	YA38L-	YS38L-	1	373.7 - 535.3 kcmil	YA38-	YS38-	2
500 kcmil	373.7 - 535.3 kcmil	YA38L-	YS38L-	2				
600 kcmil	373.7 - 600 kcmil	YA39L-	YS39L-	2	262.2 - 600 kcmil	YA39-	YS39-	3
650 kcmil	444.4 - 646 kcmil	YA40L-	YS40L-	2	444.4 - 646 kcmil	YA40-	YS40-	3
750 kcmil	750.0 - 777.7 kcmil	YA44L-	YS44L-	2	646.0 - 777.7 kcmil	YA44-	YS44-	3



PAT81KFTLI



PAT4PC834LI

TYPES YA-L, YA-L-TC

HYLUG™

Uninsulated Copper Compression Terminal
UL Listed 90° C, Up to 35 kV ♦

45° and 90° angles available. Please contact Customer Service to order:
1-800-346-4175

Features & Benefits

- Inspection window allows for visual verification that the wire has been fully inserted prior to crimping the lug; not recommended in highly corrosive environments as the wire in the barrel is exposed to corrosive elements when installed
- Barrel is designed with an internal chamfer at the wire entry to ensure smooth insertion of the wire, preventing possible damaging of the strands
- Short/Standard length barrel is recommended for installations with limited space requirements
- 45° and 90° angular lugs are available; please contact Customer Service
- Electro-tin plated unless otherwise specified to reduce galvanic corrosion (bimetallic) and resist corrosive elements
- Connectors are clearly marked with stamping and barrel color coding
- BURNDY certifies its products using the BURNDY Engineered System and select other crimp tool manufacturers in accordance with one or more of the UL categories in order to obtain a UL Listing
- Terminals and splices accommodating code wire: Accommodates Code Class B (Concentric, Compressed, Compact) and Class C wire

Accessories

- Hardware - Section F
- PENETROX™ Oxide Inhibitor - Section F
- Heat and Cold Shrink Tubing - Section D
- WIREMIKE™ Wire Micrometer - Section F
- Wire Management (Cable Ties) - Section G



NOTE: Field bending straight lugs to achieve an angular connection will void UL Listing / CSA Certifications and BURNDY will not be liable for the connection.

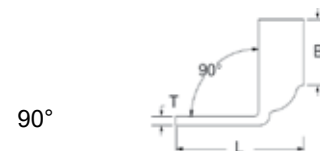
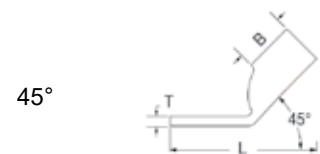

Compression Connections

Copper Compression — Code — One Hole
Standard Barrel

TYPES YA-L, YA-L-TC (Continued)

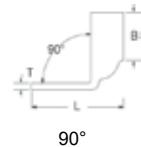
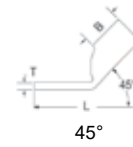
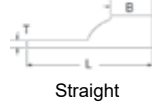

NOTE: Field bending straight lugs to achieve an angular connection will void UL Listing / CSA Certifications and BURNDY will not be liable for the connection.

Catalog Number	Conductor		Stud Hole Size	Tongue Width	Figure Dimensions			Installation Tooling					Wire Strip Length	
	AWG	MM ² ***			(B)	(T)	(L)	Dieless (# of crimps)	MD6, OUR840, MD734R	500 Series	35, 750, 46* Series	Color Code		Die Index
YAV10BOX	#14-#10 Str #12-#10 Sol	3.31 - 5.26 6	#8-#10	0.38	0.40	0.06	0.97	Non-Ratchet: Y10D, Y1022 Ratchet: MR8G98, MR89Q, Y8MRB1, MR20, N10HT, N10HT24, Y122CMR	—	—	—	—	—	7/16"
YAV10RBOX (90°)			#8-#10	0.38	0.38	0.06	0.53							3/8"
YAV10T2BOX			5/16	0.53	0.39	0.04	1.13							7/16"
YAV10R3BOX (90°)			1/4	0.47	0.38	0.04	0.55							5/16"
YAV10T3BOX			1/4	0.45	0.41	0.05	1.10							7/16"
YAV10T4BOX			3/8	0.55	0.45	0.04	1.17							
YA8CLBOX	#8 AWG #8 Flex G,H,I,K,M DLO	8.37 † 10	#8-#10	0.41	0.44	0.08	1.16	Y122CMR (1) Y1MRTC (1) MRC840 (1) Y8MRB1 (1) MY29 Series (1) 4PC Series (1) 81K Series (1)	W8CVT (1) W8CRT (1) X8CRT (1)	W8CVT (1) W8CRT (1) X8CRT (1)	U8CRT (1)	Red	49	7/16"
YA8CL1BOX			1/4	0.44	0.44	0.08	1.26							
YA8CL2BOX			5/16	0.52	0.44	0.06	1.38							
YA8CL3BOX			3/8	0.58	0.44	0.06	1.51							
YA8CL4BOX			1/2	0.71	0.44	0.05	1.76							
YA6CL1BOX	#6 AWG Str. Sol.	13.3	#8-#10	0.41	0.54	0.09	1.27	Y122CMR (1) Y1MRTC (1) MRC840 (1) MY29 Series (1) 81K Series (1)	W5CVT (1) W5CRT (1) X5CRT (1) X8CART (1)	W5CVT (1) W5CRT (1) X5CRT (1) X8CART (1)	U5CRT (1)	Blue	7 or 374	9/16"
YA6CLBOX			1/4	0.45	0.54	0.08	1.45							
YA6CL3BOX			5/16	0.52	0.54	0.07	1.52							
YA6CL4BOX			3/8	0.63	0.54	0.06	1.62							
YA6CL6			1/2	0.75	0.54	0.12	1.87							
YA5CL	#5 AWG	—	1/4	0.44	0.81	0.07	1.65	W5CRT (1) W5CVT (1) X5CRT (1)	W5CRT (1) X5CRT (1) W5CVT (1)					
YA4CL1BOX	#4 AWG	21.2	#8-#10	0.50	0.81	0.09	1.58	Y122CMR (2) Y1MRTC (2) MRC840 (1) MY29 Series (1) 81K Series (1) 644 Series (1) 444 Series (1)	W4CVT (1) W4CRT (1) X4CRT (1)	W4CVT (1) W4CRT (1) X4CRT (1)	U4CRT (1) U6CABT (1)	Gray	8	7/8"
YA4CLBOX			1/4	0.50	0.81	0.09	1.74							
YA4CL3BOX			5/16	0.50	0.81	0.08	1.79							
YA4CL4BOX			3/8	0.58	0.81	0.09	1.92							
YA4CL6BOX			1/2	0.71	0.81	0.06	2.20							
YA3CL	#3 Str #2 Sol	26.7 25	5/16	0.55	0.88	0.09	1.88	W3CRT (1)	W3CRT (1)	U3CRT (1)	White	9	15/16"	

* Use PUADP1 adapter with U dies in 46 Series

** P-RT die sets for use in Y46 HYPRESS™ only, PUADP1 adapter not required

*** The MM² conductor sizes listed are the recommendations for Class 2 conductor

† The MM² conductor size listed is for both Class 2 and Class 5 conductor

▲ See tooling section of this catalog for complete tool and die listings

◆ For applications greater than 2000 Volts consult cable manufacturer for voltage stress relief instructions

Note: All dimensions shown are for reference only.

YAV10 Series feature rounded tongues and are not ink stamped

TYPES YA-L, YA-L-TC (Continued)

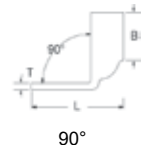
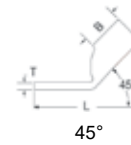
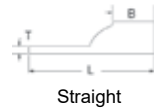

NOTE: Field bending straight lugs to achieve an angular connection will void UL Listing / CSA Certifications and BURNDY will not be liable for the connection.

Catalog Number	Conductor		Stud Hole Size	Tongue Width	Figure Dimensions			Installation Tooling						Wire Strip Length	
	AWG	MM ² ***			(B)	(T)	(L)	Dieless (# of crimps)	MD6, OUR840, MD734R	500 Series	35, 750, 46* Series	Color Code	Die Index		
YA2CL2BOX	#2 AWG	33.6 35	1/4	0.61	0.88	0.11	1.88	Y122CMR (2)** Y1MRTC (2) MY29 Series (1) MRC840 (1) 644 Series (1) 444 Series (1) 81K Series (1)	W2CVT (1) W2CRT (1) X2CRT (1)	W2CVT (1) W2CRT (1) X2CRT (1)	U2CRT (1)	Brown	10	15/16	
YA2CLBOX			5/16	0.61	0.88	0.11	1.93								
YA2CL4BOX			3/8	0.61	0.88	0.11	2.06								
YA2CL6BOX			1/2	0.73	0.88	0.09	2.32								
YA1CL2	#1 AWG	42.4 50	1/4	0.68	0.88	0.10	1.81		W1CVT(1) W1CRT1 (1) X1CRT1 (1)	W1CVT(1) W1CRT1 (1) X1CRT1 (1)	U1CRT1 (1) U4CABT (1)	Green	11 or 375	15/16	
YA1CLBOX			5/16	0.68	0.88	0.10	1.94								
YA1CL4BOX			3/8	0.68	0.88	0.10	2.06								
YA1CL6BOX			1/2	0.73	0.88	0.09	2.37								
YA25L2BOX	1/0 AWG	53.5	1/4	0.75	0.88	0.12	1.84		MY29 Series (1) MRC840 (2) 644 Series (1) 444 Series (1) 81K Series (2)	W25VT (2) W25RT (2) X25RT (2)	W25VT (2) W25RT (2) X25RT (2)	U25RT (1) U2CABT (1)	Pink	12	15/16
YA25LBOX			5/16	0.75	0.88	0.12	1.96								
YA25L4BOX			3/8	0.75	0.88	0.12	2.09								
YA25L6			1/2	0.75	0.88	0.12	2.34								
YA26L2BOX	2/0 AWG	67.4 70	1/4	0.83	0.94	0.12	1.94	W26VT (2) W26RT (2) X26RT (2)		W26VT (2) W26RT (2) X26RT (2)	U26RT (1)	Black	13	1	
YA26L3			5/16	0.83	0.94	0.12	2.06								
YA26LBOX			3/8	0.83	0.94	0.12	2.19								
YA26L6BOX			1/2	0.83	0.94	0.12	2.44								
YA26L60	3/4	1.02	0.94	0.10	2.96										
YA27L3	3/0 AWG	85	5/16	0.91	1.00	0.13	2.16	MY29 Series (1) MRC840 (2) 644 Series (1) 444 Series (1) 81K Series (2)		W27VT (2) W27RT (2) X27RT (3)	W27VT (2) W27RT (2) X27RT (3)	U27RT (1)	Orange	14	1-1/16
YA27L4BOX			3/8	0.91	1.00	0.13	2.29								
YA27LBOX			1/2	0.91	1.00	0.13	2.54								
YA28L2	4/0 AWG	107	1/4	1.02	0.88	0.14	1.96	MY29 Series (1) MRC840 (2) 644 Series (1) 444 Series (1) 81K Series (2)	W28VT (2) W28RT (2) X28RT (3)	W28VT (2) W28RT (2) X28RT (3)	U28RT (1)	Purple	15	1-1/8	
YA28L3			5/16	1.02	0.88	0.14	2.08								
YA28L4BOX			3/8	1.02	0.88	0.14	2.21								
YA28LBOX			1/2	1.02	0.88	0.14	2.46								
YA28L56	3/4	1.05	0.88	0.13	2.90										
YA29L2	250 kcmil	127	1/4	1.11	1.06	0.16	2.17	MY29 Series (1) 644 Series (1) 444 Series (1) 81K Series (2)	W29VT (2) X29RT (4)	W29VT (2) W29RT (2) X29RT (4)	U29RT (1)	Yellow	16	1-1/8	
YA29L4			3/8	1.11	1.06	0.16	2.42								
YA29L7			5/16	1.11	1.06	0.16	2.30								
YA29LBOX			1/2	1.11	1.06	0.16	2.67								
YA29LTC78			7/8	1.11	1.06	0.14	3.36								

* Use PUADP1 adapter with U dies in 46 Series
 ** Y122CMR tool #10-#2 AWG Wire only
 *** The MM² conductor sizes listed are the recommendations for Class 2 conductor

▲ See tooling section of this catalog for complete tool and die listings.

◆ For applications greater than 2000 Volts consult cable manufacturer for voltage stress relief instructions.
Note: All dimensions shown are for reference only.

Compression Connections

Copper Compression — Code — One Hole
Standard Barrel

TYPES YA-L, YA-L-TC (Continued)

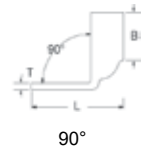
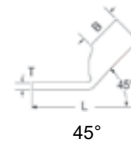
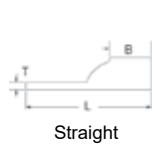

NOTE: Field bending straight lugs to achieve an angular connection will void UL Listing / CSA Certifications and BURNDY will not be liable for the connection.

Catalog Number	Conductor		Stud Hole Size	Tongue Width	Figure Dimensions			Installation Tooling					Wire Strip Length	
	AWG	MM ² ***			(B)	(T)	(L)	Dieless (# of crimps)	MD6, OUR840, MD734R	500 Series	35, 750, 46* Series	Color Code		Die Index
YA30L1	300 kcmil	152 150	5/16	1.20	1.03	0.16	2.31	644 Series (1) 444 Series (1) 81K Series (2)	W30VT (2)	W30VT (2) W30RT (2)	U30RT (2) U28ART (2)	White	17	1-1/16
YA30L24			3/8	1.20	1.03	0.16	2.44							
YA30L			1/2	1.20	1.03	0.16	2.69							
YA30LN			1/2	1.20	1.03	0.16	2.87							
YA30L7			5/8	1.20	1.03	0.16	2.94							
YA30L28			3/4	1.20	1.03	0.16	3.12							
YA30L27			7/8	1.20	1.03	0.16	3.37							
YA31L11			350 kcmil	177 185	3/8	1.29	1.06							0.18
YA31L	1/2	1.29			1.06	0.18	2.75							
YA31L7	5/8	1.29			1.06	0.18	3.00							
YA31L36	7/8	1.29			1.06	0.18	4.02							
YA32L14	400 kcmil	203	3/8	1.40	1.19	0.19	2.68	644 Series (1) 444 Series (1) 81K Series (2)	W32VT (2)	W32VT (2) W32RT (2)	U32RT (2) U30ART (2)	Blue	19	1-1/4
YA32LN			1/2	1.40	1.19	0.19	3.12							
YA32L1			1/2	1.40	1.19	0.19	2.93							
YA32L			5/8	1.40	1.19	0.19	3.18							
YA32LTC78	7/8	1.40	1.19	0.19	3.62									
YA33L	450 kcmil	—	5/8	1.48	1.50	0.21	3.57	644 Series (1) 444 Series (1) 81K Series (2)	W33VT (2)	W33VT (2) W33RT (2)	U33RT (2)	Gray	326	1-9/16
YA34L37	500 kcmil	253 240	3/8	1.55	1.27	0.23	2.87	644 Series (1) 444 Series (1) 81K Series (2)	W34VT (2)	W34VT (2) W34RT (2)	U34RT (2) U31ART (1)	Brown	20	1-7/16
YA34L6			1/2	1.55	1.27	0.23	3.12							
YA34L			5/8	1.55	1.27	0.23	3.37							
YA34L8			3/4	1.55	1.27	0.23	3.55							
YA34L9			7/8	1.55	1.27	0.23	3.80							
YA34L20			1	1.55	1.27	0.23	4.05							
YA36L11	600 kcmil	304 300	1/2	1.74	1.38	0.27	3.29	644 Series (1) 444 Series (1) 81K Series (2)	—	—	U36RT (2)	Green	22 or 472	1-3/4
YA36L			5/8	1.74	1.38	0.27	3.54							
YA36LTC78			7/8	1.74	1.38	0.27	3.97							

* Use PUADP1 adapter with U dies in 46 Series

** P-RT die sets for use in 46 Series only, PUADP1 adapter not required

*** The MM² conductor sizes listed are the recommendations for Class 2 conductor

▲ See tooling section of this catalog for complete tool and die listings.

◆ For applications greater than 2000 Volts consult cable manufacturer for voltage stress relief instructions.

Note: All dimensions shown are for reference only.

TYPES YA-L, YA-L-TC (Continued)

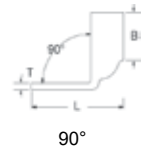
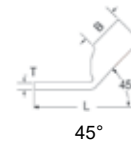
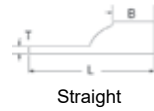

NOTE: Field bending straight lugs to achieve an angular connection will void UL Listing / CSA Certifications and BURNDY will not be liable for the connection.

Catalog Number	Conductor		Stud Hole Size	Tongue Width	Figure Dimensions			Installation Tooling					Wire Strip Length	
	AWG	MM ² ***			(B)	(T)	(L)	Dieless (# of crimps)	MD6, OUR840, MD734R	500 Series	35, 750, 46* Series	Color Code		Die Index
YA37L	650 kcmil	—	5/8	1.80	1.39	0.27	3.57	—	—	U37RT (2)	Orange	23	1-15/16	
YA37L1			3/4	1.80	1.39	0.27	3.76							
YA38L	700 kcmil	355	5/8	1.84	1.45	0.27	3.66	644 Series (1) 444 Series (1) 81K Series (3)	—	—	U38RT (2)	Pink	400	1-15/16
YA39L6	750 kcmil	380	1/2	1.91	1.42	0.27	3.41							
YA39L			5/8	1.91	1.42	0.27	3.57							
YA39L2			7/8	1.91	1.42	0.27	4.10							
YA39L9			1-1/4	1.91	1.42	0.27	4.85							
YA40L	800 kcmil	405 400	5/8	1.98	1.42	0.30	3.81	644 Series (1) 444 Series (1) 81K Series (3)	—	—	P40RT (3)**	Orange	25	1-15/16
YA41L	850 kcmil	—	5/8	2.01	1.88	0.31	4.15							
YA44L2	1000 kcmil	507 500	1/2	2.19	1.65	0.33	3.98							
YA44L			5/8	2.19	1.65	0.33	4.04							
YA44L23			1	2.19	1.65	0.33	4.73							
YA45L	1250 kcmil	633	3/4	2.46	2.00	0.38	4.68	—	—	—	P45RT (3)**	Yellow	29	2-1/16
YA453LBOX	1300 kcmil	—	3/4	2.53	2.00	0.39	4.71	—	—	—	-	Orange	30	2-1/16
YA46L	1500 kcmil	760	3/4	2.69	2.00	0.40	4.78	—	—	—	P46RT (3)**	Green	31	2-1/16
YA48L	2000 kcmil	1010 1000	3/4	3.10	2.25	0.46	5.19	—	—	—	-	Brown	34	2-3/8

* Use PUADP1 adapter with U dies in 46 Series

** P-RT die sets for use in 46 Series only, PUADP1 adapter not required

*** The MM² conductor sizes listed are the recommendations for Class 2 conductor

▲ See tooling section of this catalog for complete tool and die listings.

◆ For applications greater than 2000 Volts consult cable manufacturer for voltage stress relief instructions.

Note: All dimensions shown are for reference only.

TYPE YA-L-NT

HYLUG™

Uninsulated Copper Compression Narrow Tongue Terminal
UL Listed 90° C, Up to 35 kV ♦

45° and 90° angles available. Please contact Customer Service to order:
1-800-346-4175

Features & Benefits

- Inspection window allows for visual verification that the wire has been fully inserted prior to crimping the lug; not recommended in highly corrosive environments as the wire in the barrel is exposed to corrosive elements when installed
- Narrow tongue/tang is designed for limited space applications
- Barrel is designed with an internal chamfer at the wire entry to ensure smooth insertion of the wire, preventing possible damaging of the strands
- Short/Standard length barrel is recommended for installations with limited space requirements
- 45° and 90° angular lugs are available; please contact Customer Service
- Electro-tin plated unless otherwise specified to reduce galvanic corrosion (bimetallic) and resist corrosive elements
- Connectors are clearly marked with stamping and barrel color coding
- BURNDY certifies its products using the BURNDY Engineered System and select other crimp tool manufacturers in accordance with one or more of the UL categories in order to obtain a UL Listing
- Terminals and splices accommodating code wire: Accommodates Code Class B (Concentric, Compressed, Compact) and Class C wire

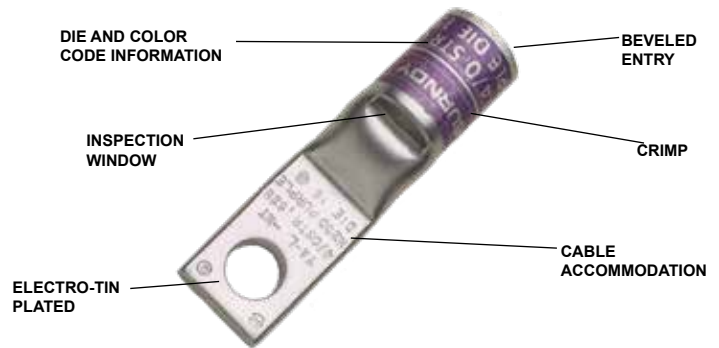

NOTE: Field bending straight lugs to achieve an angular connection will void UL Listing / CSA Certifications and BURNDY will not be liable for the connection.

Straight



45°

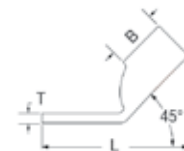

90°

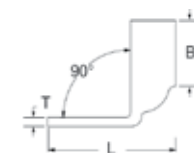

Accessories

- Hardware - Section F
- PENETROX™ Oxide Inhibitor - Section F
- Heat and Cold Shrink Tubing - Section D
- WIREMIKE™ Wire Micrometer - Section F
- Wire Management (Cable Ties) - Section G

TYPE YA-L,-NT (Continued)

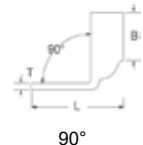
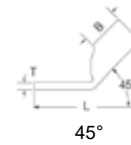
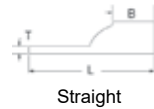

NOTE: Field bending straight lugs to achieve an angular connection will void UL Listing / CSA Certifications and BURNDY will not be liable for the connection.

Catalog Number	Conductor		Stud Hole Size	Tongue Width	Figure Dimensions			Installation Tooling (# of crimps)					Wire Strip Length	
	AWG	MM ² ***			(B)	(T)	(L)	Dieless	MD6, OUR840, MD734R	500 Series	35, 750 46° Series	Color Code		Die Index
YA8CLNT6	#8 AWG #8 Flex G,H,I,K,M DLO	8.37 10	#6	0.29	0.44	0.09	1.08	Y1MRTC (1) Y122CMR (1) MY29 Series (1) 81K Series (1)	W8CVT (1)	X8CRT (1)	U8CRT (1)	Red	49	1/2
YA8CLNT8			#8	0.33	0.44	0.09	1.18							
YA6CLNT6	#6 AWG Sol./Str.	13.3	#6	0.29	0.54	0.09	1.17	Y1MRTC (1) Y122CMR (1) MY29 Series (1) MRC840 (1) 81K Series (1)	W5CVT (1)	X5CRT (1)	U5CRT (1)	Blue	7	7/8
YA4CLNT10	#4 AWG	21.2	#10	0.40	0.81	0.09	1.73		W4CVT (1)	X4CRT (1)	U4CRT (1)	Gray	8	7/8
YA3CLNT14	#3 AWG #2 Sol.	26.7 25	1/4	0.41	0.88	0.08	1.82		W3CVT (1)	W3CVT (1)	U3CRT (1)	White	9	15/16
YA3CLNT516			5/16	0.49	0.88	0.08	1.80		W2CVT (1)	X2CRT (1)	U2CRT (1)	Brown	10	15/16
YA2CLNT10	#10	0.48	0.88	0.11	1.80									
YA2CLNT14	#2 AWG	33.6 35	1/4	0.48	0.88	0.11	1.80							
YA2CLNT516			5/16	0.49	0.88	0.11	1.82							
YA1CLNT10	#1 AWG	42.4 50	#10	0.50	0.88	0.10	2.23		MY29 Series (1) 81K Series (1)	W1CVT (1)	X1CRT (1)	U1CRT (1)	Green	11
YA1CLNT14			1/4	0.50	0.88	0.10	2.23							
YA25LNT10	1/0 AWG	53.5	#10	0.62	0.88	0.12	2.28	MY29 Series (1) MRC840 (1) 644 Series (1) 444 Series (1) 81K Series (1)	W25VT (2)	X25RT (2)	U25RT (1)	Pink	12	15/16
YA25LNT14			1/4	0.48	0.88	0.12	1.93							
YA25LNT516			5/16	0.62	0.88	0.12	2.28							
YA25LNT38			3/8	0.62	0.88	0.12	2.18							
YA26LNT10	2/0 AWG	67.4 70	#10	0.62	0.94	0.13	2.62		W26VT (2)	X26RT (1)	U26RT (1)	Black	13	1
YA26LNT14			1/4	0.48	0.94	0.12	2.02							
YA26LNT516			5/16	0.62	0.94	0.13	2.62							
YA26LNT38			3/8	0.72	0.94	0.12	2.48							
YA27LNT14	3/0 AWG	85	1/4	0.76	1.00	0.13	2.10	MY29 Series (1) MRC840 (2) 644 Series (1) 444 Series (1) 81K Series (2)	W27VT (2)	X27RT (3)	U27RT (1)	Orange	14	1-1/16
YA27LNT516			5/16	0.60	1.00	0.12	2.17							
YA27LNT38			3/8	0.76	1.00	0.12	2.73							
YA28LNT14	4/0 AWG	107	1/4	0.76	0.88	0.14	2.60	W28VT (2)	X28RT (3)	U28RT (1)	Purple	15	1-1/8	
YA28LNT516			5/16	0.70	0.88	0.14	2.09							
YA28LNT38			3/8	0.76	0.88	0.14	2.67							W28VT (2) W28RT (2) X28RT (3)

* Use PUADP1 adapter with U dies in 46 Series
 ** The MM² conductor size listed is for Class 2 and Class 5 conductor
 *** The MM² conductor sizes listed are the recommendations for Class 2 conductor

▲ See tooling section of this catalog for complete tool and die listings. Use ONLY color-coded die recommendations for FX connectors. For nest/indenter system contact factory

◆ For applications greater than 2000 Volts consult cable manufacturer for voltage stress relief instructions
Note: All dimensions shown are for reference only.

Compression Connections

Copper Compression — Code — One Hole
Narrow Tongue, Standard Barrel

TYPE YA-L-NT (Continued)

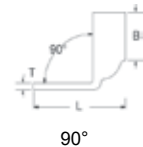
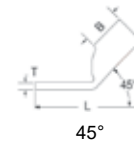
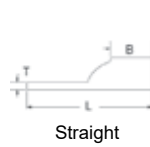

NOTE: Field bending straight lugs to achieve an angular connection will void UL Listing / CSA Certifications and BURNDY will not be liable for the connection.

Catalog Number	Conductor		Stud Hole Size	Tongue Width	Figure Dimensions			Dieless	Installation Tooling (# of crimps)					Wire Strip Length	
	AWG	MM ² ***			(B)	(T)	(L)		Mech. MD6, OUR840, MD734R	Hydraulic		Color Code	Die Index		
								500 Series	35, 750, 46° Series						
YA29LENT516	250 kcmil	127	5/16	0.76	1.06	0.16	2.49	MY29 Series (1) MRC840 (2) 644 Series (1) 444 Series (1) 81K Series (2)	W29VT (2)	X29RT (4)	U29RT (1)	Yellow	16	1-1/8	
YA29LENT38			3/8	0.76	1.06	0.16	2.96								
YA29LNT38			3/8	0.96	1.06	0.16	2.96								
YA30LNT14	300 kcmil	152	1/4	0.83	1.03	0.16	2.26	644 Series (1) 444 Series (1) 81K Series (2)	W30VT (2)	—	U30RT (2)	White	17	1-1/8	
YA30LNT38		150	3/8	0.96	1.03	0.16	2.97								
YA31LNT38	350 kcmil	177	3/8	0.96	1.06	0.18	3.31		W31VT (2)	—	U31RT (2)	Red	18	1-1/8	
YA31LNT12		185	1/2	0.88	1.06	0.18	2.75								
YA32LNT38	400 kcmil	203	3/8	0.96	1.19	0.20	3.21		W32VT (2)	—	U32RT (2)	Blue	19	1-1/4	
YA32LNT12			1/2	0.96	1.19	0.19	3.21								
YA34LNT38	500 kcmil	253	3/8	0.96	1.27	0.23	3.65		W34VT (2)	—	U34RT (2)	Brown	20	1-7/16	
YA34LNT12		240	1/2	0.96	1.27	0.23	3.65								
YA36LNT38	600 kcmil	304	3/8	1.12	1.38	0.27	4.09		—	—	U36RT (2)	Green	22	1-3/4	
YA36LNT12		300	1/2	1.00	1.38	0.27	3.29								
YA39LNT38	750 kcmil	355	3/8	1.12	1.42	0.27	4.24		81K Series (3)	—	—	U39RT (2)	Black	24	1-15/16
YA39LNT12			1/2	1.12	1.42	0.27	4.24								
YA39LNT58			5/8	1.30	1.42	0.27	3.67								

* Use PUADP1 adapter with U dies in 46 Series

** The MM² conductor size listed is for Class 2 and Class 5 conductor

*** The MM² conductor sizes listed are the recommendations for Class 2 conductor

▲ See tooling section of this catalog for complete tool and die listings. Use ONLY color-coded die recommendations for FX connectors. For nest/indentor system contact factory

◆ For applications greater than 2000 Volts consult cable manufacturer for voltage stress relief instructions

Note: All dimensions shown are for reference only.

TYPES YA, YA-TC

HYLUG™

Uninsulated Copper Compression Terminal
UL Listed 90° C, Up to 35 kV ◆

45° and 90° angles available. Please contact Customer Service to order:
1-800-346-4175

Features & Benefits

- No inspection window is ideal for more corrosive environments as the barrel transition is not open
- Barrel is designed with an internal chamfer at the wire entry to ensure smooth insertion of the wire, preventing possible damaging of the strands
- Long barrel allows for an increased number of crimps which will increase the mechanical strength of the connection
- 45° and 90° angular lugs are available; please contact Customer Service
- Electro-tin plated unless otherwise specified to reduce galvanic corrosion (bimetallic) and resist corrosive elements
- Connectors are clearly marked with stamping and barrel color coding
- BURNDY certifies its products using the BURNDY Engineered System and select other crimp tool manufacturers in accordance with one or more of the UL categories in order to obtain a UL Listing
- Terminals and splices accommodating code wire: Accommodates Code Class B (Concentric, Compressed, Compact) and Class C wire

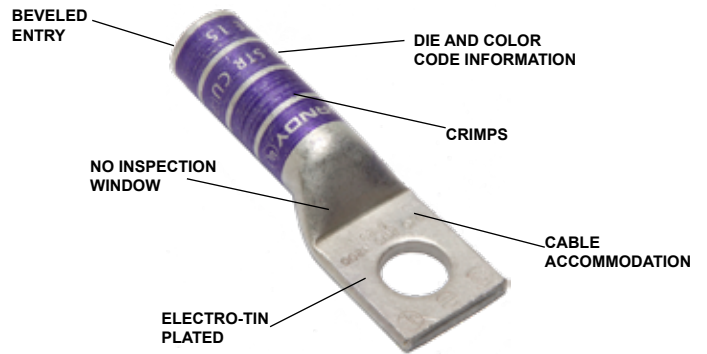

NOTE: Field bending straight lugs to achieve an angular connection will void UL Listing / CSA Certifications and BURNDY will not be liable for the connection.

Accessories

- Hardware - Section F
- PENETROX™ Oxide Inhibitor - Section F
- Heat and Cold Shrink Tubing - Section D
- WIREMIKE™ Wire Micrometer - Section F
- Wire Management (Cable Ties) - Section G

Straight



45°



90°

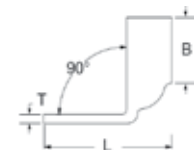

Compression Connections

Copper Compression — Code — One Hole
Long Barrel — No Inspection Window

TYPES YA, YA-TC (Continued)

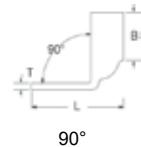
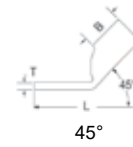
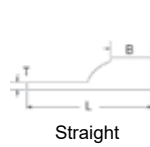

NOTE: Field bending straight lugs to achieve an angular connection will void UL Listing / CSA Certifications and BURNDY will not be liable for the connection.

Catalog Number	Conductor		Stud Hole Size	Tongue Width	Figure Dimensions			Installation Tooling						Wire Strip Length
	AWG	MM ² ***			(B)	(T)	(L)	Dieless (# of crimps)	MD6, OUR840, MD734R	500 Series	35, 750 46** Series	Color Code	Die Index	
YA8CTC10	#8 AWG #8 Flex G,H,I,K,M DLO	8.37 ↑ 10	#10	0.41	0.81	0.08	1.57	Y122CMR (2) MRC840 (2) MY29 Series (2) Y8MBR1 (1) Y1MRTC (2) 81K Series (1)	W8CVT (2) W8CRT (2) X8CRT (2)	X8CRT (2) W8CVT (2) W8CRT (2)	U8CRT (2)	Red	49	7/8
YA8CTC14			1/4	0.44	0.81	0.08	1.69							
YA8CTC38			3/8	0.58	0.81	0.06	1.88							
YA6CTC8	#6 AWG Sol./Str.	13.3	#8	0.42	1.12	0.09	1.83	Y122CMR (2) MRC840 (2) MY29 Series (2) Y1MRTC (2) 81K Series (1)	W5CVT (2) W5CRT (2) X5CRT (2) X8CART (2)	W5CVT (2) W5CRT (2) X5CRT (2) X8CART (2)	U5CRT (2) U8CABT (2)	Blue	7 or 374	1-3/16
YA6CTC10			#10	0.42	1.12	0.09	1.89							
YA6C			1/4	0.41	1.12	0.09	1.81							
YA6CN			1/2	0.83	1.12	0.12	2.64							
YA6CTC516			5/16	0.52	1.12	0.07	2.08							
YA6CTC38			3/8	0.58	1.12	0.06	2.21							
YA5C	#5 AWG	—	1/4	0.44	1.12	0.07	1.98	W5CVT (2) W5CRT (2) X5CRT (2)	W5CVT (2) W5CRT (2) X5CRT (2)	U5CRT (2)	Blue	7 or 374	1-3/16	
YA5CN			1/2	0.83	1.12	0.12	2.67							
YA4CTC10	#4 AWG	21.2	#10	0.50	1.12	0.09	1.94	W4CVT (2) W4CRT (2) X4CRT (2)	W4CVT (2) W4CRT (2) X4CRT (2)	U4CRT (2) U6CABT (2)	Gray	8 or 346	1-3/16	
YA4C			1/4	0.50	1.12	0.09	1.87							
YA4CTC38			3/8	0.58	1.12	0.08	2.25							
YA4CN			1/2	0.83	1.12	0.12	2.69							
YA3CTC14	#3 AWG #2 Solid	26.7 25	1/4	0.55	1.25	0.09	2.23	Y1MRTC (4) Y122CMR (4) MY29 Series (2) 644 Series (1) 444 Series (1) 81K Series (2)	W3CRT (2)	W3CRT (2)	U3CRT (2)	White	9	1-5/16
YA3C			5/16	0.55	1.25	0.09	2.30							
YA3CTC38			3/8	0.58	1.25	0.08	2.42							
YA3CN			1/2	0.83	1.25	0.12	2.86							
YA2CTC10	#2 AWG	33.6 35	#10	0.60	1.25	0.11	2.10	W2CVT (2) W2CRT (2) X2CRT (2)	W2CVT (2) W2CRT (2) X2CRT (2)	U2CRT (2)	Brown	10	1-5/16	
YA2CTC14			1/4	0.60	1.25	0.11	2.23							
YA2C			5/16	0.60	1.25	0.11	2.29							
YA2CTC38			3/8	0.60	1.25	0.11	2.41							
YA2CN			1/2	0.83	1.25	0.12	2.88							
YA1CTC10	#1 AWG	42.4 50	#10	0.68	1.38	0.10	2.27	Y1MR TC(4) MRC840 (2) MY29 Series (2) 644 Series (1) 444 Series (1) 81K Series (2)	W1CVT (2) W1CRT1 (2) X1CRT1 (2)	W1CVT (2) W1CRT1 (2) X1CRT1 (2)	U1CRT1 (2) U4CABT (2)	Green	11	1-7/16
YA1CTC14			1/4	0.68	1.38	0.10	2.39							
YA1C			5/16	0.68	1.38	0.10	2.45							
YA1CTC38			3/8	0.68	1.38	0.10	2.58							
YA1CN			1/2	0.83	1.38	0.12	3.06							

* Use PUADP1 adapter with U dies in 46 Series

** P-RT die sets for use in 46 Series only, PUADP1 adapter not required

*** The MM² conductor sizes listed are the recommendations for Class 2 conductor

▲ See tooling section of this catalog for complete tool and die listings. Use ONLY color coded die recommendations for -FX connectors. For nest/indenter system contact factory

• Available undrilled. Add suffix U to catalog number (example: YA25U)

◆ For applications greater than 2000 Volts consult cable manufacturer for voltage stress relief instructions

Note: All dimensions shown are for reference only

TYPES YA, YA-TC (Continued)

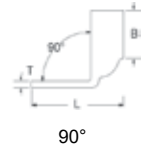
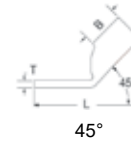
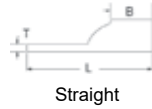

NOTE: Field bending straight lugs to achieve an angular connection will void UL Listing / CSA Certifications and BURNDY will not be liable for the connection.

Catalog Number	Conductor		Stud Hole Size	Tongue Width	Figure Dimensions			Installation Tooling						Wire Strip Length						
	AWG	MM ² ***			(B)	(T)	(L)	Dieless (# of crimps)	MD6, OUR840, MD734R	500 Series	35, 750 46** Series	Color Code	Die Index							
YA25TC10	1/0 AWG	53.5	#10	0.75	1.38	0.12	2.30	MRC840 (4) MY29 Series (2) 644 Series (1) 444 Series (1) 81K Series (2)	W25VT (4) W25RT (4) X25RT (4)	W25VT (4) W25RT (4) X25RT (4)	U25CABT (2)	Pink	12	1-7/16						
YA25			5/16	0.75	1.38	0.13	2.48													
YA25TC38			3/8	0.75	1.38	0.12	2.61													
YA25N			1/2	0.83	1.38	0.11	3.05													
YA26TC14	2/0 AWG	67.4 70	1/4	0.83	1.50	0.12	2.58	MRC840 (4) MY29 Series (2) 644 Series (1) 444 Series (1) 81K Series (2)	W26VT (4) W26RT (4) X26RT (4)	W26VT (4) W26RT (4) X26RT (4)	U26RT (2)	Black	13	1-9/16						
YA26TC516			5/16	0.83	1.50	0.12	2.65													
YA26			3/8	0.83	1.50	0.12	2.77													
YA26N			1/2	0.83	1.50	0.12	3.21													
YA27	3/0 AWG	85	1/2	0.91	1.50	0.13	3.06	MRC840 (4) MY29 Series (2) 644 Series (1) 444 Series (1) 81K Series (2)	W27VT (4) W27RT (4) X27RT (6)	W27VT (4) W27RT (4) X27RT (6)	U27RT (2)	Orange	14	1-9/16						
YA28TC38	4/0 AWG	107	3/8	1.02	1.62	0.14	2.98													
YA28			1/2	1.02	1.62	0.14	3.23													
YA28N			1/2	1.02	1.62	0.14	3.41													
YA29	250 kcmil	127	1/2	1.11	1.62	0.16	3.26	MY29 Series (2) 644 Series (1) 444 Series (1) 81K Series (2)	W29VT (4) X29RT (8)	W29VT (4) W29RT (4) X29RT (8)	U29RT (2)	Yellow	16	1-11/16						
YA30	300 kcmil	152	1/2	1.20	2.00	0.16	3.69	644 Series (1) 444 Series (1) 81K Series (3)	W30VT (4)	W30VT (4) W30RT (4)	U30RT (4) U28ART (4)	White	17 or 298	2-1/16						
YA30N		150	1/2	1.20	2.00	0.16	3.88													
YA31	350 kcmil	177 185	1/2	1.29	2.00	0.18	3.73								W31VT (4)	W31VT (4) W31RT (4)	U31RT (4) U29ART (4)	Red	18 or 324	2-1/16
YA32N	400 kcmil	203	1/2	1.40	2.12	0.19	4.09								W32VT (4)	W32VT (4) W32RT (4)	U32RT (4) U30ART (4)	Blue	19 or 470	2-3/16
YA32			5/8	1.40	2.12	0.19	4.15													

* Use PUADP1 adapter with U dies in 46 Series

** P-RT die sets for use in 46 Series only, PUADP1 adapter not required

*** The MM² conductor sizes listed are the recommendations for Class 2 conductor

▲ See tooling section of this catalog for complete tool and die listings. Use ONLY color coded die recommendations for -FX connectors. For nest/indenter system contact factory

• Available undrilled. Add suffix U to catalog number (example: YA25U)

◆ For applications greater than 2000 Volts consult cable manufacturer for voltage stress relief instructions

Note: All dimensions shown are for reference only

Compression Connections

Copper Compression — Code — One Hole
Long Barrel — No Inspection Window

TYPES YA, YA-TC (Continued)

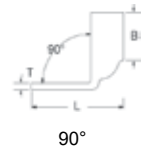
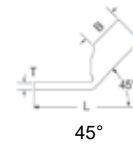
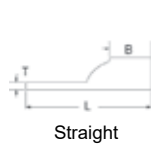

NOTE: Field bending straight lugs to achieve an angular connection will void UL Listing / CSA Certifications and BURNDY will not be liable for the connection.

Catalog Number	Conductor		Stud Hole Size	Tongue Width	Figure Dimensions			Installation Tooling						Wire Strip Length								
	AWG	MM ² ***			(B)	(T)	(L)	Dieless (# of crimps)	MD6, OUR840, MD734R	500 Series	35, 750, 46** Series	Color Code	Die Index									
YA33N	450 kcmil	—	1/2	1.48	2.13	0.21	4.17	644 Series (1) 444 Series (1) 81K Series (4)	W33VT (4)	W33VT (4) W33RT (4)	U33RT (4)	Gray	326 or 538	2-5/16								
YA33		—	5/8	1.48	2.13	0.21	4.24															
YA34N	500 kcmil	253	1/2	1.55	2.25	0.23	4.32		644 Series (1) 444 Series (1) 81K Series (4)	W34VT (4)	W34VT (4) W34RT (4)	U34RT (4) U31ART (2)	Brown	20 or 299	2-5/16							
YA34		240	5/8	1.55	2.25	0.23	4.39															
YA36N	600 kcmil	304	1/2	1.74	2.69	0.27	4.83			644 Series (1) 444 Series (1) 81K Series (4)	—	—	U36RT (4) U32ART (4)	Green	22 or 472	2-3/4						
YA36		300	5/8	1.74	2.69	0.27	4.90															
YA37N	650 kcmil	—	1/2	1.80	2.81	0.27	4.98				644 Series (1) 444 Series (1) 81K Series (4)	—	—	U37RT (4)	Orange	23	2-7/8					
YA37		—	5/8	1.80	2.81	0.27	5.05															
YA38N	700 kcmil	355	1/2	1.84	2.81	0.27	5.01					644 Series (1) 444 Series (1) 81K Series (4)	—	—	U38RT (4)	Pink	400	2-7/8				
YA38		—	5/8	1.84	2.81	0.27	5.07															
YA39N	750 kcmil	380	1/2	1.91	2.88	0.27	5.11						644 Series (1) 444 Series (1) 81K Series (4)	—	—	U39RT (4) P39RT (4)	Black	24	2-15/16			
YA39		—	5/8	1.91	2.88	0.27	5.17															
YA40	800 kcmil	405 400	5/8	1.98	2.94	0.30	5.25							644 Series (1) 444 Series (1) 81K Series (4)	—	—	P40RT (4)	Orange	25	3		
YA41N	850 kcmil	—	1/2	2.01	2.94	0.31	5.20														644 Series (1) 444 Series (1) 81K Series (4)	—
YA41		—	5/8	2.01	2.94	0.31	5.26															
YA44N	1000 kcmil	507	1/2	2.19	3.00	0.33	5.38								644 Series (1) 444 Series (1) 81K Series (4)	—	—	P44RT (4)	White	27		3-1/16
YA44		500	5/8	2.19	3.00	0.33	5.45															
YA45	1250 kcmil	633	3/4	2.46	3.19	0.38	5.93	644 Series (1) 444 Series (1) 81K Series (4)								—	—	P45RT (6)	Yellow	29		3-1/4
YA46N	1500 kcmil	760	1/2	2.69	3.19	0.40	5.79		644 Series (1) 444 Series (1) 81K Series (4)													
YA46		—	3/4	2.69	3.19	0.40	6.04															
YA47N	1750 kcmil	887	1/2	2.90	3.44	0.42	6.13			644 Series (1) 444 Series (1) 81K Series (4)						—	—	—	Gray	33		3-1/2
YA47		—	3/4	2.90	3.44	0.42	6.38															
YA48N	2000 kcmil	1010	1/2	3.10	3.44	0.46	6.22				644 Series (1) 444 Series (1) 81K Series (4)					—	—	—	Brown	34		3-1/2
YA48		—	3/4	3.10	3.44	0.46	6.47															

* Use PUADP1 adapter with U dies in 46 Series

** P-RT die sets for use in 46 Series only, PUADP1 adapter not required

*** The MM² conductor sizes listed are the recommendations for Class 2 conductor

▲ See tooling section of this catalog for complete tool and die listings. Use ONLY color coded die recommendations for -FX connectors. For nest/indenter system contact factory

• Available undrilled. Add suffix U to catalog number (example: YA25U)

◆ For applications greater than 2000 Volts consult cable manufacturer for voltage stress relief instructions

Note: All dimensions shown are for reference only

TYPE YAZ

HYLUG™

Uninsulated Copper Compression Terminal
UL Listed 90° C, Up to 35 kV ◆

45° and 90° angles available. Please contact Customer Service to order:
1-800-346-4175

Features & Benefits

- Inspection window allows for visual verification that the wire has been fully inserted prior to crimping the lug
- Barrel is designed with an internal chamfer at the wire entry to ensure smooth insertion of the wire, preventing possible damaging of the strands
- Long barrel allows for an increased number of crimps which will increase the mechanical strength of the connection
- 45° and 90° angular lugs are available; please contact Customer Service
- Electro-tin plated unless otherwise specified to reduce galvanic corrosion (bimetallic) and resist corrosive elements
- Connectors are clearly marked with stamping and barrel color coding
- BURNDY certifies its products using the BURNDY Engineered System and select other crimp tool manufacturers in accordance with one or more of the UL categories in order to obtain a UL Listing
- Terminals and splices accommodating code wire: Accommodates Code Class B (Concentric, Compressed, Compact) and Class C wire

Accessories

- Hardware - Section F
- PENETROX™ Oxide Inhibitor - Section F
- Heat and Cold Shrink Tubing - Section D
- WIREMIKE™ Wire Micrometer - Section F
- Wire Management (Cable Ties) - Section G

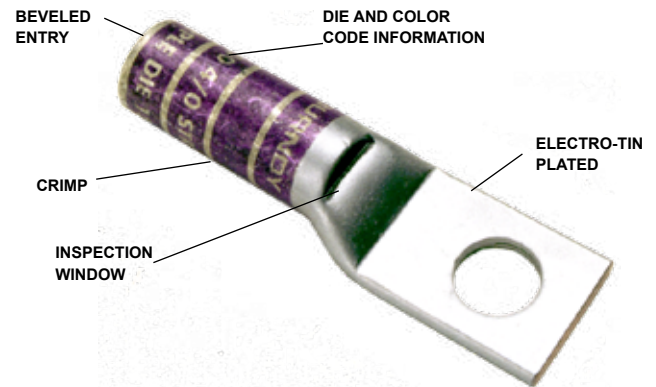

NOTE: Field bending straight lugs to achieve an angular connection will void UL Listing / CSA Certifications and BURNDY will not be liable for the connection.

Straight



45°



90°

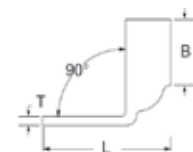

Compression Connections

Copper Compression — Code — One Hole
Long Barrel — with Inspection Window

TYPE YAZ (Continued)

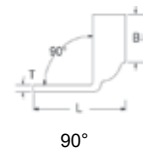
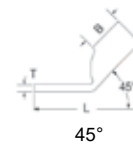
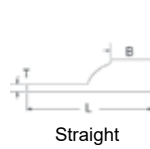

NOTE: Field bending straight lugs to achieve an angular connection will void UL Listing / CSA Certifications and BURNDY will not be liable for the connection.

Catalog Number	Conductor		Stud Hole Size	Tongue Width	Figure Dimensions			Installation Tooling						Wire Strip Length		
	AWG	MM ² ***			(B)	(T)	(L)	Dieless (# of crimps)	MD6, OUR840, MD734R	500 Series	35, 750, 46* Series	Color Code	Die Index			
YAZV10TC14	#14-10 Str #12-10 Sol	5.26 6	1/4	0.41	0.69	0.05	1.52	MR20 (2) Y8MRB1 (2) Y122CMR (2)	—	—	—	—	—	—	3/4	
YAZ8CTC10	#8 AWG	8.37 10	#10	0.41	0.75	0.08	1.43	Y122CMR (2) Y1MRTC (2) MY29 Series (2) MRC840 (2) 81K Series (1)	W8CVT (2) W8CRT (2) X8CRT (2)	W8CVT (2) W8CRT (2) X8CRT (2)	U8CRT (2)	Red	49	13/16		
YAZ8CTC14	#8 Flex G,H,I,K,M DLO		1/4	0.44	0.75	0.08	1.56									
YAZ8CTC38			3/8	0.58	0.75	0.06	1.75									
YAZ6CTC10	#6 AWG Sol / Str	13.3	#10	0.42	1.12	0.09	1.89		W5CVT (2) W5CRT (2) X5CRT (2) X8CART (2)	W5CVT (2) W5CRT (2) X5CRT (2) X8CART (2)	U5CRT (2) U8CABT (2)	Blue	7 or 374		1-3/16	
YAZ6CTC14			1/4	0.45	1.12	0.08	2.02									
YAZ6CTC38			3/8	0.58	1.12	0.06	2.21									
YAZ6CTC12			1/2	0.75	1.12	0.12	2.46									
YAZ5CTC12	#5 AWG	—	1/2	0.83	1.12	0.12	2.48		W5CVT (2) W5CRT (2) X5CRT (2)	W5CVT (2) X5CRT (2) W5CRT (2)	U5CRT (2)	Blue	7 or 374		1-3/16	
YAZ4CTC14	#4 AWG	21.2	1/4	0.50	1.12	0.09	2.04		Y122CMR (4) Y1MRTC (4) MY29 Series (2) MRC840 (2) 644 Series (1) 444 Series (1) 81K Series (1)	W4CVT (2) W4CRT (2) X4CRT (2)	W4CVT (2) W4CRT (2) X4CRT (2)	U4CRT (2) U6CABT (2)	Gray		8 or 346	1-3/16
YAZ4CTC38			3/8	0.58	1.12	0.08	2.22									
YAZ4CTC12			1/2	0.73	1.12	0.06	2.50									
YAZ3CTC14	#3 AWG #2 Sol	26.7 25	1/4	0.55	1.25	0.09	2.19	Y122CMR** (4) Y1MRTC (4) MY29 Series (2) MRC840 (2) 644 Series (1) 444 Series (1) 81K Series (2)	W3CRT (2)	W3CRT (2)	U3CRT (2)	White	9	1-5/16		
YAZ3CTC38			3/8	0.58	1.25	0.08	2.38									
YAZ3CTC12			1/2	0.71	1.25	0.07	2.63									
YAZ2CTC14	#2 AWG	33.6 35	1/4	0.60	1.25	0.11	2.21		W2CVT (2) W2CRT (2) X2CRT (2)	W2CVT (2) W2CRT (2) X2CRT (2)	U2CRT (2)	Brown	10		1-5/16	
YAZ2CTC516			5/16	0.60	1.25	0.11	2.27									
YAZ2CTC38			3/8	0.60	1.25	0.11	2.40									
YAZ2CTC12			1/2	0.73	1.25	0.09	2.65									
YAZ1CTC14	#1 AWG	42.4 50	1/4	0.68	1.38	0.10	2.37		W1CVT (2) W1CRT1 (2) X1CRT1 (2)	W1CVT (2) W1CRT1 (2) X1CRT1 (2)	U1CRT1 (2) U4CABT (2)	Green	11 or 375		1-7/16	
YAZ1CTC38			3/8	0.68	1.38	0.10	2.56									
YAZ1CTC12			1/2	0.73	1.38	0.09	2.81									

* Use PUADP1 adapter with U dies in 46 Series

** Y122CMR tool #10-#2 AWG Wire only

*** The MM² conductor sizes listed are the recommendations for Class 2 conductor

† The MM² conductor size listed is for Class 2 and Class 5 conductor

▲ See tooling section of this catalog for complete tool and die listings

• Available undrilled. Add suffix U to catalog number (example: YA25U)

◆ For applications greater than 2000 Volts consult cable manufacturer for voltage stress relief instructions

Note: All dimensions shown are for reference only

TYPES YAZ (Continued)

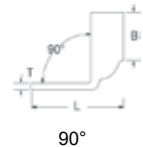
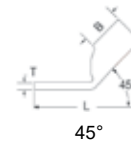
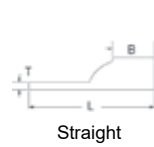

NOTE: Field bending straight lugs to achieve an angular connection will void UL Listing / CSA Certifications and BURNDY will not be liable for the connection.

Catalog Number	Conductor		Stud Hole Size	Tongue Width	Figure Dimensions			Installation Tooling						Wire Strip Length
	AWG	MM ² ***			(B)	(T)	(L)	Dieless (# of crimps)	MD6, OUR840, MD734R	500 Series	35, 750, 46* Series	Color Code	Die Index	
YAZ25TC14	1/0 AWG	53.5	1/4	0.75	1.38	0.12	2.40	MY29 Series (2) MRC840 (4) 644 Series (1) 444 Series (1) 81K Series (2)	W25RT (4) W25VT (4) X25RT (4)	W25VT (4) W25RT (4) X25RT (4)	U25RT (2) U2CABT (2)	Pink	12 or 348	1-7/16
YAZ25TC516			5/16	0.75	1.38	0.12	2.46							
YAZ25TC38			3/8	0.75	1.38	0.12	2.59							
YAZ25TC12			1/2	0.75	1.38	0.12	2.84							
YAZ26TC14	2/0 AWG	67.4 70	1/4	0.83	1.50	0.12	2.56		W26RT (4) W26VT (4) X26RT (4)	W26VT (4) W26RT (4) X26RT (4)	U26RT (2)	Black	13	1-9/16
YAZ26TC38			3/8	0.83	1.50	0.12	2.75							
YAZ26TC12			1/2	0.83	1.50	0.12	3.00							
YAZ27TC38	3/0 AWG	85	3/8	0.90	1.50	0.12	2.79		W27RT (4) W27VT (4) X27RT (6)	W27VT (4) W27RT (4) X27RT (6)	U27RT (2)	Orange	14	1-9/16
YAZ27TC12			1/2	0.90	1.50	0.12	3.04							
YAZ28TC38	4/0 AWG	107	3/8	1.02	1.62	0.14	2.95		W28VT (4) W28RT (4) X28RT (6)	W28VT (4) W28RT (4) X28RT (6)	U28RT (2)	Purple	15	1-11/16
YAZ28TC12			1/2	1.02	1.62	0.14	3.20							
YAZ29TC38	250 kcmil	127	3/8	1.10	1.62	0.16	2.98		W29VT (4) X29RT (8)	W29VT (4) W29RT (4) X29RT (6)	U29RT (2)	Yellow	16	1-11/16
YAZ29TC12			1/2	1.10	1.62	0.16	3.23							
YAZ30TC38	300 kcmil	152 150	3/8	1.20	2.00	0.16	3.41	W30VT (4)	W30VT (4) W30RT (4)	U30RT U28ART(4)	White	17 or 298	2-1/16	
YAZ30TC12			1/2	1.20	2.00	0.16	3.66							
YAZ31TC38	350 kcmil	177 185	3/8	1.29	2.00	0.18	3.44	W31VT (4)	W31VT (4) W31RT (4)	U31RT U29ART (4)	Red	18 or 324	2-1/16	
YAZ31TC12			1/2	1.29	2.00	0.18	3.69							
YAZ32TC38	400 kcmil	203	3/8	1.40	2.12	0.19	3.61	W32VT (4)	W32VT (4) W32RT (4)	U32RT U30ART (4)	Blue	19 or 470	2-3/16	
YAZ32TC12			1/2	1.40	2.12	0.19	3.86							
YAZ33TC12	450 kcmil	—	1/2	1.48	2.12	0.21	3.95	W33VT (4)	W33VT (4) W33RT (4)	W33RT (4)	Gray	326 or 538	2-5/16	
YAZ34TC38	500 kcmil	253 240	3/8	1.55	2.25	0.23	3.84							
YAZ34TC12			1/2	1.55	2.25	0.23	4.10	W34VT (4)	W34VT (4) W34RT (4)	U34RT (4) U31ART(2)	Brown	20 or 299	2-5/16	
YAZ35TC12	550 kcmil	—	1/2	1.65	2.62	0.25	4.50							—

* Use PUADP1 adapter with U dies in 46 Series

** Y122CMR tool #10-#2 AWG Wire only

*** The MM² conductor sizes listed are the recommendations for Class 2 conductor

† The MM² conductor size listed is for Class 2 and Class 5 conductor

▲ See tooling section of this catalog for complete tool and die listings

• Available undrilled. Add suffix U to catalog number (example: YA25U)

◆ For applications greater than 2000 Volts consult cable manufacturer for voltage stress relief instructions

Note: All dimensions shown are for reference only

Compression Connections

Copper Compression — Code — One Hole
Long Barrel — with Inspection Window

TYPE YAZ (Continued)

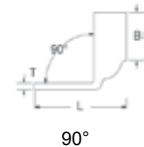
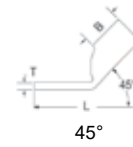
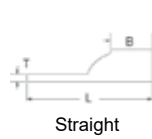

NOTE: Field bending straight lugs to achieve an angular connection will void UL Listing / CSA Certifications and BURNDY will not be liable for the connection.

Catalog Number	Conductor		Stud Hole Size	Tongue Width	Figure Dimensions			Installation Tooling					Wire Strip Length				
	AWG	MM ² ***			(B)	(T)	(L)	Dieless (# of crimps)	MD6, OUR840, MD734R	500 Series	35, 750, 46* Series	Color Code		Die Index			
YAZ36TC38	600 kcmil	304	3/8	1.74	2.69	0.26	4.54	644 Series (1) 444 Series (1) 81K Series (4)	—	—	U36RT (4)	Green	22 or 472	2-3/4			
YAZ36TC12		300	1/2	1.74	2.69	0.26	4.60				U32ART (4)						
YAZ37TC12	650 kcmil	—	1/2	1.80	2.81	0.27	4.75				U37RT (4)	Orange	23	2-7/8			
YAZ38TC12	700 kcmil	355	1/2	1.84	2.81	0.27	4.77				U38RT (4)	Pink	400	2-7/8			
YAZ39TC38	750 kcmil	380	3/8	1.91	2.88	0.27	4.81				U39RT (4) P39RT** (4)	Black	24	2-15/16			
YAZ39NT12			1/2	1.63	2.88	0.27	4.87										
YAZ39TC12			1/2	1.91	2.88	0.27	4.87										
YAZ40TC12	800 kcmil	405 400	1/2	1.98	2.94	0.30	4.94				—	Orange	25	3			
YAZ41TC12	850 kcmil	—	1/2	2.01	2.94	0.31	4.96				—	Gold	26	3			
YAZ44TC38	1000 kcmil	507	3/8	2.19	3.00	0.33	5.08				P44RT** (4)	White	27	3-1/16			
YAZ44TC12		500	1/2	2.19	3.00	0.33	5.14										
YAZ45TC12	1250 kcmil	633	1/2	2.46	3.19	0.38	5.43				—	—	—	P45RT** (6)	Yellow	29	3-1/4
YAZ453TC12	1300 kcmil	—	1/2	2.53	3.19	0.39	5.46							—	Orange	30	3-1/4
YAZ46TC12	1500 kcmil	760	1/2	2.69	3.19	0.40	5.53							P46RT** (6)	Green	31	3-1/4
YAZ47TC12	1750 kcmil	887	1/2	2.90	3.44	0.42	5.87	—	Gray	33				3-1/2			
YAZ48TC12	2000 kcmil	1010	1/2	3.10	3.44	0.46	5.95	—	—	—				—	Brown	34	3-1/2
														—	—	—	—

* Use PUADP1 adapter with U dies in 46 Series

** Y122CMR tool #10-#2 AWG Wire only

*** The MM² conductor sizes listed are the recommendations for Class 2 conductor

† The MM² conductor size listed is for Class 2 and Class 5 conductor

▲ See tooling section of this catalog for complete tool and die listings

• Available undrilled. Add suffix U to catalog number (example: YA25U)

◆ For applications greater than 2000 Volts consult cable manufacturer for voltage stress relief instructions

Note: All dimensions shown are for reference only

TYPES YAV-2TC, YA-2LN, YA-L-2TC-

HYLUG™

Uninsulated Copper Compression Terminal
UL Listed 90° C, Up to 35 kV ◆

45° and 90° angles available. Please contact Customer Service to order:
1-800-346-4175

Features & Benefits

- Inspection window allows for visual verification that the wire has been fully inserted prior to crimping the lug
- Barrel is designed with an internal chamfer at the wire entry to ensure smooth insertion of the wire, preventing possible damaging of the strands
- Short/Standard length barrel is recommended for installations with limited space requirements
- Two hole tongue/tang is recommended when space permits as the 2-hole feature minimizes the terminations from loosening or rotating under vibration, movement, or heat cycling
- 45° and 90° angular lugs are available; please contact Customer Service
- Electro-tin plated unless otherwise specified to reduce galvanic corrosion (bimetallic) and resist corrosive elements
- Connectors are clearly marked with stamping and barrel color coding
- BURNDY certifies its products using the BURNDY Engineered System and select other crimp tool manufacturers in accordance with one or more of the UL categories in order to obtain a UL Listing
- Terminals and splices accommodating code wire: Accommodates Code Class B (Concentric, Compressed, Compact) and Class C wire

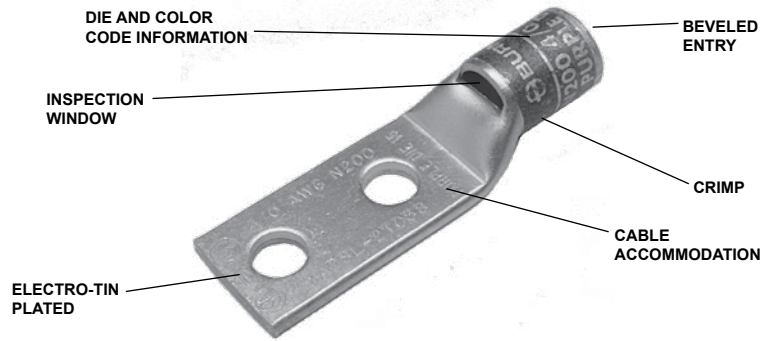

NOTE: Field bending straight lugs to achieve an angular connection will void UL Listing / CSA Certifications and BURNDY will not be liable for the connection.

Straight



45°



90°

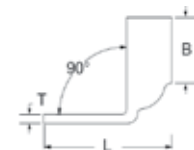

Accessories

- Hardware - Section F
- PENETROX™ Oxide Inhibitor - Section F
- Heat and Cold Shrink Tubing - Section D
- WIREMIKE™ Wire Micrometer - Section F
- Wire Management (Cable Ties) - Section G

Compression Connections

Copper Compression — Code — Two Hole
Standard Barrel — with Inspection Window

TYPES YAV-2TC, YA-2LN, YA-L-2TC- (Continued)

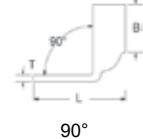
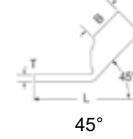
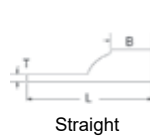

NOTE: Field bending straight lugs to achieve an angular connection will void UL Listing / CSA Certifications and BURNDY will not be liable for the connection.

Catalog Number	Conductor		Stud Hole Size	Stud Hole Spacing	Tongue Width	Figure Dimensions			Installation Tooling					Wire Strip Length	
	AWG	MM ² ***				(B)	(T)	(L)	Dieless (# of crimps)	MD6, OUR840, MD734R	500 Series	35, 750, 46* Series	Color Code		Die Index
YAV102TC10	#14-10 Str. Sol.	5.26 6	#10	5/8"	0.36	0.38	0.06	1.72	MR20 (1) Y8MRB1 (1) Y122CMR (1)	—	—	—	—	—	7/16
YAV102TC10E2			#10	3/4"	0.36	0.38	0.06	1.84							
YAV102TC14			1/4	5/8"	0.41	0.38	0.05	1.84							
YAV102TC14E1			1/4	1"	0.41	0.38	0.05	2.22							
YAV102TC14E2			1/4	3/4"	0.41	0.38	0.05	1.97							
YAV102TC38			3/8	1"	0.56	0.38	0.04	2.40							
YA8CL2TC10	#8 AWG #8 Flex G,H,I,K,M DLO	8.37 † 10	#10	5/8"	0.41	0.44	0.08	1.83	Y122CMR (1) Y1MRTC (1) Y8MRB1 (1) MY29 Series (1) MRC840 (1) 81K Series (1)	W8CVT (1) W8CRT (1) X8CRT (1)	W8CVT (1) W8CRT (1) X8CRT (1)	U8CRT (1)	Red	49	7/16
YA8CL2TC10E2			#10	3/4"	0.41	0.44	0.08	1.95							
YA8CL2TC14			1/4	5/8"	0.44	0.44	0.08	1.95							
YA8CL2TC14E2			1/4	3/4"	0.44	0.44	0.08	2.08							
YA8CL2TC14E1			1/4	1"	0.44	0.44	0.08	2.33							
YA8CL2TC38			3/8	1"	0.58	0.44	0.06	2.52							
YA8C2LN			1/2	1-3/4"	0.83	0.44	0.12	3.75							
YA6C2L51	6 AWG Sol/Str	13.3	#10	1/2"	0.42	0.54	0.09	1.79	Y122CMR (1) Y1MRTC (1) Y8MRB1 (1) MY29 Series (1) MRC840 (1) 81K Series (1)	W5CVT (1) W5CRT (1) X5CRT (1) X8CART (1)	W5CVT (1) W5CRT (1) X5CRT (1) X8CART (1)	U5CRT (1) U8CABT (1)	Blue	7 or 374	5/8
YA6CL2TC10			#10	5/8"	0.42	0.54	0.09	1.94							
YA6C2L52			1/4	1/2"	0.45	0.54	0.08	1.88							
YA6CL2TC14E			1/4	1/2"	0.45	0.54	0.08	1.94							
YA6C2L			1/4	5/8"	0.45	0.54	0.08	2.01							
YA6CL2TC14			1/4	5/8"	0.45	0.54	0.08	2.07							
YA6CL2TC14E2			1/4	3/4"	0.45	0.54	0.08	2.19							
YA6CL2TC14E1			1/4	1"	0.45	0.54	0.08	2.44							
YA6CL2TC516E2			5/16	3/4"	0.52	0.54	0.07	2.53							
YA6CL2TC516			5/16	1"	0.52	0.54	0.07	2.78							
YA6CL2TC38			3/8	1"	0.58	0.54	0.06	2.63							
YA6C2LN	1/2	1-3/4"	0.83	0.54	0.12	4.10									
YA5C2L	5 AWG	—	1/4	5/8"	0.44	0.81	0.07	2.28	Y122CMR (1) Y1MRTC (1) MY29 Series (1) MRC840 (1) 81K Series (1)	W5CVT (1) W5CRT (1) X5CRT (1) X8CART (1)	W5CVT (1) W5CRT (1) X5CRT (1) X8CART (1)	U5CRT (1) U8CABT (1)	Blue	7 or 374	7/8
YA4C2L	4 AWG	21.2	1/4	5/8"	0.50	0.81	0.09	2.30	Y122CMR (2) Y1MRTC (2) MY29 Series (1) MRC840 (1) 644 Series (1) 444 Series (1) 81K Series (1)	W4CVT (1) W4CRT (1) X4CRT (1)	W4CVT (1) W4CRT (1) X4CRT (1)	U4CRT (1) U6CABT (1)	Gray	8 or 346	7/8
YA4CL2TC14			1/4	5/8"	0.50	0.81	0.09	2.36							
YA4CL2TC14E2			1/4	3/4"	0.50	0.81	0.09	2.49							
YA4CL2TC14E1			1/4	1"	0.50	0.81	0.09	2.74							
YA4CL2TC516			5/16	1"	0.52	0.81	0.09	2.80							
YA4CL2TC38			3/8	1"	0.58	0.81	0.08	2.96							
YA4C2LN			1/2	1-3/4"	0.83	0.81	0.12	4.14							

-- Color code not assigned

* Use PUADP1 adapter with U dies in 46 Series

*** The MM² conductor sizes listed are the recommendations for Class 2 conductor

▲ See tooling section of this catalog for complete tool and die listings

◆ For applications greater than 2000 volts consult cable manufacturer for voltage stress relief instructions

Note: All dimensions shown are for reference only

TYPES YAV-2TC, YA-2LN, YA-L-2TC- (Continued)

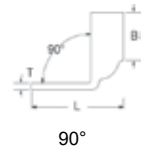
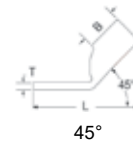
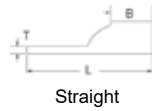

NOTE: Field bending straight lugs to achieve an angular connection will void UL Listing / CSA Certifications and BURNDY will not be liable for the connection.

Catalog Number	Conductor		Stud Hole Size	Stud Hole Spacing	Tongue Width	Figure Dimensions			Installation Tooling						Wire Strip Length
	AWG	MM ² ***				(B)	(T)	(L)	Dieless (# of crimps)	MD6, OUR840, MD734R	500 Series	35, 750, 46* Series	Color Code	Die Index	
YA3CL2TC14	3 AWG #2 Sol.	26.7 25	1/4	5/8"	0.55	0.88	0.09	2.45	Y122CMR** (2) Y1MRTC (2) MY29 Series (1) MRC840 (1) 644 Series (1) 444 Series (1) 81K Series (1)	W3CRT (1)	W3CRT (1)	U3CRT (1)	White	9	15/16
YA3C2L			5/16	5/8"	0.55	0.88	0.09	2.64							
YA3CL2TC38			3/8	1"	0.58	0.88	0.08	3.06							
YA2CL2TC14	#2 AWG	33.6 35	1/4	5/8"	0.60	0.88	0.11	2.47		W2CVT (1) W2CRT (1) X2CRT (1)	W2CVT (1) W2CRT (1) X2CRT (1)	U2CRT (1)	Brown	10	15/16
YA2CL2TC14E2			1/4	3/4"	0.60	0.88	0.11	2.60							
YA2CL2TC14E1			1/4	1"	0.60	0.88	0.11	2.85							
YA2C2L			5/16	3/4"	0.60	0.88	0.11	2.67							
YA2CL2TC516			5/16	1"	0.60	0.88	0.11	2.91							
YA2CL2TC38			3/8	1"	0.60	0.88	0.11	3.03							
YA2C2LN			1/2	1-3/4"	0.83	0.88	0.12	4.27							
YA1CL2TC14	1 AWG	42.4 50	1/4	5/8"	0.68	0.88	0.10	2.51		W1CVT (1) W1CRT-1 (1) X1CRT-1 (1)	W1CVT (1) W1CRT-1 (1) X1CRT-1 (1)	U1CRT-1 (1) U4CABT (1)	Green	11 or 375	15/16
YA1CL2TC14E2			1/4	3/4"	0.68	0.88	0.10	2.64							
YA1C2L			5/16	7/8"	0.68	0.88	0.10	2.82							
YA1CL2TC38			3/8	1"	0.68	0.88	0.10	3.07							
YA1C2LN			1/2	1-3/4"	0.83	0.88	0.12	4.32							
YA25L2TC14	1/0 AWG	53.5	1/4	5/8"	0.75	0.88	0.12	2.54	W25VT (2) W25RT (2) X25RT (2)	W25VT (2) W25RT (2) X25RT (2)	U25RT (1) U2CABT (1)	Pink	12 or 348	15/16	
YA25L2TC14E2			1/4	3/4"	0.75	0.88	0.12	2.66							
YA25L2TC14E1			1/4	1"	0.75	0.88	0.12	2.91							
YA252L			5/16	7/8"	0.75	0.88	0.12	2.85							
YA25L2TC38			3/8	1"	0.75	0.88	0.12	3.10							
YA252LN	1/2	1-3/4"	0.83	0.88	0.11	4.29									
YA26L2TC14	2/0 AWG	67.4 70	1/4	5/8"	0.83	0.94	0.12	2.64	W26VT (2) W26RT (2) X26RT (2)	W26VT (2) W26RT (2) X26RT (2)	U26RT (1)	Black	13	1	
YA26L2TC14E2			1/4	3/4"	0.83	0.94	0.12	2.76							
YA26L2TC14E1			1/4	1"	0.83	0.94	0.12	3.01							
YA262L			5/16	7/8"	0.83	0.94	0.12	2.95							
YA26L2TC38			3/8	1"	0.83	0.94	0.12	3.20							
YA262LN	1/2	1-3/4"	0.83	0.94	0.12	4.39									
YA27L2TC14E2	3/0 AWG	85	1/4	3/4"	1.00	1.00	0.12	2.86	W27VT (2) W27RT (2) X27RT (3)	W27VT (2) W27RT (2) X27RT (3)	U27RT (1)	Orange	14	1-1/16	
YA27L2TC38			3/8	1"	1.00	1.00	0.12	3.30							
YA272LN			1/2	1-3/4"	0.91	1.00	0.13	4.48							
YA28L2TC14E2	4/0 AWG	107	1/4	3/4"	1.02	0.88	0.14	2.78	W28VT (2) W28RT (2) X28RT (3)	W28VT (2) W28RT (2) X28RT (3)	U28RT (1)	Purple	15	1-1/8	
YA28L2TC14E1			1/4	1"	1.02	0.88	0.14	3.03							
YA28L2NTC516			5/16	1-3/4"	1.02	0.88	0.14	3.84							
YA28L2TC38E2			3/8	3/4"	1.02	0.88	0.14	2.97							
YA28L2TC38			3/8	1"	1.02	0.88	0.14	3.22							
YA282LN	1/2	1-3/4"	1.02	0.88	0.14	4.41									
YA29L2TC38	250 kcmil	127	3/8	1.00"	1.10	1.06	0.16	3.43	W29VT (2) W29RT (2) X29RT (4)	W29VT (2) W29RT (2) X29RT (4)	U29RT (1)	Yellow	16	1-1/8	
YA292LN			1/2	1-3/4"	1.10	1.06	0.16	4.62							

-- Color code not assigned

* Use PUADP1 adapter with U dies in 46 Series

*** The MM² conductor sizes listed are the recommendations for Class 2 conductor

▲ See tooling section of this catalog for complete tool and die listings

◆ For applications greater than 2000 volts consult cable manufacturer for voltage stress relief instructions

Note: All dimensions shown are for reference only

Compression Connections

Copper Compression — Code — Two Hole Standard Barrel — with Inspection Window

TYPES YAV-2TC, YA-2LN, YA-L-2TC- (Continued)

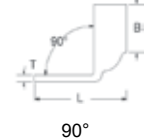
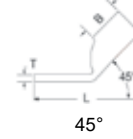
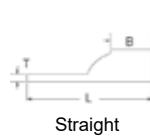

NOTE: Field bending straight lugs to achieve an angular connection will void UL Listing / CSA Certifications and BURNDY will not be liable for the connection.

Catalog Number	Conductor		Stud Hole Size	Stud Hole Spacing	Tongue Width	Figure Dimensions			Installation Tooling						Wire Strip Length	
	AWG	MM ² ***				(B)	(T)	(L)	Dieless (# of crimps)	MD6, OUR840, MD734R	500 Series	35, 750, 46* Series	Color Code	Die Index		
YA30L2TC38	300	kcmil	152	3/8	1"	1.20	1.03	0.16	3.45	644 Series (1) 444 Series (1) 81K Series (1)	W30VT (2)	W30VT (2) W30RT (2)	U30RT (2) U28ART (2)	White	17 or 298	1
YA302LN			150	1/2	1-3/4"	1.20	1.03	0.16	4.63							
YA31L2TC14E2	350	kcmil	177	1/4	3/4"	1.29	1.06	0.18	3.07	644 Series (1) 444 Series (1) 81K Series (1)	W31VT (2)	W31VT (2) W31RT (2)	U31RT (2) U29ART (2)	Red	18 or 324	1-1/8
YA31L2NTC516				5/16	1-3/4"	1.29	1.06	0.18	4.13							
YA31L2TC38			3/8	1"	1.29	1.06	0.18	3.51								
YA31L2TC12			185	1/2	1-1/4"	1.29	1.06	0.18	4.01							
YA312LN	400	kcmil	203	1/2	1-3/4"	1.29	1.06	0.18	4.70	644 Series (1) 444 Series (1) 81K Series (1)	W32VT (2)	W32VT (2) W32RT (2)	U32RT (2) U30ART (2)	Blue	19 or 470	1-1/4
YA322L				3/8	1"	1.40	1.19	0.19	3.75							
YA32L2TC38				3/8	1"	1.40	1.19	0.19	3.69							
YA32L2TC38E5				3/8	1-1/16"	1.40	1.19	0.19	3.75							
YA322LN	500	kcmil	253 240	1/2	1-3/4"	1.40	1.19	0.19	4.88	644 Series (1) 444 Series (1) 81K Series (1)	W34VT (2)	W34VT (2) W34RT (2)	U34RT (2) U31ART (2)	Brown	20 or 299	1-7/16
YA34L2TC14E2				1/4	3/4"	1.55	1.27	0.23	3.44							
YA342L				3/8	1"	1.55	1.27	0.23	3.94							
YA34L2TC38				3/8	1"	1.55	1.27	0.23	3.88							
YA34L2TC12	550	kcmil	—	1/2	1-1/4"	1.55	1.27	0.23	4.38	644 Series (1) 444 Series (1) 81K Series (1)	—	—	U35RT (2)	Yellow	21	1-3/4
YA342LN				1/2	1-3/4"	1.55	1.27	0.23	5.06							
YA352L	600	kcmil	304 300	3/8	1-1/8"	1.65	1.69	0.25	4.64	644 Series (1) 444 Series (1) 81K Series (1)	—	—	U36RT (2) U32ART (2)	Green	22 or 472	1-3/4
YA352LN				1/2	1-3/4"	1.65	1.69	0.25	5.51							
YA36L2TC38	650	kcmil	—	3/8	1-1/8"	1.80	1.39	0.27	4.40	644 Series (1) 444 Series (1) 81K Series (1)	—	—	U37RT (2)	Orange	23	1-15/16
YA372L				1/2	1-3/4"	1.80	1.39	0.27	5.27							
YA372LN	700	kcmil	355	3/8	1"	1.84	1.45	0.27	4.35	644 Series (1) 444 Series (1) 81K Series (1)	—	—	U38RT (2)	Pink	400	1-15/16
YA38L2TC38				3/8	1-1/8"	1.84	1.45	0.27	4.48							
YA382L				1/2	1-1/2"	1.84	1.45	0.27	4.67							
YA38L2TC12				1/2	1-3/4"	1.84	1.45	0.27	5.35							
YA382LN	750	kcmil	380	3/8	1"	1.91	1.42	0.27	4.36	644 Series (1) 444 Series (1) 81K Series (2)	—	—	U39RT (2) P39RT (2)	Black	24	1-15/16
YA39L2TC38				3/8	1-1/8"	1.91	1.42	0.27	4.48							
YA392L				1/2	1-1/2"	1.91	1.42	0.27	4.92							
YA39L2TC12E3				1/2	1-3/4"	1.91	1.42	0.27	5.36							
YA392LN	800	kcmil	405 400	5/8	1-1/2"	1.91	1.42	0.27	5.17	644 Series (1) 444 Series (1) 81K Series (2)	—	—	P40RT (3)	Orange	25	1-15/16
YA40L2TC38				3/8	1"	1.98	1.42	0.30	4.37							
YA402L				3/8	1-1/8"	1.98	1.42	0.30	4.50							
YA402LN	850	kcmil	—	1/2	1-3/4"	1.98	1.42	0.30	5.38	644 Series (1) 444 Series (1) 81K Series (2)	—	—	P41D (1)** P44PR	Gold	26	1-15/16
YA412L				3/8	1-1/8"	2.01	1.88	0.31	4.97							
YA442L	1000	kcmil	507 500	1/2	1-1/4"	2.19	1.65	0.33	5.24	644 Series (1) 444 Series (1) 81K Series (2)	—	—	P44RT (3)	White	27	1-15/16
YA44L2TC12				1/2	1-1/4"	2.19	1.65	0.33	5.05							
YA442LN				1/2	1-3/4"	2.19	1.65	0.33	5.74							

-- Color code not assigned

* Use PUADP1 adapter with U dies in 46 Series

*** The MM² conductor sizes listed are the recommendations for Class 2 conductor

▲ See tooling section of this catalog for complete tool and die listings

◆ For applications greater than 2000 volts consult cable manufacturer for voltage stress relief instructions

Note: All dimensions shown are for reference only

TYPE YA-L-2NT

HYLUG™

Uninsulated Copper Compression Terminal
UL Listed 90° C, Up to 35 kV ◆

45° and 90° angles available. Please contact Customer Service to order:
1-800-346-4175

Features & Benefits

- Inspection window allows for visual verification that the wire has been fully inserted prior to crimping the lug
- Narrow tongue/tang is designed for limited space applications
- Barrel is designed with an internal chamfer at the wire entry to ensure smooth insertion of the wire, preventing possible damaging of the strands
- Short/Standard length barrel is recommended for installations with limited space requirements
- Two hole tongue/tang is recommended when space permits as the 2-hole feature minimizes the terminations from loosening or rotating under vibration, movement, or heat cycling
- 45° and 90° angular lugs are available; please contact Customer Service
- Electro-tin plated unless otherwise specified to reduce galvanic corrosion (bimetallic) and resist corrosive elements
- Connectors are clearly marked with stamping and barrel color coding
- BURNDY certifies its products using the BURNDY Engineered System and select other crimp tool manufacturers in accordance with one or more of the UL categories in order to obtain a UL Listing
- Terminals and splices accommodating code wire: Accommodates Code Class B (Concentric, Compressed, Compact) and Class C wire

Accessories

- Hardware - Section F
- PENETROX™ Oxide Inhibitor - Section F
- Heat and Cold Shrink Tubing - Section D
- WIREMIKE™ Wire Micrometer - Section F
- Wire Management (Cable Ties) - Section G

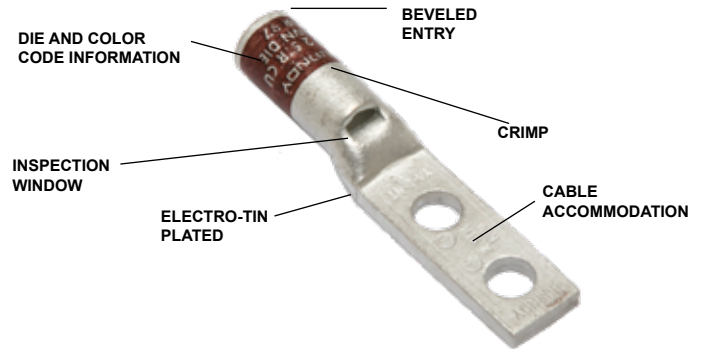

NOTE: Field bending straight lugs to achieve an angular connection will void UL Listing / CSA Certifications and BURNDY will not be liable for the connection.

Straight



45°



90°

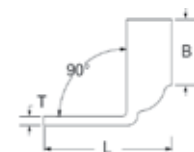

Compression Connections

Copper Compression — Code — Two Hole
Narrow Tongue, Standard Barrel — with Inspection Window

TYPE YA-L-2NT (Continued)

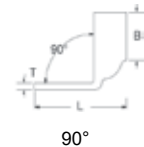
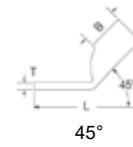
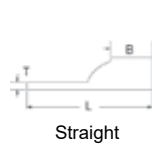

NOTE: Field bending straight lugs to achieve an angular connection will void UL Listing / CSA Certifications and BURNDY will not be liable for the connection.

Catalog Number	Conductor		Stud Hole Size	Stud Hole Spacing	Tongue Width	Figure Dimensions			Installation Tooling					Wire Strip Length								
	AWG	MM ² ***				(B)	(T)	(L)	Dieless (# of crimps)	MD6, OUR840, MD734R	500 Series	35, 750, 46° Series	Color Code		Die Index							
YA2CL2NT14	#2 AWG	33.6 35	1/4	5/8"	0.48	0.88	0.11	2.47	Y122CMR** (1) MRC840 (1) MY29 Series (1) 644 Series (1) 444 Series (1) Y1MRTC (2) 81K Series (1)	W2CVT (1)	W2CVT (1)	U2CRT (1)	Brown	10	15/16							
YA2CL2NT14E2			1/4	1/4"	0.48	0.88	0.11	2.60														
YA2CL2NT14E1			1/4	1"	0.48	0.88	0.11	2.84														
YA1CL2NT14	#1 AWG	42.4 50	1/4	5/8"	0.50	0.88	0.11	2.55	W1CVT (1)	W1CRT1 (1)	U1CRT1 (1)	Green	11	15/16								
YA1CL2NT14E2			1/4	3/4"	0.50	0.88	0.10	2.68														
YA25L2NT14	1/0 AWG	53.5	1/4	5/8"	0.48	0.88	0.12	2.56	MRC840 (2) MY29 Series (1) 644 Series (1) 444 Series (1) 81K Series (1)	W25VT (2)	W25VT (2)	U25RT (1)	Pink	12	15/16							
YA25L2NT14E1	1/4	1"	0.48	0.88	0.12	3.28																
YA26L2NT14	2/0 AWG	67.4 70	1/4	5/8"	0.48	0.94	0.12	2.66														
YA26L2NT14E1			1/4	1"	0.48	0.94	0.12	3.03														
YA27L2NT14	3/0 AWG	85	1/4	5/8"	0.76	1.00	0.13	2.73														
YA27L2NT38			3/8	1"	0.60	1.00	0.13	3.30														
YA27L2NT516			5/16	1"	0.60	1.00	0.13	3.26														
YA28L2NT14	4/0 AWG	107	1/4	5/8"	0.76	0.88	0.13	2.65								W28RT (2)	W28RT (2) X28RT (3)	U28RT (1)	Purple	15	1-1/16	
YA29L2NT38	250 kcmil	127	3/8	1"	0.80	1.00	0.16	3.43								MY29 Series (1) 644 Series (1) 444 Series (1) 81K Series (1)	W29VT (2) X29RT (2)	W29VT (2) W29RT (2) X29RT (2)	U29RT (1)	Yellow	16	1-1/8
YA29L2NT38E16			3/8	1-3/4"	0.80	1.06	0.16	4.18														
YA31L2NT38	350 kcmil	177 185	3/8	1"	0.96	1.06	0.18	3.51	644 Series (1) 444 Series (1) 81K Series (1)	W31VT (2)	W31VT (2) W31RT (2)	U31RT (1) U29ART (2)	Red	18	1-1/8							
YA31L2NT38E16	3/8	1-3/4"	0.88	1.06	0.18	4.26																
YA34L2NT38	500 kcmil	253 240	3/8	1"	0.96	1.27	0.23	3.65														
YA34L2NT38E16			3/8	1-3/4"	0.96	1.27	0.23	4.63														
YA34L2NT12E1	600 kcmil	304 300	1/2	1"	0.96	1.27	0.23	4.13	W34VT (4)	W34VT (4)	U34RT (2)	Brown	20 or 22	1-7/16								
YA36L2NNT	750 kcmil	380	1/2	1-3/4"	1.12	1.38	0.27	5.43	644 Series (1) 444 Series (1) 81K Series (1)	—	—	U36RT (2)	Green	472	1-3/4							
YA39L2NT38	1000 kcmil	507 500	3/8	1"	1.63	1.42	0.27	4.34	644 Series (1) 444 Series (1) 81K Series (2)	—	—	U39RT (2)	Black	24	1-1/2							
YA39L2NT38E16			3/8	1-3/4"	1.30	1.42	0.27	5.11														
YA39L2NT12E1			1/2	1"	1.30	1.42	0.27	4.42														
YA44L2NTC12E24	1000 kcmil	507 500	1/2	1.85	1.63	1.65	0.33	5.65	644 Series (1) 444 Series (1) 81K Series (2)	—	—	P44RT (3)	White	27	1-15/16							

* Use PUADP1 adapter with U dies in 46 Series

** Y122CMR tool #10-#2 AWG Wire only

*** The MM² conductor sizes listed are the recommendations for Class 2 conductor.

Note: All dimensions shown are for reference only.

TYPES YA-2N, YA-2TC

HYLUG™

Uninsulated Copper Compression Terminal
UL Listed 90° C, Up to 35 kV ◆

45° and 90° angles available. Please contact Customer Service to order:
1-800-346-4175

Features & Benefits

- No inspection window is ideal for more corrosive environments as the barrel transition is not open
- Barrel is designed with an internal chamfer at the wire entry to ensure smooth insertion of the wire, preventing possible damaging of the strands
- Long barrel allows for an increased number of crimps which will increase the mechanical strength of the connection
- Two hole tongue/tang is recommended when space permits as the 2-hole feature minimizes the terminations from loosening or rotating under vibration, movement, or heat cycling
- 45° and 90° angular lugs are available; please contact Customer Service
- Electro-tin plated unless otherwise specified to reduce galvanic corrosion (bimetallic) and resist corrosive elements
- Connectors are clearly marked with stamping and barrel color coding
- BURNDY certifies its products using the BURNDY Engineered System and select other crimp tool manufacturers in accordance with one or more of the UL categories in order to obtain a UL Listing
- Terminals and splices accommodating code wire: Accommodates Code Class B (Concentric, Compressed, Compact) and Class C wire

Accessories

- Hardware - Section F
- PENETROX™ Oxide Inhibitor - Section F
- Heat and Cold Shrink Tubing - Section D
- WIREMIKE™ Wire Micrometer - Section F
- Wire Management (Cable Ties) - Section G

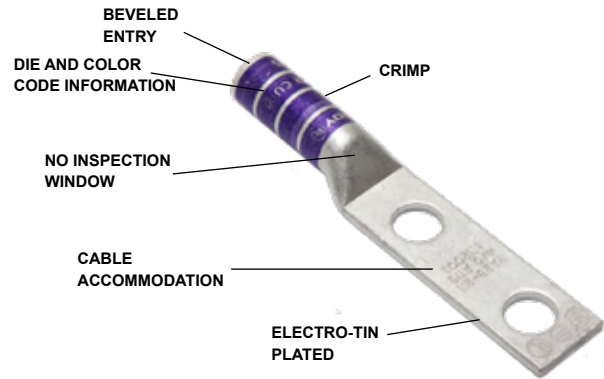

NOTE: Field bending straight lugs to achieve an angular connection will void UL Listing / CSA Certifications and BURNDY will not be liable for the connection.

Straight



45°



90°

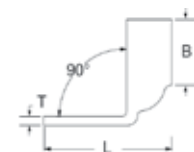

Compression Connections

Copper Compression — Code — Two Hole
Long Barrel — No Inspection Window

TYPES YA-2N, YA-2TC (Continued)

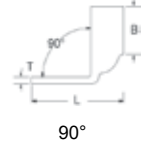
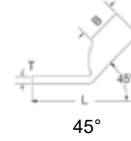
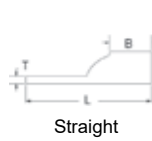

NOTE: Field bending straight lugs to achieve an angular connection will void UL Listing / CSA Certifications and BURNDY will not be liable for the connection.

Catalog Number	Conductor		Stud Hole Size	Stud Hole Spacing	Tongue Width	Figure Dimensions			Installation Tooling						Wire Strip Length
	AWG	MM ² ***				(B)	(T)	(L)	Dieless (# of crimps)	MD6, OUR840, MD734R	500 Series	35, 750, 46* Series	Color Code	Die Index	
YA8C2TC14	#8 AWG #8 Flex G,H,I,K,M DLO	8.37 † 10	1/4	5/8"	0.44	0.81	0.08	2.33	Y8MRB1 (2) Y1MRTC MY29 Series (2) MRC840 (2) 81K Series (1)	W8CVT (2) W8CRT (2) X8CRT (2)	W8CVT (2) W8CRT (2) X8CRT (2)	U8CRT (2)	Red	49	7/8
YA8C2TC14E2			1/4	3/4"	0.44	0.81	0.08	2.45							
YA8C2TC38			3/8	1"	0.58	0.81	0.06	2.89							
YA8C2N			1/2	1-3/4"	0.83	0.81	0.12	4.08							
YA6C2TC14	#6 AWG Sol□/Str	13.3	1/4	5/8"	0.45	1.12	0.08	2.65	Y1MRTC (2) MY29 Series (2) MRC840 (2) 81K Series (1)	W5CVT (2) W5CRT (2) X5CRT (2) X8CART (2)	W5CVT (2) W5CRT (2) X5CRT (2) X8CART (2)	U5CRT (2) U8CABT (2)	Blue	7 or 374	1-3/16
YA6C2TC14E2			1/4	3/4"	0.45	1.12	0.08	2.78							
YA6C2TC14E1			1/4	1"	0.45	1.12	0.08	3.03							
YA6C2TC38E2			3/8	3/4"	0.58	1.12	0.06	2.97							
YA6C2TC38E6			3/8	7/8"	0.58	1.12	0.06	3.09							
YA6C2TC38			3/8	1"	0.58	1.12	0.06	3.22							
YA6C2N	1/2	1-3/4"	0.83	1.12	0.12	4.40									
YA5C2N	#5 AWG	—	1/2	1-3/4"	0.83	1.12	0.12	4.43	MY29 Series (2) MRC840 (2) 81K Series (1)	W5CVT (2) W5CRT (2) X5CRT (2)	W5CVT (2) W5CRT (2) X5CRT (2)	U5CRT (2)	Blue	7 or 374	1-3/16
YA4C2TC14	#4 AWG	21.2	1/4	5/8"	0.50	1.12	0.09	2.70	Y1MRTC (4) MY29 Series (2) MRC840 (2) 644 Series (1) 444 Series (1) 81K Series (1)	W4CVT (2) W4CRT (2) X4CRT (2)	W4CVT (2) W4CRT (2) X4CRT (2)	U4CRT (2) U6CABT (2)	Gray	8 or 346	1-3/16
YA4C2TC14E2			1/4	3/4"	0.50	1.12	0.09	2.83							
YA4C2TC38			3/8	1"	0.58	1.12	0.08	3.26							
YA4C2N			1/2	1-3/4"	0.83	1.12	0.12	4.45							
YA3C2TC14	#3 Str #3 AWG #2 Sol.	26.7 25	1/4	5/8"	0.55	1.25	0.09	2.87	Y122CMR** (4) Y1MRTC (4) MY29 Series (2) MRC840 (2) 644 Series (1) 444 Series (1) 81K Series (1)	W3CVT (2) W3CRT (2)	W3CVT (2) W3CRT (2)	U3CRT (2)	White	9	1-5/16
YA3C2TC14E2			1/4	3/4"	0.55	1.25	0.09	2.99							
YA3C2TC38E2			3/8	3/4"	0.58	1.25	0.08	3.18							
YA3C2TC38			3/8	1"	0.58	1.25	0.08	3.43							
YA3C2N	1/2	1-3/4"	0.83	1.25	0.12	4.62									
YA2C2TC14	#2 AWG	33.6 35	1/4	5/8"	0.60	1.25	0.11	2.86	Y122CMR** (4) Y1MRTC (4) MY29 Series (2) MRC840 (2) 644 Series (1) 444 Series (1) 81K Series (2)	W2CVT (2) W2CRT (2) X2CRT (2)	W2CVT (2) W2CRT (2) X2CRT (2)	U2CRT (2)	Brown	10	1-5/16
YA2C2TC14E2			1/4	3/4"	0.60	1.25	0.11	2.98							
YA2C2TC516E2			5/16	3/4"	0.60	1.25	0.11	3.05							
YA2C2TC38E2			3/8	3/4"	0.60	1.25	0.11	3.17							
YA2C2TC38E6			3/8	7/8"	0.60	1.25	0.11	3.30							
YA2C2TC38			3/8	1"	0.60	1.25	0.11	3.42							
YA2C2N	1/2	1-3/4"	0.83	1.25	0.12	4.64									
YA1C2TC14	#1 AWG	42.4 50	1/4	5/8"	0.67	1.38	0.10	3.03	W1CVT (2) W1CRT1 (2) X1CRT1 (2)	W1CVT (2) W1CRT1 (2) X1CRT1 (2)	U1CRT1 (2) U4CABT (2)	Green	11 or 375	1-7/16	
YA1C2TC14E2			1/4	3/4"	0.67	1.38	0.10	3.15							
YA1C2TC38			3/8	1"	0.67	1.38	0.10	3.59							
YA1C2N			1/2	1-3/4"	0.83	1.38	0.12	4.82							

▲ See tooling section of this catalog for complete tool and die listings

* Use PUADP1 adaptor with U dies in 46 Series

** Y122CMR tool #10-#2 AWG Wire only

*** The MM² conductor sizes listed are the recommendations for Class 2 conductor

† The MM² conductor size listed here is for Class 2 and Class 5 conductor

◆ For applications greater than 2000 Volts consult cable manufacturer for voltage stress relief instructions

Available undrilled. Add suffix U to catalog number (example: YA25U)

Note: All dimensions shown are for reference only

TYPES YA-2N, YA-2TC (Continued)

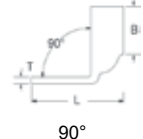
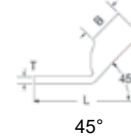
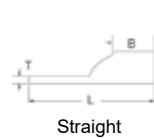

NOTE: Field bending straight lugs to achieve an angular connection will void UL Listing / CSA Certifications and BURNDY will not be liable for the connection.

Catalog Number	Conductor		Stud Hole Size	Stud Hole Spacing	Tongue Width	Figure Dimensions			Installation Tooling						Wire Strip Length
	AWG	MM ² ***				(B)	(T)	(L)	Dieless (# of crimps)	MD6, OUR840, MD734R	500 Series	35, 750, 46* Series	Color Code	Die Index	
YA252TC14	1/0 AWG	53.5	1/4	5/8"	0.75	1.38	0.12	3.05	MY29 Series (2) MRC840 (4) 644 Series (1) 444 Series (1) 81K Series (2)	W25VT (4) W25RT (4) X25RT (4)	W25VT (4) W25RT (4) X25RT (4)	U25RT (2) U2CABT (2)	Pink	12	1-7/16
YA252TC14E2			1/4	3/4"	0.75	1.38	0.12	3.18							
YA252TC516			5/16	1"	0.75	1.38	0.12	3.49							
YA252TC38			3/8	1"	0.75	1.38	0.12	3.62							
YA252NTC38			3/8	1-3/4"	0.75	1.38	0.12	4.37							
YA252N	1/2	1-3/4"	0.83	1.38	0.11	4.81									
YA262TC14	2/0 AWG	67.4 70	1/4	5/8"	0.83	1.50	0.12	3.22		W26VT (4) W26RT (4) X26RT (4)	W26VT (4) W26RT (4) X26RT (4)	U26RT (2)	Black	13	1-9/16
YA262TC14E2			1/4	3/4"	0.83	1.50	0.12	3.34							
YA262TC38			3/8	1"	0.83	1.50	0.12	3.78							
YA262N			1/2	1-3/4"	0.83	1.50	0.12	4.97							
YA272TC14E2	3/0 AWG	85	1/4	3/4"	0.90	1.50	0.12	3.38		W27VT (4) W27RT (4) X27RT (6)	W27VT (4) W27RT (4) X27RT (6)	U27RT (2)	Orange	14	1-9/16
YA272TC38			3/8	1"	0.90	1.50	0.12	3.82							
YA272N			1/2	1-3/4"	0.91	1.50	0.13	5.01							
YA282TC14E2	4/0 AWG	107	1/4	3/4"	1.02	1.62	0.14	3.55		W28VT (4) W28RT (4) X28RT (6)	W28VT (4) W28RT (4) X28RT (6)	U28RT (2)	Purple	15	1-11/16
YA282TC38			3/8	1"	1.02	1.62	0.14	3.99							
YA282NTC38			3/8	1-3/4"	1.02	1.62	0.14	4.74							
YA282N			1/2	1-3/4"	1.02	1.62	0.14	5.17							
YA292TC38	250 kcmil	127	3/8	1"	1.10	1.62	0.16	4.02	MY29 Series (2) 644 Series (1) 444 Series (1) 81K Series (2)	W29VT (4) X29RT (8)	W29VT (4) W29RT (4)	U29RT (2)	Yellow	16	1-11/16
YA292N			1/2	1-3/4"	1.11	1.62	0.16	5.21							
YA292TC58E16			5/8	1-3/4"	1.11	1.62	0.16	5.27							
YA302TC38	300 kcmil	152 150	3/8	1"	1.20	2.00	0.16	4.45	644 Series (1) 444 Series (1) 81K Series (3)	W30VT (4)	W30VT (4) W30RT (4)	U30RT (4) U28ART (4)	White	17 or 298	2-1/16
YA302N			1/2	1-3/4"	1.20	2.00	0.16	5.64							
YA312TC14E2	350 kcmil	177 185	1/4	3/4"	1.29	2.00	0.18	4.05	644 Series (1) 444 Series (1) 81K Series (3)	W31VT (4)	W31VT (4) W31RT (4)	U31RT (4) U29ART (4)	Red	18 or 324	2-1/16
YA312TC38			3/8	1"	1.29	2.00	0.18	4.49							
YA312N			1/2	1-3/4"	1.29	2.00	0.18	5.69							
YA322TC38	400 kcmil	203	3/8	1"	1.40	2.12	0.19	4.66	644 Series (1) 444 Series (1) 81K Series (3)	W32VT (4)	W32VT (4) W32RT (4)	U32RT (4) U30ART (4)	Blue	19 or 470	2-3/16
YA322N			1/2	1-3/4"	1.40	2.12	0.19	5.85							
YA332N	450 kcmil	—	1/2	1-3/4"	1.48	2.13	0.21	5.93	644 Series (1) 444 Series (1) 81K Series (4)	W33VT (4)	W33VT (4) W33RT (4)	U33RT (4)	Gray	326 or 538	2-3/16
YA342TC14E2	500 kcmil	253 240	1/4	3/4"	1.55	2.25	0.23	4.46		W34VT (4)	W34VT (4) W34RT (4)	U34RT (4)	Brown	20 or 299	2-5/16
YA342TC38			3/8	1"	1.55	2.25	0.23	4.90							
YA342N			1/2	1-3/4"	1.55	2.25	0.23	6.06							
YA352N	550 kcmil	—	1/2	1-3/4"	1.65	2.63	0.25	6.49		—	—	U35RT (4)	Yellow	21	2-11/16
YA362TC38	600 kcmil	304 300	3/8	1"	1.74	2.69	0.26	5.59				U36RT (4) U32ART (4)	Green	22 or 472	2-3/4
YA362N			1/2	1-3/4"	1.74	2.69	0.27	6.59							

▲ See tooling section of this catalog for complete tool and die listings

* Use PUADP1 adaptor with U dies in 46 Series

** Y122CMR tool #10-#2 AWG Wire only

*** The MM² conductor sizes listed are the recommendations for Class 2 conductor

† The MM² conductor size listed here is for Class 2 and Class 5 conductor

◆ For applications greater than 2000 Volts consult cable manufacturer for voltage stress relief instructions

Available undrilled. Add suffix U to catalog number (example: YA25U)

Note: All dimensions shown are for reference only

Compression Connections

Copper Compression — Code — Two Hole
Long Barrel — No Inspection Window

TYPES YA-2N, YA-2TC (Continued)

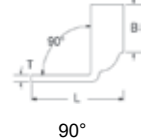
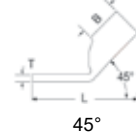
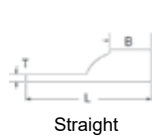

NOTE: Field bending straight lugs to achieve an angular connection will void UL Listing / CSA Certifications and BURNDY will not be liable for the connection.

Catalog Number	Conductor		Stud Hole Size	Stud Hole Spacing	Tongue Width	Figure Dimensions			Installation Tooling						Wire Strip Length			
	AWG	MM ² ***				(B)	(T)	(L)	Dieless (# of crimps)	MD6, OUR840, MD734R	500 Series	35, 750, 46* Series	Color Code	Die Index				
YA372N	650 kcmil	—	1/2	1-3/4"	1.80	2.81	0.27	6.74	644 Series (1) 444 Series (1) 81K Series (4)	—	—	U37RT (4)	Orange	23	2-7/8			
YA382TC38	700 kcmil	355	3/8	1"	1.84	2.81	0.27	5.76				U38RT (4)	Pink	400	2-7/8			
YA382N			1/2	1-3/4"	1.84	2.81	0.27	6.77				U39RT (4) P39RT (4)	Black	24	2-15/16			
YA392TC38	750 kcmil	380	3/8	1"	1.63	2.88	0.27	5.87										
YA392N			1/2	1-3/4"	1.91	2.88	0.27	6.87				P40RT (4)	Orange	25	3			
YA402N	800 kcmil	405 400	1/2	1-3/4"	1.98	2.94	0.30	6.95				P41D (2)** P44PR	Gold	26	3			
YA412N	850 kcmil	—	1/2	1-3/4"	2.01	2.94	0.31	6.96				P44RT (4)	White	27	3-1/16			
YA442TC38	1000 kcmil	507	3/8	1"	2.19	3.00	0.33	6.14				P44RT (4)	White	27	3-1/16			
YA442N	1000 kcmil	500	1/2	1-3/4"	2.19	3.00	0.32	7.14				—	—	—	P45RT (6)	Yellow	29	3-1/4
YA452N	1250 kcmil	633	1/2	1-3/4"	2.46	3.19	0.38	7.44							—	Orange	30	3-1/4
YA4532N	1300 kcmil	—	1/2	1-3/4"	2.53	3.19	0.39	7.48	P46RT (6)	Green	31				3-1/4			
YA462N	1500 kcmil	760	1/2	1-3/4"	2.69	3.19	0.40	7.55	—	Gray	33				3-1/2			
YA472N	1750 kcmil	887	1/2	1-3/4"	2.90	3.44	0.42	7.89	—	Brown	34				3-1/2			
YA482N	2000 kcmil	1010	1/2	1-3/4"	3.10	3.44	0.46	7.98										

▲ See tooling section of this catalog for complete tool and die listings

* Use PUADP1 adaptor with U dies in 46 Series

** Y122CMR tool #10-#2 AWG Wire only

*** The MM² conductor sizes listed are the recommendations for Class 2 conductor

† The MM² conductor size listed here is for Class 2 and Class 5 conductor

□ 644 Series tooling not for use on 6 AWG Sol.

◆ For applications greater than 2000 Volts consult cable manufacturer for voltage stress relief instructions

Available undrilled. Add suffix U to catalog number (example: YA25U)

Note: All dimensions shown are for reference only

TYPE YA-2NT

HYLUG™

Uninsulated Copper Compression Terminal
UL Listed 90° C, Up to 35 kV ◆

45° and 90° angles available. Please contact Customer Service to order:
1-800-346-4175

Features & Benefits

- No inspection window is ideal for more corrosive environments as the barrel transition is not open
- Narrow tongue/tang is designed for limited space applications
- Barrel is designed with an internal chamfer at the wire entry to ensure smooth insertion of the wire, preventing possible damaging of the strands
- Long barrel allows for an increased number of crimps which will increase the mechanical strength of the connection
- Two hole tongue/tang is recommended when space permits as the 2-hole feature minimizes the terminations from loosening or rotating under vibration, movement, or heat cycling
- 45° and 90° angular lugs are available; please contact Customer Service
- Electro-tin plated unless otherwise specified to reduce galvanic corrosion (bimetallic) and resist corrosive elements
- Connectors are clearly marked with stamping and barrel color coding
- BURNDY certifies its products using the BURNDY Engineered System and select other crimp tool manufacturers in accordance with one or more of the UL categories in order to obtain a UL Listing
- Terminals and splices accommodating code wire: Accommodates Code Class B (Concentric, Compressed, Compact) and Class C wire

Accessories

- Hardware - Section F
- PENETROX™ Oxide Inhibitor - Section F
- Heat and Cold Shrink Tubing - Section D
- WIREMIKE™ Wire Micrometer - Section F
- Wire Management (Cable Ties) - Section G

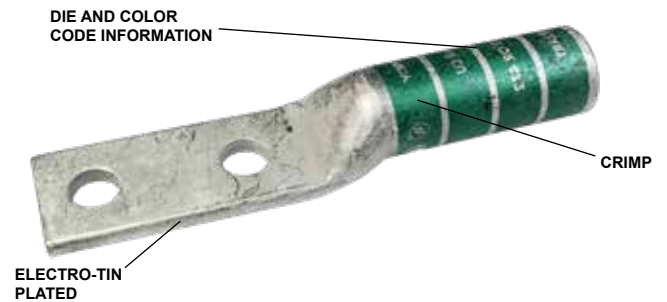

NOTE: Field bending straight lugs to achieve an angular connection will void UL Listing / CSA Certifications and BURNDY will not be liable for the connection.

Straight



45°



90°

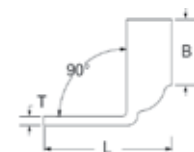

Compression Connections

Copper Compression — Code — Two Hole
Narrow Tongue, Long Barrel — No Inspection Window

TYPE YA-2NT (Continued)

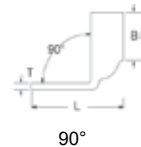
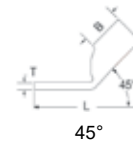
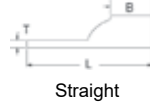

NOTE: Field bending straight lugs to achieve an angular connection will void UL Listing / CSA Certifications and BURNDY will not be liable for the connection.

Catalog Number	Conductor		Stud Hole Size	Stud Hole Spacing	Tongue Width	Figure Dimensions			▲ Installation Tooling						Wire Strip Length
	AWG	*** MM ²				(B)	(T)	(L)	Dieless (# of crimps)	MD6, OUR840, MD734R	500 Series	35, 750, 46* Series	Color Code	Die Index	
YA8C2NT8	#8 AWG #8 Flex G,H,I,K,M DLO	8.37 10	#8	5/8"	0.33"	0.81"	0.09"	2.14"	Y122CMR (2) Y1MRTC (2) MY29 Series (2) MRC840 (2) 81K Series (1)	W8CRT (2) W8CVT (2) X8CRT (2)	W8CRT (2) W8CVT (2) X8CRT (2)	U8CRT (1)	Red	49	7/8"
YA6C2NT8	#6 AWG Sol□/Str	13.3	#8	5/8"	0.33"	0.81"	0.09"	2.14"	Y122CMR (4) Y1MRTC (4) MY29 Series (2) MRC840 (2) 644 Series (1) 444 Series (1) 81K Series (1)	W5CRT (2) W5CVT (2) X5CRT (2) X8CART (2)	W5CRT (2) W5CVT (2) X5CRT (2) X8CART (2)	U5CRT (2) U8CABT(2)	Blue	7 or 374	1-3/16"
YA4C2NT10	#4 AWG	21.2	#10	5/8"	0.33"	1.12"	0.09"	2.47"	Y122CMR (4) Y1MRTC (4) MY29 Series (2) MRC840 (2) 644 Series (1) 444 Series (1) 81K Series (1)	W4CVT (2) W4CRT (2) X4CRT (2)	W4CVT (2) W4CRT (2) X4CRT (2)	U4CRT (2) U6CABT (2)	Black	8 or 346	1-3/16"
YA4C2NT14			1/4"	5/8"	0.49"	1.12"	0.09"	2.70"							
YA2C2NT14	#2 AWG	33.6 35	1/4"	5/8"	0.48"	1.25"	0.11"	2.86"	Y122CMR (4) Y1MRTC (4) MY29 Series (2) MRC840 (2) 644 Series (1) 444 Series (1) 81K Series (2)	W2CVT (2) W2CRT (2) X2CRT (2)	W2CVT (2) W2CRT (2) X2CRT (2)	U2CRT (1)	Brown	10	1-5/16"
YA2C2NT14E2			1/4"	3/4"	0.75"	1.25"	0.11"	2.99"							
YA2C2NT14E1			1/4"	1"	0.60"	1.00"	0.13"	3.26"							
YA1C2NT10	#1 AWG	42.4 50	#10	5/8"	0.50"	1.38"	0.10"	2.90"	Y1MRTC (4) MY29 Series (2) MRC840 (2) 644 Series (1) 444 Series (1) 81K Series (2)	W1CVT (2) W1CRT1 (2) X1CRT1 (2)	W1CVT (2) W1CRT1 (2) X1CRT1 (2)	U1CRT1 (2) U4CABT (2)	Green	11 or 375	1-7/16"
YA1C2NT14			1/4"	5/8"	0.50"	1.38"	0.10"	3.03"							
YA1C2NT14E2			1/4"	3/4"	0.75"	1.38"	0.10"	3.15"							
YA1C2TC38			3/8"	1"	0.60"	1.38"	0.10"	3.59"							
YA1C2N			1/2"	1-3/4"	0.83"	1.38"	0.12"	4.82"							

* Use PUADP1 adapter with U dies in 46 Series

*** The MM² conductor sizes listed are the recommendations for Class 2 conductor

▲ See tooling section of this catalog for complete tool and die listings. Use ONLY color-coded die recommendations for -FX connectors. For nest/indenter system contact factory.

◆ For applications greater than 2000 Volts consult cable manufacturer for voltage stress relief instructions.

Note: All dimensions shown are for reference only.

TYPE YA-2NT (Continued)

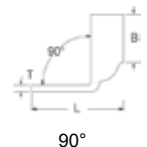
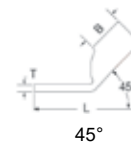
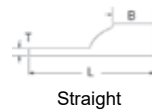

NOTE: Field bending straight lugs to achieve an angular connection will void UL Listing / CSA Certifications and BURNDY will not be liable for the connection.

Catalog Number	Conductor		Stud Hole Size	Stud Hole Spacing	Tongue Width	Figure Dimensions			▲ Installation Tooling						Wire Strip Length
	AWG	*** MM ²				(B)	(T)	(L)	Dieless (# of crimps)	MD6, OUR840, MD734R	500 Series	35, 750, 46* Series	Color Code	Die Index	
YA252NT14	1/0 AWG	53.5	1/4"	5/8"	0.48"	1.38"	0.09"	3.05"	MY29 Series (2) MRC840 (4) 644 Series (1) 444 Series (1) 81K Series (1)	W25VT (4) W25RT (4) X25RT (4)	W25VT (4) W25RT (4) X25RT (4)	U25CRT (2) U2CABT (2)	Pink	12	1-7/16"
YA252NT14E1			1/4"	1"	0.48"	1.38"	0.09"	3.05"							
YA252NT38			3/8"	1"	0.48"	1.38"	0.09"	3.05"							
YA262NT14	2/0 AWG	67.4 70	1/4"	5/8"	0.48"	1.50"	0.12"	3.22"	MY29 Series (2) MRC840 (4) 644 Series (1) 444 Series (1) 81K Series (2)	W26VT (4) W26RT (4) X26RT (4)	W26VT (4) W26RT (4) X26RT (4)	U26RT (2)	Black	13	1-9/16"
YA262NT14E1			1/4"	1"	0.48"	1.50"	0.12"	3.59"							
YA262NT516			5/16"	1"	0.52"	1.50"	0.13"	3.66"							
YA262NT38			3/8"	1"	0.62"	1.50"	0.13"	3.78"							
YA272NT14	3/0 AWG	85	1/4"	5/8"	0.60"	1.50"	0.13"	3.26"	MY29 Series (2) MRC840 (4) 644 Series (1) 444 Series (1) 81K Series (2)	W27VT (4) W27RT (4) X27RT (6)	W27VT (4) W27RT (4) X27RT (6)	U27RT (2)	Orange	14	1-9/16"
YA272NT516			5/16"	1"	0.60"	1.50"	0.13"	3.70"							
YA272NT38			3/8"	1"	0.76"	1.50"	0.13"	3.82"							
YA282NT14	4/0 AWG	107	1/4"	5/8"	0.76"	1.62"	0.14"	3.42"	MY29 Series (2) MRC840 (4) 644 Series (1) 444 Series (1) 81K Series (2)	W28VT (4) W28RT (4) X28RT (6)	W28VT (4) W28RT (4) X28RT (6)	U28RT (2)	Purple	15	1-11/16"
YA282NT516			5/16"	1"	0.76"	1.62"	0.14"	3.86"							
YA282NT38			3/8"	1"	0.76"	1.62"	0.10"	3.99"							
YA292NT14	250 kcmil	127	1/4"	5/8"	0.76"	1.62"	0.16"	3.49"	MY29 Series (2) 644 Series (1) 444 Series (1) 81K Series (2)	W29VT (4) X29RT (8)	W29VT (4) W29RT (4) X29RT (8)	U29RT (2)	Yellow	16	1-11/16"
YA292NT516			5/16"	1"	0.76"	1.62"	0.16"	3.90"							
YA292NT38			3/8"	1"	0.76"	1.62"	0.16"	4.02"							
YA292NT38E16			3/8"	1-3/4"	0.76"	1.62"	0.16"	4.77"							
YA292NNT			1/2"	1-3/4"	0.96"	1.62"	0.16"	5.21"							
YA302NT38	300 kcmil	152 150	3/8"	1"	0.52"	2.00"	0.13"	3.66"	644 Series (1) 444 Series (1) 81K Series (3)	W30VT (4)	W30VT (4) W30RT (4)	U30RT (4) U28ART (4)	White	17 or 298	2-1/16"

* Use PUADP1 adapter with U dies in 46 Series

*** The MM² conductor sizes listed are the recommendations for Class 2 conductor

▲ See tooling section of this catalog for complete tool and die listings. Use ONLY color-coded die recommendations for -FX connectors. For nest/indentor system contact factory.

◆ For applications greater than 2000 Volts consult cable manufacturer for voltage stress relief instructions.

Note: All dimensions shown are for reference only.

Compression Connections

Copper Compression — Code — Two Hole
Narrow Tongue, Long Barrel — No Inspection Window

TYPE YA-2NT (Continued)

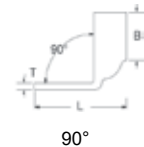
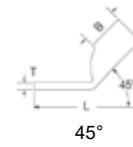
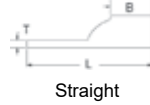

NOTE: Field bending straight lugs to achieve an angular connection will void UL Listing / CSA Certifications and BURNDY will not be liable for the connection.

Catalog Number	Conductor		Stud Hole Size	Stud Hole Spacing	Tongue Width	Figure Dimensions			▲ Installation Tooling					Wire Strip Length	
	AWG	*** MM ²				(B)	(T)	(L)	Dieless (# of crimps)	MD6, OUR840, MD734R	500 Series	35, 750, 46* Series	Color Code		Die Index
YA312NT38	350 kcmil	177 185	3/8"	1"	0.96"	2.00"	0.18"	4.48"	644 Series (1) 444 Series (1) 81K Series (3)	W31VT (4)	W31VT (4) W31RT (4)	U31RT (4) U29ART (4)	Red	18 or 324	2-1/16"
YA312NT38E16			3/8"	1-3/4"	0.96"	2.00"	0.18"	5.24"							
YA322NT38	400 kcmil	203	3/8"	1"	0.96"	2.12"	0.19"	4.66"	644 Series (1) 444 Series (1) 81K Series (3)	W32VT (4)	W32VT (4) W32RT (4)	U32RT (4) U30ART (4)	Blue	19 or 470	2-3/16"
YA322NNT			1/2"	1-3/4"	0.96"	2.00"	0.18"	5.24"							
YA342NT38	500 kcmil	253 240	3/8"	1"	0.96"	2.25"	0.23"	4.90"	644 Series (1) 444 Series (1) 81K Series (4)	W34VT (4)	W34VT (4) W34RT (4)	U34RT (4) U31ART (2)	Brown	20 or 299	2-5/16"
YA342NT38E16			3/8"	1-3/4"	0.96"	2.25"	0.23"	4.90"							
YA342NNT			1/2"	1-3/4"	0.76"	2.25"	0.23"	6.08"							
YA342NT58			5/8"	1-3/4"	1.29"	2.25"	0.23"	6.15"							
YA362NT38	600 kcmil	304 300	3/8"	1-3/4"	1.12"	2.69"	0.26"	6.59"	644 Series (1) 444 Series (1) 81K Series (4)	-	-	U36RT (4) U32ART (4)	Green	22 or 472	2-3/4"
YA362NNT			1/2"	1-3/4"	1.47"	2.69"	0.27"	6.59"							
YA362NT12			1/2"	1-3/4"	1.12"	2.69"	0.26"	6.59"							
YA392NT38	750 kcmil	380	3/8"	1"	1.12"	2.88"	0.16"	5.87"	644 Series (1) 444 Series (1) 81K Series (4)	-	-	U39RT (4) P39RT (4)	Black	24	2-15/16"
YA392NT38E16			3/8"	1-3/4"	1.12"	2.88"	0.16"	6.43"							
YA392NNT			1/2"	1-3/4"	1.63"	2.88"	0.26"	6.87"							
YA392ENNT			1/2"	1-3/4"	1.30"	2.88"	0.26"	6.87"							
YA392NT58			5/8"	1-3/4"	1.30"	2.88"	0.26"	6.93"							

* Use PUADP1 adapter with U dies in 46 Series

*** The MM² conductor sizes listed are the recommendations for Class 2 conductor

▲ See tooling section of this catalog for complete tool and die listings. Use ONLY color-coded die recommendations for -FX connectors. For nest/indenter system contact factory.

◆ For applications greater than 2000 Volts consult cable manufacturer for voltage stress relief instructions.

Note: All dimensions shown are for reference only.

TYPES YAZ-2N, YAZ-2TC

HYLUG™

Uninsulated Copper Compression Terminal
UL Listed 90° C, Up to 35 kV ♦

45° and 90° angles available. Please contact Customer Service to order:
1-800-346-4175

Features & Benefits

- Inspection window allows for visual verification that the wire has been fully inserted prior to crimping the lug
- Barrel is designed with an internal chamfer at the wire entry to ensure smooth insertion of the wire, preventing possible damaging of the strands
- Long barrel allows for an increased number of crimps which will increase the mechanical strength of the connection
- Two hole tongue/tang is recommended when space permits as the 2-hole feature minimizes the terminations from loosening or rotating under vibration, movement, or heat cycling
- 45° and 90° angular lugs are available; please contact Customer Service
- Electro-tin plated unless otherwise specified to reduce galvanic corrosion (bimetallic) and resist corrosive elements
- Connectors are clearly marked with stamping and barrel color coding
- BURNDY certifies its products using the BURNDY Engineered System and select other crimp tool manufacturers in accordance with one or more of the UL categories in order to obtain a UL Listing
- Terminals and splices accommodating code wire: Accommodates Code Class B (Concentric, Compressed, Compact) and Class C wire

Accessories

- Hardware - Section F
- PENETROX™ Oxide Inhibitor - Section F
- Heat and Cold Shrink Tubing - Section D
- WIREMIKE™ Wire Micrometer - Section F
- Wire Management (Cable Ties) - Section G

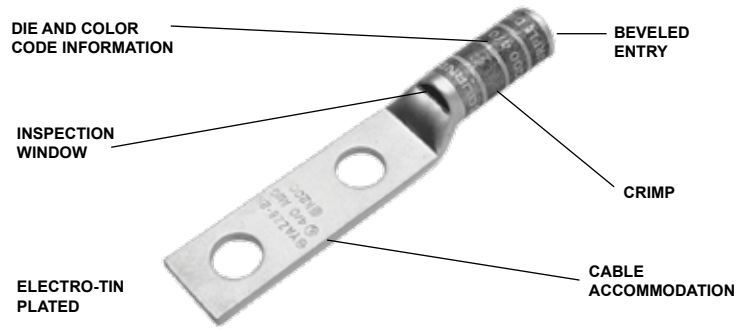

NOTE: Field bending straight lugs to achieve an angular connection will void UL Listing / CSA Certifications and BURNDY will not be liable for the connection.

Straight



45°



90°

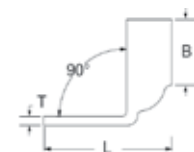

Compression Connections

Copper Compression — Code — Two Hole
Long Barrel — with Inspection Window

TYPES YAZ-2N, YAZ-2TC (Continued)

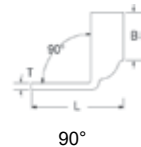
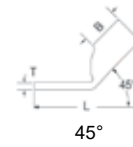
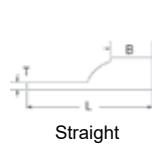

NOTE: Field bending straight lugs to achieve an angular connection will void UL Listing / CSA Certifications and BURNDY will not be liable for the connection.

Catalog Number	Conductor		Stud Hole Size	Stud Hole Spacing	Tongue Width	Figure Dimensions			Installation Tooling						Wire Strip Length					
	AWG	MM ² ***				(B)	(T)	(L)	Dieless (# of crimps)	MD6, OUR840, MD734R	500 Series	35, 750, 46* Series	Color Code	Die Index						
YAZV102TC14	14-10 AWG	5.26	1/4	5/8"	0.41	0.69	0.05	2.16	MR20 (2) Y8MRB1 (2) Y122CMR (2)	—	—	—	—	—	3/4					
YAZV102TC14E2			1/4	3/4"	0.41	0.69	0.05	2.28	—	—	—	—	—	—	—					
YAZ8C2TC10	#8 AWG #8 Flex G,H,I,K,M DLO	8.37 † 10	#10	5/8"	0.41	0.75	0.08	2.07	Y122CMR (2) Y1MRTC (2) Y8MRB1 (2) MY29 Series (2) MRC840 (2) 81K Series (1)	W8CVT (2) W8CRT (2) X8CRT (2)	W8CVT (2) W8CRT (2) X8CRT (2)	U8CRT (2)	Red	49	7/8					
YAZ8C2TC10E2			#10	3/4"	0.41	0.75	0.08	2.19	—							—	—	—	—	—
YAZ8C2TC14			1/4	5/8"	0.44	0.75	0.08	2.19	—							—	—	—	—	—
YAZ8C2TC14E2			1/4	3/4"	0.44	0.75	0.08	2.32	—							—	—	—	—	—
YAZ8C2TC14E1			1/4	1"	0.44	0.75	0.08	2.57	—							—	—	—	—	—
YAZ8C2TC38			3/8	1"	0.58	0.75	0.06	2.76	—							—	—	—	—	—
YAZ6C2TC10E2			#6 AWG Sol/Str	13.3	#10	3/4"	0.42	1.12	0.09							2.65	Y122CMR (2) MY29 Series (2) MRC840 (2) Y1MRTC (2) 81K Series (1)	W5CVT (2) W5CRT (2) X5CRT (2) X8CART (2)	W5CVT (2) W5CRT (2) X5CRT (2) X8CART (2)	U5CRT (2) U8CABT (2)
YAZ6C2TC14	1/4	5/8"			0.45	1.12	0.08	2.65	—	—	—	—	—							
YAZ6C2TC14E2	1/4	3/4"			0.45	1.12	0.08	2.78	—	—	—	—	—							
YAZ6C2TC14E1	1/4	1"			0.45	1.12	0.08	3.03	—	—	—	—	—							
YAZ6C2TC38E2	3/8	3/4"			0.58	1.12	0.06	2.97	—	—	—	—	—							
YAZ6C2TC38E6	3/8	7/8"			0.58	1.12	0.06	3.09	—	—	—	—	—							
YAZ6C2TC38	3/8	1"			0.58	1.12	0.06	3.22	—	—	—	—	—							
YAZ6C2TC38E16	3/8	1-3/4"			0.58	1.12	0.06	3.97	—	—	—	—	—							
YAZ6C2N	1/2	1-3/4"			0.83	1.12	0.12	4.40	—	—	—	—	—							
YAZ5C2N	#5 AWG	—	1/2	1-3/4"	0.83	1.12	0.12	4.43	W5CRT (2) W5CVT (2) X5CRT (2)	W5CVT (2) W5CRT (2) X5CRT (2)	U5CRT (2)	Blue	7 or 374	1-3/16						
YAZ4C2TC10E2	#4 AWG	21.2	#10	3/4"	0.50	1.12	0.09	2.67	Y122CMR (4) Y1MRTC (4) MY29 Series (2) MRC840 (2) 644 Series (1) 444 Series (1) 81K Series (2)	W4CVT (2) X4CRT (2) X4CRT (2)	W4CVT (2) W4CRT (2) X4CRT (2)	U4CRT (2) U6CABT (2)	Gray	8 or 346	1-3/16					
YAZ4C2TC14			1/4	5/8"	0.50	1.12	0.09	2.67								—	—	—	—	—
YAZ4C2TC14E2			1/4	3/4"	0.50	1.12	0.09	2.80								—	—	—	—	—
YAZ4C2TC38			3/8	1"	0.58	1.12	0.08	3.23								—	—	—	—	—
YAZ4C2N			1/2	1-3/4"	0.83	1.12	0.12	4.45								—	—	—	—	—
YAZ3C2TC14	#3 AWG #2 Sol	26.7 25	1/4	5/8"	0.55	1.25	0.09	2.83	Y122CMR (4) Y1MRTC (4) MY29 Series (2) MRC840 (2) 644 Series (1) 444 Series (1) 81K Series (2)	W3CRT (2)	W3CRT (2)	U3CRT (2)	White	9	1-5/16					
YAZ3C2TC14E2			1/4	3/4"	0.55	1.25	0.09	2.95								—	—	—	—	—
YAZ3C2TC38E2			3/8	3/4"	0.58	1.25	0.08	3.14								—	—	—	—	—
YAZ3C2TC38			3/8	1"	0.58	1.25	0.08	3.39								—	—	—	—	—
YAZ3C2N	1/2	1-3/4"	0.83	1.25	0.12	4.62	—	—	—	—	—									
YAZ2C2TC10E2	#2 AWG	33.6 35	#10	3/4"	0.60	1.25	0.11	2.85	Y122CMR (4) Y1MRTC (4) MY29 Series (2) MRC840 (2) 644 Series (1) 444 Series (1) 81K Series (2)	W2CVT (2) W2CRT (2) X2CRT (2)	W2CVT (2) W2CRT (2) X2CRT (2)	U2CRT (2)	Brown	10	1-5/16					
YAZ2C2TC14			1/4	5/8"	0.60	1.25	0.11	2.85								—	—	—	—	—
YAZ2C2TC14E2			1/4	3/4"	0.60	1.25	0.11	2.97								—	—	—	—	—
YAZ2C2TC14E1			1/4	1"	0.60	1.25	0.11	3.22								—	—	—	—	—
YAZ2C2TC516E7			5/16	.63	0.60	1.25	0.11	2.91								—	—	—	—	—
YAZ2C2TC516E2			5/16	3/4"	0.60	1.25	0.11	3.03								—	—	—	—	—
YAZ2C2TC38E2			3/8	3/4"	0.60	1.25	0.11	3.16								—	—	—	—	—
YAZ2C2TC38E6			3/8	7/8"	0.60	1.25	0.11	3.28								—	—	—	—	—
YAZ2C2TC38			3/8	1"	0.60	1.25	0.11	3.41								—	—	—	—	—
YAZ2C2NTC38			3/8	1-3/4"	0.60	1.25	0.11	4.16								—	—	—	—	—
YAZ2C2N			1/2	1-3/4"	0.83	1.25	0.12	4.64								—	—	—	—	—

* Use PUADP1 adapter with U dies in 46 Series

*** The MM² conductor sizes listed are the recommendations for Class 2 conductor

▲ See tooling section of this catalog for complete tool and die listings.

◆ For applications greater than 2000 Volts consult cable manufacturer for voltage stress relief instructions.

Note: All dimensions shown are for reference only.

TYPES YAZ-2N, YAZ-2TC (Continued)

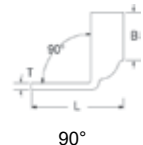
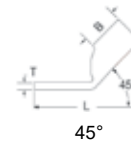
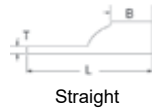

NOTE: Field bending straight lugs to achieve an angular connection will void UL Listing / CSA Certifications and BURNDY will not be liable for the connection.

Catalog Number	Conductor		Stud Hole Size	Stud Hole Spacing	Tongue Width	Figure Dimensions			Installation Tooling						Wire Strip Length
	AWG	MM ² ***				(B)	(T)	(L)	Dieless (# of crimps)	MD6, OUR840, MD734R	500 Series	35, 750, 46* Series	Color Code	Die Index	
YAZ1C2TC14	#1 AWG	42.4 50	1/4	5/8"	0.67	1.38	0.10	3.01	Y1MRTC (4) MY29 Series (2) MRC840 (2) 644 Series (1) 444 Series (1) 81K Series (2)	W1CVT (2) W1CRT1 (2) X1CRT1 (2)	W1CVT (2) W1CRT1 (2) X1CRT1 (2)	U1CRT1 (2) U4CABT (2)	Green	11 or 375	1-7/16
YAZ1C2TC14E2			1/4	3/4"	0.67	1.38	0.10	3.13							
YAZ1C2TC38			3/8	1"	0.67	1.38	0.10	3.57							
YAZ1C2N			1/2	1-3/4"	0.83	1.38	0.12	4.82							
YAZ252TC14	1/0 AWG	53.5	1/4	5/8"	0.75	1.38	0.12	3.04	MY29 Series (2) MRC840 (4) 644 Series (1) 444 Series (1) 81K Series (2)	W25RT (4) W25VT (4) X25RT (4)	W25VT (4) W25RT (4) X25RT (4)	U25RT (2) U2CABT (2)	Pink	12 or 348	1-7/16
YAZ252TC14E2			1/4	3/4"	0.75	1.38	0.12	3.16							
YAZ252TC14E1			1/4	1"	0.75	1.38	0.12	3.41							
YAZ252TC14E3			1/4	1.00	0.75	1.38	0.12	3.42							
YAZ252TC516E6			5/16	7/8"	0.75	1.38	0.12	3.35							
YAZ252TC516			5/16	1"	0.75	1.38	0.12	3.47							
YAZ252TC38			3/8	1"	0.75	1.38	0.12	3.60							
YAZ252NTC38			3/8	1-3/4"	0.75	1.38	0.12	4.35							
YAZ252N			1/2	1-3/4"	0.83	1.38	0.11	4.79							
YAZ262TC14			2/0 AWG	67.4 70	1/4	5/8"	0.83	1.50							
YAZ262TC14E2	1/4	3/4"			0.83	1.50	0.12	3.32							
YAZ262TC14E1	1/4	1.00			0.83	1.50	0.12	3.57							
YAZ262TC38	3/8	1"			0.83	1.50	0.12	3.76							
YAZ262TC38E16	3/8	1-3/4"			0.83	1.50	0.12	4.51							
YAZ262N	1/2	1-3/4"			0.83	1.50	0.12	4.95							
YAZ272TC14E2	3/0 AWG	85	1/4	3/4"	0.90	1.50	0.12	3.36	MY29 Series (2) MRC840 (4) 644 Series (1) 444 Series (1) 81K Series (2)	W27VT (4) W27RT (4) X27RT (6)	W27VT (4) W27RT (4) X27RT (6)	U27RT (2)	Orange	14	1-9/16
YAZ272TC38			3/8	1"	0.90	1.50	0.12	3.80							
YAZ272N			1/2	1-3/4"	0.91	1.50	0.12	4.98							
YAZ282TC14E2	4/0 AWG	107	1/4	3/4"	1.02	1.62	0.14	3.55	MY29 Series (2) MRC840 (4) 644 Series (1) 444 Series (1) 81K Series (2)	W28VT (4) W28RT (4) X28RT (6)	W28VT (4) W28RT (4) X28RT (6)	U28RT (2)	Purple	15	1-11/16
YAZ282TC38			3/8	1"	1.02	1.62	0.14	3.99							
YAZ282NTC38			3/8	1-3/4"	1.02	1.62	0.14	4.74							
YAZ282N			1/2	1-3/4"	1.02	1.62	0.14	5.15							
YAZ292TC38	250 kcmil	127	3/8	1"	1.10	1.62	0.14	3.99	MY29 Series (2) MRC840 (4) 644 Series (1) 444 Series (1) 81K Series (2)	W29VT (4) W29RT (8)	W29VT (4) W29RT (4) X29RT (8)	U29RT (2)	Yellow	16	1-11/16
YAZ292N			1/2	1-3/4"	1.10	1.62	0.16	5.18							
YAZ302TC38	300 kcmil	152 150	3/8	1"	1.20	2.00	0.16	4.42	644 Series (1) 444 Series (1) 81K Series (3)	W30VT (4)	W30VT (4) W30RT (4)	U30RT (4) U28ART (4)	White	17 or 298	2-1/16
YAZ302N			1/2	1-3/4"	1.20	2.00	0.16	5.60							
YAZ312TC14E2	350 kcmil	177 185	1/4	3/4"	1.29	2.00	0.18	4.02	644 Series (1) 444 Series (1) 81K Series (3)	W31VT (4)	W31VT (4) W31RT (4)	U31RT (4) U29ART (4)	Red	18 or 324	2-1/16
YAZ312TC38			3/8	1"	1.29	2.00	0.18	4.45							
YAZ312N			1/2	1-3/4"	1.29	2.00	0.18	5.64							
YAZ322TC38	400 kcmil	203	3/8	1"	1.40	2.12	0.19	4.62	644 Series (1) 444 Series (1) 81K Series (3)	W32VT (4)	W32VT (4) W32RT (4)	U32RT (4) U30ART (4)	Blue	19 or 470	2-3/16
YAZ322N			1/2	1-3/4"	1.40	2.12	0.19	5.81							

* Use PUADP1 adapter with U dies in 46 Series

*** The MM² conductor sizes listed are the recommendations for Class 2 conductor

▲ See tooling section of this catalog for complete tool and die listings.

◆ For applications greater than 2000 Volts consult cable manufacturer for voltage stress relief instructions.

Note: All dimensions shown are for reference only.

Compression Connections

Copper Compression — Code — Two Hole
Long Barrel — with Inspection Window

TYPES YAZ-2N, YAZ-2TC (Continued)

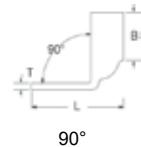
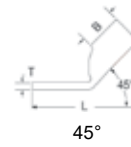
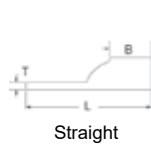

NOTE: Field bending straight lugs to achieve an angular connection will void UL Listing / CSA Certifications and BURNDY will not be liable for the connection.

Catalog Number	Conductor		Stud Hole Size	Stud Hole Spacing	Tongue Width	Figure Dimensions			Installation Tooling						Wire Strip Length							
	AWG	MM ² ***				(B)	(T)	(L)	Dieless (# of crimps)	MD6, OUR840, MD734R	500 Series	35, 750, 46* Series	Color Code	Die Index								
YAZ332N	450 kcmil	—	1/2	1-3/4	1.48	2.12	0.21	5.89	644 Series (1) 444 Series (1) 81K Series (4)	W33VT (4)	W33RT (4)	U33RT (4)	Gray	326 or 538	2-5/16							
YAZ342TC14E2	500 kcmil	253 240	1/4	3/4"	1.55	2.25	0.23	4.42		W34VT (4)	W34RT (4)	U34RT (4)	Brown	20 or 299	2-5/16							
YAZ342TC38			3/8	1"	1.55	2.25	0.23	4.85		U31ART (4)												
YAZ342N			1/2	1-3/4"	1.55	2.25	0.23	6.04														
YAZ352N	550 kcmil	—	1/2	1-3/4"	1.65	2.62	0.25	6.45		—	—	U35RT (4)	Yellow	21	2-11/16							
YAZ362TC38	600 kcmil	304 300	3/8	1"	1.74	2.69	0.26	5.55		—	—	U36RT (4)	Green	22 or 472	2-3/4							
YAZ362N			1/2	1-3/4"	1.74	2.69	0.26	6.55		U32ART (4)												
YAZ372N	650 kcmil	—	1/2	1-3/4"	1.80	2.81	0.27	6.70		—	—	U37RT (4)	Orange	23	2-7/8							
YAZ382N	700 kcmil	355	1/2	1-3/4"	1.84	2.81	0.27	6.72		—	—	U38RT (4)	Pink	400	2-7/8							
YAZ392NT38	750 kcmil	380	3/8	1"	1.63	2.88	0.27	5.82		—	—	—	P40RT (4)**	Orange	25	3						
YAZ392TC38			3/8	1"	1.91	2.88	0.27	5.82														
YAZ392N			1/2	1-3/4"	1.91	2.88	0.27	6.82									U39RT (4)	P39RT (4)**	Black	24	2-15/16	
YAZ392NNT			1/2	1-3/4"	1.63	2.88	0.27	6.82														
YAZ402N	800 kcmil	405 400	1/2	1-3/4"	1.98	2.94	0.30	6.89									—	—	—	Gold	26	3
YAZ412N	850 kcmil	—	1/2	1-3/4"	2.01	2.94	0.31	6.91	—								—	—	Gold	26	3	
YAZ442TC38	1000 kcmil	507 500	3/8	1"	2.19	3.00	0.33	6.09	—								—	—	White	27	3-1/16	
YAZ442N			1/2	1-3/4"	2.19	3.00	0.33	7.08	—								—	—	White	27	3-1/16	
YAZ452N	1250 kcmil	633	1/2	1-3/4"	2.46	3.19	0.38	7.38	—								—	—	P45RT (6)**	Yellow	29	3-1/4
YAZ4532N	1300 kcmil	—	1/2	1-3/4"	2.53	3.19	0.39	7.41											—	Orange	30	2-1/16
YAZ462N	1500 kcmil	760	1/2	1-3/4"	2.69	3.19	0.40	7.48											P46RT (6)**	Green	31	3-5/16
YAZ472N	1750 kcmil	887	1/2	1-3/4"	2.90	3.44	0.42	7.82											—	Gray	33	3-1/2
YAZ482N	2000 kcmil	1010	1/2	1-3/4"	3.10	3.44	0.46	7.89											—	Brown	34	3-1/2

* Use PUADP1 adapter with U dies in 46 Series

*** The MM² conductor sizes listed are the recommendations for Class 2 conductor

▲ See tooling section of this catalog for complete tool and die listings.

◆ For applications greater than 2000 Volts consult cable manufacturer for voltage stress relief instructions.

Note: All dimensions shown are for reference only.

TYPES YA-4N, YAB-4N

HYLUG™



Uninsulated Copper Compression Terminal
UL Listed 90° C, Up to 35 kV ◆

45° and 90° angles available. Please contact Customer Service to order: 1-800-346-4175

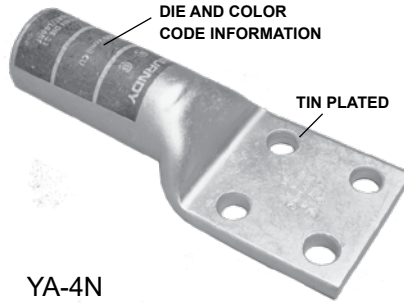

YA-4N

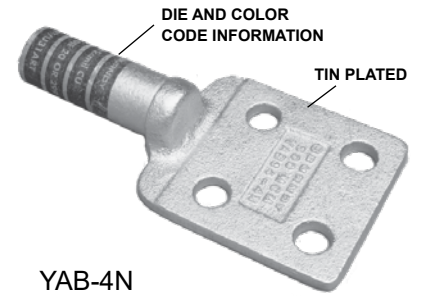

YAB-4N

Features & Benefits

- No inspection window is ideal for more corrosive environments as the barrel transition is not open
- Barrel is designed with an internal chamfer at the wire entry to ensure smooth insertion of the wire, preventing possible damaging of the strands
- Long barrel allows for an increased number of crimps which will increase the mechanical strength of the connection
- Four hole tongue/tang is recommended when space permits as the 4-hole feature minimizes the terminations from loosening or rotating under vibration, movement, or heat cycling
- 45° and 90° angular lugs are available; please contact Customer Service
- Electro-tin plated unless otherwise specified to reduce galvanic corrosion (bimetallic) and resist corrosive elements
- Connectors are clearly marked with stamping and barrel color coding
- BURNDY certifies its products using the BURNDY Engineered System and select other crimp tool manufacturers in accordance with one or more of the UL categories in order to obtain a UL Listing
- Terminals and splices accommodating code wire: Accommodates Code Class B (Concentric, Compressed, Compact) and Class C wire

NOTE: Field bending straight lugs to achieve an angular connection will void UL Listing / CSA Certifications and BURNDY will not be liable for the connection.

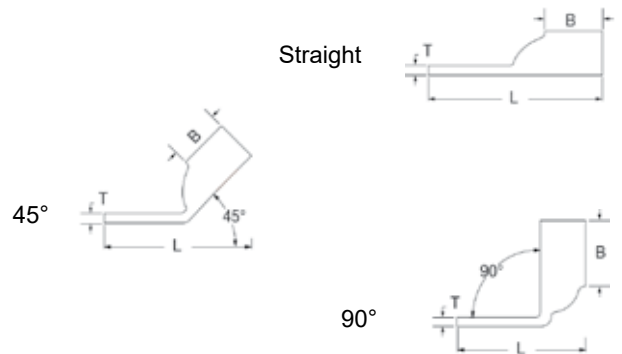

Accessories

- Hardware - Section F
- PENETROX™ Oxide Inhibitor - Section F
- Heat and Cold Shrink Tubing - Section D
- WIREMIKE™ Wire Micrometer - Section F
- Wire Management (Cable Ties) - Section G

Catalog Number	Conductor		Stud Hole Size	Stud Hole Spacing	Tongue Width	Tongue Angle	Installation Tooling						Wire Strip Length
	AWG	*** MM²					Barrel Length	Tongue Thickness	Length (Total)	Hydraulic (35, 750, 46* Series)			
										* **	Color Code	Die Index	
YAB344N	500 kcmil	—	1/2	1.75"	3.00	Straight	2.25	0.25	6.33	U34RT	Brown	20	2-5/16
YAB364N	600 kcmil	—	1/2	1.75"	3.00	Straight	2.69	0.25	6.79	U36RT	Green	22	2-3/4
YAB394N	750 kcmil	—	1/2	1.75"	3.00	Straight	2.88	0.25	7.15	U39RT	Black	24	2-15/16
YA444N	1000 kcmil	500	1/2	1.75"	3.00	Straight	3.00	0.23	7.14	P44RT	White	27	3-1/16
YA454N	1250 kcmil	—	1/2	1.75"	3.00	Straight	3.19	0.30	7.44	P45RT	Yellow	29	3-1/4
YA464N	1500 kcmil	—	1/2	1.75"	3.00	Straight	3.19	0.34	7.55	P46RT	Green	31	3-1/4
YA474N	1750 kcmil	—	1/2	1.75"	2.90	Straight	3.44	0.39	7.89	‡L47RT	Gray	33	3-1/2
YA484N	2000 kcmil	—	1/2	1.75"	3.10	Straight	3.44	0.46	7.98	‡L48RT	Brown	34	3-1/2
YA4864N	2500 kcmil	—	1/2	1.75"	3.46	Straight	4.69	0.52	9.38	‡L486RT	—	—	4-3/4

* Use PUADP1 adaptor with U dies in 46 Series

** P dies for use with 46 Series only. PUADP1 adaptor not required

*** The MM² conductor sizes listed are for Class 2 conductor. For applications greater than 2000 Volts, consult cable manufacturer for voltage stress relief instructions

‡ Requires 60 Series Tools

▲ Not UL Listed

Available undrilled. Add suffix U to catalog number (example YA444NU)

Note: All dimensions shown are for reference only

Copper Wire Table									
*Terminal Designation	Barrel O.D. (IN)	Code	Flexible Nominal Wire Size / Wire Classes / Wire Class Stranding					DLO	
		Class B, C	Flex Size (Nominal)	G	H	I	K		M
**YAV10	0.21	#14 - #10 AWG	#14 - #10 AWG	—	—	26/24	104/30	259/34	27/24
**YA8C	0.27	#8 AWG	#8 AWG	49	133	41/24	168/30	420/34	37/24
YAV6C	0.31	#6 AWG	#6 AWG	49	133	63/24	266/30	655/34	61/24
YA5C	0.30	#5 AWG	#5 AWG	49	133	84/24	336/30	836/34	91/24
YAV4C	0.38	#4 AWG	#4 AWG	49	133	105/24	420/30	1064/34	105/24
YAV3C	0.42	#3 AWG	#3 AWG	49	133	133/24	532/30	1323/34	125/24
YAV2C	0.46	#2 AWG	#2 AWG	49	133	161/24	665/30	1666/34	150/24
YAV1C	0.51	#1 AWG	#1 AWG	133	259	210/24	835/30	2107/34	225/24
YAV25-FX	0.56	1/0 AWG	1/0 AWG	133	259	226/24	1064/30	2646/34	275/24
YAV26-FX	0.63	2/0 AWG	2/0 AWG	133	259	342/24	1323/30	3325/34	325/24
YAV27-FX	0.70	3/0 AWG	3/0 AWG	133	259	418/24	1666/30	4256/34	450/24
YAV28-FX	0.77	4/0 AWG	4/0 AWG	133	427	532/24	2107/30	5320/34	550/24
YAV29	0.80	250 kcmil	4/0	(4/0 AWG) 133	(4/0 AWG) 427	(4/0 AWG) 532/24	(4/0 AWG) 2107/30	(4/0 AWG) 5320/34	(4/0 AWG) 550/24
YA30-FX	0.81	—	250 kcmil	259	427	—	—	—	—
YA31-FX	0.88	—	250 kcmil	—	—	637/24	2499/30	6348/34	262
YA32-FX	0.95	—	300 kcmil	259	427	735/24	2989/30	7581/34	313
YA34-FX	1.06	—	350 kcmil	259	427	882/24	3458/30	8806/34	373
YA36-FX	1.19	—	500 kcmil	259	427	—	—	—	444
YA38-FX	1.25	—	500 kcmil	—	427	1225/24	5054/30	—	535
		—	550 kcmil	427	703	1372/24	—	—	
YA39-FX	1.30	—	600 kcmil	427	703	1470/24	5985/30	—	1470/24
YA40-FX	1.35	—	650 kcmil	427	—	—	—	—	646
YA44-FX	1.50	—	750 kcmil	427	703	1862	—	—	777
YA46-FX	1.84	—	1000 kcmil	—	—	—	—	—	1111

*Catalog Number with suffix "FX" denote connectors that accommodate Copper Flexible Wire

TYPES YA-L, YA-L-FX, YAV, YAV-L-FX

HYLUG™

Uninsulated Copper Compression Terminal
UL Listed 90° C, Up to 35 kV ♦

45° and 90° angles available. Please contact Customer Service to order: 1-800-346-4175

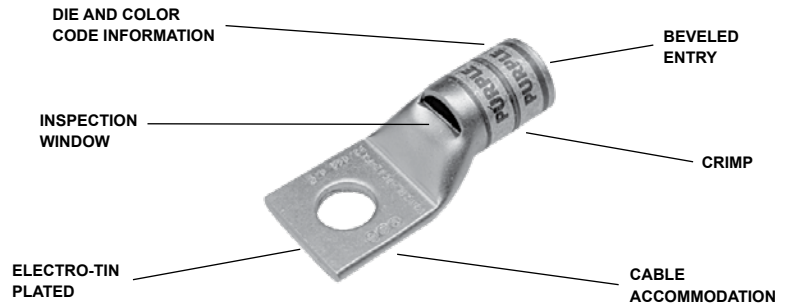

Features & Benefits

- Inspection windows allows for visual verification that the wire has been fully inserted prior to crimping the lug
- Barrel is designed with an internal chamfer at the wire entry to ensure smooth insertion of the wire, preventing possible damaging of the strands
- Short/Standard length barrel is recommended for installations with limited space requirements
- 45° and 90° angular lugs are available; please contact Customer Service
- Electro-tin plated unless otherwise specified to reduce galvanic corrosion (bimetallic) and resist corrosive elements
- Connectors are clearly marked with stamping and barrel color coding
- Connectors accommodating wire sizes #10 - 4/0 AWG accommodate both Flex and Code Wire. See Tables on each page for specific details
- Tables in this section identify flex wire as the nominal flex wire size followed by the wire classes and DLO wire size and stranding. For Class Wire Strand counts, see the table at the beginning of this section.
- BURNDY certifies its products using the BURNDY Engineered System and select other crimp tool manufacturers in accordance with one or more of the UL categories in order to obtain a UL Listing



NOTE: Field bending straight lugs to achieve an angular connection will void UL Listing / CSA Certifications and BURNDY will not be liable for the connection.

Accessories

- Hardware - Section F
- PENETROX™ Oxide Inhibitor - Section F
- Heat and Cold Shrink Tubing - Section D
- WIREMIKE™ Wire Micrometer - Section F
- Wire Management (Cable Ties) - Section G

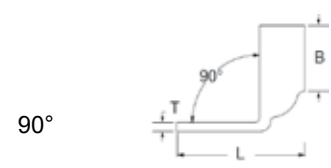
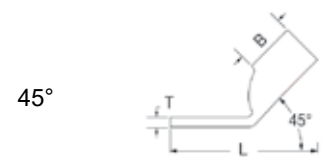

Compression Connections

Copper Compression — Flex — One Hole
Standard Barrel — with Inspection Window

TYPES YA-L, YA-L-FX, YAV, YAV-L-FX (Continued)

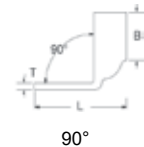
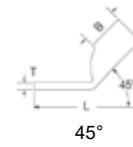
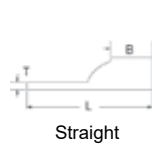

NOTE: Field bending straight lugs to achieve an angular connection will void UL Listing / CSA Certifications and BURNDY will not be liable for the connection.

Catalog Number	Conductor		Stud Hole Size	Tongue Width	Figure Dimensions			Installation Tooling						Wire Strip Length	
	AWG/KCMIL	MM ² ***			(B)	(T)	(L)	Dieless (# of crimps)	MD6, OUR840, MD734R	500 Series	35, 750, 46* Series	Color Code	Die Index		
YA8CLBOX	#8 AWG G,H,I,K,M, DLO	** 10	#8 - #10	0.41	0.44	0.08	1.16	Y122CMR (1) Y1MRTC (1)	W8CVT (1) W8CRT (1) X8CRT (1)	W8CVT (1) W8CRT (1) X8CRT (1)	U8CRT (1)	Red	49	7/16	
YA8CL1BOX			1/4	0.44	0.44	0.08	1.26	MY29 Series (1)							
YA8CL2BOX			5/16	0.52	0.44	0.06	1.38	MRC840 (1)							
YA8CL3BOX			3/8	0.58	0.44	0.06	1.51	4PC Series (1)							
YA8CL4BOX	#6 Sol #8 Sol		1/2	0.71	0.44	0.05	1.76	Y8MRB1 (1) 81K Series (1)							
YAV6CLTC10FX	#6 AWG #6 Flex G,H,I,K,M, DLO	** 16	#10	0.48	0.50	0.08	1.30	Y122CMR (1) Y1MRTC (1)	W5CVT (1) W5CRT (1) X5CRT (1)	W5CVT (1) W5CRT (1) X5CRT (1)	U5CRT (1)	Blue	7	1/2	
YAV6CLTC14FX			1/4	0.48	0.50	0.08	1.43	MY29 Series (1)							
YAV6CLTC516FX			5/16	0.52	0.50	0.07	1.49	MRC840 (1)							
YAV6CLTC38FX			3/8	0.58	0.50	0.06	1.61	Y8MRB1 (1)							
YAV6CLTC12FX			1/2	0.75	0.50	0.12	1.86	81K Series (1)							
YAV6CLTC34FX			3/4	1.04	0.50	0.09	2.66								
YAV4CLTC10FX	#4 AWG #4 Flex G,H,I,K,M, DLO	—	#10	0.55	0.50	0.09	1.32	Y122CMR (1) MY29 Series (1) 4PC Series (1) 81K Series (1)	W4CVT (1) W4CRT (1) X4CRT (1)	W4CVT (1) W4CRT (1) X4CRT (1)	U4CRT (1)	Gray	8	1/2	
YAV4CLTC14FX			1/4	0.55	0.50	0.09	1.44								
YAV4CLTC516FX			5/16	0.55	0.50	0.09	1.51								
YAV4CLTC38FX			3/8	0.58	0.50	0.08	1.67								
YAV4CLTC12FX			1/2	0.71	0.50	0.07	1.92								
YAV2CLTC10FX	#2 AWG #2 Flex G,H,I,K,M, DLO	35	#10	0.68	0.63	0.10	1.50	Y122CMR (1) Y1MRTC (2)	W2CVT (1) W2CRT (1) X2CRT (1)	W2CVT (1) W2CRT (1) X2CRT (1)	U2CRT (1)	Brown	10	11/16	
YAV2CLTC14FX			1/4	0.68	0.63	0.10	1.62	644 Series (1)							
YAV2CLTC516FX			5/16	0.68	0.63	0.10	1.69	444 Series (1)							
YAV2CLTC38FX			3/8	0.68	0.63	0.10	1.81								
YAV2CLTC12FX			1/2	0.73	0.63	0.09	2.12								
YAV1CLTC10FX	#1 AWG #1 Flex G,H,I,K,M, DLO	—	#10	0.75	0.62	0.12	1.52	644 Series (1) 444 Series (1) MY29 Series (1) 81K Series (1) 4PC Series (1)	W1CVT (1) W1CRT1 (1) X1CRT1 (1)	W1CVT (1) W1CRT1 (1) X1CRT1 (1)	U1CRT1 (1)	Green	11	11/16	
YAV1CLTC14FX			1/4	0.75	0.62	0.12	1.65								
YAV1CLTC516FX			5/16	0.75	0.62	0.12	1.71								
YAV1CLTC38FX			3/8	0.75	0.62	0.12	1.84								
YAV1CLTC12FX			1/2	0.75	0.62	0.12	2.09								
YAV25LTC14FX	1/0 AWG 1/0 Flex G,H,I,K,M, DLO	50	1/4	0.83	0.69	0.12	1.75	644 Series (1) 444 Series (1) MY29 Series (1) 81K Series (1)	W25VT (2) W25RT (2) X25RT (2)	W25VT (2) W25RT (2) X25RT (2)	U25RT (1)	Pink	12	11/16	
YAV25LTC516FX			5/16	0.83	0.69	0.12	1.81								
YAV25LTC38FX			3/8	0.83	0.69	0.12	1.94								
YAV25LTC12FX			1/2	0.83	0.69	0.12	2.19								
YAV26LTC10FX	2/0 AWG 2/0 Flex G,H,I,K,M, DLO	70	#10	0.93	0.81	0.13	1.80	4PC Series (1)	W26VT (2) W26RT (2) X26RT (2)	W26VT (2) W26RT (2) X26RT (2)	U26RT (1)	Black	13	13/16	
YAV26LTC14FX			1/4	0.93	0.81	0.13	1.92								
YAV26LTC516FX			5/16	0.93	0.81	0.13	1.98								
YAV26LTC38FX			3/8	0.93	0.81	0.13	2.11								
YAV26LTC12FX			1/2	0.93	0.81	0.13	2.36								
YAV26LTC58FX			5/8	0.93	0.81	0.13	2.61								
YAV26LTC34FX	3/4	1.10	0.81	0.11	2.89										

* Use PUADP1 adapter with U dies in 46 Series

• P-RT dies for 46 Series Tooling only

** The MM² conductor size listed is for both Class 2 and Class 5 conductors

*** The MM² conductor sizes listed are the recommendations for Class 5 conductor

▲ See tooling section of this catalog for complete tool and die listings. Use only color-coded die recommendations for -FX connectors. For nest/indenter system contact factory

◆ For applications greater than 2000 Volts consult cable manufacturer for voltage stress relief instructions

Note: All dimensions shown are for reference only

TYPES YA-L, YA-L-FX, YAV, YAV-L-FX (Continued)

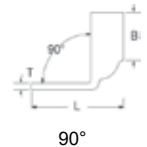
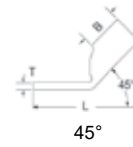
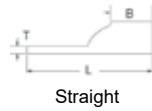

NOTE: Field bending straight lugs to achieve an angular connection will void UL Listing / CSA Certifications and BURNDY will not be liable for the connection.

Catalog Number	Conductor		Stud Hole Size	Tongue Width	Figure Dimensions			Installation Tooling					Wire Strip Length	
	AWG/KCMIL	MM ² ***			(B)	(T)	(L)	Dieless (# of crimps)	MD6, OUR840, MD734R	500 Series	35, 750, 46* Series	Color Code		Die Index
YAV27LTC10FX	3/0 AWG 3/0 Flex G,H,I,K,M, DLO	95	#10	1.03	1.00	0.14	2.03	644 Series (1)	W27VT (2) W27RT (2) X27RT (3)	W27VT (2) W27RT (2) X27RT (3)	U27RT (1)	Orange	14	1
YAV27LTC14FX			1/4	1.03	1.00	0.14	2.15	444 Series (1)						
YAV27LTC516FX			5/16	1.03	1.00	0.14	2.21	MY29 Series (1)						
YAV27LTC38FX			3/8	1.03	1.00	0.14	2.34	81K Series (1)						
YAV27LTC12FX			1/2	1.03	1.00	0.14	2.59	4PC Series (1)						
YAV28LTC14FX	4/0 AWG 4/0 Flex G,H,I,K,M, DLO	**	1/4	1.14	1.03	0.15	2.23	644 Series (1)	W28VT (2) W28RT (2) X28RT (3)	W28VT (2) W28RT (2) X28RT (3)	U28RT (1)	Purple	15	1-1/16
YAV28LTC516FX			5/16	1.14	1.03	0.15	2.29	444 Series (1)						
YAV28LTC38FX			3/8	1.14	1.03	0.15	2.42	MY29 Series (1)						
YAV28LTC12FX			1/2	1.14	1.03	0.15	2.67	81K Series (1)						
YAV28LTC58FX			5/8	1.14	1.03	0.15	2.92	4PC Series (1)						
YAV28LTC34FX	3/4	1.14	1.03	0.15	3.11									
YAV29LTC14FX	250 kcmil 4/0 Flex G,H,I,K,M, DLO	—	1/4	1.18	1.03	0.16	2.23	644 Series (1)	W29VT (2) X29RT (4)	W29VT (2) W29RT (2) X29RT (4)	U29RT (1)	Yellow	16	1-1/16
YAV29LTC516FX			5/16	1.18	1.03	0.16	2.30	444 Series (1)						
YAV29LTC38FX			3/8	1.18	1.03	0.16	2.42	MY29 Series (1)						
YAV29LTC12FX			1/2	1.18	1.03	0.16	2.67	81K Series (1)						
YAV29LTC58FX			5/8	1.18	1.03	0.16	2.92	4PC Series (1)						
YAV29LTC34FX	3/4	1.18	1.03	0.16	3.11									
YA30LTC516FX	250 kcmil G,H	—	5/16	1.20	1.03	0.16	2.31	644 Series (1)	W29VT (2) X29RT (4)	W29VT (2) W29RT (2) X29RT (4)	U29RT (1)	Yellow	16	1-1/8
YA30LTC38FX			3/8	1.20	1.03	0.16	2.44	444 Series (1)						
YA30LTC12FX			1/2	1.20	1.03	0.16	2.69	81K Series (1)						
YA30LTC58FX			5/8	1.20	1.03	0.16	2.94	4PC Series (1)						
YA30LTC34FX			3/4	1.20	1.03	0.16	3.12							
YA31LTC14FX	250 kcmil I,K,M, 262 DLO	150	1/4	1.29	1.06	0.18	2.31	644 Series (1)	W30VT (2)	W30VT (2) W30RT (2)	U30RT (2)	White	17 or 298	1-1/8
YA31LTC516FX			5/16	1.29	1.06	0.18	2.37	444 Series (1)						
YA31LTC38FX			3/8	1.29	1.06	0.18	2.50	81K Series (1)						
YA31LTC12FX			1/2	1.29	1.06	0.18	2.75	4PC Series (1)						
YA31LNT12FX			1/2	0.96	1.06	0.18	2.75							
YA31LTC58FX	5/8	1.29	1.06	0.18	3.00									
YA31LTC34FX	3/4	1.29	1.06	0.18	3.19									
YA32LTC38FX	300 kcmil G,H,I,K,M, 313 DLO	185	3/8	1.40	1.19	0.19	2.68	644 Series (1)	W31VT (2)	W31VT (2) W31RT (2)	U31RT (2)	Red	18 or 324	1-1/4
YA32LTC12FX			1/2	1.40	1.19	0.19	2.93	444 Series (1)						
YA32LTC58FX			5/8	1.40	1.19	0.19	3.18	81K Series (1)						
YA32LTC100FX			1	1.74	1.19	0.27	3.87	4PC Series (1)						
YA34LTC516FX	350 kcmil G,H,I,K,M, 373 DLO	240	5/16	1.55	1.27	0.23	2.74	644 Series (1)	W32VT (2)	W32VT (2) W32RT (2)	U32RT (2)	Blue	19 or 470	1-5/16
YA34LTC38FX			3/8	1.55	1.27	0.23	2.87	444 Series (1)						
YA34LTC12FX			1/2	1.55	1.27	0.23	3.12	81K Series (1)						
YA34LTC58FX			5/8	1.55	1.27	0.23	3.37	4PC Series (1)						
YA36LTC12FX	500 kcmil G,H 444 DLO	—	1/2	1.74	1.38	0.27	3.29	644 Series (1)	—	—	U34RT (2)	Brown	20 or 299	1-3/8
YA36LTC58FX			5/8	1.74	1.38	0.27	3.54	444 Series (1) 81K Series (2) 4PC Series (2)						

* Use PUADP1 adapter with U dies in 46 Series

** The MM² conductor size listed is for both Class 2 and Class 5 conductors

*** The MM² conductor sizes listed are the recommendations for Class 5 conductor

▲ See tooling section of this catalog for complete tool and die listings. Use only color-coded die recommendations for -FX connectors. For nest/indenter system contact factory

◆ For applications greater than 2000 Volts consult cable manufacturer for voltage stress relief instructions
Note: All dimensions shown are for reference only

Compression Connections

Copper Compression — Flex — One Hole
Long Barrel — with Inspection Window

TYPES YA-L, YA-L-FX, YAV, YAV-L-FX (Continued)

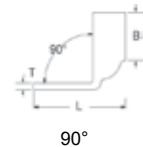
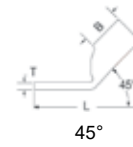
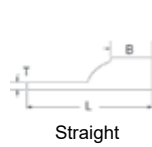

NOTE: Field bending straight lugs to achieve an angular connection will void UL Listing / CSA Certifications and BURNDY will not be liable for the connection.

Catalog Number	Conductor		Stud Hole Size	Tongue Width	Figure Dimensions			Installation Tooling					Wire Strip Length	
	AWG/KCMIL	MM ² ***			(B)	(T)	(L)	Dieless (# of crimps)	MD6, OUR840, MD734R	500 Series	35, 750, 46* Series	Color Code		Die Index
YA38LTC516FX	500 kcmil	300	5/16	1.84	1.45	0.27	3.03	644 Series (1) 444 Series (1) 81K Series (2) 4PC Series (2)	—	—	U38XRT (2)	Pink	L99	1-7/16
YA38LTC38FX	H,I,K		3/8	1.84	1.45	0.27	3.34							
YA38LTC12FX	550 kcmil		1/2	1.84	1.45	0.27	3.41							
YA38LTC58FX	G,H,I 535 DLO		5/8	1.84	1.45	0.27	3.66							
YA40LTC516FX	650 kcmil G, 646 DLO	400	5/16	1.98	1.42	0.30	3.05	644 Series (1) 444 Series (1) 81K Series (2) 4PC Series (2)	—	—	U39RT (2)	Black	24	1-5/16
YA40LTC38FX			3/8	1.98	1.42	0.30	3.38							
YA40LTC12FX			1/2	1.98	1.42	0.30	3.43							
YA40LTC58FX			5/8	1.98	1.42	0.30	3.68							
YA44LTC12FX	750 kcmil G,H,I 777 DLO	500	1/2	2.19	1.65	0.33	3.79	644 Series (1) 444 Series (1) 81K Series (2) 4PC Series (2)	—	—	U44XRT (2) *P44XRT (2)	Yellow	L115	1-5/8
YA44LTC58FX			5/8	2.19	1.65	0.33	4.04							

* Use PUADP1 adapter with U dies in 46 Series

• P-RT dies for 46 Series Tooling only

** The MM² conductor size listed is for both Class 2 and Class 5 conductors

*** The MM² conductor sizes listed are the recommendations for Class 5 conductor

▲ See tooling section of this catalog for complete tool and die listings. Use only color-coded die recommendations for -FX connectors. For nest/indenter system contact factory

◆ For applications greater than 2000 Volts consult cable manufacturer for voltage stress relief instructions

Note: All dimensions shown are for reference only

TYPE YAV-L-NTFX

HYLUG™

Uninsulated Copper Compression Terminal
UL Listed 90° C, Up to 35 kV ◆

45° and 90° angles available. Please contact Customer Service to order:
1-800-346-4175

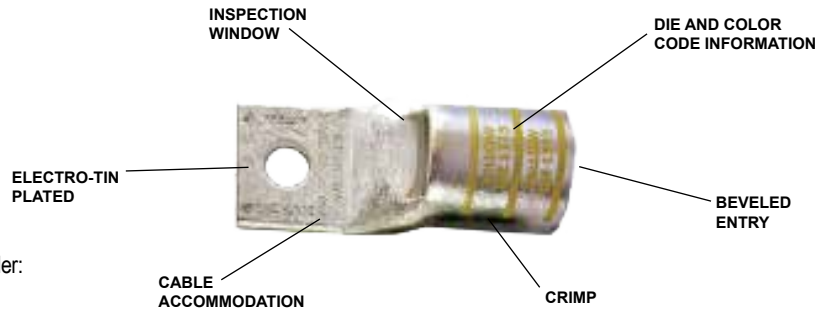

Features & Benefits

- Inspection windows allows for visual verification that the wire has been fully inserted prior to crimping the lug
- Narrow tongue/tang is designed to allow for parallel terminations of wire in limited space applications
- Barrel is designed with an internal chamfer at the wire entry to ensure smooth insertion of the wire, preventing possible damaging of the strands
- Short/Standard length barrel is recommended for installations with limited space requirements
- 45° and 90° angular lugs are available; please contact Customer Service
- Electro-tin plated unless otherwise specified to reduce galvanic corrosion (bimetallic) and resist corrosive elements
- Connectors are clearly marked with stamping and barrel color coding
- Connectors accommodating wire sizes #10 - 4/0 AWG accommodate both Flex and Code Wire. See Tables on each page for specific details
- Tables in this section identify flex wire as the nominal flex wire size followed by the wire classes and DLO wire size and stranding. For Class Wire Strand counts, see the table at the beginning of this section.
- BURNDY certifies its products using the BURNDY Engineered System and select other crimp tool manufacturers in accordance with one or more of the UL categories in order to obtain a UL Listing



NOTE: Field bending straight lugs to achieve an angular connection will void UL Listing / CSA Certifications and BURNDY will not be liable for the connection.

Accessories

- Hardware - Section F
- PENETROX™ Oxide Inhibitor - Section F
- Heat and Cold Shrink Tubing - Section D
- WIREMIKE™ Wire Micrometer - Section F
- Wire Management (Cable Ties) - Section G

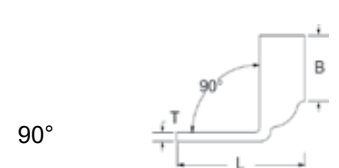
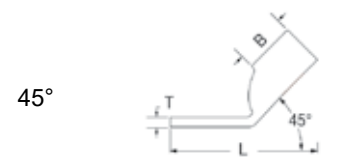

Compression Connections

Copper Compression — Flex — One Hole
Narrow Tongue, Standard Barrel — with Inspection Window

TYPEE YAV-L-NTFX (Continued)

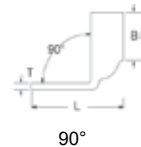
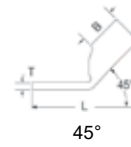
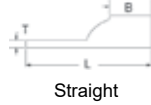

NOTE: Field bending straight lugs to achieve an angular connection will void UL Listing / CSA Certifications and BURNDY will not be liable for the connection.

Catalog Number	Conductor		Stud Hole Size	Tongue Width	Figure Dimensions			Installation Tooling					Wire Strip Length	
	AWG/ KCMIL	MM ² ***			(B)	(T)	(L)	Dieless (# of crimps)	MD6, OUR840, MD734R	500 Series	35, 750, 46* Series	Color Code		Die Index
YAV4CLNT10FX	#4 AWG #4 Flex G,H,I,K,M, DLO	—	#10	0.41	0.50	0.09	1.32	Y122CMR (2) MY29 Series (1) Y1MRTC (2) 81K Series (1) 644 Series (1) 444 Series (1)	W4CRT (1) W4CVT (1) X4CRT (1)	W4CRT (1) W4CVT (1) X4CRT (1)	U4CRT (1)	Gray	8	1/2
YAV2CLNT14FX	#2 AWG #2 Flex G,H,I,K,M, DLO	35	1/4	0.46	0.63	0.10	1.71	Y122CMR (2) MY29 Series (1) Y1MRTC (2) 81K Series (1) 644 Series (1) 444 Series (1)	W2CRT (1) W2CVT (1) X2CRT (1)	W2CVT (1) W2CRT (1) X2CRT (1)	U2CRT (1)	Brown	10	11/16
YAV2CLNT516FX			5/16	0.44	0.63	0.10	1.78							
YAV25LNT14FX	1/0 AWG 1/0 Flex G,H,I,K,M, DLO	50	1/4	0.67	0.69	0.12	1.75	MY29 Series (1) 644 Series (1) 444 Series (1) 81K Series (1)	W25VT (2) W25RT (2) X25RT (2)	W25VT (2) W25RT (2) X25RT (2)	U25RT (1)	Pink	12	11/16
YAV25LNT516FX			5/16	0.67	0.69	0.12	1.81							
YAV25LNT38FX			3/8	0.76	0.69	0.13	1.94							
YAV26LNT516FX	2/0 AWG 2/0 Flex G,H,I,K,M, DLO	70	5/16	0.90	0.81	0.13	1.98	MY29 Series (1) 644 Series (1) 444 Series (1) 81K Series (1)	W26VT (2) W26RT (2) X26RT (2)	W26VT (2) W26RT (2) X26RT (2)	U26RT (1)	Black	13	13/16
YAV26LNT38FX			3/8	0.90	0.81	0.13	2.11							
YAV26LNT12FX			1/2	0.87	0.81	0.13	2.36							
YAV27LNT12FX	3/0 AWG 3/0 Flex G,H,I,K,M, DLO	95	1/2	0.76	1.00	0.14	2.59	MY29 Series (1) 644 Series (1) 444 Series (1) 81K Series (1) 4PC Series (1)	W27VT (2) W27RT (2) X27RT (3)	W27VT (2) W27RT (2) X27RT (3)	U27RT (1)	Orange	14	1-1/16
YAV28LNT516FX	4/0 AWG 4/0 Flex G,H,I,K,M, DLO	—	5/16	0.94	1.03	0.15	2.29	MY29 Series (1) 644 Series (1) 444 Series (1) 81K Series (1)	W28VT (2) W28RT (2) X28RT (3)	W28VT (2) W28RT (2) X28RT (3)	U28RT (1)	Purple	15	1-1/16
YAV28LNT38FX			3/8	0.94	1.03	0.15	2.42							
YAV28LNT12FX			1/2	0.76	1.03	0.15	2.67							
YA30LNT516FX	250 kcmil G,H	—	5/16	0.96	1.03	0.15	2.48	644 Series (1) 444 Series (1) 81K Series (2)	W29VT (2)	—	U29RT (2)	Yellow	16	1-1/8
YA31L-NT12-FX	250 kcmil I,K,M, 262 DLO	150	1/2	0.96	1.06	0.18	2.75	644 Series (1) 444 Series (1) 81K Series (1) 4PC Series (1)	W30VT (2)	W30VT (2) W30RT (2)	U30RT (2)	White	17 or 298	1-1/8
YA32LNT516FX	300 kcmil G,H,I,K,M, 313 DLO	185	5/16	0.96	1.19	0.19	2.65	644 Series (1) 444 Series (1) 81K Series (1)	W31VT (2)	W31VT (2) W31RT (2)	U31RT (2)	Red	18	1-1/4
YA32LNT38FX			3/8	0.96	1.19	0.19	2.68							

Consult cable manufacturers for stress relief instructions

◆ For applications greater than 2000 Volts consult cable manufacturer for voltage stress relief instructions

* Use PUADP1 adaptor with U dies in 46 Series

*** The MM² conductor sizes Listed are the recommendations for CLASS 5 conductor

▲ See tooling section of this catalog for complete tool and die listings. Use ONLY color-coded die recommendations for -FX connectors

Note: All dimensions shown are for reference only.

TYPE YAV-L-NTFX (Continued)

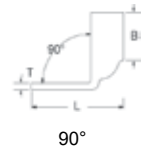
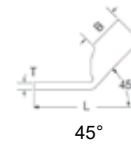
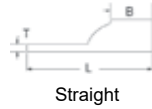

NOTE: Field bending straight lugs to achieve an angular connection will void UL Listing / CSA Certifications and BURNDY will not be liable for the connection.

Catalog Number	Conductor		Stud Hole Size	Tongue Width	Figure Dimensions			Installation Tooling						Wire Strip Length
	AWG/ KCMIL	MM ² ***			(B)	(T)	(L)	Dieless (# of crimps)	MD6, OUR840, MD734R	500 Series	35, 750, 46* Series	Color Code	Die Index	
YA34LNT38FX	350 kcmil	—	3/8	0.96	1.27	0.23	2.87							
YA34LNT12FX	G,H,I,K,M 373 DLO		1/2	0.96	1.27	0.23	3.12							
YA38LNT12FX	500 kcmil	300	1/2	1.63	1.45	0.27	3.41	644 Series (1) 444 Series (1) 81K Series (2)	—	—	U38XRT (2)	Pink	L99	1-7/16
YA38LNTM20FX	H,I,K 550 kcmil G,H,I 535 DLO		M20	1.63	1.45	0.27	3.84							
YA40LENT12FX	650 kcmil G 646 DLO	—	1/2	1.35	1.42	0.30	3.43	644 Series (1) 444 Series (1) 81K Series (2) 4PC Series (3)	—	—	U39RT (2)	Black	24	1-5/16
YA44LNT38FX	750 kcmil	500	3/8	1.50	1.65	0.33	3.79	644 Series (1) 444 Series (1) 81K Series (2)	—	—	U44XRT (2) +P44XRT (2)	Yellow	L115	1-5/8
YA44LNT12FX	G,H, 777 DLO		1/2	1.62	1.65	0.33	3.98							

Consult cable manufacturers for stress relief instructions

◆ For applications greater than 2000 Volts consult cable manufacturer for voltage stress relief instructions

* Use PUADP1 adaptor with U dies in 46 Series

• P-RT dies for 46 Series Tooling only

*** The MM² conductor sizes Listed are the recommendations for CLASS 5 conductor

▲ See tooling section of this catalog for complete tool and die listings. Use ONLY color-coded die recommendations for -FX connectors

Note: All dimensions shown are for reference only.

TYPE YAG-L-TC

HYLUG™

Uninsulated Copper Compression Terminal
UL Listed 90° C, Up to 35 kV ♦

45° and 90° angles available. Please contact Customer Service to order:
1-800-346-4175

Features & Benefits

- No inspection window is ideal for more corrosive environments as the barrel transition is not open
- Barrel is designed with an internal chamfer at the wire entry to ensure smooth insertion of the wire, preventing possible damaging of the strands
- Short/Standard length barrel is recommended for installations with limited space requirements
- 45° and 90° angular lugs are available; please contact Customer Service
- Electro-tin plated unless otherwise specified to reduce galvanic corrosion (bimetallic) and resist corrosive elements
- Connectors are clearly marked with stamping and barrel color coding
- Connectors accommodating wire sizes #10 - 4/0 AWG accommodate both Flex and Code Wire. See Tables on each page for specific details
- Tables in this section identify flex wire as the nominal flex wire size followed by the wire classes and DLO wire size and stranding. For Class Wire Strand counts, see the table at the beginning of this section.
- BURNDY certifies its products using the BURNDY Engineered System and select other crimp tool manufacturers in accordance with one or more of the UL categories in order to obtain a UL Listing

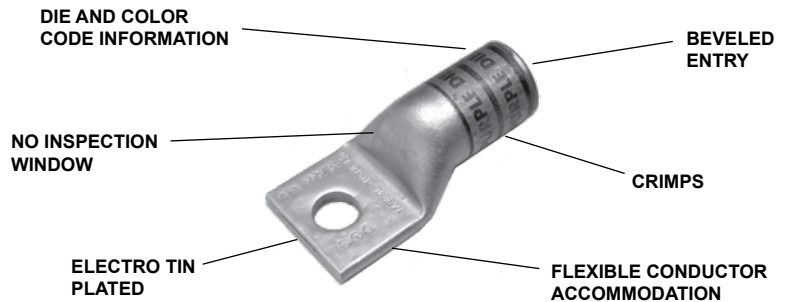

NOTE: Field bending straight lugs to achieve an angular connection will void UL Listing / CSA Certifications and BURNDY will not be liable for the connection.

Straight



45°

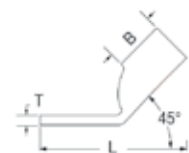

90°



Accessories

- Hardware - Section F
- PENETROX™ Oxide Inhibitor - Section F
- Heat and Cold Shrink Tubing - Section D
- WIREMIKE™ Wire Micrometer - Section F
- Wire Management (Cable Ties) - Section G

TYPE YAG-L-TC (Continued)

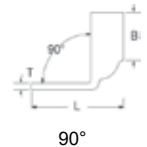
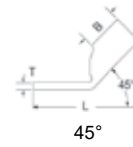
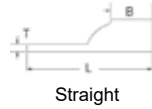

NOTE: Field bending straight lugs to achieve an angular connection will void UL Listing / CSA Certifications and BURNDY will not be liable for the connection.

Catalog Number	Conductor		Stud Hole Size	Tongue Width	Figure Dimensions			Installation Tooling					Wire Strip Length	
	AWG/KCMIL	MM ² ***			(B)	(T)	(L)	Dieless (# of crimps)	MD6, OUR840, MD734R	500 Series	35, 750, 46* Series	Color Code		Die Index
YAG8CLTC14FX	#8 AWG	** 10	1/4	0.44	0.44	0.08	1.32	MY29 Series (1)	W8CVT (1)	W8CVT (1)	U8CRT (1)	Red	49	1/2
YAG8CLTC516FX	G,H,I,K,M, DLO		5/16	0.52	0.44	0.06	1.38	Y1MRTC (1)	W8CRT (1)	W8CRT (1)	U8CRT (1)			
YAG8CLTC12FX	#6 Sol #8 Sol		1/2	0.71	0.44	0.05	1.76	Y122CMR (1) 81K Series (1)	X8CRT (1)	X8CRT (1)				
YAG6CLTC14FX	#6 AWG	** 16	1/4	0.48	0.50	0.08	1.43	MY29 Series (1)	W5CVT (1)	W5CVT (1)	U5CRT (1)	Blue	7	1/2
YAG6CLTC516FX	#6 Flex		5/16	0.52	0.50	0.07	1.49	Y1MRTC (1)	W5CRT (1)	W5CRT (1)				
YAG6CLTC38FX	G,H,I,K,M, DLO		3/8	0.58	0.50	0.06	1.61	Y122CMR (1) 81K Series (1)	X5CRT (1)	X5CRT (1)				
YAG6CLTC12FX			1/2	0.75	0.50	0.12	1.86							
YAG4CLTC14FX	#4 AWG	—	1/4	0.55	0.50	0.09	1.48	MY29 Series (1)	W4CVT (1) W4CRT (1) X4CRT (1)	W4CVT (1) W4CRT (1) X4CRT (1)	U4CRT (1)	Gray	8	1/2
YAG4CLTC516FX	#4 Flex		5/16	0.55	0.50	0.09	1.55	Y1MRTC (2)						
YAG4CLTC38FX	G,H,I,K,M, DLO		3/8	0.58	0.50	0.08	1.67	Y122CMR (2) 81K Series (1)						
YAG4CLTC12FX			1/2	0.71	0.50	0.07	1.92	644 Series (1) 444 Series (1)						
YAG2CLTC14FX	#2 AWG	35	1/4	0.68	0.63	0.10	1.64	MY29 Series (1)	W2CVT (1) W2CRT (1) X2CRT (1)	W2CVT (1) W2CRT (1) X2CRT (1)	U2CRT (1)	Brown	10	11/16
YAG2CLTC516FX	#2 Flex		5/16	0.68	0.63	0.10	1.70	Y1MRTC (2)						
YAG2CLTC38FX	G,H,I,K,M, DLO		3/8	0.68	0.63	0.10	1.83	Y122CMR (2) 81K Series (1)						
YAG2CLTC12FX			1/2	0.73	0.63	0.09	2.12	644 Series (1) 444 Series (1)						
YAG1CLTC14FX	#1 AWG	—	1/4	0.75	0.62	0.12	1.67	MY29 Series (1)	W1CVT (1) W1CRT (1) X1CRT (1)	W1CVT (1) W1CRT (1) X1CRT (1)	U1CRT1 (1)	Green	11	11/16
YAG1CLTC516FX	#1 Flex		5/16	0.75	0.62	0.12	1.73	644 Series (1)						
YAG1CLTC38FX	G,H,I,K,M, DLO		3/8	0.75	0.62	0.12	1.86	444 Series (1)						
YAG1CLTC12FX			1/2	0.75	0.62	0.12	2.11	81K Series (1)						
YAG25LTC14FX	1/0 AWG	50	1/4	0.83	0.69	0.12	1.77	MY29 Series (1)	W25VT (2) W25RT (2) X25RT (2)	W25VT (2) W25RT (2) X25RT (2)	U25RT (1)	Pink	12	11/16
YAG25LTC516FX	1/0 Flex		5/16	0.83	0.69	0.12	1.84	644 Series (1)						
YAG25LTC38FX	G,H,I,K,M, DLO		3/8	0.83	0.69	0.12	1.96	444 Series (1)						
YAG25LTC12FX			1/2	0.83	0.69	0.12	2.21	81K Series (1)						
YAG26LTC14FX	2/0 AWG	70	1/4	0.93	0.81	0.13	1.95	MY29 Series (1)	W26VT (2) W26RT (2) X26RT (2)	W26VT (2) W26RT (2) X26RT (2)	U26RT (1)	Black	13	13/16
YAG26LTC516FX	2/0 Flex		5/16	0.93	0.81	0.13	2.01	644 Series (1)						
YAG26LTC38FX	G,H,I,K,M, DLO		3/8	0.93	0.81	0.13	2.13	444 Series (1)						
YAG26LTC12FX			1/2	0.93	0.81	0.13	2.38	81K Series (1)						
YAG27LTC14FX	3/0 AWG	95	1/4	1.03	1.00	0.14	2.18	MY29 Series (1)	W27VT (2) W27RT (2) X27RT (3)	W27VT (2) W27RT (2) X27RT (3)	U27RT (1)	Orange	14	1
YAG27LTC516FX	3/0 Flex		5/16	1.03	1.00	0.14	2.24	644 Series (1)						
YAG27LTC38FX	G,H,I,K,M, DLO		3/8	1.03	1.00	0.14	2.37	444 Series (1)						
YAG27LTC12FX			1/2	1.03	1.00	0.14	2.62	81K Series (1)						
YAG28LTC14FX	4/0 AWG	120	1/4	1.14	1.03	0.15	2.26	MY29 Series (1)	W28VT (2) W28RT (2) X28RT (3)	W28VT (2) W28RT (2) X28RT (3)	U28RT (1)	Purple	15	1-1/16
YAG28LTC516FX	4/0 Flex		5/16	1.14	1.03	0.15	2.32	644 Series (1)						
YAG28LTC38FX	G,H,I,K,M, DLO		3/8	1.14	1.03	0.15	2.45	444 Series (1)						
YAG28LTC12FX			1/2	1.14	1.03	0.15	2.70	81K Series (1)						

* Use PUADP1 adapter with U dies in 46 Series

*** The MM² conductor size referenced here is for Class 5 conductor

** The MM² conductor size referenced here is for Class 2 and Class 5 conductor

▲ See tooling section of this catalog for complete tool and die listings

Note: All dimensions shown are for reference only.

Compression Connections

Copper Compression — Flex — One Hole
Standard Barrel — No Inspection Window

TYPE YAG-L-TC (Continued)

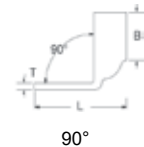
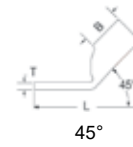
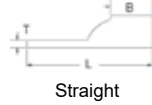

NOTE: Field bending straight lugs to achieve an angular connection will void UL Listing / CSA Certifications and BURNDY will not be liable for the connection.

Catalog Number	Conductor		Stud Hole Size	Tongue Width	Figure Dimensions			Installation Tooling					Wire Strip Length	
	AWG/KCMIL	MM ² ***			(B)	(T)	(L)	Dieless (# of crimps)	MD6, OUR840, MD734R	500 Series	35, 750, 46* Series	Color Code		Die Index
YAG29LTC38FX	250 kcmil	—	3/8	1.18	1.03	0.16	2.45	644 Series (1) 444 Series (1) 81K Series (1)	W29VT (2) X29RT (4)	W29VT (2) W29RT (2) X29RT (4)	U29RT (1)	Yellow	16	1-1/16
YAG29LTC12FX	4/0 AWG Flex G,H,I,K,M, DLO		1/2	1.18	1.03	0.16	2.70							
YAG29LTC58FX			5/8	1.18	1.03	0.16	2.95							
YAG30LTC38FX	250 kcmil G,H	—	3/8	1.20	1.03	0.16	2.47	644 Series (1) 444 Series (1) 81K Series (1)	W29VT (2) X29RT (4)	W29VT (2) W29RT (2) X29RT (4)	U29RT (1)	Yellow	16	1-1/16
YAG30LTC12FX			1/2	1.20	1.03	0.16	2.72							
YAG30LTC58FX			5/8	1.20	1.03	0.16	2.97							
YAG31LTC14FX	250 kcmil I,K,M, 262 DLO	150	1/4	1.29	1.06	0.18	2.35	644 Series (1) 444 Series (1) 81K Series (1)	W30VT (2)	W30VT (2) W30RT (2)	U30RT (2)	White	17	1-1/8
YAG31LTC516FX			5/16	1.29	1.06	0.18	2.41							
YAG31LTC38FX			3/8	1.29	1.06	0.18	2.53							
YAG31LTC12FX			1/2	1.29	1.06	0.18	2.78							
YAG31LTC58FX			5/8	1.29	1.06	0.18	3.03							
YAG32LTC12FX	300 kcmil G,H,I,K,M, 313 DLO	185	1/2	1.40	1.19	0.19	2.97	644 Series (1) 444 Series (1) 81K Series (1)	W31VT (2)	W31VT (2) W31RT (2)	U31RT (2)	Red	18	1-1/4
YAG32LTC58FX			5/8	1.40	1.19	0.19	3.22							
YAG34LTC516FX	350 kcmil G,H,I,K,M, 373 DLO	240	5/16	1.55	1.27	0.23	2.78	644 Series (1) 444 Series (1) 81K Series (1)	W32VT (2)	W32VT (2) W32RT (2)	U32RT (2)	Blue	19	1-5/16
YAG34LTC38FX			3/8	1.55	1.27	0.23	2.91							
YAG34LTC12FX			1/2	1.55	1.27	0.23	3.16							
YAG34LTC58FX			5/8	1.55	1.27	0.23	3.41							
YAG36LTC38FX	500 kcmil G,H 444 DLO	—	3/8	1.73	1.38	0.27	3.27	644 Series (1) 444 Series (1) 81K Series (2)	—	—	U34RT (2)	Brown	20	1-3/8
YAG38LTC516FX	500 kcmil H,I,K 550 kcmil G,H,I 535 DLO	300	5/16	1.84	1.45	0.27	3.08	644 Series (1) 444 Series (1) 81K Series (2)	—	—	U38XRT (2)	Pink	L99	1-7/16
YAG38LTC38FX			3/8	1.84	1.45	0.27	3.39							
YAG38LTC12FX			1/2	1.84	1.45	0.27	3.46							
YAG40LTC14FX	650 kcmil G, 646 DLO	400	1/4	1.96	1.42	0.30	3.04	644 Series (1) 444 Series (1) 81K Series (2)	—	—	U39RT (2)	Black	24	1-5/16
YAG40LTC516FX			5/16	1.96	1.42	0.30	3.11							
YAG40LTC38FX			3/8	1.96	1.42	0.30	3.42							
YAG40LTC12FX			1/2	1.96	1.42	0.30	3.48							
YAG44LTC516FX	750 kcmil G,H, 777 DLO	500	5/16	2.18	1.65	0.33	3.81	644 Series (1) 444 Series (1) 81K Series (2)	—	—	U44XRT (2) •P44XRT (2)	Yellow	L115	1-5/8
YAG44LTC38FX			3/8	2.18	1.65	0.33	3.81							
YAG44LTC12FX			1/2	2.18	1.65	0.33	3.85							

* Use PUADP1 adapter with U dies in 46 Series

• P-RT dies for 46 Series Tooling only

*** The MM² conductor size referenced here is for Class 5 conductor

** The MM² conductor size referenced here is for Class 2 and Class 5 conductor

▲ See tooling section of this catalog for complete tool and die listings

Note: All dimensions shown are for reference only.

TYPE YA-LB

HYLUG™

Uninsulated Copper Compression Terminal
UL Listed 90° C, Up to 35 kV ◆

45° and 90° angles available. Please contact Customer Service to order:
1-800-346-4175

Features & Benefits

- Inspection windows allows for visual verification that the wire has been fully inserted prior to crimping the lug
- Barrel is designed with a “belled” end opening at the wire entry, to ensure smooth insertion of highly flexible stranded wire, preventing possible damaging of the wire strands during insertion
- Short/Standard length barrel is recommended for installations with limited space requirements
- 45° and 90° angular lugs are available; please contact Customer Service
- Electro-tin plated unless otherwise specified to reduce galvanic corrosion (bimetallic) and resist corrosive elements
- Connectors are clearly marked with stamping and barrel color coding
- Connectors accommodating wire sizes #10 - 4/0 AWG accommodate both Flex and Code Wire. See Tables on each page for specific details
- Tables in this section identify flex wire as the nominal flex wire size followed by the wire classes and DLO wire size and stranding. For Class Wire Strand counts, see the table at the beginning of this section.
- BURNDY certifies its products using the BURNDY Engineered System and select other crimp tool manufacturers in accordance with one or more of the UL categories in order to obtain a UL Listing

Accessories

- Hardware - Section F
- PENETROX™ Oxide Inhibitor - Section F
- Heat and Cold Shrink Tubing - Section D
- WIREMIKE™ Wire Micrometer - Section F
- Wire Management (Cable Ties) - Section G

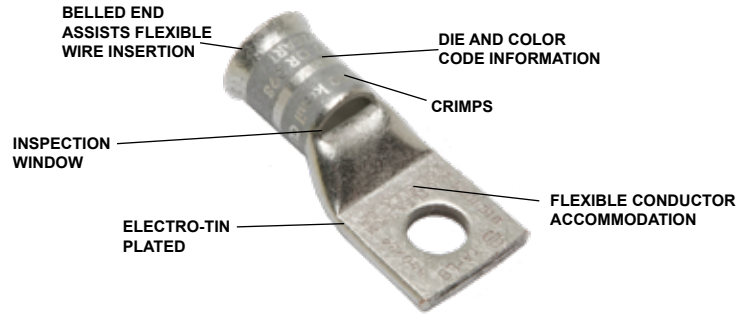

NOTE: Field bending straight lugs to achieve an angular connection will void UL Listing / CSA Certifications and BURNDY will not be liable for the connection.

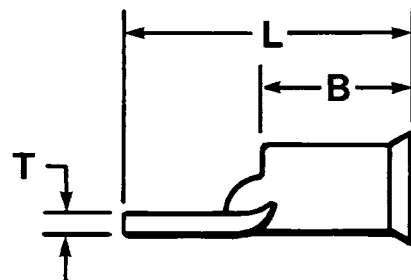
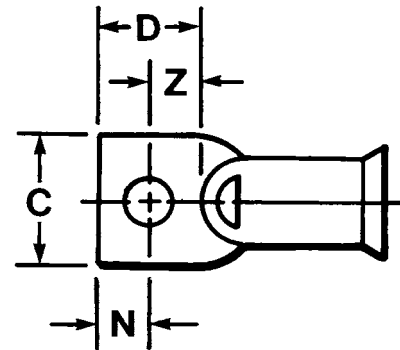

Compression Connections

Copper Compression — Flex — One Hole
Standard Barrel, Belled End — with Inspection Window

TYPE YA-LB (Continued)

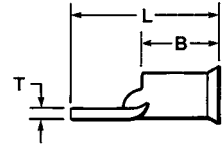
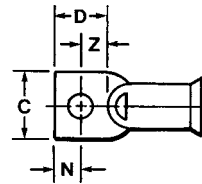

NOTE: Field bending straight lugs to achieve an angular connection will void UL Listing / CSA Certifications and BURNDY will not be liable for the connection.

Catalog Number	Flex Conductor Size AWG/kcmil	Bolt Hole Size	Wire Strip Length	Installation Tooling* Dieless (# of crimps)	Die Index	Dimensions	
						B	L
YA8CLB	#8 AWG #6 Sol, #8 Sol	#10	7/16"	81K Series (1)	49	0.41"	1.12"
	#8 Flex G,H,I,K,M, DLO				1013		
YA5CLB	#5 AWG	1/4"	7/8"		7	0.44"	1.73"
	#6 Flex G,H,I,K,M, DLO				1014		
YA4CLB	#4 AWG	1/4"	7/8"		8	0.50"	1.73"
	#5 Flex G,H,I,K,M, DLO				1015		
YA3CLB	#3 AWG	5/16"	15/16"		9	0.55"	1.94"
	#4 Flex G,H,I,K,M, DLO				1016		
YA2CLB	#2 AWG	5/16"	15/16"		10	0.61"	1.97"
	#3 Flex G,H,I,K,M, DLO				1017		
YA1CLB	#1 AWG	5/16"	15/16"	11	0.68"	2.02"	
	#2 Flex G,H,I,K,M, DLO			1018			
YA25LB	1/0 AWG	5/16"	15/16"	12	0.75"	2.26"	
	#1 Flex G,H,I,K,M, DLO			1019			
YA26LB	2/0 AWG	3/8"	1"	13	0.83"	2.61"	
	1/0 Flex G,H,I,K,M, DLO			1020			
YA27LB	3/0 AWG	1/2"	1-1/16"	14	0.91"	2.67"	
	2/0 Flex G,H,I,K,M, DLO			1021			

Catalog Number	Flex Conductor Size AWG/kcmil	Bolt Hole Size	Wire Strip Length	Installation Tooling* Dieless (# of crimps)	Die Index	Dimensions	
						B	L
YA28LB	4/0 AWG	1/2"	1-1/16"	644 Series (1) 444 Series (1) 81K Series (1)	15	1.02"	2.77"
	3/0 Flex G,H,I,K,M, DLO				1022		
YA29LB	250 kcmil	1/2"	1-1/16"		16	1.11"	2.82"
	4/0 Flex G,H				1023		
YA30LB	300 kcmil	1/2"	1-1/8"		17	1.20"	2.93"
	250 Flex G,H 4/0 Flex I, K, M DLO				1024		
YA31LB	350 kcmil	1/2"	1-3/16"		18	1.29"	3.31"
	250 Flex I,K,M, 262 DLO				1025		
YA32LB	400 kcmil	5/8"	1 1/4"		19	1.40"	3.56"
	300 Flex G,H,I,K,M, 313 DLO				1026		
YA34LB	500 kcmil	5/8"	1-7/16"	20	1.52"	3.83"	
	350 Flex G,H,I,K,M, 373 DLO 400 Flex G,H,I			1027			
YA36LB	600 kcmil	5/8"	1-3/4"	22	1.69"	4.31"	
	450 Flex I,K,M 444 DLO 500 Flex G,H			1028			
YA38LB	700 kcmil	5/8"	1-15/16"	23	1.81"	4.27"	
	500 Flex I,K,M 535 DLO 550 Flex G,H,I			1029			
YA39LB	750 kcmil	5/8"	1-15/16"	24	1.89"	4.27"	
	600 Flex G 550 Flex M			1030			
YA40LB	800 kcmil	5/8"	1-15/16"	25	1.95"	4.27"	
	600 Flex H,I,K,M			1031			
YA44LB	1000 kcmil	5/8"	1-15/16"	27	2.17"	4.5"	
	650 Flex I 750 Flex G,H 777 DLO			1032			

* 644 and 444 Series for use on Code Wire Only
Note: All dimensions shown are for reference only.

TYPES YAZ, YAZV

HYLUG™

Uninsulated Copper Compression Terminal
UL Listed 90° C, Up to 35 kV ◆

45° and 90° angles available. Please contact Customer Service to order:
1-800-346-4175

Features & Benefits

- Inspection windows allows for visual verification that the wire has been fully inserted prior to crimping the lug
- Barrel is designed with an internal chamfer at the wire entry to ensure smooth insertion of the wire, preventing possible damaging of the wire strands during insertion
- Long barrel allows for an increased number of crimps which will increase the mechanical strength of the connection
- 45° and 90° angular lugs are available; please contact Customer Service
- Electro-tin plated unless otherwise specified to reduce galvanic corrosion (bimetallic) and resist corrosive elements
- Connectors are clearly marked with stamping and barrel color coding
- Connectors accommodating wire sizes #10 - 4/0 AWG accommodate both Flex and Code Wire. See Tables on each page for specific details
- Tables in this section identify flex wire as the nominal flex wire size followed by the wire classes and DLO wire size and stranding. For Class Wire Strand counts, see the table at the beginning of this section.
- BURNDY certifies its products using the BURNDY Engineered System and select other crimp tool manufacturers in accordance with one or more of the UL categories in order to obtain a UL Listing

Accessories

- Hardware - Section F
- PENETROX™ Oxide Inhibitor - Section F
- Heat and Cold Shrink Tubing - Section D
- WIREMIKE™ Wire Micrometer - Section F
- Wire Management (Cable Ties) - Section G

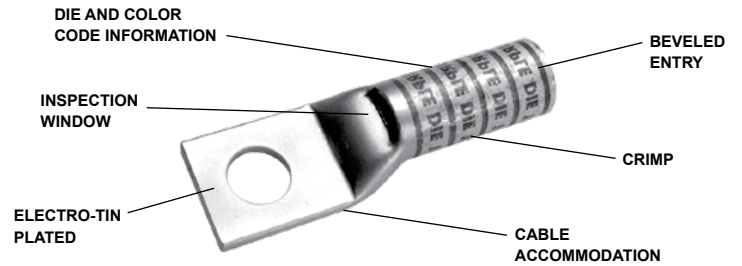

NOTE: Field bending straight lugs to achieve an angular connection will void UL Listing / CSA Certifications and BURNDY will not be liable for the connection.

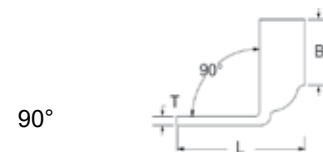
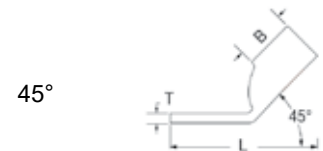

Compression Connections

Copper Compression — Flex — One Hole
Long Barrel — with Inspection Window

TYPES YAZ, YAZV (Continued)

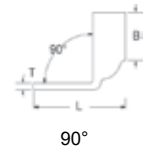
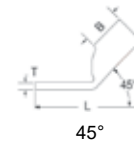
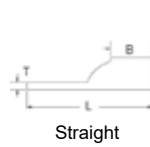

NOTE: Field bending straight lugs to achieve an angular connection will void UL Listing / CSA Certifications and BURNDY will not be liable for the connection.

Catalog Number	Conductor		Stud Hole Size	Tongue Width	Figure Dimensions			Installation Tooling					Wire Strip Length		
	AWG/KCMIL	MM ² ***			(B)	(T)	(L)	Dieless (# of crimps)	MD6, OUR840, MD734R	500 Series	35, 750, 46 ⁺ Series	Color Code		Die Index	
YAZ8CTC10	#8 AWG	**	#10	.41"	0.75	0.08	1.43	Y122CMR (2) Y1MRTC (2) MY29 Series (2) MRC840 (2) 81K Series (1)	W8CVT (2) W8CRT (2) X8CRT (2)	W8CVT (2) W8CRT (2) X8CRT (2)	U8CRT (2)	Red	49	13/16	
YAZ8CTC14	#8 Flex		1/4	.44"	0.75	0.08	1.56								
YAZ8CTC38	G,H,I,K,M DLO #6 Sol #8 Sol	3/8	.58"	0.75	0.06	1.75									
YAZV6CTC14FX	#6 AWG	**	1/4	.48"	0.75	0.08	1.59		W5CVT (2) W5CRT (2) X5CRT (2)	W5CVT (2) W5CRT (2) X5CRT (2)	U5CRT (2)	Blue	7 or 374	13/16	
YAZV6CTC38FX	#6 Flex	16	3/8	.58"	0.75	0.06	1.77								
YAZV4CTC14FX	#4 AWG	—	1/4	.55"	1.25	0.09	2.19		Y122CMR (4) Y1MRTC (4) MY29 Series (2) MRC840 (2) 644 Series (1) 444 Series (1) 81K Series (1)	W4CVT (2) W4CRT (2) X4CRT (2)	W4CVT (2) W4CRT (2) X4CRT (2)	U4CRT (2)	Gray	8 or 346	1-5/16
YAZV4CTC38FX	#4 Flex		3/8	.58"	1.25	0.08	2.42								
YAZV2CTC14FX	#2 AWG	35	1/4	.68"	1.38	0.10	2.37			W2CVT (2) W2CRT (2) X2CRT (2)	W2CVT (2) W2CRT (2) X2CRT (2)	U2CRT (2)	Brown	10	1-7/16
YAZV2CTC38FX	#2 Flex		3/8	.68"	1.38	0.10	2.56								
YAZV2CTC12FX	G,H,I,K,M, DLO		1/2	.83"	1.38	0.09	2.87								
YAZV1CTC14FX	#1 AWG	—	1/4	.75"	1.38	0.12	2.40	MY29 Series (2) MRC840 (2) 644 Series (1) 444 Series (1) 81K Series (1)	W1CVT (2) W1CRT1 (2) X1CRT1 (2)	W1CVT (2) W1CRT1 (2) X1CRT1 (2)	U1CRT1 (2)	Green	11 or 375	1-7/16	
YAZV1CTC516FX	#1 Flex		5/16	.75"	1.38	0.12	2.46								
YAZV1CTC38FX	G,H,I,K,M, DLO		3/8	.75"	1.38	0.12	2.59								
YAZV25TC14FX	1/0 AWG	50	1/4	.83"	1.50	0.12	2.56	MY29 Series (2) 644 Series (1) 444 Series (1) 81K Series (2)	W25VT (4) W25RT (4) X25RT (4)	W25VT (4) W25RT (4) X25RT (4)	U25RT (2)	Pink	12 or 348	1-9/16	
YAZV25TC38FX	1/0 Flex		3/8	.83"	1.50	0.12	2.75								
YAZV25TC12FX	G,H,I,K,M, DLO		1/2	.83"	1.50	0.12	3.00								
YAZV26TC14FX	2/0 AWG	70	1/4	.93"	1.50	0.13	2.61		W26VT (4) W26RT (4) X26RT (4)	W26VT (4) W26RT (4) X26RT (4)	U26RT (2)	Black	13	1-9/16	
YAZV26TC38FX	2/0 Flex		3/8	.93"	1.50	0.13	2.80								
YAZV26TC12FX	G,H,I,K,M, DLO		1/2	.93"	1.50	0.13	3.05								
YAZV27TC38FX	3/0 AWG	95	3/8	1.03"	1.50	0.14	2.84		W27VT (4) W27RT (4) X27RT (4)	W27VT (4) W27RT (4) X27RT (4)	U27RT (2)	Orange	14	1-9/16	
YAZV28NT38FX	4/0 AWG	**	3/8	.94"	1.62	0.14	3.01		MY29 Series (2) 644 Series (1) 444 Series (1) 81K Series (2)	W28VT (4) W28RT (4) X28RT (4)	W28VT (4) W28RT (4) X28RT (6)	U28RT (2)	Purple	15	1-11/16
YAZV28TC38FX	4/0 Flex		3/8	1.14"	1.62	0.14	3.01								
YAZV28TC12FX	G,H,I,K,M, DLO		1/2	1.14"	1.62	0.14	3.26								
YAZV29NT516FX	250 kcmil	—	5/16	.96"	2.00	0.16	3.27	W29VT (4) X29RT (8)		W29VT (4) W29RT (4) X29RT (8)	U29RT (2)	Yellow	16	2-1/16	

* Use PUADP1 adapter with U dies in 46 Series

** The MM² conductor size referenced here is for both Class 2 and Class 5 conductor

*** The MM² conductor sizes listed are the recommendations for Class 5 conductor

▲ See tooling section of this catalog for complete tool and die listings. Use ONLY color-coded die recommendations for -FX connectors. For nest/indenter system contact factory

◆ For applications greater than 2000 Volts consult cable manufacturer for voltage stress relief instructions.

Note: All dimensions shown are for reference only.

TYPES YAZ, YAZV (Continued)

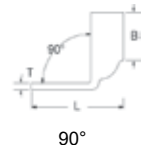
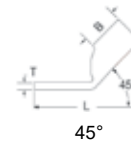
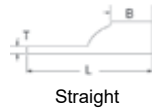

NOTE: Field bending straight lugs to achieve an angular connection will void UL Listing / CSA Certifications and BURNDY will not be liable for the connection.

Catalog Number	Conductor		Stud Hole Size	Tongue Width	Figure Dimensions			Installation Tooling						Wire Strip Length
	AWG/KCMIL	MM ² ***			(B)	(T)	(L)	Dieless (# of crimps)	MD6, OUR840, MD734R	500 Series	35, 750, 46* Series	Color Code	Die Index	
YAZ30TC38FX	250 kcmil G,H	—	3/8	1.20"	2.00	0.16	3.41	644 Series (1) 444 Series (1) 81K Series (2)	W29VT (4) X29RT (8)	W29VT (4) W29RT (4) X29RT (8)	U29RT (2)	Yellow	16	2-1/16
YAZ31TC38FX	250 kcmil I,K,M, 262 DLO	150	3/8	1.28"	2.00	0.18	3.44		W30VT (4)	W30VT (4) W30RT (4)	U30RT (4)	White	17 or 298	2-1/16
YAZ32TC38FX	300 kcmil G,H,I,K,M, 313 DLO	185	3/8	1.55"	2.12	0.19	3.61		X31VT (4)	W31VT (4) W31RT (4)	U31RT (4)	Red	18 or 324	2-3/16
YAZ34NT38FX	350 kcmil G,H,I,K,M, 373 DLO	240	3/8	.96"	2.25	0.23	3.84		W32VT (4)	W32VT (4) W32RT (4)	U32RT (4)	Blue	19	2-5/16
YAZ34TC38FX			3/8	1.52"	2.25	0.23	3.84							
YAZ34TC12FX			1/2	1.52"	2.25	0.23	4.09							
YAZ36TC38FX	500 kcmil G,H 444 DLO	—	3/8	1.72"	2.69	0.26	4.54		—	—	U34RT (4)	Brown	20 or 299	2-3/4
YAZ38NT38FX	500 kcmil H,I,K 535 DLO	300	3/8	1.63"	2.81	0.27	4.71		—	—	U38XRT (4)	Pink	L99	2-7/8
YAZ38TC38FX			3/8	1.81"	2.81	0.27	4.71							
YAZ38NT12FX			1/2	1.63"	2.81	0.27	4.77							
YAZ38TC12FX			1/2	1.81"	2.81	0.27	4.77							

* Use PUADP1 adapter with U dies in 46 Series

** The MM² conductor size referenced here is for both Class 2 and Class 5 conductor

*** The MM² conductor sizes listed are the recommendations for Class 5 conductor

▲ See tooling section of this catalog for complete tool and die listings. Use ONLY color-coded die recommendations for -FX connectors. For nest/indenter system contact factory

◆ For applications greater than 2000 Volts consult cable manufacturer for voltage stress relief instructions.

Note: All dimensions shown are for reference only.

Compression Connections

Copper Compression — Flex — One Hole
Long Barrel, Belled End — No Inspection Window

TYPES YA-TC-FXB, YAV-TC-FXB

HYLUG™

Uninsulated Copper Compression Terminal
UL Listed 90° C, Up to 35 kV ♦

45° and 90° angles available. Please contact Customer Service to order:
1-800-346-4175

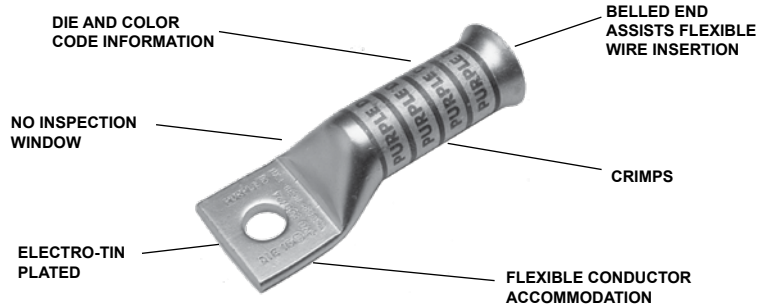

Features & Benefits

- No inspection window is ideal for more corrosive environments as the barrel transition is not open
- Barrel is designed with a “belled” end opening at the wire entry, to ensure smooth insertion of highly flexible stranded wire, preventing possible damaging of the wire strands during insertion
- Long barrel allows for an increased number of crimps which will increase the mechanical strength of the connection
- 45° and 90° angular lugs are available; please contact Customer Service
- Electro-tin plated unless otherwise specified to reduce galvanic corrosion (bimetallic) and resist corrosive elements
- Connectors are clearly marked with stamping and barrel color coding
- Connectors accommodating wire sizes #10 - 4/0 AWG accommodate both Flex and Code Wire. See Tables on each page for specific details
- Tables in this section identify flex wire as the nominal flex wire size followed by the wire classes and DLO wire size and stranding. For Class Wire Strand counts, see the table at the beginning of this section.
- BURNDY certifies its products using the BURNDY Engineered System and select other crimp tool manufacturers in accordance with one or more of the UL categories in order to obtain a UL Listing



NOTE: Field bending straight lugs to achieve an angular connection will void UL Listing / CSA Certifications and BURNDY will not be liable for the connection.

Accessories

- Hardware - Section F
- PENETROX™ Oxide Inhibitor - Section F
- Heat and Cold Shrink Tubing - Section D
- WIREMIKE™ Wire Micrometer - Section F
- Wire Management (Cable Ties) - Section G

Straight



45°

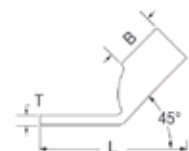

90°

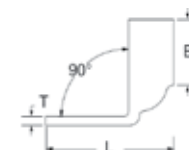

TYPES YA-TC-FXB, YAV-TC-FXB (Continued)

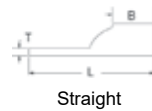

Straight

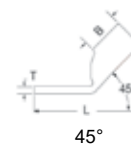

45°

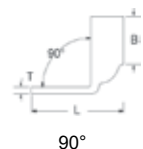

90°

NOTE: Field bending straight lugs to achieve an angular connection will void UL Listing / CSA Certifications and BURNDY will not be liable for the connection.

Catalog Number	Conductor		Stud Hole Size	Tongue Width	Figure Dimensions			Installation Tooling					Wire Strip Length	
	AWG/KCMIL	MM ² ***			(B)	(T)	(L)	Dieless (# of crimps)	MD6, OUR840, MD734R	500 Series	35, 750, 46* Series	Color Code		Die Index
YA8CTC14FXB	#8 AWG #8 Flex G,H,I,K,M DLO #6 Sol #8 Sol	** 10	1/4	0.44	0.90	0.08	1.78	MRC840 (2) MY29 Series (2) Y122CMR (2) Y1MRTC (2) 81K Series (1)	W8CVT (2)	W8CVT (2)	U8CRT (2)	Red	49	1
YAV6CTC10FXB	#6 AWG #6 Flex G,H,I,K,M, DLO	** 16	#8-#10 1/4	0.48 0.48	1.22	0.08	2.00 2.12	MY29 Series (2) Y1MRTC (2) Y122CMR (2) 81K Series (1)	W5CVT (2)	W5CVT (2)	U5CRT (2)	Blue	7	1-5/16
YAV6CTC14FXB	#5 AWG #5 Flex G,H,I,K,M, DLO	—	1/4	0.44	1.22	0.07	2.12							
YA5CTC14FXB	#5 AWG #5 Flex G,H,I,K,M, DLO	—	1/4	0.44	1.22	0.07	2.12	MY29 Series (2) Y1MRTC (4) Y122CMR (4) 644 Series (1) 444 Series (1) 81K Series (1)	W4CVT (2)	W4CVT (2)	U4CRT (2)	Gray	8	1-5/16
YAV4CTC10FXB	#4 AWG #4 Flex G,H,I,K,M, DLO	—	#8-#10 1/4	0.55 0.55	1.22	0.09	2.05 2.17							
YAV4CTC14FXB	#4 AWG #4 Flex G,H,I,K,M, DLO	—	5/16	0.55	1.22	0.09	2.24	MY29 Series (2) Y1MRTC (4) Y122CMR (4) 644 Series (1) 444 Series (1) 81K Series (1)	W2CVT (2)	W2CVT (2)	U2CRT (2)	Brown	10	1-7/16
YAV4CTC516FXB	#2 AWG #2 Flex G,H,I,K,M, DLO	35	#8-#10 5/16	0.68 0.68	1.35	0.10	2.24 2.43							
YAV2CTC10FXB	#2 AWG #2 Flex G,H,I,K,M, DLO	35	#8-#10	0.68	1.35	0.10	2.43	MY29 Series (2) 644 Series (1) 444 Series (1) 81K Series (1)	W1CVT (2)	W1CVT (2)	U1CRT1 (2)	Green	11	1-9/16
YAV1CTC10FXB	#1 AWG #1 Flex G,H,I,K,M, DLO	—	#8-#10 5/16	0.75 0.75	1.50	0.12	2.41 2.60							
YAV1CTC516FXB	#1 AWG #1 Flex G,H,I,K,M, DLO	—	5/16	0.75	1.50	0.12	2.60	MY29 Series (2) 644 Series (1) 444 Series (1) 81K Series (2)	W25VT (4)	W25VT (4)	U25RT (2)	Pink	12	1-9/16
YAV25TC10FXB	1/0 AWG	50	#8-#10	0.83	1.50	0.12	2.45							
YAV25TC516FXB	1/0 Flex		5/16	0.83	1.50	0.12	2.64							
YAV25TC38FXB	G,H,I,K,M, DLO		3/8	0.83	1.50	0.12	2.77							
YAV25TC12FXB	DLO		1/2	0.83	1.50	0.12	3.20							
YAV26TC38FXB	2/0 AWG	70	3/8	0.93	1.63	0.13	2.95	MY29 Series (2) 644 Series (1) 444 Series (1) 81K Series (2)	W26VT (4)	W26VT (4)	U26RT (2)	Black	13	1-13/16
YAV26TC12FXB	2/0 Flex G,H,I,K,M, DLO		1/2	0.93	1.63	0.13	3.39							
YAV27TC12FXB	3/0 AWG 3/0 Flex G,H,I,K,M, DLO	95	1/2	1.04	1.64	0.14	3.44	MY29 Series (2) 644 Series (1) 444 Series (1) 81K Series (2)	W27VT (4)	W27VT (4)	U27RT (2)	Orange	14	1-13/16

* Use PUADP1 adapter with U dies in 46 Series

** The 16 MM² and 120 MM² referenced here are for both Class 2 and Class 5 conductor

*** The MM² conductor sizes listed are the recommendations for Class 5 conductor

‡ P44RT for use with 46 Series only. PUADP1 adapter not required.

▲ See tooling section of this catalog for complete tool and die listings. Use ONLY color-coded die recommendations for -FX connectors. For nest/indenter system contact factory.

◆ For applications greater than 2000 Volts consult cable manufacturer for voltage stress relief instructions

Note: All dimensions shown are for reference only.

Compression Connections

Copper Compression — Flex — One Hole
Long Barrel, Belled End — No Inspection Window

TYPES YA-TC-FXB, YAV-TC-FXB (Continued)

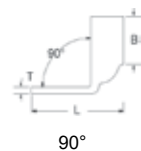
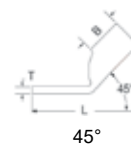
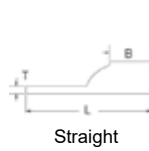

NOTE: Field bending straight lugs to achieve an angular connection will void UL Listing / CSA Certifications and BURNDY will not be liable for the connection.

Catalog Number	Conductor		Stud Hole Size	Tongue Width	Figure Dimensions			Installation Tooling					Wire Strip Length								
	AWG/KCMIL	MM ² ***			(B)	(T)	(L)	Dieless (# of crimps)	MD6, OUR840, MD734R	500 Series	35, 750, 46* Series	Color Code		Die Index							
YAV28TC38FXB	4/0 AWG 4/0 Flex G,H,I,K,M, DLO	—	3/8	1.14	1.77	0.14	3.19	644 Series (1) 444 Series (1) 81K Series (2)	W28VT (4)	W28VT (4)	U28RT (2)	Purple	15	1-7/8							
YAV28TC12FXB			1/2	1.14	1.77	0.14	3.63														
YA30TC12FXB	250 kcmil G,H	—	1/2	1.20	4.04	0.16	4.04		W29VT (4)	W29VT (4)	U29RT (2)	Yellow	16	2-1/4							
YA31TC12FXB	250 kcmil I,K,M, 262 DLO	150	1/2	1.29	2.18	0.18	4.09	644 Series (1) 444 Series (1) 81K Series (2)	W30VT (4)	W30VT (4)	U30RT (4)	White	17	2-1/4							
YA32TC12FXB															300 kcmil G,H,I,K,M, 313 DLO	185	1/2	1.40	2.32	0.19	4.28
YA34TC12FXB	350 kcmil G,H,I,K,M, 373 DLO	240	1/2	1.55	2.48	0.23	4.54		W32VT (4)	W32VT (4)	U32RT (4)	Blue	19	2-9/16							
YA36TC12FXB	500 kcmil G,H 444 DLO	—	1/2	1.73	2.95	0.26	5.09		—	—	U34RT (4)	Brown	20	3-1/16							
YA36TC58FXB			5/8	1.73	2.95	0.26	5.15														
YA38TC12FXB	500 kcmil H,I,K 550 kcmil G,H,I 535 DLO	300	1/2	1.84	3.08	0.27	5.07		—	—	U38XRT (4)	Pink	L99	3-1/16							
YA38TC58FXB			5/8	1.84	3.08	0.27	5.32														
YA40TC58FXB	650 kcmil G 646 DLO	400	5/8	1.98	3.24	0.30	5.53		644 Series (1) 444 Series (1) 81K Series (3)	—	—	U39RT (4)	Black	24	3-5/16						
YA44TC58FXB	750 kcmil G,H 777 DLO	500	5/8	2.18	3.33	0.32	5.71									—	—	U44XRT (4) •P44XRT (2)	Yellow	L115	3-7/16
YA46TC58FXB	1000 kcmil G, H 1111 DLO	—	5/8	2.69	3.58	0.39	6.19									—	—	**P45RT (4)	Yellow	29	3-11/16

* Use PUADP1 adapter with U dies in 46 Series

• P-RT dies for 46 Series Tooling only

** The 16 MM² and 120 MM² referenced here are for both Class 2 and Class 5 conductor

*** The MM² conductor sizes listed are the recommendations for Class 5 conductor

▲ See tooling section of this catalog for complete tool and die listings. Use ONLY color-coded die recommendations for -FX connectors. For nest/indenter system contact factory.

◆ For applications greater than 2000 Volts consult cable manufacturer for voltage stress relief instructions

Note: All dimensions shown are for reference only.

TYPES YA-L-2TC, YA-L-2TC-FX, YAV-L-2TC-FX

HYLUG™

Uninsulated Copper Compression Terminal
UL Listed 90° C, Up to 35 kV ◆

45° and 90° angles available. Please contact Customer Service to order:
1-800-346-4175

Features & Benefits

- Inspection windows allows for visual verification that the wire has been fully inserted prior to crimping the lug
- Barrel is designed with an internal chamfer at the wire entry to ensure smooth insertion of the wire, preventing possible damaging of the wire strands during insertion
- Short/Standard length barrel is recommended for installations with limited space requirements
- Two hole tongue/tang is recommended when space permits as the 2-hole feature minimizes the terminations from loosening or rotating under vibration, movement, or heat cycling
- 45° and 90° angular lugs are available; please contact Customer Service
- Electro-tin plated unless otherwise specified to reduce galvanic corrosion (bimetallic) and resist corrosive elements
- Connectors are clearly marked with stamping and barrel color coding
- Connectors accommodating wire sizes #10 - 4/0 AWG accommodate both Flex and Code Wire. See Tables on each page for specific details
- Tables in this section identify flex wire as the nominal flex wire size followed by the wire classes and DLO wire size and stranding. For Class Wire Strand counts, see the table at the beginning of this section.
- BURNDY certifies its products using the BURNDY Engineered System and select other crimp tool manufacturers in accordance with one or more of the UL categories in order to obtain a UL Listing

Accessories

- Hardware - Section F
- PENETROX™ Oxide Inhibitor - Section F
- Heat and Cold Shrink Tubing - Section D
- WIREMIKE™ Wire Micrometer - Section F
- Wire Management (Cable Ties) - Section G

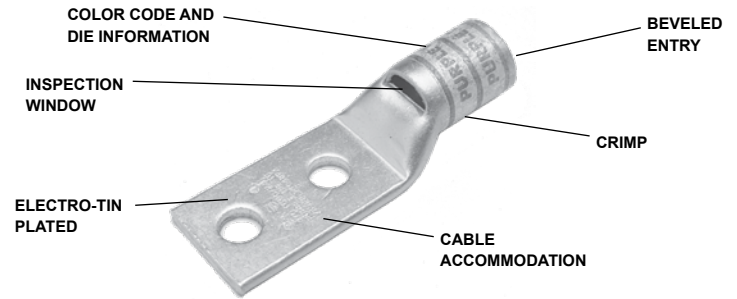

NOTE: Field bending straight lugs to achieve an angular connection will void UL Listing / CSA Certifications and BURNDY will not be liable for the connection.

Straight



45°

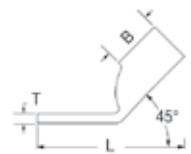

90°

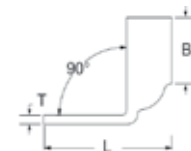

Compression Connections

Copper Compression — Flex — Two Hole
Standard Barrel — with Inspection Window

TYPES YA-L-2TC, YA-L-2TC-FX, YAV-L-2TC-FX (Continued)

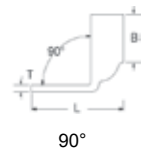
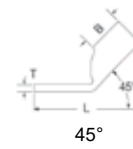
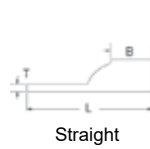

NOTE: Field bending straight lugs to achieve an angular connection will void UL Listing / CSA Certifications and BURNDY will not be liable for the connection.

Catalog Number	Conductor		Bolt Hole Size	Stud Hole Spacing	Tongue Width	Figure Dimensions			▲ Installation Tooling						Wire Strip Length	
	AWG/KCMIL	MM ² ***				(B)	(T)	(L)	Dieless (# of Crimps)	MD6, OUR840, MD734R	500 Series	35, 750, 46* Series	Color Code	Die Index		
YA8CL2TC10	#8 AWG		#10	5/8	0.41	0.44	0.08	1.83	Y122CMR (1)							
YA8CL2TC14	#8 Flex		1/4	5/8	0.44	0.44	0.08	1.95	MRC840 (1)							
YA8CL2TC14E2	G,H,I,K,M	10	1/4	3/4	0.44	0.44	0.08	2.08	MY29 Series (1)	W8CVT (1)	W8CVT (1)	U8CRT (1)	Red	49	7/16	
YA8CL2TC14E1	DLO		1/4	1	0.44	0.44	0.08	2.33	Y8MRB1 (1)	W8CRT (1)	W8CRT (1)					
YA8CL2TC38	#6 Sol		3/8	1	0.58	0.44	0.06	2.52	Y1MRTC (1)	X8CRT (1)	X8CRT (1)					
YAV6CL2TC10E9FX	#8 Sol		#10	1/2	0.48	0.50	0.08	1.81								
YAV6CL2TC10FX			#10	5/8	0.45	0.50	0.08	1.94								
YAV6CL2TC10E4FX			#10	11/16	0.45	0.50	0.08	2.00								
YAV6CL2TC10E2FX	#6 AWG	16	#10	3/4	0.48	0.50	0.08	2.06	Y122CMR (1)							
YAV6CL2TC14FX	#6 Flex		1/4	5/8	0.48	0.50	0.08	2.06	MRC840 (1)	W5CVT (1)	W5CVT (1)	U5CRT (1)	Blue	7	1/2	
YAV6CL2TC14E2FX	G,H,I,K,M,		1/4	3/4	0.48	0.50	0.08	2.16	MY29 Series (1)	W5CRT (1)	W5CRT (1)					
YAV6CL2TC14E1FX	DLO		1/4	1	0.48	0.50	0.08	2.44	Y1MRTC (1)	X5CRT (1)	X5CRT (1)					
YAV6CL2TC516FX			5/16	1	0.52	0.50	0.07	2.50	81K Series (1)							
YAV6CL2TC38FX			3/8	1	0.58	0.50	0.06	2.62								
YAV6CL2NTCFX			1/2	1-3/4	0.83	0.50	0.12	3.81								
YAV4CL2TC14FX			1/4	5/8	0.55	0.50	0.09	2.08	Y122CMR (1)							
YAV4CL2TC14E2FX	#4 AWG	—	1/4	3/4	0.55	0.50	0.09	2.20	MY29 Series (1)	W4CVT (1)	W4CVT (1)	U4CRT (1)	Gray	8	1/2	
YAV4CL2TC14E1FX	#4 Flex		1/4	1	0.55	0.50	0.09	2.45	Y1MRTC (1)	W4CRT (1)	W4CRT (1)					
YAV4CL2TC516FX	G,H,I,K,M,		5/16	1	0.55	0.50	0.09	2.52	81K Series (1)	X4CRT (1)	X4CRT (1)					
YAV4CL2TC38FX	DLO		3/8	1	0.58	0.50	0.08	2.68	644 Series (1)							
YAV4CL2NTCFX			1/2	1-3/4	0.83	0.50	0.12	3.87	444 Series (1)							
YAV2CL2TC14FX			1/4	5/8	0.68	0.63	0.10	2.26	Y12CMR (1)							
YAV2CL2TC14E2FX	#2 AWG	35	1/4	3/4	0.68	0.63	0.10	2.38	MY29 Series (1)	W2CVT (1)	W2CVT (1)	U2CRT (1)	Brown	10	11/16	
YAV2CL2TC14E1FX	#2 Flex		1/4	1	0.68	0.63	0.10	2.63	Y1MRTC (1)	W2CRT (1)	W2CRT (1)					
YAV2CL2TC516FX	G,H,I,K,M,		5/16	1	0.68	0.63	0.10	2.71	81K Series (1)	X2CRT (1)	X2CRT (1)					
YAV2CL2TC38FX	DLO		3/8	1	0.68	0.63	0.10	2.82	644 Series (1)							
YAV2CL2NTCFX			1/2	1-3/4	0.83	0.63	0.08	4.07	444 Series (1)							
YAV1CL2TC14FX			1/4	5/8	0.75	0.62	0.12	2.28	Y12CMR (1)							
YAV1CL2TC14E2FX	#1 AWG	—	1/4	3/4	0.75	0.62	0.12	2.41	MY29 Series (1)	W1CVT (1)	W1CVT (1)	U1CRT1 (1)	Green	11	11/16	
YAV1CL2TC14E1FX	#1 Flex		1/4	1	0.75	0.62	0.12	2.65	81K Series (1)	W1CRT1 (1)	W1CRT1 (1)					
YAV1CL2TC516FX	G,H,I,K,M,		5/16	1	0.75	0.62	0.12	2.72	644 Series (1)	X1CRT1 (1)	X1CRT1 (1)					
YAV1CL2TC38FX	DLO		3/8	1	0.75	0.62	0.12	2.85	444 Series (1)							
YAV1CL2NTCFX			1/2	1-3/4	0.83	0.62	0.11	4.04								
YAV25L2TC14FX			1/4	5/8	0.83	0.69	0.12	2.39	Y12CMR (1)							
YAV25L2TC14E2FX	#10 AWG	50	1/4	3/4	0.83	0.69	0.12	2.51	MY29 Series (1)	W25VT (2)	W25VT (2)	U25RT (1)	Pink	12	11/16	
YAV25L2TC516E2FX	#10 Flex		5/16	3/4	0.83	0.69	0.12	2.57	81K Series (1)	W25RT (2)	W25RT (2)					
YAV25L2TC516FX	G,H,I,K,M,		5/16	1	0.83	0.69	0.12	2.82	644 Series (1)	X25RT (2)	X25RT (2)					
YAV25L2TC38FX	DLO		3/8	1	0.83	0.69	0.12	2.95	444 Series (1)							
YAV25L2TC12E1FX			1/2	1	0.83	0.69	0.12	3.20								
YAV25L2NTCFX			1/2	1-3/4	0.83	0.69	0.12	4.14								

* Use PUADP1 adaptor with U dies in 46 Series

** The MM² conductor size referenced here is for both Class 2 and Class 5 conductor

*** The MM² conductor sizes listed are the recommendations for Class 5 conductor

▲ See tooling section of this catalog for complete tool and die listings. Use ONLY color-coded die recommendations for -FX connectors. For nest/indentor system contact factory

◆ For applications greater than 2000 Volts consult cable manufacturer for voltage stress relief instructions

Note: All dimensions shown are for reference only.

TYPES YA-L-2TC, YA-L-2TC-FX, YAV-L-2TC-FX (Continued)

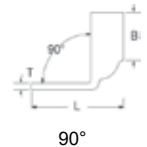
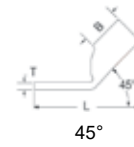
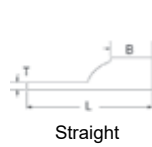

NOTE: Field bending straight lugs to achieve an angular connection will void UL Listing / CSA Certifications and BURNDY will not be liable for the connection.

Catalog Number	Conductor		Bolt Hole Size	Stud Hole Spacing	Tongue Width	Figure Dimensions			▲ Installation Tooling						Wire Strip Length
	AWG/KCMIL	MM ² ***				(B)	(T)	(L)	Dieless (# of Crimps)	MD6, OUR840, MD734R	500 Series	35, 750, 46* Series	Color Code	Die Index	
YAV26L2TC14FX	2/0 AWG 2/0 Flex G,H,I,K,M, DLO	70	1/4	5/8	0.93	0.81	0.13	2.56	MY29 Series (1) 644 Series (1) 444 Series (1) 81K Series (1)	W26VT (2) W26RT (2) X26RT (2)	W26VT (2) W26RT (2) X26RT (2)	U26RT (1)	Black	13	13/16
YAV26L2TC14E2FX			1/4	3/4	0.93	0.81	0.13	2.68							
YAV26L2TC516FX			5/16	1	0.93	0.81	0.13	2.99							
YAV26L2TC38FX			3/8	1	0.93	0.81	0.13	3.12							
YAV26L2TC38E10FX			3/8	1-1/4	0.93	0.81	0.13	3.37							
YAV26L2TC12E1FX			1/2	1	0.93	0.81	0.13	3.37							
YAV26L2NTCFX			1/2	1-3/4	0.93	0.81	0.13	4.31							
YAV27L2TC14FX	3/0 AWG 3/0 Flex G,H,I,K,M, DLO	95	1/4	5/8	1.03	1.00	0.14	2.79	MY29 Series (1) 644 Series (1) 444 Series (1) 81K Series (1)	W27VT (2) W27RT (2) X27RT (3)	W27VT (2) W27RT (2) X27RT (3)	U27RT (1)	Orange	14	1
YAV27L2TC38FX			3/8	1	1.03	1.00	0.14	3.35							
YAV27L2NTCFX			1/2	1.75	1.03	1.00	0.14	4.54							
YAV28L2TC14E2FX	4/0 AWG 4/0 Flex G,H,I,K,M, DLO	120	1/4	3/4	1.14	1.03	0.15	2.99	MY29 Series (1) 644 Series (1) 444 Series (1) 81K Series (1)	W28VT (2) W28RT (2) X28RT (3)	W28VT (2) W28RT (2) X28RT (3)	U28RT (1)	Purple	15	1-1/16
YAV28L2TC14FX			1/4	5/8	1.14	1.03	0.15	2.86							
YAV28L2TC516FX			5/16	1	1.14	1.03	0.15	3.30							
YAV28L2TC38FX			3/8	1	1.14	1.03	0.15	3.43							
YAV28L2TC12E1FX			1/2	1	1.14	1.03	0.15	3.68							
YAV28L2TC12FX			1/2	1-1/4	1.14	1.03	0.15	3.93							
YAV28L2NTCFX			1/2	1-3/4	1.14	1.03	0.15	4.62							
YAV29L2TC14FX	250 kcmil 4/0 Flex G,H,I,K,M, DLO	—	1/4	5/8	1.18	1.03	0.16	2.87	644 Series (1) 444 Series (1) 81K Series (1)	W29VT (2) X29RT (4)	W29VT (2) W29RT (2) X29RT (4)	U29RT (1)	Yellow	16	1-1/16
YAV29L2TC14E2FX			1/4	3/4	1.18	1.03	0.16	2.99							
YAV29L2TC516FX			5/16	1	1.18	1.03	0.16	3.31							
YAV29L2TC38FX			3/8	1	1.18	1.03	0.16	3.43							
YAV29L2TC12E1FX			1/2	1	1.18	1.03	0.16	3.68							
YAV29L2TC12FX			1/2	1-1/4	1.18	1.03	0.16	3.93							
YAV29L2NTCFX			1/2	1-3/4	1.18	1.03	0.16	4.62							
YA30L2TC516FX	250 kcmil G,H	—	5/16	1	1.20	1.03	0.16	3.32	644 Series (1) 444 Series (1) 81K Series (1)	W29VT (2) X29RT (4)	W29VT (2) W29RT (2) X29RT (4)	U29RT (1)	Yellow	16	1-1/16
YA30L2TC38FX			3/8	1	1.20	1.03	0.16	3.45							
YA30L2NTCFX			1/2	1-3/4	1.20	1.03	0.16	4.63							
YA31L2TC38FX	250 kcmil I,K,M, DLO 262	150	3/8	1	1.29	1.06	0.18	3.51	644 Series (1) 444 Series (1) 81K Series (1)	W30VT (2)	W30VT (2) W30RT (2)	U30RT (2)	White	17 or 298	1-1/8
YA31L2TC12FX			1/2	1-1/4	1.29	1.06	0.18	4.01							
YA31L2NTCFX			1/2	1-3/4	1.29	1.06	0.18	4.70							
YA32L2TC38FX	300 kcmil G,H,I,K,M, DLO 313	185	3/8	1	1.40	1.19	0.19	3.69	644 Series (1) 444 Series (1) 81K Series (1)	W31VT (2)	W31VT (2) W31RT (2)	U31RT (2)	Red	18 or 324	1-1/4
YA32L2NTCFX			1/2	1-3/4	1.40	1.19	0.19	4.88							
YA34L2TC516FX	350 kcmil G,H,I,K,M, DLO 373	240	5/16	1	1.55	1.27	0.23	3.75	644 Series (1) 444 Series (1) 81K Series (1)	W32VT (2)	W32VT (2) W32RT (2)	U32RT (2)	Blue	19 or 470	1-5/16
YA34L2TC38FX			3/8	1	1.55	1.27	0.23	3.88							
YA34L2NTC38FX			3/8	1-3/4	1.55	1.27	0.23	4.63							
YA34L2TC12FX			1/2	1-1/4	1.55	1.27	0.23	4.38							
YA34L2NTCFX			1/2	1-3/4	1.55	1.27	0.23	5.06							
YA36L2TC38FX	500 kcmil G,H, DLO 444	—	3/8	1	1.74	1.38	0.27	4.24	644 Series (1) 444 Series (1) 81K Series (1)	—	—	U34RT (2)	Brown	20 or 299	1-7/16
YA36L2NTCFX			1/2	1-3/4	1.74	1.38	0.27	5.24							

* Use PUADP1 adaptor with U dies in 46 Series

** The MM² conductor size referenced here is for both Class 2 and Class 5 conductor

*** The MM² conductor sizes listed are the recommendations for Class 5 conductor

▲ See tooling section of this catalog for complete tool and die listings. Use ONLY color-coded die recommendations for -FX connectors. For nest/indentor system contact factory

◆ For applications greater than 2000 Volts consult cable manufacturer for voltage stress relief instructions

Note: All dimensions shown are for reference only.

Compression Connections

Copper Compression — Flex — Two Hole
Standard Barrel — with Inspection Window

TYPES YA-L-2TC, YA-L-2TC-FX, YAV-L-2TC-FX (Continued)

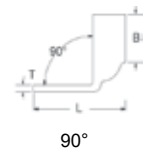
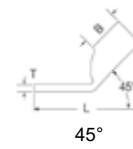
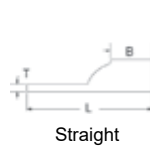

NOTE: Field bending straight lugs to achieve an angular connection will void UL Listing / CSA Certifications and BURNDY will not be liable for the connection.

Catalog Number	Conductor		Bolt Hole Size	Stud Hole Spacing	Tongue Width	Figure Dimensions			▲ Installation Tooling						Wire Strip Length
	AWG/KCMIL	MM ² ***				(B)	(T)	(L)	Dieless (# of Crimps)	MD6, OUR840, MD734R	500 Series	35, 750, 46* Series	Color Code	Die Index	
YA38L2TC516FX	500 kcmil H,I,K 550 kcmil G,H,I DLO 535	300	5/16	1	1.84	1.45	0.27	4.04	644 Series (1) 444 Series (1) 81K Series (1)	—	—	U38XRT (2)	Pink	L99	1-7/16
YA38L2TC38FX			3/8	1	1.84	1.45	0.27	4.35							
YA38L2TC12FX			1/2	1-1/4	1.84	1.45	0.27	4.67							
YA38L2NTCFX	600 kcmil G,H,I,K, DLO	—	1/2	1-3/4	1.84	1.45	0.27	5.35	644 Series (1) 444 Series (1) 81K Series (2)	—	—	U38RT (2)	Pink	400	1-1/2
YA39L2TC38E10FX			3/8	1-3/4	1.91	1.42	0.27	4.61							
YA39L2NTCFX	650 kcmil G, DLO 646	400	1/2	1-3/4	1.91	1.42	0.27	5.36	644 Series (1) 444 Series (1) 81K Series (2)	—	—	U39RT (2)	Black	24	1-5/16
YA40L2TC38FX			3/8	1	1.98	1.42	0.30	4.38							
YA40L2NTCFX	750 kcmil G,H, DLO 777	500	1/2	1-3/4	1.98	1.42	0.30	5.38	644 Series (1) 444 Series (1) 81K Series (2)	—	—	U44XRT (2) •P44XRT (2)	Yellow	L115	1-5/8
YA44L2TC38FX			3/8	1	2.19	1.65	0.33	4.74							
YA44L2TC12FX			1/2	1-1/4	2.19	1.65	0.33	5.05							
YA44L2TC12E3FX			1/2	1-1/2	2.19	1.65	0.33	5.30							
YA44L2NTCFX			1/2	1-3/4	2.19	1.65	0.33	5.74							
YA44L2TC58FX	5/8	1-1/2	2.19	1.65	0.33	5.55									

* Use PUADP-1 adaptor with U dies in 46 Series tooling

• P-RT dies for 46 Series only

** The MM² conductor size referenced here is for both Class 2 and Class 5 conductor

*** The MM² conductor sizes listed are the recommendations for Class 5 conductor

▲ See tooling section of this catalog for complete tool and die listings. Use ONLY color-coded die recommendations for -FX connectors. For nest/indentor system contact factory

◆ For applications greater than 2000 Volts consult cable manufacturer for voltage stress relief instructions

Note: All dimensions shown are for reference only.

TYPE YAV-L-2NT-FX

HYLUG™

Uninsulated Copper Compression Terminal
UL Listed 90° C, Up to 35 kV ♦

45° and 90° angles available. Please contact Customer Service to order:
1-800-346-4175

Features & Benefits

- Inspection windows allows for visual verification that the wire has been fully inserted prior to crimping the lug
- Narrow tongue/tang is designed to allow for more parallel terminations of wire in limited space applications
- Barrel is designed with an internal chamfer at the wire entry to ensure smooth insertion of the wire, preventing possible damaging of the wire strands during insertion
- Short/Standard length barrel is recommended for installations with limited space requirements
- Two hole tongue/tang is recommended when space permits as the 2-hole feature minimizes the terminations from loosening or rotating under vibration, movement, or heat cycling
- 45° and 90° angular lugs are available; please contact Customer Service
- Electro-tin plated unless otherwise specified to reduce galvanic corrosion (bimetallic) and resist corrosive elements
- Connectors are clearly marked with stamping and barrel color coding
- Connectors accommodating wire sizes #10 - 4/0 AWG accommodate both Flex and Code Wire. See Tables on each page for specific details
- Tables in this section identify flex wire as the nominal flex wire size followed by the wire classes and DLO wire size and stranding. For Class Wire Strand counts, see the table at the beginning of this section.
- BURNDY certifies its products using the BURNDY Engineered System and select other crimp tool manufacturers in accordance with one or more of the UL categories in order to obtain a UL Listing

Accessories

- Hardware - Section F
- PENETROX™ Oxide Inhibitor - Section F
- Heat and Cold Shrink Tubing - Section D
- WIREMIKE™ Wire Micrometer - Section F
- Wire Management (Cable Ties) - Section G

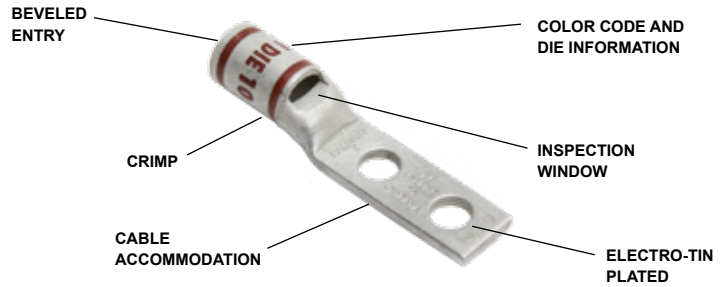

NOTE: Field bending straight lugs to achieve an angular connection will void UL Listing / CSA Certifications and BURNDY will not be liable for the connection.

Straight



45°

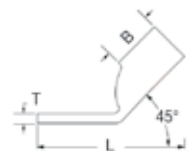

90°

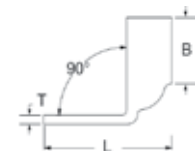

Compression Connections

Copper Compression — Flex — Two Hole
Narrow Tongue, Standard Barrel — with Inspection Window

TYPE YAV-L-2NT-FX (Continued)

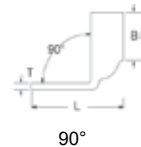
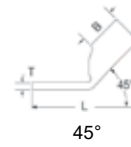
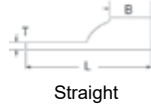

NOTE: Field bending straight lugs to achieve an angular connection will void UL Listing / CSA Certifications and BURNDY will not be liable for the connection.

Catalog Number	Conductor		Stud Hole Size	Stud Hole Spacing	Tongue Width	Figure Dimensions			Installation Tooling					Wire Strip Length		
	AWG/KCMIL	MM ² ***				(B)	(T)	(L)	Dieless (# of crimps)	MD6, OUR840, MD734R	500 Series	35, 750, 46* Series	Color Code		Die Index	
YAV4CL2NT10E1FX	#4 AWG #4 Flex G,H,I,K,M DLO	—	#10	1.00	0.41	0.50	0.09	2.33	MY29 Series (1)	W4CVT (1) W4CRT (1) X4CRT (1)	W4CVT (1) W4CRT (1) X4CRT (1)	U4CRT (1)	Gray	8	9/16	
YAV4CL2NT10FX			#10	5/8	0.41	0.50	0.09	1.95	Y122CMR (2) Y1MRTC (2) 81K Series (1) 644 Series (1) 444 Series (1)							
YAV4CL2NT14FX			1/4	.63"	0.45	0.50	0.09	2.08	444 Series (1)							
YAV2CL2NT10FX	#2 AWG #2 Flex G,H,I,K,M DLO	35	#10	.63"	0.48	0.63	0.10	2.14	MY29 Series (1)	W2CVT (1) W2CRT (1) X2CRT (1)	W2CVT (1) W2CRT (1) X2CRT (1)	U2CRT (1)	Brown	10	11/16	
YAV2CL2NT14E1FX			1/4	1.00"	0.48	0.63	0.10	2.63	Y122CMR (2) Y1MRTC (2) 81K Series (1) 644 Series (1) 444 Series (1)							
YAV2CL2NT14FX			1/4	.63"	0.48	0.63	0.10	2.26	444 Series (1)							
YAV1CL2NT14FX	#1 AWG #1 Flex G,H,I,K,M DLO	—	1/4	.63"	0.50	0.62	0.12	2.28	MY29 Series (1)	W1CVT (1) W1CRT (1) X1CRT (1)	W1CVT (1) W1CRT (1) X1CRT (1)	U1CRT (1)	Green	11	11/16	
YAV1CL2NT516FX			5/16	1.00"	0.58	0.63	0.12	2.72	644 Series (1) 444 Series (1) 81K Series (1)							
YAV25L2NT14E1FX	1/0 AWG 1/0 Flex G,H,I,K,M DLO	50	1/4	1.00"	0.64	0.69	0.12	2.76	MY29 Series (1)	W25VT (2) W25RT (2) X25RT (2)	W25VT (2) W25RT (2) X25RT (2)	U25RT (1)	Pink	12	13/16	
YAV25L2NT14FX			1/4	.63"	0.64	0.69	0.12	2.39								644 Series (1) 444 Series (1) 81K Series (1)
YAV25L2NT516FX			5/16	1.00"	0.58	0.69	0.12	2.82								81K Series (1)
YAV26L2NT14FX	2/0 AWG 2/0 Flex G,H,I,K,M DLO	70	1/4	0.63"	0.76	0.81	0.13	2.56	MY29 Series (1)	W26VT (2) W26RT (2) X26RT (2)	W26VT (2) W26RT (2) X26RT (2)	U26RT (1)	Black	13	13/16	
YAV26L2NT38FX			3/8	1.00"	0.63	0.81	0.13	3.23	644 Series (1) 444 Series (1) 81K Series (1)							
YAV26L2NT516FX			5/16	1.00"	0.58	0.81	0.13	2.99	81K Series (1)							
YAV28L2ENT14FX	4/0 AWG 4/0 Flex G,H,I,K,M DLO	—	1/4	.63	0.76	1.03	0.15	2.86	MY29 Series (1)	W28VT (2) W28RT (2) X28RT (3)	W28VT (2) W28RT (2) X28RT (3)	U28RT (1)	Purple	15	1-1/16	
YAV28L2NT38FX			3/8	1	0.94	1.03	0.15	3.43	644 Series (1) 444 Series (1) 81K Series (1)							
YAV29L2NT38FX	250 kcmil 4/0 Flex G,H,I,K,M DLO	—	3/8	1	0.94	1.03	0.16	3.43	644 Series (1) 444 Series (1) 81K Series (1)	W29VT (2) X29RT (4)	W29VT (2) W29RT (2) X29RT (4)	U29RT (1)	Yellow	16	1-1/16	
YA31L2NT38FX	250 kcmil I,K,M DLO 262	150	3/8	1.00"	0.96	1.06	0.18	3.51	644 Series (1) 444 Series (1) 81K Series (1)	W30VT (2)	W30VT (2) W30RT (2)	U30RT (2)	White	17 or 298	1-1/8	

Consult cable manufacturers for stress relief instructions

◆ For applications greater than 2000 Volts consult cable manufacturer for voltage stress relief instructions

* Use PUADP1 adaptor with U dies in 46 Series

*** The MM² conductor sizes Listed are the recommendations for Class 5 conductor

▲ See tooling section of this catalog for complete tool and die listings. Use ONLY color-coded die recommendations for -FX connectors

Note: All dimensions shown are for reference only

TYPE YAV-L-2NT-FX (Continued)

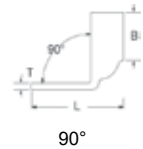
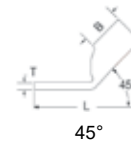
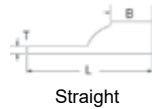

NOTE: Field bending straight lugs to achieve an angular connection will void UL Listing / CSA Certifications and BURNDY will not be liable for the connection.

Catalog Number	Conductor		Stud Hole Size	Stud Hole Spacing	Tongue Width	Figure Dimensions			Installation Tooling					Wire Strip Length	
	AWG/ KCMIL	MM ² ***				(B)	(T)	(L)	Dieless (# of crimps)	MD6, OUR840, MD734R	500 Series	35, 750, 46* Series	Color Code		Die Index
YA32L2NT38FX	300 kcmil G,H,I,K,M DLO 313	185	3/8	1.00"	0.96	1.19	0.20	3.69	644 Series (1) 444 Series (1) 81K Series (1)	W31VT (2)	W31VT (2) W31RT (2)	U31RT (2)	Red	18	1-1/4
YA34L2NT38FX	350 kcmil G,H,I,K,M DLO 373	240	3/8	1	0.96	1.27	0.23	3.88	644 Series (1) 444 Series (1) 81K Series (1)	W32VT (2)	W32VT (2) W32RT (2)	U32RT (2)	Blue	19 or 470	1-5/16
YA36L2NT38FX	500 kcmil G,H DLO 444	—	3/8	1.00"	1.63	1.38	0.27	4.24	644 Series (1) 444 Series (1) 81K Series (1)	—	—	U34RT (2)	Brown	20	1-7/16
YA36L2ENT38E10FX		—	3/8	1.25	1.50	1.38	0.27	4.49	644 Series (1) 444 Series (1) 81K Series (1)	—	—	U34RT (2)			
YA38L2ENT38FX	500 kcmil H,I,K 550 kcmil G,H,I DLO 535	300	3/8	1.00"	1.50	1.45	0.27	4.35	644 Series (1) 444 Series (1) 81K Series (1)	—	—	U38XRT (2)	Pink	L99	
YA38L2NT38FX		300	3/8	1	1.63	1.45	0.27	4.35	644 Series (1) 444 Series (1) 81K Series (1)	—	—	U38XRT (2)			
YA38L2NNTFX		300	1/2	1.75	1.63	1.45	0.27	5.35	644 Series (1) 444 Series (1) 81K Series (1)	—	—	U38XRT (2)			
YA40L2NNTFX	650 kcmil G DLO 646	400	1/2	1.75	1.63	1.42	0.30	5.38	644 Series (1) 444 Series (1) 81K Series (2)	—	—	U39RT (2)	Black	24	
YA44L2NNTFX	750 kcmil G,H DLO 777	500	1/2	1.75	1.63	1.65	0.33	5.74	644 Series (1) 444 Series (1) 81K Series (2)	—	—	U44XRT (2) •P44XRT (2)	Yellow	L115	1-5/8
YA44L2NT38FX			3/8	1	1.63	1.65	0.33	4.74							
YA45L2NT38FX	929 kcmil DLO	—	3/8	1.00"	1.70	2.00	0.38	5.18	—	—	—	P44RT (2)	White	27	2-1/16

Consult cable manufacturers for stress relief instructions

♦ For applications greater than 2000 Volts consult cable manufacturer for voltage stress relief instructions

* Use PUADP1 adaptor with U dies in 46 Series

• P-RT dies for 46 Series Tooling only

*** The MM² conductor sizes Listed are the recommendations for Class 5 conductor

▲ See tooling section of this catalog for complete tool and die listings. Use ONLY color-coded die recommendations for -FX connectors

Note: All dimensions shown are for reference only

Compression Connections

Copper Compression — Flex — Two Hole
Long Barrel — with Inspection Window

TYPE YAZ-FX

HYLUG™

Uninsulated Copper Compression Terminal
UL Listed 90° C, Up to 35 kV ♦

45° and 90° angles available. Please contact Customer Service to order:
1-800-346-4175

Features & Benefits

- Inspection windows allows for visual verification that the wire has been fully inserted prior to crimping the lug
- Barrel is designed with an internal chamfer at the wire entry to ensure smooth insertion of the wire, preventing possible damaging of the wire strands during insertion
- Long barrel allows for an increased number of crimps which will increase the mechanical strength of the connection
- Two hole tongue/tang is recommended when space permits as the 2-hole feature minimizes the terminations from loosening or rotating under vibration, movement, or heat cycling
- 45° and 90° angular lugs are available; please contact Customer Service
- Electro-tin plated unless otherwise specified to reduce galvanic corrosion (bimetallic) and resist corrosive elements
- Connectors are clearly marked with stamping and barrel color coding
- Connectors accommodating wire sizes #10 - 4/0 AWG accommodate both Flex and Code Wire. See Tables on each page for specific details
- Tables in this section identify flex wire as the nominal flex wire size followed by the wire classes and DLO wire size and stranding. For Class Wire Strand counts, see the table at the beginning of this section.
- BURNDY certifies its products using the BURNDY Engineered System and select other crimp tool manufacturers in accordance with one or more of the UL categories in order to obtain a UL Listing

Accessories

- Hardware - Section F
- PENETROX™ Oxide Inhibitor - Section F
- Heat and Cold Shrink Tubing - Section D
- WIREMIKE™ Wire Micrometer - Section F
- Wire Management (Cable Ties) - Section G

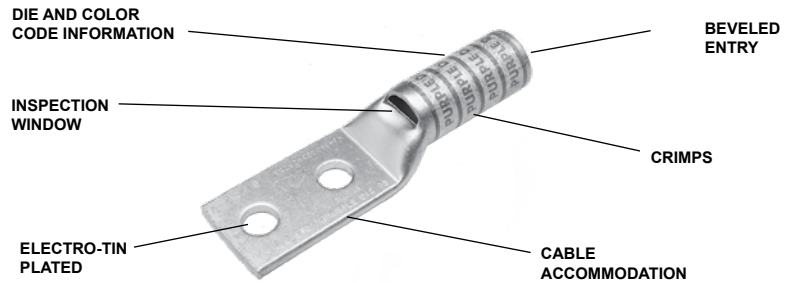

NOTE: Field bending straight lugs to achieve an angular connection will void UL Listing / CSA Certifications and BURNDY will not be liable for the connection.

Straight



45°

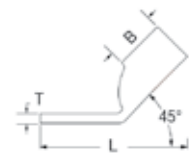

90°

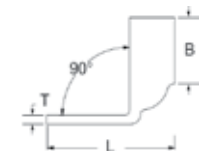

TYPE YAZ-FX (Continued)

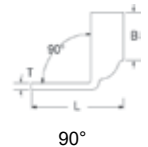
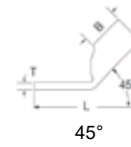
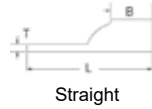

NOTE: Field bending straight lugs to achieve an angular connection will void UL Listing / CSA Certifications and BURNDY will not be liable for the connection.

Catalog Number	Conductor		Bolt Hole Size	Stud Hole Spacing	Tongue Width	Figure Dimensions			▲ Installation Tooling						Wire Strip Length	
	AWG/ KCMIL	MM ² ***				(B)	(T)	(L)	Dieless (# of Crimps)	MD6, OUR840, MD734R	500 Series	35, 750, 46* Series	Color Code	Die Index		
YAZV102TC14E1	14-10 AWG	2.5 - 4	1/4	1.00	0.41	0.69	0.05	2.53	MR20 (2) MRE1022B (2) Y122CMR (2)	—	—	—	—	—	—	3/4
YAZ8C2TC10FX	#8 AWG	10	#10	5/8	0.41	0.81	0.08	2.20	Y8MRB1 (1) MY29 Series (2) Y122CMR (2) Y1MRTC (2) 81K Series (1)	W8CVT (2) W8CRT (2) X8CRT (2)	W8CVT (2) W8CRT (2) X8CRT (2)	U8CRT (2)	Red	49	1	
YAZ8C2TC10E2FX	#8 Flex		#10	3/4	0.41	0.75	0.08	2.33								
YAZ8C2TC14FX	G,H,I,K,M		1/4	5/8	0.44	0.81	0.08	2.32								
YAZ8C2TC14E2FX	DLO		1/4	3/4	0.44	0.81	0.08	2.45								
YAZ8C2TC14E1FX	(37/24)		1/4	1	0.44	0.81	0.08	2.70								
YAZ8C2TC38FX	#6 Sol #8 Sol	3/8	1	0.58	0.81	0.06	2.89									
YAZV6C2TC10E2FX	#6 AWG	16	#10	3/4	0.48	0.75	0.08	2.64	MY29 Series (2) Y122CMR (2) Y1MRTC (2) 81K Series (1)	W5CVT (2) W5CRT (2) X5CRT (2)	W5CVT (2) W5CRT (2) X5CRT (2)	U5CRT (2)	Blue	7 or 374	1-3/16	
YAZV6C2TC14FX	#6 Flex		1/4	5/8	0.48	0.75	0.08	2.65								
YAZV6C2TC14E2FX	G,H,I,K,M		1/4	3/4	0.48	0.75	0.08	2.78								
YAZV6C2TC14E1FX	DLO		1/4	1	0.48	0.75	0.08	3.03								
YAZV6C2TC38E2FX	(61/24)		3/8	3/4	0.58	0.75	0.06	2.97								
YAZV6C2TC38E6FX	#6 Sol	3/8	7/8	0.58	0.75	0.06	3.09									
YAZV6C2TC38FX	#8 Sol	3/8	1	0.58	0.75	0.06	2.78									
YAZV4C2TC14FX	#4 AWG	—	1/4	5/8	0.55	1.25	0.09	2.83	Y1MRTC (4) Y122CMR (4) MY29 Series (2) 644 Series (1) 444 Series (1) 81K Series (1)	W4CVT (2) W4CRT (2) X4CRT (2)	W4CVT (2) W4CRT (2) X4CRT (2)	U4CRT (2)	Gray	8 or 346	1-5/16	
YAZV4C2TC14E2FX	#4 Flex		1/4	3/4	0.55	1.25	0.09	2.95								
YAZV4C2TC38E2-FX	G,H,I,K,M		3/8	3/4	0.58	1.25	0.08	3.14								
YAZV4C2TC38FX	DLO (105/24)		3/8	1	0.58	1.25	0.08	3.39								
YAZV2C2TC14FX	#2 AWG	35	1/4	5/8	0.68	1.38	0.10	3.01	Y122MRC (4) Y1MRTC (4) MY29 Series (4) 644 Series (1) 444 Series (1) 81K Series (1)	W2CVT (2) W2CRT (2) X2CRT (2)	W2CVT (2) W2CRT (2) X2CRT (2)	U2CRT (2)	Brown	10	1-7/16	
YAZV2C2TC14E2FX	#2 Flex		1/4	3/4	0.68	1.38	0.10	3.13								
YAZV2C2TC38FX	G,H,I,K,M		3/8	1	0.68	1.38	0.10	3.57								
YAZV2C2NTCFX	DLO (140/24)		1/2	1-3/4	0.83	1.38	0.10	4.76								
YAZV1C2TC14FX	#1 AWG	—	1/4	5/8	0.75	1.38	0.12	3.04	MY29 Series (2) 644 Series (1) 444 Series (1) 81K Series (2)	W1CVT (2) W1CRT1 (2) X1CRT1 (2)	W1CVT (2) W1CRT1 (2) X1CRT1 (2)	U1CRT1 (2)	Green	11 or 375	1-7/16	
YAZV1C2TC14E2FX	#1 Flex		1/4	3/4	0.75	1.38	0.12	3.16								
YAZV1C2TC14E1FX	G,H,I,K,M		1/4	1	0.75	1.38	0.12	3.41								
YAZV1C2TC516E6FX	DLO		5/16	7/8	0.75	1.38	0.12	3.35								
YAZV1C2TC516FX	(225/24)		5/16	1	0.75	1.38	0.12	3.47								
YAZV1C2TC38FX	#1 Sol	3/8	1	0.75	1.38	0.12	3.60									
YAZV252TC14FX	1/0 AWG	50	1/4	5/8	0.83	1.50	0.12	3.20	MY29 Series (2) 644 Series (1) 444 Series (1) 81K Series (2)	W25VT (4) W25RT (4) X25RT (4)	W25VT (4) W25RT (4) X25RT (4)	U25RT (2)	Pink	12 or 348	1-9/16	
YAZV252TC14E2FX	1/0 Flex		1/4	3/4	0.83	1.50	0.12	3.32								
YAZV252TC38FX	G,H,I,K,M		3/8	1	0.83	1.50	0.12	3.76								
YAZV252NTCFX	DLO (275/24)		1/2	1-3/4	0.83	1.50	0.12	4.95								

* Use PUADP1 adapter with U dies in 46 Series

** The MM² conductor size referenced here is for both Class 2 and Class 5 conductor

*** The MM² conductor sizes listed are the recommendations for Class 5 conductor

▲ See tooling section of this catalog for complete tool and die listings. Use ONLY color-coded die recommendations for -FX connectors. For nest/indenter system contact factory

◆ For applications greater than 2000 Volts consult cable manufacturer for voltage stress relief instructions

Note: All dimensions shown are for reference only.

Compression Connections

Copper Compression — Flex — Two Hole
Long Barrel — with Inspection Window

TYPE YAZ-FX (Continued)

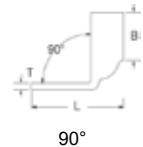
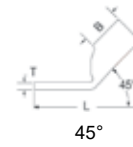
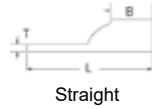

NOTE: Field bending straight lugs to achieve an angular connection will void UL Listing / CSA Certifications and BURNDY will not be liable for the connection.

Catalog Number	Conductor		Bolt Hole Size	Stud Hole Spacing	Tongue Width	Figure Dimensions			▲ Installation Tooling						Wire Strip Length
	AWG/KCMIL	MM ² ***				(B)	(T)	(L)	Dieless (# of Crimps)	MD6, OUR840, MD734R	500 Series	35, 750, 46* Series	Color Code	Die Index	
YAZV262TC14FX	2/0 AWG	70	1/4	5/8	0.93	1.50	0.13	3.20	MY29 Series (2) 644 Series (1) 444 Series (1) 81K Series (2)	W26VT (4) W26RT (4) X26RT (4)	W26VT (4) W26RT (4) X26RT (4)	U26RT (2)	Black	13	1-9/16
YAZV262TC14E2FX	2/0 Flex		1/4	3/4	0.93	1.50	0.13	3.32							
YAZV262TC38E6FX	G,H,I,K,M		3/8	.88	0.93	1.50	0.13	3.68							
YAZV262TC38FX	DLO		3/8	1	0.93	1.50	0.13	3.76							
YAZV262NTCFX	(325/24)		1/2	1-3/4	0.93	1.50	0.13	4.95							
YAZV272TC14E2FX	3/0 AWG	95	1/4	3/4	1.03	1.50	0.14	3.36	MY29 Series (2) 644 Series (1) 444 Series (1) 81K Series (2)	W27VT (4) W27RT (4) X27RT (4)	W27VT (4) W27RT (4) X27RT (4)	U27RT (2)	Orange	14	1-9/16
YAZV272TC38FX	3/0 Flex G,H,I,K,M DLO (450/24)		3/8	1	1.03	1.50	0.14	3.80							
YAZV282TC14E2FX	4/0 AWG	120	1/4	3/4	1.14	1.62	0.15	3.52	MY29 Series (2) 644 Series (1) 444 Series (1) 81K Series (2)	W28VT (4) W28RT (4) X28RT (6)	W28VT (4) W28RT (4) X28RT (6)	U28RT (2)	Purple	15	1-11/16
YAZV282TC38FX	4/0 Flex		3/8	1	1.14	1.62	0.15	3.96							
YAZV282NTCFX	G,H,I,K,M DLO (550/24)		1/2	1-3/4	1.14	1.62	0.15	4.93							
YAZV292NT516FX	250 kcmil 4/0 Flex G,H,I,K,M DLO (550/24)	—	5/16	1-3/4	0.96	2.00	0.16	4.62	644 Series (1) 444 Series (1) 81K Series (2)	W29VT (4) X29RT (8)	W29RT (4) W29VT (4) X29RT (8)	U29RT (2)	Yellow	16	2-1/16
YAZ302TC38FX	250 kcmil G,H	—	3/8	1	1.20	2.00	0.16	4.42	644 Series (1) 444 Series (1) 81K Series (2)	W29VT (4) X29RT (8)	W29RT (4) W29VT (4) X29RT (8)	U29RT (2)	Yellow	16	2-1/16
YAZ312TC14E2FX	250 kcmil	150	1/4	3/4	1.29	2.00	0.18	4.02	644 Series (1) 444 Series (1) 81K Series (2)	W30VT (4)	W30VT (4) W30RT (4)	U30RT (4)	White	17 or 298	2-1/16
YAZ312TC38FX	I,K,M		3/8	1	1.29	2.00	0.18	4.45							
YAZ312NTCFX	DLO 262 (650/24)		1/2	1.75	1.29	2.00	0.18	5.64							
YAZ322TC38FX	300 kcmil G,H,I,K,M DLO 313 (775/24)	185	3/8	1	1.40	2.12	0.19	4.62	Y / PAT644 (1) Y / PAT81KFT (2)	W31VT (4)	W31VT (4) W31RT (4)	U31RT (4)	Red	18 or 324	2-3/16
YAZ342TC14E2FX	350 kcmil	240	1/4	3/4	1.55	2.25	0.23	4.42	644 Series (1) 444 Series (1) 81K Series (2)	W32VT (4)	W32VT (4) W32RT (4)	U32RT (4)	Blue	19 or 470	2-5/16
YAZ342TC38FX	G,H,I,K,M		3/8	1	1.55	2.25	0.23	4.85							
YAZ342NT38FX	DLO 373		3/8	1	0.96	2.25	0.23	4.85							
YAZ342NTCFX	(925/24)		1/2	1-3/4	1.55	2.25	0.23	6.04							
YAZ362TC38FX	500 kcmil G,H DLO 444 (110/24)	—	3/8	1	1.74	2.69	0.27	5.55	644 Series (1) 444 Series (1) 81K Series (2)	—	—	U34RT (4)	Brown	20 or 299	2-3/4

* Use PUADP1 adapter with U dies in 46 Series

** The MM² conductor size referenced here is for both Class 2 and Class 5 conductor

*** The MM² conductor sizes listed are the recommendations for Class 5 conductor

▲ See tooling section of this catalog for complete tool and die listings. Use ONLY color-coded die recommendations for -FX connectors. For nest/indenter system contact factory

◆ For applications greater than 2000 Volts consult cable manufacturer for voltage stress relief instructions

Note: All dimensions shown are for reference only.

TYPE YAZ-FX (Continued)

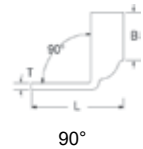
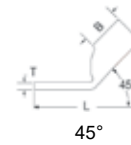
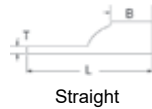

NOTE: Field bending straight lugs to achieve an angular connection will void UL Listing / CSA Certifications and BURNDY will not be liable for the connection.

Catalog Number	Conductor		Bolt Hole Size	Stud Hole Spacing	Tongue Width	Figure Dimensions			▲ Installation Tooling						Wire Strip Length
	AWG/ KCMIL	MM ² ***				(B)	(T)	(L)	Dieless (# of Crimps)	MD6, OUR840, MD734R	500 Series	35, 750, 46* Series	Color Code	Die Index	
YAZ382NT38FX	500 kcmil H,I,K	300	3/8	1	1.62	2.81	0.27	5.72	644 Series (1) 444 Series (1) 81K Series (2)	—	—	U38XRT (4)	Pink	L99	2-7/8
YAZ382TC38FX			3/8	1	1.84	2.81	0.27	5.72							
YAZ382NNTFX	550 KCMIL G,H,I		1/2	1-3/4	1.62	2.81	0.27	6.72							
YAZ382NTCFX	DLO 535 (1325/24)		1/2	1-3/4	1.84	2.81	0.27	6.72							
YAZ402NTCFX	650 kcmil G DLO 646 (1600/24)	—	1/2	1-3/4	1.98	2.94	0.30	6.89	644 Series (1) 444 Series (1)	—	—	U39RT (4)	Black	24	3
YAZ442NT38FX	750 kcmil G,H DLO 777 (1925/24)	—	3/8	1	1.62	3.00	0.33	6.08	644 Series (1) 444 Series (1) 81K Series (2)	—	—	U44XRT (4) •P44XRT (4)	Yellow	L115	3-1/16

* Use PUADP1 adapter with U dies in 46 Series

• P-RT dies for 46 Series Tooling only

** The MM² conductor size referenced here is for both Class 2 and Class 5 conductor

*** The MM² conductor sizes listed are the recommendations for Class 5 conductor

▲ See tooling section of this catalog for complete tool and die listings. Use ONLY color-coded die recommendations for -FX connectors. For nest/indentor system contact factory

◆ For applications greater than 2000 Volts consult cable manufacturer for voltage stress relief instructions

Note: All dimensions shown are for reference only.

Compression Connections

Copper Compression — Flex — Two Hole
Belled End, Long Barrel — No Inspection Window

TYPES YA-2TC-FXB, YAV-2TC-FXB

HYLUG™

Uninsulated Copper Compression Terminal
UL Listed 90° C, Up to 35 kV ♦

45° and 90° angles available. Please contact Customer Service to order:
1-800-346-4175

Features & Benefits

- No inspection window is ideal for more corrosive environments as the barrel transition is not open
- Barrel is designed with a “belled” end opening at the wire entry, to ensure smooth insertion of highly flexible stranded wire, preventing possible damaging of the wire strands during insertion
- Long barrel allows for an increased number of crimps which will increase the mechanical strength of the connection
- Two hole tongue/tang is recommended when space permits as the 2-hole feature minimizes the terminations from loosening or rotating under vibration, movement, or heat cycling
- 45° and 90° angular lugs are available; please contact Customer Service
- Electro-tin plated unless otherwise specified to reduce galvanic corrosion (bimetallic) and resist corrosive elements
- Connectors are clearly marked with stamping and barrel color coding
- Connectors accommodating wire sizes #10 - 4/0 AWG accommodate both Flex and Code Wire. See Tables on each page for specific details
- Tables in this section identify flex wire as the nominal flex wire size followed by the wire classes and DLO wire size and stranding. For Class Wire Strand counts, see the table at the beginning of this section.
- BURNDY certifies its products using the BURNDY Engineered System and select other crimp tool manufacturers in accordance with one or more of the UL categories in order to obtain a UL Listing

Accessories

- Hardware - Section F
- PENETROX™ Oxide Inhibitor - Section F
- Heat and Cold Shrink Tubing - Section D
- WIREMIKE™ Wire Micrometer - Section F
- Wire Management (Cable Ties) - Section G

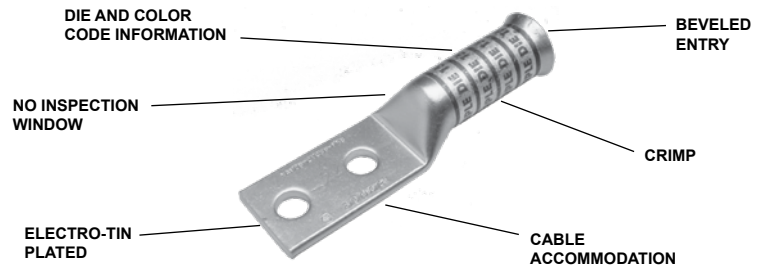

NOTE: Field bending straight lugs to achieve an angular connection will void UL Listing / CSA Certifications and BURNDY will not be liable for the connection.

Straight



45°

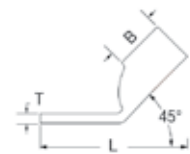

90°

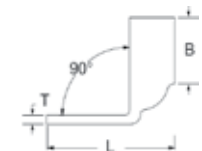

TYPES YA-2TC-FXB, YAV-2TC-FXB (Continued)

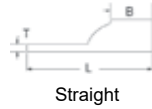

Straight



45°



90°

NOTE: Field bending straight lugs to achieve an angular connection will void UL Listing / CSA Certifications and BURNDY will not be liable for the connection.

Catalog Number	Conductor		Stud Hole Size	Stud Hole Spacing	Tongue Width	Figure Dimensions			Installation Tooling					Wire Strip Length	
	AWG/ KCMIL	MM ² ***				(B)	(T)	(L)	Dieless (# of crimps)	MD6, OUR840, MD734R	500 Series	35, 750, 46* Series	Color Code		Die Index
YA8C2TC14E2FXB	#8 AWG #8 Flex	**	1/4	3/4"	0.44	0.90	0.08	2.54	Y8MRB1 (2) Y1MRTC (2) MY29 Series (2) 81K Series (1)	W8CRT (2) W8CVT (2) X8CRT (2)	W8CVT (2) W8CRT (2)	U8CRT (2)	Red	49	1
YA8C2TC38FXB	G,H,I,K,M DLO (37/24) #6 Sol #8 Sol		3/8	1"	0.58	0.90	0.06	2.98							
YAV6C2TC14E2FXB	#6 AWG #6 Flex	**	1/4	3/4"	0.48	1.22	0.08	2.88	Y122CMR (2) Y1MRTC (2) MY29 Series (2) 81K Series (1)	W5CVT (2) W5CRT (2) X5CRT (2)	W5CVT (2) W5CRT (2)	U5CRT (2)	Blue	7	1-5/16
YAV6C2TC14FXB	G,H,I,K,M DLO		1/4	5/8"	0.48	1.22	0.08	2.76							
YAV6C2TC38FXB	G,H,I,K,M DLO	16	3/8	1"	0.58	1.22	0.06	3.32	Y122CMR (2) Y1MRTC (2) MY29 Series (2) 81K Series (1)	W5CVT (2) W5CRT (2) X5CRT (2)	W5CVT (2) W5CRT (2)	U5CRT (2)	Blue	7	1-5/16
YAV6C2NFXB	(61/24)		1/2	1-3/4"	0.83	1.22	0.12	4.51							
YAV4C2TC14E2FXB	#4 AWG #4 Flex	—	1/4	3/4"	0.55	1.22	0.09	2.93	Y122CMR (4) Y1MRTC (4) MY29 Series (2) 644 Series (1) 444 Series (1) 81K Series (1)	W4CVT (2) W4CRT (2) X4CRT (2)	W4CVT (2) W4CRT (2)	U4CRT (2)	Gray	8	1-5/16
YAV4C2TC14FXB	G,H,I,K,M DLO		1/4	5/8"	0.55	1.22	0.09	2.81							
YAV4C2TC516FXB	G,H,I,K,M DLO	—	5/16	1"	0.55	1.22	0.09	3.24	Y122CMR (4) Y1MRTC (4) MY29 Series (2) 644 Series (1) 444 Series (1) 81K Series (1)	W4CVT (2) W4CRT (2) X4CRT (2)	W4CVT (2) W4CRT (2)	U4CRT (2)	Gray	8	1-5/16
YAV4C2TC38FXB	(105/24)		3/8	1"	0.58	1.22	0.09	3.37							
YAV4C2NFXB	(105/24)	—	1/2	1-3/4"	0.83	1.22	0.12	4.56	Y122CMR (4) Y1MRTC (4) MY29 Series (2) 644 Series (1) 444 Series (1) 81K Series (1)	W4CVT (2) W4CRT (2) X4CRT (2)	W4CVT (2) W4CRT (2)	U4CRT (2)	Gray	8	1-5/16
YA3C2TC516FXB	#3 AWG #3 Flex		5/16	1"	0.55	1.48	0.09	3.51							
YA3C2TC38FXB	G,H,I,K,M DLO	—	3/8	1"	0.58	1.48	0.09	3.64	Y122CMR (4) Y1MRTC (4) MY29 Series (2) 644 Series (1) 444 Series (1) 81K Series (1)	W3CRT (2)	W3CRT (2)	U3CRT (2)	White	9	1-9/16
YAV3C2NFXB	(125/24)		1/2	1.75"	0.83	1.48	0.12	4.83							
YAV2C2TC14E1FXB	#2 AWG #2 Flex	35	1/4	1"	0.68	1.35	0.10	3.38	Y122CMR (4) Y1MRTC (4) MY29 Series (2) 644 Series (1) 444 Series (1) 81K Series (1)	W2CVT (2) W2CRT (2) X2CRT (2)	W2CVT (2) W2CRT (2)	U2CRT (2)	Brown	10	1-7/16
YAV2C2TC14E2FXB	G,H,I,K,M DLO		1/4	3/4"	0.68	1.35	0.10	3.13							
YAV2C2TC14FXB	G,H,I,K,M DLO	35	1/4	5/8"	0.68	1.35	0.10	3.00	Y122CMR (4) Y1MRTC (4) MY29 Series (2) 644 Series (1) 444 Series (1) 81K Series (1)	W2CVT (2) W2CRT (2) X2CRT (2)	W2CVT (2) W2CRT (2)	U2CRT (2)	Brown	10	1-7/16
YAV2C2TC38FXB	(150/24)		3/8	1"	0.68	1.35	0.10	3.57							
YAV2C2TC516FXB	G,H,I,K,M DLO	—	5/16	1"	0.68	1.35	0.10	3.44	Y122CMR (4) Y1MRTC (4) MY29 Series (2) 644 Series (1) 444 Series (1) 81K Series (1)	W2CVT (2) W2CRT (2) X2CRT (2)	W2CVT (2) W2CRT (2)	U2CRT (2)	Brown	10	1-7/16
YAV2C2NFXB	(150/24)		1/2	1-3/4"	0.83	1.35	0.12	4.76							
YAV1C2TC38FXB	#1 AWG #1 Flex	—	3/8	1"	0.75	1.50	0.12	3.74	MY29 Series (2) 644 Series (1) 444 Series (1) 81K Series (1)	W1CVT (2) W1CRT1 (2) X1CRT1 (2)	W1CVT (2) W1CRT1 (2)	U1CRT1 (2)	Green	11	1-9/16
YAV1C2NFXB	G,H,I,K,M DLO (225/24)		1/2	1-3/4"	0.83	1.50	0.11	4.92							
YAV252TC14E2FXB	1/0 AWG 1/0 Flex	50	1/4	3/4"	0.83	1.50	0.12	3.34	MY29 Series (2) 644 Series (1) 444 Series (1) 81K Series (1)	W25RT (4) W25VT (4) X25RT (4)	W25RT (4) W25VT (4)	U25RT (2)	Pink	12	1-9/16
YAV252TC14FXB	G,H,I,K,M DLO		1/4	5/8"	0.83	1.50	0.12	3.21							
YAV252TC38FXB	(275/24)	50	3/8	1"	0.83	1.50	0.12	3.78	MY29 Series (2) 644 Series (1) 444 Series (1) 81K Series (1)	W25RT (4) W25VT (4) X25RT (4)	W25RT (4) W25VT (4)	U25RT (2)	Pink	12	1-9/16
YAV262TC14E2FXB	2/0 AWG 2/0 Flex		1/4	3/4"	0.93	1.63	0.13	3.52							
YAV262TC14FXB	G,H,I,K,M DLO	70	1/4	5/8"	0.93	1.63	0.13	3.40	MY29 Series (2) 644 Series (1) 444 Series (1) 81K Series (1)	W26RT (4) W26VT (4) X26RT (4)	W26RT (4) W26VT (4)	U26RT (2)	Black	13	1-13/16
YAV262NTC38FXB	G,H,I,K,M DLO		3/8	1-3/4"	0.93	1.63	0.13	4.71							
YAV262TC38FXB	(325/24)	70	3/8	1"	0.93	1.63	0.13	3.96	MY29 Series (2) 644 Series (1) 444 Series (1) 81K Series (1)	W26RT (4) W26VT (4) X26RT (4)	W26RT (4) W26VT (4)	U26RT (2)	Black	13	1-13/16
YAV262NFXB	(325/24)		1/2	1-3/4"	0.93	1.63	0.13	5.15							

Consult cable manufacturers for stress relief instructions

◆ For applications greater than 2000 Volts consult cable manufacturer for voltage stress relief instructions

* Use PUADP1 adaptor with U dies in 46 Series

** The MM² conductor sizes referenced here are for both Class 2 and Class 5 conductors

*** The MM² conductor sizes listed are the recommendations for Class 5 conductor

‡ P-RT die sets for use in 46 Series only, PUADP1 adaptor not required

Note: All dimensions shown are for reference only.

▲ See tooling section of this catalog for complete tool and die listings. Use ONLY color-coded die recommendations for -FX connectors

Compression Connections

Copper Compression — Flex — Two Hole
Belled End, Long Barrel — No Inspection Window

TYPES YA-2TC-FXB, YAV-2TC-FXB (Continued)

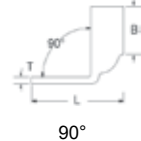
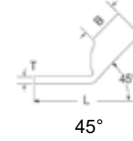
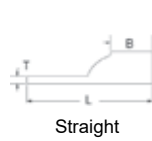

NOTE: Field bending straight lugs to achieve an angular connection will void UL Listing / CSA Certifications and BURNDY will not be liable for the connection.

Catalog Number	Conductor		Stud Hole Size	Stud Hole Spacing	Tongue Width	Figure Dimensions			Installation Tooling						Wire Strip Length
	AWG/KCMIL	MM ² ***				(B)	(T)	(L)	Dieless (# of crimps)	MD6, OUR840, MD734R	500 Series	35, 750, 46* Series	Color Code	Die Index	
YAV272TC14E2FXB	3/0 AWG	95	1/4	3/4"	1.03	1.64	0.14	3.58	MY29 Series (2) 644 Series (1) 444 Series (1) 81K Series (2)	W27RT (4) W27VT (4) X27RT (4)	W27RT (4) W27VT (4) X27RT (4)	U27RT (2)	Orange	14	1-13/16
YAV272TC38FXB	3/0 Flex		3/8	1"	1.03	1.64	0.14	4.01							
YAV272NFXB	G,H,I,K,M DLO (450/24)	1/2	1-3/4"	1.03	1.64	0.14	5.20								
YAV282TC14E2FXB	4/0 AWG	**	1/4	3/4"	1.14	1.77	0.14	3.76	MY29 Series (2) 644 Series (1) 444 Series (1) 81K Series (2)	W28RT (4) W28VT (4) X28RT (6)	W28RT (4) W28VT (4) X28RT (6)	U28RT (2)	Purple	15	1-7/8
YAV282TC38FXB	4/0 Flex	120	3/8	1"	1.14	1.77	0.14	4.20							
YAV282NT38FXB	G,H,I,K,M DLO (550/24)	**	3/8	1"	1.14	1.77	0.14	4.20							
YAV282NTC38FXB	G,H,I,K,M DLO (550/24)	**	3/8	1-3/4"	1.14	1.77	0.14	4.20	MY29 Series (2) 644 Series (1) 444 Series (1) 81K Series (2)	W28RT (4) W28VT (4) X28RT (6)	W28RT (4) W28VT (4) X28RT (6)	U28RT (2)	Purple	15	1-7/8
YAV282NFXB	G,H,I,K,M DLO (550/24)	120	1/2	1-3/4"	1.14	1.77	0.14	5.39							
YAV292TC14E2FXB	250 kcmil	—	1/4	3/4"	1.18	2.16	0.16	4.19							
YAV292TC38FXB	4/0 Flex		3/8	1"	1.18	2.16	0.16	3.62							
YAV292NT38FXB	G,H,I,K,M DLO (550/24)	—	3/8	1"	0.75	2.16	0.16	5.54							
YAV292NTC38FXB	G,H,I,K,M DLO (550/24)	—	3/8	1-3/4"	1.18	2.16	0.16	5.37	644 Series (1) 444 Series (1) 81K Series (2)	W29VT (4) X29RT (6)	W29RT (4) W29VT (4) X29RT (6)	U29RT (2)	Yellow	16	2-1/4
YAV292NFXB	G,H,I,K,M DLO (550/24)	—	1/2	1-3/4"	1.18	2.16	0.16	5.81							
YA302NFXB	250 kcmil G,H	—	1/2	1-3/4"	1.20	2.16	0.16	5.80	644 Series (1) 444 Series (1) 81K Series (2)	W29VT (4) X29RT (6)	W29RT (4) W29VT (4) X29RT (6)	U29RT (2)	Yellow	16	2-1/4
YA312TC38FXB	250 kcmil 4/0 Flex	150	3/8	1"	1.29	2.18	0.18	4.66	644 Series (1) 444 Series (1) 81K Series (2)	W30VT (4)	W30RT (4) W30VT (4)	U30RT (4)	White	17	2-1/4
YA312NFXB	G,H,I,K,M DLO (550/24)		1/2	1-3/4"	1.29	2.18	0.18	5.85							
YA322TC38FXB	300 kcmil G,H,I,K,M DLO 313 (775/24)	185	3/8	1"	1.40	2.32	0.19	4.85	644 Series (1) 444 Series (1) 81K Series (2)	W31VT (4)	W31RT (4) W31VT (4)	U31RT (4)	Red	18	2-1/4
YA322NFXB	G,H,I,K,M DLO 313 (775/24)		1/2	1-3/4"	1.40	2.32	0.19	6.04							
YA342TC38FXB	350 kcmil G,H,I,K,M DLO 373 (925/24)	240	3/8	1"	1.55	2.48	0.23	5.10	644 Series (1) 444 Series (1) 81K Series (2)	W32VT (4)	W32RT (4) W32VT (4)	U32RT (4)	Blue	19	2-9/16
YA342NFXB	G,H,I,K,M DLO 373 (925/24)		1/2	1-3/4"	1.55	2.48	0.23	6.29							
YA362NFXB	500 kcmil G,H DLO 444 (110/24)	300	1/2	1-3/4"	1.73	2.95	0.26	6.84	644 Series (1) 444 Series (1) 81K Series (2)	—	—	U40RT (4)	Brown	20	3-1/16

Consult cable manufacturers for stress relief instructions

◆ For applications greater than 2000 Volts consult cable manufacturer for voltage stress relief instructions

* Use PUADP1 adaptor with U dies in 46 Series

** The MM² conductor sizes referenced here are for both Class 2 and Class 5 conductors

*** The MM² conductor sizes listed are the recommendations for Class 5 conductor

‡ P-RT die sets for use in 46 Series only, PUADP1 adapter not required

Note: All dimensions shown are for reference only.

▲ See tooling section of this catalog for complete tool and die listings. Use ONLY color-coded die recommendations for -FX connectors

TYPES YA-2TC-FXB, YAV-2TC-FXB (Continued)

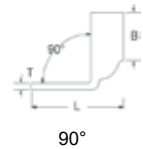
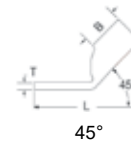
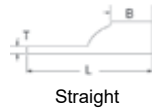

NOTE: Field bending straight lugs to achieve an angular connection will void UL Listing / CSA Certifications and BURNDY will not be liable for the connection.

Catalog Number	Conductor		Stud Hole Size	Stud Hole Spacing	Tongue Width	Figure Dimensions			Installation Tooling					Wire Strip Length		
	AWG/ KCMIL	MM ² ***				(B)	(T)	(L)	Dieless (# of crimps)	MD6, OUR840, MD734R	500 Series	35, 750, 46* Series	Color Code		Die Index	
YA382NFXB	500 kcmil H,I,K	300	1/2	1-3/4"	1.84	3.08	0.26	7.01	644 Series (1) 444 Series (1) 81K Series (2)	—	—	U38XRT (4)	Pink	L99	3-3/16	
YA382FXBG2			1/2	2"	1.84	3.08	0.27	6.82								
YA382FXBG3	550 kcmil G,H,I	1/2	1-3/16"	1.84	3.08	0.27	6.26									
YA382TC38FXB	DLO 535 (325/24)	—	3/8	1"	1.84	3.08	0.26	6.01								
YA402NFXB	650 kcmil G DLO 646 (1600/24)	400	1/2	1-3/4"	1.98	3.24	0.30	7.22	644 Series (1) 444 Series (1) 81K Series (3)	—	—	U39RT (4)	Black	24	3-5/16	
YA442TC38FXB	750 kcmil G,H	500	3/8	1"	2.19	3.33	0.33	6.44							U44XRT (4) •P44XRT (4)	Yellow
YA442NFXB	DLO 777 (1925/24)		—	1/2	1-3/4"	2.19	3.33	0.33	7.44							
YA462NFXB	1111 kcmil DLO (2750/24)	—	1/2	1-3/4"	2.69	3.58	0.39	7.91	—			•P45RT (4)**	—	29	3-11/16	

Consult cable manufacturers for stress relief instructions

◆ For applications greater than 2000 Volts consult cable manufacturer for voltage stress relief instructions

* Use PUADP-1 adaptor with U dies in 46 Series tools

• P-RT dies for 46 Series tools only

** The MM² conductor sizes referenced here are for both Class 2 and Class 5 conductors

*** The MM² conductor sizes listed are the recommendations for Class 5 conductor

Note: All dimensions shown are for reference only.

▲ See tooling section of this catalog for complete tool and die listings. Use ONLY color-coded die recommendations for -FX connectors

Compression Connections

Copper Compression — Flex — Two Hole
Narrow Tongue, Long Barrel — with Inspection Window

TYPES YAZ-2-NTFX, YAZV-2NTFX

HYLUG™

Uninsulated Copper Compression Terminal
UL Listed 90° C, Up to 35 kV ♦

45° and 90° angles available. Please contact Customer Service to order:
1-800-346-4175

Features & Benefits

- Inspection window allows for visual verification that the wire has been fully inserted prior to crimping the lug
- Narrow tongue/tang is designed to allow for more parallel terminations of wire in limited space applications
- Barrel is designed with an internal chamfer at the wire entry to ensure smooth insertion of the wire, preventing possible damaging of the wire strands during insertion
- Long barrel allows for an increased number of crimps which will increase the mechanical strength of the connection
- Two hole tongue/tang is recommended when space permits as the 2-hole feature minimizes the terminations from loosening or rotating under vibration, movement, or heat cycling
- 45° and 90° angular lugs are available; please contact Customer Service
- Electro-tin plated unless otherwise specified to reduce galvanic corrosion (bimetallic) and resist corrosive elements
- Connectors are clearly marked with stamping and barrel color coding
- Connectors accommodating wire sizes #10 - 4/0 AWG accommodate both Flex and Code Wire. See Tables on each page for specific details
- Tables in this section identify flex wire as the nominal flex wire size followed by the wire classes and DLO wire size and stranding. For Class Wire Strand counts, see the table at the beginning of this section.
- BURNDY certifies its products using the BURNDY Engineered System and select other crimp tool manufacturers in accordance with one or more of the UL categories in order to obtain a UL Listing

Accessories

- Hardware - Section F
- PENETROX™ Oxide Inhibitor - Section F
- Heat and Cold Shrink Tubing - Section D
- WIREMIKE™ Wire Micrometer - Section F
- Wire Management (Cable Ties) - Section G

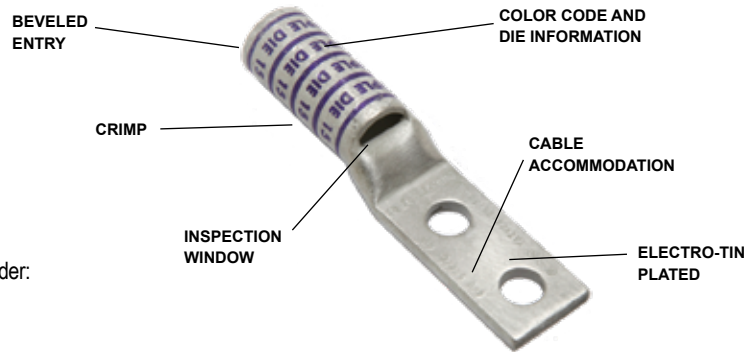

NOTE: Field bending straight lugs to achieve an angular connection will void UL Listing / CSA Certifications and BURNDY will not be liable for the connection.

Straight



45°

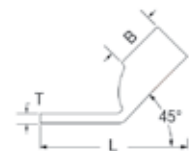

90°

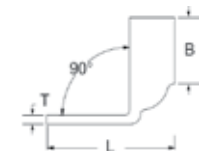

TYPES YAZ-2-NTFX, YAZV-2NTFX (Continued)

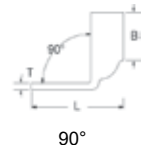
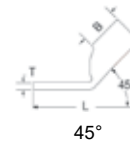
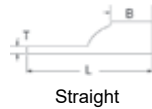

NOTE: Field bending straight lugs to achieve an angular connection will void UL Listing / CSA Certifications and BURNDY will not be liable for the connection.

Catalog Number	Stud Hole Size		Stud Hole Size	Stud Hole Spacing	Tongue Width	Figure Dimensions			▲ Installation Tooling					Wire Strip Length	
	AWG/ KCMIL	MM ²				(B)	(T)	(L)	Dieless (# of crimps)	MD6, OUR840, MD734R	500 Series	35, 750, 46* Series	Color Code		Die Index
YAZV4C2NT14E2FX	#4 AWG #4 Flex G,H,I,K,M DLO (105/24)	—	1/4	0.75	0.44	1.25	0.09	2.95	Y122CMR (4) Y1MRTC (4) MY29 Series (4) 644 Series (1) 444 Series (1) 81K Series (1)	W4CVT (2) W4CRT (2) X4CRT (2)	W4CVT (2) W4CRT (2) X4CRT (2)	U4CRT (2)	Gray	8	1-5/16
YAZV2C2NT14E2FX	#2 AWG #2 Flex G,H,I,K,M DLO (150/24)	35	1/4	0.75	0.50	1.38	0.10	3.14	Y12CMR (4) Y1MRTC (4) MY29 Series (2) 644 Series (1) 444 Series (1) 81K Series (1)	W2CVT (2) W2CRT (2) X2CRT (2)	W2CVT (2) W2CRT (2) X2CRT (2)	U2CRT (2)	Brown	10	1-7/16
YAZV252NT14FX	1/0 AWG 1/0 Flex G,H,I,K,M DLO (275/24)	—	1/4	.62	0.48	1.50	0.12	3.35	MY29 Series (2) 644 Series (1) 444 Series (1) 81K Series (2) 4PC Series (2)	W25RT (4) X25RT (4) W25VT (4)	W25RT (4) X25RT (4) W25VT (4)	U25RT (2)	Pink	12 or 348	1-9/16
YAZV282NT38FX	4/0 AWG 4/0 Flex G,H,I,K,M DLO (550/24)	—	3/8	1.00	0.94	1.62	0.17	3.96	MY29 Series (2) 644 Series (1) 444 Series (1) 81K Series (2)	W28VT (4) W28RT (4) X28RT (6)	W28VT (4) W28RT (4) X28RT (6)	U28RT (2)	Purple	15	1-11/16
YAZV292NT516FX	250 kcmil 4/0 Flex G,H,I,K,M DLO (550/24)	—	5/16	1.00	0.96	2.00	0.16	4.28	644 Series (1) 444 Series (1) 81K Series (2)	W29VT (4) X29RT (8)	W29RT (4) W29VT (4) X29RT (8)	U29RT (2)	Yellow	16	2-1/16
YAZ342NT38FX	350 kcmil G,H,I,K,M DLO 373 (925/24)	240	3/8	1.00	0.96	2.25	0.23	4.85	644 Series (1) 444 Series (1) 81K Series (2)	W32VT (4)	W32VT (4) W32RT (4)	U32RT (4)	Blue	19	2-5/16
YAZ382ENT38FX	500 kcmil H,I,K	300	3/8	1.00	1.46	2.81	0.27	5.72	644 Series (1) 444 Series (1) 81K Series (2)	—	—	U38XRT (4)	Pink	L99	2-7/8
YAZ382NT38FX	H,I,K		3/8	1.00	1.62	2.81	0.27	5.72							
YAZ382NNTFX	550 kcmil G,H,I DLO 535 (1325/24)		1/2	1.75	1.62	2.81	0.27	6.72							
YAZ442NT38FX	750 kcmil G,H DLO 777 (1925/24)	500	3/8	1.00	1.62	3.00	0.33	6.09	644 Series (1) 444 Series (1) 81K Series (2)	—	—	U44XRT (4) +P44XRT (4)	Yellow	L115	3-1/16

Consult cable manufacturers for stress relief instructions

♦ For applications greater than 2000 Volts consult cable manufacturer for voltage stress relief instructions

*** The MM² conductor sizes listed are the recommendations for Class 5 conductor.

* Use PUADP-1 adaptor with U dies in 46 Series tools

• P-RT dies for 46 Series tools

▲ See tooling section of this catalog for complete tool and die listings. Use ONLY color-coded die recommendations for -FX connectors

Note: All dimensions shown are for reference only.

Compression Connections

Copper Compression — Flex — One Hole
Standard Barrel, Tin-Zinc Plated — No Inspection Window

TYPE YAG-L-FXTZ

HYTIN-ZCLAD™

Uninsulated Copper Compression Terminal, Tin-Zinc Plated
UL Listed 90° C, Up to 35 kV ♦

45° and 90° angles available. Please contact Customer Service to order:
1-800-346-4175

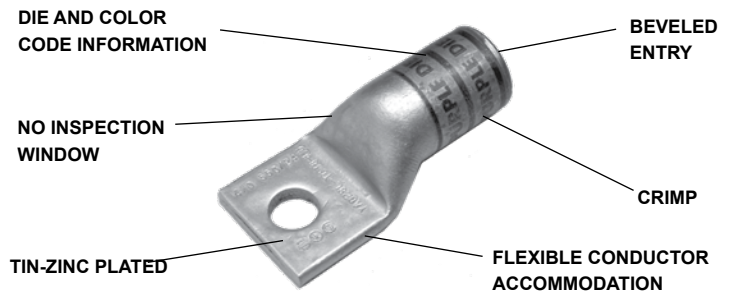

Features & Benefits

- No inspection window is ideal for more corrosive environments as the barrel transition is not open
- Barrel is designed with an internal chamfer at the wire entry to ensure smooth insertion of the wire, preventing possible damaging of the wire strands during insertion
- Short/Standard length barrel is recommended for installations with limited space requirements
- 45° and 90° angular lugs are available; please contact Customer Service
- Tin-Zinc plated for battery connectors or other heavy duty equipment, to reduce the corrosion from lead/acid batteries
- Connectors are clearly marked with stamping and barrel color coding
- Connectors accommodating wire sizes #10 - 4/0 AWG accommodate both Flex and Code Wire. See Tables on each page for specific details
- BURNDY certifies its products using the BURNDY Engineered System and select other crimp tool manufacturers in accordance with one or more of the UL categories in order to obtain a UL Listing

NOTE: Field bending straight lugs to achieve an angular connection will void UL Listing / CSA Certifications and BURNDY will not be liable for the connection.

Straight



45°

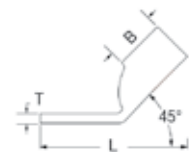

90°



Accessories

- Hardware - Section F
- PENETROX™ Oxide Inhibitor - Section F
- Heat and Cold Shrink Tubing - Section D
- WIREMIKE™ Wire Micrometer - Section F
- Wire Management (Cable Ties) - Section G

TYPE YAG-L-FXTZ (Continued)

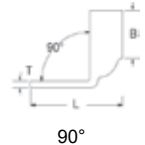
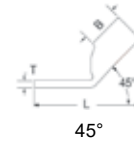
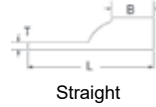

NOTE: Field bending straight lugs to achieve an angular connection will void UL Listing / CSA Certifications and BURNDY will not be liable for the connection.

Catalog Number	Fig #	Conductor		Stud Hole Size	Tongue Width	Figure Dimensions			Installation Tooling (# of crimps)					Wire Strip Length
		AWG/ KCML	MM ² ***			(B)	(T)	(L)	Dieless	MD6, 500, 600 Series, OUR840, MD734R	35, 750, 46* Series	Color Code	Die Index	
YAG8CLTC14FXTZ	1	#8 AWG #8 Flex G,H,I,K,M DLO (37/24)	10	1/4	0.44	0.44	0.08	1.32	MY29 Series (1) Y122CMR (1) Y1MRTC (1) 81K Series (1)	W8CVT (1) W8CRT (1) X8CRT (1)	U8CRT (1)	Red	49	1/2
YAG8CLTC38FXTZ	1	#6 SOL #8 SOL		3/8	0.58	0.44	0.06	1.51						
YAG6CLTC14FXTZ	1	#6 AWG #6 Flex G,H,I,K,M DLO (61/24)	16	1/4	0.48	0.50	0.08	1.43	MY29 Series (1) Y122CMR (1) Y1MRTC (1) 81K Series (1)	W5CVT (1) W5CRT (1) X5CRT (1)	U5CRT (1)	Blue	7	1/2
YAG6CLTC516FXTZ	1			5/16	0.52	0.50	0.07	1.49						
YAG6CLTC38FXTZ	1			3/8	0.58	0.50	0.06	1.61						
YAG6CLTC12FXTZ	1			1/2	0.75	0.50	0.12	1.86						
YAG4CLTC14FXTZ	1	#4 AWG #4 Flex G,H,I,K,M DLO (105/24)	—	1/4	0.55	0.50	0.09	1.48	MY29 Series (1) Y122CMR (2) Y1MRTC (2) 81K Series (1) 644 Series (1) 444 Series (1)	W4CVT (1) W4CRT (1) X4CRT (1)	U4CRT (1)	Gray	8	1/2
YAG4CLTC516FXTZ	1			5/16	0.55	0.50	0.09	1.55						
YAG4CLTC38FXTZ	1			3/8	0.58	0.50	0.08	1.67						
YAG2CLTC14FXTZ	1	#2 AWG #2 Flex G,H,I,K,M DLO (150/24)	35	1/4	0.68	0.63	0.10	1.64	MY29 Series (1) Y122CMR (2) Y1MRTC (2) 881K Series (1) 644 Series (1) 444 Series (1)	W2CRT (1) W2CVT (1) X2CRT (1)	U2CRT (1)	Brown	10	11/16
YAG2CLTC516FXTZ	1			5/16	0.68	0.63	0.10	1.70						
YAG2CLTC38FXTZ	1			3/8	0.68	0.63	0.10	1.83						
YAG2CLTC12FXTZ	1			1/2	0.73	0.63	0.09	2.12						
YAG1CLTC516FXTZ	1	#1 AWG #1 Flex G,H,I,K,M DLO (225/24)	—	5/16	0.75	0.69	0.12	1.73	MY29 Series (1) 81K Series (1) 644 Series (1) 444 Series (1)	W1CVT (1) W1CRT (1) X1CRT (1)	U1CRT1 (1)	Green	11	11/16
YAG25LTC38FXTZ	1	1/0 AWG 1/0 Flex G,H,I,K,M DLO (275/24)	50	3/8	0.83	0.69	0.12	1.96	MY29 Series (1) 81K Series (1) 644 Series (1) 444 Series (1)	W25VT (2) W25RT (2) X25RT (2)	U25RT (1)	Pink	12	11/12
YAG25LTC12FXTZ	1			1/2	0.83	0.69	0.12	2.21						
YAG26LTC38FXTZ	1	2/0 AWG 2/0 Flex G,H,I,K,M DLO (325/24)	70	3/8	0.93	0.81	0.13	2.13	MY29 Series (1) 81K Series (1) 644 Series (1) 444 Series (1)	W26VT (2) W26RT (2) X26RT (2)	U26RT (1)	Black	13	13/16
YAG26LTC516FXTZ	1			5/16	0.93	0.81	0.13	2.01						
YAG26LTC12FXTZ	1			1/2	0.93	0.81	0.13	2.38						
YAG27LTC14FXTZ	1	3/0 AWG 3/0 Flex G,H,I,K,M DLO (450/24)	95	1/4	1.03	1.00	0.14	2.18	MY29 Series (1) 81K Series (1) 644 Series (1) 444 Series (1)	W27VT (2) W27RT (2) X27RT (3)	U27RT (1)	Orange	14	1
YAG27LTC38FXTZ	1			3/8	1.03	1.00	0.14	2.37						
YAG27LTC12FXTZ	1			1/2	1.03	1.00	0.14	2.62						

* Use PUADP1 adapter with U dies in 46 Series of tools

*** The MM² conductor sizes listed are the recommendations for Class 5 conductor.

♦ For applications greater than 2000 Volts consult cable manufacturer for voltage stress relief instructions.

Note: All dimensions shown are for reference only.

Compression Connections

Copper Compression — Flex — One Hole
Standard Barrel, Tin-Zinc Plated — No Inspection Window

TYPE YAG-L-FXTZ (Continued)

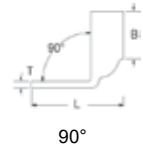
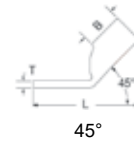
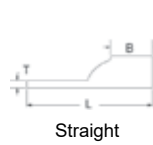

NOTE: Field bending straight lugs to achieve an angular connection will void UL Listing / CSA Certifications and BURNDY will not be liable for the connection.

Catalog Number	Fig #	Conductor		Stud Hole Size	Tongue Width	Figure Dimensions			Installation Tooling (# of crimps)					Wire Strip Length	
		AWG/ KCML	MM ² ***			(B)	(T)	(L)	Dieless	MD6, 500, 600 Series, OUR840, MD734R	35, 750, 46* Series	Color Code	Die Index		
YAG28LTC14FXTZ	1			1/4	1.14	1.03	0.15	2.26	MY29 Series (1) 81K Series (1) 644 Series (1) 444 Series (1)	W28VT (2) W28RT (2) X28RT (3)	U28RT (1)	Purple	15	1-1/16	
YAG28LTC516FXTZ	1	4/0 AWG		5/16	1.14	1.03	0.15	2.32							
YAG28LTC516N66FXTZ	1	4/0 Flex		5/16	1.14	1.03	0.15	2.64							
YAG28LTC38FXTZ	1	G,H,I,K,M	120	3/8	1.14	1.03	0.15	2.45							
YAG28LTC12FXTZ	1	DLO		1/2	1.14	1.03	0.15	2.70							
YAG28LTC58FXTZ	1	(550/24)		5/8	1.14	1.03	0.15	2.95							
YAG29LTC516FXTZ	1	250 kcmil		—	5/16	1.18	1.03	0.16	2.33	81K Series (1) 644 Series (1) 444 Series (1)	W29VT (2) W29RT (2) X29RT (4)	U29RT (1)	Yellow	16	1-1/16
YAG29LTC38FXTZ	1	4/0 Flex			3/8	1.18	1.03	0.16	2.45						
YAG32LTC58FXTZ	1	300 kcmil	185	5/8	1.40	1.19	0.19	3.22	81K Series (1) 644 Series (1) 444 Series (1)	W31VT (2) W31RT (2)	U31RT (2)	Red	18	1-1/4	
YAG34LTC516FXTZ	1	G,H,I,K,M													
YAG34LTC516N66FXTZ	1	DLO 313													
YAG34LTC38FXTZ	1	(775/24)													
YAG34LTC516FXTZ	1	350 kcmil	240	5/16	1.55	1.27	0.23	2.78	81K Series (1) 644 Series (1) 444 Series (1)	W32VT (2) W32RT (2)	U32RT (2)	Blue	19	1-5/16	
YAG34LTC516N66FXTZ	1	G,H,I,K,M													
YAG34LTC38FXTZ	1	DLO 373													
YAG34LTC12FXTZ	1	(925/24)													
YAG38LTC58FXTZ	1	500 kcmil	300	5/8	1.84	1.45	0.27	3.71	81K Series (1) 644 Series (1) 444 Series (1)	—	U38XRT (2)	Pink	L99	1-7/16	
		H,I,K													
		550 kcmil	400	1/2	1.96	1.42	0.30	3.48	81K Series (1) 644 Series (1) 444 Series (1)	—	U39RT (2)	Black	24	1-5/16	
YAG40LTC12FXTZ	1	G, DLO 646													
		(1600/24)													

* Use PUADP1 adapter with U dies in 46 Series of tools

*** The MM² conductor sizes listed are the recommendations for Class 5 conductor.

◆ For applications greater than 2000 Volts consult cable manufacturer for voltage stress relief instructions.

Note: All dimensions shown are for reference only.

TYPE YAG-2L-FXTZ

HYTIN-ZCLAD™

Uninsulated Copper Compression Terminal, Tin-Zinc Plated
UL Listed 90° C, Up to 35 kV ◆

45° and 90° angles available. Please contact Customer Service to order:
1-800-346-4175

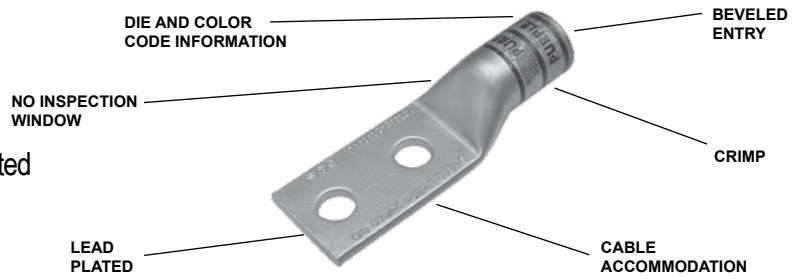

Features & Benefits

- No inspection window is ideal for more corrosive environments as the barrel transition is not open
- Barrel is designed with an internal chamfer at the wire entry to ensure smooth insertion of the wire, preventing possible damaging of the wire strands during insertion
- Short/Standard length barrel is recommended for installations with limited space requirements
- Two hole tongue/tang is recommended when space permits as the 2-hole feature minimizes the terminations from loosening or rotating under vibration, movement, or heat cycling
- 45° and 90° angular lugs are available; please contact Customer Service
- Tin-Zinc plated for battery connectors or other heavy duty equipment, to reduce the corrosion from lead/acid batteries
- Connectors are clearly marked with stamping and barrel color coding
- Connectors accommodating wire sizes #10 - 4/0 AWG accommodate both Flex and Code Wire. See Tables on each page for specific details
- BURNDY certifies its products using the BURNDY Engineered System and select other crimp tool manufacturers in accordance with one or more of the UL categories in order to obtain a UL Listing



NOTE: Field bending straight lugs to achieve an angular connection will void UL Listing / CSA Certifications and BURNDY will not be liable for the connection.

Straight



45°



90°

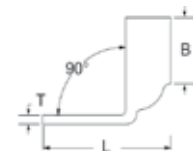

Accessories

- Hardware - Section F
- PENETROX™ Oxide Inhibitor - Section F
- Heat and Cold Shrink Tubing - Section D
- WIREMIKE™ Wire Micrometer - Section F
- Wire Management (Cable Ties) - Section G

Compression Connections

Copper Compression — Flex — Two Hole
Standard Barrel, Tin-Zinc Plated — No Inspection Window

TYPE YAG-2L-FXTZ (Continued)

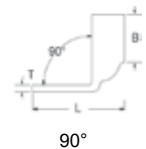
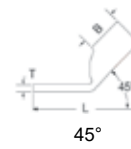
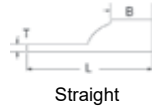

NOTE: Field bending straight lugs to achieve an angular connection will void UL Listing / CSA Certifications and BURNDY will not be liable for the connection.

Catalog Number	Fig #	Conductor		Stud Hole Size	Hole Spacing	Tongue Width	Figure Dimensions			Installation Tooling (# of crimps)					Wire Strip Length													
		AWG/KCMIL	MM ² ***				(B)	(T)	(L)	Dieless	MD6, 500, 600 Series, OUR840, MD734R	35, 750, 46* Series	Color Code	Die Index														
YAG8CL2TC14FXTZ	1	#8 AWG #8 Flex G,H,I,K,M DLO (37/24) #6 SOL #8 SOL	10	1/4	5/8	0.44	0.44	0.08	1.95	MRC840 (1) MY29 Series (1) Y8MRB1 (1) Y122CMR (1) Y1MRTC (1)	W8CVT (1) W8CRT (1) X8CRT (1)	U8CRT (1)	Red	49	7/16													
YAG8CL2TC14E1FXTZ	1									1/4						1.00	0.44	0.44	0.08	2.33								
YAG6CL2TC14FXTZ	1	#6 AWG #6 Flex G,H,I,K,M DLO (61/24)	16	1/4	5/8	0.48	0.50	0.08	2.06	MY29 Series (1) Y122CMR (1) Y1MRTC (1) 81K Series (1)	W5CVT (1) W5CRT (1) X5CRT (1)	U5CRT (1)	Blue	7	1/2													
YAG4CL2TC14FXTZ	1	#4 AWG #4 Flex G,H,I,K,M DLO (105/24)	—	1/4	5/8	0.55	0.50	0.09	2.11	MY29 Series (1) Y122CMR (2) Y1MRTC (2) 81K Series (1) 644 Series (1) 444 Series (1)	W4CVT (1) W4CRT (1) X4CRT (1)	U4CRT (1)	Gray	8	1/2													
YAG2CL2TC14FXTZ	1	#2 AWG #2 Flex G,H,I,K,M DLO (150/24)	35	1/4	5/8	0.68	0.63	0.10	2.28	MY29 Series (1) Y122CMR (2) Y1MRTC (2) 81K Series (1) 644 Series (1) 444 Series (1)	W2CVT (1) W2CRT (1) X2CRT (1)	U2CRT (1)	Brown	10	11/16													
YAG2CL2NTCFXTZ	1									1/2						1-3/4	0.83	0.63	0.08	4.03								
YAG26L2NTCFXTZ	1	2/0 AWG 2/0 Flex G,H,I,K,M DLO (325/24)	70	1/2	1-3/4	0.93	0.81	0.13	4.33	MY29 Series (1) 81K Series (1) 644 Series (1) 444 Series (1)	W26VT (2) W26RT (2) X26RT (2)	U26RT (1)	Black	13	13/16													
YAG27L2NTCFXTZ	1	3/0 AWG 3/0 Flex G,H,I,K,M DLO (450/24)	95	1/2	1-3/4	1.03	1.00	0.14	4.56	MY29 Series (1) 81K Series (1) 644 Series (1) 444 Series (1)	W27VT (2) W27RT (2) X27RT (3)	U27RT (1)	Orange	14	1													
YAG28L2TC516FXTZ	1	4/0 AWG 4/0 Flex G,H,I,K,M DLO (550/24)	120	5/16	1.00	1.14	1.03	0.15	3.33	MY29 Series (1) 81K Series (1) 644 Series (1) 444 Series (1)	W28VT (2) W28RT (2) X28RT (3)	U28RT (1)	Purple	15	1-1/16													
YAG28L2TC38FXTZ	1															3/8	1.00	1.14	1.03	0.15	3.46							
YAG28L2NT38FXTZ	1															3/8	1.00	0.94	1.03	0.17	3.48							
YAG28L2TC38FXDITZ	1															3/8	1.00	1.14	1.03	0.15	3.46							
YAG28L2NTCFXTZ	1															1/2	1-3/4	1.14	1.03	0.15	4.65							

* Use PUADP1 adapter with U dies in 46 Series of tools

*** The MM² conductor sizes listed are the recommendations for Class 5 conductor.

◆ For applications greater than 2000 Volts consult cable manufacturer for voltage stress relief instructions.

Note: All dimensions shown are for reference only.

TYPE YAG-2L-FXTZ (Continued)

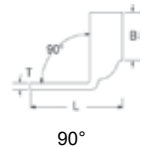
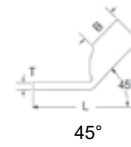
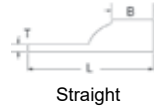

NOTE: Field bending straight lugs to achieve an angular connection will void UL Listing / CSA Certifications and BURNDY will not be liable for the connection.

Catalog Number	Fig #	Conductor		Stud Hole Size	Hole Spacing	Tongue Width	Figure Dimensions			Installation Tooling (# of crimps)					Wire Strip Length
		AWG/ KCML	MM ² ***				(B)	(T)	(L)	Dieless	MD6, 500, 600 Series, OUR840, MD734R	35, 750, 46* Series	Color Code	Die Index	
YAG29L2TC38FXTZ	1	250 kcmil	—	3/8	1.00	1.18	1.03	0.16	3.43	81K Series (1) 644 Series (1) 444 Series (1)	W29VT (2) W29RT (2) X29RT (4)	U29RT (1)	Yellow	16	1-1/16
YAG29L2NT38FXTZ	1	4/0 Flex		3/8	1.00	0.94	1.03	0.16	3.48						
YAG29L2NT38FX90TZ	3	G,H,I,K,M		3/8	1.00	0.94	1.03	0.16	2.36						
YAG29L2NTCFXTZ	1	DLO 262 (550/24)		1/2	1-3/4	1.18	1.03	0.16	4.65						
YAG31L2NTC38FXTZ	1	250 kcmil I,K,M	150	3/8	1-3/4	1.29	1.06	0.18	3.54	81K Series (1) 644 Series (1) 444 Series (1)	W30VT (2) W30RT (2)	U30RT (2)	White	17	1-1/8
YAG34L2TC38FXTZ	1	DLO 262 (650/24)													
YAG34L2NTCFXTZ	1	350 kcmil G,H,I,K,M	240	1/2	1-3/4	1.55	1.27	0.23	5.11	81K Series (1) 644 Series (1) 444 Series (1)	W32VT (2) W32RT (2)	U32RT (2)	Blue	19	1-5/16
YAG34L2NTCFXTZ	1	DLO 373 (925/24)													
YAG38L2TC12FXTZ	1	500 kcmil H,I,K	300	1/2	1-1/4	1.82	1.45	0.27	4.72	81K Series (1) 644 Series (1) 444 Series (1)	—	U38XRT (2)	Pink	20	1-3/8
YAG38L2NTCFXTZ	1	550 kcmil G,H,I													
YAG40L2NNTFXTZ	1	DLO 535 (325/24)	400	1/2	1-3/4	1.63	1.42	0.30	5.43	81K Series (2) 644 Series (1) 444 Series (1)	—	U39RT (2)	Black	24	1-5/16
YAG44L2TC38FXTZ	1	650 kcmil G													
YAG44L2NTCFXTZ	1	DLO 646 (1600/24)	500	1/2	1-3/4	2.18	1.65	0.33	5.80	81K Series (2) 644 Series (1) 444 Series (1)	—	U44XRT (2) P44XRT (2)	Yellow	L115	1-5/8
YAG44L2NTCFXTZ	1	750 kcmil G,H													
YAG44L2NTCFXTZ	1	DLO 777 (1925/24)													

* Use PUADP1 adapter with U dies in 46 Series of tools

*** The MM² conductor sizes listed are the recommendations for Class 5 conductor.

◆ For applications greater than 2000 Volts consult cable manufacturer for voltage stress relief instructions.

Note: All dimensions shown are for reference only.

Compression Connections

Copper Compression — Code — Blank Tongue
Long Barrel — No Inspection Window

TYPES YA-2NU, YA-4NU

Blank Tongue HYLUG™



Uninsulated Copper Compression Terminal
UL Listed 90° C, Up to 35 kV ♦

The Blank Tongue line of copper code HYLUG™ terminals are designed to provide maximum field flexibility. Scored lines prevent the drill from walking when trying to drill in this area. This innovative design allows the installer to customize the tongue drilling to fit their specific application while maintaining UL Listing and CSA Certification.

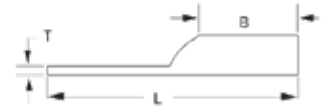

Features & Benefits

- Manufactured from seamless high conductivity electrolytic copper tubing with heavy duty wall thickness
- Internally beveled barrel end
- Proper compression systems form a highly efficient electrical connection
- Dimples located at each end of the scored line represent the location of the NEMA standard hole spacing
- Scored line locates the center of the tongue and prevents the drill from walking when trying to drill in this area
- Offered a wide range of code conductor sizes
- BURNDY certifies its products using the BURNDY Engineered System and select other crimp tool manufacturers in accordance with one or more of the UL categories in order to obtain a UL Listing
- Terminals and splices accommodating code wire: Accommodates Code Class B (Concentric, Compressed, Compact) and Class C wire

Catalog Number	Conductor		Min. Bolt Hole**	Tongue Width	Figure Dimensions			Installation Tooling (# of crimps)					Wire Strip Length	
	AWG	*** MM ²			B	T	L	Dieless	MD6, OUR840, MD734R	500 Series	35, 750, 46* Series	Color Code		Die Index
YA8C2NU	#8 AWG #6 Sol #8 Sol #8 Weld 37/24	—	#10	0.83	0.81	0.12	4.08	Y1MRTC (2) Y122CMR (2) MY29 Series (1)	W8CRT (1) W8CVT (1) X8CRT (2)	W8CRT (1)	U8CRT (1) U8CRT (1)	Red	49	7/8
YA6C2NU	#6 AWG Sol/Str.	—	#10	0.83	1.12	0.12	4.40	Y1MRTC (2) Y122CMR (2) MY29 Series (1) MRC840 (2) 81K Series (1)	W5CVT (2) W5CRT (2) X5CRT (2) X8CART (2)	W5CVT (2) W5CRT (2) X5CRT (2) X8CART (2)	U5CRT (2) U8CABT (2)	Blue	7 or 374	1-3/16
YA5C2NU	#5 AWG	16	—	0.83	1.12	0.12	4.43	MY29 Series (2) MRC840 (2) 81K Series (1)	W5CRT (2) W5CVT (2) X5CRT (2)	X5CRT (2) X5CVT (2) W5CRT (2)	U5CRT (2)	Blue	7	1-3/16
YA4C2NU	#4 AWG	—	#10	0.83	1.12	0.12	4.45	Y1MRTC (4) Y122CMR (4) MY29 Series (2) MRC840 (2)	W4CVT (2) W4CRT (2) X4CRT (2)	W4CVT (2) W4CRT (2) X4CRT (2)	U4CRT (2) U6CABT (2)	Gray	8 or 346	1-3/16
YA3C2NU	#3 AWG #2 Sol.	25	1/4	0.83	1.25	0.12	4.62	644 Series (1) 444 Series (1) 81K Series (1)	W3CRT (2)	W3CRT (2)	U3CRT (2)	White	9	1-5/16
YA2C2NU	#2 AWG	35	1/4	0.83	1.25	0.12	4.64	Y122CMR (4) Y1MRTC (4) MY29 Series (2) MRC840 (2)	W2CVT (2) W2CRT (2) X2CRT (2)	W2CVT (2) W2CRT (2) X2CRT (2)	U2CRT (2)	Brown	10	1-5/16
YA1C2NU	#1 AWG	50	1/4	0.83	1.38	0.12	4.82	644 Series (1) 444 Series (1) 81K Series (2)	W1CVT (2) W1CRT1 (2) X1CRT1 (2)	W1CVT (2) W1CRT1 (2) X1CRT1 (2)	U1CRT1 (2) U4CABT (2)	Green	11	1-7/16

* Use PUADP1 adaptor with U dies in 46 Series

** Minimum bolt hole size must be maintained for UL & CSA

*** The MM² conductor sizes listed are the recommendations for Class 2 conductor

† Requires Y60BHU HYPRESS™

NOTE: Field bending straight lugs to achieve an angular connection will void UL Listing / CSA Certifications and BURNDY will not be liable for the connection.

TYPES YA-2NU, YA-4NU (Continued)



NOTE: Field bending straight lugs to achieve an angular connection will void UL Listing / CSA Certifications and BURNDY will not be liable for the connection.



Catalog Number	Conductor		Min. Bolt Hole**	Tongue Width	Figure Dimensions			Installation Tooling (# of crimps)						Wire Strip Length
	AWG	*** MM ²			B	T	L	Dieless	MD6, OUR840, MD734R	500 Series	35, 750, 46* Series	Color Code	Die Index	
YA252NU	1/0 AWG	—	1/4	0.83	1.38	0.11	4.81	MY29 Series (2) MRC840 (4) 644 Series (1) 444 Series (1) 81K Series (2)	W25VT (4) W25RT (4) X25RT (4)	W25VT (4) W25RT (4) X25RT (4)	U25RT (2) U2CABT (2)	Pink	12 or 348	1-7/16
YA262NU	2/0 AWG	70	1/4	0.83	1.50	0.12	4.97		W26VT (4) W26RT (4) X26RT (4)	W26VT (4) W26RT (4) X26RT (4)	U26RT (2)	Black	13	1-9/16
YA272NU	3/0 AWG	—	1/4	0.91	1.50	0.13	5.01		W27VT (4) W27RT (4) X27RT (6)	W27VT (4) W27RT (4) X27RT (6)	U27RT (2)	Orange	14	1-9/16
YA282NU	4/0 AWG	—	1/4	1.02	1.62	0.14	5.17		W28VT (4) W28RT (4) X28RT (6)	W28VT (4) W28RT (4) X28RT (6)	U28RT (2)	Purple	15	1-11/16
YA292NU	250 kcmil	120	1/4	1.11	1.62	0.16	5.21	MY29 Series (2) 644 Series (1) 444 Series (1) 81K Series (2)	W29VT (4) X29RT (8)	W29VT (4) W29RT (4) X29RT (8)	U29RT (2)	Yellow	16	1-11/16
YA302NU	300 kcmil	150	1/4	1.20	2.00	0.16	5.64	644 Series (1) 444 Series (1) 81K Series (3)	W30VT (4)	W30VT (4) W30RT (4)	U30RT (4) U28ART (4)	White	17	2-1/16
YA312NU	350 kcmil	185	1/4	1.29	2.00	0.18	5.68		W31VT (4)	W31VT (4) W31RT (4)	U31RT (4) U29ART (4)	Red	18	2-1/16
YA322NU	400 kcmil	—	3/8	1.40	2.12	0.19	5.85		W32VT (4)	W32VT (4) W32RT (4)	U32RT (4) U30ART (4)	Blue	19 or 470	2-3/16
YA342NU	500 kcmil	240	3/8	1.55	2.25	0.22	6.06	644 Series (1) 444 Series (1) 81K Series (4)	W34VT (4)	W34VT (4) W34RT (4)	U34RT (4) U31ART (4)	Brown	20 or 299	2-5/16
YA362NU	600 kcmil	300	3/8	1.73	2.69	0.26	6.59	—	—	U36RT (4) U32ART (4)	Green	22 or 472	2-3/4	
YA392NU	750 kcmil	375	3/8	1.91	2.88	0.27	6.87	644 Series (1) 444 Series (1) 81K Series (3)	—	—	U39RT (4) P39RT (4)	Black	24	2-15/16
YA402NU	800 kcmil	400	3/8	1.98	2.94	0.30	6.95		—	—	P40RT (4)	Orange	25	3
YA442NU	1000 kcmil	500	3/8	2.18	3.00	0.32	7.14		—	—	P44RT (4)	White	27	3-1/16

* Use PUADP1 adaptor with U dies in 46 Series

** Minimum bolt hole size must be maintained for UL & CSA

*** The MM² conductor sizes listed are the recommendations for Class 2 conductor

‡ Requires 60 Ton Series HYPRESS™

TYPES YA-2NU, YA-4NU (Continued)



NOTE: Field bending straight lugs to achieve an angular connection will void UL Listing / CSA Certifications and BURNDY will not be liable for the connection.



Catalog Number	Conductor		Min. Bolt Hole**	Tongue Width	Figure Dimensions			Installation Tooling (# of crimps)					Wire Strip Length	
	AWG	*** MM ²			B	T	L	Dieless	MD6, OUR840, MD734R	500 Series	35, 750, 46* Series	Color Code		Die Index
YA452NU	1250 kcmil	—	3/8	2.46	3.19	0.38	7.44	—	—	—	P45RT (6)	Yellow	29	3-1/4
YA462NU	1500 kcmil	800	3/8	2.69	3.19	0.40	7.55	—	—	—	P46RT (6)	Green	31	3-1/4
YA472NU	1750 kcmil	—	3/8	2.90	3.44	0.42	7.89	—	—	—	—	Gray	33	3-1/2
YA482NU	2000 kcmil	1000	3/8	3.10	3.44	0.46	7.98	—	—	—	—	Brown	34	3-1/2
YA444NU	1000 kcmil	500	3/8	3.00	3.00	0.23	7.14	—	—	—	P44RT	White	27	3-1/16
YA454NU	1250 kcmil	—	3/8	3.00	3.19	0.30	7.44	—	—	—	P45RT	Yellow	29	3-1/4
YA464NU	1500 kcmil	800	3/8	3.00	3.19	0.34	7.55	—	—	—	P46RT	Green	31	3-1/4

* Use PUADP1 adaptor with U dies in 46 Series

** Minimum bolt hole size must be maintained for UL & CSA

*** The MM² conductor sizes listed are the recommendations for Class 2 conductor

‡ Requires 60 Ton HYPRESS™

TYPES YA-L2TC-SL, YAV-L2TC-FXSL

HYLUG™

Uninsulated Copper Compression Terminal
UL Listed 90° C, Up to 35 kV ◆



Compression slotted lugs connect copper or tinned copper conductors to bus bars, CPI racks, cabinets or cable runway. Slotted and 90° slotted lugs have one round and one oblong hole to match hole spacing on equipment mounting rails on CPI racks and cabinets and on some bus bars.

NOTE: Field bending straight lugs to achieve an angular connection will void UL Listing / CSA Certifications and BURNDY will not be liable for the connection.

Features & Benefits

- Inspection window allows for visual verification that the wire has been fully inserted prior to crimping the lug
- Barrel is designed with an internal chamfer at the wire entry to ensure smooth insertion of the wire, preventing possible damaging of the wire strands during installation
- Short/standard length barrel is recommended for installations with limited space requirements
- One hole with slotted second hole tongue/tang offers additional flexibility over a standard 2-hole tongue/tang as the slot provides the installer with multiple mounting hole alignments options. The 2-hole feature minimizes the terminations from loosening or rotating under vibration, movement or heat cycling
- 45° and 90° angular lugs are available; please contact Customer Service
- Electro-tin plated unless specified to reduce galvanic corrosion (bimetallic) and resist corrosive elements
- Connectors are clearly marked with stamping and barrel color coding
- BURNDY certifies its products using the BURNDY Engineered System and select other crimp tool manufacturers in accordance with one or more of the UL categories in order to obtain a UL Listing
- Terminals and splices accommodating code wire: Accommodates Code Class B (Concentric, Compressed, Compact) and Class C wire

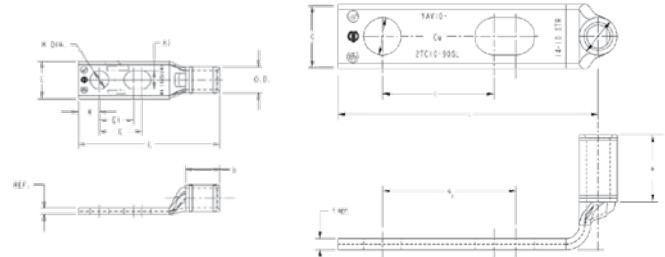

Catalog Number	Cond. Size	Stud Hole Size	Tongue Width	Figure Dimensions					Installation Tooling (# of crimps)					Wire Strip Length		
				(B)	(T)	(L)	(E)	(E1)	Dieless	MD6, OUR840, MD734R	500 Series	35, 750, 46** Series	Color Code		Die Index	
YA6CL2TC14E2SL	#6 AWG G,H,I,K,M DLO (61/24)	1/4	0.45	0.81	0.08	2.47	0.62	0.75	MY29 Series (1)	W5CRT (1) W5CVT (1) X5CRT (1) X8CART (1)	W5CRT (1) W5CVT (1)	U5CRT (1) U8CABT (1)	Blue	7 or 374	7/8	
YAV6CL2TC10FX90SL*	#6 AWG	#10	0.48	0.50	0.08	1.54	0.62	0.75	MY29 Series (1)	W5CRT (1) W5CVT (1) X5CRT (1) X8CART (1)	W5CRT (1) W5CVT (1)	U5CRT (1) U8CABT (1)	Blue	7 or 374	7/8	
YAV4CL2TC14FXSL	#4 AWG G,H,I,K,M DLO (105/24)	1/4	0.55	0.50	0.09	2.08	0.50	0.62	MY29 Series (1) 644 Series (1) 444 Series (1) 81K Series (1)	W4CRT (1) W4CVT (1) X4CRT (1)	W4CRT (1) W4CVT (1) X4CRT (1)	U4CRT (1)	Gray	8	9/16	
YAV4CL2TC38FXSL	#4 AWG	3/8	0.58	0.50	0.08	2.68	0.75	1.00								9/16
YAV2CL2TC14FXSL	#2 AWG G,H,I,K,M DLO (150/24)	1/4	0.68	0.62	0.10	2.26	0.50	0.62			W2CRT (1) W2CVT (1) X2CRT (1)	W2CRT (1) W2CVT (1) X2CRT (1)	U2CRT (1)	Brown	10	11/16
YAV2CL2TC38FXSL	#2 AWG	3/8	0.68	0.62	0.10	2.82	0.75	1.0							11/16	
YA44L2NNTFXSL	750 kcmil G,H DLO 777 (1925/24)	5/8	1.63	1.65	0.33	5.74	1.58	1.75	644 Series (1) 444 Series (1) 81K Series (2)	—	—	U44XRT (2)	Yellow	L115	1-2/3	

* Denotes 90° Angle

**Use PUADP1 adapter with U dies in 46 Series of tools

Note: All dimensions shown are for reference only.

TYPE YA-2TC-SL

HYLUG™

Uninsulated Copper Compression Terminal
UL Listed 90° C, Up to 35 kV ♦

Compression slotted lugs connect copper or tinned copper conductors to bus bars, CPI racks, cabinets or cable runway. Slotted and 90° slotted lugs have one round and one oblong hole to match hole spacing on equipment mounting rails on CPI racks and cabinets and on some bus bars.



NOTE: Field bending straight lugs to achieve an angular connection will void UL Listing / CSA Certifications and BURNDY will not be liable for the connection.

Features & Benefits

- Inspection window allows for visual verification that the wire has been fully inserted prior to crimping the lug
- Barrel is designed with an internal chamfer at the wire entry to ensure smooth insertion of the wire, preventing possible damaging of the wire strands during installation
- Long barrel allows for an increased number of crimps which will increase the mechanical strength of the connection
- One hole with slotted second hole tongue/tang offers additional flexibility over a standard 2-hole tongue/tang as the slot provides the installer with multiple mounting hole alignments options. The 2-hole feature minimizes the terminations from loosening or rotating under vibration, movement or heat cycling
- 45° and 90° angular lugs are available; please contact Customer Service
- Electro-tin plated unless specified to reduce galvanic corrosion (bimetallic) and resist corrosive elements
- Connectors are clearly marked with stamping and barrel color coding
- BURNDY certifies its products using the BURNDY Engineered System and select other crimp tool manufacturers in accordance with one or more of the UL categories in order to obtain a UL Listing
- Terminals and splices accommodating code wire: Accommodates Code Class B (Concentric, Compressed, Compact) and Class C wire

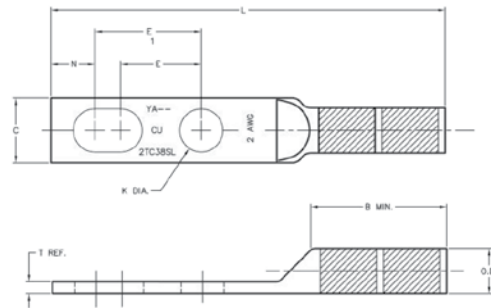

Accessories

- Hardware - Section F
- PENETROX™ Oxide Inhibitor - Section F
- Heat and Cold Shrink Tubing - Section D
- WIREMIKE™ Wire Micrometer - Section F
- Wire Management (Cable Ties) - Section G

Catalog Number	Wire Size	Stud Hole Size	Tongue Width	Figure Dimensions					Installation Tooling (# of crimps)					Wire Strip Length	
				(B)	(T)	(L)	(E)	(E1)	Dieless	MD6, OUR840, MD734R	500 Series	35, 750, 46* Series	Color Code		Die Index
YA6C2TC38SL	6 AWG	3/8	0.58	1.12	0.06	3.22	0.75	1	MY29 Series (1)	W5CRT (2) W5CVT (2)	W5CRT (2) W5CVT (2)	U8CABT (2)	Blue	7374	1-3/16
YA6C2TC38SLBOX500		3/8	0.58	1.12	0.06	3.22	0.75	1							
YA3C2TC38SL	3 AWG	3/8	0.58	1.25	0.08	3.43	0.75	1	MY29 Series (1) 644 Series (1) 444 Series (1) 81K Series (1)	W3CRT (2)	W3CRT (2)	U3CRT (2)	White	9	1-5/16
YA3C2TC38SLBOX500		3/8	0.58	1.25	0.08	3.43	0.75	1							
YA2C2TC38SL	2 AWG	3/8	0.60	1.25	0.11	3.42	0.75	1	MY29 Series (1) 644 Series (1) 444 Series (1)	W2CRT (2) W2CVT (2)	W2CRT (2) W2CVT (2)	U2CRT (2)	Brown	10	1-5/16
YA2C2TC38SLBOX500		3/8	0.60	1.25	0.11	3.42	0.75	1							

Note: All dimensions shown are for reference only.

*Use PUADP1 adapter with U dies in 46 Series of tools

TYPE YAZ-2TC-SL

HYLUG™

Uninsulated Copper Compression Terminal
UL Listed 90° C, Up to 35 kV ♦

Compression slotted lugs connect copper or tinned copper conductors to bus bars, CPI racks, cabinets or cable runway. Slotted and 90° slotted lugs have one round and one oblong hole to match hole spacing on equipment mounting rails on CPI racks and cabinets and on some bus bars.

Features & Benefits

- Inspection window allows for visual verification that the wire has been fully inserted prior to crimping the lug
- Barrel is designed with an internal chamfer at the wire entry to ensure smooth insertion of the wire, preventing possible damaging of the wire strands during installation
- Long barrel allows for an increased number of crimps which will increase the mechanical strengths of the connection
- One hole with slotted second hole tongue/tang offers additional flexibility over a standard 2-hole tongue/tang as the slot provides the installer with multiple mounting hole alignments options. The 2-hole feature minimizes the terminations from loosening or rotating under vibration, movement or heat cycling
- 45° and 90° angular lugs are available; please contact Customer Service
- Electro-tin plated unless specified to reduce galvanic corrosion (bimetallic) and resist corrosive elements
- Connectors are clearly marked with stamping and barrel color coding
- BURNDY certifies its products using the BURNDY Engineered System and select other crimp tool manufacturers in accordance with one or more of the UL categories in order to obtain a UL Listing
- Terminals and splices accommodating code wire: Accommodates Code Class B (Concentric, Compressed, Compact) and Class C wire



NOTE: Field bending straight lugs to achieve an angular connection will void UL Listing / CSA Certifications and BURNDY will not be liable for the connection.

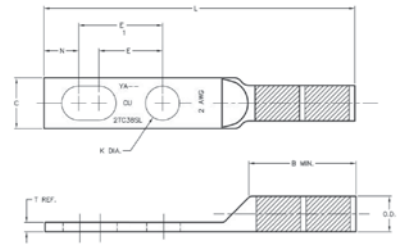

Fig. 1

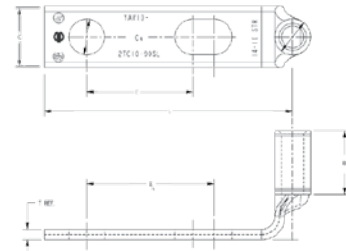

Fig. 2

Catalog Number	Wire Size	Stud Hole Size	Fig.	Tongue Width	Figure Dimensions					Installation Tooling (# of crimps)					Wire Strip Length	
					(B)	(T)	(L)	(E)	(E1)	Dieless	MD6, OUR840, MD734R	500 Series	35, 750, 46** Series	Color Code		Die Index
YAZ8C2TC10SL	8 AWG	#10	1	0.41	0.75	0.08	2.21	0.62	0.75	MY29 Series (1)	W8CRT (2) W8CVT (2) X8CRT (2)	W8CRT (2)	U8CRT (2)	Red	49	13/16
YAZ8C2TC1090SL		#10		0.41	0.75	0.08	1.50	0.62	0.75							
YAZ3C2TC38SL	3 AWG	3/8	2	0.58	1.25	0.08	3.39	0.75	1	MY29 Series (1) 644 Series (1) 444 Series (1)	W3CRT (2)	W3CRT (2)	U3CRT (2)	White	9	1-5/16
YAZ3C2TC38SLBOX500		3/8		0.58	1.25	0.08	3.43	0.75	1							
YAZ2C2TC38SL	2 AWG	3/8	2	0.60	1.25	0.11	3.41	0.75	1	MY29 Series (1) 644 Series (1) 444 Series (1)	W2CRT (2) W2CVT (2)	W2CRT (2) W2CVT (2)	U2CRT (2)	Brown	10	1-5/16
YAZ2C2TC38SLBOX500		3/8		0.60	1.25	0.11	3.42	0.75	1							

* Denotes 90° Angle

** Use PUADP1 adapter with U dies in 46 Series of tools

Note: All dimensions shown are for reference only.

TYPES YAV-2TC-SL, YAZV-2TC-FXSL

HYLUG™

Uninsulated Copper Compression Terminal
UL Listed 90° C, Up to 35 kV ◆

Compression slotted lugs connect copper or tinned copper conductors to bus bars, CPI racks, cabinets or cable runway. Slotted and 90° slotted lugs have one round and one oblong hole to match hole spacing on equipment mounting rails on CPI racks and cabinets and on some bus bars.



NOTE: Field bending straight lugs to achieve an angular connection will void UL Listing / CSA Certifications and BURNDY will not be liable for the connection.

Features & Benefits

- Inspection window allows for visual verification that the wire has been fully inserted prior to crimping the lug
- Barrel is designed with an internal chamfer at the wire entry to ensure smooth insertion of the wire, preventing possible damaging of the wire strands during installation
- Long barrel allows for an increased number of crimps which will increase the mechanical strengths of the connection
- One hole with slotted second hole tongue/tang offers additional flexibility over a standard 2-hole tongue/tang as the slot provides the installer with multiple mounting hole alignments options. The 2-hole feature minimizes the terminations from loosening or rotating under vibration, movement or heat cycling
- 45° and 90° angular lugs are available; please contact Customer Service
- Electro-tin plated unless specified to reduce galvanic corrosion (bimetallic) and resist corrosive elements
- Connectors are clearly marked with stamping and barrel color coding
- BURNDY certifies its products using the BURNDY Engineered System and select other crimp tool manufacturers in accordance with one or more of the UL categories in order to obtain a UL Listing

Accessories

- Hardware - Section F
- PENETROX™ Oxide Inhibitor - Section F
- Heat and Cold Shrink Tubing - Section D
- WIREMIKE™ Wire Micrometer - Section F
- Wire Management (Cable Ties) - Section G

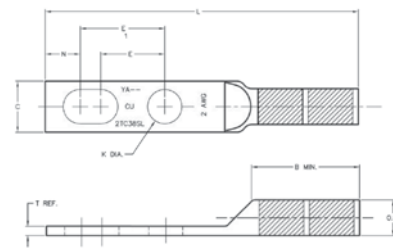

Fig. 1

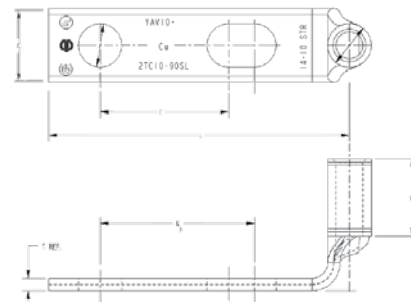

Fig. 2

TYPES YAV-2TC-SL, YAZV-2TC-FXSL (Continued)



NOTE: Field bending straight lugs to achieve an angular connection will void UL Listing / CSA Certifications and BURNDY will not be liable for the connection.

Catalog Number	Cond. Size	Stud Hole Size	Fig.	Tongue Width	Figure Dimensions					Installation Tooling (# of crimps)					Wire Strip Length		
					(B)	(T)	(L)	(E)	(E1)	Dieless	MD6, OUR840, MD734R	500 Series	35, 750, 46** Series	Color Code		Die Index	
YAZV102TC14SL	14 - 10 AWG	1/4	2	0.41	0.69	0.05	2.28	0.62	0.75	Y8MRB1 (1)	—	—	—	—	—	3/4	
YAV102TC1090SL*		#10	1	0.36	0.38	0.06	1.46	0.63	0.75								7/16
YAZV6C2TC38FXSLBOX500	#6 AWG G,H,I,K,M DLO (61/24)	3/8	1	0.58	1.12	0.08	3.22	0.63	1	MY29 Series (1)	W5CRT (2) W5CVT (2)	W5CRT (2) W5CVT (2)	U8CABT (2)	Blue	7 or 374	1-3/16	
YAZV6C2TC38FXSL		3/8	1	0.58	1.12	0.08	3.22	0.63	1								
YAZV6C2TC14FXSLBOX500		1/4	1	0.58	1.12	0.08	3.22	0.63	1								
YAZV6C2TC14FXSL		1/4	1	0.58	1.12	0.08	3.22	0.63	1								
YAZV6C2TC10FX90SL		#10	1	0.48	0.75	0.08	1.50	0.75	1								
YAZV4C2TC14FXSL	#4 AWG G,H,I,K,M DLO (105/24)	1/4	1	0.55	1.25	0.09	2.95	0.63	1	MY29 Series (1) 644 Series (1) 444 Series (1) 81K Series (1)	W4CRT (2) W4CVT (2) X4CRT (2)	W4CRT (2) W4CVT (2) X4CRT (2)	U4CRT (2)	Gray	8 or 346	1-5/16	
YAZV4C2TC14FXSLBOX500		1/4	1	0.55	1.25	0.09	2.95	0.63	1								
YAZV4C2TC38FXSL		3/8	1	0.55	1.25	0.09	2.95	0.63	1								
YAZV4C2TC38FXSLBOX500		3/8	1	0.55	1.25	0.09	2.95	0.63	1								
YAZV2C2TC14FXSL		#2 AWG G,H,I,K,M DLO (150/24)	1/4	1	0.60	1.25	0.11	3.42	0.75								1
YAZV2C2TC14FXSLBOX500	3/8	1	0.60	1.25	0.11	3.42	0.75	1									
YAZV2C2TC38FXSL	3/8	1	0.60	1.25	0.11	3.42	0.75	1									
YAZV2C2TC38FXSLBOX500	#2 AWG	3/8	1	0.60	1.25	0.11	3.42	0.75	1								
YAZV252TC14FXSL	1/0 AWG G,H,I,K,M DLO (275/24)	1/4	1	0.83	1.50	0.12	3.44	0.63	1	MY29 Series (1) 644 Series (1) 444 Series (1)	W25RT (4) W25VT (4) X25RT (4)	W25RT (4) W25VT (4) X25RT (4)	U25RT (2)	Pink	12	1-9/16	
YAZV252TC14FXSLBOX500	1/4	1	0.83	1.50	0.12	3.44	0.63	1									
YAZV252TC38FXSL	3/8	2	0.83	1.50	0.12	3.44	0.63	1									
YAZV252TC38FXSLBOX500	1/0 AWG	3/8	2	0.83	1.50	0.12	3.44	0.63	1								
YAZV262TC14FXSL	2/0 AWG G,H,I,K,M DLO (325/24)	1/4	1	0.93	1.50	0.13	3.58	0.63	1								MY29 Series (1) 644 Series (1) 444 Series (1)
YAZV262TC14FXSLBOX500	1/4	1	0.93	1.50	0.13	3.58	0.63	1									
YAZV262TC38FXSL	3/8	1	0.93	1.50	0.13	3.58	0.63	1									
YAZV262TC38FXSLBOX500	2/0 AWG	3/8	1	0.93	1.50	0.13	3.58	0.63	1								
YAZV282TC14FXSL	4/0 AWG G,H,I,K,M DLO (550/24)	1/4	1	1.14	1.62	0.15	3.64	0.63	1	MY29 Series (1) 644 Series (1) 444 Series (1)	W28VT (4) W28RT (4) X28RT (6)	W28VT (4) W28RT (4) X28RT (6)	U28RT (2)	Purple	15	1-11/16	
YAZV282TC14FXSLBOX500	1/4	1	1.14	1.62	0.15	3.64	0.63	1									
YAZV282TC38FXSL	3/8	1	1.14	1.62	0.15	3.64	0.63	1									
YAZV282TC38FXSLBOX500	4/0 AWG	3/8	1	1.14	1.62	0.15	3.64	0.63	1								

* Denotes 90° Angle

** Use PUADP1 adapter with U dies in 46 Series of tools

Note: All dimensions shown are for reference only.

TYPES YA-L-4TC, YAV-L-4TC-FX

HYLUG™

Uninsulated Copper Compression Terminal
UL Listed 90° C, Up to 35 kV ♦



Features & Benefits

- Inspection window allows for visual verification that the wire has been fully inserted prior to crimping the lug
- Split feature in the tongue/tang is used when connecting two separate terminal blocks for the same phase; the slot provides the needed equipment gap while allowing the proper mounting hole alignment
- Barrel is designed with an internal chamfer at the wire entry to ensure smooth insertion of the wire, preventing possible damaging of the wire strands during installation
- Short/standard length barrel is recommended for installations with limited space requirements
- Two hole tongue/tang is recommended when space permits as the 2-hole feature minimizes the terminations from loosening or rotating under vibration, movement or heat cycling
- 45° and 90° angular lugs are available; please contact Customer Service
- Electro-tin plated unless specified to reduce galvanic corrosion (bimetallic) and resist corrosive elements
- Connectors are clearly marked with stamping and barrel color coding
- BURNDY certifies its products using the BURNDY Engineered System and select other crimp tool manufacturers in accordance with one or more of the UL categories in order to obtain a UL Listing
- Terminals and splices accommodating code wire: Accommodates Code Class B (Concentric, Compressed, Compact) and Class C wire

NOTE: Field bending straight lugs to achieve an angular connection will void UL Listing / CSA Certifications and BURNDY will not be liable for the connection.

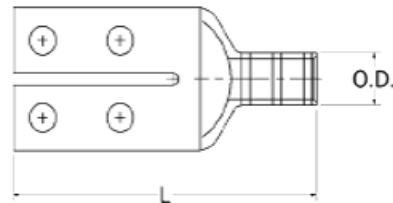

Accessories

- Hardware - Section F
- PENETROX™ Oxide Inhibitor - Section F
- Heat and Cold Shrink Tubing - Section D
- WIREMIKE™ Wire Micrometer - Section F
- Wire Management (Cable Ties) - Section G

TYPES YA-L-4TC, YAV-L-4TC-FX (Continued)



NOTE: Field bending straight lugs to achieve an angular connection will void UL Listing / CSA Certifications and BURNDY will not be liable for the connection.



Catalog Number	Wire Size	Stud Hole Size	Stud Hole Spacing	Tongue Width	Figure Dimensions			Installation Tooling						Wire Strip Length
					(B)	(T)	(L)	Dieless (# of crimps)	MD6, OUR840, MD734R	500 Series	35, 750, 46** Series	Color Code	Die Index	
YA25L4TCG1	1/0 AWG	1/4	0.62	1.38	0.88	0.11	3.05	MY29 Series (1) 644 Series (1) 444 Series (1)	X25RT (2) W25RT (2) W25VT (2)	X25RT (2) W25RT (2) W25VT (2)	U25RT (1) U2CABT (1)	Pink	12 or 348	15/16
YA26L4TCG1	2/0 AWG	1/4	0.62	1.38	0.94	0.21	3.15		X26RT (2) W26RT (2) W26VT (2)	X26RT (2) W26RT (2) W26VT (2)	U26RT (1) U26D1 (1)	Black	13	1
YA27L4TCG1	3/0 AWG	1/4	0.62	1.38	1.00	0.21	3.25		X27RT (3) W27RT (2) W27VT (2)	X27RT (3) W27RT (2) W27VT (2)	U27RT (1) U27D1 (1)	Orange	14	1-1/16
YA28L4TCG1	4/0 AWG	1/4	0.62	1.38	1.00	0.21	3.29		X28RT (3) W28RT (2) W28VT (2)	X28RT (3) W28RT (2) W28VT (2)	U28RT (1) U28D1 (1)	Purple	15	1-1/8
YAV28L4TCG1		1/4	0.62	1.38	1.00	0.21	3.29		X28RT (3) W28RT (2) W28VT (2)	X28RT (3) W28RT (2) W28VT (2)	U28RT (1)	Purple	15	11/16
YA29L4TCG1	250 kcmil	1/4	0.62	1.38	1.06	0.21	3.39		X29RT (4) W29RT (2) W29VT (2)	X29RT (4) W29RT (2) W29VT (2)	U29RT (1) U29D1 (1)	Yellow	16	1-1/8
YA31L4TCG1	350 kcmil	1/4	0.62	1.38	1.06	0.21	3.46		W31RT (2) W31VT (2)	W31RT (2) W31VT (2)	U31RT (2) U29ART (2)	Red	18 or 324	1-1/8
FLEX CONDUCTOR														
YAV2CL4TC14FXG1	#2 AWG G,H,I,K,M DLO (150/24) #2 AWG	1/4	0.62	1.38	0.62	0.11	2.84	MY2911 (1) 644Series (1) 444 Series (1)	X2CRT (1) W2CRT (1) W2CVT (1)	X2CRT (1) W2CRT (1) W2CVT (1)	U2CRT (1)	Brown	10	11/16
YAV25L4TC14FXG1	1/0 AWG G,H,I,K,M DLO (275/24) 1/0 AWG	1/4	0.62	1.38	0.69	0.21	2.90	MY29 Series (1) 644 Series (1) 444 Series (1)	X25RT (1) W25RT (1) W25VT (1)	X25RT (1) W25RT (1) W25VT (1)	U25RT (1)	Pink	12	13/16
YAV26L4TC14FXG1	2/0 AWG G,H,I,K,M DLO (325/24) 2/0 AWG	1/4	0.62	1.38	0.81	0.21	3.07		X26RT (2) W26RT (2) W26VT (2)	X26RT (2) W26RT (2) W26VT (2)	U26RT (1)	Black	13	1-1/16
YAV27L4TC14FXG1	3/0 AWG G,H,I,K,M DLO (450/24) 3/0 AWG	1/4	0.62	1.38	1.00	0.21	3.30		X27RT (3) W27RT (2) W27VT (2)	X27RT (3) W27RT (2) W27VT (2)	U27RT (1)	Orange	14	1-1/16
YAV28L4TC14FXG1	4/0 AWG G,H,I,K,M DLO (550/24) 4/0 AWG	1/4	0.62	1.38	1.00	0.21	3.38		X28RT (3) W28RT (2) W28VT (2)	X28RT (3) W28RT (2) W28VT (2)	U28RT (1)	Purple	15	11/16

** Use PUADP1 adapter with U dies in 46 Series of tools

TYPES YA-4TC, YAV-4TC-FX

HYLUG™

Uninsulated Copper Compression Terminal
UL Listed 90° C, Up to 35 kV ♦

Features & Benefits

- Inspection window allows for visual verification that the wire has been fully inserted prior to crimping the lug
- Split feature in the tongue/tang is used when connecting two separate terminal blocks for the same phase; the slot provides the needed equipment gap while allowing the proper mounting hole alignment
- Barrel is designed with an internal chamfer at the wire entry to ensure smooth insertion of the wire, preventing possible damaging of the wire strands during installation
- Long barrel allows for an increased number of crimps which will increase the mechanical strengths of the connection
- Two hole tongue/tang is recommended when space permits as the 2-hole feature minimizes the terminations from loosening or rotating under vibration, movement or heat cycling
- 45° and 90° angular lugs are available; please contact Customer Service
- Electro-tin plated unless specified to reduce galvanic corrosion (bimetallic) and resist corrosive elements
- Connectors are clearly marked with stamping and barrel color coding
- BURNDY certifies its products using the BURNDY Engineered System and select other crimp tool manufacturers in accordance with one or more of the UL categories in order to obtain a UL Listing
- Terminals and splices accommodating code wire: Accommodates Code Class B (Concentric, Compressed, Compact) and Class C wire



NOTE: Field bending straight lugs to achieve an angular connection will void UL Listing / CSA Certifications and BURNDY will not be liable for the connection.

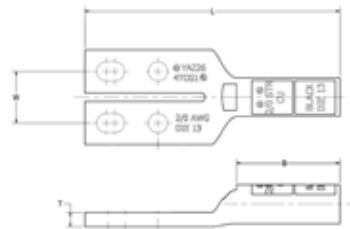

Accessories

- Hardware - Section F
- PENETROX™ Oxide Inhibitor - Section F
- Heat and Cold Shrink Tubing - Section D
- WIREMIKE™ Wire Micrometer - Section F
- Wire Management (Cable Ties) - Section G

Catalog Number	Wire Size	Stud Hole Size	Stud Hole Spacing	Tongue Width	Figure Dimensions			Installation Tooling					Wire Strip Length	
					(B)	(T)	(L)	Dieless (# of crimps)	MD6, OUR840, MD734R	500 Series	35, 750, 46** Series	Color Code		Die Index
YAZ254TCG1	1/0 AWG	1/4	0.62	1.38	1.38	0.11	3.55	MY29 Series (1) 644 Series (1) 444 Series (1)	X25RT (1)	X25RT (1)	U25RT (2)	Pink	12 or 348	1-7/16
YAZ254TC38E1G1		3/8	1.00	1.63	1.38	0.11	3.93		W25RT (1)	W25RT (1)	U2CABT (2)			
YAZ264TC38E1G1	3/8	1.00	1.63	1.50	0.21	4.09	W25VT (1)		W25VT (1)					
YAZ264TCG1	2/0 AWG	1/4	0.62	1.38	1.50	0.21	3.71		X26RT (2)	X26RT (2)	U26RT (2)	Black	13	1-9/16
									W26RT (2)	W26RT (2)	U26D1 (2)			
									W26VT (2)	W26VT (2)				
YAZ284TCG1	4/0 AWG	1/4	0.62	1.38	1.62	0.21	3.91		X28RT (3)	X28RT (3)	U28RT (1)	Purple	15	1-11/16
									W28RT (2)	W28RT (2)				
									W28VT (2)	W28VT (2)				
YAZ294TCG1	250 kcmil	1/4	0.62	1.38	1.62	0.21	3.94		X29RT (4)	X29RT (4)	U29RT (2)	Yellow	16	1-11/16
									W29RT (2)	W29RT (2)	U29D1 (2)			
									W29VT (2)	W29VT (2)				
YAZ314TCG1	350 kcmil	1/4	0.62	1.38	2.00	0.21	4.39	W31RT (2)	W31RT (2)	U31D1 (2)	Red	18 or 324	2-1/16	
								W31VT (2)	W31VT (2)	U31RT (2)				
										U29ART (2)				

** Use PUADP1 adapter with U dies in 46 Series of tools

TYPE YA-E

E-LINE HYLUG™ Equipment Line



UL Listed 90° C, Up to 35 kV ♦

Type YA-E Equipment terminals are designed to provide replacements for original equipment mechanical or other compression terminals. These narrow tongue terminals are specially designed to fit in tight areas. Whether you're upgrading or replacing, YA-E connectors will provide for any of your cable termination needs. When installed with our dieless tool, these terminals can accommodate a range of conductor sizes.



Features & Benefits

- Narrow tongue/tang is designed to allow for more parallel terminations of wire in limited space applications
- Terminals are available in copper or aluminum material
- Aluminum terminals accommodate both copper and aluminum wire
- Barrel is designed with an internal chamfer at the wire entry to ensure smooth insertion of the wire
- One or two-hole tongue/tang styles are available; 2-hole tongue/tang is recommended when space permits as the 2-hole feature minimizes the terminations from loosening or rotating under vibration, movement or heat cycling
- Electro-tin plated unless specified to reduce galvanic corrosion (bimetallic) and resist corrosive elements
- Connectors are clearly marked with stamping and barrel color coding
- Overlap crimps should crimp the entire crimp zone
- BURNDY certifies its products using the BURNDY Engineered System and select other crimp tool manufacturers in accordance with one or more of the UL categories in order to obtain a UL Listing
- Terminals and splices accommodating code wire: Accommodates Code Class B (Concentric, Compressed, Compact) and Class C wire

NOTE: Field bending straight lugs to achieve an angular connection will void UL Listing / CSA Certifications and BURNDY will not be liable for the connection.

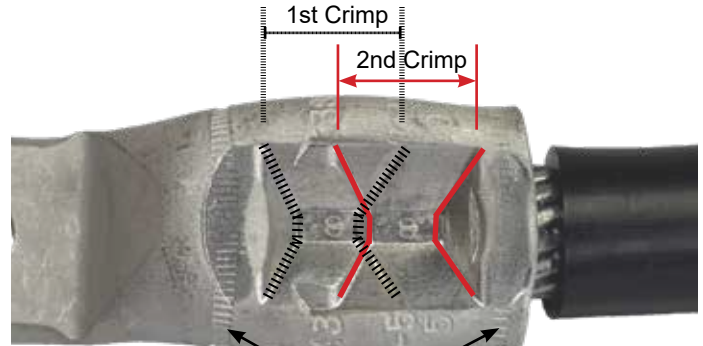

When overlapping crimps, ensure pyramid crimp shapes are within knurl marks.

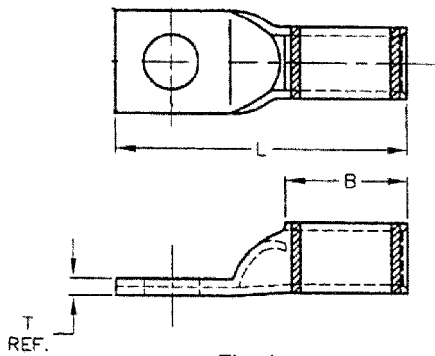

Fig. 1

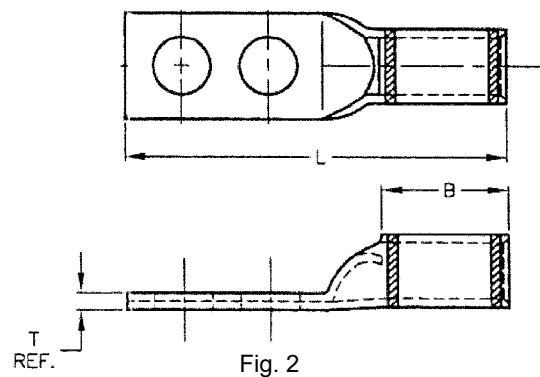

Fig. 2

TYPE YA-E (Continued)



NOTE: Field bending straight lugs to achieve an angular connection will void UL Listing / CSA Certifications and BURNDY will not be liable for the connection.



COPPER E-LINE HYLUG™ COMPRESSION TERMINALS

Catalog Number	Fig. No.	Conductor Accommodations		Stud Hole Size	Stud Hole Spacing	Tongue Width (max)	Dimensions			† Installation Tooling					Wire Strip Length
		Copper Only					B	T	L	Dieless (# of crimps)	MD6, MD7 (# of crimps)	35, 750, 46* Series (# of crimps)	Color Code	Die Index	
		AWG/KCMIL	Expanded Wire Range using 644 / 444 Series												
YA25LN50T14E	1	1/0 AWG	#6 - 1/0 AWG	1/4	—	0.50	0.88	0.12	1.84	644 Series (1) 444 Series (1)	W25RT (2)	U25RT (1)	Pink	12 or 348	15/16
YA25LN64T516E				5/16	—	0.64	0.88	0.12	1.96		W26RT (2)	U26RT (1)			
YA26LN50T14E	1	2/0 AWG	#4 - 2/0 AWG	1/4	—	0.50	0.94	0.12	1.94	81K Series (1)	W26RT (2) W26VT (2)	U26RT (1)	Black	13	1
YA30L24N100T38E	1	300 kcmil	2/0 AWG - 300 kcmil	3/8	—	1.00	1.03	0.16	2.44	644 Series (1) 444 Series (1)	W30RT (2)	U30RT (2)	White	17 or 298	1-1/16
YA34L6N131T12E	1	500 kcmil	4/0 AWG - 500 kcmil	1/2	—	1.31	1.27	0.23	3.31		U34RT (2)	U28ART (2)			
YA342LNN119T12E	2			1/2	1.75	1.19	1.27	0.22	5.06	—	U31ART (2)	P34RT (2)			
YA342LNN131T12E	2			1/2	1.75	1.31	1.27	0.22	5.06	81K Series (2)	—	—			
YA39L6N131T12E	1	750 kcmil	500 - 750 kcmil	1/2	—	1.31	1.42	0.27	3.61	—	U39RT (2)	Black	24	1-1/2	
YA392LNN131T12E	2			1/2	1.75	1.31	1.42	0.27	5.37						

ALUMINUM E-LINE HYLUG™ COMPRESSION TERMINALS

Catalog Number	Fig. No.	Conductor Accommodations		Stud Hole Size	Stud Hole Spacing	Tongue Width (max)	Dimensions			† Installation Tooling				Wire Strip Length
		Aluminum	Copper or Aluminum				B	T	L	Dieless (# of crimps)	35, 750, 46* Series (# of crimps)	Color Code	Die Index	
		AWG/KCMIL	Expanded Wire Range using 644 / 444 Series											
YA8CA3S56T14E	1	#8 AWG	—	1/4	—	0.56	0.62	0.09	1.65	81K Series (1)	U8CABT (1)	Blue	374	11/16
YA2CA5S53T14E	1	#2 AWG	#6 - #2 AWG	1/4	—	0.53	1.00	0.22	2.25	644 Series (1) 444 Series (1)	U2CABT (1)	Pink	348	1-3/16
YA2CA1S91T516E				5/16	—	0.91	1.12	0.16	2.50					
YA25A1S60T516E	1	1/0 AWG	#1 - 1/0 AWG	5/16	—	0.63	1.00	0.21	2.29	81K Series (1)	U25ART (1)	Tan	296	1-1/8
YA25A3N69T38E				3/8	—	0.69	1.05	0.21	2.38					

† A variety of BURNDY® installation tools are available and not all tools are listed. If you require additional tooling information, please feel free to call our customer service department for other recommendations.

* Use PUADP1 adapter with U dies in 46 Series, P-RT die sets for use in 46 Series only, PUADP1 adapter not required.

Note: All dimensions shown are for reference only.

**Overlap crimps when using U Dies, 644 or 444 Series Tools.

TYPE YA-E (Continued)



NOTE: Field bending straight lugs to achieve an angular connection will void UL Listing / CSA Certifications and BURNDY will not be liable for the connection.



ALUMINUM E-LINE HYLUG™ COMPRESSION TERMINALS

Catalog Number	Fig. No.	Conductor Accommodations		Stud Hole Size	Stud Hole Spacing	Tongue Width (max)	Dimensions			† Installation Tooling				Wire Strip Length	
		Aluminum AWG/KCMIL	Copper or Aluminum Expanded Wire Range using 644 / 444 Series				B	T	L	Dieless (# of crimps)	35, 750, 46* Series (# of crimps)	Color Code	Die Index		
YA26A13N100T516E	1	2/0 AWG	#1 - 2/0 AWG	5/16	—	1.00	1.11	0.24	2.45	644 Series (1) 444 Series (1) 81K Series (2)	U26ART (2)	Olive	297	1-3/16	
YA26A6N100T38E				3/8	—	1.00	1.11	0.24	2.53						
YA27A10S76T516E	1	3/0 AWG	#1 - 3/0 AWG	5/16	—	0.76	1.11	0.26	2.58		U27ART (2)	Ruby	467	1-3/16	
YA28A14N100T516E	1	4/0 AWG	1/0 - 4/0 AWG	3/8	—	1.00	1.39	0.30	2.85						
YA28A1N100T38E				5/16	—	1.00	1.39	0.30	2.94						
YA30A9N100T516E	1	300 kcmil	2/0 AWG - 300 kcmil	5/16	—	1.00	1.53	0.36	3.12		U30ART (2)	Blue	470	1-5/8	
YA30A6N100T38E				3/8	—	1.00	1.53	0.36	3.20						
YA30A1N131T12E				1/2	—	1.31	1.53	0.35	3.57						
YA31A11N100T516E	1	350 kcmil	3/0 AWG - 350 kcmil	5/16	—	1.00	1.85	0.39	3.51		644 Series (1) 444 Series (1) 81K Series (2)	U31ART (2)	Brown	299	1-7/8
YA31A9N100T38E				3/8	—	1.00	1.85	0.39	3.59						
YA32A8N106T516E	1	400 kcmil	4/0 AWG - 400 kcmil	5/16	—	1.06	2.26	0.43	3.92	644 Series (1) 444 Series (1) 81K Series (2)	U32ART (4)	Green	472	2-5/16	
YA34A8N131T38E **	1	500 kcmil	4/0 AWG - 500 kcmil	3/8	—	1.31	1.64	0.35	3.88						
YA34A7N131T12E **				1/2	—	1.31	1.64	0.35	3.88						
YA34A3N131T12E **	2			1/2	1.75	1.31	1.64	0.39	5.71	644 Series (2) 444 Series (2) 81K Series (2)	U34ART (4)	Pink	300	1-11/16	
YA36A9N131TD12E **	1	600 kcmil	250 - 600 kcmil	1/2	—	1.31	1.64	0.39	3.98						
YA36A3N131TD38E **				3/8	—	1.31	1.64	0.39	5.32						
YA36A3N131TD12E **	2			1/2	1.75	1.31	1.64	0.39	5.71						
YA39A1N131TD12E **	1			1/2	—	1.31	1.86	0.31	4.28	644 Series (2) 444 Series (2) 81K Series (2)	U34ART (4)	Pink	300	1-15/16	
YA39A5N131TD12E **	2	750 kcmil	500 - 900 © kcmil Aluminum 500 kcmil Copper Only	1/2	1.75	1.31	1.86	0.31	6.09						

† A variety of BURNDY® installation tools are available and not all tools are listed. If you require additional tooling information, please feel free to call our customer service department for other recommendations.

* Use PUADP1 adapter with U dies in 46 Series, P-RT die sets for use in 46 Series only, PUADP1 adapter not required.

Note: All dimensions shown are for reference only.

© 900 kcmil Aluminum must be Compact Stranding and use 644 or 444 Series Tools

**Overlap crimps when using U Dies, 644 or 444 Series Tools.

TYPE YAV-M

HYLUG™

Uninsulated Copper Compression Terminal
Rated for 90° C, Up to 35 kV ♦

Made from electrolytic copper tube and is electro-tin plated. Wire range is from 2.5 mm² to 630 mm² Class 2. Compatible to **IEC61238-1**.

NOTE: Field bending straight lugs to achieve an angular connection will void UL Listing / CSA Certifications and BURNDY will not be liable for the connection.

Features & Benefits

- Inspection window allows for visual verification that the wire has been fully inserted prior to crimping the lug
- Barrel is designed with an internal chamfer at the wire entry to ensure smooth insertion of the wire, preventing possible damaging of the wire strands during installation
- Short/standard length barrel is recommended for installation with limited space requirements
- Electro-tin plated unless specified to reduce galvanic corrosion (bimetallic) and resist corrosive elements
- Compatible Standards: IEC61238-1, UL 486A-486B, CSA-C22.2 No. 65-03
- Connectors are clearly marked with stamping
- Terminals and splices accommodating code wire: Accommodates Code Class B (Concentric, Compressed, Compact) and Class C wire

Accessories

- Hardware - Section F
- PENETROX™ Oxide Inhibitor - Section F
- Heat and Cold Shrink Tubing - Section D
- WIREMIKE™ Wire Micrometer - Section F
- Wire Management (Cable Ties) - Section G

Electro-Tin
Plated

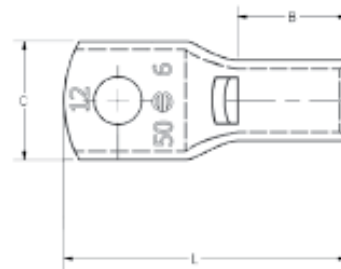
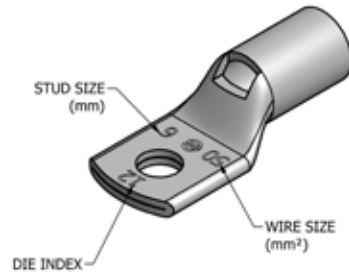

TYPE YAV-M (Continued)

Electro-Tin
Plated

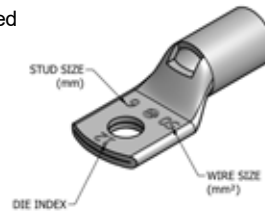

NOTE: Field bending straight lugs to achieve an angular connection will void UL Listing / CSA Certifications and BURNDY will not be liable for the connection.

Catalog Number	Copper		Stud Size	Dimensions (mm)				Installation Tooling					Wire Strip Length				
	Wire Range mm ² (AWG)	Class		(B)	(C)	(L)	Tongue Thickness	Dieless	MD6, OUR840, MD734R	500 Series	35, 750, 46** Series	Die Index					
YAV025M3	1.5 - 2.5 (20 - 14)	2, 5	M3	6.7	7.9	19.1	1.0	Y10D (1) Y1022 (1) MR8G98 (1) MR89Q (1) Y8MRB1 (1) MR20 (1)	—	—	—	—	7				
YAV025M4			M4	6.7	7.9	19.1	1.0										
YAV025M5			M5	6.7	7.9	19.1	1.0										
YAV025M6			M6	6.7	10.7	24.2	0.8										
YAV025M8			M8	6.7	11.0	24.2	0.8										
YAV06M35	4 - 6 (12 - 10)	2, 5	M3.5	10.5	7.6	23.7	1.8		Y1MRTC (1) MY2911 (1) MRC840 (1) 81K Series (1)	—	—	—		—	11		
YAV06M4			M4	10.4	9.5	23.9	1.5										
YAV06M5			M5	10.4	9.5	23.9	1.5										
YAV06M6			M6	10.4	11.9	26.9	1.3										
YAV06M8			M8	10.4	13.5	28.7	1.0										
YAV06M10			M10	9.5	14.2	31.0	1.0										
YAV10M4	10 (8)	2, 5	M4	11.2	10.4	29.1	2.0	Y1MRTC (1) MY2911 (1) MRC840 (1) 81K Series (1)		W8CVT (1) W8CRT (1) X8CRT (1)	W8CVT (1) W8CRT (1) X8CRT (1)	U8CRT (1)	49	11			
YAV10M5			M5	11.2	10.4	28.5	1.8										
YAV10M6			M6	11.2	1.0	31.0	1.8										
YAV10M8			M8	11.2	13.2	33.0	1.5										
YAV10M10			M10	11.2	14.5	33.0	1.3										
YAV10M12			M12	11.2	18.5	38.6	1.3										
YAV16M4	16 (6)	2, 5	M4	12.7	12.2	31.5	2.3		Y1MRTC (1) MY2911 (1) MRC840 (1) 81K Series (1)	W5CVT (1) W5CRT (1) X5CRT (1)	W5CVT (1) W5CRT (1) X5CRT (1)	U5CRT (1)	7		13		
YAV16M5			M5	12.7	12.2	33.0	2.0										
YAV16M6			M6	12.7	12.2	33.0	2.0										
YAV16M8			M8	12.7	15.2	36.3	1.5										
YAV16M10			M10	12.7	14.7	40.9	1.5										
YAV16M12			M12	12.7	18.8	41.6	1.3										
YAV25M5	25 (4)	2, 5	M5	12.7	14.0	33.5	2.3	Y1MRTC (2) MY2911 (1) MRC840 (1) 644 Series (1) 444 Series (1) 81K Series (1)		W3CRT (1)	W3CRT (1)	U3CRT (1)	9	13			
YAV25M6			M6	12.7	12.7	34.5	2.0										
YAV25M8			M8	12.7	16.0	37.6	2.0										
YAV25M10			M10	12.7	14.7	41.4	2.0										
YAV25M12			M12	12.7	18.5	42.7	1.5										
YAV35M5	35 (2)	2, 5	M5	16.0	17.3	38.1	2.5			MY2911 (1) MRC840 (2) 644 Series (1) 444 Series (1) 81K Series (1)	W2CVT (1) W2CRT (1) X2CRT (1)	W2CVT (1) W2CRT (1) X2CRT (1)	U2CRT (1)			10	17
YAV35M6			M6	11.7	17.3	43.7	2.5										
YAV35M8			M8	11.7	17.3	43.7	2.5										
YAV35M10			M10	11.7	17.3	45.9	2.5										
YAV35M12			M12	11.7	19.6	47.5	2.3										
YAV35M16			M16	11.7	21.1	58.7	3.0										
YAV50M5	50 (2)	2	M5	16.0	17.3	38.1	2.5		MY2911 (1) MRC840 (2) 644 Series (1) 444 Series (1) 81K Series (1)		W25VT (2) W25RT (2) X25RT (2)	W25VT (2) W25RT (2) X25RT (2)	U25RT (1)		12	17	
YAV50M6			M6	16.0	17.3	38.1	2.5										
YAV50M8			M8	16.0	17.3	42.9	2.5										
YAV50M10			M10	16.0	17.3	45.9	2.5										
YAV50M12			M12	16.0	18.5	52.3	2.5										
YAV50M14			M14	16.0	21.1	53.3	3.0										
YAV50M16	M16	16.0	25.9	58.7	3.6												

* Use equivalent AWG setting on tool for installation

** PUADP1 Adaptor is required to use U Dies in 46 Series

† P-RT Die sets for use in 46 Series tools only, PUADP1 Adaptor not required

Compression Connections

Copper Compression — Code — One Hole
Standard Barrel — Metric Lugs

TYPE YAV-M (Continued)

Electro-Tin
Plated

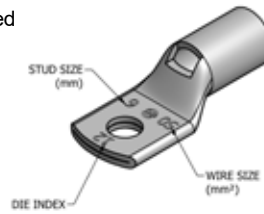

NOTE: Field bending straight lugs to achieve an angular connection will void UL Listing / CSA Certifications and BURNDY will not be liable for the connection.

Catalog Number	Copper		Stud Size	Dimensions (mm)				Installation Tooling					Wire Strip Length
	Wire Range mm ² (AWG)	Class		(B)	(C)	(L)	Tongue Thickness	Dieless	MD6, OUR840, MD734R	500 Series	35, 750, 46** Series	Die Index	
YAV70M5	70 (1/0)	2	M5	17.5	21.1	41.4	3.0	MY2911 (1) MRC840 (2) 644 Series (1) 444 Series (1) 81K Series (1)	W26VT (2) W26RT (2) X26RT (2)	W26VT (2) W26RT (2) X26RT (2)	U26RT (1)	13	19
YAV70M6			M6	17.5	21.1	44.5	3.0						
YAV70M8			M8	17.5	21.1	46.0	3.0						
YAV70M10			M10	17.5	21.1	49.3	3.0						
YAV70M12			M12	17.5	21.1	55.6	3.0						
YAV70M14			M14	17.5	22.4	56.6	2.8						
YAV70M16			M16	17.5	22.4	62.0	2.8						
YAV95M6	95 (2/0)	2	M6	20.6	23.6	45.8	3.3	MY2911 (1) MRC840 (2) 644 Series (1) 444 Series (1) 81K Series (2)	W27VT (2) W27RT (2) X27RT (3)	W27VT (2) W27RT (2) X27RT (3)	U27RT (1)	14	22
YAV95M8			M8	20.6	23.6	50.3	3.3						
YAV95M10			M10	20.6	23.6	53.6	3.3						
YAV95M12			M12	20.6	23.6	59.9	3.3						
YAV95M14			M14	20.6	23.6	61.0	3.3						
YAV95M16			M16	20.6	23.6	66.3	3.3						
YAV95M20			M20	20.6	30.5	77.4	4.1						
YAV120M6	120 (4/0)	2	M6	26.2	29.0	53.6	3.8	MY2911 (1) MRC840 (2) 644 Series (1) 444 Series (1) 81K Series (2)	W28VT (2) W28RT (2) X28RT (2)	W28VT (2) W28RT (2) X28RT (2)	U28RT (1)	15	27
YAV120M8			M8	26.2	29.0	58.2	3.8						
YAV120M10			M10	26.2	29.0	61.5	3.8						
YAV120M12			M12	26.2	29.0	67.8	3.8						
YAV120M14			M14	26.2	29.0	68.8	3.8						
YAV120M16			M16	26.2	29.0	74.2	3.8						
YAV120M20			M20	26.2	29.0	85.2	3.8						
YAV150M8	150 (300)	2	M8	26.2	30.5	58.7	4.1	644 Series (1) 444 Series (1) 81K Series (2)	W30VT (2)	W30VT (2) W30RT (2)	U30RT (2)	17	27
YAV150M10			M10	26.2	30.5	62.0	4.1						
YAV150M12			M12	26.2	30.5	68.3	4.1						
YAV150M14			M14	26.2	30.5	69.2	4.1						
YAV150M16			M16	26.2	30.5	74.7	4.1						
YAV150M20			M20	26.2	30.5	85.7	4.1						
YAV185M8	185 (350)	2	M8	26.9	32.8	60.2	4.6	644 Series (1) 444 Series (1) 81K Series (2)	W31VT (2)	W31VT (2) W31RT (2)	U31RT (2)	18	29
YAV185M10			M10	26.9	32.8	63.5	4.3						
YAV185M12			M12	26.9	32.8	69.9	4.3						
YAV185M14			M14	26.9	32.8	70.8	4.6						
YAV185M16			M16	26.9	32.8	76.2	4.6						
YAV185M20			M20	26.9	32.8	87.3	4.6						
YAV240M10	240 (500)	2	M10	32.3	39.4	72.9	5.8	644 Series (1) 444 Series (1) 81K Series (2)	W34VT (2)	W34VT (2) W34RT (2)	U34RT (2)	20	33
YAV240M12			M12	32.3	39.4	80.2	5.6						
YAV240M14			M14	32.3	39.4	81.3	5.8						
YAV240M16			M16	32.3	39.4	85.6	5.8						
YAV240M20			M20	32.3	39.4	96.6	5.8						
YAV300M10	300 (600)	2	M10	35.1	44.2	77.2	6.9	644 Series (1) 444 Series (1) 81K Series (2)	—	—	U36RT (2)	22	35
YAV300M12			M12	35.1	44.2	83.6	6.6						
YAV300M14			M14	35.1	44.2	84.6	6.9						
YAV300M16			M16	35.1	44.2	89.9	6.9						
YAV300M20			M20	35.1	44.2	100.9	6.9						

* Use equivalent AWG setting on tool for installation.

** PUADP1 Adaptor is required to use U Dies in 46 Series tools.

† P-RT Die sets for use in 46 Series only, PUADP1 Adaptor not required.

TYPE YAV-M (Continued)

Electro-Tin
Plated

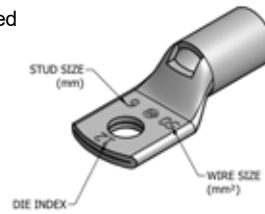

NOTE: Field bending straight lugs to achieve an angular connection will void UL Listing / CSA Certifications and BURNDY will not be liable for the connection.

Catalog Number	Copper		Stud Size	Dimensions (mm)				Installation Tooling					Wire Strip Length
	Wire Range mm ² (AWG)	Class		(B)	(C)	(L)	Tongue Thickness	Dieless	MD6, OUR840, MD734R	500 Series	35, 750, 46** Series	Die Index	
YAV400M12	400 (800)	2	M12	36.1	50.3	87.1	7.6	644 Series (1) 444 Series (1) 81K Series (3)	—	—	U39RT (3)	24	37
YAV400M14			M14	36.1	50.3	88.1	7.6						
YAV400M16			M16	36.1	50.3	93.5	7.6						
YAV400M20			M20	36.1	50.3	104.5	7.6						
YAV500M12	500 (1000)	2	M12	41.9	55.6	96.2	8.1	—	—	U44XRT (3) •P44XRT (3)	L115	43	
YAV500M16			M16	41.9	55.6	102.6	8.4						
YAV500M20			M20	41.9	55.6	113.7	8.4						
YAV630M12	630 (1250)	2	M12	50.8	62.5	107.7	9.7	—	—	P45RT (3)	29	55	
YAV630M16			M16	50.8	62.5	114.0	9.7						
YAV630M20			M20	50.8	62.5	125.2	9.7						

* Use equivalent AWG setting on tool for installation

** PUADP1 Adaptor is required to use U Dies in 46 Series

- P-RT dies for 46 Series Tooling only

TYPE YALB-M

HYLUG™

Rated for 90° C, Up to 35 kV ♦

Made from electrolytic copper tube and is electro-tin plated. Wire range is from 2.5 mm² to 630 mm² Class 2. Compatible to **IEC61238-1**.

NOTE: Field bending straight lugs to achieve an angular connection will void UL Listing / CSA Certifications and BURNDY will not be liable for the connection.

Features & Benefits

- No inspection window is ideal for more corrosive environments as the barrel transition is not open
- Barrel is designed with an internal chamfer at the wire entry to ensure smooth insertion of the wire, preventing possible damaging of the wire strands during installation
- Long barrel allows for an increased number of crimps which will increase the mechanical strength of the connection
- Electro-tin plated unless specified to reduce galvanic corrosion (bimetallic) and resist corrosive elements
- Compatible Standards: IEC61238-1, UL 486A-486B, CSA-C22.2 No. 65-03
- Terminals and splices accommodating code wire: Accommodates Code Class B (Concentric, Compressed, Compact) and Class C wire

Accessories

- Hardware - Section F
- PENETROX™ Oxide Inhibitor - Section F
- Heat and Cold Shrink Tubing - Section D
- WIREMIKE™ Wire Micrometer - Section F
- Wire Management (Cable Ties) - Section G

Electro-Tin
Plated

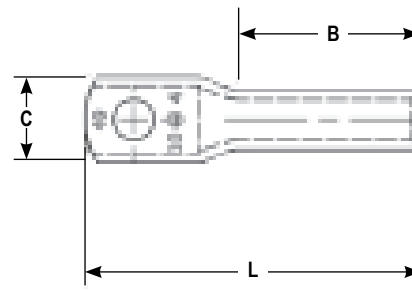
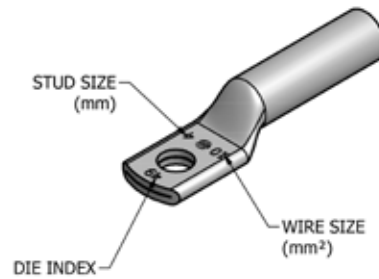

TYPE YALB-M (Continued)

NOTE: Field bending straight lugs to achieve an angular connection will void UL Listing / CSA Certifications and BURNDY will not be liable for the connection.

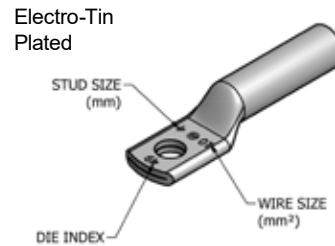

Catalog Number	Wire Range (MM²)	Stud Size	Dimensions (mm)				Installation Tooling					Wire Strip Length
			Tongue Thickness	(B)	(C)	(L)	Dieless	MD6, OUR840, MD734R	500 Series	35, 750, 46** Series	Die Index	
YALB10M4	10	M4	2.3	20.6	9.7	38.1	Y1MRTC (2) MY2911 (1) MRC840 (2) 81K Series (1)	W8CVT (2) W8CRT (2) X8CRT (2)	W8CVT (2) W8CRT (2) X8CRT (2)	U8CRT (2)	49	22
YALB10M5		M5	2	20.6	10.4	39.9						
YALB10M6		M6	2	20.6	11.2	42.9						
YALB10M8		M8	1.5	20.6	13.2	44.5						
YALB10M10		M10	1.5	20.6	14.7	47.8						
YALB10M12		M12	3	20.6	21.1	58.9						
YALB16M4	16	M4	2	28.4	11.4	47.2	Y1MRTC (2) MY2911 (2) MRC840 (2) 81K Series (1)	W5CVT (2) W5CRT (2) X5CRT (2)	W5CVT (2) W5CRT (2) X5CRT (2)	U5CRT (2)	7	30
YALB16M5		M5	2	28.4	11.4	48.8						
YALB16M6		M6	2	28.4	12.2	51.8						
YALB16M8		M8	1.8	28.4	13.2	53.6						
YALB16M10		M10	1.5	28.4	14.7	59.2						
YALB16M12		M12	3	28.4	19.1	63.0						
YALB25M5	25	M5	2.3	31.8	14	53.6	Y1MRTC (4) MY2911 (2) MRC840 (2) 644 Series (1) 444 Series (1) 81K Series (1)	W3CRT (2)	W3CRT (2)	U3CRT (2)	9	33
YALB25M6		M6	2.3	31.8	14	56.6						
YALB25M8		M8	2.3	31.8	14	58.4						
YALB25M10		M10	2	31.8	14.7	61.5						
YALB25M12		M12	3	31.8	21.1	67.8						
YALB35M5		35	M5	2.5	35.1	17.3						
YALB35M6	M6		2.5	35.1	17.3	60.7						
YALB35M8	M8		2.5	35.1	17.3	62.2						
YALB35M10	M10		2.5	35.1	17.3	65.5						
YALB35M12	M12		3	35.1	21.1	71.9						
YALB50M6	50		M6	2.5	35.1	17.3	60.7	MY2911 (2) MRC840 (4) 644 Series (1) 444 Series (1) 81K Series (1)	W25VT (4) W25RT (4) X25RT (4)	W25VT (4) W25RT (4) X25RT (4)	U25RT (2)	12
YALB50M8		M8	2.5	35.1	17.3	62.2						
YALB50M10		M10	2.5	35.1	17.3	65.5						
YALB50M12		M12	3	35.1	21.1	71.9						
YALB50M14		M14	3	35.1	21.1	72.9						
YALB50M16		M16	3	35.1	21.1	78.2						
YALB70M6	70	M6	3	38.1	21.1	65.5	MY2911 (2) MRC840 (4) 644 Series (1) 444 Series (1) 81K Series (2)	W26VT (4) W26RT (4) X26RT (4)	W26VT (4) W26RT (4) X26RT (4)	U26RT (2)	13	40
YALB70M8		M8	3	38.1	21.1	67.3						
YALB70M10		M10	3	38.1	21.1	70.4						
YALB70M12		M12	3	38.1	21.1	76.7						
YALB70M14		M14	3	38.1	21.1	77.7						
YALB70M16		M16	3	38.1	21.1	86.4						
YALB95M8	95	M8	3.3	38.1	23.6	68.6	MY2911 (2) MRC840 (4) 644 Series (1) 444 Series (1) 81K Series (2)	W27VT (4) W27RT (4) X27RT (4)	W27VT (4) W27RT (4) X27RT (4)	U27RT (2)	14	40
YALB95M10		M10	3.3	38.1	23.6	71.6						
YALB95M12		M12	3.3	38.1	23.6	78						
YALB95M14		M14	3.3	38.1	23.6	79						
YALB95M16		M16	3.3	38.1	23.6	84.3						
YALB95M20		M20	4.1	38.1	30.5	95.5						

* Use equivalent AWG setting on tool for installation

** PUADP1 Adaptor is required to use U Dies in 46 Series

• P-RT dies for 46 Series Tooling only

Compression Connections

Copper Compression — Code — One Hole
Long Barrel — Metric Lugs

TYPE YALB-M (Continued)

NOTE: Field bending straight lugs to achieve an angular connection will void UL Listing / CSA Certifications and BURNDY will not be liable for the connection.

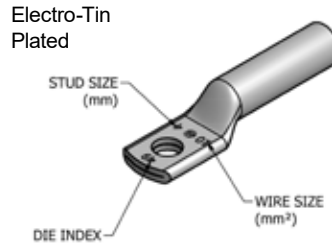

Catalog Number	Wire Range (MM²)	Stud Size	Dimensions (mm)				Installation Tooling					Wire Strip Length
			Tongue Thickness	(B)	(C)	(L)	Dieless	MD6, OUR840, MD734R	500 Series	35, 750, 46** Series	Die Index	
YALB120M8	120	M8	3.6	41.1	29	73.9	MY2911 (2) MRC840 (4) 644 Series (1) 444 Series (1) 81K Series (2)	W28VT (4) W28RT (4) X28RT (6)	W28VT (4) W28RT (4) X28RT (6)	U28RT (2)	15	43
YALB120M10		M10	3.6	41.1	29	77.2						
YALB120M12		M12	3.6	41.1	29	83.6						
YALB120M14		M14	3.6	41.1	29	84.6						
YALB120M16		M16	3.6	41.1	29	89.9						
YALB120M20		M20	4.3	41.1	30.5	101.1						
YALB150M8	150	M8	4.1	50.8	30.5	84.1	644 Series (1) 444 Series (1) 81K Series (3)	W30VT (4)	W30VT (4)	U30RT (4)	17	52
YALB150M10		M10	4.1	50.8	30.5	87.4						
YALB150M12		M12	4.1	50.8	30.5	93.7						
YALB150M14		M14	4.1	50.8	30.5	94.7						
YALB150M16		M16	4.1	50.8	30.5	100.1						
YALB150M20		M20	4.1	50.8	30.5	111.3						
YALB185M8	185	M8	4.3	50.8	32.8	85.1		W31VT (4)	W31VT (4)	U31RT (4)	18	52
YALB185M10		M10	4.3	50.8	32.8	88.4						
YALB185M12		M12	4.3	50.8	32.8	94.7						
YALB185M14		M14	4.3	50.8	32.8	95.3						
YALB185M16		M16	4.3	50.8	32.8	101.1						
YALB185M20		M20	4.3	50.8	32.8	112.3						
YALB240M10	240	M10	5.6	57.2	39.4	98	W34VT (4)	W34VT (4)	U34RT (4)	20	59	
YALB240M12		M12	5.6	57.2	39.4	105.2						
YALB240M14		M14	5.6	57.2	39.4	106.2						
YALB240M16		M16	5.6	57.2	39.4	111.3						
YALB240M20		M20	5.6	57.2	39.4	122.4						
YALB300M10	300	M10	6.6	68.3	44.2	111.8	644 Series (1) 444 Series (1) 81K Series (4)	—	—	U36RT (4)	22	70
YALB300M12		M12	6.6	68.3	44.2	118.1						
YALB300M14		M14	6.6	68.3	44.2	119.1						
YALB300M16		M16	6.6	68.3	44.2	124.5						
YALB300M20		M20	6.6	68.3	44.2	135.4						
YALB400M12	400	M12	7.6	74.7	50.3	127	—	—	U39RT (4)	24	76	
YALB400M14		M14	7.6	74.7	50.3	128						
YALB400M16		M16	7.6	74.7	50.3	133.4						
YALB400M20		M20	7.6	74.7	50.3	144.3						
YALB500M12	500	M12	8.1	76.2	55.6	132.1	—	—	U44XRT (4) P44XRT (4)	L115	78	
YALB500M16		M16	8.1	76.2	55.6	138.4						
YALB500M20		M20	8.1	76.2	55.6	149.4						
YALB630M12	630	M12	9.7	81	62.5	139.4	—	—	P45RT (6)	29	83	
YALB630M16		M16	9.7	81	62.5	145.8						
YALB630M20		M20	9.7	81	62.5	157						

* Use equivalent AWG setting on tool for installation.

** PUADP1 Adaptor is required to use U Dies in 46 Series tools.

† P-RT Die sets for use in 46 Series only, PUADP1 Adaptor not required.

TYPE YAV-2M

HYLUG™

Rated for 90° C, Up to 35 kV ♦

Made from electrolytic copper tube and is electro-tin plated. Wire range is from 2.5 mm² to 630 mm² Class 2. Compatible to IEC61238-1.

NOTE: Field bending straight lugs to achieve an angular connection will void UL Listing / CSA Certifications and BURNDY will not be liable for the connection.

Features & Benefits

- Inspection window allows for visual verification that the wire has been fully inserted prior to crimping the lug; not recommended in highly corrosive environments as the wire in the barrel is exposed to corrosive elements installed
- Barrel is designed with an internal chamfer at the wire entry to ensure smooth insertion of the wire, preventing possible damaging of the wire strands during installation
- Short/standard length barrel is recommended for installations with limited space requirements and meet the exact UL testing requirements as long barrel connectors so performance of the connection is not compromised
- Two hole tongue/tang is recommended when space permits as the 2-hole feature minimizes the terminations from loosening or rotating under vibration, movement, or heat cycling
- Electro-tin plated unless specified to reduce galvanic corrosion (bimetallic) and resist corrosive elements
- Compatible Standards: IEC61238-1, UL 486A-486B, CSA-C22.2 No. 65-03
- Connectors are clearly marked with stamping
- Terminals and splices accommodating code wire: Accommodates Code Class B (Concentric, Compressed, Compact) and Class C wire

Accessories

- Hardware - Section F
- PENETROX™ Oxide Inhibitor - Section F
- Heat and Cold Shrink Tubing - Section D
- WIREMIKE™ Wire Micrometer - Section F
- Wire Management (Cable Ties) - Section G

Electro-Tin
Plated

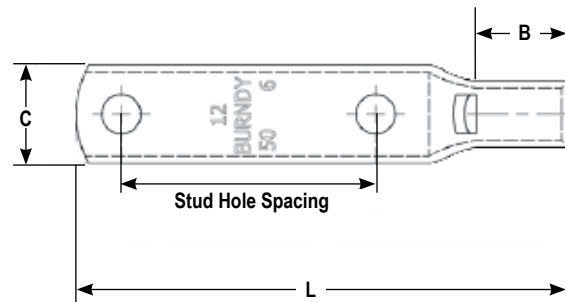

Compression Connections

Copper Compression — Code — Two Hole
Standard Barrel — Metric Lugs

TYPE YAV-2M (Continued)

Electro-Tin
Plated



NOTE: Field bending straight lugs to achieve an angular connection will void UL Listing / CSA Certifications and BURNDY will not be liable for the connection.

Catalog Number	Wire Range (MM ²)	Stud Size	Stud Hole Spacing	Dimensions (mm)				Installation Tooling					Wire Strip Length (mm)
				Tongue Width	(B)	(C)	(L)	Dieless	MD6, OUR840, MD734R	500 Series	35, 750, 46** Series	Die Index	
YAV0252M3	2.5	M3	25.4	1	170.2	200.7	44.7	Y10D (1)	—	—	—	—	7
YAV0252M4		M4	25.4	1	170.2	200.7	44.7	Y1022 (1)					
YAV0252M5		M5	25.4	1	170.2	200.7	44.7	MR8G98 (1)					
YAV0252M6		M6	25.4	0.8	170.2	271.8	49.8	MR89Q (1)					
YAV0252M8		M8	25.4	0.8	170.2	279.4	49.8	Y8MRB1 (1)					
YAV062M4	6	M4	25.4	1.5	264.2	241.3	49.5	Y10D (1)	—	—	—	—	11
YAV062M5		M5	25.4	1.5	264.2	241.3	49.5	Y1022 (1)					
YAV062M6		M6	25.4	1.3	264.2	302.3	52.6	MR8G98 (1)					
YAV062M8		M8	25.4	1	264.2	342.9	53.3	MR89Q (1)					
YAV062M10		M10	25.4	1	302.3	360.7	54.6	Y8MRB1 (1)					
YAV102M4	10	M4	44.5	0	284.5	264.2	73.4	Y1MRTC (1)	W8CVT (1)	W8CVT (1)	U8CRT (1)	49	11
YAV102M5		M5	44.5	0	284.5	264.2	74.9						
YAV102M6		M6	44.5	0	284.5	297.2	78.2						
YAV102M8		M8	44.5	0	284.5	335.3	79.8						
YAV102M10		M10	44.5	0	284.5	348	83.1						
YAV102M12	M12	44.5	0	284.5	469.9	89.4	81K Series (1)	X8CRT (1)	X8CRT (1)				
YAV162M4	16	M4	44.5	2	322.6	309.9	76.2	Y1MRTC (1)	W5CVT (1)	W5CVT (1)	U5CRT (1)	7	13
YAV162M5		M5	44.5	2	322.6	309.9	77.7						
YAV162M6		M6	44.5	2	322.6	309.9	80.8						
YAV162M8		M8	44.5	1.5	322.6	386.1	82.6						
YAV162M10		M10	44.5	1.5	322.6	373.4	85.6						
YAV162M12	M12	44.5	1.3	322.6	477.5	91.9	MRC840 (1)	W5CRT (1)	W5CRT (1)				
YAV252M5	25	M5	44.5	2	322.6	355.6	78.2	Y1MRTC (2)	W3CRT (1)	W3CRT (1)	U3CRT (1)	9	13
YAV252M6		M6	44.5	2	322.6	322.6	81.3						
YAV252M8		M8	44.5	2	322.6	406.4	83.1						
YAV252M10		M10	44.5	2	322.6	373.4	86.1						
YAV252M12		M12	44.5	1.5	322.6	469.9	92.5						
YAV352M5	35	M5	44.5	2.5	406.4	439.4	85.9	Y1MRTC (2)	W2CVT (1)	W2CVT (1)	U2CRT (1)	10	17
YAV352M6		M6	44.5	2.5	406.4	439.4	87.6						
YAV352M8		M8	44.5	2.5	406.4	439.4	90.7						
YAV352M10		M10	44.5	2.5	406.4	439.4	90.7						
YAV352M12		M12	44.5	2.5	406.4	439.4	97						
YAV502M6	50	M6	44.5	2.5	406.4	439.4	85.9	MY2911 (1)	W25VT (2)	W25VT (2)	U25RT (1)	12	17
YAV502M8		M8	44.5	2.5	406.4	439.4	87.6						
YAV502M10		M10	44.5	2.5	406.4	439.4	90.7						
YAV502M12		M12	44.5	2.5	406.4	469.9	97						
YAV502M14		M14	44.5	3	406.4	535.9	98						
YAV502M16	M16	44.5	3	406.4	657.9	103.4	MRC840 (2)	W25RT (2)	W25RT (2)				
YAV702M6	70	M6	44.5	3	444.5	535.9	89.2	MY2911 (1)	W26VT (2)	W26VT (2)	U26RT (1)	13	19
YAV702M8		M8	44.5	3	444.5	535.9	90.7						
YAV702M10		M10	44.5	3	444.5	535.9	94						
YAV702M12		M12	44.5	3	444.5	535.9	100.3						
YAV702M14		M14	44.5	2.8	444.5	569	101.3						
YAV702M16	M16	44.5	2.8	444.5	569	106.7	81K Series (1)	W26RT (2)	W26RT (2)				

* Use equivalent AWG setting on tool for installation.

** PUADP1 Adaptor is required to use U Dies in 46 Series tools.

† P-RT Die sets for use in 46 Series only, PUADP1 Adaptor not required.

TYPE YAV-2M (Continued)

Electro-Tin
Plated



NOTE: Field bending straight lugs to achieve an angular connection will void UL Listing / CSA Certifications and BURNDY will not be liable for the connection.

Catalog Number	Wire Range (MM ²)	Stud Size	Stud Hole Spacing	Dimensions (mm)				Installation Tooling					Wire Strip Length (mm)
				Tongue Width	(B)	(C)	(L)	Dieless	MD6, OUR840, MD734R	500 Series	35, 750, 46** Series	Die Index	
YAV952M8	95	M8	44.5	3.3	523.2	599.4	95	MY2911 (1) MRC840 (2) 644 Series (1) 444 Series (1) 81K Series (2)	W27VT (2) W27RT (2) X27RT (3)	W27VT (2) W27RT (2) X27RT (3)	U27RT (1)	14	22
YAV952M10		M10	44.5	3.3	523.2	599.4	98.3						
YAV952M12		M12	44.5	3.3	523.2	599.4	104.6						
YAV952M14		M14	44.5	3.3	523.2	599.4	105.7						
YAV952M16		M16	44.5	3.3	523.2	599.4	111						
YAV952M20		M20	44.5	4.1	523.2	774.7	122.2						
YAV1202M8	120	M8	44.5	3.6	665.5	736.6	102.9	MY2911 (1) MRC840 (2) 644 Series (1) 444 Series (1) 81K Series (2)	W28VT (3) W28RT (3) X28RT (3)	W28VT (2) W28RT (2) X28RT (3)	U28RT (1)	15	27
YAV1202M10		M10	44.5	3.6	665.5	736.6	106.2						
YAV1202M12		M12	44.5	3.8	665.5	736.6	112.5						
YAV1202M14		M14	44.5	3.6	665.5	736.6	113.5						
YAV1202M16		M16	44.5	3.6	665.5	736.6	118.9						
YAV1202M20		M20	44.5	4.3	665.5	736.6	130						
YAV1502M8	150	M8	44.5	4.1	665.5	774.7	103.4	644 Series (1) 444 Series (1) 81K Series (2)	W30VT (2)	W30VT (2) W30RT (2)	U30RT (2)	17	27
YAV1502M10		M10	44.5	4.1	665.5	774.7	106.7						
YAV1502M12		M12	44.5	4.1	665.5	774.7	113						
YAV1502M14		M14	44.5	4.1	665.5	774.7	114						
YAV1502M16		M16	44.5	4.1	665.5	774.7	119.4						
YAV1502M20		M20	44.5	4.1	665.5	774.7	130.3						
YAV1852M8	185	M8	44.5	4.3	683.3	833.1	104.9	644 Series (1) 444 Series (1) 81K Series (2)	W31VT (2)	W31VT (2) W31RT (2)	U31RT (2)	18	29
YAV1852M10		M10	44.5	4.3	683.3	833.1	108.2						
YAV1852M12		M12	44.5	4.3	683.3	833.1	114.6						
YAV1852M14		M14	44.5	4.3	683.3	833.1	115.6						
YAV1852M16		M16	44.5	4.3	683.3	833.1	120.9						
YAV1852M20		M20	44.5	4.3	683.3	833.1	132.1						
YAV2402M10	240	M10	44.5	5.6	820.4	1000.8	117.6	644 Series (1) 444 Series (1) 81K Series (2)	W34VT (2)	W34VT (2) W34RT (2)	U34RT (2)	20	33
YAV2402M12		M12	44.5	5.6	820.4	1000.8	125						
YAV2402M14		M14	44.5	5.6	820.4	1000.8	125						
YAV2402M16		M16	44.5	5.6	820.4	1000.8	130.3						
YAV2402M20		M20	44.5	5.6	820.4	1000.8	141.2						
YAV3002M10	300	M10	44.5	6.6	175.3	1122.7	121.9	644 Series (1) 444 Series (1) 81K Series (2)	—	—	U36RT (2)	22	35
YAV3002M12		M12	44.5	6.6	167.6	1122.7	128.3						
YAV3002M14		M14	44.5	6.6	175.3	1122.7	129						
YAV3002M16		M16	44.5	6.6	175.3	1122.7	134.6						
YAV3002M20		M20	44.5	6.6	175.3	1122.7	145.5						
YAV4002M14	400	M14	44.5	7.6	193	1277.6	132.8	644 Series (1)	—	—	U39RT (3)	24	37
YAV4002M16		M16	44.5	7.6	193	1277.6	138.2	444 Series (1)					
YAV4002M20		M20	44.5	7.6	193	1277.6	149.4	81K Series (2)					
YAV5002M16	500	M16	44.5	8.1	205.7	1412.2	147.3	644 Series (1)	—	—	U44XRT (3) † P44XRT (3)	L115	43
YAV5002M20		M20	44.5	8.1	205.7	1412.2	158.5	444 Series (1) 81K Series (2)					
YAV6302M16	630	M16	44.5	9.7	246.4	1587.5	158.8	644 Series (1)	—	—	† P45RT (3)	29	55
YAV6302M20		M20	44.5	9.7	246.4	1587.5	169.9	444 Series (1) 81K Series (2)					

* Use equivalent AWG setting on tool for installation

** PUADP1 Adaptor is required to use U Dies in 46 Series

• P-RT dies for 46 Series Tooling only

TYPE YALB-2M

HYLUG™

Rated for 90° C, Up to 35 kV ♦

Made from electrolytic copper tube and is electro-tin plated. Wire range is from 10 mm² to 630 mm² Class 2. Compatible to **IEC61238-1**.

NOTE: Field bending straight lugs to achieve an angular connection will void UL Listing / CSA Certifications and BURNDY will not be liable for the connection.

Electro-Tin
Plated

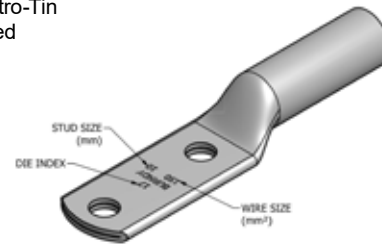

Features & Benefits

- No inspection window is ideal for more corrosive environments as the barrel transition is not open
- Barrel is designed with an internal chamfer at the wire entry to ensure smooth insertion of the wire, preventing possible damaging of the wire strands during installation
- Long barrel allows for an increased number of crimps which will increase the mechanical strength of the connection
- Two hole tongue/tang is recommended when space permits as the 2-hole feature minimizes the terminations from loosening or rotating under vibration, movement, or heat cycling
- Electro-tin plated unless specified to reduce galvanic corrosion (bimetallic) and resist corrosive elements
- Compatible Standards: IEC61238-1, UL 486A-486B, CSA-C22.2 No. 65-03
- Connectors are clearly marked with stamping
- Terminals and splices accommodating code wire: Accommodates Code Class B (Concentric, Compressed, Compact) and Class C wire

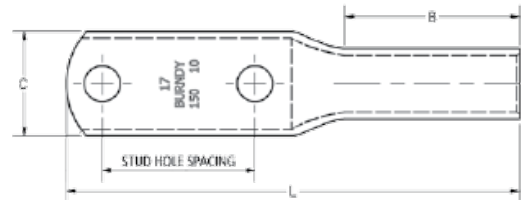

Accessories

- Hardware - Section F
- PENETROX™ Oxide Inhibitor - Section F
- Heat and Cold Shrink Tubing - Section D
- WIREMIKE™ Wire Micrometer - Section F
- Wire Management (Cable Ties) - Section G

TYPE YALB-2M (Continued)

Electro-Tin
Plated

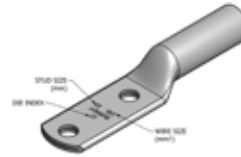

NOTE: Field bending straight lugs to achieve an angular connection will void UL Listing / CSA Certifications and BURNDY will not be liable for the connection.

Catalog Number	Wire Range (MM ²)	Stud Size	Stud Hole Spacing	Dimensions (mm)				Installation Tooling					Wire Strip Length (mm)
				Tongue Thickness	(B)	(C)	(L)	Dieless*	MD6, OUR840, MD734R	500 Series	35, 750, 46** Series	Die Index	
YALB102M4	10	M4	44.5	2.3	20.6	9.9	82.6	Y1MRTC (2) MY2911 (1) MRC840 (2) 81K Series (1)	W8CVT (2) W8CRT (2) X8CRT (2)	W8CVT (2) W8CRT (2) X8CRT (2)	U8CRT (2)	49	22
YALB102M5		M5	44.5	2.0	20.6	10.4	84.3						
YALB102M6		M6	44.5	2.0	20.6	11.2	87.4						
YALB102M8		M8	44.5	1.5	20.6	13.2	88.9						
YALB102M10		M10	44.5	1.5	20.6	14.7	92.2						
YALB102M12		M12	44.5	3.0	20.6	21.1	103.4						
YALB162M4	16	M4	44.5	2.3	28.4	11.4	91.7	Y1MRTC (2) MY2911 (2) MRC840 (2) 81K Series (1)	W5CVT (2) W5CRT (2) X5CRT (2)	W5CVT (2) W5CRT (2) X5CRT (2)	U5CRT (2)	7	30
YALB162M5		M5	44.5	2.3	28.4	11.4	93.2						
YALB162M6		M6	44.5	2.0	28.4	12.2	96.5						
YALB162M8		M8	44.5	1.8	28.4	13.2	98.0						
YALB162M10		M10	44.5	1.5	28.4	14.7	103.6						
YALB162M12		M12	44.5	3.0	28.4	19.1	107.7						
YALB252M5	25	M5	44.5	2.3	31.8	14.0	98.0	81K Series (1)	W3CRT (2)	W3CRT (2)	U3CRT (2)	9	33
YALB252M6		M6	44.5	2.3	31.8	14.0	101.1						
YALB252M8		M8	44.5	2.3	31.8	14.0	102.9						
YALB252M10		M10	44.5	2.0	31.8	14.7	105.9						
YALB252M12		M12	44.5	3.0	31.8	21.1	112.5						
YALB352M5	35	M5	44.5	2.5	35.1	17.3	102.1	Y1MRTC (4) MY2911 (2) MRC840 (2) 644 Series (1) 444 Series (1) 81K Series (1)	W2CVT (2) W2CRT (2) X2CRT (2)	W2CVT (2) W2CRT (2) X2CRT (2)	U2CRT (2)	10	37
YALB352M6		M6	44.5	2.5	35.1	17.3	105.2						
YALB352M8		M8	44.5	2.5	35.1	17.3	106.8						
YALB352M10		M10	44.5	2.5	35.1	17.3	110.0						
YALB352M12		M12	44.5	3.0	35.1	21.1	116.4						
YALB502M6	50	M6	44.5	2.5	35.1	17.3	105.2	MY2911 (2) MRC840 (4) 644 Series (1) 444 Series (1) 81K Series (2)	W25VT (4) W25RT (4) X25RT (4)	W25VT (4) W25RT (4) X25RT (4)	U25RT (2)	12	37
YALB502M8		M8	44.5	2.5	35.1	17.3	106.7						
YALB502M10		M10	44.5	2.5	35.1	17.3	110.0						
YALB502M12		M12	44.5	3.0	35.1	21.1	116.3						
YALB502M14		M14	44.5	3.0	35.1	21.1	117.3						
YALB502M16		M16	44.5	3.0	35.1	21.1	122.7						

* Use equivalent AWG setting on tool for installation

** PUADP1 Adaptor is required to use U Dies in 46 Series

• P-RT dies for 46 Series Tooling only

Compression Connections

Copper Compression — Code — Two Hole
Long Barrel — Metric Lugs

TYPE YALB-2M (Continued)

Electro-Tin
Plated

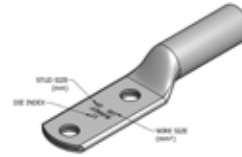

NOTE: Field bending straight lugs to achieve an angular connection will void UL Listing / CSA Certifications and BURNDY will not be liable for the connection.

Catalog Number	Wire Range (MM ²)	Stud Size	Stud Hole Spacing	Dimensions (mm)			Installation Tooling					Wire Strip Length (mm)	
				Tongue Thickness	(B)	(C)	(L)	Dieless*	MD6, OUR840, MD734R	500 Series	35, 750, 46** Series		Die Index
YALB702M6	70	M6	44.5	3.0	38.1	21.1	110.0		W26VT (4) W26RT (4) X26RT (4)	W26VT (4) W26RT (4) X26RT (4)	U26RT (2)	13	40
YALB702M8		M8	44.5	3.0	38.1	21.1	111.8						
YALB702M10		M10	44.5	3.0	38.1	21.1	114.8						
YALB702M12		M12	44.5	3.0	38.1	21.1	121.4						
YALB702M14		M14	44.5	3.0	38.1	21.1	122.2						
YALB702M16		M16	44.5	3.0	38.1	21.1	130.8						
YALB952M8	95	M8	44.5	3.3	38.1	23.6	113.0	MY2911 (2) MRC840 (4) 644 Series (1) 444 Series (1) 81K Series (2)	W27VT (4) W27RT (4) X27RT (6)	W27VT (4) W27RT (4) X27RT (6)	U27RT (2)	14	40
YALB952M10		M10	44.5	3.3	38.1	23.6	116.1						
YALB952M12		M12	44.5	3.3	38.1	23.6	122.4						
YALB952M14		M14	44.5	3.3	38.1	23.6	123.4						
YALB952M16		M16	44.5	3.3	38.1	23.6	128.8						
YALB952M20		M20	44.5	4.1	38.1	30.5	140.0						
YALB1202M8	120	M8	44.5	3.8	41.1	29.0	118.6		W28VT (4) W28RT (4) X28RT (6)	W28VT (4) W28RT (4) X28RT (6)	U28RT (2)	15	43
YALB1202M10		M10	44.5	3.8	41.1	29.0	124.1						
YALB1202M12		M12	44.5	3.8	41.1	29.0	128.0						
YALB1202M14		M14	44.5	3.8	41.1	29.0	129.0						
YALB1202M16		M16	44.5	3.8	41.1	29.0	134.4						
YALB1202M20		M20	44.5	4.3	41.1	30.5	145.5						
YALB1502M8	150	M8	44.5	4.1	50.8	30.5	128.8	644 Series (1) 444 Series (1) 81K Series (3)	W30VT (4)	W30VT (4) W30RT (4)	U30RT (4)	17	52
YALB1502M10		M10	44.5	4.1	50.8	30.5	131.8						
YALB1502M12		M12	44.5	4.1	50.8	30.5	138.2						
YALB1502M14		M14	44.5	4.1	50.8	30.5	139.2						
YALB1502M16		M16	44.5	4.1	50.8	30.5	145.3						
YALB1502M20		M20	44.5	4.1	50.8	30.5	156.2						
YALB1852M8	185	M8	44.5	4.3	50.8	32.8	129.8		W31VT (4)	W31VT (4) W31RT (4)	U31RT (4)	18	52
YALB1852M10		M10	44.5	4.3	50.8	32.8	132.8						
YALB1852M12		M12	44.5	4.3	50.8	32.8	139.2						
YALB1852M14		M14	44.5	4.3	50.8	32.8	139.7						
YALB1852M16		M16	44.5	4.3	50.8	32.8	145.5						
YALB1852M20		M20	44.5	4.3	50.8	32.8	156.7						

* Use equivalent AWG setting on tool for installation.

** PUADP1 Adaptor is required to use U Dies in 46 Series tools.

† P-RT Die sets for use in 46 Series only, PUADP1 Adaptor not required.

TYPE YALB-2M (Continued)

Electro-Tin
Plated



NOTE: Field bending straight lugs to achieve an angular connection will void UL Listing / CSA Certifications and BURNDY will not be liable for the connection.

Catalog Number	Wire Range (MM ²)	Stud Size	Stud Hole Spacing	Dimensions (mm)				Installation Tooling					Wire Strip Length (mm)				
				Tongue Thickness	(B)	(C)	(L)	Dieless*	MD6, OUR840, MD734R	500 Series	35, 750, 46** Series	Die Index					
YALB2402M10	240	M10	44.5	5.6	57.2	39.4	142.5	644 Series (1) 444 Series (1) 81K Series (4)	W34VT (4)	W34VT (4) W34RT (4)	U34RT (4)	20	59				
YALB2402M12		M12	44.5	5.6	57.2	39.4	149.6										
YALB2402M14		M14	44.5	5.6	57.2	39.4	150.6										
YALB2402M16		M16	44.5	5.6	57.2	39.4	156.0										
YALB2402M20		M20	44.5	5.6	57.2	39.4	166.9										
YALB3002M10	300	M10	44.5	6.6	68.3	44.2	156.2		644 Series (1) 444 Series (1) 81K Series (4)	—	—	U36RT (4)	22	70			
YALB3002M12		M12	44.5	6.6	68.3	44.2	162.6										
YALB3002M14		M14	44.5	6.6	68.3	44.2	163.6										
YALB3002M16		M16	44.5	6.6	68.3	44.2	168.9										
YALB3002M20		M20	44.5	6.6	68.3	44.2	179.6										
YALB4002M12	400	M12	44.5	7.6	74.7	50.3	171.4					644 Series (1) 444 Series (1) 81K Series (4)	—	—	U39RT (4)	24	76
YALB4002M14		M14	44.5	7.6	74.7	50.3	172.5										
YALB4002M16		M16	44.5	7.6	74.7	50.3	177.8										
YALB4002M20		M20	44.5	7.6	74.7	50.3	189.0										
YALB5002M12	500	M12	44.5	8.1	76.2	55.6	176.5						644 Series (1) 444 Series (1) 81K Series (4)	—	—	U44XRT (4) †P44XRT (4)	L115
YALB5002M16		M16	44.5	8.1	76.2	55.6	182.9										
YALB5002M20		M20	44.5	8.1	76.2	55.6	194.1										
YALB6302M12	630	M12	44.5	9.7	81.0	62.5	183.9	644 Series (1) 444 Series (1) 81K Series (4)		—	—			† P45RT (6)	29	83	
YALB6302M16		M16	44.5	9.7	81.0	62.5	190.5										
YALB6302M20		M20	44.5	9.7	81.0	62.5	201.4										

* Use equivalent AWG setting on tool for installation

** PUADP1 Adaptor is required to use U Dies in 46 Series

• P-RT dies for 46 Series Tooling only

TYPE YAV-FM

HYLUG™

Rated for 90° C, Up to 35 kV ♦

Made from electrolytic copper tube and is electro-tin plated. Wire range is from 50 mm² to 630 mm² Class 5. Compatible to **IEC61238-1**.

NOTE: Field bending straight lugs to achieve an angular connection will void UL Listing / CSA Certifications and BURNDY will not be liable for the connection.

Features & Benefits

- No inspection window is ideal for more corrosive environments as the barrel transition is not open
- Barrel is designed with an internal chamfer at the wire entry to ensure smooth insertion of the wire, preventing possible damaging of the wire strands during installation
- Short/standard length barrel is recommended for installations with limited space requirements
- Electro-tin plated unless specified to reduce galvanic corrosion (bimetallic) and resist corrosive elements
- Compatible Standards: IEC61238-1, UL 486A-486B, CSA-C22.2 No. 65-03
- Connectors are clearly marked with stamping

Accessories

- Hardware - Section F
- PENETROX™ Oxide Inhibitor - Section F
- Heat and Cold Shrink Tubing - Section D
- WIREMIKE™ Wire Micrometer - Section F
- Wire Management (Cable Ties) - Section G

Electro-Tin
Plated

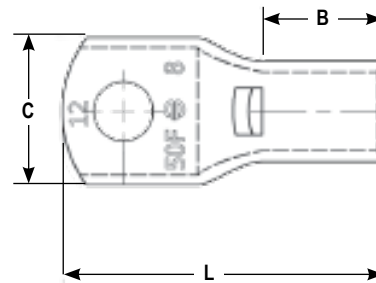
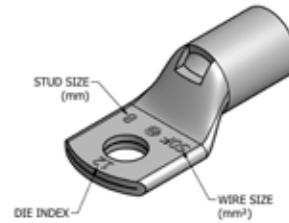

TYPE YAV-FM (Continued)

Electro-Tin
Plated

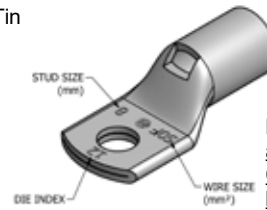

NOTE: Field bending straight lugs to achieve an angular connection will void UL Listing / CSA Certifications and BURNDY will not be liable for the connection.

Catalog Number	Wire Range (MM ²)	Stud Size	Dimensions (mm)				Installation Tooling					Wire Strip Length
			Tongue Thickness	(B)	(C)	(L)	Dieless*	MD6, OUR840, MD734R	500 Series	35, 750, 46** Series	Die Index	
YAV50FM6	50	M6	3.0	17.5	21.1	46.0	MY2911 (1) MRC840 (2) 644 Series (1) 444 Series (1) 81K Series (1)	W25VT (2) W25RT (2) X25RT (2)	W25VT (2) W25RT (2) X25RT (2)	U25RT (1)	12	19
YAV50FM8		M8	3.0	17.5	21.1	46.0						
YAV50FM10		M10	3.0	17.5	21.1	49.3						
YAV50FM12		M12	3.0	17.5	21.1	55.6						
YAV50FM14		M14	3.0	17.5	22.4	56.6						
YAV50FM16		M16	3.0	17.5	22.4	61.9						
YAV70FM6	70	M6	3.3	20.6	23.6	49.0	MY2911 (1) MRC840 (2) 644 Series (1) 444 Series (1) 81K Series (1)	W26VT (2) W26RT (2) X26RT (2)	W26VT (2) W26RT (2) X26RT (2)	U26RT (1)	13	22
YAV70FM8		M8	3.3	20.6	23.6	50.3						
YAV70FM10		M10	3.3	20.6	23.6	54.0						
YAV70FM12		M12	3.3	20.6	23.6	60.0						
YAV70FM14		M14	3.3	20.6	23.6	61.0						
YAV70FM16		M16	3.3	20.6	23.6	66.3						
YAV95FM8	95	M8	3.6	25.4	26.2	56.0	MY2911 (1) MRC840 (2) 644 Series (1) 444 Series (1) 81K Series (2)	W27VT (2) W27RT (2) X27RT (3)	W27VT (2) W27RT (2) X27RT (3)	U27RT (1)	14	27
YAV95FM10		M10	3.6	25.4	26.2	59.0						
YAV95FM12		M12	3.6	25.4	26.2	66.0						
YAV95FM14		M14	3.6	25.4	26.2	66.8						
YAV95FM16		M16	3.6	25.4	26.2	72.1						
YAV95FM20		M20	3.6	25.4	26.2	83.2						
YAV120FM8	120	M8	3.8	26.2	29.0	58.2	MY2911 (1) MRC840 (2) 644 Series (1) 444 Series (1) 81K Series (2)	W28VT (2) W28RT (2) X28RT (3)	W28VT (2) W28RT (2) X28RT (3)	U28RT (1)	15	27
YAV120FM10		M10	3.8	26.2	29.0	61.0						
YAV120FM12		M12	3.8	26.2	29.0	68.0						
YAV120FM14		M14	3.8	26.2	29.0	68.8						
YAV120FM16		M16	3.8	26.2	29.0	74.1						
YAV120FM20		M20	3.8	26.2	29.0	85.2						
YAV150FM8	150	M8	4.6	26.9	32.8	60.2	644 Series (1) 444 Series (1) 81K Series (2)	W30VT (2)	W30VT (2) W30RT (2)	U30RT (2)	17	29
YAV150FM10		M10	4.6	26.9	32.8	64.0						
YAV150FM12		M12	4.6	26.9	32.8	70.0						
YAV150FM14		M14	4.6	26.9	32.8	70.8						
YAV150FM16		M16	4.6	26.9	32.8	76.0						
YAV150FM20		M20	4.6	26.9	32.8	87.3						

* Use equivalent AWG setting on tool for installation

** PUADP1 Adaptor is required to use U Dies in 46 Series

• P-RT dies for 46 Series Tooling only

Compression Connections

Copper Compression — Flex — One Hole
Standard Barrel — Metric Lugs

TYPE YAV-FM (Continued)

Electro-Tin
Plated

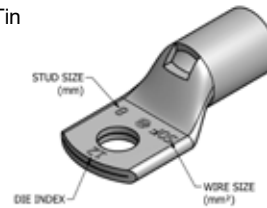

NOTE: Field bending straight lugs to achieve an angular connection will void UL Listing / CSA Certifications and BURNDY will not be liable for the connection.

Catalog Number	Wire Range (MM ²)	Stud Size	Dimensions (mm)				Installation Tooling					Wire Strip Length
			Tongue Thickness	(B)	(C)	(L)	Dieless*	MD6, OUR840, MD734R	500 Series	35, 750, 46** Series	Die Index	
YAV185FM8	185	M8	5.0	30.2	35.6	64.8	644 Series (1) 444 Series (1) 81K Series (2)	W31VT (2)	W31VT (2) W31RT (2)	U31RT (2)	18	29
YAV185FM10		M10	5.0	30.2	35.6	68.0						
YAV185FM12		M12	5.0	30.2	35.6	74.0						
YAV185FM14		M14	5.0	30.2	35.6	75.4						
YAV185FM16		M16	5.0	30.2	35.6	81.0						
YAV185FM20		M20	5.0	30.2	35.6	91.8						
YAV240FM10	240	M10	5.8	32.3	39.4	72.9	644 Series (1) 444 Series (1) 81K Series (2)	W34VT (2)	W34VT (2) W34RT (2)	U34RT (2)	20	33
YAV240FM12		M12	5.8	32.3	39.4	79.0						
YAV240FM14		M14	5.8	32.3	39.4	80.2						
YAV240FM16		M16	5.8	32.3	39.4	85.5						
YAV240FM20		M20	5.8	32.3	39.4	96.6						
YAV300FM10	300	M10	6.9	36.8	46.7	80.2	644 Series (1) 444 Series (1) 81K Series (2)			U36RT (2)	22	38
YAV300FM12		M12	6.9	36.8	46.7	87.0						
YAV300FM14		M14	6.9	36.8	46.7	87.5						
YAV300FM16		M16	6.9	36.8	46.7	93.0						
YAV300FM20		M20	6.9	36.8	46.7	104.0						
YAV400FM12	400	M12	7.6	36.1	50.3	87.0	644 Series (1) 444 Series (1) 81K Series (3)	—	—	U39RT (3)	24	37
YAV400FM14		M14	7.6	36.1	50.3	88.1						
YAV400FM16		M16	7.6	36.1	50.3	93.5						
YAV400FM20		M20	7.6	36.1	50.3	104.5						
YAV500FM12	500	M12	8.4	41.9	55.6	96.0	644 Series (1) 444 Series (1) 81K Series (3)			U44XRT (3) †P44XRT (3)	L115	43
YAV500FM16		M16	8.4	41.9	55.6	102.6						
YAV500FM20		M20	8.4	41.9	55.6	113.7						
YAV630FM12	630	M12	9.9	50.8	68.3	110.2	—			† P46RT (3)	31	55
YAV630FM16		M16	9.9	50.8	68.3	116.6						
YAV630FM20		M20	9.9	50.8	68.3	127.8						

* Use equivalent AWG setting on tool for installation.

** PUADP1 Adaptor is required to use U Dies in 46 Series tools.

† P-RT Die sets for use in 46 Series only, PUADP1 Adaptor not required.

TYPE YALB-FM

HYLUG™

Rated for 90° C, Up to 35 kV ♦

Made from electrolytic copper tube and is electro-tin plated. Wire range is from 50 mm² to 630 mm² Class 5. Compatible to **IEC61238-1**.

Features & Benefits

- No inspection window is ideal for more corrosive environments as the barrel transition is not open
- Barrel is designed with an internal chamfer at the wire entry to ensure smooth insertion of the wire, preventing possible damaging of the wire strands during installation
- Long barrel allows for an increased number of crimps which will increase the mechanical strength of the connection
- Electro-tin plated unless specified to reduce galvanic corrosion (bimetallic) and resist corrosive elements
- Compatible Standards: IEC61238-1, UL 486A-486B, CSA-C22.2 No. 65-03
- Connectors are clearly marked with stamping

Accessories

- Hardware - Section F
- PENETROX™ Oxide Inhibitor - Section F
- Heat and Cold Shrink Tubing - Section D
- WIREMIKE™ Wire Micrometer - Section F
- Wire Management (Cable Ties) - Section G

Electro-Tin
Plated

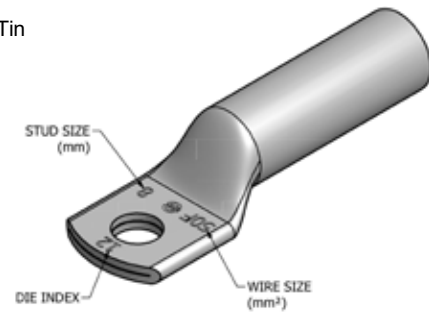

NOTE: Field bending straight lugs to achieve an angular connection will void UL Listing / CSA Certifications and BURNDY will not be liable for the connection.

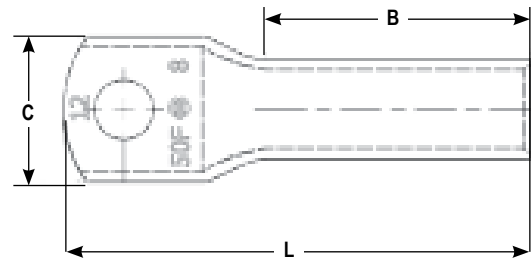

Compression Connections

Copper Compression — Flex — One Hole
Long Barrel — Metric Lugs

TYPE YALB-FM (Continued)

Electro-Tin
Plated

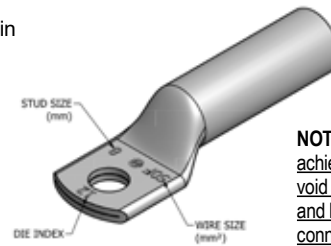

NOTE: Field bending straight lugs to achieve an angular connection will void UL Listing / CSA Certifications and BURNDY will not be liable for the connection.

Catalog Number	Wire Range (MM²)	Stud Size	Dimensions (mm)				Installation Tooling					Wire Strip Length
			Tongue Thickness	(B)	(C)	(L)	Dieless*	MD6, OUR840, MD734R	500 Series	35, 750, 46** Series	Die Index	
YALB50FM6	50	M6	3.0	38.1	21.1	65.5	MY2911 (2) MRC840 (4) 644 Series (1) 444 Series (1) 81K Series (2)	W25VT (4) W25RT (4) X25RT (4)	W25VT (4) W25RT (4) X25RT (4)	U25RT (2)	12	
YALB50FM8		M8	3.0	38.1	21.1	67.3						
YALB50FM10		M10	3.0	38.1	21.1	70.4						
YALB50FM12		M12	3.0	38.1	21.1	76.7						
YALB50FM14		M14	3.0	38.1	21.1	77.7						
YALB50FM16		M16	3.0	38.1	21.1	86.4						
YALB70FM6	70	M6	3.3	38.1	23.6	66.3	MY2911 (2) MRC840 (4) 644 Series (1) 444 Series (1) 81K Series (2)	W26VT (4) W26RT (4) X26RT (4)	W26VT (4) W26RT (4) X26RT (4)	U26RT (2)	13	40
YALB70FM8		M8	3.3	38.1	23.6	68.5						
YALB70FM10		M10	3.3	38.1	23.6	71.7						
YALB70FM12		M12	3.3	38.1	23.6	78.0						
YALB70FM14		M14	3.3	38.1	23.6	79.0						
YALB70FM16		M16	3.3	38.1	23.6	84.3						
YALB95FM8	95	M8	3.6	38.1	26.2	68.8	MY2911 (2) MRC840 (4) 644 Series (1) 444 Series (1) 81K Series (2)	W27VT (4) W27RT (4) X27RT (6)	W27VT (4) W27RT (4) X27RT (6)	U27RT (2)	14	
YALB95FM10		M10	3.6	38.1	26.2	72.1						
YALB95FM12		M12	3.6	38.1	26.2	78.5						
YALB95FM14		M14	3.6	38.1	26.2	79.5						
YALB95FM16		M16	3.6	38.1	26.2	84.8						
YALB95FM20		M20	3.6	38.1	26.2	96.0						
YALB120FM8	120	M8	3.8	41.1	29.0	73.9	MY2911 (2) MRC840 (4) 644 Series (1) 444 Series (1) 81K Series (2)	W28VT (4) W28RT (4) X28RT (6)	W28VT (4) W28RT (4) X28RT (6)	U28RT (2)	15	43
YALB120FM10		M10	3.8	41.1	29.0	79.5						
YALB120FM12		M12	3.8	41.1	29.0	83.6						
YALB120FM14		M14	3.8	41.1	29.0	84.6						
YALB120FM16		M16	3.8	41.1	29.0	89.9						
YALB120FM20		M20	3.8	41.1	29.0	101.1						
YALB150FM8	150	M8	4.3	50.8	32.8	85.1	644 Series (1) 444 Series (1) 81K Series (3)	W30VT (4)	W30VT (4) W30RT (4)	U30RT (4)	17	52
YALB150FM10		M10	4.3	50.8	32.8	88.4						
YALB150FM12		M12	4.3	50.8	32.8	94.7						
YALB150FM14		M14	4.3	50.8	32.8	95.3						
YALB150FM16		M16	4.3	50.8	32.8	101.1						
YALB150FM20		M20	4.3	50.8	32.8	112.3						

* Use equivalent AWG setting on tool for installation.

** PUADP1 Adaptor is required to use U Dies in 46 Series tools.

† P-RT Die sets for use in 46 Series only, PUADP1 Adaptor not required.

TYPE YALB-FM (Continued)

Electro-Tin
Plated

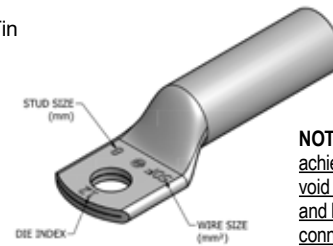

NOTE: Field bending straight lugs to achieve an angular connection will void UL Listing / CSA Certifications and BURNDY will not be liable for the connection.

Catalog Number	Wire Range (MM ²)	Stud Size	Dimensions (mm)				Installation Tooling					Wire Strip Length
			Tongue Thickness	(B)	(C)	(L)	Dieless*	MD6, OUR840, MD734R	500 Series	35, 750, 46** Series	Die Index	
YALB185FM8	185	M8	4.8	53.8	35.6	88.6	644 Series (1) 444 Series (1) 81K Series (3)	W31VT (4)	W31VT (4) W31RT (4)	U31RT (4)	18	52
YALB185FM10		M10	4.8	53.8	35.6	91.7						
YALB185FM12		M12	4.8	53.8	35.6	98.0						
YALB185FM14		M14	4.8	53.8	35.6	99.1						
YALB185FM16		M16	4.8	53.8	35.6	104.4						
YALB185FM20		M20	4.8	53.8	35.6	115.6						
YALB240FM10	240	M10	5.6	57.2	39.4	98.0	644 Series (1) 444 Series (1) 81K Series (4)	W34VT (4)	W34VT (4) W34RT (4)	U34RT (4)	20	59
YALB240FM12		M12	5.6	57.2	39.4	105.2						
YALB240FM14		M14	5.6	57.2	39.4	106.2						
YALB240FM16		M16	5.6	57.2	39.4	111.5						
YALB240FM20		M20	5.6	57.2	39.4	122.4						
YALB300FM10	300	M10	6.9	71.4	46.7	114.8	644 Series (1) 444 Series (1) 81K Series (4)			U36RT (4)	22	73
YALB300FM12		M12	6.9	71.4	46.7	121.2						
YALB300FM14		M14	6.9	71.4	46.7	122.2						
YALB300FM16		M16	6.9	71.4	46.7	127.5						
YALB300FM20		M20	6.9	71.4	46.7	138.7						
YALB400FM12	400	M12	7.6	74.7	50.3	127.0	644 Series (1) 444 Series (1) 81K Series (4)	—	—	U39RT (4)	24	76
YALB400FM14		M14	7.6	74.7	50.3	128.0						
YALB400FM16		M16	7.6	74.7	50.3	133.4						
YALB400FM20		M20	7.6	74.7	50.3	144.5						
YALB500FM12	500	M12	8.1	76.2	55.6	132.1	644 Series (1) 444 Series (1) 81K Series (4)			U44XRT (4) †P44XRT (4)	L115	78
YALB500FM16		M16	8.1	76.2	55.6	138.4						
YALB500FM20		M20	8.1	76.2	55.6	149.4						
YALB630FM12	630	M12	9.9	81.0	68.3	140.5	—			† P46RT (6)	31	83
YALB630FM16		M16	9.9	81.0	68.3	146.8						
YALB630FM20		M20	9.9	81.0	68.3	158.0						

* Use equivalent AWG setting on tool for installation

** PUADP1 Adaptor is required to use U Dies in 46 Series

• P-RT dies for 46 Series Tooling only

TYPE YAV-F2M

HYLUG™

Rated for 90° C, Up to 35 kV ♦

Made from electrolytic copper tube and is electro-tin plated. Wire range is from 50 mm² to 630 mm² Class 5. Compatible to IEC61238-1.

NOTE: Field bending straight lugs to achieve an angular connection will void UL Listing / CSA Certifications and BURNDY will not be liable for the connection.

Electro-Tin
Plated

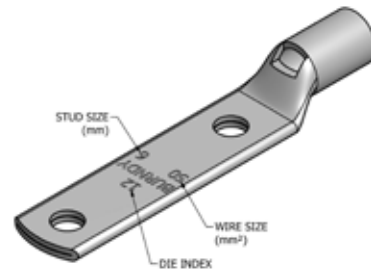

Features & Benefits

- Inspection window allows for visual verification that the wire has been fully inserted prior to crimping the lug
- Barrel is designed with an internal chamfer at the wire entry to ensure smooth insertion of the wire, preventing possible damaging of the wire strands during installation
- Short/standard length barrel is recommended for installations with limited space requirements
- Two hole tongue/tang is recommended when space permits as the 2-hole feature minimizes the terminations from loosening or rotating under vibration, movement, or heat cycling
- Electro-tin plated unless specified to reduce galvanic corrosion (bimetallic) and resist corrosive elements
- Compatible Standards: IEC61238-1, UL 486A-486B, CSA-C22.2 No. 65-03
- Connectors are clearly marked with stamping

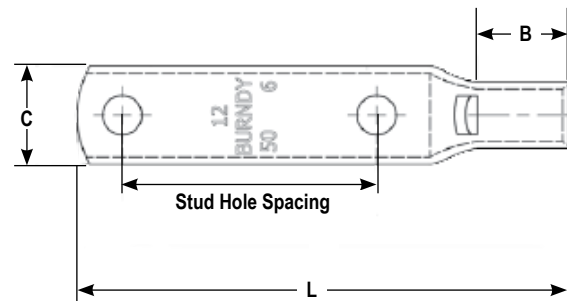

Accessories

- Hardware - Section F
- PENETROX™ Oxide Inhibitor - Section F
- Heat and Cold Shrink Tubing - Section D
- WIREMIKE™ Wire Micrometer - Section F
- Wire Management (Cable Ties) - Section G

TYPE YAV-F2M (Continued)

Electro-Tin
Plated



NOTE: Field bending straight lugs to achieve an angular connection will void UL Listing / CSA Certifications and BURNDY will not be liable for the connection.

Catalog Number	Wire Range (MM ²)	Stud Size	Stud Hole Spacing	Dimensions (mm)				Installation Tooling					Wire Strip Length (mm)
				Tongue Thickness	(B)	(C)	(L)	Dieless*	MD6, OUR840, MD734R	500 Series	35, 750, 46** Series	Die Index	
YAV50F2M6	50	M6	44.5	3.0	17.5	21.1	89.2	MY2911 (1) MRC840 (2) 644 Series (1) 444 Series (1) 81K Series (1)	W25VT (2) W25RT (2) X25RT (2)	W25VT (2) W25RT (2) X25RT (2)	U25RT (1)	12	19
YAV50F2M8		M8	44.5	3.0	17.5	21.1	90.7						
YAV50F2M10		M10	44.5	3.0	17.5	21.1	94.0						
YAV50F2M12		M12	44.5	3.0	17.5	21.1	100.3						
YAV50F2M14		M14	44.5	3.0	17.5	22.4	101.3						
YAV50F2M16		M16	44.5	3.0	17.5	22.4	106.7						
YAV70F2M6	70	M6	44.5	3.3	20.6	23.6	93.2	MY2911 (1) MRC840 (2) 644 Series (1) 444 Series (1) 81K Series (1)	W26RT (2) W26VT (2) X26RT (2)	W26RT (2) W26VT (2) X26RT (2)	U26RT (1)	13	22
YAV70F2M8		M8	44.5	3.3	20.6	23.6	95.0						
YAV70F2M10		M10	44.5	3.3	20.6	23.6	98.3						
YAV70F2M12		M12	44.5	3.3	20.6	23.6	104.6						
YAV70F2M14		M14	44.5	3.3	20.6	23.6	105.7						
YAV70F2M16		M16	44.5	3.3	20.6	23.6	111.0						
YAV95F2M8	95	M8	44.5	3.6	25.4	26.2	100.8	MY2911 (1) MRC840 (2) 644 Series (1) 444 Series (1) 81K Series (2)	W27VT (2) W27RT (2) X27RT (3)	W27VT (2) W27RT (2) X27RT (3)	U27RT (1)	14	27
YAV95F2M10		M10	44.5	3.6	25.4	26.2	104.1						
YAV95F2M12		M12	44.5	3.6	25.4	26.2	110.5						
YAV95F2M14		M14	44.5	3.6	25.4	26.2	111.5						
YAV95F2M16		M16	44.5	3.6	25.4	26.2	116.8						
YAV95F2M20		M20	44.5	3.6	25.4	26.2	128.0						
YAV120F2M8	120	M8	44.5	3.8	26.2	29.0	102.9	MY2911 (1) MRC840 (2) 644 Series (1) 444 Series (1) 81K Series (2)	W28VT (2) W28RT (2) X28RT (3)	W28VT (2) W28RT (2) X28RT (3)	U28RT (1)	15	27
YAV120F2M10		M10	44.5	3.8	26.2	29.0	106.2						
YAV120F2M12		M12	44.5	3.8	26.2	29.0	112.5						
YAV120F2M14		M14	44.5	3.8	26.2	29.0	113.5						
YAV120F2M16		M16	44.5	3.8	26.2	29.0	118.9						
YAV120F2M20		M20	44.5	3.8	26.2	29.0	130.0						
YAV150F2M8	150	M8	44.5	4.6	26.9	32.8	104.9	644 Series (1) 444 Series (1) 81K Series (2)	W30VT (2)	W30VT (2) W30RT (2)	U30RT (2)	17	29
YAV150F2M10		M10	44.5	4.6	26.9	32.8	108.2						
YAV150F2M12		M12	44.5	4.6	26.9	32.8	114.6						
YAV150F2M14		M14	44.5	4.6	26.9	32.8	115.6						
YAV150F2M16		M16	44.5	4.6	26.9	32.8	120.9						
YAV150F2M20		M20	44.5	4.6	26.9	32.8	132.1						
YAV185F2M8	185	M8	44.5	4.8	30.2	35.6	109.5	644 Series (1) 444 Series (1) 81K Series (2)	W31VT (2)	W31VT (2) W31RT (2)	U31RT (2)	18	29
YAV185F2M10		M10	44.5	4.8	30.2	35.6	112.8						
YAV185F2M12		M12	44.5	4.8	30.2	35.6	119.1						
YAV185F2M14		M14	44.5	4.8	30.2	35.6	120.1						
YAV185F2M16		M16	44.5	4.8	30.2	35.6	125.5						
YAV185F2M20		M20	44.5	4.8	30.2	35.6	136.7						

* Use equivalent AWG setting on tool for installation

** PUADP1 Adaptor is required to use U Dies in 46 Series

- P-RT dies for 46 Series Tooling only

Compression Connections

Copper Compression — Flex — Two Hole
Standard Barrel — Metric Lugs

TYPE YAV-F2M (Continued)

NOTE: Field bending straight lugs to achieve an angular connection will void UL Listing / CSA Certifications and BURNDY will not be liable for the connection.

Electro-Tin
Plated



Catalog Number	Wire Range (MM ²)	Stud Size	Stud Hole Spacing	Dimensions (mm)				Installation Tooling					Wire Strip Length (mm)
				Tongue Thickness	(B)	(C)	(L)	Dieless*	MD6, OUR840, MD734R	500 Series	35, 750, 46** Series	Die Index	
YAV240F2M10	240	M10	44.5	5.8	32.3	39.4	117.6	644 Series (1) 444 Series (1) 81K Series (2)	W34VT (2)	W34VT (2) W34RT (2)	U34RT (2)	20	33
YAV240F2M12		M12	44.5	5.8	32.3	39.4	123.9						
YAV240F2M14		M14	44.5	5.8	32.3	39.4	124.9						
YAV240F2M16		M16	44.5	5.8	32.3	39.4	130.3						
YAV240F2M20		M20	44.5	5.8	32.3	39.4	141.3						
YAV300F2M10	300	M10	44.5	6.9	36.8	46.7	124.9	644 Series (1) 444 Series (1) 81K Series (2)	—	—	U36RT (2)	22	38
YAV300F2M12		M12	44.5	6.9	36.8	46.7	131.3						
YAV300F2M14		M14	44.5	6.9	36.8	46.7	132.2						
YAV300F2M16		M16	44.5	6.9	36.8	46.7	137.7						
YAV300F2M20		M20	44.5	6.9	36.8	46.7	148.7						
YAV400F2M12	400	M12	44.5	7.6	36.1	50.3	131.8	644 Series (1) 444 Series (1) 81K Series (3)	—	—	U39RT (3)	24	37
YAV400F2M14		M14	44.5	7.6	36.1	50.3	138.2						
YAV400F2M16		M16	44.5	7.6	36.1	50.3	149.2						
YAV400F2M20		M20	44.5	7.6	36.1	50.3	149.2						
YAV500F2M12	500	M12	44.5	8.4	41.9	55.6	140.9	644 Series (1) 444 Series (1) 81K Series (3)	—	—	U44XRT (3) †P44XRT (3)	L115	43
YAV500F2M16		M16	44.5	8.4	41.9	55.6	147.3						
YAV500F2M20		M20	44.5	8.4	41.9	55.6	158.4						
YAV630F2M12	630	M12	44.5	9.9	50.8	68.3	154.9	—	—	—	† P46RT (3)	31	55
YAV630F2M16		M16	44.5	9.9	50.8	68.3	161.3						
YAV630F2M20		M20	44.5	9.9	50.8	68.3	172.4						

* Use equivalent AWG setting on tool for installation.

** PUADP1 Adaptor is required to use U Dies in 46 Series tools.

† P-RT Die sets for use in 46 Series only, PUADP1 Adaptor not required.

TYPE YALB-F2M

HYLUG™

Rated for 90° C, Up to 35 kV ◆

Made from electrolytic copper tube and is electro-tin plated. Wire range is from 50 mm² to 630 mm² Class 5. Compatible to **IEC61238-1**.

Features & Benefits

- No inspection window is ideal for more corrosive environments as the barrel transition is not open
- Barrel is designed with an internal chamfer at the wire entry to ensure smooth insertion of the wire, preventing possible damaging of the wire strands during installation
- Long barrel allows for an increased number of crimps which will increase the mechanical strength of the connection
- Two hole tongue/tang is recommended when space permits as the 2-hole feature minimizes the terminations from loosening or rotating under vibration, movement, or heat cycling
- Electro-tin plated unless specified to reduce galvanic corrosion (bimetallic) and resist corrosive elements
- Compatible Standards: IEC61238-1, UL 486A-486B, CSA-C22.2 No. 65-03
- Connectors are clearly marked with stamping

Accessories

- Hardware - Section F
- PENETROX™ Oxide Inhibitor - Section F
- Heat and Cold Shrink Tubing - Section D
- WIREMIKE™ Wire Micrometer - Section F
- Wire Management (Cable Ties) - Section G

Electro-Tin
Plated

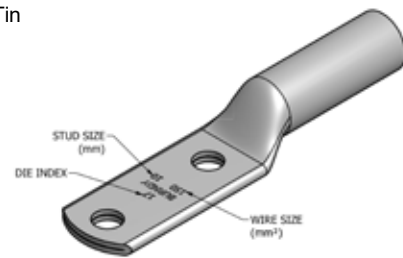

NOTE: Field bending straight lugs to achieve an angular connection will void UL Listing / CSA Certifications and BURNDY will not be liable for the connection.

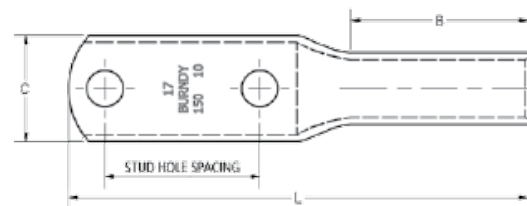

Compression Connections

Copper Compression — Flex — Two Hole
Long Barrel — Metric Lugs

TYPE YALB-F2M (Continued)

NOTE: Field bending straight lugs to achieve an angular connection will void UL Listing / CSA Certifications and BURNDY will not be liable for the connection.

Electro-Tin
Plated

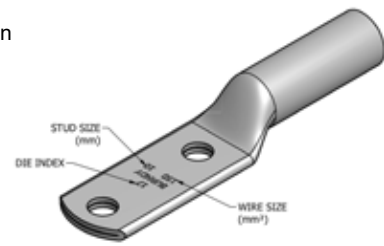

Catalog Number	Wire Range (MM²)	Stud Size	Stud Hole Spacing	Dimensions (mm)				Installation Tooling					Wire Strip Length (mm)
				Tongue Width	(B)	(C)	(L)	Dieless*	MD6, OUR840, MD734R	500 Series	35, 750, 46** Series	Die Index	
YALB50F2M6	50	M6	44.5	3.0	38.1	21.1	110.2	MY2911 (2) MRC840 (4) 644 Series (1) 444 Series (1) 81K Series (2)	W25VT (4) W25RT (4) X25RT (4)	W25VT (4) W25RT (4) X25RT (4)	U25RT (2)	12	40
YALB50F2M8		M8	44.5	3.0	38.1	21.1	112.0						
YALB50F2M10		M10	44.5	3.0	38.1	21.1	115.1						
YALB50F2M12		M12	44.5	3.0	38.1	21.1	121.4						
YALB50F2M14		M14	44.5	3.0	38.1	21.1	122.4						
YALB50F2M16		M16	44.5	3.0	38.1	21.1	131.1						
YALB70F2M6	70	M6	44.5	3.3	38.1	23.6	111.0	MY2911 (2) MRC840 (4) 644 Series (1) 444 Series (1) 81K Series (2)	W26VT (4) W26RT (4) X26RT (4)	W26VT (4) W26RT (4) X26RT (4)	U26RT (2)	13	40
YALB70F2M8		M8	44.5	3.3	38.1	23.6	113.3						
YALB70F2M10		M10	44.5	3.3	38.1	23.6	116.3						
YALB70F2M12		M12	44.5	3.3	38.1	23.6	122.7						
YALB70F2M14		M14	44.5	3.3	38.1	23.6	123.7						
YALB70F2M16		M16	44.5	3.3	38.1	23.6	129.0						
YALB95F2M8	95	M8	44.5	3.6	38.1	26.2	114.3	MY2911 (2) MRC840 (4) 644 Series (1) 444 Series (1) 81K Series (2)	W27VT (4) W27RT (4) X27RT (6)	W27VT (4) W27RT (4) X27RT (6)	U27RT (2)	14	43
YALB95F2M10		M10	44.5	3.6	38.1	26.2	117.6						
YALB95F2M12		M12	44.5	3.6	38.1	26.2	124.0						
YALB95F2M14		M14	44.5	3.6	38.1	26.2	125.0						
YALB95F2M16		M16	44.5	3.6	38.1	26.2	130.3						
YALB95F2M20		M20	44.5	3.6	38.1	26.2	141.2						
YALB120F2M8	120	M8	44.5	3.8	41.1	29.0	118.6	MY2911 (2) MRC840 (4) 644 Series (1) 444 Series (1) 81K Series (2)	W28VT (4) W28RT (4) X28RT (6)	W28VT (4) W28RT (4) X28RT (6)	U28RT (2)	15	43
YALB120F2M10		M10	44.5	3.8	41.1	29.0	124.2						
YALB120F2M12		M12	44.5	3.8	41.1	29.0	128.3						
YALB120F2M14		M14	44.5	3.8	41.1	29.0	129.3						
YALB120F2M16		M16	44.5	3.8	41.1	29.0	134.6						
YALB120F2M20		M20	44.5	4.3	41.1	30.5	145.8						
YALB150F2M8	150	M8	44.5	4.3	50.8	32.8	129.8	644 Series (1) 444 Series (1) 81K Series (3)	W30VT (4)	W30VT (4) W30RT (4)	U30RT (4)	17	52
YALB150F2M10		M10	44.5	4.3	50.8	32.8	133.1						
YALB150F2M12		M12	44.5	4.3	50.8	32.8	139.4						
YALB150F2M14		M14	44.5	4.3	50.8	32.8	140.0						
YALB150F2M16		M16	44.5	4.3	50.8	32.8	145.8						
YALB150F2M20		M20	44.5	4.3	50.8	32.8	157.0						

* Use equivalent AWG setting on tool for installation.

** PUADP1 Adaptor is required to use U Dies in 46 Series tools.

† P-RT Die sets for use in 46 Series only, PUADP1 Adaptor not required.

TYPE YALB-F2M (Continued)

NOTE: Field bending straight lugs to achieve an angular connection will void UL Listing / CSA Certifications and BURNDY will not be liable for the connection.

Electro-Tin
Plated

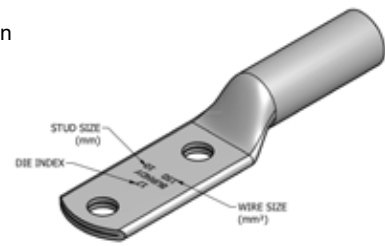

Catalog Number	Wire Range (MM²)	Stud Size	Stud Hole Spacing	Dimensions (mm)				Installation Tooling					Wire Strip Length (mm)
				Tongue Thickness	(B)	(C)	(L)	Dieless*	MD6, OUR840, MD734R	500 Series	35, 750, 46** Series	Die Index	
YALB185F2M8	185	M8	44.5	4.8	53.8	35.6	134.1	644 Series (1) 444 Series (1) 81K Series (3)	W31VT (4)	W31VT (4) W31RT (4)	U31RT (4)	18	52
YALB185F2M10		M10	44.5	4.8	53.8	35.6	137.4						
YALB185F2M12		M12	44.5	4.8	53.8	35.6	143.8						
YALB185F2M14		M14	44.5	4.8	53.8	35.6	144.8						
YALB185F2M16		M16	44.5	4.8	53.8	35.6	150.1						
YALB185F2M20		M20	44.5	4.8	53.8	35.6	161.3						
YALB240F2M10	240	M10	44.5	5.6	57.2	39.4	142.7	644 Series (1) 444 Series (1) 81K Series (4)	W34VT (4)	W34VT (4) W34RT (4)	U34RT (4)	20	59
YALB240F2M12		M12	44.5	5.6	57.2	39.4	149.9						
YALB240F2M14		M14	44.5	5.6	57.2	39.4	150.9						
YALB240F2M16		M16	44.5	5.6	57.2	39.4	156.2						
YALB240F2M20		M20	44.5	5.6	57.2	39.4	167.1						
YALB300F2M10	300	M10	44.5	6.9	71.4	46.7	160.8	644 Series (1) 444 Series (1) 81K Series (4)	—	—	U36RT (4)	22	73
YALB300F2M12		M12	44.5	6.9	71.4	46.7	167.1						
YALB300F2M14		M14	44.5	6.9	71.4	46.7	168.1						
YALB300F2M16		M16	44.5	6.9	71.4	46.7	173.5						
YALB300F2M20		M20	44.5	6.9	71.4	46.7	184.7						
YALB400F2M12	400	M12	44.5	7.6	74.7	50.3	171.7	—	—	—	U39RT (4)	24	76
YALB400F2M14		M14	44.5	7.6	74.7	50.3	172.7						
YALB400F2M16		M16	44.5	7.6	74.7	50.3	178.1						
YALB400F2M20		M20	44.5	7.6	74.7	50.3	189.2						
YALB500F2M12	500	M12	44.5	8.1	76.2	55.6	176.8	—	—	—	U44XRT (4) †P44XRT (4)	L115	78
YALB500F2M16		M16	44.5	8.1	76.2	55.6	183.1						
YALB500F2M20		M20	44.5	8.1	76.2	55.6	194.1						
YALB630F2M12	630	M12	44.5	9.9	81.0	68.3	186.9	—	—	—	† P46RT (6)	31	83
YALB630F2M16		M16	44.5	9.9	81.0	68.3	193.3						
YALB630F2M20		M20	44.5	9.9	81.0	68.3	204.5						

* Use equivalent AWG setting on tool for installation

** PUADP1 Adaptor is required to use U Dies in 46 Series

- P-RT dies for 46 Series Tooling only

Compression Connections

Copper Compression
HYPLUG™ Adapters for Copper Conductor

TYPES YE-P, YE-P-FX

HYPLUG™



Wire Connector Adapter Rated for 90° C, Up to 35 kV ♦

Type YE-P copper compression adapters are designed for reliable termination of copper conductor when the current capacity of the conductor is downsized, but larger conductor is utilized. Typical applications are for voltage drop protection when oversized conductors are used or flex conductor is used. These adapters facilitate the termination into existing mechanical set screw connectors for various stranded copper cables.

♦ For applications greater than 2000 Volts consult cable manufacturer for voltage stress relief instructions.

NOTE: Field bending straight lugs to achieve an angular connection will void UL Listing / CSA Certifications and BURNDY will not be liable for the connection.



600 Volts, 90°C EPDM or Santoprene rubber covers supplied with the connector

Features & Benefits

- Connectors are cULus Listed wire adapters per UL 486A-486B where symbol shown on the page
- The adapters are used in voltage drop applications
- Designed with a compression barrel that accommodate the wire and a solid pin that is used to insert and terminate in a mechanical set screw connector
- Solid pin design is rated to carry the equivalent ampacity of the incoming wire being terminated, solid pin design is more effective than stranded conductor as there is no risk of damaging strands during termination in the mechanical set screw connector
- Covers are supplied with connectors
 - EPDM rubber covers are UL Listed/CSA Certified and rated up to 600 Volts and 90° C
 - Santoprene rubber covers are also UL Listed/CSA Certified and rated up to 600 Volts and 90° C
- Connectors are clearly marked

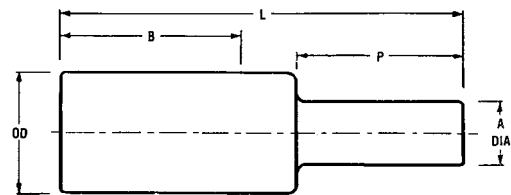

Accessories

- Hardware - Section F
- PENETROX™ Oxide Inhibitor - Section F
- Heat and Cold Shrink Tubing - Section D
- WIREMIKE™ Wire Micrometer - Section F
- Wire Management (Cable Ties) - Section G

TYPES YE-P, YE-P-FX (Continued)



WIRE
CONNECTOR
ADAPTER



Note: up to 600 Volts, 90°C EPDM or Santoprene rubber covers supplied with the connector

Catalog Number	Accommodates Copper Wire Sizes			Pin Size Equiv.	Dimensions					Color Code	Die Index	Installation Data								Cable Strip Length
	Flex Cable	Code AWG	Navy		A Dia	B	L	P	OD			Mech Tools (# of Crimps)				Hydraulic Tools (# of Crimps)				
												MY 2911	Y1 / Y2MR	MD734R	MD6 / MD7	35, 750 Series	46 Ⓢ Series	60 Ton Series	644, 444 Series	
YE44CP20X75FX	#4 Str. 91/24-105/24)	#4	40	#4 AWG	0.20	1.37	2.27	0.75	0.38	Gray	8	(2)	W4CVT (2)	W4CRT (2)	U4CRT (2)	—	(1)	1-1/2		
YE22CP26X75FX	#2 Str. (125/24-150/24)	#2	60	#2 AWG	0.26	1.65	2.60	0.75	0.46	Brown	10		W2CVT (2)	W2CRT (2)	U2CRT (2)			1-3/4		
YE11CP29X75FX	#1 Str. (175/24-225/24)	#1	75	#1 AWG	0.29	1.66	2.63	0.75	0.51	Green	11	(1)	W1CVT (2)	W1CRT1 (2)	U1CRT1 (2)	—	(1)	1-3/4		
YE25P33X75FX	1/0 Str. (275/24)	1/0	100	1/0 AWG	0.33	1.80	2.80	0.75	0.56	Pink	12		W25VT (4)	W25RT (4)	U25RT (2)			1-7/8		
YE26P37X75FX	2/0 Str. (325/24)	2/0	125	2/0 AWG	0.37	1.82	2.86	0.75	0.63	Black	13	—	W26VT (4)	W26RT (4)	U26RT (2)	—	(1)	1-7/8		
YE27P41X82FX	3/0 Str. (450/24)	3/0	150	3/0 AWG	0.41	1.97	3.11	0.82	0.70	Orange	14		W27VT (4)	W27RT (4)	U27RT (2)			2-1/16		
YE28P46X92FX	4/0 Str. (550/24)	4/0	200	4/0 AWG	0.46	1.99	3.28	0.92	0.77	Purple	15	—	W28VT (4)	W28RT (4)	U28RT (2)	—	(1)	2-1/16		

FLEX CABLE ONLY		Pin Size Equiv.	A Dia	B	L	P	OD	Color Code	Die Index	(1)	—	—	W29VT (4)	W29RT (4)	U29RT (2)	L29RT (1)	(1)	2-3/8
YE30P50X100FX	250 kcmil Flex Class G 259 Class H 427																	
YE31P51X102FX	262.6 kcmil Flex (650/24) 250 Flex Class I, K, M	262.6 kcmil	0.51	2.39	3.82	1.02	0.88	White	17	—	—	W31VT (4)	W31RT (4)	U31RT (4)	L31RT (1)	(1)	2-5/8	
YE32P55X110FX	313.1 kcmil (775/24) (300 kcmil Nom)	300 kcmil	0.55	2.53	4.08	1.10	0.95	Red	18								W32VT (4)	W32RT (4)
YE34P59X118FX	373.7 kcmil (925/24) (350 kcmil Nom)	350 kcmil	0.59	2.68	4.36	1.18	1.06	Blue	19	—	—	—	—	U34RT (4)	L34RT (2)	(1)	3-1/4	
YE36P67X134FX	444.4 kcmil (1100/24) (450 kcmil Nom)	450 kcmil	0.67	3.14	5.04	1.34	1.19	Brown	20								U38XRT (4)	—
YE38P71X142FX	535.3 kcmil (1325/24) (500 kcmil Nom)	500 kcmil	0.71	3.29	5.30	1.42	1.25	Pink	L99	—	—	—	—	U39RT (4)	L39RT (2)	(1)	3-7/16	
YE40P78X156FX	646 kcmil (1600/24) (600 kcmil Nom)	600 kcmil	0.78	3.31	5.51	1.56	1.35	Black	24								U44XRT (4)	—
YE44P87X174FX	777.7 kcmil (1925/24) (750 kcmil Nom)	750 kcmil	0.87	3.54	5.99	1.74	1.50	Yellow	L115	—	—	—	—	—	—	—	—	

CODE CABLE ONLY		AWG	Pin Size Equiv.	A Dia	B	L	P	OD	Color Code	Die Index	(1)	—	—	W29VT (4)	W29RT (4)	U29RT (2)	—	(1)	2-1/2
YE29P50X100	250 kcmil	250																	
YE30P55X110	300 kcmil	300	300 kcmil	0.55	2.37	3.85	1.10	0.81	White	17	—	—	W31VT (4)	W31RT (4)	U31RT (4)	L31RT (1)	(1)	2-3/4	
YE31P59X118	350 kcmil	350	350 kcmil	0.59	2.39	3.98	1.18	0.88	Red	18	—	—	W32VT (4)	W32RT (4)	U32RT (4)	L32RT (1)		3-1/4	
YE32P63X126	400 kcmil	400	400 kcmil	0.63	2.53	4.24	1.26	0.95	Blue	19	—	—	W34VT (4)	W34RT (4)	U34RT (4)	L34RT (2)	(1)	3-3/8	
YE34P71X142	500 kcmil	—	500 kcmil	0.71	2.68	4.60	1.42	1.06	Brown	20	—	—	—	—	U36RT (4)	L36RT (2)		1-3/4	
YE36P78X156	600 kcmil	—	600 kcmil	0.78	3.14	3.78	1.56	1.19	Green	22	—	—	—	—	U39RT (4)	P39RT (4)	L39RT (2)	3-5/8	
YE39P87X174	750 kcmil	—	750 kcmil	0.87	3.37	5.73	1.74	1.30	Black	24	—	—	—	—	—	—	—	—	

Compression Connections

Copper Compression
HYPLUG™ Adapters for Copper Conductor

TYPES YE-P, YE-P-FX (Continued)

Note: up to 600 Volts, 90°C EPDM or Santoprene rubber covers supplied with the connector
Connectors on this page are NOT cULus Listed



Catalog Number	Accommodates Copper Wire Sizes			Pin Size Equiv.	Dimensions					Installation Data										
	Flex Cable	Code AWG	Navy		A Dia	B	L	P	OD	Color Code	Die Index	Mech Tools (# of Crimps)				Hydraulic Tools (# of Crimps)				Cable Strip Length
												MY 2911	Y1 / Y2MR	MD734R	MD6 / MD7	35, 750 Series	46 Series	60 Ton Series	644, 444 Series	

YE2CP23X75FX	#2 Str. (125/24-150/24)	#2	60	3 AWG	0.23	1.65	2.60	0.75	0.46	Brown	10	(1)	(4)	W2CVT (2)	W2CRT (2)	U2CRT (2)	-	(1)	1-3/4
YE1CP26X75FX	#1 Str. (175/24-225/24)	#1	75	2 AWG	0.26	1.66	2.63	0.75	0.51	Green	11			W1CVT (2)	W1CRT1 (2)	U1CRT1 (2)			1-3/4
YE25P29X75FX	1/0 Str. (275/24)	1/0	100	1 AWG	0.29	1.80	2.80	0.75	0.56	Pink	12			W25VT (4)	W25RT (4)	U25RT (2)			1-7/8
YE26P33X75FX	2/0 Str. (325/24)	2/0	125	1/0 AWG	0.33	1.82	2.86	0.75	0.63	Black	13			W26VT (4)	W26RT (4)	U26RT (2)			1-7/8
YE27P37X75FX	3/0 Str. (450/24)	3/0	150	2/0 AWG	0.37	1.97	3.04	0.75	0.70	Orange	14			W27VT (4)	W27RT (4)	U27RT (2)			2-1/16
YE28P41X75FX	4/0 Str. (550/24)	4/0	200	3/0 AWG	0.41	1.99	3.11	0.75	0.77	Purple	15			W28VT (4)	W28RT (4)	U28RT (2)			2-1/16

FLEX CABLE ONLY

YE30P46X92FX	250 kcmil Flex Class G 259 Class H 427	—	—	4/0 AWG	0.46	2.37	3.67	0.92	0.81	Yellow	16			W29VT (4)	W29RT (4)	U29RT (2)	L29RT (1)	(1)	2-3/8
YE32P51X102FX	313.1 kcmil (775/24)(300 kcmil Nom)	—	—	250 kcmil	0.51	2.53	4.00	1.02	0.95	Red	18			W31VT (8)	W31RT (8)	U31RT (4)	L31RT (1)		2-5/8
YE34P55X110FX	373.7 kcmil (925/24)(350 kcmil Nom)	—	—	300 kcmil	0.55	2.68	4.28	1.10	1.06	Blue	19			W32VT (8)	W32RT (8)	U32RT (4)	L32RT (1)		2-3/4
YE36P59X118FX	444.4 kcmil (1100/24)(450 kcmil Nom)	—	—	350 kcmil	0.59	3.14	4.88	1.18	1.19	Brown	20			W34VT (8)	W34RT (8)	U34RT (4)	L34RT (2)		3-1/4
YE38P67X134FX	535.3 kcmil (1325/24)(500 kcmil Nom)	—	—	450 kcmil	0.67	3.29	5.22	1.34	1.25	Pink	L99			—	—	U38XRT (4)	—		3-3/8
YE40P71X142FX	646 kcmil (1600/24)(600 kcmil Nom)	—	—	500 kcmil	0.71	3.31	5.37	1.42	1.35	Black	24			—	—	U39RT (4)	L39RT (2)		3-7/16
YE44P78X156FX	777.7 kcmil (1925/24)(750 kcmil Nom)	—	—	600 kcmil	0.78	3.54	5.81	1.56	1.50	Yellow	L115			—	—	U44XRT (4)	—		3-5/8

CODE CABLE ONLY AWG

YE29P46X92	250 kcmil	—	250	4/0 kcmil	0.46	1.99	3.25	0.92	0.75	Yellow	16	(1)	—	W29VT (4)	W29RT (4)	U29RT (2)	—	(1)	2-1/2
YE30P50X100	300 kcmil	—	300	250 kcmil	0.50	2.37	3.75	1.00	0.81	White	17			W30VT (8)	W30RT (8)	U30RT (4)	L30RT (1)		2-5/8
YE31P55X110	350 kcmil	—	350	300 kcmil	0.55	2.39	3.90	1.10	0.88	Red	18			W31VT (8)	W31RT (8)	U31RT (4)	L31RT (1)		2-3/4
YE32P59X118	400 kcmil	—	400	350 kcmil	0.59	2.53	4.16	1.18	0.95	Blue	19			W32VT (8)	W32RT (8)	U32RT (4)	L32RT (1)		3-1/4
YE34P63X126	500 kcmil	—	—	400 kcmil	0.63	2.68	4.44	1.26	1.06	Brown	20			W34VT (8)	W34RT (8)	U34RT (4)	L34RT (2)		3-3/8
YE36P71X142	600 kcmil	—	—	500 kcmil	0.71	3.14	5.11	1.42	1.19	Green	22			—	—	U36RT (4)	L36RT (2)		3-7/16
YE39P78X156	750 kcmil	—	—	600 kcmil	0.78	3.37	5.55	1.56	1.30	Black	24			—	—	U39RT (4)	P39RT (4)		L39RT (2)

1. For sizes above 4/0 the MD66R2 must be used.
© See Sales Drawings for Metric Conductor Ratings.

© To use U dies in 46 Series tools, PUADP1 die adapter is required.
Note: All dimensions shown are for reference only.

TYPES YE-P, YE-P-FX (Continued)

Note: up to 600 Volts, 90°C EPDM or Santoprene rubber covers supplied with the connector
Connectors on this page are NOT cULus Listed



REDUCED PIN DIAMETER

Catalog Number	Accommodates Copper Wire Sizes			Pin Size Equiv.	Dimensions					Color Code	Die Index	Installation Data								
	Flex Cable	Code AWG	Navy		A Dia	B	L	P	OD			Mech Tools (# of Crimps)				Hydraulic Tools (# of Crimps)				Cable Strip Length
												MY 2911	Y1/Y2MR	MD734R	MD6/MD7	35, 750 Series	46 Ⓢ Series	60 Ton Series	644, 444 Series	
YEY4CP16X75FX	#4 Str. (91/24-105/24)	#4	40	6 AWG	0.16	1.37	2.27	0.75	0.38	Gray	8	(1)	(2)	W4CVT (2)	W4CRT (2)	U4CRT (2)	—	(1)	1-1/2	
YEV2CP20X75FX	#2 Str. (125/24-150/24)	#2	60	4 AWG	0.20	1.65	2.60	0.75	0.46	Brown	10			W2CVT (2)	W2CRT (2)	U2CRT (2)	—		1-3/4	
YEV1CP23X75FX	#1 Str. (175/24-225/24)	#1	75	3 AWG	0.23	1.66	2.63	0.75	0.51	Green	11			W1CVT (2)	W1CRT1 (2)	U1CRT1 (2)	—		1-3/4	
YEV25P26X75FX	1/0 Str. (275/24)	1/0	100	2 AWG	0.26	1.80	2.80	0.75	0.56	Pink	12			W25VT (4)	W25RT (4)	U25RT (2)	—		1-7/8	
YEV26P29X75FX	2/0 Str. (325/24)	2/0	125	1 AWG	0.29	1.82	2.86	0.75	0.63	Black	13			W26VT (4)	W26RT (4)	U26RT (2)	—		1-7/8	
YEV27P33X75FX	3/0 Str. (450/24)	3/0	150	1/0 AWG	0.33	1.97	3.04	0.75	0.70	Orange	14			W27VT (4)	W27RT (4)	U27RT (2)	—		2-1/16	
YEV28P37X75FX	4/0 Str. (550/24)	4/0	200	2/0 AWG	0.37	1.99	3.11	0.75	0.77	Purple	15			W28VT (4)	W28RT (4)	U28RT (2)	—		2-1/16	

FLEX CABLE ONLY																		
YE31P41X82FX	262.6 kcmil (650/24) 250 Flex Class I, K, M	—	3/0 AWG	0.41	2.39	3.62	0.82	0.88	White	17	—	—	W30VT (8)	W30RT (8)	U30RT (4)	L30RT (1)	(1)	2-1/2
YE34P51X102FX	373.7 kcmil (925/24) (350 kcmil Nom)	—	250 kcmil	0.51	2.68	4.20	1.02	1.06	Blue	19			W32VT (8)	W32RT (8)	U32RT (4)	L32RT (1)		2-3/4
YE38P59X118FX	535.3 kcmil (1325/24) (500 kcmil Nom)	—	350 kcmil	0.59	3.29	5.06	1.18	1.25	Pink	L99			—	—	U38XRT (4)	—		3-3/8
YE40P67X134FX	646 kcmil (1600/24) (600 kcmil Nom)	—	450 kcmil	0.67	3.31	5.29	1.34	1.35	Black	24			—	—	U39RT (4)	L39RT (2)		3-7/16

CODE CABLE ONLY																		
YE29P31X109	250 kcmil	—	1 AWG	0.31	1.06	2.49	1.09	0.75	Yellow	16	(1)	—	—	W29RT (4)	U29RT (2)	L29RT (2)	—	1-1/8
YE29P41X82	250 kcmil	—	3/0 AWG	0.41	1.99	3.15	0.82	0.75	Yellow	16			W29VT (4)	W29RT (4)	U29RT (2)	—	2-1/2	
YE30P46X92	300 kcmil	—	4/0 AWG	0.46	2.37	3.67	0.92	0.81	White	17			W30VT (8)	W30RT (8)	U30RT (4)	L30RT (1)	2-5/8	
YE31P50X100	350 kcmil	—	250 kcmil	0.50	2.39	3.80	1.00	0.88	Red	18			W31VT (8)	W31RT (8)	U31RT (4)	L31RT (1)	2-3/4	
YE32P55X110	400 kcmil	—	300 kcmil	0.55	2.53	4.08	1.10	0.95	Blue	19			W32VT (8)	W32RT (8)	U32RT (4)	L32RT (1)	3-1/4	
YE34P59X118	500 kcmil	—	350 kcmil	0.59	2.68	4.36	1.18	1.06	Brown	20			W34VT (8)	W34RT (8)	U34RT (4)	L34RT (2)	3-3/8	
YE36P63X126	600 kcmil	—	400 kcmil	0.63	3.14	4.95	1.26	1.19	Green	22			—	—	U36RT (4)	L36RT (2)	3-7/16	
YE39P71X142	750 kcmil	—	500 kcmil	0.71	3.37	5.41	1.42	1.30	Black	24			—	—	U39RT (4)	P39RT (4)	L39RT (2)	3-5/8

1. For sizes above 4/0 the MD66R2 must be used.
 Ⓢ See Sales Drawings for Metric Conductor Ratings.
 Ⓢ To use U dies in 46 Series tools, PUADP1 die adapter is required.
Note: All dimensions shown are for reference only.

TYPE ASA-U

HYSTACK™ Terminal Stacking Adapter

UL Listed 90° C, Up to 35 kV ♦

The Hystack™ adapter is specially designed to allow standard terminals to be stacked on two or four hole NEMA transformer or equipment terminal pads. Hystack™ adapters are tin-plated, high conductivity aluminum to provide optimum corrosion resistance. Only three sizes accommodate terminals from 250 kcmil through 1000 kcmil to help keep costly inventories to a minimum.

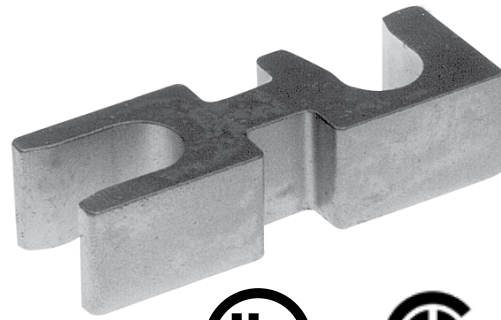

Features & Benefits

- For use on terminals made from copper or aluminum material
- Designed specifically for stacking standard terminals; uses include:
 - Place the stacking adapter on the mounting plate and a terminal on top of the stacking adapter and bolt down
 - Placing a stacking adapter on a terminal pad that will be mounted to a bus bar or mounting plate and a terminal on top of the stacking adapter, and bolt down
- May be used with standard NEMA two and four hole terminals; to stack four hole NEMA terminations use two stacking adapters assembled side-by-side
- Only three sizes necessary to accommodate terminals from 250 kcmil through 1000 kcmil, minimizing inventory requirements
- Stacking adapters are clearly marked

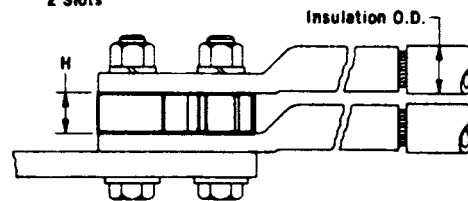
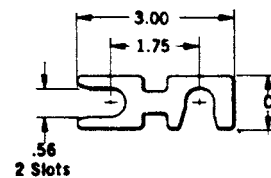

Accessories

- Hardware - Section F
- PENETROX™ Oxide Inhibitor - Section F
- Heat and Cold Shrink Tubing - Section D
- WIREMIKE™ Wire Micrometer - Section F
- Wire Management (Cable Ties) - Section G

Accommodates Copper and Aluminum Compression Terminals		Catalog Number	C	H
Conductor Max.	Insulation O.D.			
250 kcmil	0.87	ASA250U	1.00	0.77
800 kcmil	1.37	ASA800U	1.00	1.13
1000 kcmil	1.49	ASA1000U	1.25	1.25

To stack 4 hole NEMA drilled terminals use 2 adaptors assembled side by side. ASA-U stacking adaptors are recommended for use with any BURNDY® UL Listed compression terminal, 2 or 4 hole NEMA pad aluminum and copper lugs, types YA, YA-L, YA-A, and for all 2-hole NEMA spaced lugs in the OVERHEAD and UNDERGROUND catalog sections.

Note: All dimensions shown are for reference only.

TYPE CUSA

HYSTACK™ Terminal Stacking Adapter

The Hystack™ adapter is specially designed to get terminals to the back end of a bus bar or other areas that require terminals to be elevated off the mounting surface. These Hystack™ adapters are made from high conductivity copper and tin-plated to provide optimum corrosion resistance. It will accommodate #10 AWG through 750 kcmil HYLUG™ terminals.

Features & Benefits

- For use on terminals made from copper
- Designed specifically for stacking standard terminals; uses include:
 - Place the stacking adapter on the mounting plate and a terminal on top of the stacking adapter and bolt down
 - Placing a stacking adapter on a terminal pad that will be mounted to a bus bar or mounting plate and a terminal on top of the stacking adapter, and bolt down
- May be used with standard NEMA two and four hole terminals; to stack four hole NEMA terminations use two stacking adapters assembled side-by-side
- Stacking adapters are clearly marked

Accessories

- Hardware - Section F
- PENETROX™ Oxide Inhibitor - Section F
- Heat and Cold Shrink Tubing - Section D
- WIREMIKE™ Wire Micrometer - Section F
- Wire Management (Cable Ties) - Section G

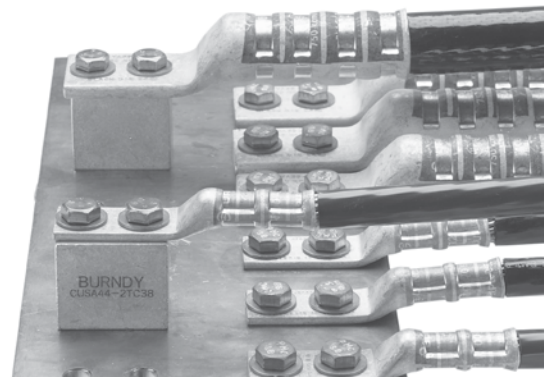

Catalog Number	Stud Hole Size	Stud Hole Spacing	Length	Width	Height
CUSA442TC38	3/8"	1"	1.75"	1.12"	1.50"
CUSA442NTC	1/2"	1-3/4"	3.00"	1.12"	1.50"

Note: All dimensions shown are for reference only.

Reference: Catalog Number TMH332.

This TMH332 Kit has just the right hardware when using the CUSA442TC38 Hystack on a 1/4 bus bar with a 4/0 through 750 kcmil HYLUG™.

TYPE YSCM

Color-Coded HYLINK™ Uninsulated Parallel Splice

Type YSCM HYLINK™ seamless parallel splice connectors permit stranded wires to be laid parallel inside the connector and spliced together with BURNDY® compression tools. Each YSCM style splice accommodates a wide range of conductors and is color-coded to ensure proper tool and die match. Type YSCM connectors are cULus Listed Wire Connectors per UL 486A/B for Grounding and Bonding, and UL 467 rated for Direct Burial in earth and concrete.



Features & Benefits

- Copper seamless barrel uninsulated parallel splice
- Designed to accommodate a wide range of stranded wires to be laid parallel inside the barrel and spliced together
- Barrel is designed with an internal chamfer at the wire entry to ensure smooth insertion of the wire, preventing possible damaging of the wire strands during insertion
- Electro-tin plated unless otherwise specified to reduce galvanic corrosion (bimetallic) and resist corrosive elements
- Barrel is color coded to ensure proper die and installation tooling is selected
- Type YSCM Uninsulated Parallel Splices are cULus Listed Wire Connectors per UL 486A-486B for Grounding and Bonding
- UL 467 Rated for Direct Burial in earth and concrete
- BURNDY certifies its products using the BURNDY Engineered System and select other crimp tool manufacturers in accordance with one or more of the UL categories in order to obtain a UL Listing
- Terminals and splices accommodating code wire: Accommodates Code Class B (Concentric, Compressed, Compact) and Class C wire

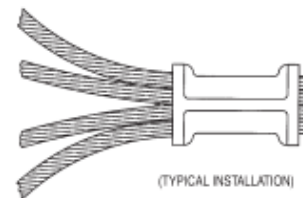
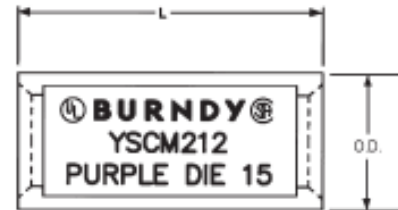

Accessories

- Hardware - Section F
- PENETROX™ Oxide Inhibitor - Section F
- Heat and Cold Shrink Tubing - Section D
- WIREMIKE™ Wire Micrometer - Section F
- Wire Management (Cable Ties) - Section G

TYPE YSCM (Continued)



Catalog Number	Conductor Range Cable Circular Mils	Dimensions Inches [mm]		Color Code	Die Index	Recommended Installation Tooling		Wire Strip Length
		L ±.03	O.D. ±.01			OUR840, 500, 600 Series	35, 750 Series	
YSCM17	13,060 - 16,910	0.50 [13]	0.27 [7]	Red	49	X8CRT, W8CRT	U8CRT	11/16
YSCM27	16,910 - 26,890	0.50 [13]	0.31 [8]	Blue	7	X5CRT, W5CRT	U5CRT	11/16
YSCM42	29,970 - 41,520	0.50 [13]	0.38 [10]	Gray	8	X4CRT, W4CRT	U4CRT	11/16
YSCM66	42,750 - 66,040	0.62 [16]	0.47 [12]	Brown	10	X2CRT, W2CRT	U2CRT	3/4
YSCM80	67,980 - 80,020	0.62 [16]	0.52 [13]	Green	11	X1CRT, W1CRT-1	U1CRT-1	3/4
YSCM104	82,870 - 103,630	0.69 [18]	0.57 [14]	Pink	12	X25RT, W25RT	U25RT	15/16
YSCM133	104,960 - 133,220	0.81 [21]	0.64 [16]	Black	13	X26RT, W26RT	U26RT	1-1/16
YSCM167	134,340 - 166,560	0.81 [21]	0.70 [18]	Orange	14	X27RT, W27RT	U27RT	1-1/16
YSCM212	167,380 - 211,820	0.88 [22]	0.78 [20]	Purple	15	X28RT, W28RT	U28RT	1-1/16
YSCM231	- 230,800	1.05 [27]	0.81 [21]	Yellow	16	X29RT, W29RT	U29RT	1-1/16

Notes:

1. Material: Copper per ASTM B75.
 2. Finish: Tin plated. For nickel plating, add suffix "NK" to the Catalog Number.
- † Recommended strip length. Strip length dependant on size, no. of wires and insulation thickness.
- ‡ Refer to Circular Mil Table per ASTM B8 for total Class B Circular Mil calculations.
- * YSCM231 can also be installed with MY293 and retain Listings.

Add the circular mils of the wires you wish to splice; that sum would be used to determine the correct splice using the Min/Max on the table above.

The table to the right is for reference only.

Circular Mil Table per ASTM B8			
Size		ASTM Strandings	
Circular Mils	AWG	Class	Cable Diameter (in)
1,022	20	B	0.036
1,624	18	B	0.045
2,583	16	B	0.057
4,107	14	B	0.072
6,530	12	B	0.091
10,380	10	B	0.116
13,090	9	B	0.130
16,510	8	B	0.146
20,820	7	B	0.164
26,250	6	B	0.184
33,100	5	B	0.206
41,740	4	AA	0.254
41,740	4	B&A	0.232
52,630	3	AA	0.285
52,630	3	B&A	0.260
66,370	2	AA	0.320
66,370	2	B&A	0.292
83,690	1	AA	0.360
83,690	1	A	0.328
83,690	1	B	0.332
105,500	1/0	A&A	0.368
105,500	1/0	—	0.390
105,500	1/0	B	0.373
133,100	2/0	A&A	0.414
133,100	2/0	—	0.438
133,100	2/0	B	0.419
167,800	3/0	A&A	0.464
167,800	3/0	—	0.492
167,800	3/0	B	0.470
211,600	4/0	A&A	0.522
211,600	4/0	—	0.522
211,600	4/0	B	0.528

TYPE YS-L

HYLINK™ Splice



UL Listed 90° C, Up to 35 kV ◆

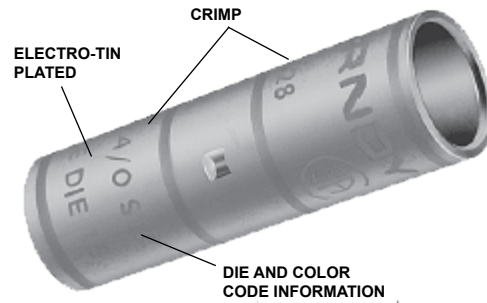

Features & Benefits

- Copper seamless barrel has center stop indentations used to indicate when wire is fully inserted into each side of the barrel
- Barrel is designed with an internal chamfer at the wire entry to ensure smooth insertion of the wire, preventing possible damaging of the wire strands during insertion
- Electro-tin plated unless otherwise specified to reduce galvanic corrosion (bimetallic) and resist corrosive elements
- Short/standard length barrel is recommended for installation with limited space requirements
- Connectors clearly marked with color coding
- BURNDY certifies its products using the BURNDY Engineered System and select other crimp tool manufacturers in accordance with one or more of the UL categories in order to obtain a UL Listing
- Terminals and splices accommodating code wire: Accommodates Code Class B (Concentric, Compressed, Compact) and Class C wire

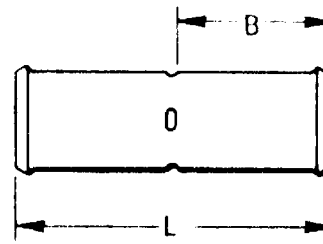

Catalog Number	Conductor		Dimensions		Dieless (# of crimps)	Installation Tooling ▲					Wire Strip Length		
	AWG	*** MM ²	L	B		Mechanical			35 ■, 750, 46* Series			▲ Die Index & Embossment	
						Y1MRTC Y2MR	MD734R	MD6 OUR840	Die Number (# crimps)	Color Code			
YS8CLBOX	8 Str.	10	1.00	0.44	81K Series (1)	Y1MRTC (1)	W8CVT (1)	X8CRT (1)	U8CRT (1)	Red	49	1/2"	
YS6CLBOX	6 Str.	—	1.75	0.81			W5CVT (1)	X5CRT (1)	U5CRT (1)	Blue	7 or 374	7/8"	
YS5CLBOX	5 Str.	16	1.90	0.81		Y1MRTC (2)	W4CVT (1)	X4CRT (1)	U4CRT (1)	Gray	8 or 346	7/8"	
YS4CLBOX	4 Str.	—	1.75	0.81			—	—	U3CRT (1)	White	9	15/16"	
YS3CL	3 Str./ 2 Sol.	25	2.05	0.88			W2CVT (1)	X2CRT (1)	U2CRT (1)	Brown	10	15/16"	
YS2CLBOX	2 Str.	—	2.00	0.88			W1CVT (1)	X1CRT (1)	U1CRT1 (1)	Green	11 or 375	15/16"	
YS1CLBOX	1 Str.	50	2.06	0.88		81K Series (2)	—	W25VT (2)	X25RT (2)	U25RT (1)	Pink	12 or 348	15/16"
YS25LBOX	1/0 Str.	—	2.08	0.88				W26VT (2)	X26RT (2)	U26RT (1)	Black	13	1"
YS26LBOX	2/0 Str.	70	2.17	0.94				W27VT (2)	X27RT (2)	U27RT (1)	Orange	14	1-1/16"
YS27LBOX	3/0 Str.	95	2.30	1.00				W28VT (2)	X28RT (2)	U28RT (1)	Purple	15	1-1/16"
YS28LBOX	4/0 Str.	—	2.32	1.00	W29VT (2)			—	U29RT (1)	Yellow	16	1-1/8"	
YS29LBOX	250 kcmil	120	2.46	1.06	W30VT (2)			—	U30RT (2)	White	17 or 298	1-1/8"	
YS30L	300 kcmil	150	2.47	1.06	W31VT (2)			—	U31RT (2)	Red	18 or 324	1-3/16"	
YS31L	350 kcmil	185	2.60	1.12	W32VT (2)			—	U32RT (2)	Blue	19 or 470	1-1/4"	
YS32L	400 kcmil	—	2.74	1.19	W34VT (2)			—	U34RT (2)	Brown	20 or 299	1-7/16"	
YS34L	500 kcmil	240	3.15	1.38	81K Series (3)			—	U36RT (2)	Green	22 or 472	1-7/16"	
YS36L	600 kcmil	300	3.22	1.38		U38RT (2)	Pink		400	1-7/16"			
YS38L	700 kcmil	—	3.22	1.38		U39RT (2)	Black		24	1-11/16"			
YS39L	750 kcmil	—	3.72	1.62		P44RT (2)**	White		27	1-15/16"			
YS44L	1000 kcmil	500	4.28	1.88									

▲ See tooling section of this catalog for complete tool and die listings.

* Use PUADP1 adaptor with U dies in 46 Series.

** P44RT for use with 46 Series only. PUADP1 adaptor not required.

*** The MM² conductor sizes listed are the recommendations for Class 2 conductor.

■ The maximum size for the Y35 is 400 kcmil insulated code cable.

◆ For applications greater than 2000 Volts consult cable manufacturer for voltage stress relief instructions.

Note: All dimensions shown are for reference only.

TYPE YS

HYLINK™ Splice, Long Barrel

UL Listed 90° C, Up to 35 kV ♦



Features & Benefits

- Copper seamless barrel has center stop indentations used to indicate when wire is fully inserted into each side of the barrel
- Barrel is designed with an internal chamfer at the wire entry to ensure smooth insertion of the wire,
- Electro-tin plated unless otherwise specified to reduce galvanic corrosion (bimetallic) and resist corrosive elements
- Barrel is color coded to ensure proper die and installation tooling is selected
- Long barrel allows for an increased number of crimps which will increase the mechanical strength of the connection
- Terminals and splices accommodating code wire: Accommodates Code Class B (Concentric, Compressed, Compact) and Class C wire

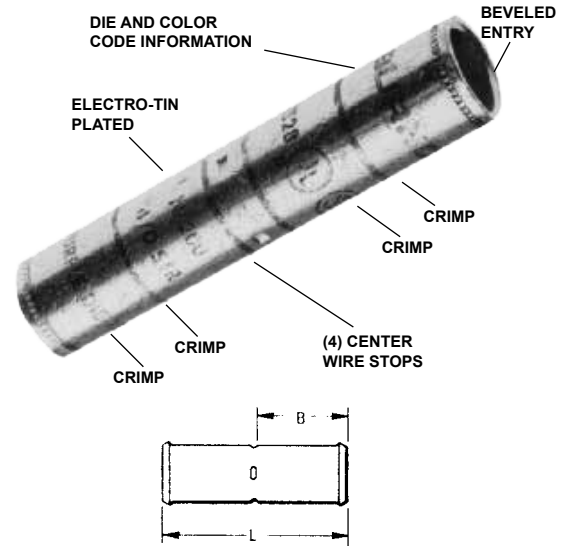

Catalog Number	Conductor		Dimensions		Dieless (# of crimps)	Installation Tooling ▲					Wire Strip Length		
	AWG	mm²	L	B		Mechanical			35 ■, 750, 46* Series			Die Index & Embossment	
						Y1MRTC	MD734R	MD6 OUR840	Die Number (# crimps)	Color Code			
YS8C	8 Str.	10	1.75	0.78	81K Series (1)	Y1MRTC (2)	W8CVT (2)	X8CRT (2)	U8CRT (2)	Red	49	7/8	
YS6C	6 Str.	—	2.38	1.09			W5CVT (2)	X5CRT (2)	U5CRT (2)	Blue	7 or 374	1-3/16	
YS5C	5 Str.	16	2.55	1.09			W5CVT (2)	X5CRT (2)	U5CRT (2)	Blue	7 or 374	1-3/16	
YS4C	4 Str.	—	2.55	1.09			W4CVT (2)	X4CRT (2)	U4CRT (2)	Gray	8 or 346	1-3/16	
YS3C	3 Str./2 Sol.	25	2.80	1.22	81K Series (2)	Y1MRTC (4)	—	W3CRT (2)	—	White	9	1-5/16	
YR2C2WT	2 Str. - 2Sol.	25	3.03	1.25			W2CVT (2)	W2CVT (2)	W2CRT (2)	U2CRT (2)	Brown	10	1-5/8
YS2C	2 Str.	35	2.82	1.22			W2CVT (2)	X2CRT (2)	U2CRT (2)	Brown	10	1-5/16	
YS1C	1 Str.	50	3.07	1.34			W1CVT (2)	X1CRT1 (2)	U1CRT1 (2)	Green	11 or 375	1-7/16	
YS25	1/0 Str.	—	3.08	1.34			—	W25VT (4)	X25RT (4)	U25RT (2)	Pink	12 or 348	1-7/16
YS26	2/0 Str.	70	3.30	1.45			—	W26VT (4)	X26RT (4)	U26RT (2)	Black	13	1-9/16
YS27	3/0 Str.	—	3.30	1.45			—	W27VT (4)	X27RT (4)	U27RT (2)	Orange	14	1-9/16
YS28	4/0 Str.	—	3.57	1.58			—	W28VT (4)	X28RT (4)	U28RT (2)	Purple	15	1-11/16
YS29	250 kcmil	120	3.58	1.58			—	W29VT (4)	—	U29RT (2)	Yellow	16	1-11/16
YS30	300 kcmil	150	4.34	1.95			81K Series (3)	—	W30VT (4)	—	U30RT (4)	White	17 or 298
YS31	350 kcmil	185	4.35	1.95	—	W31VT (4)		—	U31RT (4)	Red	18 or 324	2-1/16	
YS32	400 kcmil	—	4.62	2.08	—	W32VT (4)		—	U32RT (4)	Blue	19 or 470	2-3/16	
YS34	500 kcmil	240	4.91	2.20	81K Series (4)	—	W34VT (4)	—	U34RT (4)	Brown	20 or 299	2-5/16	
YS36	600 kcmil	300	5.85	2.63		—	—	—	U36RT (4)	Green	22 or 472	2-3/4	
YS39	750 kcmil	—	6.38	2.81		—	—	—	U39RT (4)	Black	24	2-15/16	
YS44	1000 kcmil	500	6.55	2.94		—	—	—	P44RT (2)	White	27	3-1/16	
YS46	1500 kcmil	—	7.01	3.13	—	—	—	P46RT (6)	Green	31	3-1/4		
YS48	2000 kcmil	—	7.57	3.27	—	—	—	† L48RT (4)	Brown	34	3-3/8		

① Not color coded.

* Use PUADP1 adapter with U dies in 46 Series.

** P44RT for use with 46 Series tooling only. PUADP1 adapter not required.

*** The MM² conductor sizes listed are the recommendations for Class 2 conductor.

■ The maximum size for the Y35 is 400 kcmil.

▲ See tooling section of this catalog for complete tool and die listings

♦ For applications greater than 2000 Volts consult cable manufacturer for voltage stress relief instructions.

† Requires 60 Ton Series with L48RT die set.

Note: All dimensions shown are for reference only.

TYPE Y-R

Reducing Adapter for Copper

Up to 35 kV ♦

Type Y-R reducing adapter has been designed to allow large size, long barrel, copper HYDENT™, HYSPLICE™, and HYTEE™ terminals, splices and T-taps to be used on small conductor sizes. To use, simply insert the reducer into the barrel, insert the wire into the reducer adapter and crimp the outer barrel using its recommended tooling.

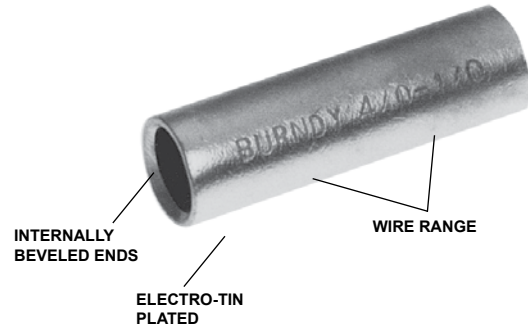

Features & Benefits

- Reducing adapters fit inside copper long barrel compression terminals (Type YA-), splices (Type YS-), or tap connectors
- The outside diameter of the reducing adapter is equivalent to the terminal or splice accommodating wire size, and the inside diameter of the reducer adapter is reduced to accommodate a smaller wire size
- Use the same installation tooling and die sets or dieless tool recommended for the compression terminal, splice, or tap connector with the reducing adapter
- Barrel is designed with an internal chamfer at the wire entry to ensure smooth insertion of the wire, preventing possible damage of the wire strands during insertion
- Electro-tin plated, unless otherwise specified, to reduce galvanic corrosion (bimetallic) and resist corrosive elements
- Can be field modified to fit short length compression terminals (Type YA-L) and splices (Type YS-L)
- Connectors are clearly marked with stamping
- Terminals and splices accommodating code wire: Accommodates Code Class B (Concentric, Compressed, Compact) and Class C wire

Catalog Number	Wire Range		Dimensions	
	From	To	Max O.D.	L
Y286CR	4/0 AWG	6,8, Str. 6 Sol.	0.53	1.75
Y284WR		4 Sol.	0.53	1.75
Y284CR		4 Str.	0.53	1.75
Y282CR		2 Str.	0.53	1.75
Y281CR		1 Str.	0.53	1.75
Y2825R		1/0 Str.	0.53	1.75
Y2826R		2/0 Str.	0.53	1.75
Y2827R		3/0 Str.	0.53	1.75
Y2928R	250 kcmil	4/0	0.58	1.62
Y304CR	300 kcmil	4	0.64	2.00
Y302CR		2	0.64	2.00
Y3025R		1/0	0.64	2.00
Y3026R		2/0	0.64	2.00
Y3027R		3/0	0.64	2.00
Y3028R		4/0	0.64	2.00
Y3126R	350 kcmil	2/0	0.69	2.00
Y3128R		4/0	0.69	2.00
Y3129R		250	0.69	2.00
Y342CR	500 kcmil	2 Str.	0.82	2.50
Y3425R		1/0 Str.	0.82	2.50
Y3426R		2/0 Str.	0.82	2.50
Y3427R		3/0 Str.	0.82	2.50
Y3428R		4/0 Str.	0.82	2.50
Y3429R		250 kcmil	0.82	2.50
Y3430R		300 kcmil	0.82	2.50
Y3431R		350 kcmil	0.82	2.50
Y3432R	400 kcmil	0.82	2.50	
Y3934R	750 kcmil	500 kcmil	1.02	2.88
Y3936R		600 kcmil	1.02	2.88
Y4439R	1000 kcmil	750 kcmil	1.30	3.00

Contact Technical Support for other sizes not listed.

♦ For applications greater than 2000 Volts consult cable manufacturer for voltage stress relief instructions.

Note: All dimensions shown are for reference only.



Example Accommodate a 4/0 AWG wire on one end and a #2 AWG wire on the other:

1. Use a YS28 (which splices two 4/0 AWG wires on each end)
2. Select a Y282CR reducing adapter (reducing adapter fits the YS28 barrel with a reduced inside diameter that accommodates a #2 AWG wire size)
3. Fully insert the Y282CR reducing adapter into one end of the YS28 splice barrel
4. Insert the #2 AWG wire into the Y282CR reducing adapter that is inside the YS28 splice barrel
5. Crimp the YS28 barrel side with the Y282CR reducing adapter, using the recommended die and tool combination or dieless tool as specified for use on the YS28
6. Insert the 4/0 AWG wire into the other end of the YS28 barrel and crimp that side of the splice using the recommended installation tooling and your splice reducing connection is complete!

TYPE YS-LB

HYLINK™ Splice, Belled Ends



UL Listed 90° C, Up to 35 kV ♦

Type YS-LB HYLINK™ splices are designed for flexible and extra flexible copper conductors used in mining machines, locomotives, welding cables and other flexible cable applications. The seamless, high conductivity copper, electro-tin plated belled barrel provides for easy insertion of flexible stranded conductors and the nest indentor die system provides an excellent electrical and mechanical connection.

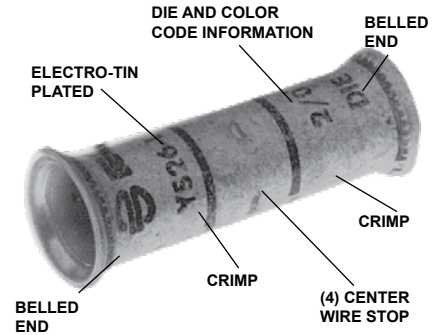

Features & Benefits

- Copper seamless barrel is designed with a “belled” end opening at the wire entry to ensure smooth insertion of highly flexible stranded wire, preventing damaging of the wire strands during insertion
- Electro-tin plated unless otherwise specified to reduce galvanic corrosion (bimetallic) and resist corrosive elements
- Short/standard length barrel is recommended for installations with limited space requirements
- Barrel has center stop indentations used to indicate when wire is fully inserted into each side of the barrel
- Connectors are clearly marked with color coding to ensure proper die and installation tooling is selected
- BURNDY certifies its products using the BURNDY Engineered System and select other crimp tool manufacturers in accordance with one or more of the UL categories in order to obtain a UL Listing

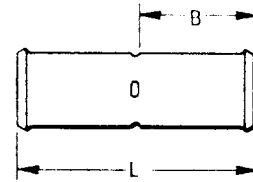

See next page for Installation Tooling Information

Catalog Number	Copper Conductor							Dimensions	
	Class B, C	Flexible and Extra Flexible Cables							
		Class G	Class H	Class I	Battery Cable Class K	Welding Cable Class M	Locomotive Cable	B	L
YS8CLB	8	#8 (49 str)	#8 (133 str)	—	#8 (168/30)	#8 (420/34)	#8 (37/24)	0.44	1.09
YS5CLB	5	#6 (49 str)	#6 (133 str)	#6 (63/24)	#6 (266/30)	#6 (665/34)	#6 (61/24)	0.81	1.82
YS4CLB	4	#5 (49 str)	#5 (133 str)	#5 (84/24)	#5 (336/30)	#5 (836/34)	#5 (91/24)	0.81	1.84
YS3CLB	3	#4 (49 str)	#4 (133 str)	#4 (105/24)	#4 (420/30)	#4 (1064/34)	#4 (105/24)	0.88	1.96
YS2CLB	2	#3 (49 str)	#3 (133 str)	#3 (133/24)	#3 (532/30)	#3 (1323/24)	#3 (125/24)	0.87	1.98
YS1CLB	1	#2 (49 str)	#2 (133 str)	#2 (161/24)	#2 (665/30)	#2 (1666/34)	#2 (150/24)	0.87	1.97
YS25LB	1/0	#1 (133 str)	#1 (259 str)	#1 (210/24)	#1 (836/30)	#1 (2107/34)	#1 (225/24)	0.87	2.00
YS26LB	2/0	1/0 (133 str)	1/0 (259 str)	1/0 (266/24)	1/0 (1064/30)	1/0 (2646/34)	1/0 (275/24)	0.93	2.12
YS27LB	3/0	2/0 (133 str)	2/0 (259 str)	2/0 (342/24)	2/0 (1323/30)	2/0 (3325/34)	2/0 (325/24)	0.99	2.24
YS28LB	4/0	3/0 (133 str)	3/0 (259 str)	3/0 (418/24)	3/0 (1666/30)	—	3/0 (450/24)	0.98	2.26
YS29LB	250	4/0 (133 str)	4/0 (259 str)	—	—	—	—	1.04	2.40
YS30LB	300	250 kcmil (259 str)	250 kcmil (427 str)	4/0 (532/24)	4/0 (2107/30)	4/0 (5320/34)	4/0 (550/24)	1.04	2.41
YS32LB	400	300 kcmil (259 str)	300 kcmil (427 Str)	300 kcmil (735/24)	300 kcmil (2989/30)	300 kcmil (7581/34)	313.1 kcmil (775/24)	1.17	2.69
YS34LB	500	350 kcmil (259 str) 400 kcmil (259 str)	350 kcmil (427 str) 400 kcmil (427 str)	350 kcmil (882/24) 400 kcmil (980/24)	350 kcmil (3458/30)	350 kcmil (8806/34)	373.7 kcmil (925/24)	1.35	3.10
YS36LB	600	500 kcmil (259 str)	500 kcmil (427 str)	450 kcmil (1127/24)	450 kcmil (4522/30)	450 kcmil (11396/34)	444.4 kcmil (1100/24)	1.66	3.14
YS38LB	700	550 kcmil (427 str)	550 kcmil (703 str)	500 kcmil (1225/24) 550 kcmil (1372/24)	500 kcmil (5054/30)	500 kcmil (12691/34)	535.3 kcmil (1325/24)	1.85	3.14
YS39LB	750	600 kcmil (427 str)	—	—	—	550 kcmil (13664/34)	—	1.85	3.64
YS40LB	800	—	600 kcmil (703 str)	600 kcmil (1470/24)	—	600 kcmil (14945/34)	—	1.85	3.67
YS44LB	1000	750 kcmil (427 str)	750 kcmil (703 str)	650 kcmil (1596/24)	600 kcmil (5985/30)	—	777.7 kcmil (1925/24)	1.85	4.20

* Contact BURNDY® for conductors not shown.

♦ For applications greater than 2000 Volts consult cable manufacturer for voltage stress relief instructions.

Note: All dimensions shown are for reference only.

TYPE YS-LB (Continued)

INSTALLATION TOOLING CHART



Catalog Number	Cable Size	Installation Tooling ▲				HYDRAULIC				Wire Strip Length
		Dieless (# of Crimps)	Die Index	Dieless (# of crimps)	Die Type	35 † Series	750 † Series	46 * † Series	60 Ton Series	
YS8CLB	8 AWG	-	49	Y8MRB1	DIE SET	U8CRT	U8CRT	U8CRT	-	7/16
	8 Flex		1013		NEST	UV8L	UV8L	UV8L	-	
YS5CLB ①	5 AWG	81K Series (1)	7	MR4C MY293 MY2911	DIE SET	U5CRT	U5CRT	U5CRT	-	7/8
	6 Flex		1014		NEST	U6CD1	U6CD1	U6CD1		
YS4CLB	4 AWG	644 Series (1) 444 Series (1) 81K Series (1)	8	MR4C MY293 MY2911	DIE SET	U4CRT	U4CRT	U4CRT	-	7/8
	5 Flex		1015		NEST	U4CD1	U4CD1	U4CD1		
YS3CLB	3 AWG	644 Series (1) 444 Series (1) 81K Series (1)	9	MY293 MY2911	DIE SET	U3CRT	U3CRT	U3CRT	-	15/16
	4 Flex		1016		NEST	U3CD1	U3CD1	U3CD1		
YS2CLB	2 AWG	644 Series (1) 444 Series (1) 81K Series (1)	10	MY293 MY2911	DIE SET	U2CRT	U2CRT	U2CRT	-	15/16
	3 Flex		1017		NEST	U2CD1	U2CD1	U2CD1		
YS1CLB	1 AWG	644 Series (1) 444 Series (1) 81K Series (1)	11	MY293 MY2911	DIE SET	U1CRT1	U1CRT1	U1CRT1	-	15/16
	2 Flex		1018		NEST	U1CD1	U1CD1	U1CD1		
YS25LB	1/0 AWG	644 Series (1) 444 Series (1) 81K Series (1)	12	MY293 MY2911	DIE SET	U25RT	U25RT	U25RT	-	15/16
	1 Flex		1019		NEST	U25D1	U25D1	U25D1		
YS26LB	2/0 AWG	644 Series (1) 444 Series (1) 81K Series (1)	13	MY293 MY2911	DIE SET	U26RT	U26RT	U26RT	-	1
	1/0 Flex		1020		NEST	U26D1	U26D1	U26D1		
YS27LB	3/0 AWG	644 Series (1) 444 Series (1) 81K Series (1)	14	MY293 MY2911	DIE SET	U27RT	U27RT	U27RT	-	1-1/16
	2/0 Flex		1021		NEST	U27D1	U27D1	U27D1		
YS28LB	4/0 AWG	644 Series (1) 444 Series (1) 81K Series (1)	15	MY293 MY2911	DIE SET	U28RT	U28RT	U28RT	-	1-1/16
	3/0 Flex		1022		NEST	-	U28D1	U28D1		
YS29LB	250 kcmil	644 Series (2) 444 Series (2) 81K Series (2)	16	MY293 MY2911	DIE SET	U29RT	U29RT	U29RT	-	1-1/16
	4/0 Flex		1023		NEST	-	U29D1	U29D1		
YS30LB	300 kcmil	644 Series (2) 444 Series (2) 81K Series (2)	17	-	DIE SET	U30RT	U30RT	U30RT	-	1-1/8
	4/0-250 Flex		1024		NEST	-	U30D1	U30D1		

† Use Y35P3 adaptor with Y34PR indenter.

* Use PUADP1 adaptor with U dies in 46 Series

▲ See Tooling section in this catalog for complete tool and die listings.

① Not color coded.

◆ For applications greater than 2000 Volts consult cable manufacturer for voltage stress relief instructions.

Note: All dimensions shown are for reference only.

TYPE YS-LB (Continued)

INSTALLATION TOOLING CHART



Catalog Number	Cable Size	Installation Tooling ▲				HYDRAULIC				Wire Strip Length
		Dieless (# of Crimps)	Die Index	Dieless (# of crimps)	Die Type	35 † Series	750 † Series	46 * † Series	60 Ton Series	
YS32LB	400 kcmil	644 Series (2) 444 Series (2) 81K Series (2)	19	-	DIE SET	U32RT	U32RT	U32RT	L32RT	1-1/4
	300 Flex		1026		NEST INDENTOR	- -	U32D-1 Y34PR-2	U32D-1 Y34PR-2	- -	
YS34LB	500 kcmil		20	-	DIE SET	-	U34RT	U34RT	L34RT	1-7/16
	350 Flex		1027		NEST INDENTOR	- -	U34D-1 Y34PR-2	U34D-1 Y34PR-2	- -	
YS36LB	600 kcmil		22	-	DIE SET	-	U36RT	U36RT	L36RT	1-3/4
	500 Flex		1028		NEST INDENTOR	- -	- -	P36D P48PR-1	- -	
YS38LB	700 kcmil		400	-	DIE SET	U38RT	U38RT	U38RT	-	1-15/16
	550 Flex		1029		NEST INDENTOR	- -	- -	P38D P48PR-1	- -	
YS39LB	750 kcmil		24	-	DIE SET	-	U39RT	P39RT	L39RT	1-15/16
	600 Flex		1030		NEST INDENTOR	- -	- -	P39D P48PR-1	- -	
YS40LB	800 kcmil		25	-	DIE SET	-	-	P40RT	L40RT	1-15/16
	600 Flex		1031		NEST INDENTOR	- -	- -	P40D P48PR-1	- -	
YS44LB	1000 kcmil		27	-	DIE SET	-	-	P44RT	L44RT	1-15/16
	750 Flex		1022		NEST INDENTOR	- -	- -	P44D P48PR-1	- -	

† Use Y35P3 adaptor with Y34PR indenter.

* Use PUADP1 adaptor with U dies in 46 Series

▲ See Tooling section in this catalog for complete tool and die listings.

Ⓞ Not color coded.

◆ For applications greater than 2000 Volts consult cable manufacturer for voltage stress relief instructions.

Note: All dimensions shown are for reference only.

TYPES YS-T, YSP-T

HYLINK™ High Voltage, Tapered Ends

UL Listed 90° C, Up to 35 kV ♦



Types YS-T and YSP-T seamless high conductivity copper electro-tin plated compression HYLINK™ high voltage splices with standard barrel and tapered ends are ideally suited for higher voltage applications from 5 kV through 35 kV.

Features & Benefits

- Copper seamless barrel is designed with tapered ends per EEI Standard TD160, indicating use on voltages 5kV through 35kV; this aids in preventing corona emission and simplifies taping for lower installation cost
- Barrel also features an internal chamfer at the wire entry to ensure smooth insertion of the wire, preventing possible damage of the wire strands during insertion
- Electro-tin plated unless otherwise specified to reduce galvanic corrosion (bimetallic) and resist corrosive elements
- Short/standard length barrel is recommended for installations with limited space requirements
- Type YS-T barrel has center stop indentations used to indicate when wire is fully inserted into each side of the barrel
- Type YSP-T barrel has a center plug permanently brazed in place; this plug prevents oil within oil filled conductor from passing through the splice connector and is also an indication when the wire is fully inserted into each side of the barrel
- Connectors are clearly marked with color coding to ensure proper die and installation tooling is selected
- BURNDY certifies its products using the BURNDY Engineered System and select other crimp tool manufacturers in accordance with one or more of the UL categories in order to obtain a UL Listing
- Terminals and splices accommodating code wire: Accommodates Code Class B (Concentric, Compressed, Compact) and Class C wire

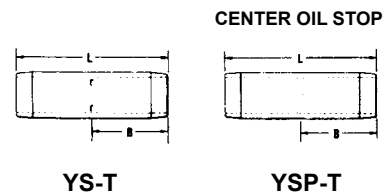
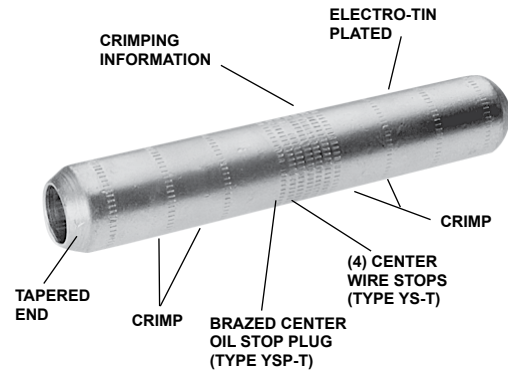

Accessories

- Hardware - Section F
- PENETROX™ Oxide Inhibitor - Section F
- Heat and Cold Shrink Tubing - Section D
- WIREMIKE™ Wire Micrometer - Section F
- Wire Management (Cable Ties) - Section G

Catalog Number		Code Conductors	Dimensions		Installation Tooling- Nest/Indentor ▲					Wire Strip Length
					Y34B Y34PR Indentor	35, 750 Series, Y34PR Indentor Y35P3 Adaptor	35, 750, 46° Series Die Number (# of crimps per end)	Die Index ▲	No. of Indent	
YS-T	YSP-T		B	L	Nest Die	Nest Die				
YS6CT	—	6 Str.	0.90	2.16	B6CD	U6CD1	U5CRT (2)	7	1	15/16
YS4CT	YSP4CT	4 Str.	0.90	2.16	B4CD	U4CD1	U4CRT (2)	8	1	15/16
YS2CT	YSP2CT	2 Str.	0.98	2.34	B2CD	U2D1	U2CRT (2)	10	1	1
YS1CT	YSP1CT	1 Str.	0.97	2.31	B1CD	U1D1	U1CRT1 (2)	11	1	1
YS25T	YSP25T	1/0 Str.	0.98	2.35	B25D	U25D1	U25RT (2)	12	1	1-3/32
YS26T	YSP26T	2/0 Str.	1.04	2.47	B26D	U26D1	U26RT (2)	13	1	1-3/32
YS28T	YSP28T	4/0 Str.	1.13	2.67	B28D	U28D1	U28RT (2)	15	1	1-3/16
YS29T	YSP29T	250 kcmil	1.21	2.85	B29D	U29D1	U29RT (2)	16	1	1-3/32
YS30T	YSP30T	300 kcmil	1.22	2.87	B30D	U30D1	U30RT (4)	17	2	1-5/16
YS31T	YSP31T	350 kcmil	1.32	3.09	B31D	U31D1	U31RT (4)	18	2	1-3/5
YS34T	YSP34T	500 kcmil	1.68	3.86	No Die Needed	U34D1	U34RT (4)	20	2	1-3/4
YS39T	YSP39T	750 kcmil	2.00	4.60	—	—	U39RT (4)	24	2	2-1/8

* Use adapter PUADP1 with U Dies in 46 Series. 46 Series uses the same nest indentor and adapter as the 35 and 750 Series, but with the PUADP1 adapter.

** A 0.06 radius at each end is used for sizes 6-27.

■ The maximum size for the 35 Series is 400 kcmil.

▲ See tooling section of this catalog for complete tool and die listings.

♦ For applications greater than 2000 Volts consult cable manufacturer for voltage stress relief instructions.

Note: All dimensions shown are for reference only.

TYPE YS-FXB

HYLINK™ Splice, Belled Ends

UL Listed 90° C, Up to 35 kV ♦



Features & Benefits

- Copper seamless barrel is designed with a “belled” end opening at the wire entry to ensure smooth insertion of highly flexible stranded wire, preventing damaging of the wire strands during insertion
- Electro-tin plated unless otherwise specified to reduce galvanic corrosion (bimetallic) and resist corrosive elements
- Long barrel allows for an increased number of crimps which will increase the mechanical strength of the connection
- Barrel has center stop indentations used to indicate when wire is fully inserted into each side of the barrel
- Connectors are clearly marked with color coding to ensure proper die and installation tooling is selected
- BURNDY certifies its products using the BURNDY Engineered System and select other crimp tool manufacturers in accordance with one or more of the UL categories in order to obtain a UL Listing

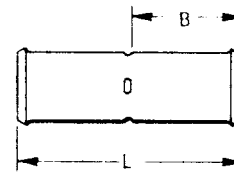
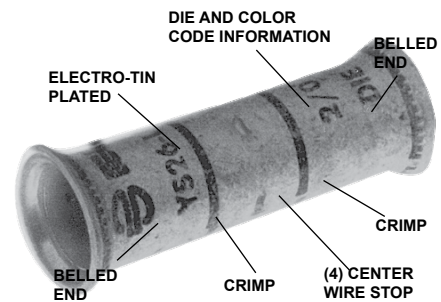

Accessories

- Hardware - Section F
- PENETROX™ Oxide Inhibitor - Section F
- Heat and Cold Shrink Tubing - Section D
- WIREMIKE™ Wire Micrometer - Section F
- Wire Management (Cable Ties) - Section G

Compression Connections

Copper — Flex
Belled Ends, Long Barrel Splice

TYPE YS-FXB (Continued)



Catalog Number	Conductor		Dimensions		Installation Tooling					Cable Strip Length
	Flexible Cable Code AWG	*** MM ²	L (mm)	B (mm)	Dieless (# of crimps/end)	Mechanical	35, 750, 46* Series			
						Y1MRTC	Embossed Die Index	Color Code	Die Number (# of crimps/end)	
YS8CFXB	#8 AWG G,H,I,K,M DLO (37/24) #8 AWG, #6 SOL, #8 SOL	10	1.99 (51)	0.90 (23)	81K Series (1)	Y1MR (2)	49	Red	U8CRT (2)	1" (25)
YSV6CFXB	#6 AWG G,H,I,K,M DLO (61/24) #6 AWG	‡ 16	2.62 (67)	1.22 (31)		Y1MR (2)	7	Blue	U5CRT (2)	1-5/16" (33)
YSV4CFXB	#4 AWG G,H,I,K,M DLO (105/24) #4 AWG	—	2.62 (67)	1.22 (31)		Y1MR (4)	8	Gray	U4CRT (2)	1-5/16" (33)
YSV2CFXB	#2 AWG G,H,I,K,M DLO (150/24) #2 AWG	35	2.89 (73)	1.35 (34)		Y1MR (4)	10	Brown	U2CRT (2)	1-7/16" (37)
YSV1CFXB	#1 AWG G,H,I,K,M DLO (225/24) #1 AWG	—	3.18 (81)	1.50 (38)		—	11	Green	U1CRT-1 (2)	1-9/16" (40)
YSV25FXB	1/0 AWG G,H,I,K,M DLO (275/24) 1/0 AWG	50	3.18 (81)	1.50 (38)		—	12	Pink	U25RT (2)	1-9/16" (40)
YSV26FXB	2/0 AWG G,H,I,K,M DLO (325/24) 2/0 AWG	70	3.44 (87)	1.63 (41)		—	13	Black	U26RT (2)	1-11/16" (43)
YSV27FXB	3/0 AWG G,H,I,K,M DLO (450/24) 3/0 AWG	95	3.46 (88)	1.64 (42)		—	14	Orange	U27RT (2)	1-11/16" (43)
YSV28FXB	4/0 AWG G,H,I,K,M DLO (550/24) 4/0 AWG	† 120	3.72 (94)	1.77 (45)	81K Series (2)	—	15	Purple	U28RT (2)	1-7/8" (48)
YS30FXB	250 kcmil G,H	—	4.51 (115)	2.16 (55)		—	16	Yellow	U29RT (2)	2-1/4" (57)
YS31FXB	250 kcmil I,K,M DLO 262 (650/24)	150	4.54 (115)	2.18 (55)		—	17	White	U30RT (4)	2-1/4" (57)
YS32FXB	300 kcmil G,H,I,K,M DLO 313 (775/24)	185	4.82 (122)	2.32 (59)		—	18	Red	U31RT (4)	2-7/16" (62)
YS34FXB	350 kcmil G,H,I,K,M DLO 373 (925/24)	240	5.14 (131)	2.48 (63)		—	19	Blue	U32RT (4)	2-9/16" (65)
YS36-FXB	500 kcmil G,H DLO 444 (110/24)	300	6.09 (155)	2.95 (75)		—	20	Brown	U34RT (4)	3-1/16" (79)
YS38FXB	500 kcmil H,I,K 550 kcmil G,H,I DLO 535 (1325/24)	—	6.34 (161)	3.08 (78)	81K Series (3)	—	L99	Pink	U38XRT (4)	3-3/16" (81)
YS40FXB	650 kcmil G DLO 646 (1600/24)	400	6.66 (169)	3.24 (82)		—	24	Black	U39RT (4)	3-5/16" (84)
YS44FXB	750 kcmil G,H DLO 777 (1925/24)	500	6.84 (174)	3.33 (85)		—	L115	Yellow	U44XRT (4) †P44XRT (4)	3-7/16" (87)

* Use PUADP1 adapter with U dies in 46 Series.

† P-RT dies sets are for use with 46 Series only.

*** The MM² conductor sizes listed are the recommendations for Class 5 conductor.

‡ 16 MM² and 120 MM² referenced are for both Class 2 and Class 5

■ The maximum size for the 35 Series is 373.7 kcmil.

▲ See tooling section of this catalog for complete tool and die listings.

◆ For applications greater than 2000 Volts consult cable manufacturer for voltage stress relief instructions.

Note: All dimensions shown are for reference only. Measurements in brackets [] are in metric dimensions.

TYPE YS-TC

HYSPLICE™ In-Line Splice Kits Standard Barrel, with Inspection Window

Type YS-TC kits are for splicing cables and covering the connection with clear heat shrink. Splices are constructed from seamless, high conductivity electrolytic copper tubing for maximum conductivity and tin-plated to resist corrosion. Each YS-TC splice is provided with inspection holes and cable stops. The YS-TC family also features the BURNDY Engineered System of coordinated tools and dies.

Features & Benefits

- Each splice kit includes one YS-TC compression splice connector and heat shrink
- The YS-TC type compression splice connector provided in the kit is UL Listed in accordance with UL 486A-486B - Wire Connectors; UL Listed 90°C up to 35kV
- Barrels have 2 inspection windows on each side to allow for visual verification that the wire has been fully inserted prior to crimping the splice
- Barrel is designed with an internal chamfer at the wire entry to ensure smooth insertion of the wire, preventing possible damaging of the wire strands during insertion
- Electro-tin plated unless otherwise specified to reduce galvanic corrosion (bimetallic) and resist corrosive elements
- Short/standard length barrel is recommended for installations with limited space requirements and meet the exact UL testing requirements as long barrel connectors so performance of the connection is not compromised
- Connectors clearly marked with color coding

Accessories

- Hardware - Section F
- PENETROX™ Oxide Inhibitor - Section F
- Heat and Cold Shrink Tubing - Section D
- WIREMIKE™ Wire Micrometer - Section F
- Wire Management (Cable Ties) - Section G

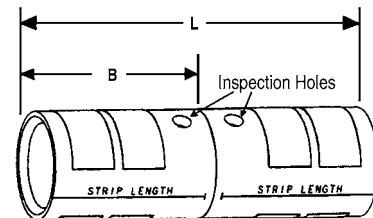
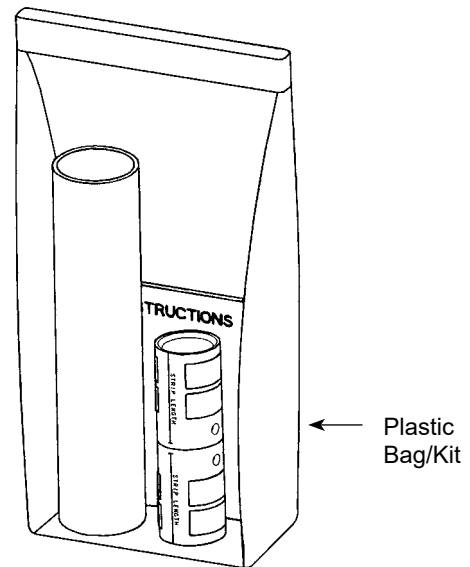

Compression Connections

Copper — Code / Flex — In Line Splice Kit
Standard Barrel — with Inspection Window

TYPE YS-TC (Continued)

HYREDUCER™ In-Line Standard Barrel
Splice Kits with Inspection Window

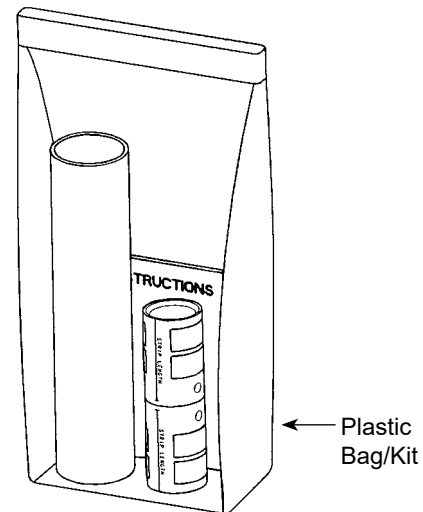

Clear Heat Shrink Kit Catalog Number	Wire Size		Barrel Type	Dimensions		Color Code	Die Index	Wire Strip Length
	AWG	mm ²		Barrel	Length			
YS44FXLTCKITC	750 kcmil G,H DLO 777 (1925/24)	500 mm ² Class 5	Standard	1.90	4.30	Yellow	L115	1.96
YS39LTCKITC	750 kcmil Code	—	Standard	1.62	3.68	Black	23	1.67
YS38FXLTCKITC	500 kcmil H,I,K 550 kcmil G,H,I DLO 535 (1325/24)	300 mm ² Class 5	Standard	1.71	3.87	Pink	L99	1.77
YS34LTCKITC	500 kcmil Code	240 mm ² Class 2	Standard	1.56	3.51	Brown	20	1.60
YS34FXLTCKITC	350 kcmil G,H,I,K,M DLO 373 (925/24)	240 mm ² Class 2	Standard	1.56	3.51	Blue	19 or L80	1.60
YS31LTCKITC	350 kcmil Code	185 mm ² Class 2	Standard	1.39	3.10	Red	17	1.42
YS29FXLTCKITC	250 kcmil Flex 4/0 AWG G,H,I,K,M DLO (550/24)	—	Standard	1.36	2.98	Yellow	16	1.38
YS28LTCKITC	4/0 AWG Code	—	Standard	1.23	2.69	Purple	15	1.24
YS26LTCKITC	2/0 AWG Code	70 mm ²	Standard	1.16	2.62	Black	13	1.10
YS26FXLTCKITC	2/0 AWG G,H,I,K,M DLO (325/24)	70 mm ² Class 5	Standard	1.09	2.41	Black	13	1.10
YS25LTCKITC	1/0 AWG Code	—	Standard	1.04	2.37	Pink	12	1.00
YS25FXLTCKITC	1/0 AWG G,H,I,K,M DLO (275/24) 1/0 AWG	50 mm ² Class 5	Standard	1.04	2.18	Pink	12	1.00
YS2CLTCKITC	#2 AWG Code	35 mm ² Class 5	Standard	0.82	1.88	Brown	10	0.78
YS2CFXLTCKITC	#2 AWG G,H,I,K,M DLO (150/24)	35 mm ² Class 5	Standard	0.82	1.73	Brown	10	0.78
YS4CFXLTCKITC	#4 AWG G,H,I,K,M DLO (105/24) #4 AWG	—	Standard	0.74	1.69	Gray	8	0.71
YS6CFXLTCKITC	#6 AWG G,H,I,K,M DLO (61/24) #6 AWG	16 mm ² Class 5 or Class 2	Standard	0.73	1.60	Blue	7 or 24	0.70
YS8CFXLTCKITC	#8 AWG G,H,I,K,M DLO (37/24) #8 AWG, #6 SOL, #8 SOL	—	Standard	0.65	1.48	Red	49	0.62

* Clear Heatshrink – UL224 VW1 Listed – passes TELCORDIA GR-347-CORE Abrasion and Cut Test.
(Up to 750 kcmil Class B code cable. Contact factory for 750 flex cable applications.)
Note: All dimensions shown are for reference only.

TYPE YSR-TC

HYREDUCER™ In-Line Reducer Splice Kits Standard Barrel, with Inspection Window

Type YSR-TC reducing splice kits provide for splicing two different cable sizes with inspection holes. The larger conductor is inserted first and butts against the center of the connector where the smaller barrel begins. Constructed from seamless, high conductivity electrolytic copper tubing for maximum conductivity and tin plated to resist corrosion. The YSR-TC family also features the BURNDY® color code system.

Features & Benefits

- Each splice kit includes one YSR-TC compression in-line splice reducer connector and heat shrink
- The YSR-TC type reducing compression splice connector provided in the kit is UL Listed in accordance with UL 486A-486B - Wire Connectors; UL Listed 90°C up to 35kV
- Barrels have 2 inspection windows on each side to allow for visual verification that the wire has been fully inserted prior to crimping the splice
- Designed configurations allow for copper code-to-code wire connections, copper code-to-flex wire connections, and copper flex-to-flex wire connections; see table for more complete details
- Barrel is designed with a taper to accommodate a main run wire that is reduced to a smaller tap wire
- Barrel also provided with an internal chamfer at the wire entry to ensure smooth insertion of the wire, preventing possible damaging of the wire strands during insertion
- Electro-tin plated unless otherwise specified to reduce galvanic corrosion (bimetallic) and resist corrosive elements
- Short/standard length barrel is recommended for installations with limited space requirements and meet the exact UL testing requirements as long barrel connectors so performance of the connection is not compromised
- Connectors clearly marked with color coding
- Can be used in place of H-taps; the in-line design saves space in cable trays and other similar applications

Accessories

- Hardware - Section F
- PENETROX™ Oxide Inhibitor - Section F
- Heat and Cold Shrink Tubing - Section D
- WIREMIKE™ Wire Micrometer - Section F
- Wire Management (Cable Ties) - Section G

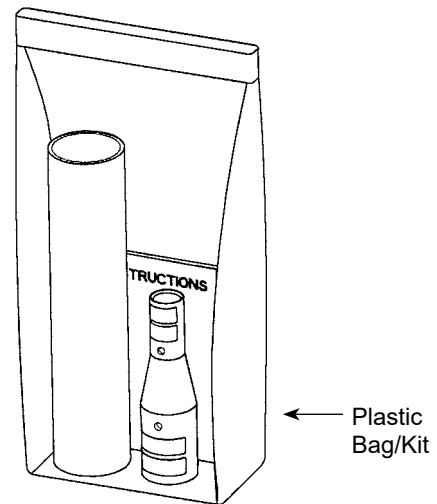

Connector with Clear Heat Shrink Kit

Clear heat shrink UL224 VW1 Listed. Passes TELCORDIA GR-347-CORE Abrasion and Cut Test up to 750 kcmil Class B code cable; contact factory for 750 flex cable applications.

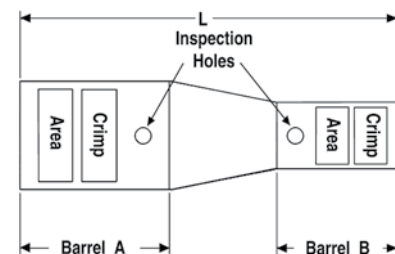

Compression Connections

Copper — Code / Flex — Reducing Splice Kit
Standard Barrel — with Inspection Window

TYPE YSR-TC (Continued)

HYREDUCER™ In-Line Standard Barrel Reducer
Splice Kits with Inspection Window

Connector with Clear Heat Shrink Kit

Clear heat shrink UL224 VW1 Listed. Passes TELCORDIA GR-347-CORE
Abrasion and Cut Test up to 750 kcmil Class B code cable; contact factory for
750 flex cable applications.

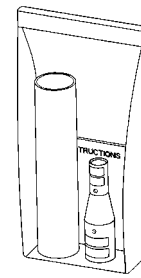

← Plastic Bag/Kit

Clear Heat Shrink Kit Catalog Number	Wire Size				Connector							Wire Strip Length	
	Barrel A		Barrel B		Dimensions			Color Code		Die Index		Barrel A	Barrel B
	AWG	mm ²	AWG	mm ²	Barrel A	Barrel B	L	Barrel A	Barrel B	Barrel A	Barrel B		
YSR44FX39LTCKITC	750 kcmil G,H DLO 777 (1925/24)	500 mm ² Class 5	750 kcmil Code	-	2.09	1.78	4.38	Yellow	Black	L115	24	1.96	1.67
YSR44FX38FLTCKITC			500 kcmil H,I,K 550 kcmil G,H,I DLO 535 (1325/24)	300 mm ²	2.09	1.60	4.61		Pink		L99	1.96	1.77
YSR44FX34LTCKITC			500 kcmil Code	240 mm ²	2.09	1.69	4.91		Brown		20	1.96	1.60
YSR44FX34FLTCKITC			350 kcmil G,H,I,K,M DLO 373 (925/24)	240 mm ²	2.09	1.69	4.91		Blue		19 or L80	1.96	1.60
YSR44FX31LTCKITC			350 kcmil Code	185 mm ²	2.09	1.49	5.18		Red		18	1.96	1.41
YSR44FX30LTCKITC			300 kcmil Code	150 mm ²	2.09	1.30	5.01		White		17 or 298	1.96	1.24
YSR44FX29LTCKITC †			250 kcmil Code	-	2.09	1.44	5.53		Yellow		16	1.96	1.38
YSR44FX29FLTCKITC			250 kcmil Flex 4/0 AWG G,H,I,K,M DLO (550/24)	120 mm ²	2.09	1.44	5.33		Yellow		16	1.96	1.38
YSR44FX28LTCKITC †			4/0 AWG Code	-	2.09	1.30	5.27		Purple		15	1.96	1.24
YSR44FX28FLTCKITC †			4/0 AWG G,H,I,K,M DLO (550/24) 4/0 AWG	120 mm ²	2.09	1.40	5.46		Purple		15	1.96	1.36
YSR3939LTCKITC			750 kcmil Code	-	750 kcmil Code	-	1.78		1.78		4.13	Black	Black
YSR3938FLTCKITC	500 kcmil H,I,K 550 kcmil G,H,I DLO 535 (1325/24)	300 mm ²			1.78	1.88	3.79	Pink	L99	1.67	1.77		
YSR3934LTCKITC	500 kcmil Code	240 mm ²			1.78	1.69	4.09	Brown	20	1.67	1.60		
YSR3934FLTCKITC	250 kcmil G,H,I,K,M DLO 373 (925/24)	240 mm ²			1.78	1.69	4.09	Blue	19 or L80	1.67	1.60		
YSR3931LTCKITC	350 kcmil Code	185 mm ²			1.78	1.49	4.36	Red	18	1.67	1.41		
YSR3930LTCKITC	300 kcmil Code	150 mm ²			1.78	1.30	4.23	White	17 or 298	1.67	1.24		
YSR3929LTCKITC †	250 kcmil Code	-			1.78	1.44	4.71	Yellow	16	1.67	1.38		
YSR3929FLTCKITC	250 kcmil Flex 4/0 AWG G,H,I,K,M DLO (550/24)	120 mm ²			1.78	1.44	4.59	Yellow	16	1.67	1.38		
YSR3928LTCKITC †	4/0 AWG Code	-			1.78	1.30	4.65	Purple	15	1.67	1.24		
YSR3928FLTCKITC †	4/0 AWG G,H,I,K,M DLO (550/24) 4/0 AWG	120 mm ²			1.78	1.40	4.64	Purple	15	1.67	1.36		

† Provided with 2 heat shrink tubings. One will overlap the other; install the smaller first and larger over it.

Separate Installation Tooling Chart follows.

TYPE YSR-TC (Continued)

HYREDUCER™ In-Line Standard Barrel Reducer
Splice Kits with Inspection Window

Connector with Clear Heat Shrink Kit

Clear heat shrink UL224 VW1 Listed. Passes TELCORDIA GR-347-CORE
Abrasion and Cut Test up to 750 kcmil Class B code cable; contact factory for
750 flex cable applications.

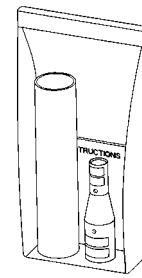

← Plastic Bag/Kit

Clear Heat Shrink Kit Catalog Number	Wire Size				Connector								Wire Strip Length		
	Barrel A		Barrel B		Dimensions			Color Code		Die Index		Barrel A	Barrel B		
	AWG	mm ²	AWG	mm ²	Barrel A	Barrel B	L	Barrel A	Barrel B	Barrel A	Barrel B				
YSR38FX34LTCKITC	500 kcmil H,I,K 550 kcmil G,H,I DLO 535 (1325/24)	300 mm ²	500 kcmil Code	240 mm ²	1.88	1.69	4.06	Pink	Brown	L99	20	1.77	1.60		
YSR38FX34FXLTCKITC			350 kcmil G,H,I,K,M DLO 373 (925/24)	240 mm ²	1.88	1.69	4.06		Blue		19 or L80	1.77	1.60		
YSR38FX31LTCKITC			350 kcmil Code	185 mm ²	1.88	1.49	4.33		Red		18	1.77	1.41		
YSR38FX30LTCKITC			300 kcmil Code	150 mm ²	1.88	1.30	4.20		White		17 or 298	1.77	1.24		
YSR38FX29LTCKITC †			250 kcmil Code	-	1.88	1.44	4.67		Yellow		16	1.77	1.38		
YSR38FX29FXLTCKITC †			250 kcmil Flex 4/0 AWG G,H,I,K,M DLO (550/24)	120 mm ²	1.88	1.44	4.48		Yellow		16	1.77	1.38		
YSR38FX28FXLTCKITC †			4/0 AWG G,H,I,K,M DLO (550/24) 4/0 AWG	120 mm ²	1.88	1.40	4.60		Purple		15	1.77	1.36		
YSR38FX28LTCKITC †			4/0 AWG Code	-	1.88	1.30	4.62		Pink		Purple	L99	15	1.77	1.24
YSR38FX26FXLTCKITC †			2/0 AWG G,H,I,K,M DLO (325/24) 2/0 AWG	70 mm ² Class 5	1.88	1.13	4.62				Black		13	1.77	1.09
YSR3434FXLTCKITC			350 kcmil G,H,I,K,M DLO 373 (925/24)	240 mm ²	1.69	1.69	3.51				Brown		Blue	20	19 or L80
YSR3431LTCKITC	350 kcmil Code	185 mm ²	1.69	1.49	3.66	Red	18	1.60	1.41						
YSR3429FXLTCKITC	250 kcmil Flex 4/0 AWG G,H,I,K,M DLO (550/24)	120 mm ²	1.69	1.44	3.81	Yellow	16	1.60	1.38						
YSR3428LTCKITC	4/0 AWG Code	-	1.69	1.30	3.95	Purple	15	1.60	1.24						
YSR3426FXLTCKITC †	2/0 AWG G,H,I,K,M DLO (325/24) 2/0 AWG	70 mm ² Class 5	1.69	1.13	4.01	Black	13	1.60	1.09						
YSR3425FXLTCKITC †	1/0 AWG G,H,I,K,M DLO (275/24) 1/0 AWG	50 mm ²	1.69	1.04	4.01	Pink	12	1.60	1.00						
YSR34FX31LTCKITC	350 kcmil G,H,I,K,M DLO 373 (925/24)	240 mm ²	350 kcmil Code	185 mm ²	1.69	1.49	3.63	Blue	Red	19 or L80		18	1.60		1.41

† Provided with 2 heat shrink tubings. One will overlap the other; install the smaller first and larger over it.

Separate Installation Tooling Chart follows.

Compression Connections

Copper — Code / Flex — Reducing Splice Kit
Standard Barrel — with Inspection Window

TYPE YSR-TC (Continued)

HYREDUCER™ In-Line Standard Barrel Reducer
Splice Kits with Inspection Window

Connector with Clear Heat Shrink Kit

Clear heat shrink UL224 VW1 Listed. Passes TELCORDIA GR-347-CORE
Abrasion and Cut Test up to 750 kcmil Class B code cable; contact factory for
750 flex cable applications.

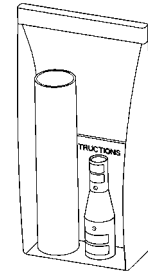

← Plastic Bag/Kit

Clear Heat Shrink Kit Catalog Number	Wire Size				Connector								Wire Strip Length	
	Barrel A		Barrel B		Dimensions			Color Code		Die Index		Barrel A	Barrel B	
	AWG	mm ²	AWG	mm ²	Barrel A	Barrel B	L	Barrel A	Barrel B	Barrel A	Barrel B			
YSR34FX29FXLTCKITC	350 kcmil G,H,I,K,M DLO 373 (925/24)	240 mm ²	250 kcmil Flex 4/0 AWG G,H,I,K, DLO (550/24)	120 mm ²	1.69	1.44	3.81	Blue	Yellow	19 or L80	16	1.60	1.38	
YSR34FX28FXLTCKITC			4/0 AWG G,H,I,K,M DLO (550/24) 4/0 AWG	120 mm ²	1.69	1.43	3.86		Purple		15	1.60	1.36	
YSR34FX28LTCKITC			4/0 AWG Code	-	1.69	1.30	3.95		Purple		15	1.60	1.24	
YSR34FX26FXLTCKITC			2/0 AWG G,H,I,K,M DLO (325/24) 2/0 AWG	70 mm ² Class 5	1.69	1.13	3.94		Black		13	1.60	1.09	
YSR34FX25FXLTCKITC			1/0 AWG G,H,I,K,M DLO (275/24) 1/0 AWG	50 mm ²	1.69	1.04	4.01		Pink		12	1.60	1.00	
YSR34FX2CFXLTCKITC			#2 AWG G,H,I,K,M DLO (150/24) #2 AWG	35 mm ²	1.69	0.82	4.02		Brown		10	1.60	0.78	
YSR34FX4CFXLTCKITC ††			#4 AWG G,H,I,K,M DLO (105/24)	-	1.69	0.74	4.11		Gray		8	1.60	0.71	
YSR34FX6CFXLTCKITC ††			#6 AWG G,H,I,K,M DLO (61/24) #6 AWG	16 mm ²	1.69	0.73	4.26		Blue		7	1.60	0.70	
YSR3129FXLTCKITC	350 kcmil Code	185 mm ² Class 2	250 kcmil Flex 4/0 AWG G,H,I,K, DLO (550/24)	120 mm ²	1.49	1.44	3.13	Red	Yellow	18	16	1.41	1.38	
YSR3128FXLTCKITC			4/0 AWG G,H,I,K,M DLO (550/24) 4/0 AWG	120 mm ²	1.25	1.40	3.25		Purple		15	1.41	1.36	
YSR3128LTCKITC			4/0 AWG Code	-	1.49	1.30	3.27		Purple		15	1.41	1.24	
YSR3126FXLTCKITC			2/0 AWG G,H,I,K,M DLO (325/24) 2/0 AWG	70 mm ² Class 5	1.49	1.16	3.24		Black		13	1.41	1.10	
YSR3125FXLTCKITC			1/0 AWG G,H,I,K,M DLO (275/24) 1/0 AWG	50 mm ²	1.49	1.04	3.33		Pink		12	1.41	1.00	

† Provided with 2 heat shrink tubings. One will overlap the other; install the smaller first and larger over it.

Separate Installation Tooling Chart follows.

TYPE YSR-TC (Continued)

HYREDUCER™ In-Line Standard Barrel Reducer
Splice Kits with Inspection Window

Connector with Clear Heat Shrink Kit

Clear heat shrink UL224 VW1 Listed. Passes TELCORDIA GR-347-CORE
Abrasion and Cut Test up to 750 kcmil Class B code cable; contact factory for
750 flex cable applications.

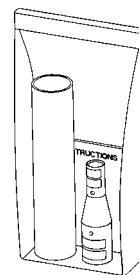

← Plastic Bag/Kit

Clear Heat Shrink Kit Catalog Number	Wire Size				Connector								Wire Strip Length	
	Barrel A		Barrel B		Dimensions			Color Code		Die Index		Barrel A	Barrel B	
	AWG	mm ²	AWG	mm ²	Barrel A	Barrel B	L	Barrel A	Barrel B	Barrel A	Barrel B			
YSR312CFXLTCKITC	350 kcmil Code	185 mm ² Class 2	#2 AWG G,H,I,K,M DLO (150/24)	35 mm ²	1.49	0.82	3.37	Red	Brown	10	18	10	1.41	0.78
YSR314CFXLTCKITC †			#4 AWG G,H,I,K,M DLO (105/24)	-	1.49	0.74	3.43		Gray			8	1.41	0.71
YSR316CFXLTCKITC †			#6 AWG G,H,I,K,M DLO (61/24)	16 mm ²	1.49	0.73	3.58		Blue			7	1.41	0.70
YSR32FX29FXLTCKITC	300 kcmil G,H,I,K,M DLO (91/24)	185 mm ² Class 2	250 kcmil Flex 4/0 AWG G,H,I,K, DLO (550/24)	120 mm ²	1.57	1.44	3.50	Red	Yellow	19 or L80	16	1.48	1.38	
YSR32FX28FXLTCKITC			4/0 AWG G,H,I,K,M DLO (550/24)	120 mm ²	1.57	1.43	3.46		Purple			15	1.48	1.36
YSR29FX28LTCKITC	250 kcmil Flex 4/0 AWG G,H,I,K,M DLO (550/24)	120 mm ²	4/0 AWG Code	-	1.44	1.30	3.00	Yellow	Purple	16	15	1.38	1.24	
YSR29FX25FXLTCKITC			1/0 AWG G,H,I,K,M DLO (275/24)	50 mm ²	1.44	1.04	3.10		Pink			12	1.38	1.00
YSR29FX2CFXLTCKITC			#2 AWG G,H,I,K,M DLO (150/24)	35 mm ²	1.44	0.82	3.13		Brown			10	1.38	0.78
YSR2825FXLTCKITC	4/0 AWG Code	-	1/0 AWG G,H,I,K,M DLO (275/24)	50 mm ²	1.30	1.04	2.66	Purple	Pink	15	12	1.24	1.00	
YSR282CFXLTCKITC			#2 AWG G,H,I,K,M DLO (150/24)	35 mm ²	1.30	0.82	2.70		Brown			10	1.24	0.78
YSR284CFXLTCKITC †			#4 AWG G,H,I,K,M DLO (105/24)	-	1.30	0.74	2.69		Gray			8	1.24	0.71
YSR286CFXLTCKITC †			#6 AWG G,H,I,K,M DLO (61/24)	16 mm ²	1.30	0.73	2.99		Blue			7	1.24	0.70

† Provided with 2 heat shrink tubings. One will overlap the other; install the smaller first and larger over it.

Separate Installation Tooling Chart follows.

Compression Connections

Copper — Code / Flex — Reducing Splice Kit
Standard Barrel — with Inspection Window

TYPE YSR-TC (Continued)

HYREDUCER™ In-Line Standard Barrel Reducer
Splice Kits with Inspection Window

Connector with Clear Heat Shrink Kit

Clear heat shrink UL224 VW1 Listed. Passes TELCORDIA GR-347-CORE
Abrasion and Cut Test up to 750 kcmil Class B code cable; contact factory for
750 flex cable applications.

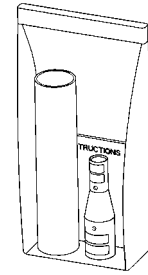

← Plastic Bag/Kit

Clear Heat Shrink Kit Catalog Number	Wire Size				Connector							Wire Strip Length	
	Barrel A		Barrel B		Dimensions			Color Code		Die Index		Barrel A	Barrel B
	AWG	mm ²	AWG	mm ²	Barrel A	Barrel B	L	Barrel A	Barrel B	Barrel A	Barrel B		
YSR28FX28LTCKITC	4/0 AWG G,H,I,K,M DLO (550/24) 4/0 AWG	120 mm ²	4/0 AWG Code	-	1.43	1.27	3.00	Purple	Purple	15	15	1.36	1.24
YSR28FX26FXLTCKITC			2/0 AWG G,H,I,K,M DLO (325/24) 2/0 AWG	70 mm ² Class 5	1.43	1.13	2.94		Black		13	1.36	1.19
YSR28FX25FXLTCKITC			1/0 AWG G,H,I,K,M DLO (275/24) 1/0 AWG	50 mm ²	1.43	1.02	3.07		Pink		12	1.36	1.00
YSR28FX2CFXLTCKITC			#2 AWG G,H,I,K,M DLO (150/24) #2 AWG	35 mm ²	1.43	0.79	3.11		Brown		10	1.36	0.78
YSR28FX4CFXLTCKITC †			#4 AWG G,H,I,K,M DLO (105/24)	-	1.43	0.74	3.10		Gray		8	1.36	0.71
YSR26FX25FXLTCKITC	2/0 AWG G,H,I,K,M DLO (325/24) 2/0 AWG	70 mm ²	1/0 AWG G,H,I,K,M DLO (275/24) 1/0 AWG	50 mm ²	1.16	1.04	2.36	Black	Pink	13	12	1.10	1.00
YSR26FX2CFXLTCKITC			#2 AWG G,H,I,K,M DLO (150/24) #2 AWG	35 mm ²	1.16	0.82	2.41		Brown		10	1.10	0.78
YSR26FX4CFXLTCKITC †			#4 AWG G,H,I,K,M DLO (105/24)	-	1.16	0.74	2.47	Black	Gray	13	8	1.10	0.71
YSR26FX6CFXLTCKITC †			#6 AWG G,H,I,K,M DLO (61/24) #6 AWG	16 mm ²	1.16	0.73	2.71		Blue		7	1.10	0.70
YSR25FX2CFXLTCKITC	1/0 AWG G,H,I,K,M DLO (275/24) 1/0 AWG	50 mm ²	#2 AWG G,H,I,K,M DLO (150/24) #2 AWG	35 mm ²	1.04	0.82	2.12	Pink	Brown	12	10	1.00	0.76
YSR25FX4CFXLTCKITC †			#4 AWG G,H,I,K,M DLO (105/24)	-	1.04	0.74	2.18		Gray		8	1.00	0.62
YSR25FX6CFXLTCKITC †			#6 AWG G,H,I,K,M DLO (61/24) #6 AWG	16 mm ²	1.04	0.63	2.42		Blue		7	1.00	0.61

† Provided with 2 heat shrink tubings. One will overlap the other; install the smaller first and larger over it.

Separate Installation Tooling Chart follows.

TYPE YSR-TC (Continued)

HYREDUCER™ In-Line Standard Barrel Reducer
Splice Kits with Inspection Window

Connector with Clear Heat Shrink Kit

Clear heat shrink UL224 VW1 Listed. Passes TELCORDIA GR-347-CORE
Abrasion and Cut Test up to 750 kcmil Class B code cable; contact factory for
750 flex cable applications.

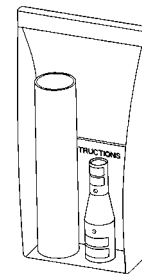

← Plastic Bag/Kit

Clear Heat Shrink Kit Catalog Number	Wire Size				Connector								Wire Strip Length	
	Barrel A		Barrel B		Dimensions			Color Code		Die Index		Barrel A	Barrel B	
	AWG	mm ²	AWG	mm ²	Barrel A	Barrel B	L	Barrel A	Barrel B	Barrel A	Barrel B			
YSR25FX8CFXLTKITC †	1/0 AWG G,H,I,K,M DLO (275/24) 1/0 AWG	50 mm ²	#8 AWG G,H,I,K,M DLO (37/24) #8 AWG #6 Sol #8 Sol	10 mm ² Str.-Flex	1.04	0.73	2.31	Pink	Red	12	49	1.01	.60	
YSR2CFX4CFXLTKITC	#2 AWG G,H,I,K,M DLO (150/24) #2 AWG	35 mm ²	#4 AWG G,H,I,K,M DLO (105/24)	-	0.82	0.74	1.79	Brown	Gray	10	8	0.78	0.63	
YSR2CFX6CFXLTKITC			#6 AWG G,H,I,K,M DLO (61/24) #6 AWG	16 mm ²	0.82	0.73	1.96		Blue		7	0.78	0.61	
YSR2CFX8CFXLTKITC			#8 AWG G,H,I,K,M DLO (37/24) #8 AWG #6 Sol #8 Sol	10 mm ²	0.82	0.60	1.79		Red		49	0.78	0.60	
YSR4CFX6CFXLTKITC	#4 AWG G,H,I,K,M DLO (105/24) #4 AWG	-	#6 AWG G,H,I,K,M DLO (61/24) #6 AWG	16 mm ²	0.74	0.73	1.67	Gray	Blue	8	7	0.71	0.61	
YSR4CFX8CFXLTKITC			#8 AWG G,H,I,K,M DLO (37/24) #8 AWG #6 Sol #8 Sol	10 mm ²	0.74	0.60	1.50		Red		49	0.71	0.60	
YSR4CFX10CLTKITC			#14 - #10 AWG I,K,M DLO (27/24)	6 mm ² Str. or 2.5 mm ² Flex	0.74	0.66	1.66		—		—	0.71	0.65	
YSR6CFX8CFXLTKITC	#6 AWG G,H,I,K,M DLO (61/24) #6 AWG	16 mm ²	#8 AWG G,H,I,K,M DLO (37/24) #8 AWG #6 Sol #8 Sol	10 mm ²	0.73	0.60	1.37	Blue	Red	7	49	0.70	0.57	
YSR6CFX10CLTKITC			#14 - #10 AWG I,K,M DLO (27/24)	6 mm ² Str. or 2.5 mm ² Flex	0.73	0.66	1.53		—		—	0.70	0.63	
YSR6CFX14CLTKITC			#14 - #10 AWG I,K,M DLO (27/24)	6 mm ² Str. or 2.5 mm ² Flex	0.73	0.66	1.53		—		—	.70	.63	

† Provided with 2 heat shrink tubings. One will overlap the other; install the smaller first and larger over it.

Separate Installation Tooling Chart follows.

Compression Connections

Copper — Code / Flex — Reducing Splice Kit
Standard Barrel — with Inspection Window

TYPE YSR-TC (Continued)

HYREDUCER™ In-Line Standard Barrel Reducer
Splice Kits with Inspection Window

Connector with Clear Heat Shrink Kit

Clear heat shrink UL224 VW1 Listed. Passes TELCORDIA GR-347-CORE
Abrasion and Cut Test up to 750 kcmil Class B code cable; contact factory for
750 flex cable applications.

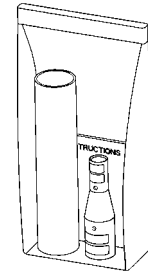

← Plastic Bag/Kit

Clear Heat Shrink Kit Catalog Number	Wire Size				Connector						Wire Strip Length		
	Barrel A		Barrel B		Dimensions			Color Code		Die Index		Barrel A	Barrel B
	AWG	mm ²	AWG	mm ²	Barrel A	Barrel B	L	Barrel A	Barrel B	Barrel A	Barrel B		
YSR8CFX10CLTCKITC	#8 AWG G,H,I,K,M DLO (37/24)	10 mm ²	#14 - #10 AWG I,K,M DLO (27/24)	6 mm ² Str. or 2.5 mm ² Flex	0.57	0.66	1.41	Red	—	49	—	0.57	0.63
YSR8CFX14CLTCKITC	#8 AWG #6 Sol #8 Sol		#14 - #10 AWG I,K,M DLO (27/24)	6 mm ² Str. or 2.5 mm ² Flex	0.57	0.66	1.41		—		—	0.57	0.63
YSR10CFX12CLTCKITC	#10 - #14 AWG I,K,M DLO (27/24)	6 mm ² Str. or 2.5 mm ² Flex	#14 - #10 AWG I,K,M #12 AWG Sol #10 AWG Sol DLO (27/24)	6 mm ² Str. or 2.5 mm ² Flex	0.66	0.66	1.45	—	—	—	—	0.63	0.63
YSR10CFX14CLTCKITC			#14 - #10 AWG I,K,M DLO (27/24)	6 mm ² Str. or 2.5 mm ² Flex	0.66	0.66	1.45		—		—	0.63	0.63

† Provided with 2 heat shrink tubings. One will overlap the other; install the smaller first and larger over it.

Separate Installation Tooling Chart follows.

TYPE YSR-TC (Continued)

INSTALLATION TOOLING CHART Standard Barrel with Inspection Window

Connector with Clear Heat Shrink Kit

Clear heat shrink UL224 VW1 Listed.
Passes TELCORDIA GR-347-CORE Abrasion and
Cut Test up to 750 kcmil Class B code cable; contact
factory for 750 flex cable applications.

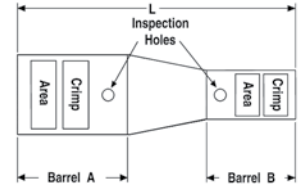

Clear Heat Shrink Kit Catalog Number	Wire Size				Connector				Installation Tooling											
	Barrel A		Barrel B		Color Code		Die Index		Hydraulic 750, 35, 46 Series		Hydraulic 500 Series		Mechanical OUR840, MD734		Dieless 644 Series, MY2911, MRC840					
	AWG	mm ²	AWG	mm ²	Barrel A	Barrel B	Barrel A	Barrel B	Barrel A	Barrel B	Barrel A	Barrel B	Barrel A	Barrel B	Barrel A	Barrel B				
YSR44FX39LTCKITC	750 kcmil G,H DLO 777 (1925/24)	500 mm ² Class 5	750 kcmil Code	-	Yellow	Black	24	L115	U44XRT (2)	U39RT (2) P39RT (2)	-	-	-	-	-	644 Series (1)				
YSR44FX38FLTCKITC			500 kcmil H,I,K 550 kcmil G,H,I DLO 535 (1325/24)	300 mm ²		Pink	L99			U38XRT (2)	-	-	-	-	-	-	-	-	-	644 Series (1)
YSR44FX34LTCKITC			500 kcmil Code	240 mm ²		Brown	20			U34RT (2)	W34VT (2) W34RT (2)	W34RT (2)	-	-	-	-	-	-	-	644 Series (1)
YSR44FX34FLTCKITC			350 kcmil G,H,I,K,M DLO 373 (925/24)	240 mm ²		Blue	19 or L80			U32RT (2)	W32VT (2) W32RT (2)	W32VT (2)	-	-	-	-	-	-	-	644 Series (1)
YSR44FX31LTCKITC			350 kcmil Code	185 mm ²		Red	18			U31RT (2)	W31VT (2) W31RT (2)	W31VT (2)	-	-	-	-	-	-	-	644 Series (1)
YSR44FX30LTCKITC			300 kcmil Code	150 mm ²		White	17 or 298			U30RT (2)	W30VT (2) W30RT (2)	W30VT (2)	-	-	-	-	-	-	-	644 Series (1)
YSR44FX29LTCKITC †			250 kcmil Code	-		Yellow	16			U29RT (1)	W29VT (2) W29RT (2) X29RT (4)	W29VT (2) X29RT (4)	-	-	-	-	-	-	-	644 Series (1)
YSR44FX29FLTCKITC †			250 kcmil Flex 4/0 AWG G,H,I,K,M DLO (550/24)	120 mm ²		Yellow	16			U29RT (1)	W29VT (2) W29RT (2) X29RT (4)	W29VT (2) X29RT (4)	-	-	-	-	-	-	-	644 Series (1)
YSR44FX28LTCKITC			4/0 AWG Code	-		Purple	15			U28RT (1)	W28VT (2) W28RT (2) X28RT (3)	W28VT (2) X28RT (3)	-	-	-	-	-	-	-	MY2911 (1) MRC840 (2) 644 Series (1)
YSR44FX28FLTCKITC †			4/0 AWG G,H,I,K,M DLO (550/24) 4/0 AWG	120 mm ²		Purple	15			U28RT (1)	W28VT (2) W28RT (2) X28RT (4)	W28VT (2) W28RT (2) X28RT (4)	-	-	-	-	-	-	-	MY2911 (1) MRC840 (2) 644 Series (1)
YSR3939LTCKITC	750 kcmil Code	-	750 kcmil Code	-	Black	Black	24	24	U39RT (2) P39RT (2)	U39RT (2) P39RT (2)	-	-	-	-	-	644 Series (1)				
YSR3938FLTCKITC			500 kcmil H,I,K 550 kcmil G,H,I DLO 535 (1325/24)	300 mm ²		Pink	L99			U38XRT (2)	-	-	-	-	-	-	-	-	644 Series (1)	
YSR3934LTCKITC			500 kcmil Code	240 mm ²		Brown	20			U34RT (2)	W34VT (2) W34RT (2)	W34VT (2)	-	-	-	-	-	-	644 Series (1)	
YSR3934FLTCKITC			250 kcmil G,H	240 mm ²		Blue	19 or L80			U32RT (2)	W32VT (2) W32RT (2)	W32VT (2)	-	-	-	-	-	-	644 Series (1)	
YSR3931LTCKITC			350 kcmil Code	185 mm ²		Red	18			U31RT (2)	W31VT (2) W31RT (2)	W31VT (2)	-	-	-	-	-	-	644 Series (1)	
YSR3930LTCKITC			300 kcmil Code	150 mm ²		White	17 or 298			U30RT (2)	W30VT (2) W30RT (2)	W30VT (2)	-	-	-	-	-	-	644 Series (1)	
YSR3929LTCKITC			250 kcmil Code	-		Yellow	16			U29RT (1)	W29VT (2) W29RT (2) X29RT (4)	W29VT (2) X29RT (4)	-	-	-	-	-	-	644 Series (1)	
YSR3929FLTCKITC †			250 kcmil Flex 4/0 AWG G,H,I,K,M DLO (550/24)	120 mm ²		Yellow	16			U29RT (1)	W29VT (2) W29RT (2) X29RT (4)	W29VT (2) X29RT (4)	-	-	-	-	-	-	644 Series (1)	
YSR3928LTCKITC †			4/0 AWG Code	-		Purple	15			U28RT (1)	W28VT (2) W28RT (2) X28RT (3)	W28VT (2) X28RT (3)	-	-	-	-	-	-	MY2911 (1) MRC840 (2) 644 Series (1)	
YSR3928FLTCKITC †			4/0 AWG G,H,I,K,M DLO (550/24) 4/0 AWG	120 mm ²		Purple	15			U28RT (1)	W28VT (2) W28RT (2) X28RT (4)	W28VT (2) W28RT (2) X28RT (4)	-	-	-	-	-	-	MY2911 (1) MRC840 (2) 644 Series (1)	

† Provided with 2 heat shrink tubings. One will overlap the other; install the smaller first and larger over it. * 46 Series require the PUADP1 adapter for U-Dies.

TYPE YSR-TC (Continued)

INSTALLATION TOOLING CHART Standard Barrel with Inspection Window

Connector with Clear Heat Shrink Kit

Clear heat shrink UL224 VW1 Listed.
Passes TELCORDIA GR-347-CORE Abrasion and
Cut Test up to 750 kcmil Class B code cable; contact
factory for 750 flex cable applications.

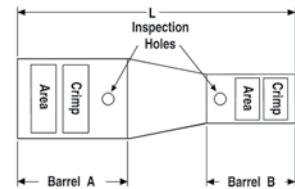

Clear Heat Shrink Kit Catalog Number	Wire Size				Connector				Installation Tooling																																																			
	Barrel A		Barrel B		Color Code		Die Index		Hydraulic 750, 35, 46" Series		Hydraulic 500 Series		Mechanical OUR840, MD734		Dieless 644 Series, MY2911, MRC840																																													
	AWG	mm ²	AWG	mm ²	Barrel A	Barrel B	Barrel A	Barrel B	Barrel A	Barrel B	Barrel A	Barrel B	Barrel A	Barrel B	Barrel A	Barrel B																																												
YSR38FX34LTCKITC	500 kcmil H,I,K 550 kcmil G,H,J DLO 535 (1325/24)	300 mm ²	500 kcmil Code	240 mm ²	Pink	Brown	L99	20	U34RT (2)	U34RT (2)	W34VT (2) W34RT (2)	W34VT (2)	644 Series (1)																																															
YSR38FX34FLTCKITC			350 kcmil G,H,I,K,M DLO 373 (925/24)	240 mm ²										Blue	19 or L80	U32RT (2)	W32VT (2) W32RT (2)	W32VT (2)	644 Series (1)																																									
YSR38FX31LTCKITC			350 kcmil Code	185 mm ²																Red	18	U31RT (2)	W31VT (2) W31RT (2)	W31VT (2)	644 Series (1)																																			
YSR38FX30LTCKITC			300 kcmil Code	150 mm ²																						White	17 or 298	U30RT (2)	W30VT (2) W30RT (2)	W30VT (2)	644 Series (1)																													
YSR38FX29LTCKITC †			250 kcmil Code	-																												Yellow	16	U29RT (1)	W29VT (2) W29RT (2) X29RT (4)	W29VT (2) X29RT (4)	644 Series (1)																							
YSR38FX29FLTCKITC †			250 kcmil Flex 4/0 AWG G,H,I,K,M DLO (550/24)	120 mm ²																																		Yellow	L99	16	U38XRT (2) U29RT (1)	W29VT (2) W29RT (2) X29RT (4)	W29VT (2) X29RT (4)	644 Series (1)	644 Series (1)															
YSR38FX28FLTCKITC †			4/0 AWG G,H,I,K,M DLO (550/24) 4/0 AWG	120 mm ²																																										Purple	15	U28RT (1)	W28VT (2) W28RT (2) X28RT (4)	W28VT (2) W28RT (2) X28RT (4)	MY2911 (1) MRC840 (2) 644 Series (1)									
YSR38FX28LTCKITC †			4/0 AWG Code	-																																																Purple	15	U28RT (1)	W28VT (2) W28RT (2) X28RT (3)	W28VT (2) W28RT (2) X28RT (3)	MY2911 (1) MRC840 (2) 644 Series (1)			
YSR38FX26FLTCKITC †			2/0 AWG G,H,I,K,M DLO (325/24) 2/0 AWG	70 mm ² Class 5																																																						Black	13	U26RT (1)
YSR3434FLTCKITC	500 kcmil Code	240 mm ²	350 kcmil G,H,I,K,M DLO 373 (925/24)	240 mm ²	Brown	Blue	19 or L80	U32RT (2)	U32RT (2)	W32VT (2) W32RT (2)	W32VT (2)	644 Series (1)																																																
YSR3431LTCKITC			350 kcmil Code	185 mm ²									Red	18	U31RT (2)	W31VT (2) W31RT (2)	W31VT (2)	644 Series (1)																																										
YSR3429FLTCKITC			250 kcmil Flex 4/0 AWG G,H,I,K,M DLO (550/24)	120 mm ²															Yellow	16	U29RT (1)	W29VT (2) W29RT (2) X29RT (4)	W29VT (2) X29RT (4)	644 Series (1)																																				
YSR3428LTCKITC			4/0 AWG Code	-																					Purple	20	15	U34RT (2) U31ART (2) U28RT (1)	W34VT (2) W34RT (2) W28VT (2) W28RT (2) X28RT (3)	W34VT (2)	644 Series (1)																													
YSR3426FLTCKITC †			2/0 AWG G,H,I,K,M DLO (325/24) 2/0 AWG	70 mm ² Class 5																												Black	13	U26RT (1)	W26VT (2) W26RT (2) X26RT (2)	W26VT (2) W26RT (2) X26RT (2)	MY2911 (1) 644 Series (1)																							
YSR3425FLTCKITC †			1/0 AWG G,H,I,K,M DLO (275/24) 1/0 AWG	50 mm ²																																		Pink	12	U25RT (1)	W25VT (2) W25RT (2) X25RT (2)	W25VT (2) W25RT (2) X25RT (2)	MY2911 (1) 644 Series (1)																	

† Provided with 2 heat shrink tubings. One will overlap the other; install the smaller first and larger over it. * 46 Series require the PUADP1 adapter for U-Dies.

TYPE YSR-TC (Continued)

INSTALLATION TOOLING CHART Standard Barrel with Inspection Window

Connector with Clear Heat Shrink Kit

Clear heat shrink UL224 VW1 Listed.
Passes TELCORDIA GR-347-CORE Abrasion and
Cut Test up to 750 kcmil Class B code cable; contact
factory for 750 flex cable applications.

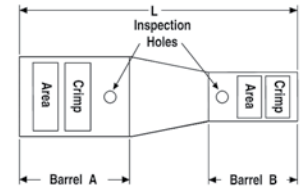

Clear Heat Shrink Kit Catalog Number	Wire Size				Connector				Installation Tooling												
	Barrel A		Barrel B		Color Code		Die Index		Hydraulic 750, 35, 46* Series		Hydraulic 500 Series		Mechanical OUR840, MD734		Dieless 644 Series, MY2911, MRC840						
	AWG	mm ²	AWG	mm ²	Barrel A	Barrel B	Barrel A	Barrel B	Barrel A	Barrel B	Barrel A	Barrel B	Barrel A	Barrel B	Barrel A	Barrel B					
YSR34FX31LTCKITC	350 kcmil G,H,I,K,M DLO 373 (925/24)	240 mm ²	350 kcmil Code	185 mm ²	Blue	Black	19 or L80	18	U32RT (2)	U31RT (2)	W31VT (2) W31RT (2)	W31VT (2)	W31VT (2)	644 Series (1)		644 Series (1)					
YSR34FX29FLTKITC			250 kcmil Flex 4/0 AWG G,H,I,K, DLO (550/24)	120 mm ²													16	U29RT (1)	W29VT (2) W29RT (2) X29RT (4)	W29VT (2) X29RT (4)	644 Series (1)
YSR34FX28FLTKITC			4/0 AWG G,H,I,K,M DLO (550/24) 4/0 AWG	120 mm ²													15	U28RT (1)	W28VT (2) W28RT (2) X28RT (3)	W28VT (2) W28RT (2) X28RT (2)	MY2911 (1) 644 Series (1)
YSR34FX28LTCKITC			4/0 AWG Code	-													15	U28RT (1)	W28VT (2) W28RT (2) X28RT (3)	W28VT (2) W28RT (2) X28RT (2)	MY2911 (1) MRC840 (2) 644 Series (1)
YSR34FX26FLTKITC			2/0 AWG G,H,I,K,M DLO (325/24) 2/0 AWG	70 mm ² Class 5													13	U26RT (1)	W26VT (2) W26RT (2) X26RT (2)	W26VT (2) W26RT (2) X26RT (2)	MY2911 (1) 644 Series (1)
YSR34FX25FLTKITC			1/0 AWG G,H,I,K,M DLO (275/24) 1/0 AWG	50 mm ²													12	U25RT (1)	W25VT (2) W25RT (2) X25RT (2)	W25VT (2) W25RT (2) X25RT (2)	MY2911 (1) 644 Series (1)
YSR34FX2CFXLTCKITC			#2 AWG G,H,I,K,M DLO (150/24) #2 AWG	35 mm ²													10	U2CRT (1)	W2CVT (1) W2CRT (1) X2CRT (1)	W2CVT (1) W2CRT (1) X2CRT (1)	YIMRTC (2) MY2911 (1) 644 Series (1)
YSR34FX4CFXLTCKITC †			#4 AWG G,H,I,K,M DLO (105/24)	-													8	U4CRT (1)	W4CVT (1) W4CRT (1) X4CRT (1)	W4CVT (1) W4CRT (1) X4CRT (1)	YIMRTC (2) MY2911 (1) 644 Series (1)
YSR34FX6CFXLTCKITC †			#6 AWG G,H,I,K,M DLO (61/24) #6 AWG	16 mm ²													7	U5CRT (1)	W5CVT (1) W5CRT (1) X5CRT (1)	W5CVT (1) W5CRT (1) X5CRT (1)	YIMRTC (1) MY2911 (1) 644 Series (1)
YSR3129FXLTCKITC	350 kcmil Code	185 mm ² Class 2	250 kcmil Flex 4/0 AWG G,H,I,K, DLO (550/24)	120 mm ²	Red		18	U31RT (2)	U29RT (1)	W31VT (2) W31RT (2)	W31VT (2)	W31VT (2)	644 Series (1)		644 Series (1)						
YSR3128FXLTCKITC			4/0 AWG G,H,I,K,M DLO (550/24) 4/0 AWG	120 mm ²												15	U28RT (1)	W28VT (2) W28RT (2) X28RT (4)	W28VT (2) W28RT (2) X28RT (4)	MY2911 (1) MRC840 (2) 644 Series (1)	
YSR3128LTCKITC	350 kcmil Code	185 mm ² Class 2	4/0 AWG Code	-	Red		18	U31RT (2)	U28RT (1)	W31VT (2) W31RT (2)	W31VT (2)	W31VT (2)	644 Series (1)		644 Series (1)						
YSR3126FXLTCKITC			2/0 AWG G,H,I,K,M DLO (325/24) 2/0 AWG	70 mm ² Class 5												13	U26RT (1)	W26VT (2) W26RT (2) X26RT (2)	W26VT (2) W26RT (2) X26RT (2)	MY2911 (1) 644 Series (1)	
YSR3125FXLTCKITC			1/0 AWG G,H,I,K,M DLO (275/24) 1/0 AWG	50 mm ²												12	U25RT (1)	W25VT (2) W25RT (2) X25RT (2)	W25VT (2) W25RT (2) X25RT (2)	MY2911 (1) 644 Series (1)	
YSR312CFXLTCKITC			#2 AWG G,H,I,K,M DLO (150/24) #2 AWG	35 mm ²												10	U2CRT (1)	W2CVT (1) W2CRT (1) X2CRT (1)	W2CVT (1) W2CRT (1) X2CRT (1)	YIMRTC (2) MY2911 (1) 644 Series (1)	
YSR314CFXLTCKITC †			#4 AWG G,H,I,K,M DLO (105/24)	-												8	U4CRT (1)	W4CVT (1) W4CRT (1) X4CRT (1)	W4CVT (1) W4CRT (1) X4CRT (1)	YIMRTC (2) MY2911 (1) 644 Series (1)	
YSR316CFXLTCKITC †			#6 AWG G,H,I,K,M DLO (61/24) #6 AWG	16 mm ²												7	U5CRT (1)	W5CVT (1) W5CRT (1) X5CRT (1)	W5CVT (1) W5CRT (1) X5CRT (1)	YIMRTC (1) MY2911 (1) 644 Series (1)	

† Provided with 2 heat shrink tubings. One will overlap the other; install the smaller first and larger over it. * 46 Series require the PUADP1 adapter for U-Dies.

Compression Connections

Copper — Code / Flex — Reducing Splice Kit
Standard Barrel — with Inspection Window

TYPE YSR-TC (Continued)

INSTALLATION TOOLING CHART Standard Barrel with Inspection Window

Connector with Clear Heat Shrink Kit

Clear heat shrink UL224 VW1 Listed.
Passes TELCORDIA GR-347-CORE Abrasion and
Cut Test up to 750 kcmil Class B code cable; contact
factory for 750 flex cable applications.

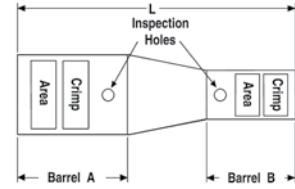

Clear Heat Shrink Kit Catalog Number	Wire Size				Connector				Installation Tooling													
	Barrel A		Barrel B		Color Code		Die Index		Hydraulic 750, 35, 46* Series		Hydraulic 500 Series		Mechanical OUR840, MD734		Dieless 644 Series, MY2911, MRC840							
	AWG	mm ²	AWG	mm ²	Barrel A	Barrel B	Barrel A	Barrel B	Barrel A	Barrel B	Barrel A	Barrel B	Barrel A	Barrel B	Barrel A	Barrel B						
YSR32FX29FXLTCKITC	300 kcmil G,H,I,K,M DLO (91/24)	185 mm ² Class 2	250 kcmil Flex 4/0 AWG G,H,I,K, DLO (550/24)	120 mm ²	Red	Yellow	19 or L80	16	U31RT (2)	U29RT (1)	W31VT (2) W31RT (2)	W29VT (2) W29RT (2) X29RT (4)	W31VT (2)	W29VT (2) X29RT (4)	644 Series (1)	644 Series (1)						
YSR32FX28FXLTCKITC			4/0 AWG G,H,I,K,M DLO (550/24) 4/0 AWG	120 mm ²													Purple	15	U28RT (1)	W28VT (2) W28RT (2) X28RT (3)	W28VT (2) W28RT (2) X28RT (3)	MY2911 (1) 644 Series (1)
YSR29FX28LTCKITC	250 kcmil Flex 5/0 AWG G,H,I,K,M DLO (550/24)	120 mm ²	4/0 AWG Code	-	Yellow	Pink	16	12	U29RT (1)	U28RT (1)	W29VT (2) W29RT (2) X29RT (4)	W28VT (2) W28RT (2) X28RT (3)	W29VT (2) X29RT (4)	W25VT (2) W25RT (2) X25RT (2)	644 Series (1)	MY2911 (1) MRC840 (2) 644 Series (1)						
YSR29FX25FXLTCKITC			1/0 AWG G,H,I,K,M DLO (275/24) 1/0 AWG	50 mm ²													Brown	10	U25RT (1)	W25VT (2) W25RT (2) X25RT (2)	W25VT (2) W25RT (2) X25RT (2)	MY2911 (1) 644 Series (1)
YSR29FX2CFXLTCKITC			#2 AWG G,H,I,K,M DLO (150/24) #2 AWG	35 mm ²													Brown	10	U2CRT (1)	W2CVT (1) W2CRT (1) X2CRT (1)	W2CVT (1) W2CRT (1) X2CRT (1)	YIMRTC (2) MY2911 (1) 644 Series (1)
YSR2825FXLTCKITC	4/0 AWG Code	-	1/0 AWG G,H,I,K,M DLO (275/24) 1/0 AWG	50 mm ²	Purple	Pink	15	10	U28RT (1)	U25RT (1)	W25VT (2) W25RT (2) X25RT (2)	W28VT (2) W28RT (2) X28RT (3)	W25VT (2) W25RT (2) X25RT (2)	MY2911 (1) MRC840 (2) 644 Series (1)	MY2911 (1) 644 Series (1)							
YSR282CFXLTCKITC			#2 AWG G,H,I,K,M DLO (150/24) #2 AWG	35 mm ²												Brown	10	U2CRT (1)	W2CVT (1) W2CRT (1) X2CRT (1)	W2CVT (1) W2CRT (1) X2CRT (1)	YIMRTC (2) MY2911 (1) 644 Series (1)	
YSR284CFXLTCKITC †			#4 AWG G,H,I,K,M DLO (105/24)	-												Gray	8	U4CRT (1)	W4CVT (1) W4CRT (1) X4CRT (1)	W4CVT (1) W4CRT (1) X4CRT (1)	YIMRTC (2) MY2911 (1) 644 Series (1)	
YSR286CFXLTCKITC †			#6 AWG G,H,I,K,M DLO (61/24) #6 AWG	16 mm ²												Blue	7	U5CRT (1)	W5CVT (1) W5CRT (1) X5CRT (1)	W5CVT (1) W5CRT (1) X5CRT (1)	YIMRTC (1) MY2911 (1) 644 Series (1)	
YSR28FX28LTCKITC	4/0 AWG G,H,I,K,M DLO (550/24) 4/0 AWG	120 mm ²	4/0 AWG Code	-	Purple	Black	15	13	U28RT (1)	U28RT (1)	W28VT (2) W28RT (2) X28RT (3)	W28VT (2) W28RT (2) X28RT (3)	W28VT (2) W28RT (2) X28RT (3)	MY2911 (1) MRC840 (2) 644 Series (1)	MY2911 (1) 644 Series (1)							
YSR28FX26FXLTCKITC			2/0 AWG G,H,I,K,M DLO (325/24) 2/0 AWG	70 mm ² Class 5												Pink	12	U25RT (1)	W25VT (2) W25RT (2) X25RT (2)	W25VT (2) W25RT (2) X25RT (2)	MY2911 (1) 644 Series (1)	
YSR28FX25FXLTCKITC			1/0 AWG G,H,I,K,M DLO (275/24) 1/0 AWG	50 mm ²												Pink	12	U25RT (1)	W25VT (2) W25RT (2) X25RT (2)	W25VT (2) W25RT (2) X25RT (2)	MY2911 (1) 644 Series (1)	
YSR28FX2CFXLTCKITC	4/0 AWG Flex or Telco Flex	120 mm ²	#2 AWG G,H,I,K,M DLO (150/24) #2 AWG	35 mm ²	Purple	Brown	15	10	U28RT (1)	U2CRT (1)	W28VT (2) W28RT (2) X28RT (3)	W2CVT (1) W2CRT (1) X2CRT (1)	W28VT (2) W28RT (2) X28RT (3)	MY2911 (1) MRC840 (2) 644 Series (1)	YIMRTC (2) MY2911 (1) 644 Series (1)							
YSR28FX4CFXLTCKITC †			#4 AWG G,H,I,K,M DLO (105/24)	-												Gray	8	U4CRT (1)	W4CVT (1) W4CRT (1) X4CRT (1)	W4CVT (1) W4CRT (1) X4CRT (1)	YIMRTC (2) MY2911 (1) 644 Series (1)	

† Provided with 2 heat shrink tubings. One will overlap the other; install the smaller first and larger over it. * 46 Series require the PUADP1 adapter for U-Dies.

TYPE YSR-TC (Continued)

INSTALLATION TOOLING CHART Standard Barrel with Inspection Window

Connector with Clear Heat Shrink Kit

Clear heat shrink UL224 VW1 Listed.
Passes TELCORDIA GR-347-CORE Abrasion and
Cut Test up to 750 kcmil Class B code cable; contact
factory for 750 flex cable applications.

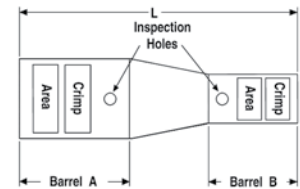

Clear Heat Shrink Kit Catalog Number	Wire Size				Connector				Installation Tooling								
	Barrel A		Barrel B		Color Code		Die Index		Hydraulic 750, 35, 46* Series		Hydraulic 500 Series		Mechanical OUR840, MD734		Dieless 644 Series, MY2911, MRC840		
	AWG	mm ²	AWG	mm ²	Barrel A	Barrel B	Barrel A	Barrel B	Barrel A	Barrel B	Barrel A	Barrel B	Barrel A	Barrel B	Barrel A	Barrel B	
YSR26FX25FLTKITC	2/0 AWG G,H,I,K,M DLO (325/24) 2/0 AWG	70 mm ²	1/0 AWG G,H,I,K,M DLO (275/24) 1/0 AWG	50 mm ²	Pink		12		U25RT (1)	W25VT (2) W25RT (2) X25RT (2)	W25VT (2) W25RT (2) X25RT (2)	W25VT (2) W25RT (2) X25RT (2)		MY2911 (1) 644 Series (1)			
YSR26FX2CFXLTCKITC			#2 AWG G,H,I,K,M DLO (150/24) #2 AWG	35 mm ²	Black	Brown	13	10	U26RT (1)	U2CRT (1)	W26VT (2) W26RT (2) X26RT (2)	W26VT (2) W26RT (2) X26RT (2)	W26VT (2) W26RT (2) X26RT (2)	W26VT (1) W26RT (1) X26RT (1)	MY2911 (1) 644 Series (1)	MY2911 (1) 644 Series (1)	
YSR26FX4CFXLTCKITC †			#4 AWG G,H,I,K,M DLO (105/24)	-	Gray				8		U4CRT (1)	W4CVT (1) W4CRT (1) X4CRT (1)	W4CVT (1) W4CRT (1) X4CRT (1)	W4CVT (1) W4CRT (1) X4CRT (1)	W4CVT (1) W4CRT (1) X4CRT (1)	Y1MRTC (2) MY2911 (1) 644 Series (1)	
YSR26FX6CFXLTCKITC †			#6 AWG G,H,I,K,M DLO (61/24) #6 AWG	16 mm ²	Blue				7		U5CRT (1)	W5CVT (1) W5CRT (1) X5CRT (1)	W5CVT (1) W5CRT (1) X5CRT (1)	W5CVT (1) W5CRT (1) X5CRT (1)	W5CVT (1) W5CRT (1) X5CRT (1)	Y1MRTC (1) MY2911 (1) 644 Series (1)	
YSR25FX2CFXLTCKITC	1/0 AWG G,H,I,K,M DLO (275/24) 1/0 AWG	50 mm ²	#2 AWG G,H,I,K,M DLO (150/24) #2 AWG	35 mm ²		Brown		10		U2CRT (1)	W2CVT (1) W2CRT (1) X2CRT (1)	W2CVT (1) W2CRT (1) X2CRT (1)	W2CVT (1) W2CRT (1) X2CRT (1)		MY2911 (1) 644 Series (1)		
YSR25FX4CFXLTCKITC †			#4 AWG G,H,I,K,M DLO (105/24)	-	Gray			8		U4CRT (1)	W4CVT (1) W4CRT (1) X4CRT (1)	W4CVT (1) W4CRT (1) X4CRT (1)	W4CVT (1) W4CRT (1) X4CRT (1)	W4CVT (1) W4CRT (1) X4CRT (1)	Y1MRTC (2) MY2911 (1) 644 Series (1)		
YSR25FX6CFXLTCKITC †			#6 AWG G,H,I,K,M DLO (61/24) #6 AWG	16 mm ²	Pink	Blue	12	7		U25RT (1)	U5CRT (1)	W25VT (2) W25RT (2) X25RT (2)	W25VT (2) W25RT (2) X25RT (2)	W25VT (1) W25RT (1) X25RT (1)	W25VT (1) W25RT (1) X25RT (1)	MY2911 (1) 644 Series (1)	Y1MRTC (1) MY2911 (1) 644 Series (1)
YSR25FX8CFXLTCKITC †			#8 AWG G,H,I,K,M DLO (37/24) #8 AWG #6 Sol #8 Sol	10 mm ² Str-Flex		Red			-		U8CRT (1)	W8CVT (1) W8CRT (1) X8CRT (1)	W8CVT (1) W8CRT (1) X8CRT (1)	W8CVT (1) W8CRT (1) X8CRT (1)	W8CVT (1) W8CRT (1) X8CRT (1)	Y8MRB1 (1) Y1MRTC (1) MY293 (1) MY2911 (1)	
YSR2CFX4CFXLTCKITC	#2 AWG G,H,I,K,M DLO (150/24) #2 AWG	35 mm ²	#4 AWG G,H,I,K,M DLO (105/24)	-	Gray		8		U4CRT (1)	W4CVT (1) W4CRT (1) X4CRT (1)	W4CVT (1) W4CRT (1) X4CRT (1)	W4CVT (1) W4CRT (1) X4CRT (1)	W4CVT (1) W4CRT (1) X4CRT (1)	Y1MRTC (2) MY2911 (1) 644 Series (1)	Y1MRTC (2) MY2911 (1) 644 Series (1)		
YSR2CFX6CFXLTCKITC			#6 AWG G,H,I,K,M DLO (61/24) #6 AWG	16 mm ²	Brown	Blue	10	7	U2CRT (1)	U5CRT (1)	W2CVT (1) W2CRT (1) X2CRT (1)	W2CVT (1) W2CRT (1) X2CRT (1)	W2CVT (1) W2CRT (1) X2CRT (1)	W2CVT (1) W2CRT (1) X2CRT (1)	Y1MRTC (2) MY2911 (1) 644 Series (1)	Y1MRTC (2) MY2911 (1) 644 Series (1)	
YSR2CFX8CFXLTCKITC			#8 AWG G,H,I,K,M DLO (37/24) #8 AWG #6 Sol #8 Sol	10 mm ²		Red			49		U8CRT (1)	W8CVT (1) W8CRT (1) X8CRT (1)	W8CVT (1) W8CRT (1) X8CRT (1)	W8CVT (1) W8CRT (1) X8CRT (1)	W8CVT (1) W8CRT (1) X8CRT (1)	Y8MRB1 (1) Y1MRTC (2) MY293 (1) MY2911 (1)	
YSR4CFX6CFXLTCKITC	#4 AWG G,H,I,K,M DLO (105/24) #4 AWG	-	#6 AWG G,H,I,K,M DLO (61/24) #6 AWG	16 mm ²	Gray	Blue	8	7	U4CRT (1)	U5CRT (1)	W4CVT (1) W4CRT (1) X4CRT (1)	W5CVT (1) W5CRT (1) X5CRT (1)	W4CVT (1) W4CRT (1) X4CRT (1)	W5CVT (1) W5CRT (1) X5CRT (1)	Y1MRTC (2) MY2911 (1) 644 Series (1)	Y1MRTC (1) MY2911 (1) 644 Series (1)	
YSR4CFX8CFXLTCKITC			#8 AWG G,H,I,K,M DLO (37/24) #8 AWG #6 Sol #8 Sol	10 mm ²		Red		49		U8CRT (1)	U8CRT (1)	W8CVT (1) W8CRT (1) X8CRT (1)	W8CVT (1) W8CRT (1) X8CRT (1)	W8CVT (1) W8CRT (1) X8CRT (1)	W8CVT (1) W8CRT (1) X8CRT (1)	Y8MRB1 (1) Y1MRTC (2) MY293 (1) MY2911 (1)	
YSR4CFX10CLTCKITC			#14 - #10 AWG I,K,M DLO (27/24)	6 mm ² Str or 2.5 mm ² Flex					-			W4CVT (1) W4CRT (1) X4CRT (1)	-	W4CVT (1) W4CRT (1) X4CRT (1)	-	Y8MRB1 (2) MRC98 (2) Y10D (2)	

† Provided with 2 heat shrink tubings. One will overlap the other; install the smaller first and larger over it. * 46 Series require the PUADP1 adapter for U-Dies.

TYPE YSR-TC (Continued)

INSTALLATION TOOLING CHART Standard Barrel with Inspection Window

Connector with Clear Heat Shrink Kit

Clear heat shrink UL224 VW1 Listed.
Passes TELCORDIA GR-347-CORE Abrasion and
Cut Test up to 750 kcmil Class B code cable; contact
factory for 750 flex cable applications.

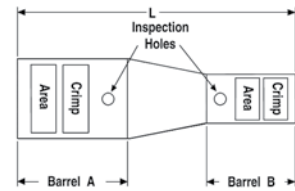

Clear Heat Shrink Kit Catalog Number	Wire Size				Connector				Installation Tooling							
	Barrel A		Barrel B		Color Code		Die Index		Hydraulic 750, 35, 46 [†] Series		Hydraulic 500 Series		Mechanical OUR840, MD734		Dieless 644 Series, MY2911, MRC840	
	AWG	mm ²	AWG	mm ²	Barrel A	Barrel B	Barrel A	Barrel B	Barrel A	Barrel B	Barrel A	Barrel B	Barrel A	Barrel B	Barrel A	Barrel B
YSR6CFX8CFXLTCKITC	#6 AWG G,H,I,K,M DLO (61/24) #6 AWG	16 mm ²	#8 AWG G,H,I,K,M DLO (37/24) #8 AWG #6 Sol #8 Sol	10 mm ²	Red		49		U8CRT (1)		W8CVT (1) W8CRT (1) X8CRT (1)		W8CVT (1) W8CRT (1) X8CRT (1)		Y8MRB1 (1) Y1MRTC (1) MY2931 (1) MY2911 (1)	
YSR6CFX10CLTCKITC			#14 - #10 AWG I,K,M DLO (27/24)	6 mm ² Str. or 2.5 mm ² Flex	Blue		7		U5CRT (1)		W5CVT (1) W5CRT (1) X5CRT (1)		W5CVT (1) X5CRT (1)		Y1MRTC (1) MY2911 (1)	Y8MRB1 (2) MRG98 (2) Y10D (2)
YSR6CFX14CLTCKITC			#14 - #10 AWG I,K,M DLO (27/24)	6 mm ² Str. or 2.5 mm ² Flex												
YSR8CFX10CLTCKITC	#8 AWG G,H,I,K,M DLO (37/24) #8 AWG #6 Sol #8 Sol	10 mm ²	#14 - #10 AWG I,K,M DLO (27/24)	6 mm ² Str. or 2.5 mm ² Flex	Red		49		U8CRT (1)		W8CVT (1) W8CRT (1) X8CRT (1)		W8CVT (1) W8CRT (1) X8CRT (1)		Y8MRB1 (1) Y1MRTC (1) MY2931 (1) MY2911 (1)	Y8MRB1 (2) MRG98 (2) Y10D (2)
YSR8CFX14CLTCKITC			#14 - #10 AWG I,K,M DLO (27/24)	6 mm ² Str. or 2.5 mm ² Flex												Y8MRB1 (2) MRG98 (2) Y10D (2)
YSR10CFX12CLTCKITC	#10 - #14 AWG I,K,M DLO (27/24)	6 mm ² Str. or 2.5 mm ² Flex	#14 - #10 AWG I,K,M #12 AWG Sol #10 AWG Sol DLO (27/24)	6 mm ² Str. or 2.5 mm ² Flex											Y8MRB1 (2) MRG98 (2) Y10D (2)	
YSR10CFX14CLTCKITC			#14 - #10 AWG I,K,M DLO (27/24)	6 mm ² Str. or 2.5 mm ² Flex												Y8MRB1 (2) MRG98 (2) Y10D (2)

† Provided with 2 heat shrink tubings. One will overlap the other; install the smaller first and larger over it.

* 46 Series require the PUADP1 adapter for U-Dies.

TYPE YSR-TC

HYREDUCER™ In-Line Reducer Splice Kits Standard Barrel, No Inspection Window

Type YSR-TC reducing splice kits provide for splicing two different cable sizes without inspection holes. The larger conductor is inserted first and butts against the center of the connector where the smaller barrel begins. Constructed from seamless, high conductivity electrolytic copper tubing for maximum conductivity and tin plated to resist corrosion. The YSR-TC family also features the BURNDY® color code system.

Features & Benefits

- Each splice kit includes one YSR-TC compression in-line splice reducer connector and heat shrink
- The YSR-TC type reducing compression splice connector provided in the kit is UL Listed in accordance with UL 486A-486B - Wire Connectors; UL Listed 90°C up to 35kV
- No inspection window for more corrosive environments as the barrel transition is not open
- Designed configurations allow for copper code-to-code wire connections, copper code-to-flex wire connections, and copper flex-to-flex wire connections; see table for more complete details
- Barrel is designed with a taper to accommodate a main run wire that is reduced to a smaller tap wire
- Barrel also provided with an internal chamfer at the wire entry to ensure smooth insertion of the wire, preventing possible damaging of the wire strands during insertion
- Electro-tin plated unless otherwise specified to reduce galvanic corrosion (bimetallic) and resist corrosive elements
- Short/standard length barrel is recommended for installations with limited space requirements and meet the exact UL testing requirements as long barrel connectors so performance of the connection is not compromised
- Connectors clearly marked with color coding
- Can be used in place of H-taps; the in-line design saves space in cable trays and other similar applications

Accessories

- Hardware - Section F
- PENETROX™ Oxide Inhibitor - Section F
- Heat and Cold Shrink Tubing - Section D
- WIREMIKE™ Wire Micrometer - Section F
- Wire Management (Cable Ties) - Section G

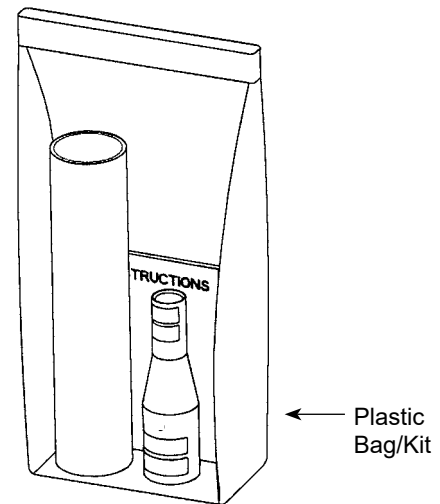

Connector with Clear Heat Shrink Kit

Clear heat shrink UL224 VW1 Listed. Passes TELCORDIA GR-347-CORE Abrasion and Cut Test up to 750 kcmil Class B code cable; contact factory for 750 flex cable applications.

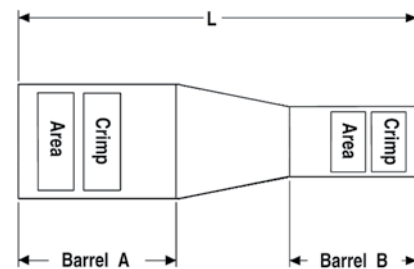

Compression Connections

Copper — Code / Flex — Reducing Splice Kit
Standard Barrel — No Inspection Window

TYPE YSR-TC (Continued)

HYREDUCER™ In-Line Standard Barrel Reducer
Splice Kits, No Inspection Window

Connector with Clear Heat Shrink Kit

Clear heat shrink UL224 VW1 Listed. Passes TELCORDIA GR-347-CORE
Abrasion and Cut Test up to 750 kcmil Class B code cable; contact factory for
750 flex cable applications.

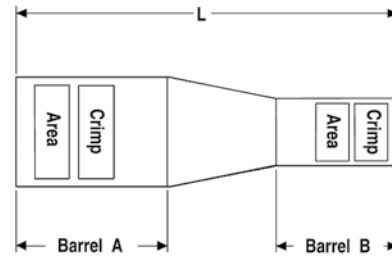

Clear Heat Shrink Kit Catalog Number	Wire Size				Connector								Wire Strip Length	
	Barrel A		Barrel B		Dimensions			Color Code		Die Index			Barrel A	Barrel B
	AWG	mm ²	AWG	mm ²	Barrel A	Barrel B	L	Barrel A	Barrel B	Barrel A	Barrel B			
YSR44FX38FXLKITC	750 kcmil G,H DLO 777 (1925/24)	500 mm ² Class 5	500 kcmil H,I,K 550 kcmil G,H,I DLO 535 (1325/24)	300 mm ²	2.09	1.69	4.61	Yellow	Pink	L115	L99	1.96	1.77	
YSR44FX34FXLKITC			350 kcmil G,H,I,K,M DLO 373 (925/24)	240 mm ²	2.09	1.69	4.91		Blue					19 or L80
YSR44FX29FXLKITC †			250 kcmil Flex 4/0 AWG G,H,I,K,M DLO (550/24)	-	2.09	1.44	5.33		Yellow					16
YSR3938FXLKITC	750 kcmil Code	-	500 kcmil H,I,K 550 kcmil G,H,I DLO 535 (1325/24)	300 mm ²	1.78	1.88	3.79	Black	Pink	24	L99	1.67	1.77	
YSR3934FXLKITC			350 kcmil G,H,I,K,M DLO 373 (925/24)	240 mm ²	1.78	1.69	4.09		Blue					19 or L80
YSR3929FXLKITC			250 kcmil Flex 4/0 AWG G,H,I,K,M DLO (550/24)	-	1.78	1.44	4.51		Yellow					16
YSR38FX34FXLKITC	500 kcmil H,I,K 550 kcmil G,H,I DLO 535 (1325/24)	300 mm ²	350 kcmil G,H,I,K,M DLO 373 (925/24)	240 mm ²	1.88	1.69	4.06	Pink	Blue	L99	19 or L80	1.77	1.60	
YSR38FX29FXLKITC †			250 kcmil Flex 4/0 AWG G,H,I,K,M DLO (550/24)	-	1.88	1.44	4.48		Yellow					16
YSR3434FXLKITC	500 kcmil Code	240 mm ²	350 kcmil G,H,I,K,M DLO 373 (925/24)	240 mm ²	1.69	1.69	3.51	Brown	Blue	20	19 or L80	1.60	1.60	
YSR3429FXLKITC			250 kcmil Flex 4/0 AWG G,H,I,K,M DLO (550/24)	-	1.69	1.44	3.81		Yellow					16
YSR34FX29FXLKITC	350 kcmil G,H,I,K,M DLO 373 (925/24)	240 mm ²	250 kcmil Flex 4/0 AWG G,H,I,K,M DLO (550/24)	-	1.69	1.44	3.81	Blue	Yellow	19 or L80	16	1.60	1.38	
YSR3129FXLKITC	350 kcmil Code	185 mm ²	250 kcmil Flex 4/0 AWG G,H,I,K,M DLO (550/24)	-	1.49	1.44	3.13	Red	Yellow	18	16	2.34	2.29	

† Provided with 2 heat shrink tubings. One will overlap the other; install the smaller first and larger over it.

Separate Installation Tooling Chart follows.

TYPE YSR-TC (Continued)

INSTALLATION TOOLING CHART Standard Barrel No Inspection Window

Connector with Clear Heat Shrink Kit

Clear heat shrink UL224 VW1 Listed.
Passes TELCORDIA GR-347-CORE Abrasion and
Cut Test up to 750 kcmil Class B code cable; contact
factory for 750 flex cable applications.

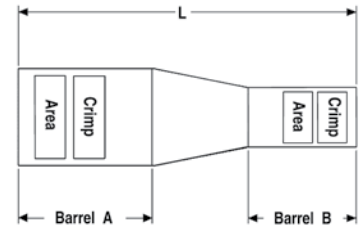

Clear Heat Shrink Kit Catalog Number	Wire Size				Connector				Installation Tooling																	
	Barrel A		Barrel B		Color Code		Die Index		Hydraulic		Hydraulic		Mechanical		Dieless											
	AWG	mm ²	AWG	mm ²	Barrel A	Barrel B	Barrel A	Barrel B	750, 35, 46 [*] Series		500 Series		OUR840, MD734		644 Series											
									Barrel A	Barrel B	Barrel A	Barrel B	Barrel A	Barrel B	Barrel A	Barrel B										
YSR44FX38FXLKITC	750 kcmil G,H DLO 777 (1925/24)	500 mm ² Class 5	500 kcmil H,I,K 550 kcmil G,H,I DLO 535 (1325/24)	300 mm ²	Yellow	Pink	L99	-	-	-	-	-	-	-	-	-										
YSR44FX34FXLKITC			350 kcmil G,H,I,K,M DLO 373 (925/24)	240 mm ²													Blue	L115	19 or L80	U44XRT (2) P44XRT (2)	U34RT (2)	-	W34VT (2) W34RT (2)	-	W34VT (2)	644 Series (1)
YSR44FX29FXLKITC †			250 kcmil Flex 4/0 AWG G,H,I,K,M DLO (550/24)	-													Yellow	16	U29RT (2)	U29RT (2)	W29VT (2) W29RT (2) X29RT (4)	W29VT (2) X29RT (4)				
YSR3938FXLKITC	750 kcmil Code	-	500 kcmil H,I,K 550 kcmil G,H,I DLO 535 (1325/24)	300 mm ²	Black	Pink	L99	-	-	-	-	-	-	-	-	-										
YSR3934FXLKITC			350 kcmil G,H,I,K,M DLO 373 (925/24)	240 mm ²													Blue	24	19 or L80	U39RT (2) P39RT (2)	U32RT (2)	-	W32VT (2) W32RT (2)	-	W32VT (2)	644 Series (1)
YSR3929FXLKITC			250 kcmil Flex 4/0 AWG G,H,I,K,M DLO (550/24)	-													Black	Yellow	16	U29RT (2)	U29RT (2)	W29VT (2) W29RT (2) X29RT (4)	W29VT (2) X29RT (4)			
YSR38FX34FXLKITC	500 kcmil H,I,K 550 kcmil G,H,I DLO 535 (1325/24)	300 mm ²	350 kcmil G,H,I,K,M DLO 373 (925/24)	240 mm ²	Pink	Blue	L99	19 or L80	U38XRT (2)	U32RT (2)	-	-	-	-	-	-										
YSR38FX29FXLKITC †			250 kcmil Flex 4/0 AWG G,H,I,K,M DLO (550/24)	-													Yellow	16	U29RT (2)	U29RT (2)	W29VT (2) W29RT (2) X29RT (4)	W29VT (2) X29RT (4)				

† Provided with 2 heat shrink tubings. One will overlap the other; install the smaller first and larger over it.

* 46 Series require the PUADP1 adapter for U-Dies.
• P-RT for use in 46 Series tools only.

TYPE YSR-TC (Continued)

INSTALLATION TOOLING CHART Standard Barrel No Inspection Window

Connector with Clear Heat Shrink Kit

Clear heat shrink UL224 VW1 Listed.
Passes TELCORDIA GR-347-CORE Abrasion and
Cut Test up to 750 kcmil Class B code cable; contact
factory for 750 flex cable applications.

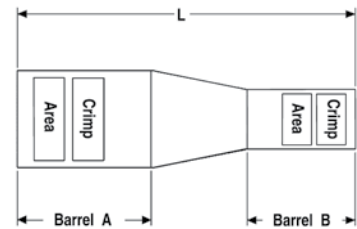

Clear Heat Shrink Kit Catalog Number	Wire Size				Connector				Installation Tooling							
	Barrel A		Barrel B		Color Code		Die Index		Hydraulic		Hydraulic		Mechanical		Dieless	
	AWG	mm ²	AWG	mm ²	Barrel A	Barrel B	Barrel A	Barrel B	750, 35, 46* Series		500 Series		OUR840, MD734		644 Series	
									Barrel A	Barrel B	Barrel A	Barrel B	Barrel A	Barrel B	Barrel A	Barrel B
YSR3434FXLKITC	500 kcmil Code	240 mm ²	350 kcmil G,H,I,K,M DLO 373 (925/24)	240 mm ²	Brown	Blue	20	19 or L80	U34RT (2) U31ART (2)	U32RT (2)	W34VT (2) W34RT (2)	W32VT (2) W32RT (2)	W34VT (2)	W32VT (2)	644 Series (1)	
YSR3429FXLKITC			250 kcmil Flex 4/0 AWG G,H,I,K,M DLO (550/24)	-												Yellow
YSR34FX29FXLKITC	350 kcmil G,H,I,K,M DLO 373 (925/24)	240 mm ²	250 kcmil Flex 4/0 AWG G,H,I,K,M DLO (550/24)	-	Blue	Yellow	19 or L80	16	U32RT (2)	U29RT (2)	W32VT (2) W32RT (2)	W29VT (2) W29RT (2) X29RT (4)	W32VT (2)	W29VT (2) X29RT (4)	644 Series (1)	
YSR3129FXLKITC	350 kcmil Code	185 mm ²	250 kcmil Flex 4/0 AWG G,H,I,K,M DLO (550/24)	-	Red	Yellow	18	16	U31RT (2)	U29RT (2)	W31VT (2) W31RT (2)	W29VT (2) W29RT (2) X29RT (4)	W31VT (2)	W29RT (2) X29RT (4)	644 Series (1)	

† Provided with 2 heat shrink tubings. One will overlap the other; install the smaller first and larger over it.

* 46 Series require the PUADP1 adapter for U-Dies.

• P-RT for use in 46 Series tools only.

TYPE YSR-TC

HYREDUCER™ In-Line Long Barrel Reducer Splice Kits for Telecommunications Applications with Inspection Window

Type YSR-TC reducing splice kits provide for splicing two different cable sizes with inspection holes. The larger conductor is inserted first and butts against the center of the connector where the smaller barrel begins. Constructed from seamless, high conductivity electrolytic copper tubing for maximum conductivity and tin plated to resist corrosion. The YSR-TC family also features the BURNDY® color code system.

Features & Benefits

- Each splice kit includes one YSR-TC compression in-line splice reducer connector and heat shrink
- The YSR-TC type reducing compression splice connector provided in the kit is UL Listed in accordance with UL 486A-486B - Wire Connectors; UL Listed 90°C up to 35kV
- Barrels have 2 inspection windows on each side to allow for visual verification that the wire has been fully inserted prior to crimping the splice
- Designed configurations allow for copper code-to-code wire connections, copper code-to-flex wire connections, and copper flex-to-flex wire connections; see table for more complete details
- Barrel is designed with a taper to accommodate a main run wire that is reduced to a smaller tap wire
- Barrel also provided with an internal chamfer at the wire entry to ensure smooth insertion of the wire, preventing possible damaging of the wire strands during insertion
- Electro-tin plated unless otherwise specified to reduce galvanic corrosion (bimetallic) and resist corrosive elements
- Long barrel allows for an increased number of crimps which will increase the mechanical strength of the connection
- Connectors clearly marked with color coding
- Can be used in place of H-taps; the in-line design saves space in cable trays and other similar applications

Accessories

- Hardware - Section F
- PENETROX™ Oxide Inhibitor - Section F
- Heat and Cold Shrink Tubing - Section D
- WIREMIKE™ Wire Micrometer - Section F
- Wire Management (Cable Ties) - Section G

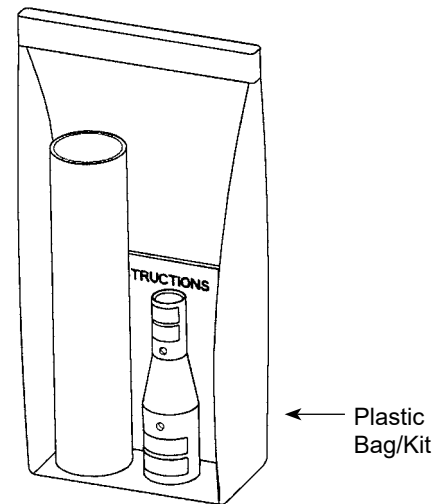

Connector with Clear Heat Shrink Kit

Clear heat shrink UL224 VW1 Listed. Passes TELCORDIA GR-347-CORE Abrasion and Cut Test up to 750 kcmil Class B code cable; contact factory for 750 flex cable applications.

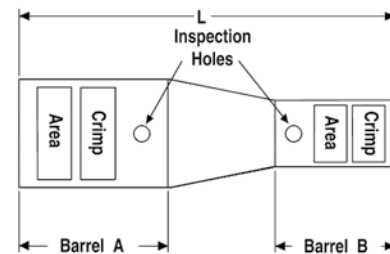

Compression Connections

Copper — Code / Flex — Reducing Splice Kit
Long Barrel — with Inspection Window

TYPE YSR-TC (Continued)

HYREDUCER™ In-Line Long Barrel
Reducer Splice Kits, with Inspection Window

Connector with Clear Heat Shrink Kit

Clear heat shrink UL224 VW1 Listed. Passes TELCORDIA GR-347-CORE
Abrasion and Cut Test up to 750 kcmil Class B code cable; contact factory for
750 flex cable applications.

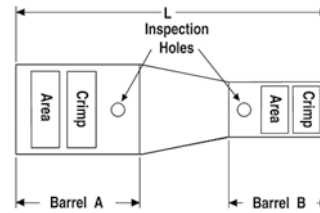

Clear Heat Shrink Kit Catalog Number	Wire Size				Connector						Wire Strip Length		
	Barrel A		Barrel B		Dimensions			Color Code		Die Index		Barrel A	Barrel B
	AWG	mm ²	AWG	mm ²	Barrel A	Barrel B	L	Barrel A	Barrel B	Barrel A	Barrel B		
YSR44FX39TCKITC	750 kcmil G,H DLO 777 (1925/24)	500 mm ² Class 5	750 kcmil Code	-	3.35	2.82	6.69	Yellow	Black	L115	24	3.09	2.71
YSR44FX34TCKITC			500 kcmil Code	240 mm ²	3.35	2.75	7.23		Brown		20		2.66
YSR44FX31TCKITC			350 kcmil Code	185 mm ²	3.35	2.51	7.47		Red		18		2.42
YSR3931TCKITC	750 kcmil Code	-	350 kcmil Code	185 mm ²	2.82	2.51	6.43	Black	Red	24	18	2.71	2.42
YSR3928TCKITC †			4/0 AWG Code	-	2.82	2.11	6.51		Purple		15		2.05
YSR38FX31TCKITC	500 kcmil H,I,K 550 kcmil G,H,I DLO 535 (1325/24)	300 mm ²	350 kcmil Code	185 mm ²	3.03	2.51	6.51	Pink	Red	L99	18	2.93	2.47
YSR38FX28TCKITC			4/0 AWG Code	-	3.03	2.11	6.59		Purple		15		2.05
YSR3431TCKITC	500 kcmil Code	240 mm ²	350 kcmil Code	185 mm ²	2.75	2.51	5.74	Brown	Red	20	18	2.67	2.42
YSR3428TCKITC			4/0 AWG Code	-	2.75	2.11	5.82		Purple		15		2.05
YSR3425FXTCKITC			1/0 AWG G,H,I,K,M DLO (275/24) 1/0 AWG	50 mm ²	2.75	1.66	5.69		Pink		12		1.68
YSR34FX28TCKITC	350 kcmil G,H,I,K,M DLO 373 (925/24)	240 mm ²	4/0 AWG Code	-	2.75	2.11	5.82	Blue	Purple	19 or L80	15	2.67	2.05
YSR34FX28FXTCKITC			4/0 AWG G,H,I,K,M DLO (550/24) 4/0 AWG	-	2.75	2.34	5.83		Purple		15		2.27
YSR34FX25FXTCKITC			1/0 AWG G,H,I,K,M DLO (275/24) 1/0 AWG	50 mm ²	2.75	1.66	5.69		Pink		12		1.61
YSR3128TCKITC	350 kcmil Code	185 mm ²	4/0 AWG Code	-	2.51	2.11	5.10	Red	Purple	18	15	2.42	2.05
YSR3125FXTCKITC			1/0 AWG G,H,I,K,M DLO (275/24) 1/0 AWG	50 mm ²	2.51	1.66	4.97		Pink		12		1.61
YSR312CFXTCKITC			#2 AWG G,H,I,K,M DLO (150/24) #2 AWG	35 mm ²	2.51	1.33	4.91		Brown		10		1.29

† Provided with 2 heat shrink tubings. One will overlap the other; install the smaller first and larger over it.

Separate Installation Tooling Chart follows.

TYPE YSR-TC (Continued)

HYREDUCER™ In-Line Long Barrel Reducer Splice Kits
with Inspection Window

Connector with Clear Heat Shrink Kit

Clear heat shrink UL224 VW1 Listed.Passes TELCORDIA GR-347-CORE
Abrasion and Cut Test up to 750 kcmil Class B code cable; contact factory for
750 flex cable applications.

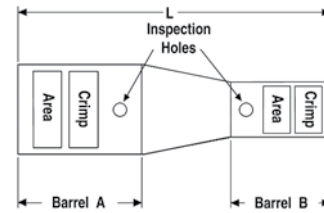

Clear Heat Shrink Kit Catalog Number	Wire Size				Connector								Wire Strip Length	
	Barrel A		Barrel B		Dimensions			Color Code		Die Index		Barrel A	Barrel B	
	AWG	mm ²	AWG	mm ²	Barrel A	Barrel B	L	Barrel A	Barrel B	Barrel A	Barrel B			
YSR32FX29FXTCKITC	300 kcmil G,H,I,K,M DLO 313 (775/24)	185 mm ² Class 2	250 kcmil Flex 4/0 AWG G,H,I,K,M DLO (550/24)	-	2.48	2.34	5.30	Red	Yellow	19 or L80	16	2.40	2.27	
YSR32FX28FXTCKITC			4/0 AWG G,H,I,K,M DLO (550/24) 4/0 AWG	120 mm ²	2.48	2.34	5.28		Purple		15		2.27	
YSR29FX25FXTCKITC	250 kcmil Flex 4/0 AWG G,H,I,K,M DLO (550/24)	-	1/0 AWG G,H,I,K,M DLO (275/24) 1/0 AWG	50 mm ²	2.36	1.66	4.63	Yellow	Pink	16	12	2.29	1.61	
YSR29FX2CFXTCKITC			#2 AWG G,H,I,K,M DLO (150/24) #2 AWG	35 mm ²	2.36	1.33	4.56		Brown		10		1.29	
YSR2825FXTCKITC	4/0 AWG Code	-	1/0 AWG G,H,I,K,M DLO (275/24) 1/0 AWG	50 mm ²	2.11	1.66	4.09	Purple	Pink	15	12	2.06	1.61	
YSR282CFXTCKITC			#2 AWG G,H,I,K,M DLO (150/24) #2 AWG	35 mm ²	2.11	1.33	4.03		Brown		10		1.29	
YSR286CFXTCKITC †			#6 AWG G,H,I,K,M DLO (61/24) #6 AWG	16 mm ²	2.11	1.17	4.25		Blue		7		1.15	
YSR26FX6CFXTCKITC †	2/0 AWG G,H,I,K,M DLO (325/24)	70 mm ²	#6 AWG G,H,I,K,M DLO (61/24) #6 AWG	16 mm ²	1.85	1.85	3.86	Black	Blue	13	7	1.80	1.85	
YSR25FX6CFXTCKITC †	1/0 AWG G,H,I,K,M DLO (275/24) 1/0 AWG	50 mm ²	#6 AWG G,H,I,K,M DLO (61/24) #6 AWG	16 mm ²	1.66	1.17	3.48	Pink	Blue	12	7	1.63	1.24	
YSR2CFX6CFXTCKITC	#2 AWG G,H,I,K,M DLO (150/24) #2 AWG	35 mm ²	#6 AWG G,H,I,K,M DLO (61/24) #6 AWG	16 mm ²	1.33	1.17	2.88	Brown	Blue	10	7	1.30	1.24	
YSR4CFX6CFXTCKITC	#4 AWG G,H,I,K,M DLO (105/24) #4 AWG	-	#6 AWG G,H,I,K,M DLO (61/24) #6 AWG	16 mm ²	1.15	1.17	2.49	Gray	Blue	8	7	1.12	1.24	

† Provided with 2 heat shrink tubings. One will overlap the other; install the smaller first and larger over it.

Separate Installation Tooling Chart follows.

Compression Connections

Copper — Code / Flex — Reducing Splice Kit
Long Barrel — with Inspection Window

TYPE YSR-TC (Continued)

INSTALLATION TOOLING CHART Long Barrel with Inspection Window

Connector with Clear Heat Shrink Kit

Clear heat shrink UL224 VW1 Listed.

Passes TELCORDIA GR-347-CORE Abrasion and Cut Test up to 750 kcmil Class B code cable; contact factory for 750 flex cable applications.

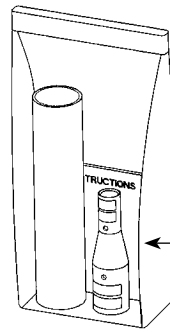

Plastic Bag/Kit

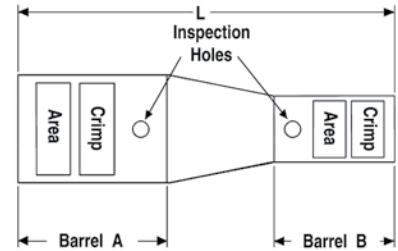

Clear Heat Shrink Kit Catalog Number	Wire Size				Connector				Installation Tooling										
	Barrel A		Barrel B		Color Code		Die Index		Hydraulic 750, 35, 46" Series		Hydraulic 500 Series		Mechanical OUR840, MD734		Dieless MY2911, MRC840, 644 Series				
	AWG	mm ²	AWG	mm ²	Barrel A	Barrel B	Barrel A	Barrel B	Barrel A	Barrel B	Barrel A	Barrel B	Barrel A	Barrel B	Barrel A	Barrel B			
YSR44FX39TCKITC	750 kcmil G,H DLO 777 (1925/24)	500 mm ² Class 5	750 kcmil Code	-	Yellow	Black	L115	24	U44XRT (4)	U39RT (4) P39RT (4)	-	-	-	644 Series (2)	644 Series (2)				
YSR44FX34TCKITC			500 kcmil Code	240 mm ²		Brown		20		U34RT (4)	-	W34VT (4) W34RT (4)	-		W34VT (4)	644 Series (2)	644 Series (2)		
YSR44FX31TCKITC			350 kcmil Code	185 mm ²		Red		18		U31RT (4)	-	W31VT (4) W31RT (4)	-		W31VT (4) W31RT (4)	644 Series (2)	644 Series (2)		
YSR3931TCKITC	750 kcmil Code	-	350 kcmil Code	185 mm ²	Black	Red	24	18	U39RT (4) P39RT (4)	U31RT (4)	-	W31VT (4) W31RT (4)	-	W31VT (4)	644 Series (2)	644 Series (2)			
YSR3928TCKITC †			4/0 AWG Code	-		Purple		15		U28RT (2)	-	W28VT (4) W28RT (4) X28RT (6)	-	W28VT (4) W28RT (4) X28RT (6)		644 Series (2)	MY2911 (2) MRC840 (4) 644 Series (2)		
YSR38FX31TCKITC	500 kcmil H,I,K 550 kcmil G,H,I DLO 535 (1325/24)	300 mm ²	350 kcmil Code	185 mm ²	Pink	Red	L99	18	U38XRT (4)	U31RT (4)	-	W31VT (4) W31RT (4)	-	W31VT (4)	644 Series (2)	644 Series (2)			
YSR38FX28TCKITC			4/0 AWG Code	-		Purple		15		U28RT (2)	-	W28VT (4) W28RT (4) X28RT (6)	-	W28VT (4) W28RT (4) X28RT (6)		644 Series (2)	MY2911 (2) MRC840 (4) 644 Series (2)		
YSR3431TCKITC	500 kcmil Code	240 mm ²	350 kcmil Code	185 mm ²	Brown	Red	20	18	U34RT (4) U31ART (4)	U31RT (4)	W34VT (4) W34RT (4)	W31VT (4) W31RT (4)	W34VT (4)	W31VT (4)	644 Series (2)	644 Series (2)			
YSR3428TCKITC			4/0 AWG Code	-		Purple		15		U28RT (2)		-		W28VT (4) W28RT (4) X28RT (6)		-	W28VT (4) W28RT (4) X28RT (6)	644 Series (2)	MY2911 (2) MRC840 (4) 644 Series (2)
YSR3425FXTCKITC			1/0 AWG G,H,I,K,M DLO (275/24) 1/0 AWG	50 mm ²		Pink		12		U25RT (2)		-		W25VT (4) W25RT (4) X25RT (4)		-	W25VT (4) W25RT (4) X25RT (4)	644 Series (2)	644 Series (2)
YSR34FX28TCKITC	350 kcmil G,H,I,K,M DLO 373 (925/24)	240 mm ²	4/0 AWG Code	-	Blue	Purple	19 or L80	15	U32RT (4)	U28RT (2)	W32VT (4) W32RT (4)	-	W32VT (4)	W28VT (4) W28RT (4) X28RT (4)	644 Series (2)	MY2911 (2) MRC840 (4) 644 Series (2)			
YSR34FX28FXTCKITC			4/0 AWG G,H,I,K,M DLO (550/24) 4/0 AWG	-		Purple		15		U28RT (2)		-		W28VT (4) W28RT (4) X28RT (6)		-	W28VT (4) W28RT (4) X28RT (4)	644 Series (2)	644 Series (2)
YSR34FX25FXTCKITC			1/0 AWG G,H,I,K,M DLO (275/24) 1/0 AWG	50 mm ²		Pink		12		U25RT (2) U2CABT (2)		-		W25VT (4) W25RT (4) X25RT (4)		-	W25VT (4) W25RT (4) X25RT (4)	644 Series (2)	644 Series (2)

† Provided with 2 heat shrink tubings. One will overlap the other; install the smaller first and larger over it.

* 46 Series require the PUADP1 adapter for U-Dies.

• P-RT for use in 46 Series tools only.

TYPE YSR-TC (Continued)

INSTALLATION TOOLING CHART Long Barrel with Inspection Window

Connector with Clear Heat Shrink Kit

Clear heat shrink UL224 VW1 Listed.

Passes TELCORDIA GR-347-CORE Abrasion and Cut Test up to 750 kcmil Class B code cable; contact factory for 750 flex cable applications.

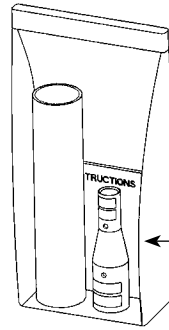

Plastic Bag/Kit

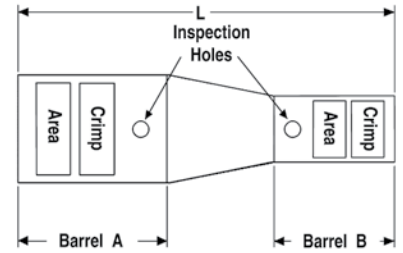

Clear Heat Shrink Kit Catalog Number	Wire Size				Connector				Installation Tooling							
	Barrel A		Barrel B		Color Code		Die Index		Hydraulic		Hydraulic		Mechanical		Dieless	
	AWG	mm ²	AWG	mm ²	Barrel A	Barrel B	Barrel A	Barrel B	750, 35, 46* Series		500 Series		OUR840, MD734		MY2911, MRC840, 644 Series	
									Barrel A	Barrel B	Barrel A	Barrel B	Barrel A	Barrel B	Barrel A	Barrel B
YSR3128TCKITC			4/0 AWG Code	-	Red	Purple	18	15	U31RT (4)	U28RT (2)	W31VT (4) W31RT (4)	W28VT (4) W28RT (4) X28RT (6)	W31VT (4)	W28VT (4) W28RT (4) X28RT (6)	644 Series (2)	MY2911 (2) MRC840 (4) 644 Series (2)
YSR3125FXTCKITC	350 kcmil Code	185 mm ²	1/0 AWG G,H,I,K,M DLO (275/24) 1/0 AWG	50 mm ²	Red	Pink	18	12	U31RT (4)	U25RT (2)	W31VT (4) W31RT (4)	W25VT (4) W25RT (4) X25RT (4)	W31VT (4)	W25VT (4) W25RT (4) X25RT (4)	644 Series (2)	MY2911 (2) 644 Series (2)
YSR312CFXTCKITC			#2 AWG G,H,I,K,M DLO (150/24) #2 AWG	35 mm ²	Red	Brown		10	U31RT (4)	U2CRT (2)	W31VT (4) W31RT (4)	W2CVT (2) W2CRT (2) X2CRT (2)	W31VT (4)	W2CVT (2) W2CRT (2) X2CRT (2)		Y1MRTC (4) MY2911 (2) 644 Series (2)
YSR32FX29FXTCKITC	300 kcmil G,H,I,K,M DLO 313 (775/24)	185 mm ² Class 2	250 kcmil Flex 4/0 AWG G,H,I,K,M DLO (550/24)	-	Red	Yellow	19 or L80	16	U31RT (4)	U29RT (4)	W31VT (4) W31RT (4)	W29VT (4) W29RT (4) X29RT (8)	W31VT (4)	W29VT (4) X29RT (8)	644 Series (2)	644 Series (2)
YSR32FX28FXTCKITC			4/0 AWG G,H,I,K,M DLO (550/24) 4/0 AWG	120 mm ²	Red	Purple		15	U31RT (4)	U28RT (2)	W31VT (4) W31RT (4)	W28VT (4) W28RT (4) X28RT (6)	W31VT (4)	W28VT (4) W28RT (4) X28RT (6)		MY2911 (2) 644 Series (2)
YSR29FX25FXTCKITC	250 kcmil Flex 4/0 AWG G,H,I,K,M DLO (550/24)	-	1/0 AWG G,H,I,K,M DLO (275/24) 1/0 AWG	50 mm ²	Yellow	Pink	16	12	U29RT (4)	U25RT (4)	W29VT (4) W29RT (4) X29RT (8)	W25VT (4) W25RT (4) X25RT (4)	W29VT (4) X29RT (8)	W25VT (4) W25RT (4) X25RT (4)	644 Series (2)	MY2911 (2) 644 Series (2)
YSR29FX2CFXTCKITC			#2 AWG G,H,I,K,M DLO (150/24) #2 AWG	35 mm ²	Yellow	Brown		10	U29RT (4)	U2CRT (2)	W29VT (4) W29RT (4) X29RT (8)	W2CVT (2) W2CRT (2) X2CRT (2)	W29VT (4) X29RT (8)	W2CVT (2) W2CRT (2) X2CRT (2)		Y1MRTC (4) MY2911 (2) 644 Series (2)
YSR2825FXTCKITC			1/0 AWG G,H,I,K,M DLO (275/24) 1/0 AWG	50 mm ²		Pink		12	U28RT (2)	U25RT (2)		W25VT (4) W25RT (4) X25RT (4)		W25VT (4) W25RT (4) X25RT (4)		MY2911 (2) 644 Series (2)
YSR282CFXTCKITC	4/0 AWG Code	-	#2 AWG G,H,I,K,M DLO (150/24) #2 AWG	35 mm ²	Purple	Brown	15	10	U28RT (2)	U2CRT (2)	W28VT (4) W28RT (4) X28RT (6)	W2CVT (2) W2CRT (2) X2CRT (2)	W28VT (4) W28RT (4) X28RT (6)	W2CVT (2) W2CRT (2) X2CRT (2)	MY2911 (2) MRC840 (4) 644 Series (2)	Y1MRTC (4) MY2911 (2) 644 Series (2)
YSR286CFXTCKITC †			#6 AWG G,H,I,K,M DLO (61/24) #6 AWG	16 mm ²		Blue		7	U5CRT (2)	U5CRT (2)		W5CVT (2) W5CRT (2) X5CRT (2)		W5CVT (2) W5CRT (2) X5CRT (2)		Y1MRTC (4) MY2911 (2) 644 Series (2)

† Provided with 2 heat shrink tubings. One will overlap the other; install the smaller first and larger over it.

* 46 Series require the PUADP1 adapter for U-Dies.

• P-RT for use in 46 Series tools only.

Compression Connections

Copper — Code / Flex — Reducing Splice Kit
Long Barrel — with Inspection Window

TYPE YSR-TC (Continued)

INSTALLATION TOOLING CHART Long Barrel with Inspection Window

Connector with Clear Heat Shrink Kit

Clear heat shrink UL224 VW1 Listed.

Passes TELCORDIA GR-347-CORE Abrasion and Cut Test up to 750 kcmil Class B code cable; contact factory for 750 flex cable applications.

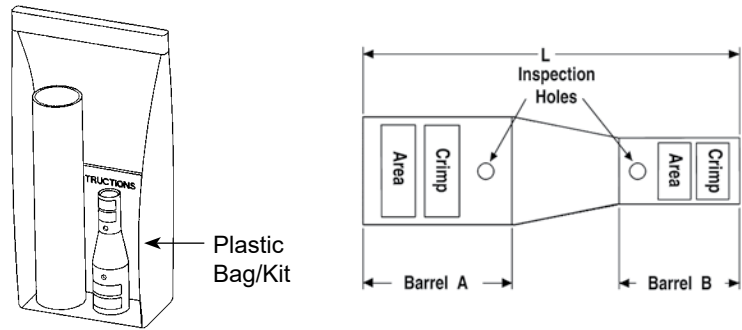

Clear Heat Shrink Kit Catalog Number	Wire Size				Connector				Installation Tooling							
	Barrel A		Barrel B		Color Code		Die Index		Hydraulic 750, 35, 46 Series		Hydraulic 500 Series		Mechanical OUR840, MD734		Dieless MY2911, MRC840, 644 Series	
	AWG	mm ²	AWG	mm ²	Barrel A	Barrel B	Barrel A	Barrel B	Barrel A	Barrel B	Barrel A	Barrel B	Barrel A	Barrel B	Barrel A	Barrel B
	YSR26FX6CFXTCKITC †	2/0 AWG G,H,I,K,M DLO (325/24)	70 mm ²	#6 AWG G,H,I,K,M DLO (61/24) #6 AWG	16 mm ²	Black	Blue	13	7	U26RT (2)	U5CRT (2)	W26VT (4) W26RT (4) X26RT (4)	W5CVT (2) W5CRT (2) X5CRT (2)	W26VT (4) W26RT (4) X26RT (4)	W5CVT (2) W5CRT (2) X5CRT (2)	MY2911 (2) 644 Series (2)
YSR25FX6CFXTCKITC †	1/0 AWG G,H,I,K,M DLO (275/24) 1/0 AWG	50 mm ²	#6 AWG G,H,I,K,M DLO (61/24) #6 AWG	16 mm ²	Pink	Blue	12	7	U25RT (2)	U5CRT (2)	W25VT (4) W25RT (4) X25RT (4)	W5CVT (2) W5CRT (2) X5CRT (2)	W25VT (4) W25RT (4) X25RT (4)	W5CVT (2) W5CRT (2) X5CRT (2)	MY2911 (2) 644 Series (2)	Y1MRTC (2) MY2911 (2)
YSR2CFX6CFXTCKITC	#2 AWG G,H,I,K,M DLO (150/24) #2 AWG	35 mm ²	#6 AWG G,H,I,K,M DLO (61/24) #6 AWG	16 mm ²	Brown	Blue	10	7	U2CRT (2)	U5CRT (2)	W2CVT (2) W2CRT (2) X2CRT (2)	W5CVT (2) W5CRT (2) X5CRT (2)	W2CVT (2) W2CRT (2) X2CRT (2)	W5CVT (2) W5CRT (2) X5CRT (2)	Y1MRTC (4) MY2911 (2) 644 Series (2)	Y1MRTC (2) MY2911 (2)
YSR4CFX6CFXTCKITC	#4 AWG G,H,I,K,M DLO (105/24) #4 AWG	-	#6 AWG G,H,I,K,M DLO (61/24) #6 AWG	16 mm ²	Gray	Blue	8	7	U4CRT (2)	U5CRT (2)	W4CVT (2) W4CRT (2) X4CRT (2)	W5CVT (2) W5CRT (2) X5CRT (2)	W4CVT (2) W4CRT (2) X4CRT (2)	W5CVT (2) W5CRT (2) X5CRT (2)	Y1MRTC (4) MY2911 (2) 644 Series (2)	Y1MRTC (2) MY2911 (2)

† Provided with 2 heat shrink tubings. One will overlap the other; install the smaller first and larger over it.

* 46 Series require the PUADP1 adapter for U-Dies.

• P-RT for use in 46 Series tools only.

TYPE YSR-TC

HYREDUCER™ In-Line Long Barrel Reducer Splice Kits, No Inspection Window

Type YSR-TC reducing splice kits provide for splicing two different cable sizes without inspection holes. The larger conductor is inserted first and butts against the center of the connector where the smaller barrel begins. Constructed from seamless, high conductivity electrolytic copper tubing for maximum conductivity and tin plated to resist corrosion. The YSR-TC family also features the BURNDY® color code system.

Features & Benefits

- Each splice kit includes one YSR-TC compression in-line splice reducer connector and heat shrink
- The YSR-TC type reducing compression splice connector provided in the kit is UL Listed in accordance with UL 486A-486B - Wire Connectors; UL Listed 90°C up to 35kV
- No inspection window for more corrosive environments as the barrel transition is not open
- Designed configurations allow for copper code-to-code wire connections, copper code-to-flex wire connections, and copper flex-to-flex wire connections; see table for more complete details
- Barrel is designed with a taper to accommodate a main run wire that is reduced to a smaller tap wire
- Barrel also provided with an internal chamfer at the wire entry to ensure smooth insertion of the wire, preventing possible damaging of the wire strands during insertion
- Electro-tin plated unless otherwise specified to reduce galvanic corrosion (bimetallic) and resist corrosive elements
- Long barrel allows for an increased number of crimps which will increase the mechanical strength of the connection
- Connectors clearly marked with color coding
- Can be used in place of H-taps; the in-line design saves space in cable trays and other similar applications

Accessories

- Hardware - Section F
- PENETROX™ Oxide Inhibitor - Section F
- Heat and Cold Shrink Tubing - Section D
- WIREMIKE™ Wire Micrometer - Section F
- Wire Management (Cable Ties) - Section G

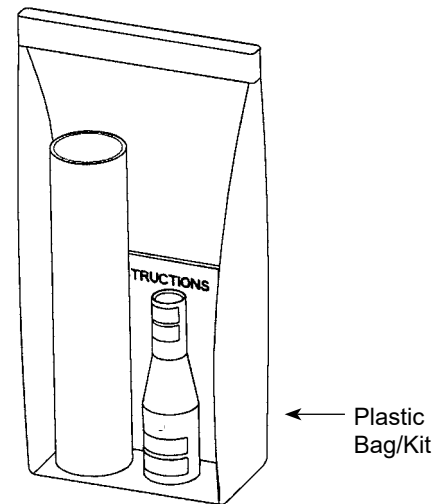

Connector with Clear Heat Shrink Kit

Clear heat shrink UL224 VW1 Listed. Passes TELCORDIA GR-347-CORE Abrasion and Cut Test up to 750 kcmil Class B code cable; contact factory for 750 flex cable applications.

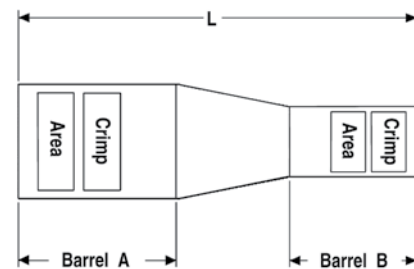

Compression Connections

Copper — Code / Flex — Reducing Splice Kit
Long Barrel — No Inspection Window

TYPE YSR-TC (Continued)

HYREDUCER™ In-Line Long Barrel
Reducer Splice Kits, No Inspection Window

Connector with Clear Heat Shrink Kit

Clear heat shrink UL224 VW1 Listed. Passes TELCORDIA GR-347-CORE
Abrasion and Cut Test up to 750 kcmil Class B code cable; contact factory for
750 flex cable applications.

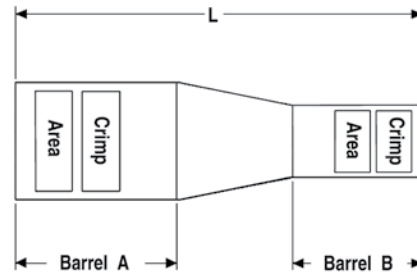

Clear Heat Shrink Kit Catalog Number	Wire Size				Connector								Wire Strip Length	
	Barrel A		Barrel B		Dimensions			Color Code		Die Index				
	AWG	mm ²	AWG	mm ²	Barrel A	Barrel B	L	Barrel A	Barrel B	Barrel A	Barrel B	Barrel A	Barrel B	
YSR44FX38FXKITC	750 kcmil G,H DLO 777 (1925/24)	500 mm ² Class 5	500 kcmil H,I,K 550 kcmil G,H,I DLO 535 (1325/24)	300 mm ²	3.22	2.79	6.64	Yellow	Pink	L99	19 or L80	3.09	2.68	
YSR44FX34FXKITC			350 kcmil G,H,I,K,M DLO 373 (925/24)	240 mm ²	3.22	2.56	6.91		Blue				2.47	
YSR44FX29FXKITC †			350 kcmil Flex 4/0 AWG G,H,I,K,M DLO (550/24)	-	3.22	2.36	7.38		Yellow				16	2.29
YSR3938FXKITC	750 kcmil Code	-	500 kcmil H,I,K 550 kcmil G,H,I DLO 535 (1325/24)	300 mm ²	2.82	2.79	5.74	Black	Pink	24	19 or L80	2.71	2.68	
YSR3934FXKITC			350 kcmil G,H,I,K,M DLO 373 (925/24)	240 mm ²	2.82	2.56	6.00		Blue				2.47	
YSR3929FXKITC †			350 kcmil Flex 4/0 AWG G,H,I,K,M DLO (550/24)	-	2.82	2.36	6.47		Yellow				16	2.29
YSR38FX34FXKITC	500 kcmil H,I,K 550 kcmil G,H,I DLO 535 (1325/24)	300 mm ²	350 kcmil G,H,I,K,M DLO 373 (925/24)	240 mm ²	2.79	2.56	5.83	Pink	Blue	L99	19 or L80	2.68	2.47	
YSR38FX29FXKITC			350 kcmil Flex 4/0 AWG G,H,I,K,M DLO (550/24)	-	2.79	2.36	6.30		Yellow				16	2.29
YSR3434FXKITC	500 kcmil Code	240 mm ²	350 kcmil G,H,I,K,M DLO 373 (925/24)	240 mm ²	2.56	2.56	5.12	Brown	Blue	20	19 or L80	2.47	2.47	
YSR3429FXKITC			350 kcmil Flex 4/0 AWG G,H,I,K,M DLO (550/24)	-	2.56	2.36	5.59		Yellow				16	2.29
YSR34FX29FXKITC	350 kcmil G,H,I,K,M DLO 373 (925/24)	240 mm ²	350 kcmil Flex 4/0 AWG G,H,I,K,M DLO (550/24)	-	2.56	2.36	5.59	Blue	Yellow	19 or L80	16	2.67	2.29	
YSR3129FXKITC	350 kcmil Code	185 mm ²	350 kcmil Flex 4/0 AWG G,H,I,K,M DLO (550/24)	-	2.42	2.36	4.97	Red	Yellow	18	16	2.34	2.29	

† Provided with 2 heat shrink tubings. One will overlap the other; install the smaller first and larger over it.

Separate Installation Tooling Chart follows.

TYPE YSR-TC (Continued)

INSTALLATION TOOLING CHART Long Barrel No Inspection Window

Connector with Clear Heat Shrink Kit

Clear heat shrink UL224 VW1 Listed.
 Passes TELCORDIA GR-347-CORE Abrasion and Cut
 Test up to 750 kcmil Class B code cable; contact factory
 for 750 flex cable applications.

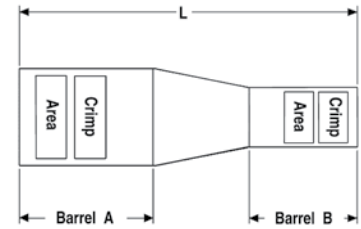

Clear Heat Shrink Kit Catalog Number	Wire Size				Connector				Installation Tooling							
	Barrel A		Barrel B		Color Code		Die Index		Hydraulic		Hydraulic		Mechanical		Dieless	
	AWG	mm ²	AWG	mm ²	Barrel A	Barrel B	Barrel A	Barrel B	750, 35, 46* Series		500 Series		OUR840, MD734		644 Series	
									Barrel A	Barrel B	Barrel A	Barrel B	Barrel A	Barrel B	Barrel A	Barrel B
YSR44FX38FXKITC			500 kcmil H,I,K 550 kcmil G,H,I DLO 535 (1325/24)	300 mm ²		Pink	L99	U44XRT (4)	U38XRT (4)							
YSR44FX34FXKITC	750 kcmil G,H DLO 777 (1925/24)	500 mm ² Class 5	350 kcmil G,H,I,K,M DLO 373 (925/24)	240 mm ²	Yellow	Blue	L115 19 or L80	U44XRT (4) +P44XRT (4)	U32RT (4)	-	W32VT (4) W32RT (4)	-	W32VT (4)			644 Series (2)
YSR44FX29FXKITC †			350 kcmil Flex 4/0 AWG G,H,I,K,M DLO (550/24)	-		Yellow	16	U44XRT (4) +P44XRT (4)	U29RT (4)		W29VT (4) W29RT (4) X29RT (8)		W29VT (4) X29RT (8)			
YSR3938FXKITC			500 kcmil H,I,K 550 kcmil G,H,I DLO 535 (1325/24)	300 mm ²		Pink	L99		U38XRT (4)							
YSR3934FXKITC	750 kcmil Code	-	350 kcmil G,H,I,K,M DLO 373 (925/24)	240 mm ²	Black	Blue	24 19 or L80	U39RT (4) P39RT (4)	U32RT (4)	-	W32VT (4) W32RT (4)	-	W32VT (4)			644 Series (2)
YSR3929FXKITC †			350 kcmil Flex 4/0 AWG G,H,I,K,M DLO (550/24)	-		Yellow	16		U29RT (4)		W29VT (4) W29RT (4) X29RT (8)		W29VT (4) X29RT (8)			
YSR38FX34FXKITC	500 kcmil H,I,K 550 kcmil G,H,I DLO 535 (1325/24)	300 mm ²	350 kcmil G,H,I,K,M DLO 373 (925/24)	240 mm ²		Blue	L99 19 or L80	U38XRT (4)	U32RT (4)		W32VT (4) W32RT (4)		W32VT (4)			644 Series (2)
YSR38FX29FXKITC			350 kcmil Flex 4/0 AWG G,H,I,K,M DLO (550/24)	-		Yellow	16		U29RT (4)		W29VT (4) W29RT (4) X29RT (8)		W29VT (4) X29RT (8)			
YSR3434FXKITC	500 kcmil Code	240 mm ²	350 kcmil G,H,I,K,M DLO 373 (925/24)	240 mm ²		Blue	20 19 or L80	U34RT (4) U31ART (4)	U32RT (4)	W34VT (4) W34RT (4)	W32VT (4) W32RT (4)	W34VT (4)	W32VT (4)			644 Series (2)
YSR3429FXKITC			350 kcmil Flex 4/0 AWG G,H,I,K,M DLO (550/24)	-		Yellow	16		U29RT (4)		W29VT (4) W29RT (4) X29RT (8)		W29VT (4) X29RT (8)			
YSR34FX29FXKITC	350 kcmil G,H,I,K,M DLO 373 (925/24)	240 mm ²	350 kcmil Flex 4/0 AWG G,H,I,K,M DLO (550/24)	-	Blue	Yellow	19 or L80 16	U32RT (4)	U29RT (4)	W32VT (4) W32RT (4)	W29VT (4) W29RT (4)	W32VT (4)	W29VT (4) X29RT (8)			644 Series (2)
YSR3129FXKITC	350 kcmil Code	185 mm ²	350 kcmil Flex 4/0 AWG G,H,I,K,M DLO (550/24)	-	Red	Yellow	18 16	U31RT (4)	U29RT (4)	W31VT (4) W31RT (4)	W29VT (4) W29RT (4) X29RT (8)	W31VT (4)	W29VT (4) X29RT (8)			644 Series (2)

† Provided with 2 heat shrink tubings. One will overlap the other; install the smaller first and larger over it.

* 46 Series require the PUADP1 adapter for U-Dies.

• P-RT for use in 46 Series tools only.

TYPE YC-L

Thin Wall Copper C-Tap

UL Listed 90° C, Up to 35 kV ♦



Type YC-L is a thin wall, high conductivity copper connector for making copper taps and parallel connections from #14 to 3/0 AWG. UL Listed and CSA Certified Wire Connectors per UL 486A-486B. Direct Burial Rating per UL 467 Grounding and Bonding Connector.

Features & Benefits

- Bare copper range taking C-tap that allows for less inventory as one C-tap can accommodate a multitude of wire combinations
- Reinforced ribs on the outside of the C-tap increases the mechanical holding strength of the connection
- Creates a compact connection that allows for easy taping and insulating
- Connectors include a color dot to ensure proper die and installation tooling is selected
- Manufactured from high conductivity wrought copper providing low resistance for excellent electrical conductivity
- Connectors are clearly marked with stamping and color dot
- UL Listed CSA Certified Wire Connectors per UL 486A-486B
- Four sizes are listed for Grounding and Bonding per UL 467 for Direct Burial in Earth or concrete
- BURNDY certifies its products using the BURNDY Engineered System and select other crimp tool manufacturers in accordance with one or more of the UL categories in order to obtain a UL Listing

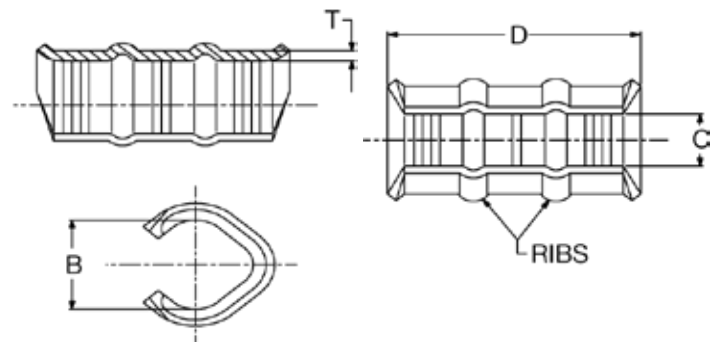

Catalog Number	Copper Conductor AWG ‡		No. of Ribs	Dimensions				Color Code	Installation Tooling						Wire Strip Length
									Mechanical			Hydraulic			
									Y122CMR Y1MRTC	MD6, OUR840, MD734R Die No. (# crimps)	Die ▲ Index Embossment	MD6, 500 Series (# crimps)	35, 750, 46* Series (# of crimps)	Die ▲ Index Embossment	
Run	Tap	B	C	D	T										
YC8L12	10 8	10 12	0	0.25	0.21	0.60	0.07	Blue	Blue (1)	W5CVT (1)	7	—	—	—	5/8
YC6L12	8 6	10-8 12-10	0	0.33	0.25	0.60	0.07	Gray	Gray (2)	W4CVT (1)	8	—	—	—	5/8
YC4L12	6 5,4	8-6 12-8	1	0.39	0.28	1.18	0.07	Brown	Brown (2)	W2CVT (2)	10	—	UC4 (1)	10M	1-3/16
YC3L12**	5,4 3	6-5 12-6	1	0.46	0.27	1.18	0.08	Green	—	W1CVT (2)	11	—	—	—	1-3/16
YC2L12	4 3 2	4 5 12-6	1	0.50	0.36	1.18	0.08	Pink	—	W25VT (2)	12	WC2 (1)	UC2 (1)	12M	1-3/16
YC1L12	3 2 1	4-3 5-4 12-5	2	0.55	0.34	1.75	0.08	Black	—	W26VT (3)	13	WC1 (2)	UC1 (1)	13M	1-13/16
YC25L12	2 1 1/0	3-2 4-3 12-4	2	0.62	0.42	1.75	0.09	Orange	—	W27VT (3)	14	WC25 (2)	UC25 (1)	14M	1-13/16
YC26L12	1 1/0 2/0	2-1 3-2 12-3	2	0.69	0.43	1.75	0.09	Purple	—	W28VT (3)	15	—	UC26 (1)	15	1-13/16
YC27L12	1/0 2/0 3/0	1-1/0 2-1 12-2	2	0.81	0.48	1.75	0.09	Yellow	—	W29VT (3)	16	—	—	—	1-13/16

▲ See tooling section of this catalog for complete tool and die listings.

‡ Refer to website for sales drawing with complete listing with solid/stranded copper conductor

* Use PUADP1 adapter with U dies in 46 Series

For Tin plating add TN suffix (example = YC10L12TN)

Note: All dimensions shown are for reference only.

** YC3L12 is NOT UL Listed or CSA Certified for Grounding and Bonding.

TYPE YC-C

Copper CRIMPIT™ C-Tap

UL Listed 90° C, Up to 35 kV ♦

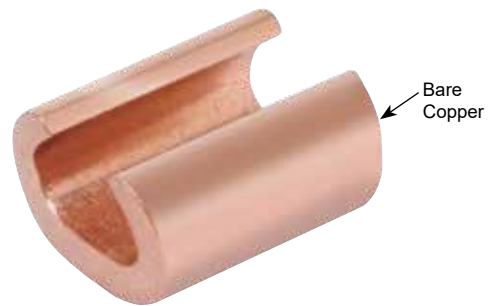

Type YC-C copper CRIMPIT™ connector is a range-taking C-shape compression connector for making tap or parallel copper connections from #12 solid to 4/0 stranded conductor.

Features & Benefits

- Bare copper standard (tin plated available)
- Range taking C-tap that allows for less inventory as one C-tap can accommodate a multitude of wire combinations
- Creates a compact connection that allows for easy taping and insulating
- Manufactured from high conductivity wrought copper providing low resistance for excellent electrical conductivity
- Connectors are clearly marked with stamping
- BURNDY certifies its products using the BURNDY Engineered System and select other crimp tool manufacturers in accordance with one or more of the UL categories in order to obtain a UL Listing

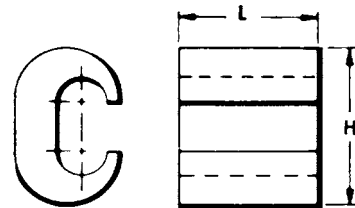

Accessories

- Hardware - Section F
- PENETROX™ Oxide Inhibitor - Section F
- Heat and Cold Shrink Tubing - Section D
- WIREMIKE™ Wire Micrometer - Section F
- Wire Management (Cable Ties) - Section G

Copperweld-Copper Conductors

- 8A - Use CRIMPIT™ accommodating 6 str. Copper
- 6A - Use CRIMPIT™ accommodating 4 Str. Copper
- 4A - Use CRIMPIT™ accommodating 2 Str. Copper
- 2A - Use CRIMPIT™ accommodating 1/0 and 2/0 Copper

Catalog Number	Run	Tap	L	▲ Die Index	Tools, Die Set, Catalog Number, and (‡No. of Crimps) ▲			CRIMPIT™ for 1 Str. Copper	
					MD6	OUR840	35, 750, 46* Series	Run	Tap
YC10C10 †	12 Sol.-10 Str.	12 Sol.- 10 Str.	.32	238	W238 (1)	W238 (1)	U238 (1)	—	—
YC8C8	8 Sol.-8 Str.	10 Sol.- 8 Str.	.50	162	W162 (2)	W162 (2)	U162** (1)	—	—
YC4C8	6 Sol.-4 Str.	8 Sol.- 8 Str.	.62	BG or 5/8	BG (2) WBG** (1)	XBG (2) XNBG (2)	UBG (1)	—	—
YC4C6		6 Sol.- 6 Str.	.57						
YC4C4		6 Sol.- 4 Str.							
YC2C4	4 Sol.-2 Str.	8 Sol.- 4 Str.	.67	C	WC (2)	—	UC (1)	1 Str. §	6, 8 Str., 8 Sol.
YC2C2	2 Sol.-2 Str.	2 Sol.- 2 Str.						—	—
YC26C2	1/0 Sol.-2/0 Str.	8 Sol.- 2 Str.	.92	E or O	—	—	UE (3) UO (1)	1 Str. §	1 or 2 Str.
YC26C26		1/0 Sol.- 2/0 Str.						—	—
YC28C2	3/0 Sol.-4/0 Str.	6 Sol.- 2 Str.	1.07	F or D3	—	—	UF (3) UD3** (1)	—	—
YC28C26		1/0 Sol.- 2/0 Str.							
YC28C28		3/0 - 4/0 Str.							

† Not UL Listed.

▲ See tooling section of this catalog for complete tool and die listings.

§ Not UL Listed or CSA Certified with this conductor size in run.

* Use PUADP1 adapter when using U dies in the 46 Series.

** Multiple crimp die set. Makes more than one crimp per tool compression. Figure () indicates number of compressions.

♦ For applications greater than 2000 Volts consult cable manufacturer for voltage stress relief instructions.

Note: All dimensions shown are for reference only.

TYPE YCHC

Copper CRIMPIT™ C-Tap

UL Listed 90° C, Up to 35 kV ♦

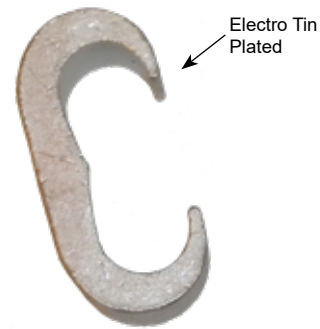

Features & Benefits

- Range taking C-tap that allows for less inventory as one C-tap can accommodate a multitude of wire combinations
- Accommodates a wide range of run/tap combinations
- Manufactured from high conductivity wrought copper providing low resistance for excellent electrical conductivity
- Electro-tin plated unless otherwise specified to reduce galvanic corrosion (bimetallic) and resist corrosive elements
- Each connector has a recommended UL Listed / CSA Certified insulating cover available in both black and clear (see table); clear cover allows for easy inspection of the connection (see separate page for full details on Type CCFR-FR and CFR-FR Covers)
- Connectors are clearly marked with stamping
- BURNDY certifies its products using the BURNDY Engineered System and select other crimp tool manufacturers in accordance with one or more of the UL categories in order to obtain a UL Listing

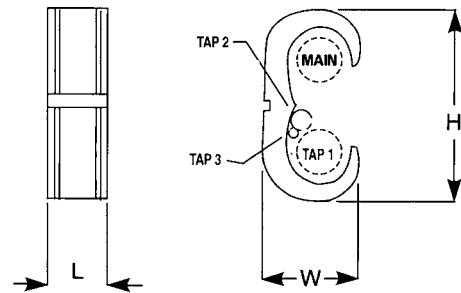

BURNDY Catalog Number	Flame Retardant Cover		Conductor Sizes Code/(Flex) Cable				▲ Tooling († No. of Crimps)						▲ Die Index & Embossment	H	W	L	Strip Length	
	Clear Cat. No.	Black Cat. No. ‡	Main	Tap 1	Tap 2	Tap 3	35 Series	†	750 Series	†	46* Series	†						Color Code
YCHC44TC44	CCFRFR	CFRFR	1000-750 (750-500)	1000-750 (750-500)	—	—	—	—	—	—	P1102	1	White	1102	3.59	1.73	1.16	1-1/4"
YCHC39TC39	CCFRFR	CFRFR	750-500 (550-500)	750-350 (550-350)	—	—	—	—	—	—	P1103	1	Blue	1103	3.12	1.53	1.06	1-1/8"
YCHC39TC31	CCFRFR	CFRFR	750-500 (550-500)	350-2 (250-2)	2-6 Str./Sol. (2-8)	8-14 (8-14)	—	—	—	—	P1103	1	Blue	1103	2.96	1.53	1.31	1-3/8"
YCHC39TC2	CCFRFR	CFRFR	750-500 (550-500)	2-6 Str./Sol. (2-8)	8-14 (8-14)	—	—	—	—	—	P1103	1	Blue	1103	2.66	1.53	1.31	1-3/8"
YCHC34TC34	CCFNFR	CFNFR	500-4/0 (350-4/0)	500-4/0 (350-4/0)	—	—	—	—	U1104	2	U1104	1	Brown	1104	2.97	1.38	1.00	1-1/4"
YCHC34TC29	CCFNFR	CFNFR	500-4/0 (350-4/0)	250-2 (4/0-2)	2-6 Str./Sol. (2-8)	—	—	—	U1104	2	U1104	1	Brown	1104	2.45	1.26	0.88	1"
YCHC34TC2	CCFNFR	CFNFR	500-4/0 (350-4/0)	2-6 Str./Sol. (2-8)	8-14 (8-14)	—	—	—	U1104	2	U1104	1	Brown	1104	2.45	1.26	0.94	1"
YCHC29TC29	CCFDXFR	CFDFR	250-2 (4/0-2)	250-2 (4/0-2)	—	—	—	—	U997	1	U997	1	Orange	997	2.12	.98	0.94	1"
YCHC29TC2	CCFDFR	CFDFR	250-2 (4/0-2)	2-6 Str./Sol. (2-8)	8-14 (8-14)	—	—	—	U251	1	U251	1	Red	251	1.78	.97	0.81	1"
YCHC2TC2	CCFOFR	CFOFR	2-6 Str./Sol. (2-8)	2-6 Str./Sol. (2-8)	8-14 (8-14)	—	UC	1	UC	1	UC	1	Brown	C	1.22	.60	0.81	1"
YCHC8TC8	♦	♦	8-12 (8-12)	8-12 (8-12)	—	—	U240	1	U240	1	U240	1	Red	240	0.53	.35	0.56	5/8"

Note: To properly use tap 2 and/or tap 3 conductors in YCHC connector a conductor from the tap 1 cable range must be included in the tap 1 groove.

‡ To obtain covers made of polyethylene remove suffix-FR (example: CFO). CFO is not flame retardant.

* Use PUADP1 adaptor with U dies in 46 Series.

▲ See tooling section of Master Catalog for complete tool and die listings.

♦ For applications requiring flame retardant cover, use either a CCFBG-FR (Clear) or CFBG-FR (Black) cover and YH2C2C connector by ordering YH8C8CWCC (Clear) or YH8C8CWC (Black).

Note: All dimensions shown are for reference only.

TYPE YH

H-Tap Copper CRIMPIT™

UL Listed 90° C, Up to 35 kV ♦



Features & Benefits

- Range taking H-tap that allows for less inventory as one H-tap can accommodate a multitude of wire combinations
- H-Tap Copper CRIMPIT™ also accommodates a wide range of run and tap combinations
- The tap grooves act independently; the use of one run and one tap wire is required when using this connector for making a connection
- Designs with more than one tap wire groove require installers to utilize only the run and one tap groove; the other tap grooves can be left empty
- The “third hand” is a string provided with the H-tap connector used to wrap the wire while being inserted into the run and tap grooves; this feature constrains the wire while the installer applies the recommended number of crimps
- Electro-tin plated unless otherwise specified to reduce galvanic corrosion (bimetallic) and resist corrosive elements
- Each connector has a recommended UL Listed / CSA Certified insulating cover available in both black and clear (see table); clear cover allows for easy inspection of the connection (see separate page for details on Type CCF-FR and CFR-FR Covers)
- Connectors clearly marked with color coding to ensure proper die and installation tooling is selected
- BURNDY certifies its products using the BURNDY Engineered System and select other crimp tool manufacturers in accordance with one or more of the UL categories in order to obtain a UL Listing

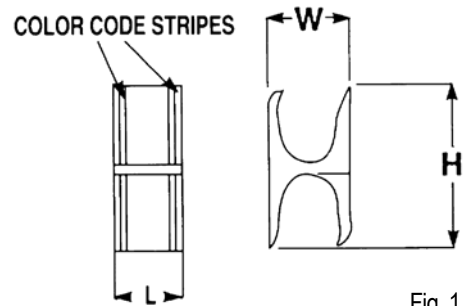
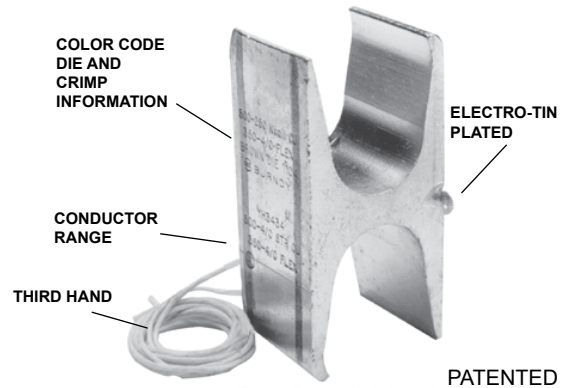

Fig. 1

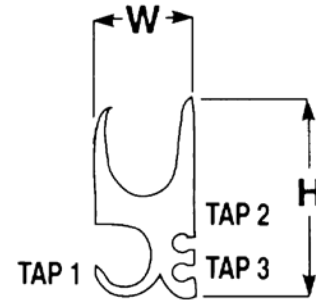

Fig. 2

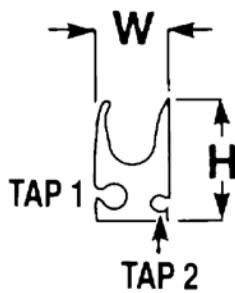

Fig. 3

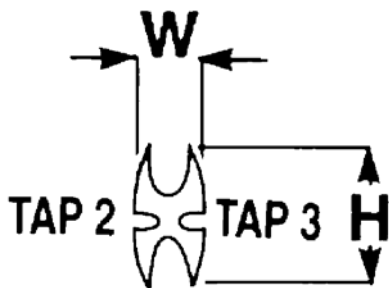

Fig. 4



Fig. 5



Fig. 6

TYPE YH (Continued)

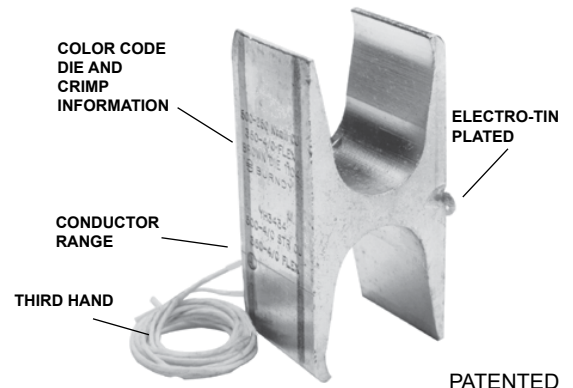

TABLE 1 CODE CONDUCTOR AND METRIC EQUIVALENT

H-Tap Connector	Kit Catalog Number		Conductor Sizes Code/(Flex Cable)					Metric Conductor Sizes (mm ²)			
	Flame Retardant Cover		Fig. No.	Main	Tap 1	Tap 2	Tap 3	Main	Tap 1	Tap 2	Tap 3
	Clear	Black †									
YH4444	YH4444WCC	YH4444WC	1	1000-750 (750-500) (750)	1000-750 (750-500) (750)	—	—	500-400	500-400	—	—
YH4434	YH4434WCC*	YH4434WC	6	1000-750 (750-500) (750)	500-250 (350-4/0)	—	—	1000-750 (777-500) (777-750)	500-350 (350 FX)	—	—
YH4429	YH4429WCC	YH4429WC	5	1000-750 (777-500)	250-2 (4/0-2)	—	—	500-400	150-35	—	—
YH3939	YH3939WCC	YH3939WC	1	750-500 (550-500)	750-350 (550-313)	—	—	300-300	300-185	—	—
YH3931	YH3931WCC	YH3931WC	2	750-350 (550-500)	4/0-1/0 (250-1/0)	1-6 Str/Sol (1-8)	2-14 (2-14)	300-185	95-70	35-16	35-2.5
YH3434	YH3434WCC	YH3434WC	1	500-250 (350-4/0)	500-4/0 (350-4/0)	—	—	240-150	240-120	—	—
YH3429	YH3429WCC	YH3429WC	2	500-4/0 (350-4/0)	250/1/0 (4/0-1/0)	1-6 Str/Sol (1-8)	8-14 (8-14)	240-120	120-70	35-16	6-2.5
YH2929	YH2929WCC	YH2929WC	1	250-2 (4/0-2)	250-2 (4/0-2)	—	—	120-35	120-35	—	—
YH292C	YH292CWCC	YH292CWC	3	250-2 (4/0-2)	2-6 Str/Sol (2-8)	8-14	—	120-35	35-16	6-2.5	—
YH298C	YH298CWCC	YH298CWC	3	250-2 (4/0-2)	8-14	8-14	—	120-35	6-2.5	6-2.5	—
YH2C2C	YH2C2CWCC	YH2C2CWC	4	2-6 Str/Sol (2-8)	2-6 Str/Sol (2-8)	8-14	8-14	35-16	35-16	6-2.5	6-2.5
YH6C6C	YH6C6CWCC	YH6C6CWC	1	6-10 (6-10)	6-14 (6-14)	—	—	10-6	10-2.5	—	—
YH8C8C	YH8C8CWCC	YH8C8CWC	4	8-14 (8-14)	8-14 (8-14)	—	—	6-2.5	6-2.5	—	—

• Use PUADP1 adaptor with U dies in 46 Series.

* Not CSA Certified.

▲ See tooling section of this catalog for complete tool and die listings.

Note: All H-Taps ROHS compliant.

Note: All dimensions shown are for reference only.

TYPE YH (Continued)

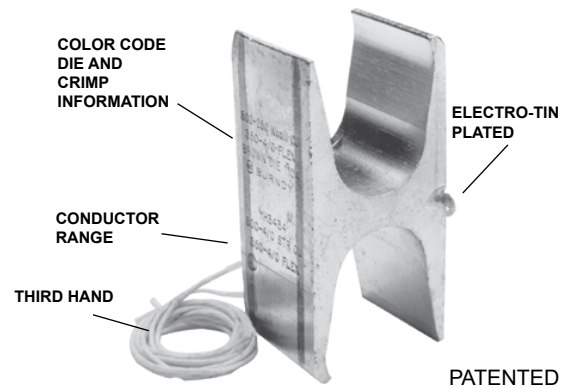

TABLE 2 FLEX AND METRIC CONDUCTOR RANGES

Catalog Number		Maximum Conductor in Range		Diameter mm	Minimum Conductor in Range		Diameter mm
		Flex Conductor (AWG/kcmil)	Maximum Metric Dimensions mm ²		Flex Conductor (AWG/kcmil)	Minimum Metric Dimensions mm ²	
YH4444	Main	777	393	28	500	253	24
	Tap 1	777	393	28	500	253	24
	Main	777	393	28	750	380	31
YH4434	Tap 1	—	—	—	350	177	20
YH4429	Main	777	393	28	500	253	24
	Tap 1	4/0	107	15.5	2	33.6	8
YH3939	Main	550	278	25	500	253	24
	Tap 1	550	278	25	2	177	20
YH3931	Main	550	278	25	500	253	24
	Tap 1	250	126	17	1/0	53.5	11
	Tap 2	1	42	9	8	8	4
	Tap 3	2	33.6	8	14	2	2
YH3434	Main	350	177	20	4/0	107	15.5
	Tap 1	350	177	20	4/0	107	15.5
YH3429	Main	350	177	20	4/0	107	15.5
	Tap 1	4/0	107	15.5	1/0	53	11
	Tap 2	1	42	9	8	8	4
	Tap 3	8	8	4	14	2	2
YH2929	Main	4/0	107	15.5	2	33.6	8
	Tap 1	4/0	107	15.5	2	33.6	8
YH292C	Main	4/0	107	15.5	2	33.6	8
	Tap 1	2	33.6	8	8	8	4
	Tap 2	8	8	4	14	2	2
YH298C	Main	4/0	107	15.5	2	33.6	8
	Tap 1	8	8	4	14	2	2
	Tap 2	8	8	4	14	2	2
YH2C2C	Main	2	33.6	8	8	8	4
	Tap 1	2	33.6	8	8	8	4
	Tap 2	8	8	4	14	2	2
	Tap 3	8	8	4	14	2	2
YH6C6C	Main	6	13	5	10	5	3
	Tap 1	6	13	5	14	2	2
YH8C8C	Main	8	8	4	14	2	2
	Tap 1	8	8	4	14	2	2

• Use PUADP1 adaptor with U dies in 46 Series.

▲ See tooling section of this catalog for complete tool and die listings.

* Not CSA Certified.

Note: All H-Taps ROHS compliant.

Note: All dimensions shown are for reference only.

TYPE YH (Continued)

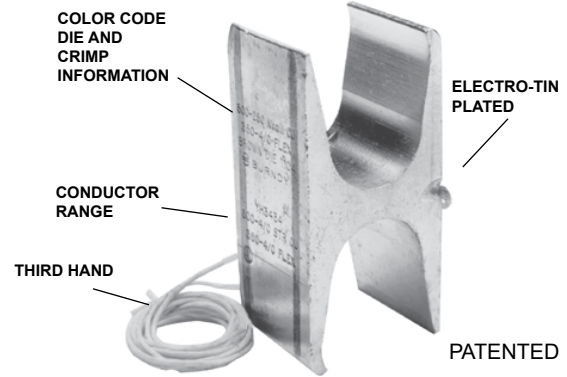

TABLE 3 INSTALLATION TOOLING + DIMENSIONS

Catalog Number	Kit Catalog Number		▲ Tooling († No. of Crimps)								▲ Die Index & Embossment	H	W	Length	Strip Length
	Flame Retardant Cover		Fig. No.	35 Series	†	750 Series	†	46* Series	†	Color Code					
	Clear	Black ‡													
YH4444	YH4444WCC	YH4444WC	1	—	—	—	—	P1102	1	White	1102	3.38	1.70	24	1-1/8
YH4434	YH4434WCC*	YH4434WC	6	—	—	—	—	P1102	1	Yellow	KR	3.38	1.70	1.00	1-3/8
YH4429	YH4429WCC	YH4429WC	5	—	—	—	—	PYFR	1	Yellow	KR	3.22	1.70	1.00	1-3/8
YH3939	YH3939WCC	YH3939WC	1	—	—	—	—	PYFR	1	Yellow	KR	2.97	1.50	1.25	1-3/8
YH3931	YH3931WCC	YH3931WC	2	—	—	—	—	PYFR	1	Yellow	KR	2.97	1.50	0.95	1-1/16
YH3434	YH3434WCC	YH3434WC	1	—	—	U1104M U1104	1 2	P1104 U1104M	1 1	Brown	1104	2.43	1.15	1.00	1-1/8
YH3429	YH3429WCC	YH3429WC	2	—	—	U1104M U1104	1 2	P1104 U1104M	1 1	Brown	1104	2.23	1.31	1.00	1-1/8
YH2929	YH2929WCC	YH2929WC	1	—	—	U654	1	U654 P654	1	Purple	654	1.85	.90	0.90	1-1/16
YH292C	YH292CWCC	YH292CWC	3	—	—	U654	1	U654 P654	1	Purple	654	1.52	.90	0.90	1-1/16
YH298C	YH298CWCC	YH298CWC	3	—	—	U654	1	U654 P654	1	Purple	654	1.52	.90	0.90	1-1/16
YH2C2C	YH2C2CWCC	YH2C2CWC	4	U-C	1	UC	1	UC	1	Brown	C	1.25	.60	0.75	7/8
YH6C6C	YH6C6CWCC	YH6C6CWC	1	UBGRT	1	UBGRT	1	UBGRT	1	Orange	BG	0.81	.39	0.60	3/4
YH8C8C	YH8C8CWCC	YH8C8CWC	4	U11T1	1	U11T1	1	U11T1	1	Green	11	0.63	.40	0.60	3/4

• Use PUADP1 adaptor with U dies in 46 Series.

* Not CSA Certified.

▲ See tooling section of this catalog for complete tool and die listings.

Note: All H-Taps ROHS compliant.

Note: All dimensions shown are for reference only.

TYPE CF-FR

H-Tap Flame Retardant Cover

UL Listed 90° C, Up to 600 Volts



Features & Benefits

- Insulation cover that has a one-piece hinge design so not extra hardware is required
- After an H-tap connection is made, the appropriate CF-FR cover can be used to slip over the connection and latches securely shut
- The use of the insulation cover eliminates the need to tape the connection, making this solution a fast and reliable method of insulating
- Flash Barrier; the cover is designed to protect against electrical flashover
- Type CF-FR cover material has a UL94 V-O Flame rating with a minimum 28 oxygen index that indicate self-extinguishing retardant properties
- Covers are clearly marked with lettering
- BURNDY certifies its products using the BURNDY Engineered System and select other crimp tool manufacturers in accordance with one or more of the UL categories in order to obtain a UL Listing

Catalog Number	Max. Conductor Accommodated	Matched H Copper CRIMPIT™	Max. Connector Length	Connector Color Code
CFBGFR	#8 AWG	YH8C8C	0.65	Green
	#6 AWG	YH6C6C	0.65	Orange
CFOFR	#2 AWG	YH2C2C	0.80	Brown
CFDFR	250 kcmil	YH292C, YH298C, YH2929	0.95	Purple
CFNFR	500 kcmil	YH3434, YH3429*	1.10	Brown
CFRFR	750 kcmil	YH3939, YH3931, YH4429	1.30	Yellow
	1000 kcmil	YH4434, YH4444	1.10	White

* Use CFNFR for single tap installation; use CFRFR when 2 or more tap conductors are installed.

† Two-piece design packaged together.

Note: All dimensions shown are for reference only.

TYPE CCF-FR

Clear H-Tap Flame Retardant Cover

UL Listed 90° C, Up to 600 Volts

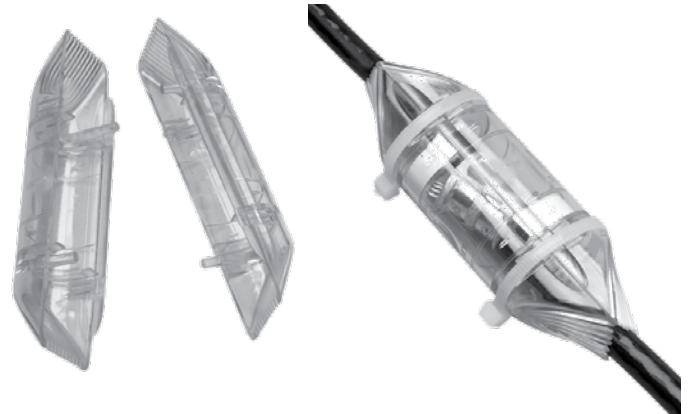

Features & Benefits

- Insulation cover that has a two-piece design with positive locking latch to ensure correct installation; prevents opening after installation
- After an H-tap connection is made, the appropriate Type CCF-FR cover can be used to slip over the connection and latch securely shut
- Embedded magnifying lense in the cover provides increased visibility of the H-tap die embossment on the connector made by the require installation tooling; this allows for improved visibility during a connection inspection
- Made of polished clear polycarbonate material that provides:
 - High visibility for inspection of installed H-tap connection
 - Built-in channels on the outside of the covers accommodate and hold cable ties, hook and loop ties, or waxed cord security in place after cover installation
 - Patented highly flexible fingers on each cover are designed to contour around the wire
 - Internal pockets designed to accommodate identification tags (4 ID tags included)
 - UL94 V-O Flame rating indicating self-extinguishing retardant properties
- The use of the insulation cover eliminates the need to tape the connection making this solution a fast and reliable method of insulating
- Molded barrier prevents installed H-tap connectors from electrical flashover
- Covers come with two (2) clear halves, two (2) cable ties, and four (4) identification tags

- Covers are clearly marked with lettering
- BURNDY certifies its products using the BURNDY Engineered System and select other crimp tool manufacturers in accordance with one or more of the UL categories in order to obtain a UL Listing

Catalog Number	Max. Conductor Accommodated	Matched H Copper CRIMPIT™	Max. Connector Length	Connector Color Code
CCFBGFR	#8 AWG	YH8C8C	0.65	Green
	#6 AWG	YH6C6C	0.65	Orange
CCFOFR	#2 AWG	YH2C2C	0.80	Brown
CCDFR	250 kcmil	YH292C, YH298C	0.95	Purple
CCFDXFR	250 kcmil	YH2929	0.95	Purple
CCFNFR	500 kcmil	YH3434, YH3429*	1.10	Brown
CCFRFR	750 kcmil 1000 kcmil	YH3939, YH3931,	1.30	Yellow
		YH4429, YH4434,	1.10	White
		YH4444		

* Use CCFNFR for single tap installation; use CCFRFR when 2 or more tap conductors are installed.

Note: All dimensions shown are for reference only.

TYPE YSH

H Copper CRIMPIT™ Split Compression Wye Tap Connector

Type YSH heavy duty connectors are designed for insulated underground wye splices. The split H copper CRIMPIT™ connector is longer than our standard H copper CRIMPIT™ and is suitable for use on high voltage (15kV) power cables with copper conductors. The connectors cannot be used with oil filled or mass impregnated cables since no oil stop is provided. The connector is installed with standard BURNDY® HYPRESS™ tools and is made of tin-plated electrolytic copper.

Features & Benefits

- Range taking H-tap that allows for less inventory as one H-tap can accommodate a multitude of wire combinations
- Accommodates a wide range of run / tap combinations
- The tap grooves act independently; the use of one run and one tap wire is required when using this connector for making a connection
- Manufactured from high conductivity wrought copper providing low resistance for excellent electrical conductivity
- Electro-tin plated unless otherwise specified to reduce galvanic corrosion (bimetallic) and resist corrosive elements
- Color coded to ensure proper die and installation tooling is selected
- Insulation is not provided; insulation may be obtained from Raychem (800-272-9243) Type HVSJ Splice Kits for 15kV installations; a complete IEEE 404 15kV installation is provided

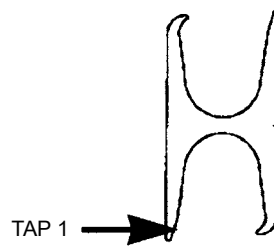
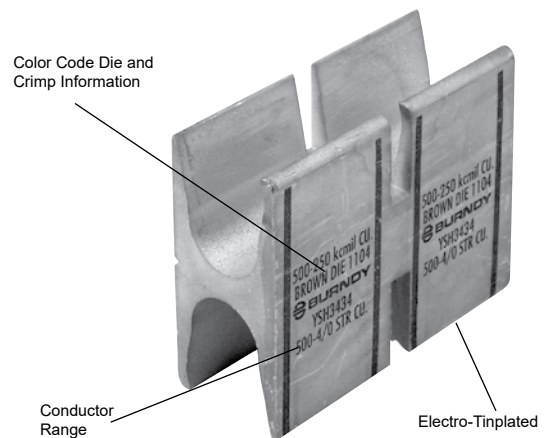

Fig. 1

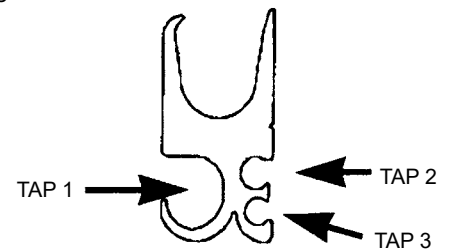
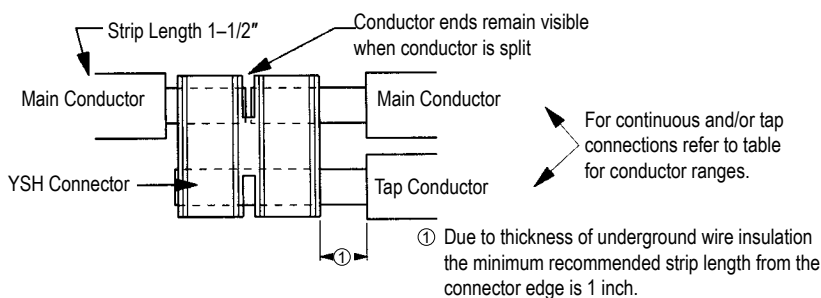

Fig. 2

Accessories

- Hardware - Section F
- PENETROX™ Oxide Inhibitor - Section F
- Heat and Cold Shrink Tubing - Section D
- WIREMIKE™ Wire Micrometer - Section F
- Wire Management (Cable Ties) - Section G



TYPE YSH (Continued)

Expanded Tap 1 Components	
Expanded Catalog Number	Tap 1 Range
YSH-292C-E	#2 Str.
YSH-2925-E	1/0 Str.

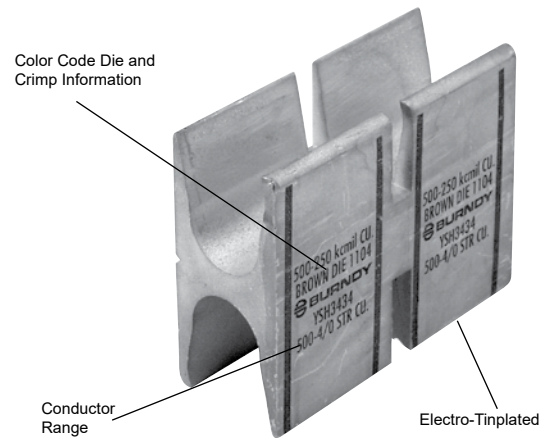

Catalog Number	Fig. #	Conductor Sizes Code Expanded Tap 1 (Flex Cable)				750 Series	†	46* Series	†	Color Code	Die Index ▲ & Embossment	H	W	L	Wire Strip Length
		AWG	Tap 1	Tap 2	Tap 3										
YSH2929	1	250 kcmil - #2 AWG (4/0 - 2)	250 kcmil - #2 AWG (4/0 - 2)	-	-	U654	4	P654	2	Purple	654	1.85 in	0.90 in	3.00 in	1 1/2
YSH3429	2	500 kcmil - 4/0 AWG (350 - 4/0)	250 kcmil - 1/0 AWG (4/0 - 1/0)	#1- #6 AWG (1 - 8)	#8- #14 AWG (8 - 14)	U1104	4	P1104	2	Brown	1104	2.23 in	1.31 in	3.00 in	1 1/2
YSH3434	1	500-250 kcmil (350 - 4/0)	500 kcmil-4/0 AWG (350 - 4/0)	-	-	U1104	4	P1104	2	Brown	1104	2.43 in	1.15 in	3.00 in	1 1/2
YSH3931	2	750 - 350 kcmil (550 - 500)	4/0 - 1/0 AWG (350 - 1/0)	#1-#6 AWG (1 - 8)	#2-#14 AWG (2 - 14)	-	-	PYFR	2	Yellow	KR	2.97 in	1.50 in	3.00 in	1 1/2
YSH3939	1	750 - 500 kcmil (550 - 500)	750 - 350 kcmil (550 - 350)	-	-	-	-	PYFR	2	Yellow	KR	2.97 in	1.50 in	3.00 in	1 1/2

* Use PUADP1 adaptor with U dies in 46 Series. P dies result in a smooth crimp surface and is recommended for voltages above 600 V.

▲ See tooling section of this catalog for complete tool and die listings.

† Number of crimps per connector. U dies require double crimps.

Note: All dimensions shown are for reference only.

TYPE YST

Uninsulated Copper HYTEE™ T-Coupler



UL Listed to 90° C, Up to 35 kV ♦

Type YST copper compression tee is designed for connecting a run conductor with a perpendicular tap conductor. Type YST connectors are commonly used in junction boxes and manholes to make a radial tap off a main run. They are needed in many industrial, utility generation, and commercial applications. The most common cable combinations are listed below. The Type Y-R reducers can also be used to accommodate most cable combinations.

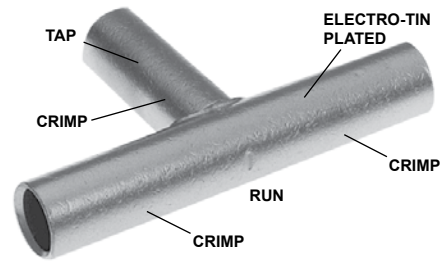

Features & Benefits

- Manufactured from high conductivity electrolytic copper tubing with heavy wall thickness, Type YST T-couplers provide low resistance for excellent electrical conductivity
- Featuring long barrel length for all three wire wire accommodating barrels allows for an increased number of crimps, in turn increasing the mechanical strength of the connection while allowing the connection to operate at a lower temperature rating; additionally, the long barrel permits the use of the Type Y-R reducing adapters
- Accommodates a wide range of run / tap combinations
- Electro-tin plated unless otherwise specified to reduce galvanic corrosion (bimetallic) and resist corrosive elements
- Connectors are clearly marked
- BURNDY certifies its products using the BURNDY Engineered System and select other crimp tool manufacturers in accordance with one or more of the UL categories in order to obtain a UL Listing

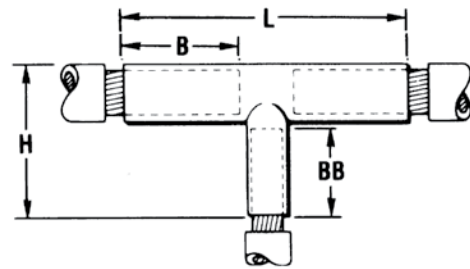

Catalog Number	Code • Conductors		Dimensions				Dieless (# of crimps)	Installation Tooling ▲						Wire Length		
								Run Conductors			Tap Conductors					
	Run	Tap	B	BB	H	L		35 ■, 750, 46* Series			35 ■, 750, 46* Series			Run	Tap	
								Die Number (# of crimps)	Color Code	Die Index	Die Number (# of crimps)	Color Code	Die Index ▲			
YST4C4C	4 str.	4 str.	1.12	1.38	1.72	3.25	644 Series (1) 81K Series (1)	U4CRT (2)	Gray	8	U4CRT (2)	Gray	8	1-3/16"	1-3/16"	
YST2C2C	2 str.	2 str.	1.25	1.56	1.98	3.56		U2CRT (2)	Brown	10	U2CRT (2)	Brown	10	1-5/16"	1-5/16"	
YST2525	1/0 str.	1/0 str.	1.38	1.56	1.91	3.81		U25RT (2)	Pink	12	U25RT (2)	Pink	12	1-7/16"	1-7/16"	
YST2626	2/0 str.	2/0 str.	1.50	1.67	2.18	3.94		U26RT (2)	Black	13	U26RT (2)	Black	13	1-9/16"	1-9/16"	
YST282C	4/0 str.	2 str.	1.62	1.50	2.12	3.94		U28RT (2)	Purple	15	U2CRT (2)	Brown	10	1-11/16"	1-5/16"	
YST2825	4/0 str.	1/0 str.	1.62	1.56	2.25	4.00		U28RT (2)	Purple	15	U25RT (2)	Pink	12	1-11/16"	1-5/8"	
YST2828	4/0 str.	4/0 str.	1.62	1.75	2.44	4.19		—	U28RT (2)	Purple	15	U28RT (2)	Purple	15	1-11/16"	1-13/16"
YST2929	250 kcmil	250 kcmil	1.62	1.78	2.53	4.25		—	U29RT (2)	Yellow	16	U29RT (2)	Yellow	16	1-11/16"	1-11/16"
YST3131	350 kcmil	350 kcmil	2.00	2.25	3.12	5.50	644 Series (2) 81K Series (2)	U31RT (4)	Red	18	U31RT (4)	Red	18	2"	2"	
YST3428	500 kcmil	4/0 str.	2.25	1.75	2.81	5.81		U34RT (4)	Brown	20	U28RT (2)	Purple	15	2-5/16"	1-11/16"	
YST3434	500 kcmil	500 kcmil	2.25	2.70	3.76	6.19		U34RT (4)	Brown	20	U34RT (4)	Brown	20	2-5/16"	2-5/16"	
YST3939	750 kcmil	750 kcmil	2.88	3.34	4.64	8.12		U39RT (4)	Black	24	U39RT (4)	Black	24	2-15/16"	2-15/16"	
								U39RT (4)	Black	24	U39RT (4)	Black	24	2-15/16"	2-15/16"	

* Use adapter PUADP1 with U Dies in 46 Series.

■ The maximum size for the Y35 is 400 kcmil.

● Contact factory for conductor combinations not shown.

▲ See tooling section of this catalog for complete tool and die listings.

♦ For applications greater than 2000 Volts consult cable manufacturer for voltage stress relief instructions.

Note: All dimensions shown are for reference only.

TYPE YA-A

HYLUG™

UL Listed 90° C, Up to 35 kV ♦



Type YA-A aluminum tin-plated compression HYLUG™ terminals are dual-rated and designed for use on both aluminum and copper conductors from #12 solid through 2000 kcmil.

See Pages C-194 through C-197 for Type YA-A Installation Tooling Information.

Features & Benefits

- UL486A-486B Listed and CSA Certified
- Aluminum terminals are dual rated to accommodate both copper and aluminum wire and are indicated with AL-CU on the connector:
 - AL9CU indicates the terminal can accommodate aluminum and copper wire and is UL Listed 90°C, up to 35kV
 - AL7CU indicates the terminal can accommodate aluminum and copper wire and is UL Listed 75°C, up to 35kV
- Barrel is designed with an internal chamfer at the wire entry to ensure smooth insertion of the wire, preventing possible damaging of the wire strands during insertion
- 45° and 90° angular lugs are available, please contact Customer Service
- Electro-tin plated unless otherwise specified to reduce galvanic corrosion (bimetallic) and resist corrosive elements
- Connectors are clearly marked with wire size, die index, color code, and crimp location bands
- Factory pre-filled with PENETROX™ Type A13 oxide inhibitor
- Color coded end caps are factory inserted in the barrels to match the die color code and prevent foreign materials from entering the barrel
- Aluminum oxidation is not easily detected but causes resistance in a connection; it is imperative the proper preparation takes place prior to making an aluminum-to-aluminum connection
- BURNDY certifies its products using the BURNDY Engineered System and select other crimp tool manufacturers in accordance with one or more of the UL categories in order to obtain a UL Listing
- Connectors have been tested with expanded wire ranges when installed with specified dieless tools. See Beginning of Section C for Expanded Ranges Tables.
- Conductor Accommodate Types:
 - Aluminum Code Wire: Class B (Concentric, Compressed, Compact)
 - Copper Code Wire: Class B (Concentric, Compressed, Compact or Class C)
 - Copper Clad Aluminum: Noted in the conductor accommodates as CCA

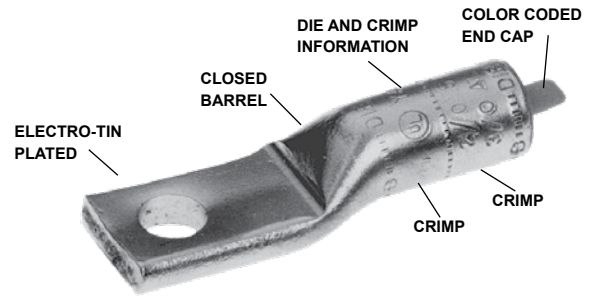

NOTE: Field bending straight lugs to achieve an angular connection will void UL Listing / CSA Certifications and BURNDY will not be liable for the connection.

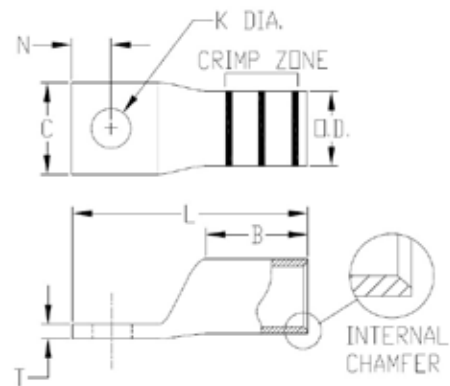

Accessories

- Hardware - Section F
- PENETROX™ Oxide Inhibitor - Section F
- Heat and Cold Shrink Tubing - Section D
- WIREMIKE™ Wire Micrometer - Section F
- Wire Management (Cable Ties) - Section G

Compression Connections

Aluminum / Copper — One Hole
Uninsulated Aluminum Terminals

TYPE YA-A (Continued)



AL9CU



NOTE: Field bending straight lugs to achieve an angular connection will void UL Listing / CSA Certifications and BURNDY will not be liable for the connection.

Catalog Number	AL / Cu Conductor	Dimensions									Color Code	Die Index	Wire Strip Length	Temperature Rating
		Stud Size	Stud Hole Diameter (K)	No. of Holes in Pad	Outside Diameter (OD)	Barrel Length (B)	Pad Width (C)	Overall Length (L)	Hole Offset (N)	Pad Thickness (T)				
YA12ATN*	12 AWG Sol./Str.	#10	0.20	1	0.21	0.50	0.41	1.19	0.20	0.07	—	—	5/8	75° C
YA10ATN*	10 AWG Sol./Str.	#10	0.20	1	0.21	0.50	0.41	1.22	0.20	0.06	—	—	5/8	75° C
YA8CA1	8 AWG	#10	0.20	1	0.30	0.62	0.53	1.50	0.20	0.09	Blue	374	5/8	75° C
YA8CA3		1/4	0.28	1	0.30	0.62	0.53	1.65	0.25	0.09				
YA6CA1	6 AWG	1/4	0.28	1	0.34	0.75	0.47	1.84	0.33	0.14	Gray	346	3/4	90° C
YA6CA3		3/8	0.44	1	0.34	0.75	0.65	2.28	0.44	0.09				
YA4CA1	4 AWG	1/4	0.28	1	0.43	0.88	0.47	2.13	0.33	0.18	Green	375	7/8	90° C
YA4CA3		5/16	0.38	1	0.43	0.88	0.80	2.25	0.41	0.12				
YA4CA6		3/8	0.44	1	0.43	0.88	0.80	2.32	0.44	0.12				
YA2CA5	2 AWG	1/4	0.28	1	0.53	1.00	0.50	2.25	0.33	0.22	Pink	348	1-1/8	90° C
YA2CA1		5/16	0.38	1	0.53	1.12	0.88	2.50	0.41	0.16				
YA2CA3		3/8	0.44	1	0.53	1.12	0.88	2.56	0.44	0.16				
YA1CA1	1 AWG	3/8	0.44	1	0.54	0.91	0.76	2.59	0.44	0.19	Gold	471	15/16	90° C
YA25A1	1/0 AWG	5/16	0.38	1	0.60	1.00	0.60	2.31	0.41	0.21	Tan	296	1-1/16	90° C
YA25A3		3/8	0.44	1	0.60	1.05	0.82	2.67	0.63	0.21				
YA25A9		1/2	0.56	1	0.60	1.05	1.03	2.83	0.63	0.17				
YA26A7	2/0 AWG	5/16	0.38	1	0.67	1.17	0.67	2.52	0.41	0.24	Olive	297	1-3/8	90° C
YA26A6		3/8	0.44	1	0.67	1.17	0.67	2.79	0.44	0.24				
YA26A1		1/2	0.56	1	0.67	1.17	1.03	3.03	0.63	0.20				
YA26A8		5/8	0.69	1	0.67	1.17	1.03	3.03	0.63	0.20				
YA27A1	3/0 AWG	3/8	0.44	1	0.76	1.11	0.73	2.88	0.44	0.26	Ruby	467	1-1/2	90° C
YA27A3		1/2	0.56	1	0.76	1.31	1.04	3.27	0.63	0.26				
YA28A1	4/0 AWG	3/8	0.44	1	0.85	1.39	1.17	3.26	0.44	0.30	White	298	1-5/8	90° C
YA28A3		1/2	0.56	1	0.85	1.39	1.17	3.44	0.63	0.30				
YA29A9	250 kcmil	3/8	0.41	1	0.92	1.45	1.26	3.09	0.41	0.33	Red	324	1-9/16	90° C
YA29A1		1/2	0.56	1	0.92	1.45	1.26	3.53	0.63	0.33				
YA29A6		5/8	0.69	1	0.92	1.45	1.26	3.69	0.75	0.33				
YA30A6	300 kcmil 4/0 AWG CCA DLO (329/22)	3/8	0.44	1	1.01	1.53	1.38	3.90	0.63	0.36	Blue	470	1-3/4	90° C
YA30A1		1/2	0.56	1	1.01	1.53	1.38	3.90	0.63	0.36				
YA31A6	350 kcmil 250 kcmil CCA DLO (399/22)	3/8	0.44	1	1.11	1.85	1.52	3.95	0.44	0.39	Brown	299	2-1/8	90° C
YA31A1		1/2	0.56	1	1.11	1.85	1.52	4.33	0.63	0.39				
YA31A12		5/8	0.65	1	1.11	1.85	1.52	4.33	0.44	0.39				
YA32A9	400 kcmil	3/8	0.41	1	1.19	2.26	1.62	3.95	0.41	0.43	Green	472	2-5/16	90° C
YA32A6		1/2	0.56	1	1.19	2.26	1.62	4.92	0.88	0.43			2-1/2	90° C
YA32A1		5/8	0.69	1	1.19	2.26	1.62	4.92	0.88	0.43			2-1/2	90° C

- Contact BURNDY® for conductor, stud sizes and hole drillings not shown.
- ♦ For applications greater than 2000 Volts consult cable manufacturer for voltage stress relief instructions.
- * AL Conductor Only

Note: All dimensions shown are for reference only.

See Pages C-194 through C-197 for Type YA-A Installation Tooling Information.

TYPE YA-A (Continued)



AL9CU



NOTE: Field bending straight lugs to achieve an angular connection will void UL Listing / CSA Certifications and BURNDY will not be liable for the connection.

Catalog Number	AL / Cu Conductor	Dimensions									Color Code	Die Index	Wire Strip Length	Temperature Rating
		Stud Size	Stud Hole Diameter (K)	No. of Holes in Pad	Outside Diameter (OD)	Barrel Length (B)	Pad Width (C)	Overall Length (L)	Hole Offset (N)	Pad Thickness (T)				
YA34A7	500 kcmil	1/2	0.56	1	1.32	2.34	1.80	5.02	0.63	0.46	Pink	300	2-5/8	90° C
YA34A1	350 kcmil CCA DLO (551/22)	5/8	0.69	1	1.32	2.34	1.80	5.56	0.88	0.46				
YA36A8	600 kcmil	1/2	0.56	1	1.44	2.47	1.97	5.64	0.69	0.52	Black	473	2-7/8	90° C
YA36A1	500 kcmil CCA DLO (779/22)	5/8	0.69	1	1.44	2.47	1.97	5.82	0.88	0.52				
YA39A1	700 - 750	1/2	0.56	1	1.46	2.46	2.05	5.26	0.63	0.43	Yellow	936	2-7/8	90° C
YA39A3	kcmil	5/8	0.69	1	1.46	2.46	2.05	5.80	0.88	0.43				
YA39A34	900 kcmil Compact AL† 600 kcmil CCA DLO (925/22)	3/4	0.81	1	1.46	2.46	2.05	6.17	1.00	0.43				
YA42A1	900 kcmil AL	1/2	0.56	1	1.50	2.46	2.14	5.32	0.63	0.39	Gray	303	2-7/8	90° C
YA42A3		5/8	0.69	1	1.50	2.46	2.14	5.32	0.66	0.39				
YA44A1	1000 kcmil 750 kcmil CCA DLO (1194/22) 800 kcmil CCA DLO (1258/22)	5/8	0.69	1	1.84	2.74	2.50	6.50	0.88	0.66	Brown	302	3	90° C

- Contact BURNDY® for conductor, stud sizes and hole drillings not shown.
 - ♦ For applications greater than 2000 Volts consult cable manufacturer for voltage stress relief instructions.
 - † Listed using 444S / 644 Series Tools only.
- Note:** All dimensions shown are for reference only.

See Pages C-194 through C-197 for Type YA-A Installation Tooling Information.

TYPE YA-A

HYLUG™

UL Listed 90° C, Up to 35 kV ♦



Type YA-A terminals in 2- and 4-hole designs inhibit connector rotation and increase area contact. These aluminum terminals have the same design features and benefits as the 1-hole YA-A with an added stud hole for a more secure termination to various types of equipment pads. They are dual-rated for use on both aluminum and copper conductors.

See Pages C-194 through C-197 for Type YA-A Installation Tooling Information.

Features & Benefits

- UL486A-486B Listed and CSA Certified
- Aluminum terminals are dual rated to accommodate both copper and aluminum wire and are indicated with AL-CU on the connector:
 - AL9CU indicates the terminal can accommodate aluminum and copper wire and is UL Listed 90°C, up to 35kV
 - AL7CU indicates the terminal can accommodate aluminum and copper wire and is UL Listed 75°C, up to 35kV
- Barrel is designed with an internal chamfer at the wire entry to ensure smooth insertion of the wire, preventing possible damaging of the wire strands during insertion
- 45° and 90° angular lugs are available, please contact Customer Service
- Electro-tin plated unless otherwise specified to reduce galvanic corrosion (bimetallic) and resist corrosive elements
- Connectors are clearly marked with wire size, die index, color code, and crimp location bands
- Factory pre-filled with PENETROX™ Type A13 oxide inhibitor
- Color coded end caps are factory inserted in the barrels to match the die color code and prevent foreign materials from entering the barrel
- Aluminum oxidation is not easily detected but causes resistance in a connection; it is imperative the proper preparation takes place prior to making an aluminum-to-aluminum connection
- BURNDY certifies its products using the BURNDY Engineered System and select other crimp tool manufacturers in accordance with one or more of the UL categories in order to obtain a UL Listing
- Connectors have been tested with expanded wire ranges when installed with specified dieless tools. See Beginning of Section C for Expanded Ranges Tables.
- Conductor Accommodate Types:
 - Aluminum Code Wire: Class B (Concentric, Compressed, Compact)
 - Copper Code Wire: Class B (Concentric, Compressed, Compact or Class C)
 - Copper Clad Aluminum: Noted in the conductor accommodates as CCA

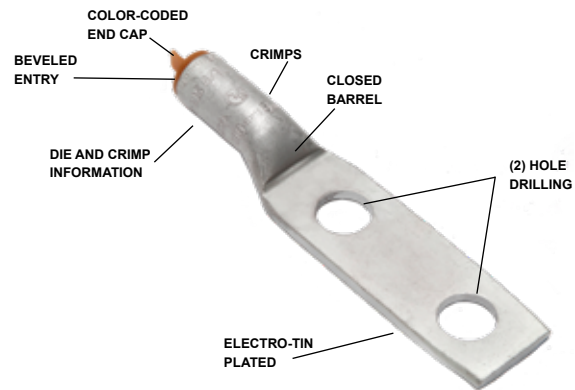

NOTE: Field bending straight lugs to achieve an angular connection will void UL Listing / CSA Certifications and BURNDY will not be liable for the connection.

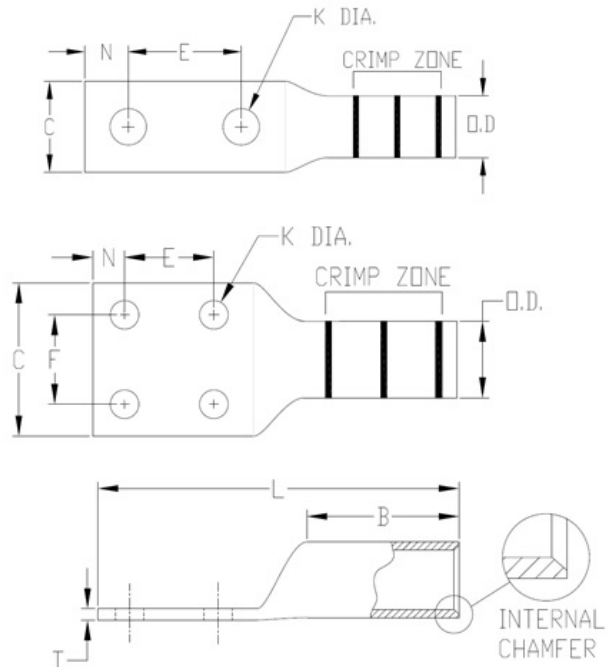

Accessories

- Hardware - Section F
- PENETROX™ Oxide Inhibitor - Section F
- Heat and Cold Shrink Tubing - Section D
- WIREMIKE™ Wire Micrometer - Section F
- Wire Management (Cable Ties) - Section G

TYPE YA-A (Continued)



AL9CU



NOTE: Field bending straight lugs to achieve an angular connection will void UL Listing / CSA Certifications and BURNDY will not be liable for the connection.

Catalog Number	AL / Cu Conductor	Stud Size	Stud Hole Diameter (K)	No. of Holes in Pad	Dimensions								Color Code	Die Index	Wire Strip Length	Temperature Rating
					Outside Diameter (OD)	Barrel Length (B)	Pad Width (C)	Overall Length (L)	Hole Spacing (E)	Hole Spacing (F)	Hole Offset (N)	Pad Thickness (T)				
YA2CA9	2 str.	1/2	0.56	2	0.53	1.12	0.88	4.73	1.75	—	0.63	0.16	Pink	348	1-1/8	90° C
YA25A7	1/0 str.	1/2	0.56	2	0.60	1.05	1.03	4.59	1.75	—	0.63	0.17	Tan	296	1-1/16	90° C
YA25A5		3/8	0.44	2	0.60	1.05	0.82	3.73	1.06	—	0.63	0.21				
YA26A3	2/0 str.	1/2	0.56	2	0.67	1.17	1.03	4.78	1.75	—	0.63	0.20	Olive	297	1-3/8	90° C
YA26A5		3/8	0.44	2	0.67	1.17	0.92	3.56	1.00	—	0.44	0.24				
YA27A7	3/0 str.	3/8	0.44	2	0.76	1.31	1.04	3.79	1.00	—	0.44	0.26	Ruby	467	1-1/2	90° C
YA27A5		1/2	0.56	2	0.76	1.31	1.04	5.02	1.75	—	0.63	0.26				
YA28A7	4/0 str.	3/8	0.44	2	0.85	1.39	1.17	3.97	1.00	—	0.44	0.30	White	298	1-5/8	90° C
YA28A5		1/2	0.56	2	0.85	1.39	1.17	5.19	1.75	—	0.63	0.30				
YA29A5	250 kcmil	3/8	0.44	2	0.92	1.45	1.26	4.06	1.00	—	0.44	0.33	Red	324	1-5/8	90° C
YA29A3		1/2	0.56	2	0.92	1.45	1.26	5.28	1.75	—	0.63	0.33				
YA30A5	300 kcmil 4/0 AWG CCA DLO (329/22)	3/8	0.44	2	1.01	1.53	1.38	4.42	1.00	—	0.44	0.36	Blue	470	1-3/4	90° C
YA30A3		1/2	0.56	2	1.01	1.53	1.38	5.64	1.75	—	0.63	0.36				
YA31A5	350 kcmil 250 kcmil CCA DLO (399/22)	3/8	0.44	2	1.11	1.85	1.52	4.85	1.00	—	0.44	0.39	Brown	299	2-1/8	90° C
YA31A3		1/2	0.56	2	1.11	1.85	1.52	6.07	1.75	—	0.63	0.39				
YA32A5	400 kcmil	3/8	0.44	2	1.19	2.26	1.62	4.93	1.00	—	0.44	0.43	Green	472	2	90° C
YA32A3		1/2	0.56	2	1.19	2.26	1.62	6.15	1.75	—	0.63	0.43				
YA34A5	500 kcmil 350 kcmil CCA DLO (551/22)	3/8	0.44	2	1.32	2.34	1.80	5.54	1.00	—	0.44	0.46	Pink	300	2-5/8	90° C
YA34A3 †		1/2	0.56	2	1.32	2.34	1.62	6.80	1.75	—	0.63	0.46				
YA34A8		1/2	0.56	2	1.32	2.34	1.80	6.77	1.75	—	0.63	0.46				
YA36A5	600 kcmil 500 kcmil CCA DLO (779/22)	3/8	0.44	2	1.44	2.47	1.97	5.64	1.00	—	0.69	0.52	Black	473	2-7/8	90° C
YA36A3 †		1/2	0.56	2	1.44	2.47	1.62	7.09	1.75	—	0.63	0.52				
YA36A17		1/2	0.56	2	1.44	2.47	1.97	7.06	1.75	—	0.63	0.52				

† Narrow tongue design; may be mounted side-by-side on a 4-hole NEMA pad
 • Contact BURNDY® for conductor, stud sizes and hole drillings not shown.
 ♦ For applications greater than 2000 Volts consult cable manufacturer for voltage stress relief instructions.
Note: All dimensions shown are for reference only.

See Pages C-194 through C-197 for Type YA-A Installation Tooling Information.

Compression Connections

Aluminum / Copper — Two and Four Hole
Uninsulated Aluminum Terminals

TYPE YA-A (Continued)



AL9CU



NOTE: Field bending straight lugs to achieve an angular connection will void UL Listing / CSA Certifications and BURNDY will not be liable for the connection.

Catalog Number	AL / Cu Conductor	Stud Size	Stud Hole Diameter (K)	No. of Holes in Pad	Dimensions								Color Code	Die Index	Wire Strip Length	Temperature Rating
					Outside Diameter (OD)	Barrel Length (B)	Pad Width (C)	Overall Length (L)	Hole Spacing (E)	Hole Spacing (F)	Hole Offset (N)	Pad Thickness (T)				
YA39A7	700 - 750 kcmil	3/8	0.44	2	1.46	2.46	2.05	5.81	1.00	—	0.44	0.43	Yellow	936	2-7/8	90° C
YA39A5 †	900 kcmil	1/2	0.56	2	1.46	2.46	1.62	7.07	1.75	—	0.63	0.43				
YA39A13	Compact AL* 600 kcmil CCA DLO (925/22)	1/2	0.56	2	1.46	2.46	2.05	7.04	1.75	—	0.63	0.43				
YA39AM2	600 kcmil CCA DLO (925/22)	1/2	0.56	2	1.60	2.56	1.69	7.31	1.75	—	0.63	0.57	Red	301	2-7/8	90° C
YA42A7	900 kcmil AL	3/8	0.44	2	1.50	2.46	2.14	5.96	1.00	—	0.44	0.39	Gray	303	2-7/8	90° C
YA42A5		1/2	0.56	2	1.50	2.46	1.62	7.09	1.75	—	0.63	0.39				
YA44A3 †	1000 kcmil 750 kcmil CCA DLO (1194/22) 800 kcmil CCA DLO (1258/22)	1/2	0.56	2	1.84	2.74	1.65	7.76	1.75	—	0.63	0.55	Brown	302	3	90° C
YA44A8		1/2	0.56	2	1.84	2.74	2.50	7.76	1.75	—	0.63	0.66				
YA45A5	1250 kcmil 900 kcmil CCA DLO (1406/22) 1000 kcmil CCA DLO (1554/22)	1/2	0.56	2	1.84	2.74	2.59	7.73	1.75	—	0.63	0.51	Brown	302	3	75° C
YA46A3	1500 kcmil	1/2	0.56	2	2.26	3.30	3.08	8.73	1.75	—	0.63	0.81	Blue	478	2-3/4	75° C
YA46A5		1/2	0.56	4	2.26	3.30	3.08	8.73	1.75	1.75	0.63	0.81				
YA48A3	2000 kcmil	1/2	0.56	2	2.60	3.69	3.57	8.49	1.75	—	0.63	0.90	Red	479	4-1/8	75° C

† Narrow tongue design; may be mounted side-by-side on a 4-hole NEMA pad

* Contact BURNDY® for conductor, stud sizes and hole drillings not shown.

◆ For applications greater than 2000 Volts consult cable manufacturer for voltage stress relief instructions.

* Listed using 444S / 644 Series Tools only

Note: All dimensions shown are for reference only.

See Pages C-194 through C-197 for Type YA-A Installation Tooling Information.

TYPE YAAKIT

Transformer Lug Kit



CONNECTOR

Each kit contains the UL Listed and CSA Certified AL9CU rated aluminum compression connectors and tongue mounting hardware needed to terminate aluminum or copper cables in “dry type” transformers. The KVA rating gives an approximate cross reference to the appropriate kit.

See Pages C-194 through C-197 for Type YA-A Installation Tooling Information.

Features & Benefits

- UL Listed AL9CU dual rated compression terminals and CSA Certified; ensure the transformer feeders and taps are terminated properly
- Plated steel cap screws and hex nuts with captive conical washers or individual belleville washers
- Terminal to bus connections are made using proper hardware resulting in true torque to pressure performance, compensates for dissimilar metal expansion and contraction
- Hardware packed in plastic bag; no lost hardware prior to installation
- Conductor Accommodate Types:
 - Aluminum Code Wire: Class B (Concentric, Compressed, Compact)
 - Copper Code Wire: Class B (Concentric, Compressed, Compact or Class C)
 - Copper Clad Aluminum: Noted in the conductor accommodates as CCA



NOTE: Field bending straight lugs to achieve an angular connection will void UL Listing / CSA Certifications and BURNDY will not be liable for the connection.

Accessories

- Hardware - Section F
- PENETROX™ Oxide Inhibitor - Section F
- Heat and Cold Shrink Tubing - Section D
- WIREMIKE™ Wire Micrometer - Section F
- Wire Management (Cable Ties) - Section G

Catalog Number	KVA	Terminals		Wire Range with 644 Series	Bolt		Hardware		Washer	
		Qty.	Cat. No.		Qty.	Size	Qty.	Nut	Qty.	Type
YAAKIT1	15-37.5 1Ø	8	YA2C-A5	#6-2 AWG	8	1/4-20 X 3/4	8	1/2 x 20HN		Captive
	15-45.3 3Ø	4	YA30-A7	2/0 AWG-300 kcmil	8	1/4-20 X 3/4	8	1/2 x 20HN		Captive
YAAKIT2	50-75 1Ø	12	YA30-A7	2/0 AWG-300 kcmil	8	1/4-20 X 3/4	16	1/4 X 20HN		Captive
	75-112.5 3Ø	12	YA30-A7	2/0 AWG-300 kcmil	8	1/4-20 X 2	16	1/4 X 20HN		Captive
YAAKIT3	100-167 1Ø	3	YA30-A7	2/0 AWG-300 kcmil	3	1/4-20 X 3/4	3	1/4 X 20		Captive
	150-300 3Ø	22	YA39-A1	500-750 kcmil	16	1/2-13 X 2	16	1/2-13	16	1/2" Belleville

HH- Hex Head

HN- Hex Nut

See Mechanical section for set screw terminal kits.

Note: All dimensions shown are for reference only.

Compression Connections

Type YA-A Installation Tooling Table Mechanical/Ratchet (Dedicated Die or Requiring Dies)

Catalog Number Type	Wire Size	Wire Strip Length	Color Code and Die Index Number	Mechanical & Ratchet Dies Required (# Crimps)		Mechanical & Ratchet Dedicated Die Tools # Crimps	
	Class B, C Conductor (AL/CU)			MD6 and MD7 Series	OUR840	MY28 and MY29 Series	MRC840AL
YA8CA-	#8 AWG	5/8	Blue 374	X8CART (2) W374 (1)	X8CART (2)	1 Crimp	1 Crimp
YA6CA-	#6 AWG	3/4	Gray 346	X6CART (2)	X6CART (2)	1 Crimp	1 Crimp
			No Color 161	W161 (1)	X161 (2)	—	—
YA4CA-	#4 AWG	1	Green 375	X4CART (3)	X4CART (3)	1 Crimp	2 Crimps
			No Color 162	W162 (3)	—	—	—
YA2CA-	#2 AWG	1-1/4	Pink 348	X2CART (4)	X2CART (4)	2 Crimps	2 Crimps
			No Color 163	W163 (3)	—	—	—
			No Color 239	W239 (2)	X239 (4)	—	—
YA1CA-	#1 AWG	1-1/16	Gold 471	X1CART (3)	X1CART (3)	2 Crimps	2 Crimps
			No Color 163	W163 (3)	—	—	—
YA25A-	1/0 AWG	1-3/16	Tan 296	X25ART (4)	X25ART (4)	2 Crimps	2 Crimps
			No Color 241	W241 (2)	X241 (4)	—	—
YA26A-	2/0 AWG	1-3/8	Olive 297	X26ART (4) WBG (2)	X26ART (4) XBG (4)	2 Crimps	3 Crimps
			No Color 245	W245 (3)	X245 (4)	—	—
YA27A-	3/0 AWG	1-1/2	Ruby 467	X27ART (4)	X27ART (4)	2 Crimps	3 Crimps
			No Color 166	W166 (4)	—	—	—
YA28A-	4/0 AWG	1-5/8	White 298	X28ART (6)	X28ART (6)	2 Crimps	3 Crimps
			No Color 660	W660 (3)	X660 (8)	—	—
YA29A-	250 kcmil	1-5/8	Red 324	—	—	—	—
YA30A-	300 kcmil	1-3/4	Blue 470	—	—	—	—
YA31A-	350 kcmil	2-1/8	Brown 299	W31ART (4)	—	—	—
YA32A-	400 kcmil	2-1/2	Green 472	—	—	—	—
YA34A-	500 kcmil	2-5/8	Pink 300	—	—	—	—
YA36A-	600 kcmil	2-7/8	Black 473	—	—	—	—
YA39A-	700 - 750 kcmil	2-7/8	Yellow 936	—	—	—	—
YA40A-	800 kcmil	3	Gray 474	—	—	—	—
YA42A-	900 AL kcmil	2-7/8	Gray 303	—	—	—	—
YA44A-	1000 kcmil	3-1/8	Gray 474	—	—	—	—
YA45A-	1250 kcmil	3-1/8	Brown 302	—	—	—	—
YA46A-	1500 kcmil	3-3/4	Blue 478	—	—	—	—
YA47A-	1750 kcmil	4-3/8	White 587	—	—	—	—
YA48A-	2000 kcmil	4-1/8	Red 479	—	—	—	—

Catalog Number Type	Wire / Conductor Size	Wire Strip Length	Color Code Die Index	Hydraulic Tools - Dies Required (# Crimps)				
	Class B, C (AL/CU)			MD6, 600, 500 Series	750, 35 Series	45 Series Use PT6515 with U Dies	46 Series Use PUADP1 with U Dies	60 Series
YA8CA-	#8 AWG	5/8	Blue 374	X8CART (2) W374 (1)	U8CABT (1)	U8CABT (1)	U8CABT (1)	—
YA6CA-	#6 AWG	3/4	Gray 346	X6CART (2)	U6CABT (1)	U6CABT (1)	U6CABT (1)	—
			No Color 161	W161 (1) X161 (2)	—	—	—	—
YA4CA-	#4 AWG	1	Green 375	X4CART (3)	U4CABT (1)	U4CABT (1)	U4CABT (1)	—
			No Color 162	W162 (3)	—	—	—	—
YA2CA-	#2 AWG	1-1/4	Pink 348	X2CART (4)	U2CABT (1)	U2CABT (1)	U2CABT (1)	—
			No Color 163	W163 (3)	—	—	—	—
			No Color 239	W239 (2) X239 (4)	—	—	—	—
YA1CA-	#1 AWG	1-1/16	Gold 471	X1CART (3)	U1CART (1)	U1CART (1)	U1CART (1)	—
			No Color 163	W163 (3)	—	—	—	—
YA25A-	1/0 AWG	1-3/16	Tan 296	X25ART (4)	U25ART (1)	U25ART (1)	U25ART (1)	—
			No Color 241	X241 (2)	—	—	—	—
YA26A-	2/0 AWG	1-3/8	Olive 297	X26ART (4) WBG (2)	U26ART (2)	U26ART (2)	U26ART (2)	—
			No Color 245	W245 (3) X245 (4)	—	—	—	—
YA27A-	3/0 AWG	1-1/2	Ruby 467	X27ART (4)	U27ART (2)	U27ART (2)	U27ART (2)	—
			No Color 166	W166 (4)	—	—	—	—
YA28A-	4/0 AWG	1-5/8	White 298	X28ART (6)	U28ART (2)	U28ART (2)	U28ART (2)	L28ART (1)
			No Color 660	W660 (3) X660 (8)	—	—	—	—
YA29A-	250 kcmil	1-5/8	Red 324	—	U29ART (2)	U29ART (2)	U29ART (2)	L29ART (1)
YA30A-	300 kcmil	1-3/4	Blue 470	—	U30ART (2)	U30ART (2)	U30ART (2)	L30ART (1)
YA31A-	350 kcmil	2-1/8	Brown 299	W31ART (4)	U31ART (2)	U31ART (2)	U31ART (2)	L31ART (1)
YA32A-	400 kcmil	2-1/2	Green 472	—	U32ART (4)	U32ART (4)	U32ART (4)	L32ART (2)
YA34A-	500 kcmil	2-5/8	Pink 300	—	U34ART (4)	U34ART (4)	U34ART (4)	L34ART (2)
YA36A-	600 kcmil	2-7/8	Black 473	—	U36ART (4)	U36ART (4)	U36ART (4)	L36ART (2)
YA39A-	700 - 750 kcmil	2-7/8	Yellow 936	—	U39ART2 (4)	U39ART2 (4)	U39ART2 (4)	L39ART2 (2)
YA40A-	800 kcmil	3	Gray 474	—	—	S40ART (4)	P40ART (4)	L40ART (2)
YA42A-	900 AL kcmil	2-7/8	Gray 303	—	—	U42ART (4)	U42ART (4)	—
YA44A-	1000 kcmil	3-1/8	Gray 474	—	—	S44ART (4)	P44ART (4)	L44ART (2)
YA45A-	1250 kcmil	3-1/8	Brown 302	—	—	S44ART (4)	P44ART (4)	L44ART (2)
YA46A-	1500 kcmil	3-3/4	Blue 478	—	—	—	—	L46ART (2)
YA47A-	1750 kcmil	4-3/8	White 587	—	—	—	—	L47ART (2)
YA48A-	2000 kcmil	4-1/8	Red 479	—	—	—	—	L48ART (2)

Compression Connections

Type YA-A Installation Tooling Table Hydraulic (Dieless)

Catalog Number Type	Wire / Conductor Size		Wire Strip Length	Color Code Die Index	Hydraulic Tools - Dieless # Crimps			
	Class B, C (AL/CU)	Copper Clad Aluminum (CCA) <i>Only for use with 644 / 444S Series</i>			81K, 4PC Series	644 Series	444S Series	Y644MBH Remote Head
YA8CA-	#8 AWG	—	5/8	Blue 374	1 Crimp	—	—	—
YA6CA-	#6 AWG	—	3/4	Gray 346	1 Crimp	1 Crimp	—	1 Crimp
				No Color 161	—	—	—	—
YA4CA-	#4 AWG	—	1	Green 375	1 Crimp	1 Crimp	1 Crimp	1 Crimp
				No Color 162	—	—	—	—
YA2CA-	#2 AWG	—	1-1/4	Pink 348	2 Crimps	1 Crimp	1 Crimp	1 Crimp
				No Color 163	—	—	—	—
				No Color 239	—	—	—	—
YA1CA-	#1 AWG	—	1-1/16	Gold 471	2 Crimps	1 Crimp	1 Crimp	1 Crimp
				No Color 163	—	—	—	—
YA25A-	1/0 AWG	—	1-3/16	Tan 296	2 Crimps	1 Crimp	1 Crimp	1 Crimp
				No Color 241	—	—	—	—
YA26A-	2/0 AWG	—	1-3/8	Olive 297	2 Crimps	1 Crimp	1 Crimp	1 Crimp
				No Color 245	—	—	—	—
YA27A-	3/0 AWG	—	1-1/2	Ruby 467	2 Crimps	1 Crimp	1 Crimp	1 Crimp
				No Color 166	—	—	—	—
YA28A-	4/0 AWG	—	1-5/8	White 298	2 Crimps	1 Crimp	1 Crimp	1 Crimp
				No Color 660	—	—	—	—
YA29A-	250 kcmil	—	1-5/8	Red 324	2 Crimps	1 Crimp	1 Crimp	1 Crimp
YA30A-	300 kcmil	4/0 AWG CCA DLO (329/22)	1-3/4	Blue 470	2 Crimps	1 Crimp	1 Crimp	1 Crimp
YA31A-	350 kcmil	250 kcmil CCA DLO (399/22)	2-1/8	Brown 299	3 Crimps	1 Crimp	1 Crimp	1 Crimp
YA32A-	400 kcmil	—	2-1/2	Green 472	4 Crimps	1 Crimp	1 Crimp	1 Crimp
YA34A-	500 kcmil	350 kcmil CCA DLO (779/22)	2-5/8	Pink 300	4 Crimps	1 Crimp	1 Crimp	1 Crimp
YA36A-	600 kcmil	500 kcmil CCA DLO (779/22)	2-7/8	Black 473	4 Crimps	1 Crimp	1 Crimp	1 Crimp
YA39A-	700 - 750 kcmil	600 kcmil CCA DLO (925/22)	2-7/8	Yellow 936	4 Crimps	1 Crimp	1 Crimp	1 Crimp
YA40A-	800 kcmil	—	3	Gray 474	—	1 Crimp	1 Crimp	1 Crimp
YA42A-	900 AL kcmil	—	2-7/8	Gray 303	—	2 Crimps	2 Crimps	2 Crimps
YA44A-	1000 kcmil	750 kcmil CCA DLO (1184/22) 800 kcmil CCA DLO (1258/22)	3-1/8	Gray 474	—	—	1 Crimp	1 Crimp
YA45A-	1250 kcmil	900 kcmil CCA DLO (1406/22) 1000 kcmil CCA DLO (1554/22)	3-1/8	Brown 302	—	—	—	—
YA46A-	1500 kcmil	—	3-3/4	Blue 478	—	—	—	—
YA47A-	1750 kcmil	—	4-3/8	White 587	—	—	—	—
YA48A-	2000 kcmil	—	4-1/8	Red 479	—	—	—	—

Installation Instructions

Installation instructions help the installer understand proper wire preparation, proper insertion requirements, crimp zone location, individual crimp location, crimp order and crimp direction, to ensure safe and reliable wire connections. In order to obtain a UL Listing BURNDY certifies its products using the BURNDY Engineered System and select other crimp tool manufacturers in accordance with one or more UL categories.

Aluminum Installation Steps:

- Select the appropriate connector based on:
 - Wire Material
 - Wire Construction
 - Wire Size
- Strip the insulation to the appropriate wire strip length, based on the table's Wire Strip Length recommendation for the selected connector. Due to tolerances in the connector, wire strip length, and insulation stripping tools, this range may be 0" - 1/4". The exposed wire, also known as a "shiner", has no performance impact on the connection and there is no wire exposure requirement by BURNDY.
- Wire brush the bare conductor to remove any oxides. DO NOT wire brush tin-plated connectors.
- Apply PENETROX™ A13 oxide inhibitor to the bare conductor.
- Insert the conductor into the barrel for the full length. The connector barrel is filled with PENETROX™ A13, so be aware of the following:
 - Oxide inhibitor may discharge from the barrel when wire is fully inserted.
 - Oxide inhibitor may cause resistance that could feel like the wire is fully inserted. Ensure you insert the wire with enough force to penetrate the oxide inhibitor barrier until you reach the full wire insertion distance.
- Apply the proper number of crimps based on the installation tooling requirements. Use the illustrations as a guide on crimp placement and direction for the proper number of crimps.
- Remove excess PENETROX™ A13 that may discharge during installation.

*For simplicity, the images show a 1-hole connector, however, connectors are available in 1-hole, 2-hole or more hole patterns.

CATALOG NUMBER DESIGNATIONS

YA8CA-	YA6CA-	YA4CA-	YA2CA-	YA1CA-	YA25A-
--------	--------	--------	--------	--------	--------

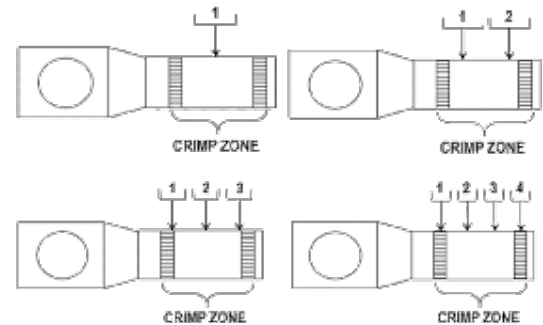

CATALOG NUMBER DESIGNATIONS

YA26A-	YA27A-	YA28A-	YA29A-	YA30A-	YA31A-
YA39AM-	YA40A-	YA44A-	YA45A-	YA46A-	YA48A-

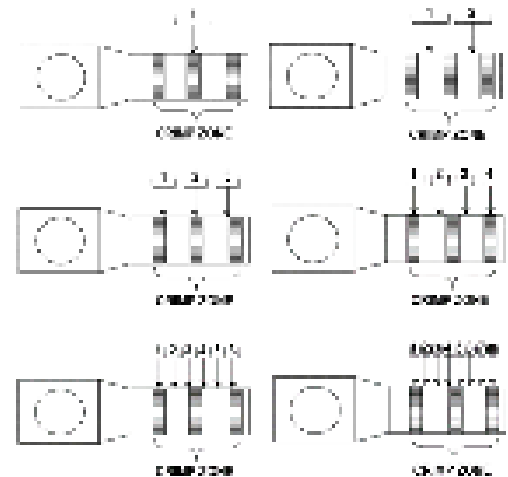

CATALOG NUMBER DESIGNATIONS

YA32A-	YA34A-	YA36A-	YA39A-	YA42A-
--------	--------	--------	--------	--------

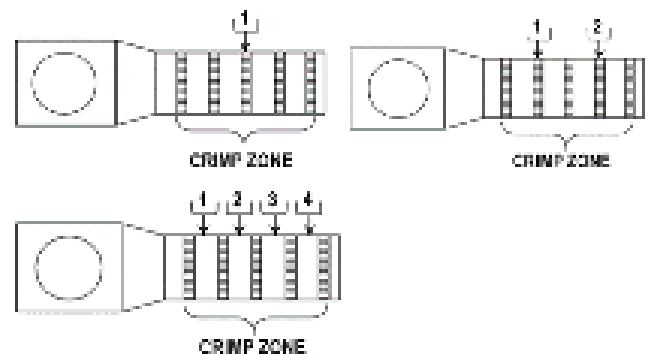

TYPES AYP, AYPO

HYPLUG™ Adapters

UL Listed 90° C, Up to 35 kV ♦



AL9CU



AL9

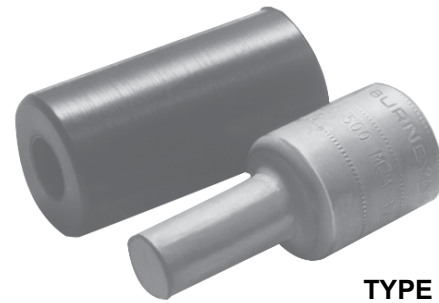

TYPE AYP

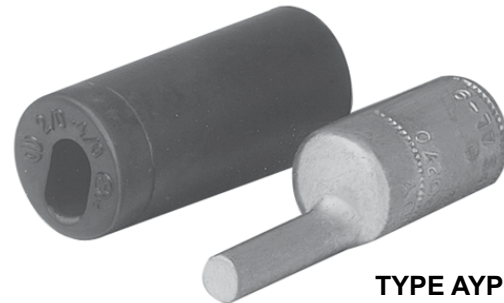

TYPE AYPO

Features & Benefits

- Aluminum pin terminals are dual rated to accommodate both copper and aluminum wire and are indicated with AL-CU on the connector:
 - AL9CU indicates the terminal can accommodate aluminum and copper wire and is UL Listed 90°C, up to 35kV
 - AL7CU indicates the terminal can accommodate aluminum and copper wire and is UL Listed 75°C, up to 35kV
- Short pin length design permits easy installation in limited space applications; rated for the full ampacity of the incoming conductor
- Smooth surface on the pin allows for greater contact area and electrical connectivity
- Solid pin design eliminates “how tight is tight” torque requirement problem and eliminates over torquing on stranded pin adapters that can result in damaged strands increasing resistance
- Barrel is designed with an internal chamfer at the wire entry to ensure smooth insertion of the wire, preventing possible damaging of the wire strands during insertion
- Electro-tin plated unless otherwise specified to reduce galvanic corrosion (bimetallic) and resist corrosive elements
- Connectors are clearly marked with wire size, die index, color code, and crimp location bands
- Factory pre-filled with PENETROX™ Type A13 oxide inhibitor
- Color coded end caps are factory inserted in the barrels to match the die color code and prevent foreign materials from entering the barrel
- Aluminum oxidation is not easily detected but causes resistance in a connection; it is imperative the proper preparation takes place prior to making an aluminum-to-aluminum connection
- Covers are supplied with connectors:
 - EPDM rubber covers are UL Listed/CSA Certified and rated up to 600 Volts and 90°C
 - Santoprene rubber covers are also UL Listed/CSA Certified and rated up to 600 Volts and 90°C

- The connector is offered with an in-line pin (Type AYP) and offset pin (Type AYPO) design
- Offset pin design provides added flexibility in limited space applications as the connectors can be rotated preventing wire interference when installing cable side-by-side to a mechanical connector
- Only 5 dies sets are necessary to install the complete line of HYPLUG™ adapters from #6 AWG up to 750 kcmil
- BURNDY certifies its products using the BURNDY Engineered System and select other crimp tool manufacturers in accordance with one or more of the UL categories in order to obtain a UL Listing
- Conductor Accommodate Types:
 - Aluminum Code Wire: Class B (Concentric, Compressed, Compact)
 - Copper Code Wire: Class B (Concentric, Compressed, Compact or Class C)
 - Copper Clad Aluminum: Noted in the conductor accommodates as CCA

Accessories

- Hardware - Section F
- PENETROX™ Oxide Inhibitor - Section F
- Heat and Cold Shrink Tubing - Section D
- WIREMIKE™ Wire Micrometer - Section F
- Wire Management (Cable Ties) - Section G

♦ For applications greater than 2000 Volts consult cable manufacturer for voltage stress relief instructions.

TYPES AYP, AYPO (Continued)

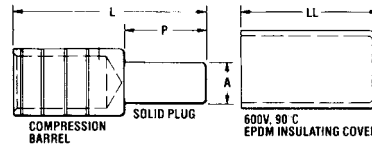

Fig 1: TYPE AYP (Straight)

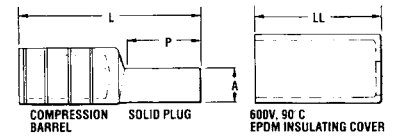
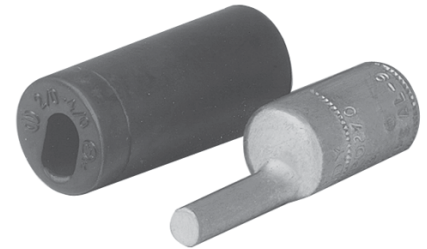

Fig 2: TYPE AYPO (Offset)

Catalog Number	AL Class B CU Class B, C	Copper Flex	Fig. No.	Dimensions					Installation Tooling ▲					Wire Strip Length
				A ▼ Pin Dia.	Pin Size Equiv.	P Pin Length	L Overall Length	LL Cover Length	HYTOOL™		35 & 750, 46* Series		Die Index & Emboss.	
									Dieless Tools (# of crimps)	+ MD6	Die Number (# of crimps)	Color Code		
AYP6	6 AWG ●	#8 Class I, DLO	1	0.23	4 AWG	0.68	1.85	2.03	MY293 (2)** 444 Series (1) 644 Series (1) 81K Series (1)	W241 (2)	U25ART (1)	Tan	296	1-1/16
AYP4	4 AWG	#6 Class I, DLO	1	0.23	4 AWG	0.68	1.85	2.03						
AYP2	2 AWG	#4 Class I, DLO	1	0.23	4 AWG	0.68	1.85	2.03						
AYP1	1 AWG	#2 Class I, DLO	1	0.26	3 AWG	0.84	2.01	2.03						
AYP1/0	1/0 AWG	#1 Class I, DLO	1	0.29	2 AWG	0.84	2.01	2.03						
AYPO2/0	2/0 AWG	1/0 Class I, DLO	2	0.33	1 AWG	1.09	2.70	2.23	MY293 (2)** 444 Series (1) 644 Series (1) 81K Series (2)	W660 (4)	U28ART (2)	White	298	1-1/8
AYPO3/0	3/0 AWG	2/0 Class I, DLO	2	0.37	1/0 AWG	1.22	2.80	2.23						
AYPO4/0	4/0 AWG	3/0 Class I, DLO	2	0.42	2/0 AWG	1.22	2.80	2.23						
AYP250	250 kcmil	4/0 Class I, K, M, DLO	1	0.47	3/0 AWG	1.16	2.63	2.54	444 Series (1) 644 Series (1) 81K Series (2)	—	U31ART (2)	Brown	299	1-1/8
AYPO250	250 kcmil		2	0.47	3/0 AWG	1.22	2.98	2.54						
AYPO300	300 kcmil	250 kcmil Class I, 262 DLO	2	0.53	4/0 AWG	1.34	3.08	2.54						
AYP350	350 kcmil	313 kcmil DLO	1	0.57	250 kcmil	1.34	2.75	2.54						
AYPO350	350 kcmil		2	0.57	250 kcmil	1.34	3.08	2.54						
AYPO400	400 kcmil	—	2	0.63	300 kcmil	1.60	3.43	2.81						
AYP500	500 kcmil	373 kcmil Class I, 373 DLO	1	0.68	350 kcmil	1.60	3.08	2.81						
AYPO500	500 kcmil		2	0.68	350 kcmil	1.60	3.43	2.81						
AYPO600	600 kcmil	444 kcmil DLO	2	0.73	400 kcmil	1.64	4.02	3.69						
AYP750	700 - 750 kcmil ‡900 kcmil Compact AL	535 kcmil DLO	1	0.81	500 kcmil	1.76	3.79	3.69						
AYPO750			2	0.81	500 kcmil	1.76	4.16	3.69						
AYP900	900 kcmil AL	—	1	0.91	650 kcmil	1.82	4.10	4.20						
AYPO900		—	2	0.91	650 kcmil	1.82	4.16	4.20						
AYPO1000	1000 kcmil	777 kcmil DLO	2	0.81	500 kcmil	1.76	4.17	—	444 Series (1) Y644MBH only (1)	—	—	—	—	1-3/4

Scratch brushing of all conductors before making installation is recommended

▲ See tooling section of this catalog for complete tool and die listings.

** For MY293 use aluminum index plate at 1/0 setting for sizes #6 through 1/0 or at 4/0 setting for sizes 2/0 through 4/0.

+ Not UL Listed with these tools.

* Use PUADP1 adaptor with U dies in 46 Series Tools

■ Also accommodates compressed and compact conductors (except for 700 kcmil in 750 kcmil barrel).

‡ Listed using 444S / 644 Series Tools only.

◆ For applications greater than 2000 Volts consult cable manufacturer for voltage stress relief instructions.

▼ For copper equivalent wire size see Section O for Aluminum 1350 Cable Reference

Notes: CSA Certified for AL Conductor only.

All dimensions shown are for reference only.

● Aluminum wire only for 444S and 644 Series tooling

TYPE YS-A



HYLINK™ Aluminum Splices

UL Listed 90° C, Up to 35 kV ◆

Type YS-A is a high conductivity aluminum tin-plated compression butt splice for use on all combinations of aluminum to aluminum, aluminum to copper, and copper to copper conductor combinations.

They are designed to accommodate conductors from #12 stranded through 1000 kcmil in standard and heavy duty applications. Prefilled with PENETROX™ oxide inhibiting compounds and assembled with color-coded end caps, these connectors provide a permanent trouble-free electrical splice with flexibility and low installed cost.



Features & Benefits

- Aluminum splices are dual rated to accommodate both copper and aluminum wire and are indicated with AL-CU on the connector:
 - AL9CU indicates the terminal can accommodate aluminum and copper wire and is UL Listed 90°C, up to 35kV
 - AL7CU indicates the terminal can accommodate aluminum and copper wire and is UL Listed 75°C, up to 35kV
- Barrel is designed with an internal chamfer at the wire entry to ensure smooth insertion of the wire, preventing possible damaging of the wire strands during insertion
- Electro-tin plated unless otherwise specified to reduce galvanic corrosion (bimetallic) and resist corrosive elements
- Connectors are clearly marked with wire size, die index, color code, and crimp location bands
- Factory pre-filled with PENETROX™ Type A13 oxide inhibitor
- Color coded end caps are factory inserted in the barrels to match the die color code and prevent foreign materials from entering the barrel
- Aluminum oxidation is not easily detected but causes resistance in a connection; it is imperative the proper preparation takes place prior to making an aluminum-to-aluminum connection
- BURNDY certifies its products using the BURNDY Engineered System and select other crimp tool manufacturers in accordance with one or more of the UL categories in order to obtain a UL Listing
- Conductor Accommodate Types:
 - Aluminum Code Wire: Class B (Concentric, Compressed, Compact)
 - Copper Code Wire: Class B (Concentric, Compressed, Compact or Class C)
 - Copper Clad Aluminum: Noted in the conductor accommodates as CCA

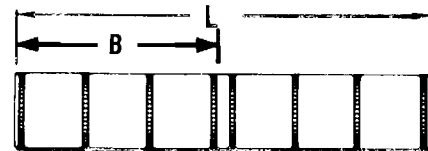

Accessories

- Hardware - Section F
- PENETROX™ Oxide Inhibitor - Section F
- Heat and Cold Shrink Tubing - Section D
- WIREMIKE™ Wire Micrometer - Section F
- Wire Management (Cable Ties) - Section G

TYPE YS-A (Continued)



Catalog Number	Code • Conductor	Dimensions		Installation Tooling ▲					Wire Strip Length
				Dieless (# of crimps/end)		35 ■, 750, 46* Series		Die Index & Embossment	
		B	L	Mechanical	Hydraulic	Die Number (# of crimps per end)	Color Code		
YS12AG1	#12 Str.	0.45	1.03	Ratchet: MR827 (1)	—	—	— ①	—	5/8
YS10WAG1	#10 Sol.	0.50	1.12						
YS8CA1	8 Str.	0.59	1.44	MY293 (1) MRC840AL (1)	644 Series (1) 81K Series (1)	U8CABT (1)	Blue	374	5/8
YS6CA1	6 Str.	0.72	1.70			U6CABT (1)	Gray	346	3/4
YS4CA1	4 Str.	0.86	1.97	MY293 (1) MRC840AL (2)	644 Series (1) 81K Series (2)	U4CABT (1)	Green	375	7/8
YS2CA1	2 Str.	1.09	2.44			U2CABT (1)	Pink	348	1-1/8
YS1CA1	1 Str.	0.90	2.05	MY293 (2) MRC840AL (3)	644 Series (1) 81K Series (2)	U1CART (1)	Gold	471	15/16
YS25A1	1/0 Str.	1.06	2.37			U25ART (1)	Tan	296	1-1/16
YS26A1	2/0 str.	1.18	2.61	MY293 (2) MRC840AL (3)	644 Series (1) 81K Series (2)	U26ART (2)	Olive	297	1-3/8
YS27A1	3/0 str.	1.31	2.88			U27ART (2)	Ruby	467	1-1/2
YS28A1	4/0 str.	1.40	3.06	MY293 (2) MRC840AL (3)	644 Series (1) 81K Series (2)	U28ART (2)	White	298	1-5/8
YS29A1	250kcmil	1.46	3.18			U29ART (2)	Red	324	1-5/8
YS30A1	300 kcmil	1.47	3.20	—	644 Series (1) 81K Series (2)	U30ART (2)	Blue	470	1-3/4
YS31A1	350 kcmil	1.89	4.04			U31ART (2)	Brown	299	2-1/8
YS32A1	400kcmil	2.30	4.86	—	644 Series (1) 81K Series (4)	U32ART (2)	Green	472	2-1/2
YS34A1	500 kcmil	2.38	5.02			U34ART (2)	Pink	300	2-5/8
YS36A1	600 kcmil	2.44	5.14	—	644 Series (1) 81K Series (4)	U36ART (4)	Black	473	2-7/8
YS39A1	700 kcmil 750 kcmil +900 Compact Al	2.50	5.26			U39ART2 (4)	Yellow	936	2-7/8
YS39AM1	700 kcmil 750 kcmil +900 Compact Al	2.63	5.58	—	644 Series (2)	P39ART** (4)	Red	301	2-7/8
YS42A1	600 - 900 kcmil	2.50	5.26			U42ART (4)	Gray	303	2-7/8
YS44A1	1000 kcmil	2.84	5.94	—	—	P44ART** (4)	Brown	302	3
YS45A1^^	1250 kcmil	2.84	6.21			P48PR1/ L44ART** (6)	Brown	302	2-7/8
YS46A1^^	1500 kcmil	3.40	7.05	—	—	L46ART*** (2)	Blue	478	3-7/8
YS47A1^^	1750 kcmil	3.99	8.31			L47ART*** (2)	White	587	4
YS48A1^^	2000 kcmil	3.66	7.58	—	—	L48ART*** (2)	Red	479	3-5/8
YS483A1^^	2250 kcmil ALUMINUM ONLY	3.66	7.58			L48ART*** (2)	Red	479	3-5/8

▲ See tooling section of this catalog for complete tool and die listing.

① No color code assigned.

‡ UL Listed for Aluminum only. Not CSA Certified.

+ Tested with Y644HSXT and PAT644XT-18V dieless tools only and not UL Listed with any tool on 900 Compact Al.

* Use PUADP1 adaptor with U dies in 46 Series.

■ The largest size for the 35 Series is 400 kcmil.

◆ For applications greater than 2000 Volts consult cable manufacturer for voltage stress relief instructions.

● Also accommodates compressed and compact conductors (except for 700 kcmil in 750 kcmil barrel).

^^ 75°C Rated

**P-RT dies for use in 46 Series tools only.

***L dies for use with 60 Ton HYPRESS™ only

Note: All dimensions shown are for reference only.

Compression Connections

Aluminum / Copper Compression
HYREDUCER™ Aluminum Reducing Splices

TYPE YRB

HYREDUCER™ Aluminum Reducing Splice



UL Listed 90° C, Up to 35 kV ♦

HYREDUCER™ Type YRB reducer butt splices are designed to splice two different conductor sizes and is UL Listed for aluminum to copper and aluminum to aluminum applications. The outside diameter is held constant to minimize installation dies and is factory pre-filled with PENETROX™ oxide inhibitor.

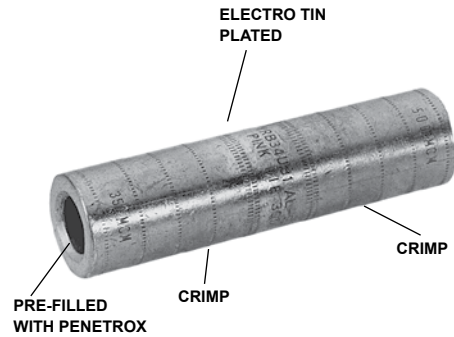

Features & Benefits

- Aluminum splice reducers are dual rated to accommodate both copper and aluminum wire and are indicated with AL-CU on the connector:
 - AL9CU indicates the terminal can accommodate aluminum and copper wire and is UL Listed 90°C, up to 35kV
 - AL7CU indicates the terminal can accommodate aluminum and copper wire and is UL Listed 75°C, up to 35kV
- Barrel features an internal chamfer at the wire entry to ensure smooth insertion of the wire, preventing possible damaging of the wire strands during insertion
- Electro-tin plated unless otherwise specified to reduce galvanic corrosion (bimetallic) and resist corrosive elements
- Connectors are clearly marked with crimp location bands
- Factory pre-filled with PENETROX™ Type A13 oxide inhibitor
- Color coded end caps are factory inserted in the barrels to match the die color code and prevent foreign materials from entering the barrel
- The barrels are designed to accommodate larger run conductor and smaller tap conductor so the inside diameters on each end of the barrel are different but the outside diameter is held constant minimizing number of installation dies necessary

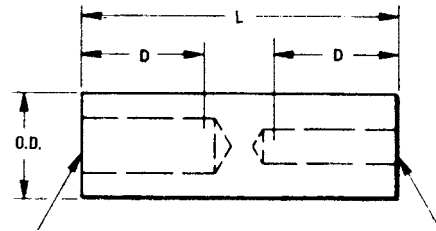

- Aluminum oxidation is not easily detected but causes resistance in a connection; it is imperative the proper preparation takes place prior to making an aluminum-to-aluminum connection
- BURNDY certifies its products using the BURNDY Engineered System and select other crimp tool manufacturers in accordance with one or more of the UL categories in order to obtain a UL Listing

Catalog Number	Conductor Range • Aluminum or Copper Size †		Dimensions			Installation Tooling ▲ Hydraulic Tools, Die Sets (No. of Crimps ‡)				Wire Strip Length
	Barrel A	Barrel B	O.D.	D	L	35 ■, 750, 46* Series	‡	Die Index	Color Code	
YRB2U4	1 str. 2 str.	4 str. 3 str.	0.65	0.88	2.00	U25ART	1	296	Tan	15/16
YRB25U2	1/0 str.	1 str. 2 str.	0.65	0.88	2.00	U25ART	1	296	Tan	15/16
YRB27U25	3/0 str.	1/0 str.	0.85	1.36	3.31	U28ART	2	298	White	1-7/16
YRB27U26	3/0 str.	2/0 str.	0.85	1.36	3.31	U28ART	2	298	White	1-7/16
YRB28U26	4/0 str.	2/0 str.	0.85	1.36	3.31	U28ART	2	298	White	1-7/16
YRB29U28	250 kcmil	4/0 str.	1.11	1.73	4.21	U31ART	2	299	Brown	1-13/16
YRB31U28	350 kcmil	4/0 str.	1.11	1.73	4.21	U31ART	2	299	Brown	1-13/16
YRB31U29	350 kcmil	250 kcmil	1.11	1.73	4.21	U31ART	2	299	Brown	1-13/16
YRB34U31	500 kcmil	350 kcmil	1.31	2.11	5.12	U34ART	4	300	Pink	2-3/16
YRB36U31	600 kcmil	350 kcmil	1.46	2.25	5.57	U39ART2	4	936	Yellow	2-5/16
YRB36U34	600 kcmil	500 kcmil	1.46	2.25	5.57	U39ART2	4	936	Yellow	2-5/16
YRB39U34	700/750 kcmil • 900 Compact AL ▼	500 kcmil	1.46	2.25	5.57	U39ART2	4	936	Yellow	2-5/16
YRB39U36	700/750 kcmil • 900 Compact AL ▼	600 kcmil	1.46	2.25	5.57	U39ART2	4	936	Yellow	2-5/16

† Contact BURNDY for conductor sizes not shown

▲ See tooling section of this catalog for complete tool and die listing

‡ Number of crimps

* Use PUADP1 adaptor with U dies in 46 Series

■ The largest size for the 35 Series is 400 kcmil

♦ For applications greater than 2000 Volts consult cable manufacturer for voltage stress relief instructions

• Also accommodates compressed and compact conductors (except for 700 kcmil in 750 kcmil barrel)

▼ Tested with Y644HSXT and PAT644XT-18V dieless tools only and not UL Listed with any tool on 900 Compact Al.

Note: All dimensions shown are for reference only.

TYPES YFD, YFN, YFO, YFR

H-CRIMPIT™ Aluminum Compression Tap Connector



UL Listed 90° C, Up to 35 kV ♦

H-CRIMPIT™ compression tap connectors Types YFD, YFN, YFO, and YFR are for use with aluminum to aluminum and aluminum to copper connections.

The H-CRIMPIT™ taps are ideal for making both parallel and tap compression connections in risers and gutters. It should only be installed with hydraulic tools.

Features & Benefits

- Aluminum H Taps are dual rated to accommodate both copper and aluminum wire and are indicated with AL-CU on the connector:
 - AL9CU indicates the terminal can accommodate aluminum and copper wire and is UL Listed 90°C, up to 35kV
 - AL7CU indicates the terminal can accommodate aluminum and copper wire and is UL Listed 75°C, up to 35kV
- Each connector is factory sealed in polyethylene to ensure connector is delivered free of foreign materials prior to being installed
- Post crimp, the connector is easy to tape
- Connectors are clearly marked
- Factory pre-filled with PENETROX™ Type A13 oxide inhibitor
- Aluminum oxidation is not easily detected but causes resistance in a connection so it is imperative that the proper preparation takes place prior to making an aluminum-to-aluminum connection
- BURNDY certifies its products using the BURNDY Engineered System and select other crimp tool manufacturers in accordance with one or more of the UL categories in order to obtain a UL Listing

DIE AND COLOR CODE
AND CRIMP INFORMATION

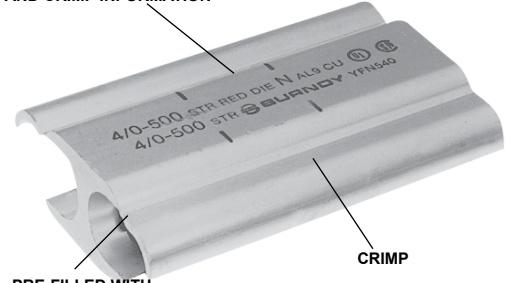

PRE-FILLED WITH
PENETROX

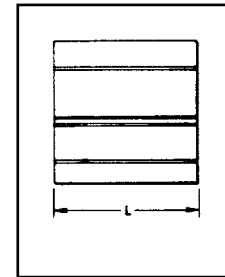
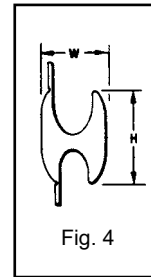
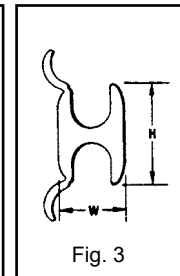
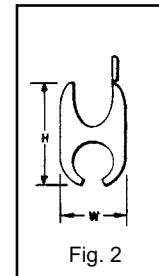
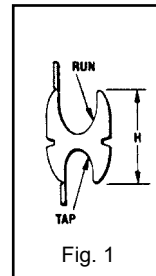

Accommodates ②						Catalog Number	Fig. #	H	L	W	Installation Tooling ▲					Wire Strip Length
Copper or Aluminum		Compact ④		Dia. Range							Die Index	Color Code	Hydraulic Tools, Die Sets (No. of Crimps)			
Run	Tap	Run	Tap	Run	Tap								750, 35 Series	46 ⑤ Series	()	
1/0-6 Str	1-6 Str	2/0-6	1-6 Str	.398-.162	.332-.162	YFO140	1	1.15	1.62	0.70	O	Green	UYFO, UO	UYFO, UO	(2)	1-7/8
4/0-1 Str	2/0-1 Str	250-1/0	3/0-1/0	.563-.338	.477-.338	YFD365	1	1.42	2.50	0.89	D3	Blue	UD3 UYFD	UD3 UYFD	(3)	2-3/4
500-4/0	500-4/0	500-250	500-250	.815-.522	.815-.522	YFN540	3	1.82	4.50	1.23	N	Red	UN UYFN	PN PYFN	(3)	4-7/8
900-600	600-350	900-700	600-400	1.108-.877	.893-.659	YFR865	4	3.04	4.62	1.74	KR	Yellow	—	PKR PYFR	(4)	5

▲ See tooling section of this catalog for complete tool and die listings.

♦ For applications greater than 2000 Volts consult cable manufacturer for voltage stress relief instructions.

* CSA Listed

Note: All dimensions shown are for reference only.

① Material: Aluminum.

② For Conductor combinations of AL to AL or AL to CU.

③ Catalog Number PUADP1 adaptor is required to use U type dies in 46 series tools; **do not use UYFN die set with PUADP1; use PYFN only.**

④ Other conductors not listed in table can be accommodated as long as the conductor diameter falls within diameter range specified.

TYPE YAEBAS

Straight Style Battery Post Terminals

#6 - 4/0 AWG Solid and Stranded Copper

BURNDY straight style battery post terminals are made from pure copper alloy and tin plated to prevent corrosion. They adhere to SAE, JIS, and DIN stud standards. Typical applications are automotive, marine, transportation, petrochemical, and OEM markets.



Features & Benefits

Barrel:

- Color coded for easy identification
- Chamfered end
- Made of copper alloy, tin plated for corrosion resistance and RoHS compliance
- Supplied standard with stainless steel hardware installed

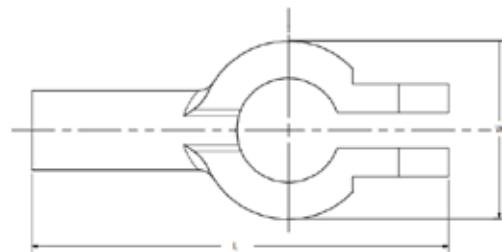

Post:

- Clamp color coded by polarity; red is positive, black is negative
- Not UL Listed but tested and met UL486A-486B pullout requirements

Catalog Number	Wire Range	Dimensions		Bulk Catalog Number	Conn. Color Code	Installation Tooling			Color Code Die	Die Index	Strip Length
		L	W			MD6, MD734R, 500, 600 Series	35, 750 Series	Dieless (# Crimps)			
YAEBAS6CNTN	#6	2.30"	0.98"	YAEBAS6CNTNOEM	Blue	W5CVT (1)	U5CRT (1)	81K Series (1) 4PC Series (1) 644 Series (1) MY2911 (1) MRC840 (1)	Blue	7	1-3/32"
YAEBAS6CPTN			1.02"	YAEBAS6CPTNOEM		W5CRT (1)					
YAEBAS4CNTN	#4		0.98"	YAEBAS4CNTNOEM	Gray	W4CVT (1)	U4CRT (1)		Gray	6	
YAEBAS4CPTN			1.02"	YAEBAS4CPTNOEM		W4CRT (1)					
YAEBAS2CNTN	#2		0.98"	YAEBAS2CNTNOEM	Green	W2CVT (1)	U2CRT (1)		Brown	10	
YAEBAS2CPTN			1.02"	YAEBAS2CPTNOEM		W2CRT (1)					
YAEBAS1CNTN	#1		0.98"	YAEBAS1CNTNOEM	Pink	W1CVT (1)	U1CRT (1)		Green	11	
YAEBAS1CPTN			1.02"	YAEBAS1CPTNOEM		W1CRT1 (1)					
YAEBAS25NTN	1/0	0.98"	YAEBAS25NTNOEM	Black	W25VT (1)	U25RT (1)	Pink	12			
YAEBAS25PTN		1.02"	YAEBAS25PTNOEM		W25RT (1)						
YAEBAS26NTN	2/0	0.98"	YAEBAS26NTNOEM	Orange	W26VT (1)	U26RT (1)	Black	13			
YAEBAS26PTN		1.02"	YAEBAS26PTNOEM		W26RT (1)						
YAEBAS27NTN	3/0	0.98"	YAEBAS27NTNOEM	Purple	W27VT (1)	U27RT (1)	Orange	14			
YAEBAS27PTN		1.02"	YAEBAS27PTNOEM		W27RT (1)						
YAEBAS28NTN	4/0	0.98"	YAEBAS28NTNOEM	Yellow	W28VT (1)	U28RT (1)	Purple	15			
YAEBAS28PTN		1.02"	YAEBAS28PTNOEM		W28RT (1)						

TYPE YAEB-A-F

T-Style Battery Post Terminals

#2 - 4/0 AWG Solid and Stranded Copper

BURNDY T-Style battery post terminals are made from pure copper alloy and tin plated to prevent corrosion. They adhere to SAE, JIS, and DIN stud standards. Typical applications are automotive, marine, transportation, petrochemical, and OEM markets.



Features & Benefits

Barrel:

- Color coded for easy identification
- Chamfered end
- Made of copper alloy, tin plated for corrosion resistance and RoHS compliance
- Supplied standard with stainless steel hardware installed

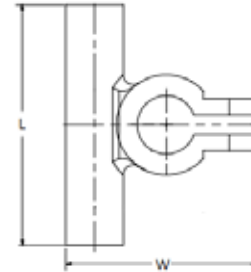

Post:

- Clamp color coded by polarity; red is positive, black is negative
- Not UL Listed but tested and met UL486A-486B pullout requirements

Catalog Number	Wire Range	Dimensions		Bulk Catalog Number	Conn. Color Code	Installation Tooling			Die Color Code	Die Index	Strip Length
		L	W			MD6, MD734R, 500, 600 Series	35, 750 Series	Dieless (# Crimps)			
YAEBAF2CNTN	#2	2.36	1.89	YAEBAF2CNTNOEM	Green	W2CVT (1)	U2CRT (1)	MY2911 (1) MRC840 (1)	Brown	10	1-9/32
YAEBAF2CPTN				YAEBAF2CPTNOEM		W2CRT (1)					
YAEBAF1CNTN	#1			YAEBAF1CNTNOEM	Pink	W1CVT (1)	U1CRT1 (1)		Green	11	
YAEBAF1CPTN				YAEBAF1CPTNOEM		W1CRT1 (1)					
YAEBAF25NTN	1/0		1.97	YAEBAF25NTNOEM	Black	W25VT (1)	U25RT (1)	MY2911 (1) MRC840 (2)	Pink	12	
YAEBAF25PTN				YAEBAF25PTNOEM		W25RT (1)					
YAEBAF26NTN	2/0		YAEBAF26NTNOEM	Orange	W26VT (1)	U26RT (1)	Black	13			
YAEBAF26PTN			YAEBAF26PTNOEM		W26RT (1)						
YAEBAF27NTN	3/0	YAEBAF27NTNOEM	Purple	W27VT (1)	U27RT (1)	Orange	14				
YAEBAF27PTN		YAEBAF27PTNOEM		W27RT (1)							
YAEBAF28NTN	4/0	YAEBAF28NTNOEM	Yellow	W28VT (1)	U28RT (1)	Purple	15				
YAEBAF28PTN		YAEBAF28PTNOEM		W28RT (1)							

Compression Connections

Battery Terminals
One Hole Grounding / Starter Lugs

TYPE YAGB

One Hole Battery Grounding / Starter Lugs

#6 - 4/0 AWG Solid and Stranded Copper



Features & Benefits

- Color coded for easy identification
- Chamfered end
- Made of copper alloy, tin plated for corrosion resistance and RoHS compliance
- Not UL Listed but tested and met UL486A-486B pullout requirements

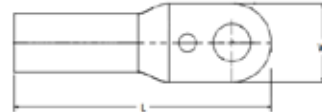

Catalog Number	Wire Range	Stud Size	Dimensions		Bulk Catalog Number	Conn. Color Code	Installation Tooling			Color Code (Die)	Die Index	Strip Length
			L	W			MD6, MD734R, 500, 600 Series	35, 750 Series	Dieless (# Crimps)			
YAGB6CLTC10FX	#6	#10	1.46"	0.44"	YAGB6CLTC10FXOEM	Blue	W5CVT (1) W5CRT (1)	U5CRT (1)	81K Series (1) 4PC Series (1) MY2911 (1) MRC840 (1)	Blue	7	7/8"
YAGB6CLTC14FX		1/4"			YAGB6CLTC14FXOEM							
YAGB6CLTC516FX		5/16"	1.61"	0.60"	YAGB6CLTC516FXOEM							
YAGB6CLTC38FX		3/8"	YAGB6CLTC38FXOEM									
YAGB6CLTC12FX		1/2"	1.73"	0.74"	YAGB6CLTC12FXOEM							
YAGB4CLTC10FX	#4	#10	1.97"	0.75"	YAGB4CLTC10FXOEM	Gray	W4CVT (1) W4CRT (1)	U4CRT (1)	81K Series (1) 4PC Series (1) 644 Series (1) MY2911 (1) MRC840 (1)	Gray	6	15/16"
YAGB4CLTC14FX		1/4"			YAGB4CLTC14FXOEM							
YAGB4CLTC516FX		5/16"			YAGB4CLTC516FXOEM							
YAGB4CLTC38FX		3/8"			YAGB4CLTC38FXOEM							
YAGB4CLTC12FX		1/2"			YAGB4CLTC12FXOEM							
YAGB2CLTC10FX	#2	#10	2.09"	0.81"	YAGB2CLTC10FXOEM	Green	W2CVT (1) W2CRT (1)	U2CRT (1)	81K Series (1) 4PC Series (1) 644 Series (1) MY2911 (1) MRC840 (1)	Brown	10	15/16"
YAGB2CLTC14FX		1/4"			YAGB2CLTC14FXOEM							
YAGB2CLTC516FX		5/16"			YAGB2CLTC516FXOEM							
YAGB2CLTC38FX		3/8"			YAGB2CLTC38FXOEM							
YAGB2CLTC12FX		1/2"			YAGB2CLTC12FXOEM							
YAGB25LTC14FX	1/0	1/4"	2.40"	0.87"	YAGB25LTC14FXOEM	Black	W25VT (1) W25RT (1)	U25RT (1)		Pink	12	
YAGB25LTC516FX		5/16"			YAGB25LTC516FXOEM							
YAGB25LTC38FX		3/8"			YAGB25LTC38FXOEM							
YAGB25LTC12FX		1/2"			YAGB25LTC12FXOEM							
YAGB26LTC14FX	2/0	1/4"	2.44"	0.91"	YAGB26LTC14FXOEM	Orange	W26VT (1) W26RT (1)	U26RT (1)	81K Series (1) 4PC Series (1) 644 Series (1) MY2911 (1) MRC840 (2)	Black	13	1-3/16"
YAGB26LTC516FX		5/16"			YAGB26LTC516FXOEM							
YAGB26LTC38FX		3/8"			YAGB26LTC38FXOEM							
YAGB26LTC12FX		1/2"			YAGB26LTC12FXOEM							
YAGB28LTC14FX	4/0	1/4"	2.56"	1.10"	YAGB28LTC14FXOEM	Yellow	W28VT (1) W28RT (1)	U28RT (1)		Purple	15	
YAGB28LTC516FX		5/16"			YAGB28LTC516FXOEM							
YAGB28LTC38FX		3/8"			YAGB28LTC38FXOEM							
YAGB28LTC12FX		1/2"			YAGB28LTC12FXOEM							

TYPE YCP-L

Compression Cable Pulling Heads

Before using this product, it is required to read, understand, and comply with the Safety Operation Maintenance & Installation manual provided with the product.

Features & Benefits

- Range-taking; only 6 compression pulling heads are required to pull #6 AWG through 1000 kcmil wire
- Accommodates:
 - Copper Class B (Concentric, Compressed, Compact) or Class C wire
 - Aluminum Class B (Concentric, Compressed, Compact)
- Parallel installation; each of the 6 compression pulling heads come in 5 unique lanyard lengths for staggering when pulling multiple wires
- Knurl crimp bands clearly indicate the crimp zone locations on the compression pulling head barrels
- Protection sleeve at the lanyard loop connection

Catalog Number	Barrel OD (in)	Wire Size (Cu & AL)	Lanyard Length (in)	Minimum Wire Strip Length (in)
YCP25L13	.51"	#6 - 1/0 AWG	13"	2.50"
YCP25L20			20"	
YCP25L27			27"	
YCP25L34			34"	
YCP25L41			41"	
YCP28L13	.69"	2/0 AWG 3/0 AWG 4/0 AWG	13"	3.00"
YCP28L20			20"	
YCP28L27			27"	
YCP28L34			34"	
YCP28L41			41"	
YCP31L13	.88"	250 kcmil 300 kcmil 350 kcmil	13"	3.25"
YCP31L20			20"	
YCP31L27			27"	
YCP31L34			34"	
YCP31L41			41"	
YCP34L13	1.06"	400 kcmil 450 kcmil 500 kcmil	13"	3.25"
YCP34L20			20"	
YCP34L27			27"	
YCP34L34			34"	
YCP34L41			41"	
YCP39L13	1.30"	550 kcmil 600 kcmil 650 kcmil 700 kcmil 750 kcmil	13"	3.25"
YCP39L20			20"	
YCP39L27			27"	
YCP39L34			34"	
YCP39L41			41"	



Compression Connections

Compression Cable Pulling Heads
Type YCP-L

TYPE YCP-L (Continued)

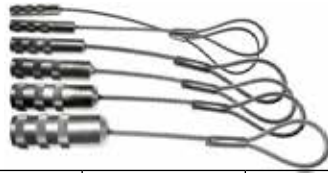

Catalog Number	Barrel OD (in)	Wire Size (Cu & AL)	Lanyard Length (in)	Minimum Wire Strip Length (in)
YCP44L13	1.50"	800 kcmil 900 kcmil 1000 kcmil	13"	3.25"
YCP44L20			20"	
YCP44L27			27"	
YCP44L34			34"	
YCP44L41			41"	

Installation Tooling and Max Rated Pull Loads		Max. Rated Pull Load per Cable (lbs) Copper & Aluminum Wire with 444 and 644 Series of Tools			Max. Rated Pull Load per Cable (lbs) Copper & Aluminum Wire with 750 or 46 Platform Tooling			
Catalog Number* (add lanyard length)	Wire Size	Copper (Concentric Compress Compact)	Aluminum (Concentric Compress Compact)	444, 644 Series (# of Crimps)	Copper (Concentric Compress ONLY)	Copper (Compact ONLY)	Aluminum (Concentric Compress Compact)	750, 46** Series Die # (# of Crimps)
YCP25L-*	#6 AWG	200	200	(1)	N/A	N/A	N/A	N/A
	#4 AWG	300	300					
	#3 AWG	400	400					
	#2 AWG	500	400					
	#1 AWG	1,200	400					
YCP28L-*	1/0 AWG	1,200	400	(2)	1,200	550	400	U25RT (1)
	2/0 AWG	1,200	400					
	3/0 AWG	2,000	750					
YCP31L-*	4/0 AWG	2,000	1,000	(3)	2,000	1,000	1,000	U28RT (2)
	250 kcmil	2,000	1,200					
	300 kcmil	4,000	1,500					
YCP34L-*	350 kcmil	4,000	1,800	(3)	4,000	1,400	1,800	U31RT (3)
	400 kcmil	4,000	2,000					
	450 kcmil	5,000	2,400					
YCP39L-*	500 kcmil	5,000	2,700	(3)	5,000	2,200	2,700	U34RT (3)
	550 kcmil	5,000	3,600					
	600 kcmil	5,000	3,600					
	650 kcmil	5,000	3,600					
	700 kcmil	5,000	3,600					
YCP44L-*	750 kcmil	5,000	3,600	(3)	5,000	2,200	3,600	U39RT (3)
	800 kcmil	5,000	3,600					
	900 kcmil	5,000	3,600					
YCP44L-*	1000 kcmil	5,000	5,000	(3)	5,000	2,200	5,000	U44XRT (3)

* Lanyard length needs to be added for complete catalog number. Example: YCP34L13 is 13" Lanyard Length.

**46 Series requires PUADP1 adapter to use U dies.