

SWITCH / ROCKER SW

MR5 Industry's smallest AC/DC rocker switches, lighted, up to 6A 125VAC

Ultra Mini-Sized Rocker Switches, up to 6A 125VAC,
Appealing outlook illuminated & non-illuminated type
Soldering lug

PDF Download

Get Information

Print this page



ZOOM IN

Feature



- 6A 125VAC, 3A 250VAC (UL, CUL)
- 3A 250VAC μ T100/55 (VDE, ENEC,CQC)
- 3A 250VAC T100/55 (KC)
- Initial contact resistance : 20m ohm MAX.
- Insulation resistance : 100M ohm MIN. at 500VDC
- Dielectric strength : 1,000VAC FOR 1 MINUTE.
- Electrical life :1000(UL), 10,000 cycles. (VDE)
- Patent No: ZL201020514219.0 (CHINA)
- Temperature range : 0 to + 100 degrees in Celsius
- Base : Nylon 66, UL rated 94V-2 min
- Actuator : Nylon 66, UL rated 94V-2 min
- Spring : Piano wire
- Contacts: Silver alloy
- Terminals: Silver plated copper alloy
- Smallest AC rocker switch with highest rating in the market
- Optional request available: glow wire testing 750 degrees in Celsius by VDE according standard DIN EN 60335-1.
- Appealing outlook
- SPST, SPDT(non-illuminated type)

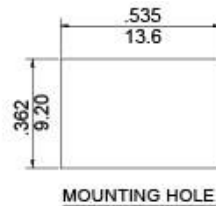

* Panel cut-out size fitting thickness of 0.75~1.25mm, for tolerance or other thicknesses, please consult our sales.

Item

[How to Order \(Standard square type, non-illuminated\)](#)

MR5	1	1	1	F	5	W
POLE	FUNCTION	TERMINAL TYPE	ACTUATOR TYPE	MARKING TYPE	MARKING COLOR	
1 SINGLE	1 ON-OFF 2 ON-ON 4 (ON)-OFF	1 SOLDER TERMINAL 2 PC TERMINAL	F FLAT	1 HI LO 2 NONE 3 ON OFF 4 ○ 5 ○ -	B BLACK W WHITE N NONE	

N	B	B	A	-	X
ILLUMINATED TYPE	BASE COLOR	ACTUATOR COLOR	SWITCH RATING & TEMPERATURE	SUFFIXES COLOR	
N NO LAMP	B BLACK W WHITE A GRAY	B BLACK A GRAY W WHITE R RED	A 6A 125VAC, 3A 250VAC T55 D 6A (6-30VDC) T55 1 6A 125VAC, 3A 250VAC T100/55 4 6A (6-30VDC) T100/55	BLANK NUMBER OR LETTERS (CUSTOM CODE)	

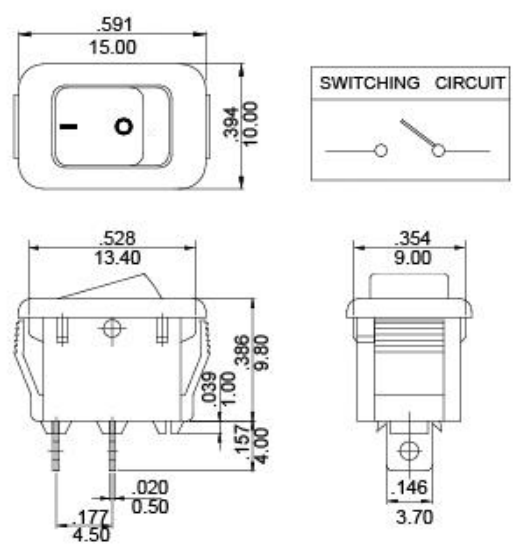



MR5-141F5W-NBRA

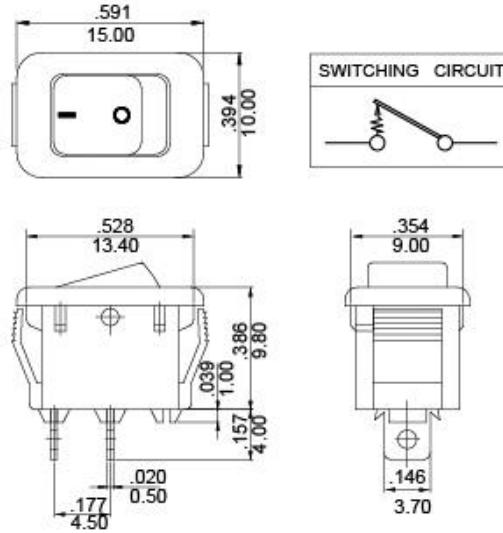

How to Order (LED Illuminated or Lever actuator)

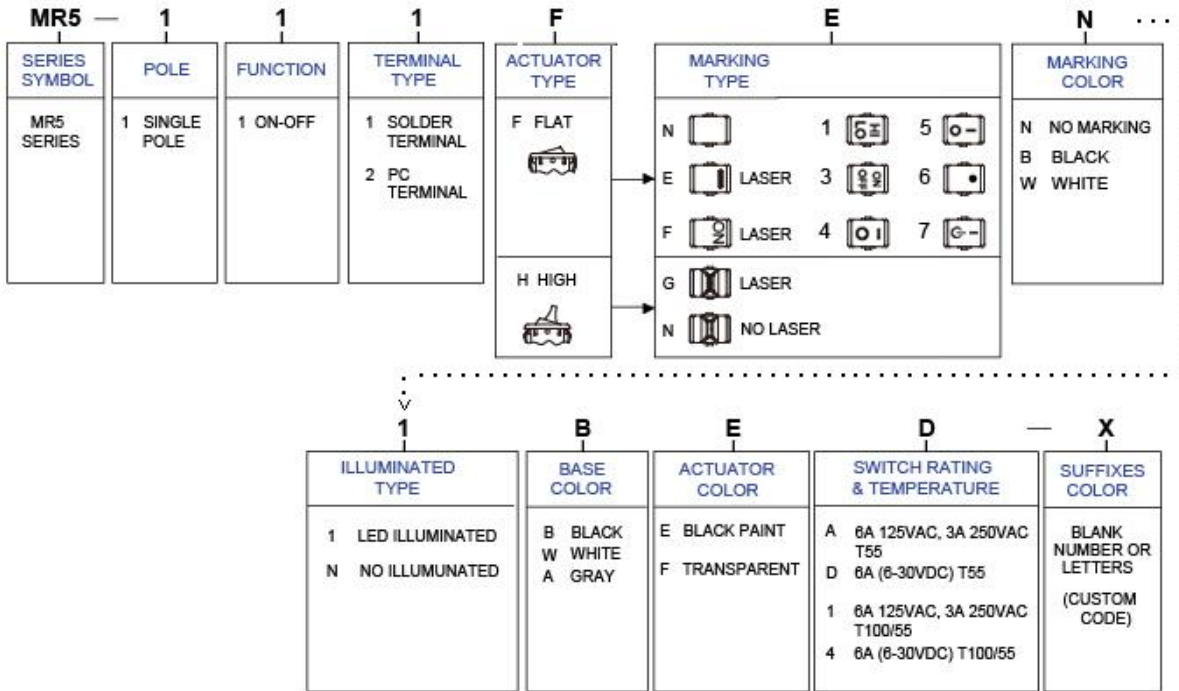



MR5-111FEN1BED-0G2C
(LINE symbol lighted in green)

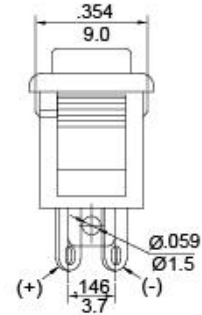
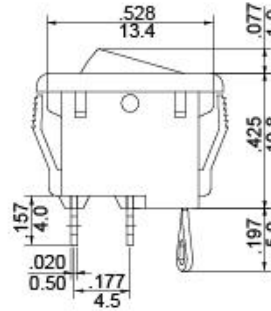
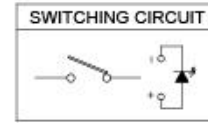
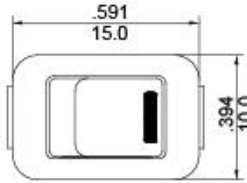

MR5-111FFN1BED-0W2C
(ON icon lighted in white)

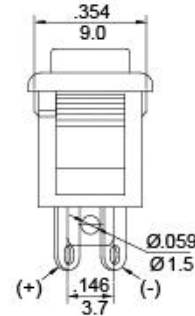
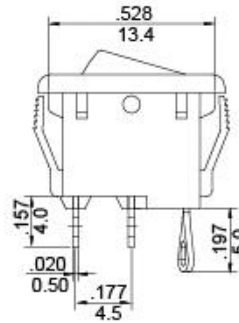
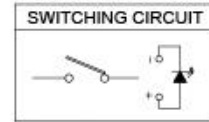
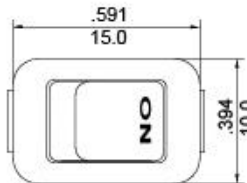

MR5-111F5B-1BFA-0R2C
(Red Led illuminated
in transparent PC actuator,
'O' printed vertically)

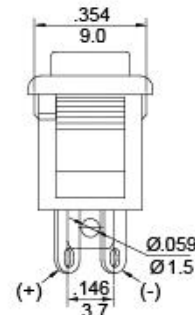
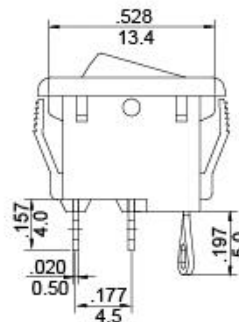
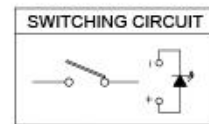
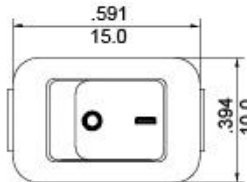



MR5-111HGN1BED-0G2C
(end tip lighted in green)

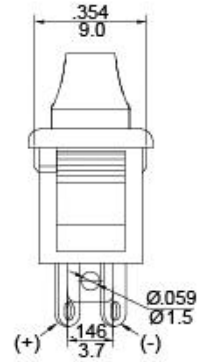
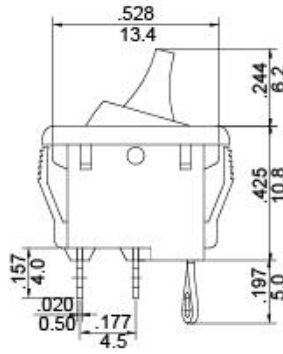
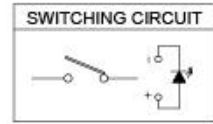
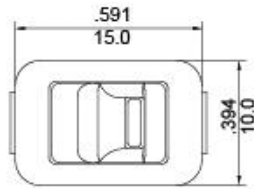

MR5-111HNN1BFD-0W2C
(full lighted in white)

