

RF APPLICATIONS

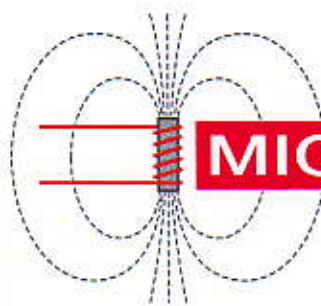

Issue H
December 2005



MICROMETALS

IRON POWDER CORES

CONTENTS

General Material Properties	1	Balun Cores	17
Engineering Kits	2	Cylindrical Core Applications	18
Tolerances	3	Plain Cores	19
Toroidal Cores	4	Hollow Cores	20
Material Saturation Curves	9	Sleeves	21
Material Core Loss Curves	10	Threaded Cores	22
Q versus Frequency Curves	12	Cups/Discs	23
Winding Table	14	Toroids (Rectangular), Squared Bobbins	24
Broadband Applications	15	Additional Literature	25

Copyright © 2005 by Micrometals, Inc.
Issue H, Reprinted December 2005

MICROMETALS, INC. established in 1951, is committed to supplying high quality iron powder cores to meet the needs of the electronics industry. As the technology has changed, new shapes, sizes and materials have been introduced to become industry standards.



MICROMETALS, INC.

Iron powder has been used as a core material in RF circuits for many years. It is typically used to produce high "Q" inductors from 50 KHz to 500 MHz and broadband transformers above 50 MHz. It is a preferred core material due to its stability, high "Q", frequency response, and power handling capabilities.

Micrometals offers iron powder cores produced to narrow permeability tolerances, which results in cores with close uniformity within lots and relative uniformity from lot to lot.

TEL. (714) 970-9400
FAX (714) 970-0400

MICROMETALS

GENERAL MATERIAL PROPERTIES FOR RF MATERIALS

Material Mix No.	Basic Iron powder	Material Permeability (μ_0)	Temperature ¹ Stability (+ppm/C ⁰)	Relative Cost	Toroidal Color Code
-1	Carbonyl C	20	280	2.7	Blue/Clear
-2	Carbonyl E	10	95	1.7	Red/Clear
-3	Carbonyl HP	35	370	2.5	Gray/Clear
-4	Carbonyl J	9.0	280	2.0	Blue/White
-6	Carbonyl SF	8.5	35	2.0	Yellow/Clear
-7	Carbonyl TH	9.0	30	2.0	White/Clear
-8	Carbonyl GQ4	35	255	2.5	Orange/Clear
-10	Carbonyl W	6.0	150	4.7	Black/Clear
-12*	Synthetic Oxide	4.0	170**	1.5	Green/White
-15	Carbonyl GS6	25	190	3.1	Red/White
-17	Carbonyl	4.0	50	3.1	Blue/Yellow
-42	Hydrogen Reduced	40	550	1.4	Blue/Red
-0	Phenolic	1	0	1.0	Tan/Tan

¹Temperature stability values, averaged from -55°C to +125°C, are listed for closed magnetic structures.

* Non-linear

** Mix 17 was developed as a temperature stable alternative to mix 12 and is recommended for all new designs.

Note: For information on Mix #'s 8, 14, 18, 26, 30, 34, 35, 38, 40, 45 and 52 see Micrometals Catalog for Power Conversion and Line Filter Applications.

RESONANT CIRCUIT* (—) AND BROADBAND FREQUENCY RANGE (- - -)

Mix #	Range (MHz)	2KHz to 50KHz	50KHz to 250KHz	250KHz to 500KHz	500KHz to 2MHz	2MHz to 10MHz	10MHz to 40MHz	40MHz to 150MHz	150MHz to 250MHz	250MHz to 500MHz	500MHz to 1GHz
42	.03-.80	—									
3	.02-1	—	—								
8	.02-1	—	—								
1	.15-3		—	—							
15	.15-3		—	—							
2	.25-10			—	—				—		
7	1-25				—	—					
4	3-40					—	—				
6	3-40					—	—			—	
10	15-100						—	—			—
17	20-200							—	—		
12	30-250								—	—	
0	50-350									—	—

*Resonant frequency range is given to optimize Q and core loss.

Materials can be used outside resonant frequency range where optimum Q is not required.

TYPICAL APPLICATIONS

-2, -4, -6, -7 Materials: These are the most popular carbonyl irons. They will provide high Q up to 40 MHz and are the most popular materials for amateur radio and a variety of other communication applications. They are also useful for moderate band transformers in the 200 to 400 MHz frequency range.

-1, -3, -8, -15 Materials: These materials are annealed carbonyl irons providing the highest carbonyl permeability. They are useful for high Q applications below 1 MHz. They will provide the broadest band transformers covering a typical range from 50 to 500 MHz.

-10, -17 Materials: These materials are the highest frequency carbonyl irons. They will provide high Q up to 150 MHz and are a popular material for cable television applications. They will produce moderate band transformers typically covering 400 to 700 MHz.

-0 Material: This is a non-magnetic material. It provides a solid form for winding air coils. It has excellent temperature stability and will provide high Q up to the highest frequencies. It is also useful for moderate band transformer applications covering a typical range from 600 to 1000 MHz.

TEL. (714) 970-9400
FAX (714) 970-0400

MICROMETALS

INTRODUCTION

AVAILABILITY

Part numbers in this catalog which appear in **bold** print are standard items and are generally available from stock. Other items are on a build-to-order basis. Orders may be placed directly with our main office in California or with any of our sales representatives.

Micrometals has factories in Anaheim, California and Abilene, Texas as well as in maintaining stocking warehouses in Hong Kong and Dietzenbach, Germany for immediate delivery to Asia and Europe. Please call for a complete list of our distributors and representatives. Micrometals will gladly extend sample cores and technical support to aid in your core selection.

ENGINEERING KITS

ENGINEERING KIT #20

Mixes 1,3,15 Frequency: 20KHz-3MHz
T12,T16,T20,T25,T30,T37,T44,T50,T68
17 items, 170 pieces

ENGINEERING KIT #22

Mixes 2,6,7 Frequency: 250KHz-30MHz
T7,T12,T16,T20,T22,T25,T27
T30,T37,T44,T50,T51,T60,T68
34 items, 240 pieces

ENGINEERING KIT #24

Mixes 10,17,0 Frequency: 10MHz-250MHz
T5,T7,T10,T12,T20,T22,
T25,T27,T30,T44,T50,T68
34 items, 340 pieces

ENGINEERING KIT #21

Mixes 1,3,15 Frequency: 20KHz-3MHz
T80,T94,T106,T130,T157,T184
10 items, 44 pieces

ENGINEERING KIT #23

Mixes 2,6,7 Frequency: 250KHz-30MHz
T72,T80,T94,T106,T130,T157,T175,
T200,T225,T250,T300,T400
20 items, 60 pieces

ENGINEERING KIT #25

Mixes 2,6,8,10,0 Frequency: 30MHz-1GHz
(Broadband Transformer Applications)
BLN814,BLN1728,BLN1728A
12 items, 120 pieces

INDUCTANCE RATINGS

In this catalog the inductance ratings, also known as A_L values, are expressed in nanohenries (10^{-9} Henries) per turn (N) squared (nH/N^2).

An example of a conversion from μH for 100 turns to nH/N^2 is:

$$350 \mu H \text{ for } 100 \text{ turns} = 35.0 \text{ nH/N}^2$$

To calculate the number of turns required for a desired inductance (L) in nanohenries (nH) use the following formula:

$$\text{Required turns} = \left[\frac{\text{desired } L(\text{nH})}{A_L (\text{nH/N}^2)} \right]^{1/2}$$

TEMPERATURE EFFECTS *

Micrometals iron powder cores have an organic content and undergo thermal aging. When the cores are exposed to or generated elevated temperatures, a permanent decrease in both inductance and quality factor will gradually occur. The extent of these changes are highly dependent on time, temperature, core size, frequency, and flux density. It is essential that these properties are considered in any design operating at or above 75°C. Iron powder cores tolerate temperatures down to -65°C with no permanent effects.

In high power applications where core loss is contributing to the total temperature, a decrease in quality factor will translate into an increase in eddy current losses which will further heat the core and can lead to thermal runaway. Designs where core loss exceeds copper loss should be avoided. Hysteresis losses are unaffected by the thermal aging process.

A more thorough and detailed discussion regarding thermal considerations for iron powder core designs is given on pages 38-40 of our Power Conversion Catalog. Furthermore, we are pleased to provide free consultation.

FINISH*

The toroidal cores listed in this catalog come with a protective coating. The T5 to T20 size cores are coated under vacuum with Parylene C. The larger cores are coated with a two color code finish that is **UL approved** for Flame Class UL94V-0 per file # E140098 (S). A copy of the Yellow card will be provided upon request. All finishes have a minimum dielectric strength of 500 Vrms at 60 Hz and resist most cleaning solvents. Extended exposure to certain solvents may have detrimental effects.

The toroidal cores can be double or triple coated for greater dielectric strength. We can also provide uncoated cores upon special request. Please contact the factory for information on optional finishes or core caps for larger size toroids. Micrometals recommends that all uncoated cores should be sheltered from high humidity or rain since they will eventually form surface rust.

Micrometals Iron Powder Cores will tolerate elevated temperatures for a limited time during Flow Solder, IR, or Vapor Phase soldering operations. The typical solder temperatures encountered are 200°C to 240°C for up to 25 seconds of exposure time. The physically small cores (T5-T20) that are parylene coated stand the greatest chance of damage to the coating if exposed too long at elevated temperature. The coating will soften and possibly "blister" under worst case exposure. The Polyester coating applied to core sizes T22-T650 will stand up to soldering temperatures for up to 2 minutes and not suffer any long-term damage.

TEL. (714) 970-9400
FAX (714) 970-0400

MICROMETALS

MAGNETIC TOLERANCE

Material	- 1	- 2	- 3	- 4	- 6	- 7	- 8	- 10	- 12	- 15	- 17	- 42	- 0
A _L Tolerance	±10%	±5%	±10%	±5%	±5%	±5%	±10%	±5%	±5%	±10%	±5%	±10%	N/A

The cores are manufactured to the A_L values listed; the permeability for each material is for reference only. Toroidal cores are tested with evenly-spaced windings in order to minimize leakage effects. Iron powder cores tested with a small number of turns which are not evenly distributed will produce higher inductance reading than expected.

The saturation curves shown on page 9 have a typical tolerance of ±10%. The core loss curves on page 10 have a typical tolerance of ±25%.

DIMENSIONAL TOLERANCE (inches)

TOROIDS*	OD	ID	Ht	TOROIDS*	OD	ID	Ht
T5 - T12	±.005	±.005	±.005	T80 - T130	±.020	±.020	±.025
T16 - T20	±.010**	±.010**	±.010**	T157 - T225	±.025	±.025	±.030
T22 - T37	±.015	±.015	±.020**	T300 - T520	±.030	±.030	±.030
T44 - T72	±.020	±.020	±.020				
BALUN CORES	A	B	ID	D	Length		
BLN814 - BLN1728	±.005**	±.005**	±.005**	±.005**	±.007**		
PLAIN CORES	OD	Length					
P22	+ .000/- .003	±.005					
P23 - P35	+ .000/- .003	±.010					
P48 - P810	+ .000/- .005	±.010					
P825 - P2028	+ .000/- .005	±.015					
P2440 - P6448	+ .000/- .005	±.020					
HOLLOW CORES	OD	ID	Length				
H22 - H68	+ .000/- .005	+ .005/- .000	±.010				
H520 - H918	+ .000/- .005	+ .005/- .000	±.015				
H1020 - H1616	+ .000/- .005	+ .005/- .000	±.020				
SLEEVES	OD	ID	Length				
S2 - S7	+ .000/- .005	+ .005/- .000	±.010**				
S10 - S12	+ .000/- .005	+ .005/- .000	±.015**				
S16 - S30	+ .000/- .005	+ .005/- .000	±.015				
THREADED CORES	OD	Length					
TH03 - TH412	±.001	±.010					
CUPS	OD	D	H	Ht	Depth		
C8 - C23	+ .000/- .005	+ .005/- .000	+ .005/- .000	±.010	±.005		
DISCS	OD	D	H	T			
D9 - D30	+ .000/- .005	+ .005/- .000	+ .005/- .000	±.004**			
TOROIDS (RECTANGULAR)	OD	ID	Ht				
TR11	±.008	±.008	±.008				
SQUARED BOBBINS	A	B	C	D	E	F	
SBB0505 - SBB3333	±.003	±.003	±.003	±.003	±.003	±.003	

*Tolerance includes coating
 **Revised since last issue

RF TOROIDS

COLOR CODE*

- 1 Blue/Clear
- 2 Red/Clear
- 3 Gray/Clear
- 6 Yellow/Clear
- 7 White/Clear
- 10 Black/Clear
- 12 Green/White
- 15 Red/White
- 17 Blue/Yellow
- 0 Tan

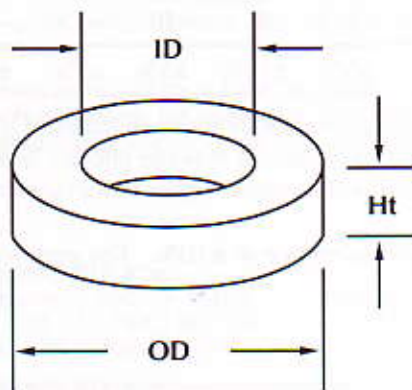

TYPICAL PART NO.

T 25 - 10

OD in 100th Inches
Micrometals Mix No.
Letter Indicates Alternate Height

Note: For information on Mix -14, -18, -26, -30, -34, -35, -38, -40, -45 and -52 see Micrometals Power Conversion catalog.

* T5's and T7's have no color code

Refer to page 3 for tolerances

MICROMETALS Part No.	A _L nH/N ²	OD in/mm	ID in/mm	Ht in/mm	MAGNETIC DIMENSIONS		
					cm	A cm ²	V cm ³
T5-6	1.0	.050/ 1.27	.025/ .64	.025/ .64	.30	.0019	.0006
T5-10	.7						
T5-17	.42						
T5-0	.16						
T7-1	3.5	.070/ 1.78	.035/ .89	.030/ .76	.42	.0035	.0015
T7-2	1.35						
T7-6	1.3						
T7-10	.9						
T7-12	.6						
T7-17	.6						
T7-0	.3						
T10-1	3.2	.097/ 2.46	.044/ 1.12	.030/ .76	.56	.0045	.0025
T10-2	1.35						
T10-6	1.15						
T10-10	.8						
T10-12	.5						
T10-17	.5						
T10-0	.24						
T12-1	4.8	.125/ 3.18	.062/ 1.57	.050/ 1.27	.75	.010	.0077
T12-2	2.0						
T12-3	6.0						
T12-6	1.7						
T12-7	1.8						
T12-10	1.2						
T12-12	.75						
T12-15	5.0						
T12-17	.75						
T12-0	.24						
T12-2B	1.62	.125/ 3.18	.062/ 1.57	.042/ 1.07	.75	.008	.0061
T12-6B	1.35						
T12-10B	1.0						
T16-1	4.4	.160/ 4.06	.078/ 1.98	.060/ 1.52	.93	.015	.0141
T16-2	2.2						
T16-3	6.1						
T16-6	1.9						
T16-10	1.3						
T16-12	.8						
T16-15	5.5						
T16-17	.8						
T16-0	.3						
T18-6	.9	.185/ 4.70	.102/ 2.59	.040/ 1.02	1.14	.010	.0114

TEL. (714) 970-9400
FAX (714) 970-0400

MICROMETALS

COLOR CODE

- 1 Blue/Clear
- 2 Red/Clear
- 3 Gray/Clear
- 6 Yellow/Clear
- 7 White/Clear
- 10 Black/Clear
- 12 Green/White
- 15 Red/White
- 17 Blue/Yellow
- 0 Tan

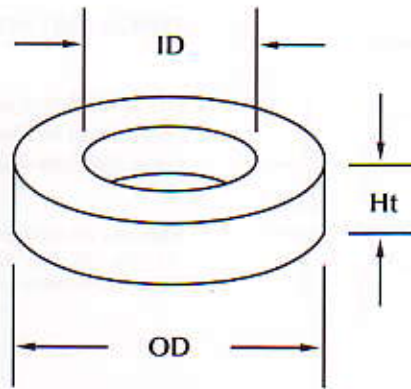

TYPICAL PART NO.

T 25 - 10

OD in 100th Inches

Micrometals Mix No.

Letter Indicates Alternate Height

Note: For information on Mix -14, -18, -26, -30, -34, -35, -38, -40, -45 and -52 see Micrometals Power Conversion catalog.

Refer to page 3 for tolerances

MICROMETALS Part No.	A _L nH/N ²	MAGNETIC DIMENSIONS					
		OD in/mm	ID in/mm	Ht in/mm	l cm	A cm ²	V cm ³
T20-1	5.2	.200/5.08	.088/2.24	.070/1.78	1.15	.023	.026
T20-2	2.5						
T20-3	7.6						
T20-6	2.2						
T20-7	2.3						
T20-10	1.6						
T20-12	1.0						
T20-15	6.5						
T20-17	1.0						
T20-0	.35						
T22-2	5.5	.223/5.66	.097/2.46	.143/3.63	1.28	.052	.067
T22-6	4.5						
T22-10	3.2						
T25-1	7.0	.255/6.48	.120/3.05	.096/2.44	1.50	.037	.055
T25-2	3.4						
T25-3	10.0						
T25-6	2.7						
T25-7	2.9						
T25-10	1.9						
T25-12	1.2						
T25-15	8.5						
T25-17	1.2						
T25-0	.45						
T27-2	3.3	.280/7.11	.151/3.84	.128/3.25	1.71	.047	.080
T27-6	2.7						
T27-10	2.2						
T27-12	1.5						
T27-17	1.3						
T27-0	.45						
T30-1	8.5	.307/7.80	.151/3.84	.128/3.25	1.84	.061	.110
T30-2	4.3						
T30-3	14.0						
T30-6	3.6						
T30-7	3.7						
T30-10	2.5						
T30-12	1.6						
T30-15	9.3						
T30-17	1.6						
T30-0	.6						

TEL. (714) 970-9400
FAX (714) 970-0400

MICROMETALS

RF TOROIDS

COLOR CODE

- 1 Blue/Clear
- 2 Red/Clear
- 3 Gray/Clear
- 6 Yellow/Clear
- 7 White/Clear
- 10 Black/Clear
- 12 Green/White
- 15 Red/White
- 17 Blue/Yellow
- 0 Tan

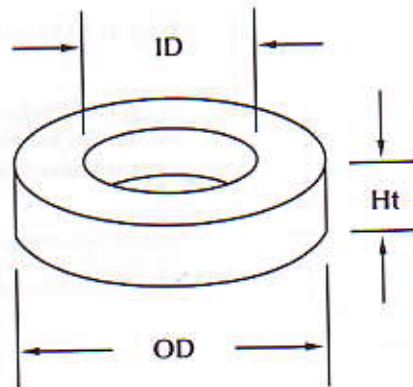

TYPICAL PART NO.

T 25 - 10

OD in 100th Inches

Micrometals Mix No.

Letter Indicates Alternate Height

Note: For information on Mix -14, -18, -26, -30, -34, -35, -38, -40, -45 and -52 see Micrometals Power Conversion catalog.

Refer to page 3 for tolerances

MICROMETALS Part No.	A _L nH/N ²	MAGNETIC DIMENSIONS					
		OD in/mm	ID in/mm	Ht in/mm	cm	A cm ²	V cm ³
T37-1	8.0	.375/9.53	.205/5.21	.128/3.25	2.31	.064	.147
T37-2	4.0						
T37-3	12.0						
T37-6	3.0						
T37-7	3.2						
T37-10	2.5						
T37-12	1.5						
T37-15	9.0						
T37-17	1.5						
T37-0	.49						
T44-1	10.5	.440/11.2	.229/5.82	.159/4.04	2.68	.099	.266
T44-2	5.2						
T44-3	18.0						
T44-6	4.2						
T44-7	4.6						
T44-10	3.3						
T44-12	1.85						
T44-15	16.0						
T44-17	1.85						
T44-0	.65						
T44-2A	3.6	.440/11.2	.229/5.82	.128/3.25	2.68	.080	.215
T50-1	10.0	.500/12.7	.303/7.70	.190/4.83	3.19	.112	.358
T50-2	4.9						
T50-3	17.5						
T50-6	4.0						
T50-7	4.3						
T50-10	3.1						
T50-12	1.8						
T50-15	13.5						
T50-17	1.8						
T50-0	.64						
T51-2B	13.8	.500/12.7	.200/5.08	.312/7.92	2.79	.282	.786
T51-6B	10.2						
T60-2	6.5	.600/15.2	.336/8.53	.234/5.94	3.74	.187	.699
T60-6	5.5						
T68-1	11.5	.690/17.5	.370/9.40	.190/4.83	4.23	.179	.759
T68-2	5.7						
T68-3	19.5						
T68-6	4.7						

TEL: (714) 970-9400
FAX: (714) 970-0400

MICROMETALS

COLOR CODE

- 1 Blue/Clear
- 2 Red/Clear
- 3 Gray/Clear
- 6 Yellow/Clear
- 7 White/Clear
- 10 Black/Clear
- 12 Green/White
- 15 Red/White
- 17 Blue/Yellow
- 0 Tan

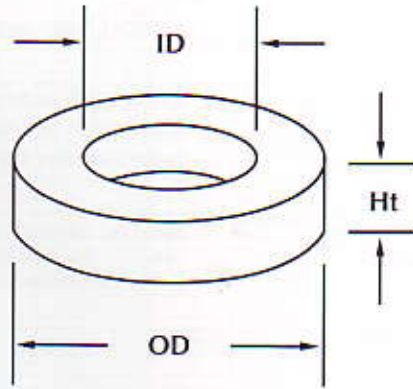

TYPICAL PART NO.

T 25 - 10

OD in 100th Inches

Micrometals Mix No.

Letter Indicates Alternate Height

Note: For information on Mix -14, -18, -26, -30, -34, -35, -38, -40, -45 and -52 see Micrometals Power Conversion catalog.

Refer to page 3 for tolerances

MICROMETALS Part No.	A _L nH/N ²	MAGNETIC DIMENSIONS					
		OD in/mm	ID in/mm	Ht in/mm	cm	A cm ²	V cm ³
T68-7	5.2	.690/17.5	.370/9.40	.190/4.83	4.23	.179	.759
T68-10	3.2						
T68-12	2.1						
T68-15	18.0						
T68-17	2.1						
T68-0	.75						
T68-2A	7.0	.690/17.5	.370/9.40	.250/6.35	4.23	.242	1.03
T68-3A	26.0						
T68-6A	6.2						
T68-7A	7.3						
T72-2	12.8	.720/18.3	.280/7.11	.260/6.60	4.01	.349	1.40
T72-3	36.0						
T72-7	9.5						
T80-1	11.5	.795/20.2	.495/12.6	.250/6.35	5.14	.231	1.19
T80-2	5.5						
T80-3	18.0						
T80-6	4.5						
T80-7	5.0						
T80-10	3.2						
T80-12	2.2						
T80-15	17.0						
T80-17	2.2						
T80-0	.85						
T80-7B	8.4	.795/20.2	.495/12.6	.375/9.53	5.14	.346	1.78
T94-1	16.0	.942/23.9	.560/14.2	.312/7.92	5.97	.362	2.16
T94-2	8.4						
T94-3	24.8						
T94-6	7.0						
T94-10	5.8						
T94-15	20.0						
T94-17	2.9						
T94-0	1.06						
T106-1	28.0	1.060/26.9	.570/14.5	.437/11.1	6.49	.659	4.28
T106-2	13.5						
T106-3	45.0						
T106-6	11.6						
T106-7	13.3						
T106-15	34.5						
T106-17	5.1						
T106-0	1.9						

TEL. (714) 970-9400
FAX (714) 970-0400

MICROMETALS

RF TOROIDS

COLOR CODE

- 1 Blue/Clear
- 2 Red/Clear
- 3 Gray/Clear
- 6 Yellow/Clear
- 7 White/Clear
- 10 Black/Clear
- 12 Green/White
- 15 Red/White
- 17 Blue/Yellow
- 0 Tan

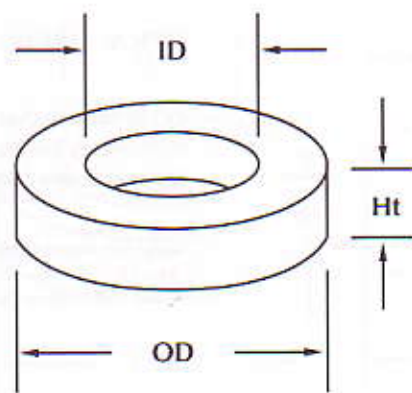

TYPICAL PART NO.

T 25 - 10

OD in 100th Inches
Micrometals Mix No.
Letter Indicates Alternate Height

Note: For information on Mix -14, -18, -26, -30, -34, -35, -38, -40, -45 and -52 see Micrometals Power Conversion catalog.

Refer to page 3 for tolerances

MICROMETALS Part No.	A _i nH/N ²	MAGNETIC DIMENSIONS					
		OD in/mm	ID in/mm	Ht in/mm	l cm	A cm ²	V cm ³
T130-1	20.0	1.300/33.0	.780/19.8	.437/11.1	8.28	.698	5.78
T130-2	11.0						
T130-3	35.0						
T130-6	9.6						
T130-7	10.3						
T130-15	25.0						
T130-17	4.0						
T130-0	1.5						
T157-1	32.0	1.570/39.9	.950/24.1	.570/14.5	10.1	1.06	10.7
T157-2	14.0						
T157-3	42.0						
T157-6	11.5						
T157-17	5.3						
T175-2	15.0	1.750/44.5	1.070/27.2	.650/16.5	11.2	1.34	15.0
T175-6	12.5						
T184-1	50.0	1.840/46.7	.950/24.1	.710/18.0	11.2	1.88	21.0
T184-2	24.0						
T184-3	72.0						
T184-6	19.5						
T184-17	8.7						
T200-1	25.0	2.000/50.8	1.250/31.8	.550/14.0	13.0	1.27	16.4
T200-2	12.0						
T200-3	42.5						
T200-6	10.4						
T200-7	10.5						
T200-2B	21.8	2.000/50.8	1.250/31.8	1.000/25.4	13.0	2.32	30.0
T225-2	12.0	2.250/57.2	1.400/35.6	.550/14.0	14.6	1.42	20.7
T225-3	42.5						
T225-6	10.4						
T225-2B	21.5	2.250/57.2	1.400/35.6	1.000/25.4	14.6	2.59	37.8
T300-2	11.4	3.040/77.2	1.930/49.0	.500/12.7	19.8	1.68	33.4
T300-2D	22.8	3.040/77.2	1.930/49.0	1.000/25.4	19.8	3.78	67.0
T400-2	18.0	4.000/102	2.250/57.2	.650/16.5	25.0	3.46	86.4
T400-2D	36.0	4.000/102	2.250/57.2	1.300/33.0	25.0	6.85	171
T520-2	20.0	5.200/132	3.808/78.2	.800/20.3	33.1	5.24	173

TEL (714) 970-9400
FAX (714) 970-0400

MICROMETALS

SATURATION CURVES

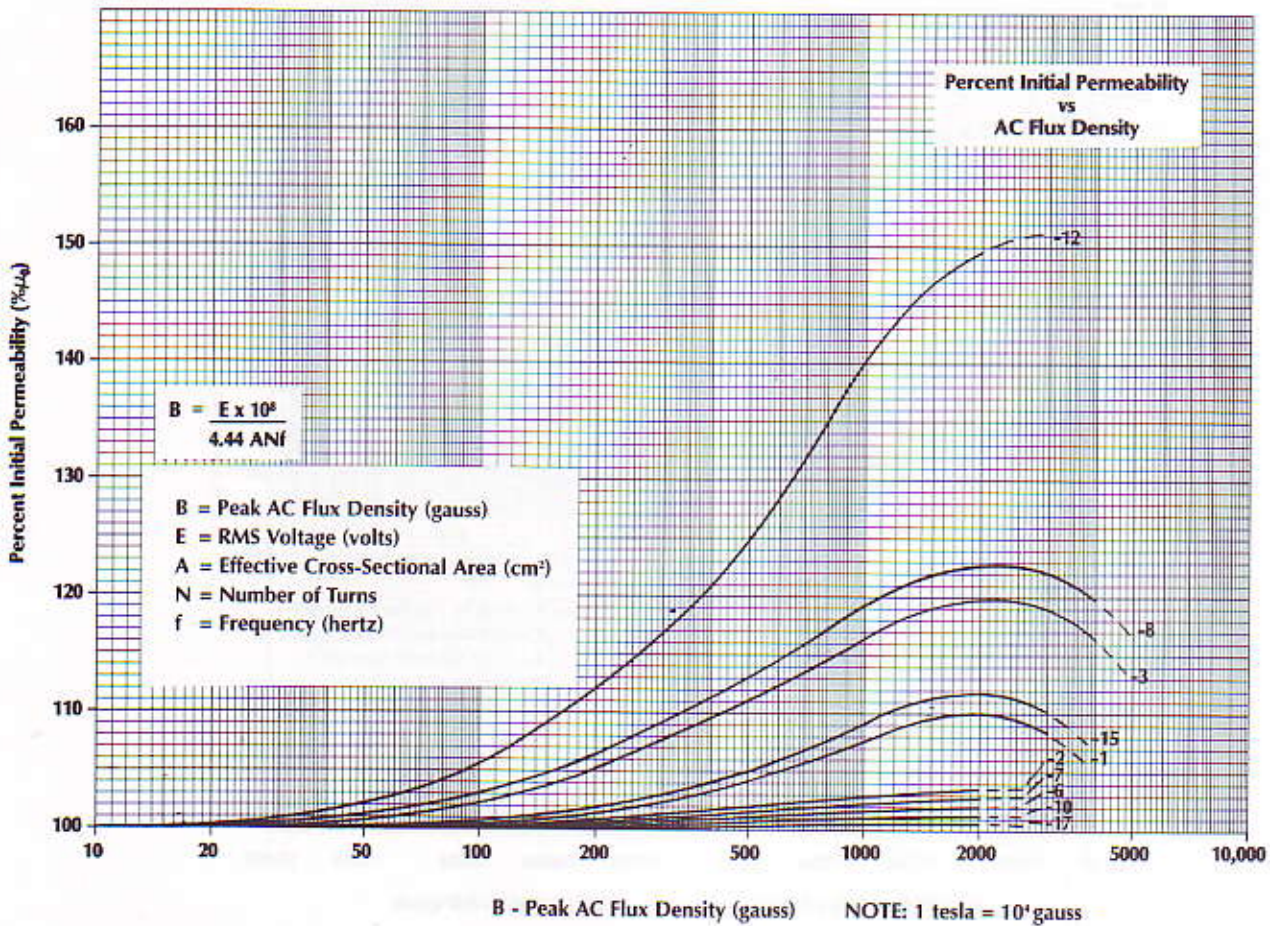
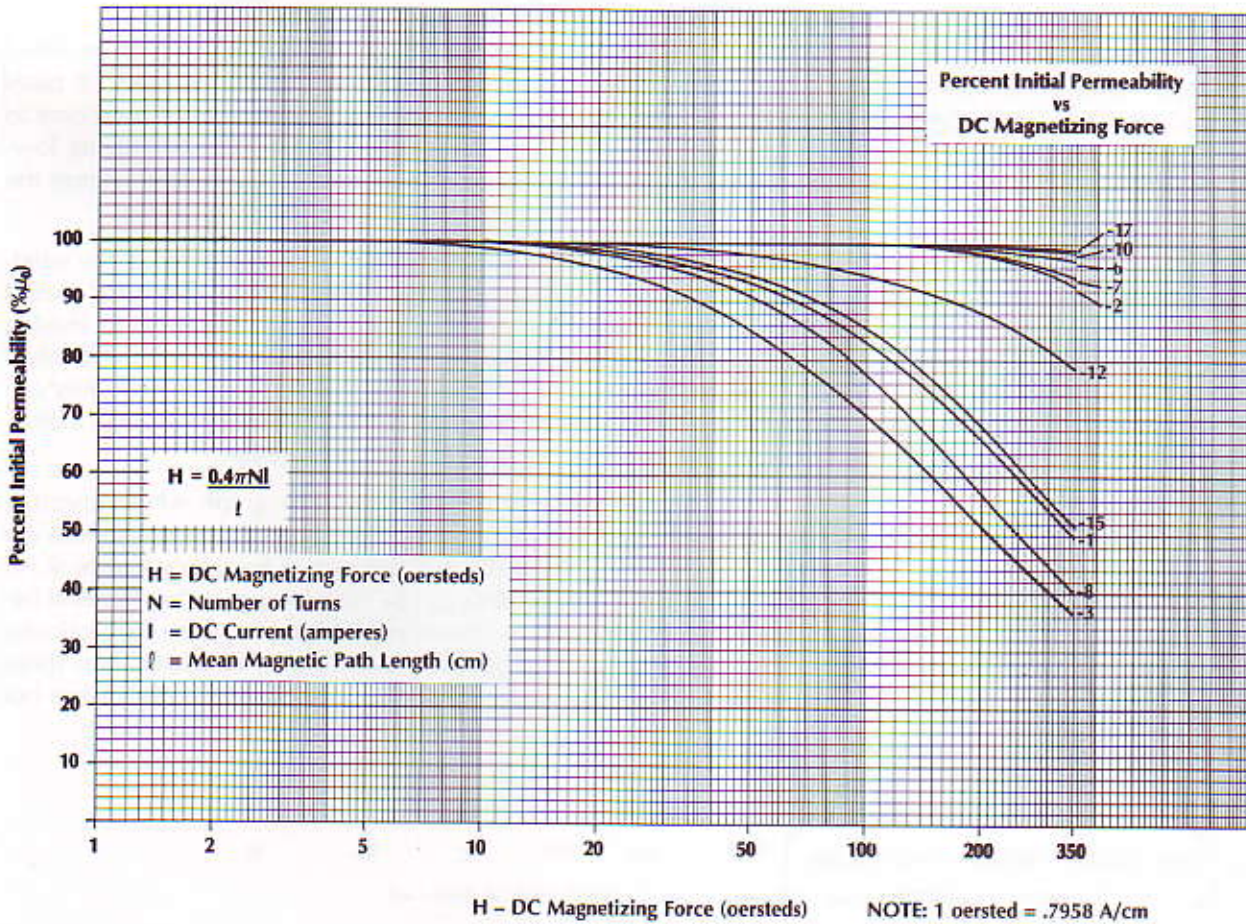

TEL. (714) 970-9400
 FAX (714) 970-0400

MICROMETALS

CORE LOSS

CORE LOSS CHARACTERISTICS

The Q-curves on pages 12 and 13 of this catalog and in Micrometals application supplement "Q Curves for Iron Powder Cores" are very useful for designing high Q, low-power inductors and transformers. These curves result from measurements made on low voltage Q-meters.

The design of inductors and transformers for higher power applications requires additional considerations. A common misconception is that core saturation (refer to page 9) is the primary limiting factor in high power RF applications. However, core loss measurements on iron powder cores at high frequency show that, with sinewave signals, excessive temperature rise resulting from the losses in the winding and the core material is the limiting factor.

The core loss information shown is in milliwatts per cubic centimeter of core material as a function of peak AC flux density for various frequencies. Faraday's Law is used to calculate the peak AC flux density. The effective cross-sectional area and volume for each core size is listed on pages 4 - 8.

The following formula provides a reasonable approximation for the temperature rise of a core in free standing air.

$$\text{Temp Rise (C}^\circ\text{)} = \left[\frac{\text{Total Power Dissipation (Milliwatts)}}{\text{Surface Area (cm}^2\text{)}} \right] .833$$

In other environments such as moving air or an enclosed case, other relationships will need to be used. It takes about 2 hours of constant power dissipation for a core to reach its final temperature. Applications involving low-duty cycle or intermittent operation can time average the losses in order to approximate temperature rise.

The surface area for most core sizes is listed in the winding table on page 14. The surface area of a toroid increases at approximately a squared rate with outside diameter while the volume increases at approximately a cubed rate. The result is that small diameter cores can dissipate more power per unit volume than large diameter cores for the same temperature rise.

A formula is provided on each graph which approximates the experimental core loss results in milliwatts per cubic centimeter as a function of frequency and peak AC flux density. This can be useful in projecting losses at frequencies not shown on the graphs. Core loss calculations at frequencies much higher or lower than those shown on the graphs may be useful for indication but should be verified experimentally.

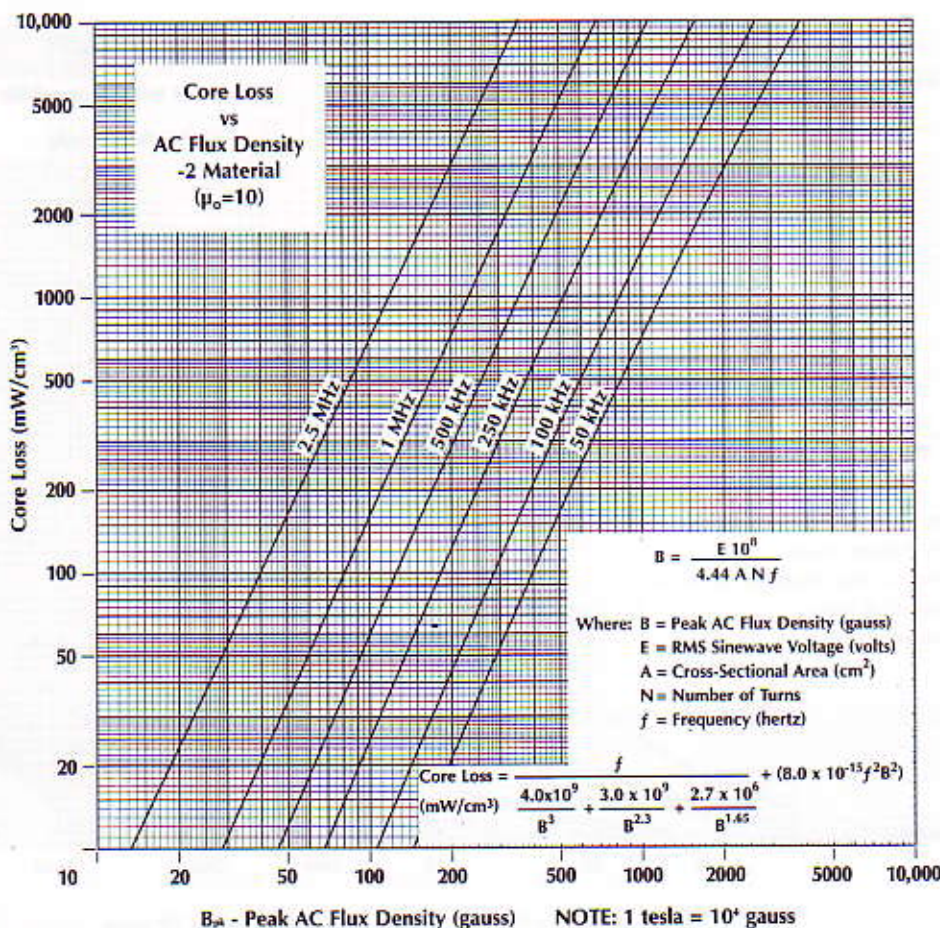

TEL. (714) 970-9400
FAX (714) 970-0400

MICROMETALS

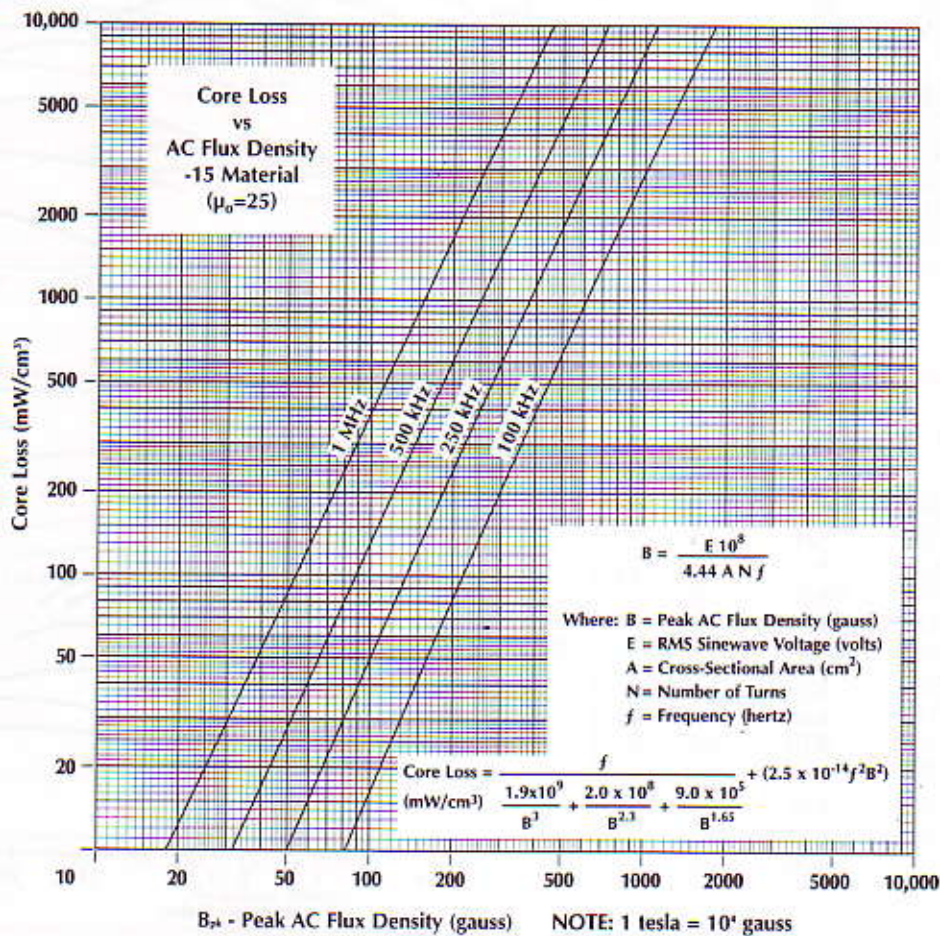
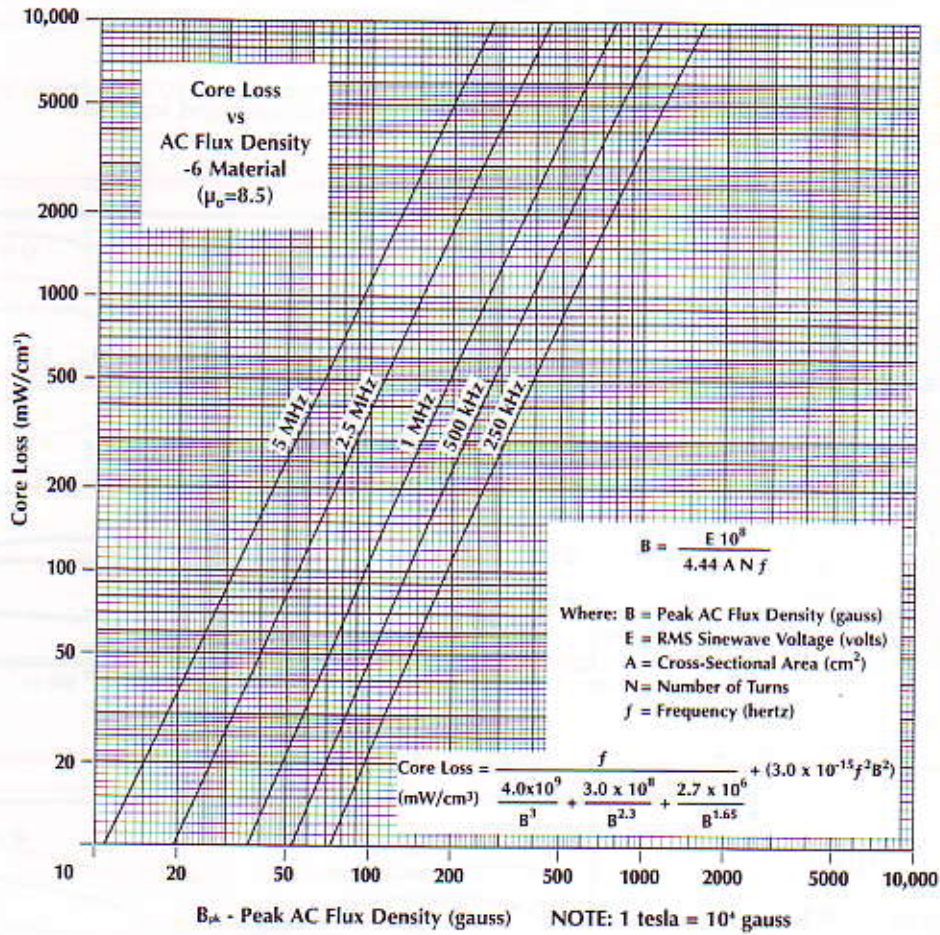

TEL. (714) 970-9400
 FAX (714) 970-0400

MICROMETALS

Q vs FREQUENCY

The Q of an inductor is represented by the following expression:

$$Q = \frac{2 \pi f L}{R}$$

Where: F = Frequency

L = inductance

R = effective series resistance due to both copper and iron loss.

100 kHz to 30 MHz

MIX-3

	Turns	Wire	L (μH)
T130-3*	200	#28	1400
T106-3	100	#26	450
T94-3	100	#28	248
T80-3	100	#28	180
T68-3	100	#30	195
T50-3	100	#32	175
T44-3	100	#34	180
T37-3*	100	#33	120
T30-3*	100	#32	140
T25-3*	100	#34	100
T20-3*	100	#38	76

*Not Single Layers

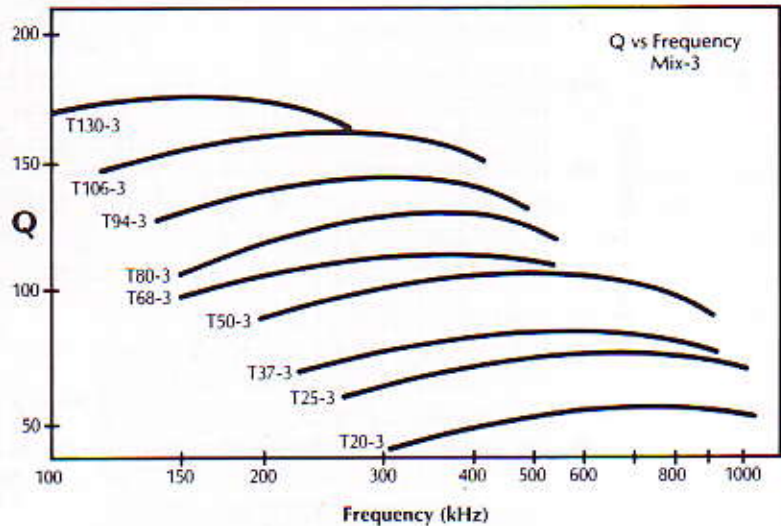

MIX-2

	Turns	Wire	L (μH)
T94-2	100	#28	84
T80-2	100	#28	55
T68-2	100	#30	57
T50-2	77	#30	29
T44-2	66	#30	23
T37-2	53	#30	11.5
T30-2	47	#32	9.3
T25-2	30	#30	3.0
T20-2	30	#33	2.4
T12-2	25	#36	1.3
T10-2	25	#40	.9

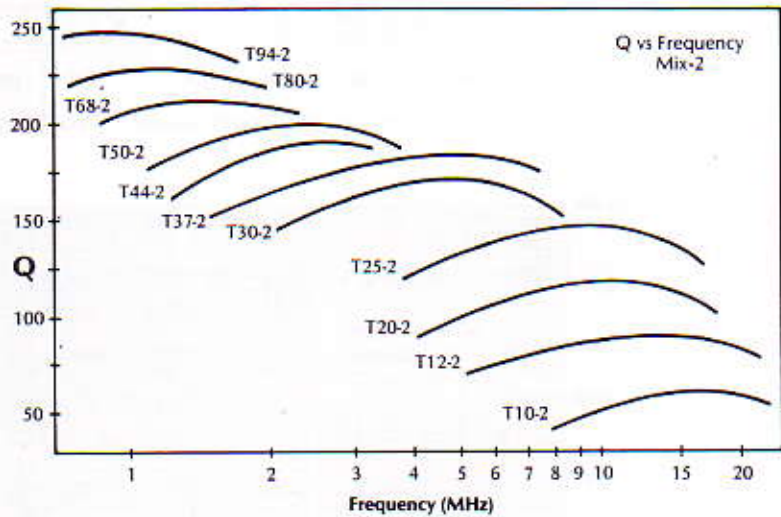

MIX-6

	Turns	Wire	L (μH)
T80-6	70	#26	22
T68-6	60	#27	17
T50-6	50	#27	10
T44-6	47	#28	9.3
T37-6	40	#28	4.8
T30-6	37	#30	4.9
T27-6	32	#30	2.8
T25-6	30	#30	2.5
T20-6	30	#33	2.0
T16-6	25	#33	1.2
T12-6	22	#34	.7
T10-6	17	#36	.3

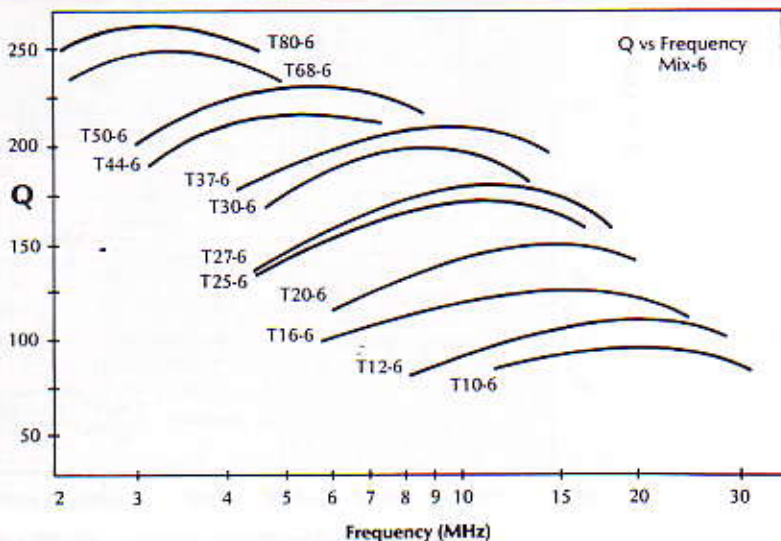

TEL: (714) 970-9400
FAX: (714) 970-0400

MICROMETALS

Q vs FREQUENCY

The interrelationships between frequency, Q, inductance, core size, and winding considerations are discussed in more detail in Micrometals Q Curve Supplement, "Q Curves for Iron Powder Cores."

Unless otherwise noted, the coils in this listing are single layer magnet wire.

10 MHz to 200 MHz

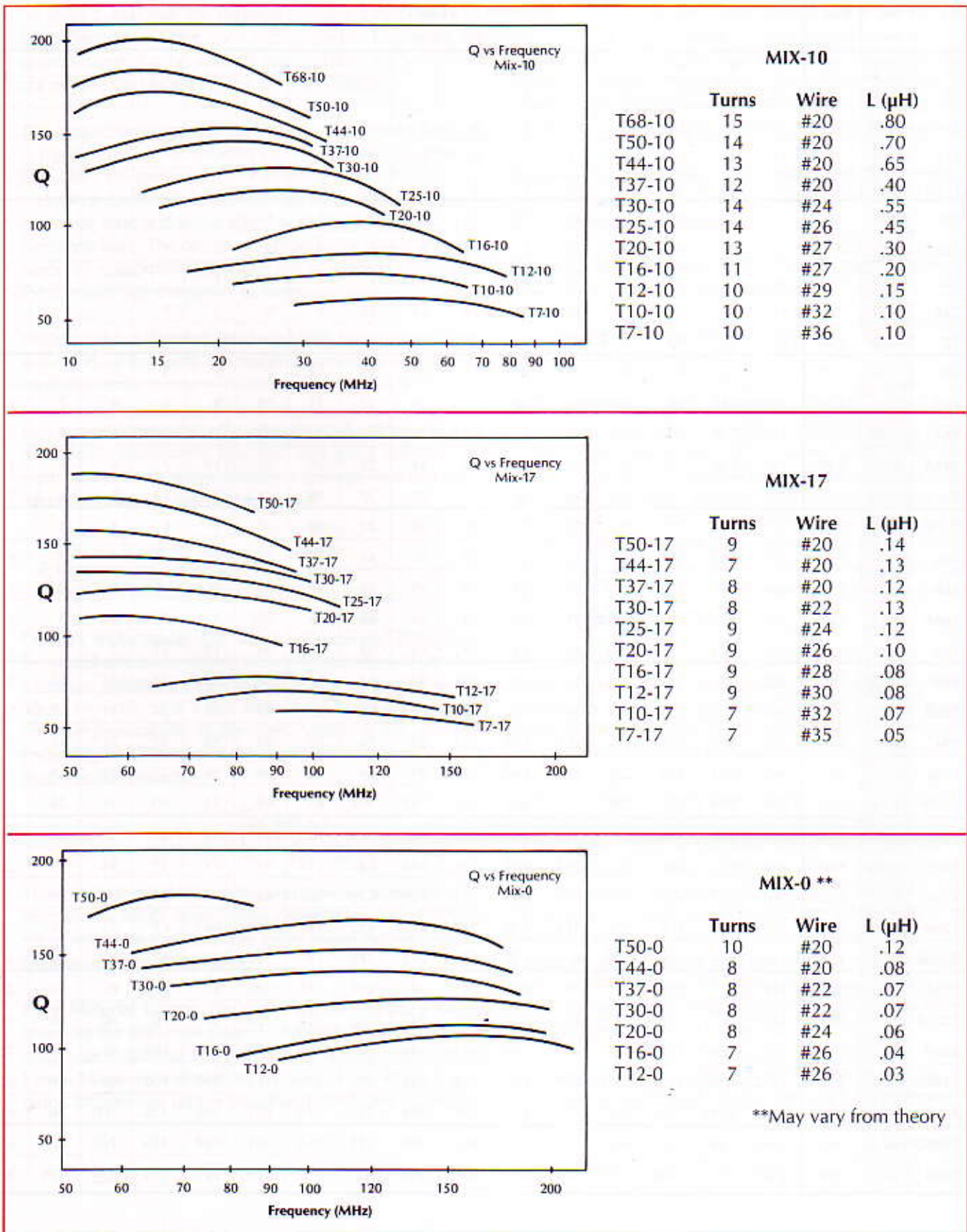

MICROMETALS
 TEL. (714) 970-9400
 FAX (714) 970-0400

WINDING TABLE

SINGLE LAYER WINDING TABLE

Wire Size (AWG)	40	38	36	34	32	30	28	26	24	22	20	18	16	14	12	10		
Resistivity (mΩ/cm)	35.4	21.3	13.6	8.57	5.32	3.40	2.13	1.34	.842	.530	.330	.210	.132	.083	.052	.033		
Part No.	MTL cm/turn	Surface Area (cm ²)	NUMBER OF TURNS															
			12	8	6	4	2											
T5	.283	.089	12	8	6	4	2											
T7	.349	.154	20	15	11	8	5	3	2									
T10	.416	.248	28	21	16	12	8	6	4	2								
T12	.564	.445	43	33	26	20	15	11	8	5	3	1						
T12B	.523	.415	43	33	26	20	15	11	8	5	3	1						
T16	.799	.800	48	37	29	22	17	13	9	6	4	2	1					
T20	.956	1.16	57	44	34	27	20	15	11	8	5	3	2	1				
T22	1.38	1.84	64	50	35	31	23	18	13	10	7	4	2	1				
T25	1.19	1.88	84	65	52	41	31	24	18	14	10	7	5	3	1			
T27	1.36	2.46	110	86	69	54	42	33	25	20	15	11	7	5	3	1		
T30	1.44	2.79	110	86	69	54	42	33	25	20	15	11	7	5	3	1		
T37	1.53	3.77	156	122	98	78	60	48	37	29	22	17	12	9	6	4	2	1
T44	1.84	5.23	177	138	111	88	69	55	43	34	26	20	15	11	7	5	3	1
T44A	1.69	4.80	177	138	111	88	69	55	43	34	26	20	15	11	7	5	3	1
T50	2.01	6.86	239	187	151	121	94	76	59	47	37	28	22	16	12	8	6	3
T51B	2.89	8.44	152	118	95	76	59	47	36	28	22	16	12	9	6	4	2	
T60	2.48	9.84	267	209	169	135	106	85	67	53	41	32	25	19	14	10	7	4
T68	2.47	11.2	296	232	187	150	117	94	74	59	46	36	28	21	16	12	8	5
T68A	2.77	12.5	296	232	187	150	117	94	74	59	46	36	28	21	16	12	8	5
T72	3.15	13.3	220	172	138	110	86	69	54	43	33	26	19	14	11	7	5	3
T80	2.80	15.5	402	316	255	204	161	129	103	82	64	51	39	30	23	17	13	9
T80B	3.44	18.7	402	316	255	204	161	129	103	82	64	51	39	30	23	17	13	9
T94	3.44	22.0	458	359	290	233	183	148	117	94	74	58	45	35	27	21	15	11
T106	4.49	31.0	462	362	293	235	185	149	118	95	74	59	46	36	27	21	15	11
T130	4.75	42.2	640	503	406	326	257	208	165	133	105	83	65	51	40	31	23	17
T157	5.89	63.2	784	616	499	401	316	256	204	164	129	103	81	64	50	39	30	23
T175	6.58	79.1	886	697	564	453	357	289	230	186	147	117	92	73	57	44	34	26
T184	7.54	89.2	780	613	496	398	314	254	202	163	129	102	81	63	50	38	29	22
T200	6.50	90.9	1035	814	658	529	418	338	270	217	172	137	108	86	67	53	41	31
T200B	8.78	120	1035	814	658	529	418	338	270	217	172	137	108	86	67	53	41	31
T225	6.93	109	1167	917	742	597	471	382	305	245	195	155	123	97	76	60	46	36
T225B	9.21	143	1167	917	742	597	471	382	305	245	195	155	123	97	76	60	46	36
T300	7.95	173	1612	1268	1027	826	653	529	422	341	271	216	171	136	108	85	66	52
T300D	10.5	223	1612	1268	1027	826	653	529	422	341	271	216	171	136	108	85	66	52
T400	11.1	301	1884	1482	1200	966	763	619	494	399	317	254	201	160	126	100	78	61
T400D	14.4	384	1884	1482	1200	966	763	619	494	399	317	254	201	160	126	100	78	61
T520	17.7	629	2589	2037	1650	1328	1050	852	680	550	437	350	278	221	176	139	109	86

TEL (714) 970-9400
FAX (714) 970-0400

MICROMETALS

IRON POWDER CORES FOR BROADBAND APPLICATIONS

Iron powder cores are very commonly used in RF tuned circuit applications where high Q (quality factor) is a primary objective. The "General Magnetic Properties" table on page 1 indicates the frequency ranges which will produce the highest Q for each core material. The useful frequency range for broadband applications, since they do not require the highest Q, will be much higher.

The frequency range of a core material for broadband use is highly application dependent. The primary parameters that affect the performance of broadband transformers can be broken down into those affecting the low frequency performance limit and those affecting the high frequency performance limit. The design of a broadband transformer is a matter of compromise between the parameters controlling the low and high frequency performance limits.

Broadband transformers produced with iron powder cores will not have the wide bandwidth attainable with high permeability ferrite cores.

Iron powder cores are well-suited for applications requiring a moderate bandwidth, low loss, and good stability. The main factors limiting low frequency performance of a transformer in order of importance are:

1. Primary inductance
2. Core material losses
3. Resistive winding losses

Primary Inductance: The minimum required inductance for acceptable performance at low frequency will produce inductive reactance of about four times the source impedance. Inductance is a function of the turns squared, the effective permeability of the core material at the operating frequency and the ratio of the core's cross-sectional area to magnetic path length.

$$L \text{ (nH)} = \left[\frac{4\pi \mu_{\text{eff}} A N^2}{\ell} \right]$$

The initial permeability of the iron powder materials commonly used for RF applications ranges from 4 to 35. All of these materials maintain the listed initial permeability to frequencies above 500 MHz.

Core Material Losses: The tuned-circuit frequency ranges listed in the table on page 1 indicate the frequency at which each material will produce the lowest core material losses. However, these losses are only of secondary importance. In most low power broadband applications, the loss-

es of any of the iron powder materials will be at an acceptable level.

In high power applications, the core material losses are of greater importance and more consideration needs to be given to this characteristic. In general, the lower permeability materials will provide lower core loss under high power conditions. These lower permeability materials will require more turns to meet the minimum inductance resulting in a lower operating flux density and, thus, less core loss.

Resistive Winding Losses: This characteristic is normally of such little significance that it can be ignored in all but very low frequency applications.

The main factors limiting high frequency performance of a transformer in order of importance are:

1. Self capacitance of the winding
2. Leakage inductance

Self Capacitance of the Winding: Minimizing self capacitance of the winding will improve high frequency performance. Self capacitance of a winding results from both wire-to-core capacitance and turn-to-turn capacitance. The wire size, number of strands, proximity of adjacent wire, number of turns, total length of wire, and operating frequency will all affect self capacitance of a winding. Minimizing turns is the first step to minimizing self capacitance. Small core sizes will also tend to operate more successfully at high frequencies.

Leakage Inductance: Leakage inductance needs to be minimized for successful high frequency performance. This is particularly true when using iron powder cores. The relatively low permeability of iron powder puts a premium on winding technique to help minimize leakage inductance.

If, for example, a transformer was wound on a toroidal core with the primary winding on one side of the toroid and the secondary winding on the other side of the toroid, the coupling between the two windings is reliant on the ability of the core material to contain and transfer the magnetic field. With such a winding configuration, the relatively low permeability of iron powder will cause a significant amount of magnetic field leakage (leakage inductance) resulting in poor coupling between the primary and secondary windings. This will cause a deterioration of the high frequency performance.

Whenever possible multifilar windings should be used. The close proximity of such windings will help to more

(Continued on page 17)

BROADBAND APPLICATIONS

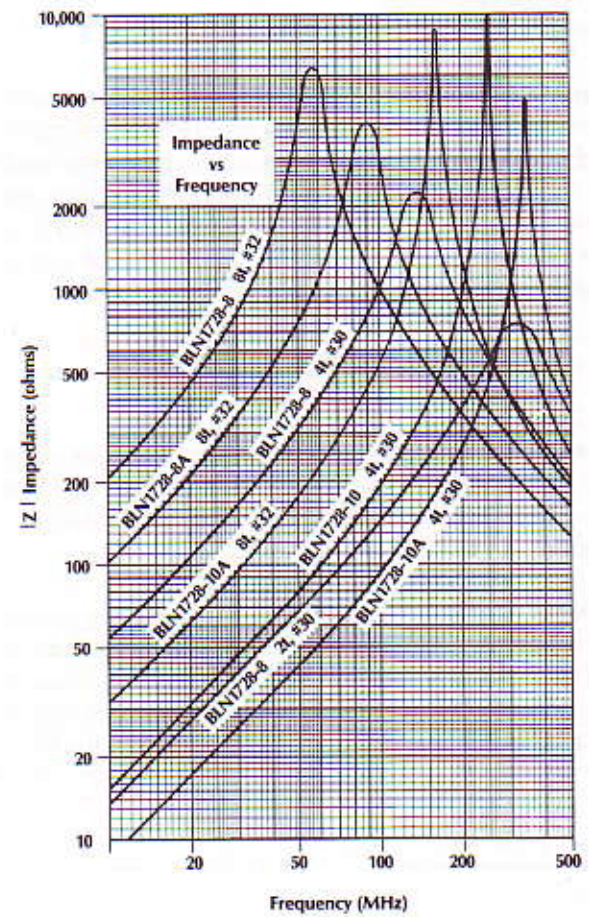
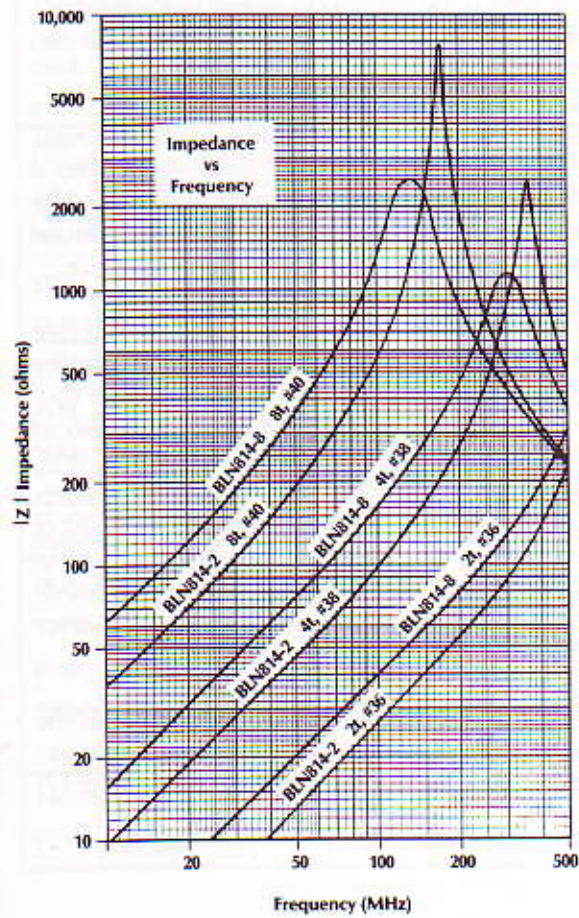
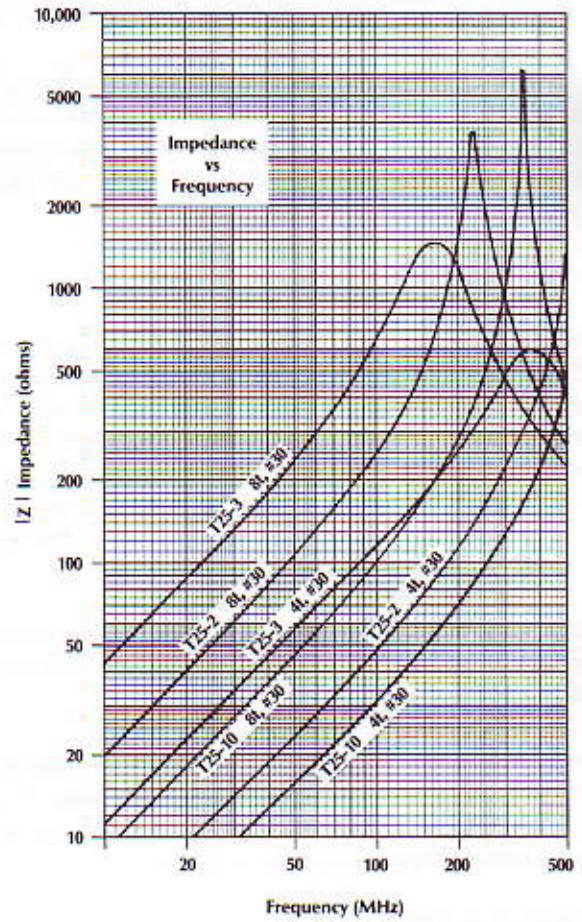
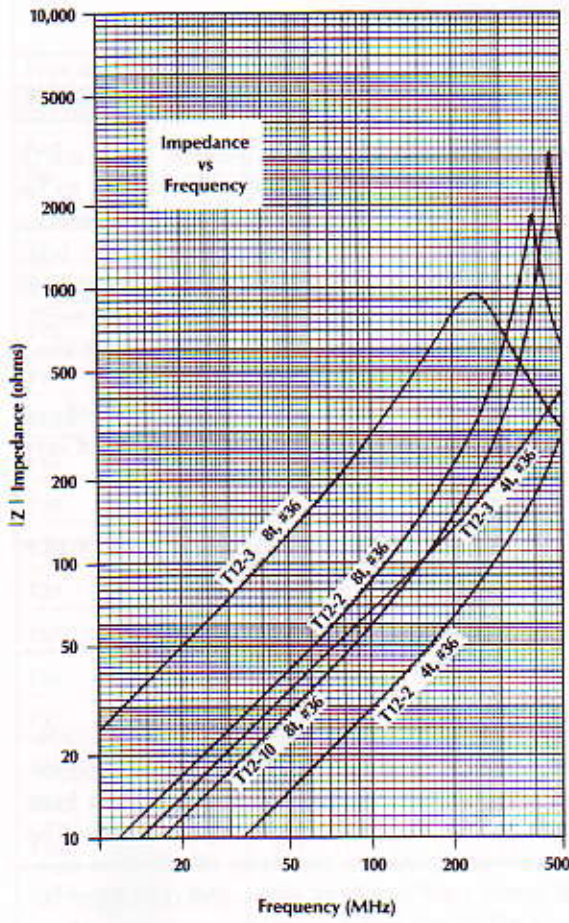

TEL. (714) 970-9400
FAX (714) 970-0400

MICROMETALS

Micrometals balun cores are well suited for vhf and uhf transformer applications.

Balun cores are available in iron powder mixes 0, 2, 6, 8, 10, 15 and 17.

Refer to page 3 for tolerances

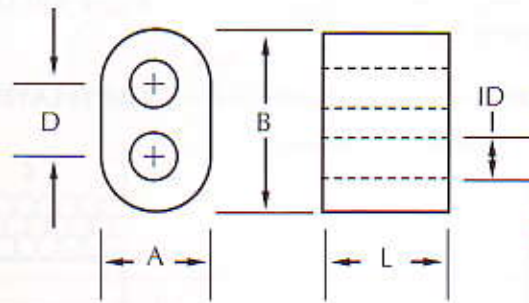

TYPICAL PART NO.

BLN1728-10 A / 94

Micrometals Mix No. **10**
 Letter Indicates Alternate Length **A**
 Indicates Parylene Coating **94**

Note: For information on Mix -14, -18, -26, -30, -34, -35, -38, -40, -45 and -52 see Micrometals Power Conversion catalog.

MICROMETALS Part No.	A _i nH/N ²	A in/mm	B in/mm	ID in/mm	D in/mm	Length in/mm	ℓ cm	A cm ²
BLN814-2/94	8.1	.082/2.08	.140/3.56	.033/0.84	.058/1.47	.093/2.36	.753	.022
BLN814-8/94	14.4							
BLN814-10/94	5.6							
BLN814-0/94	2.5							
BLN814-0A/94	1.9	.082/2.08	.140/3.56	.033/0.84	.058/1.47	.070/1.78	.753	.017
BLN814-8A/94	10.5							
BLN1728-2/94	22.0	.169/4.29	.282/7.16	.077/1.96	.144/3.66	.250/6.35	1.56	.104
BLN1728-6/94	18.0							
BLN1728-8/94	55.0							
BLN1728-10/94	15.8							
BLN1728-2A/94	11.0	.169/4.29	.282/7.16	.077/1.96	.144/3.66	.125/3.17	1.56	.052
BLN1728-6A/94	9.0							
BLN1728-8A/94	27.5							
BLN1728-10A/94	7.9							

BROADBAND APPLICATIONS (Continued)

tightly couple the primary and secondary, thus, minimizing leakage inductance.

The most commonly used core configurations for broadband transformers are toroidal cores and balun cores.

Toroidal Cores: Toroidal cores are often selected for broadband transformer applications due to the relative ease of winding. Toroids which have a relatively large outside diameter to inside diameter ratio (more like a bead) will tend to produce broader band performance.

Balun Cores: The balun configuration has been available in ferrite core materials for many years. This geometry was developed specifically for broadband applications. Since it produces more impedance per unit length of wire than a typical toroidal core when produced in the same core material, this shape will tend to produce transformers which will operate over a broader frequency

range than a comparable toroidal core. This is particularly true when the winding is applied from one hole to the other, rather than around the outside of the core.

Balun cores are somewhat more difficult to wind than a typical toroid but allow for more variety in winding configuration.

The graphs on page 16 contain a number of impedance versus frequency curves for both toroidal cores and balun cores. The balun cores were wound through both holes. All measurements were made on a HP4191A using spring clip fixture 16092A.

This information is intended primarily to assist in core selection for broadband transformer applications. It should be noted, however, that the impedance versus frequency characteristics of iron powder make it useful for EMI suppression applications above 200 MHz.

TEL. (714) 970-9400
 FAX (714) 970-0400

MICROMETALS

CYLINDRICAL CORE APPLICATIONS

The inductance of Micrometals plain cores, threaded cores, hollow cores and insert cores can be closely approximated from the following formulas for cylindrical cores.

Micrometals cups, discs and sleeves when used in conjunction with a core will raise the effective permeability of the system and help control stray magnetic flux.

SINGLE-LAYER COIL

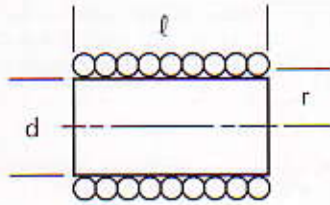

$$L = \frac{\mu_{\text{eff}} (rN)^2}{9r + 10\ell}$$

or

$$N = \frac{1}{r} \left[\frac{L(9r + 10\ell)}{\mu_{\text{eff}}} \right]^{1/2}$$

MULTI-LAYER COIL

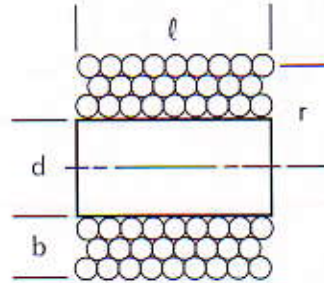

$$L = \frac{0.8 (\mu_{\text{eff}}) (rN)^2}{6r + 9\ell + 10b}$$

or

$$N = \frac{1}{r} \left[\frac{L(6r + 9\ell + 10b)}{(0.8) (\mu_{\text{eff}})} \right]^{1/2}$$

WHERE:

L = Inductance (microhenries)

μ_{eff} = Effective permeability of core (see graph below)

N = Number of turns

r = radius of coil (inches)

d = diameter of core (inches)

ℓ = length of coil/core (inches)

b = coil build (inches)

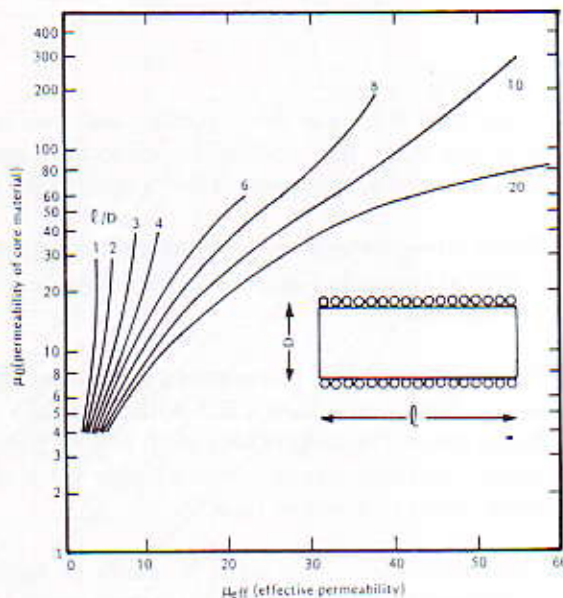

The family of curves to the left shows how the effective permeability (μ_{eff}) of a wound cylindrical core is a function of the core's length to diameter ratio (ℓ/D) as well as the initial material permeability (μ_i).

These curves indicate that in many cases variations in the length/diameter ratio will more significantly affect the effective permeability than increases in the permeability of the core material.

This group of curves was calculated using a cylindrical core with a single layer winding closely wound over 95% of its length. They can be used as a fair approximation of the effective permeability for multi-layer windings.

TEL. (714) 970-9400
FAX (714) 970-0400

MICROMETALS

PLAIN CORES

Micrometals plain cores are available in iron powder mixes 0, 1, 2, 3, 6, 7, 8, 10, 12, 15, 17 and 42.

Core diameters are standard with variations from listed core lengths possible upon request. Electrical values on page 18.

Refer to page 3 for tolerances

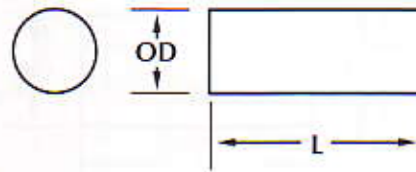

TYPICAL PART NO.

P68-106

Micrometals Mix No. —

Note: For information on Mix -14, -18, -26, -30, -34, -35, -38, -40, -45 and -52 see Micrometals Power Conversion catalog.

MICROMETALS Part No.	OD in/mm	Length in/mm
P22-106	.033/ 0.84	.050/ 1.27
P22-117	.033/ 0.84	.050/ 1.27
P23-100	.033/ 0.84	.075/ 1.90
P23-117	.033/ 0.84	.075/ 1.90
P24-100	.033/ 0.84	.100/ 2.54
P24-106	.033/ 0.84	.100/ 2.54
P24-117	.033/ 0.84	.100/ 2.54
P25-102	.033/ 0.84	.155/ 3.94
P25-106	.033/ 0.84	.155/ 3.94
P25-117	.033/ 0.84	.155/ 3.94
P33-106	.044/ 1.12	.100/ 2.54
P33-110	.044/ 1.12	.100/ 2.54
P35-106	.044/ 1.12	.155/ 3.94
P48-102	.064/ 1.63	.250/ 6.35
P48-110	.064/ 1.63	.250/ 6.35
P68-106	.098/ 2.49	.250/ 6.35
P710-101	.107/ 2.72	.312/ 7.92
P810-210	.125/ 3.17	.312/ 7.92
P825-142	.136/ 3.45	.775/ 19.7
P912-102	.147/ 3.73	.375/ 9.53
P1012-102	.157/ 3.99	.375/ 9.53
P1224-102	.190/ 4.83	.750/ 19.1
P1624-102	.250/ 6.35	.750/ 19.1
P1632-102	.250/ 6.35	1.000/ 25.4
P1640-206	.255/ 6.48	1.250/ 31.8
P1648-202	.255/ 6.48	1.500/ 38.1
P2028-102	.309/ 7.85	.875/ 22.2
P2440-106	.370/ 9.40	1.250/ 31.8
P2440-201	.375/ 9.53	1.250/ 31.8
P2440-202	.375/ 9.53	1.250/ 31.8
P2448-202	.375/ 9.53	1.500/ 38.1
P3240-102	.500/ 12.7	1.250/ 31.8
P3240-108	.500/ 12.7	1.250/ 31.8
P4040-102	.625/ 15.9	1.250/ 31.8
P4840-102	.750/ 19.1	1.250/ 31.8
P4848-102	.750/ 19.1	1.500/ 38.1
P6448-102	1.000/ 25.4	1.500/ 38.1

TEL. (714) 970-9400
FAX (714) 970-0400

MICROMETALS

HOLLOW CORES

Micrometals hollow cores are available in iron powder mixes 0, 1, 2, 3, 6, 7, 8, 10, 12, 15, 17 and 42.

Core outside and inside diameters listed are standard with variations in length possible upon request.

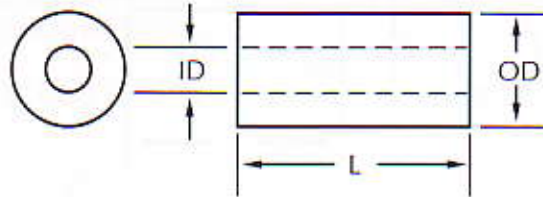

TYPICAL PART NO.

H918-1002

Micrometals Mix No.

Note: For information on Mix -14, -18, -26, -30, -34, -35, -38, -40, -45 and -52 see Micrometals Power Conversion catalog.

Refer to page 3 for tolerances

MICROMETALS Part No.	OD in/mm	ID in/mm	Length in/mm
H22-1002	.144/ 3.66	.064/ 1.63	.125/ 3.17
H22-1006	.144/ 3.66	.064/ 1.63	.125/ 3.17
H46-1002	.263/ 6.68	.075/ 1.90	.394/ 10.0
H46-1006	.263/ 6.68	.075/ 1.90	.394/ 10.0
H520-1002	.312/ 7.92	.137/ 3.48	1.250/ 31.8
H68-1002	.375/ 9.53	.125/ 3.17	.500/ 12.7
H68-1003	.375/ 9.53	.125/ 3.17	.500/ 12.7
H68-1006	.375/ 9.53	.125/ 3.17	.500/ 12.7
H68-1010	.375/ 9.53	.125/ 3.17	.500/ 12.7
H68-1242	.375/ 9.53	.205/ 5.21	.500/ 12.7
H610-1003	.375/ 9.53	.125/ 3.17	.625/ 15.9
H610-1102	.364/ 9.25	.125/ 3.17	.625/ 15.9
H610-1103	.364/ 9.25	.125/ 3.17	.625/ 15.9
H610-1107	.364/ 9.25	.125/ 3.17	.625/ 15.9
H616-1002	.375/ 9.53	.125/ 3.17	1.000/ 25.4
H616-1202	.368/ 9.35	.201/ 5.11	1.000/ 25.4
H616-1301	.375/ 9.53	.137/ 3.48	1.000/ 25.4
H616-1302	.375/ 9.53	.137/ 3.48	1.000/ 25.4
H618-1042	.375/ 9.53	.125/ 3.17	1.125/ 28.6
H620-1002	.375/ 9.53	.137/ 3.48	1.250/ 31.8
H810-1007	.500/ 12.7	.200/ 5.08	.625/ 15.9
H818-1003	.500/ 12.7	.200/ 5.08	1.125/ 28.6
H918-1002	.570/ 14.5	.250/ 6.35	1.125/ 28.6
H918-1006	.570/ 14.5	.250/ 6.35	1.125/ 28.6
H918-1008	.570/ 14.5	.250/ 6.35	1.125/ 28.6
H918-1010	.570/ 14.5	.245/ 6.22	1.125/ 28.6
H1020-1002	.625/ 15.9	.219/ 5.56	1.250/ 31.8
H1224-1002	.750/ 19.1	.260/ 6.60	1.500/ 38.1
H1614-1002	1.000/ 25.4	.250/ 6.35	.875/ 22.2
H1616-1102	.950/ 24.1	.189/ 4.80	1.000/ 25.4

TEL. (714) 970-9400
FAX (714) 970-0400

MICROMETALS

Micrometals sleeves are available in iron powder mixes 0, 1, 2, 3, 6, 7, 8, 10, 12, 15, 17 and 42.

Sleeve outside and inside diameters listed are standard with variations in length possible upon request.

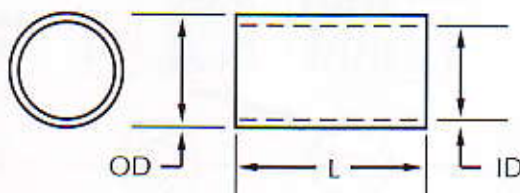

TYPICAL PART NO.

S16-1408

Micrometals Mix No.

Refer to page 3 for tolerances

MICROMETALS Part No.	OD in/mm	ID in/mm	Length in/mm
S2-1002	.064/ 1.63	.026/ 0.66	.140/ 3.56
S2-1006	.064/ 1.63	.026/ 0.66	.140/ 3.56
S2-1108	.080/ 2.03	.034/ 0.86	.150/ 3.81
S2-1202	.066/ 1.68	.026/ 0.66	.187/ 4.75
S2-1206	.066/ 1.68	.026/ 0.66	.187/ 4.75
S2-1902	.066/ 1.68	.026/ 0.66	.220/ 5.59
S3-1006	.093/ 2.36	.029/ 0.74	.063/ 1.60
S3-1206	.105/ 2.67	.040/ 1.02	.145/ 3.68
S3-1308	.102/ 2.59	.034/ 0.86	.155/ 3.94
S3-1502	.109/ 2.77	.045/ 1.14	.145/ 3.68
S3-2002	.100/ 2.54	.071/ 1.80	.215/ 5.46
S4-1006	.125/ 3.17	.071/ 1.80	.215/ 5.46
S4-1402	.114/ 2.90	.045/ 1.14	.145/ 3.68
S5-1201	.138/ 3.51	.104/ 2.64	.302/ 7.67
S5-1202	.138/ 3.51	.104/ 2.64	.302/ 7.67
S5-1206	.138/ 3.51	.104/ 2.64	.302/ 7.67
S5-1502	.146/ 3.71	.096/ 2.44	.340/ 8.64
S5-1802	.140/ 3.56	.114/ 2.90	.360/ 9.14
S5-1808	.140/ 3.56	.114/ 2.90	.360/ 9.14
S7-1002	.223/ 5.66	.172/ 4.37	.188/ 4.78
S7-1006	.223/ 5.66	.172/ 4.37	.188/ 4.78
S10-1002	.309/ 7.85	.218/ 5.54	.630/ 16.0
S12-1006	.383/ 9.73	.316/ 8.03	.625/ 15.9
S16-1408	.497/ 12.6	.400/ 10.2	.700/ 17.8
S16-1508	.497/ 12.6	.400/ 10.2	.900/ 22.9
S16-1708	.497/ 12.6	.400/ 10.2	1.000/ 25.4
S20-1102	.630/ 16.0	.500/ 12.7	.875/ 22.2
S22-1208	.700/ 17.8	.495/ 12.6	1.250/ 31.8
S24-1102	.750/ 19.1	.566/ 14.4	.750/ 19.1
S26-2003	.828/ 21.0	.695/ 17.7	.625/ 15.9
S30-1803	.935/ 23.8	.704/ 17.9	1.250/ 31.8

TEL. (714) 970-9400
FAX (714) 970-0400

MICROMETALS

THREADED CORES

Micrometals threaded cores are available in iron powder mixes 0, 1, 2, 3, 6,7,8,10,12,15,17 and 42. All threaded cores are normally supplied with shallow threads. Full threads are available and are designated by adding "F" to the end of the part number. Threads conform to MPIF standards.

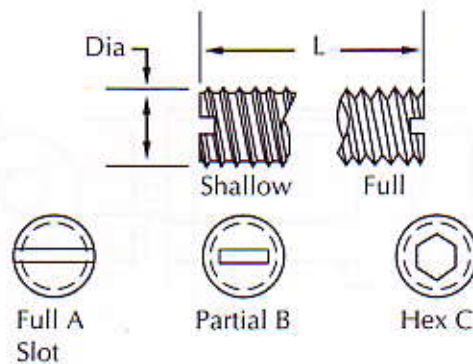

TYPICAL PART NO.

TH34-02 02 F

Micrometals Mix No. 02
F Designates Full Thread

Refer to page 3 for tolerances

MICROMETALS Part No.	OD in/mm	Length in/mm	Thread	Drive
TH03-0106	.111/ 2.82	.187/ 4.75	4-40	A
TH03-0306	.111/ 2.82	.187/ 4.75	4-40	B
TH13-0206	.130/ 3.30	.187/ 4.75	6-32	A
TH14-0101	.130/ 3.30	.250/ 6.35	6-32	A
TH15-0102	.130/ 3.30	.312/ 7.92	6-32	A
TH15-0106	.130/ 3.30	.312/ 7.92	6-32	A
TH16-0102	.130/ 3.30	.375/ 9.53	6-32	A
TH23-0406	.159/ 4.04	.187/ 4.75	8-32	B
TH24-0206	.159/ 4.04	.250/ 6.35	8-32	B
TH24-0210	.159/ 4.04	.250/ 6.35	8-32	B
TH25-0204	.159/ 4.04	.312/ 7.92	8-32	B
TH26-0106	.155/ 3.94	.400/ 10.2	8-32	B
TH26-1306	.159/ 4.04	.375/ 9.53	8-32	A
TH27-0102	.155/ 3.94	.437/ 11.1	8-32	B
TH27-0106	.155/ 3.94	.437/ 11.1	8-32	B
TH28-0206	.155/ 3.94	.500/ 12.7	8-32	B
TH33-0217	.180/ 4.57	.197/ 5.00	10-32	C
TH34-0104	.180/ 4.57	.250/ 6.35	10-32	B
TH34-0202	.180/ 4.57	.250/ 6.35	10-32	C
TH34-0217	.180/ 4.57	.250/ 6.35	10-32	C
TH35-0206	.180/ 4.57	.312/ 7.92	10-32	C
TH35-0207	.180/ 4.57	.312/ 7.92	10-32	C
TH35-0302	.180/ 4.57	.312/ 7.92	10-32	B
TH35-0304	.180/ 4.57	.312/ 7.92	10-32	B
TH35-0307	.180/ 4.57	.312/ 7.92	10-32	B
TH35-0310	.180/ 4.57	.312/ 7.92	10-32	B
TH36-0104	.180/ 4.57	.375/ 9.53	10-32	B
TH36-0106	.180/ 4.57	.375/ 9.53	10-32	B
TH36-0202	.180/ 4.57	.375/ 9.53	10-32	C
TH36-0206	.180/ 4.57	.375/ 9.53	10-32	C
TH36-0210	.180/ 4.57	.375/ 9.53	10-32	C
TH46-0202	.249/ 6.32	.375/ 9.53	1/4-28	C
TH46-0206	.249/ 6.32	.375/ 9.53	1/4-28	C
TH46-0212	.249/ 6.32	.375/ 9.53	1/4-28	C
TH48-0102	.248/ 6.30	.500/ 12.7	1/4-28	C
TH48-0106	.248/ 6.30	.500/ 12.7	1/4-28	C
TH412-0142	.247/ 6.27	.750/ 19.1	1/4-28	C

TEL. (714) 970-9400
FAX (714) 970-0400

MICROMETALS

CUPS

Micrometals cups are available in iron powder mixes 1,2,3,6,7,8,10,17, and 42.

Variations in Ht and Depth are available upon request.

Refer to page 3 for tolerances

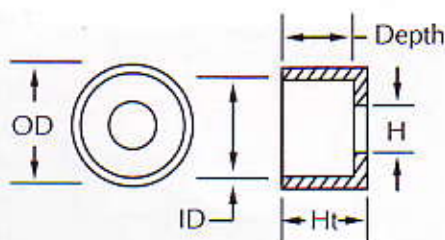

TYPICAL PART NO.

C12-10 02

Micrometals Mix No. —

MICROMETALS Part No.	OD in/mm	ID in/mm	H in/mm	Ht in/mm	Depth in/mm	Notch
C8-1006	.250/ 6.35	.163/ 4.14	— / —	.275/ 6.99	.182/ 4.62	—
C8-1106	.246/ 6.25	.163/ 4.14	.087/ 2.21	.250/ 6.35	.187/ 4.75	—
C9-1206	.290/ 7.37	.229/ 5.82	.166/ 4.22	.312/ 7.92	.250/ 6.35	—
C9-2702	.270/ 6.86	.215/ 5.46	.163/ 4.14	.235/ 5.97	.210/ 5.33	—
C9-2703	.270/ 6.86	.215/ 5.46	.163/ 4.14	.235/ 5.97	.210/ 5.33	—
C11-1006	.364/ 9.25	.291/ 7.39	.187/ 4.75	.500/ 12.7	.470/ 11.9	—
C12-1002	.375/ 9.53	.280/ 7.11	.185/ 4.70	.250/ 6.35	.187/ 4.75	—
C12-1003	.375/ 9.53	.280/ 7.11	.185/ 4.70	.250/ 6.35	.187/ 4.75	—
C12-2502	.373/ 9.47	.280/ 7.11	.152/ 3.86	.312/ 7.92	.250/ 6.35	—
C12-2510	.373/ 9.47	.280/ 7.11	.152/ 3.86	.312/ 7.92	.250/ 6.35	—
C12-3001	.375/ 9.53	.285/ 7.24	.220/ 5.59	.365/ 9.27	.335/ 8.51	4
C12-3006	.375/ 9.53	.285/ 7.24	.220/ 5.59	.365/ 9.27	.335/ 8.51	4
C16-1002	.505/ 12.8	.405/ 10.3	.234/ 5.94	.195/ 4.95	.105/ 2.67	2
C16-1003	.505/ 12.8	.405/ 10.3	.234/ 5.94	.195/ 4.95	.105/ 2.67	2
C16-1102	.505/ 12.8	.405/ 10.3	.234/ 5.94	.312/ 7.92	.250/ 6.35	2
C16-1608	.497/ 12.6	.400/ 10.2	.158/ 4.01	.600/ 15.3	.560/ 14.2	—
C16-1708	.497/ 12.6	.400/ 10.2	.158/ 4.01	.900/ 22.9	.875/ 22.2	—
C19-1202	.598/ 15.2	.465/ 11.8	.248/ 6.30	.312/ 7.92	.250/ 6.35	4
C19-2502	.598/ 15.2	.465/ 11.8	.285/ 7.24	.375/ 9.53	.312/ 7.93	2
C23-1002	.724/ 18.4	.589/ 15.0	.288/ 7.32	.500/ 12.7	.420/ 10.7	—

DISCS

Micrometals discs are available in iron powder mixes 1,2,3,6,7,8,10,17, and 42.

Variations in T are available upon request.

Refer to page 3 for tolerances

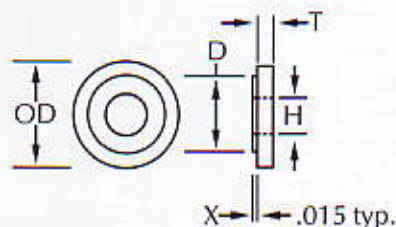

TYPICAL PART NO.

D23-11 02

Micrometals Mix No. —

MICROMETALS Part No.	OD in/mm	D in/mm	H in/mm	T in/mm	Notch
D9-1201	.286/ 7.26	—	.106/ 2.69	.095/ 2.41	—
D9-1202	.286/ 7.26	—	.106/ 2.69	.095/ 2.41	—
D12-1002	.375/ 9.53	.280/ 7.11	.183/ 4.65	.047/ 1.19	—
D12-1003	.375/ 9.53	.280/ 7.11	.183/ 4.65	.047/ 1.19	—
D15-1202	.472/ 12.0	.359/ 9.12	.210/ 5.33	.062/ 1.57	—
D15-1402	.472/ 12.0	.359/ 9.12	.201/ 5.11	.062/ 1.57	—
D19-1202	.598/ 15.2	.465/ 11.8	.265/ 6.73	.062/ 1.57	—
D23-1102	.723/ 18.4	.593/ 15.1	.291/ 7.39	.050/ 1.27	2
D30-1303	.942/ 23.9	.705/ 17.9	.313/ 7.95	.125/ 3.18	—

TEL. (714) 970-9400
FAX (714) 970-0400

MICROMETALS

TOROIDS (RECTANGULAR)

Micrometals square toroids are designed as a substitute to the standard toroids when it is necessary to prevent wound turns from shifting position. Available in iron powder mixes 0, 2, 6, 8, 10, 15, and 17.

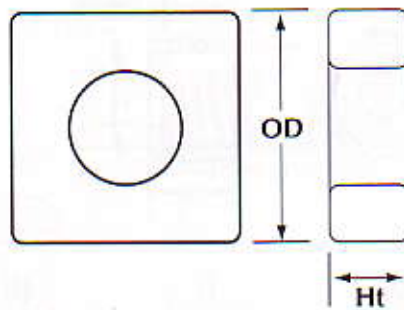

TYPICAL PART NO.

TR11-6A/94

OD in 100th inches
 Micrometals Mix. No.
 Indicates alternate height
 "/94" indicates Parylene Coating with no color code

Refer to page 3 for tolerances.

MICROMETALS Part No.	A_L^* nH/N ²	OD in/mm	ID in/mm	Ht in/mm	ℓ cm	A cm ²	V cm ³
TR11 - 0/94	0.45	.100/ 2.54	.055/ 1.40	.070/ 1.78	.730	.0120	.0087
TR11 - 2/94	2.40	.100/ 2.54	.055/ 1.40	.070/ 1.78			
TR11 - 6/94	2.10	.100/ 2.54	.055/ 1.40	.070/ 1.78			
TR11 - 8/94	6.10	.100/ 2.54	.055/ 1.40	.070/ 1.78			
TR11 - 10/94	1.80	.100/ 2.54	.055/ 1.40	.070/ 1.78			
TR11 - 17/94	1.30	.100/ 2.54	.055/ 1.40	.070/ 1.78			
TR11 - 0A/94	0.35	.100/ 2.54	.055/ 1.40	.050/ 1.27	.730	.0086	.0062
TR11 - 2A/94	1.80	.100/ 2.54	.055/ 1.40	.050/ 1.27			
TR11 - 6A/94	1.60	.100/ 2.54	.055/ 1.40	.050/ 1.27			
TR11 - 8A/94	5.10	.100/ 2.54	.055/ 1.40	.050/ 1.27			
TR11 - 10A/94	1.40	.100/ 2.54	.055/ 1.40	.050/ 1.27			
TR11 - 17A/94	1.00	.100/ 2.54	.055/ 1.40	.050/ 1.27			

*Preliminary

SQUARED BOBBINS

Micrometals Squared Bobbins are ideally suited for both delay line and surface mount applications. Available in iron powder mixes 0, 2, 6, 8, 10, 15 and 17.

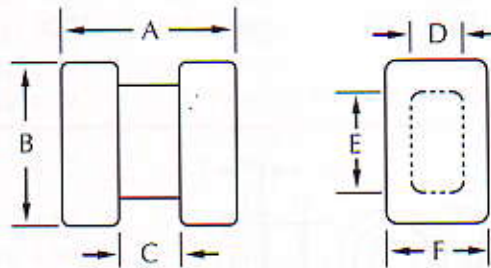

TYPICAL PART NO.

SBB1010-18 02

Micrometals Mix No.

Refer to page 3 for tolerances.

MICROMETALS Part No.	A_L nH/N ²	A in/mm	B in/mm	C in/mm	D in/mm	E in/mm	F in/mm
SBB0505-1002	2.16	.078/ 1.98	.047/ 1.19	.037/ 0.94	.025/ 0.64	.025/ 0.64	.047/ 1.19
SBB0505-1008	3.38						
SBB0710-1802	6.84	.070/ 1.78	.105/ 2.67	.020/ 0.51	.040/ 1.02	.080/ 2.03	.063/ 1.60
SBB0710-1806	6.04						
SBB0710-1810	5.24						
SBB0810-1802	5.44	.081/ 2.06	.105/ 2.67	.040/ 1.02	.034/ 0.86	.075/ 1.90	.065/ 1.65
SBB0810-1806	4.72						
SBB0810-1810	4.00						
SBB1010-1802	5.12	.102/ 2.59	.105/ 2.67	.047/ 1.19	.034/ 0.86	.074/ 1.88	.063/ 1.60
SBB1010-1806	4.40						
SBB1010-1810	3.68						
SBB3333-1002	9.85	.327/ 8.31	.327/ 8.31	.223/ 5.66	.077/ 1.96	.192/ 4.88	.170/ 4.32
SBB3333-1008	15.40						

TEL. (714) 970-9400
 FAX (714) 970-0400

MICROMETALS

Q CURVES

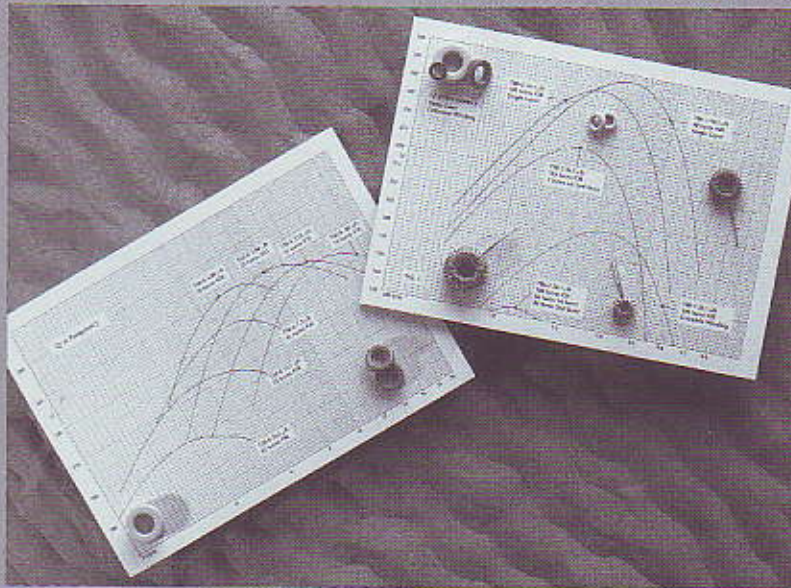

A design and application supplement to Micrometals for RF catalog.
Contains over 30 pages of Q vs. Frequency Curves and other useful information.

POWER CONVERSION AND LINE FILTER APPLICATIONS

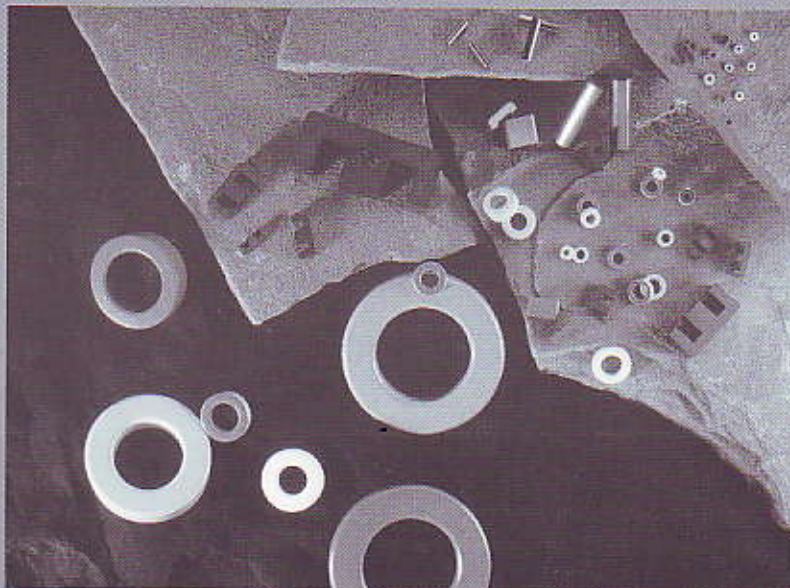

Contains Iron Powder Toroids, E-Cores, Bus Bar Cores, Plain Cores, Hollow Cores and Discs in Mixes 2, 8, 14, 18, 26, 30, 34, 35, 38, 40, 45 and 52 for Power Conversion and Line Filter Applications.

TEL. (714) 970-9400
FAX (714) 970-0400

MICROMETALS

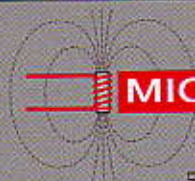

MICROMETALS
IRON POWDER CORES

5615 E. LA PALMA AVE.
ANAHEIM, CA 92807 USA

TOLL FREE IN USA (800) 356-5977 • WORLDWIDE (714) 970-9400
FAX (714) 970-0400 • WEB SITE www.micrometals.com
FSC 12856