



PRODUCT BROCHURE

IMU/AHRS

GNSS/INS

DUAL GNSS/INS

NavtechGPS

+1-703-256-8900 or 800-628-0885

info@NavtechGPS.com

www.NavtechGPS.com

SMALLER. SMARTER. PROVEN.

NAVIGATION **WITHOUT** **COMPROMISE.**

Whether you are engineering cutting edge technology or delivering mission critical systems, knowing you can rely on your navigation solution means everything. At VectorNav, we deliver inertial navigation solutions that you can depend on to complete your objective and give you the competitive edge.

Since our founding, we have been guided by one mission: **the Relentless Pursuit of Inertial Navigation Excellence**. It has led us to produce solutions that provide unrivaled performance to size, and capability that delivers under the most challenging conditions. Partner with VectorNav and leverage that value to succeed in your market.

**VectorNav products are engineered for the difficult and the edge cases.
Designed to perform where you need it most.**

**All VectorNav products are Made in the USA, ITAR-free and have short
lead times.**



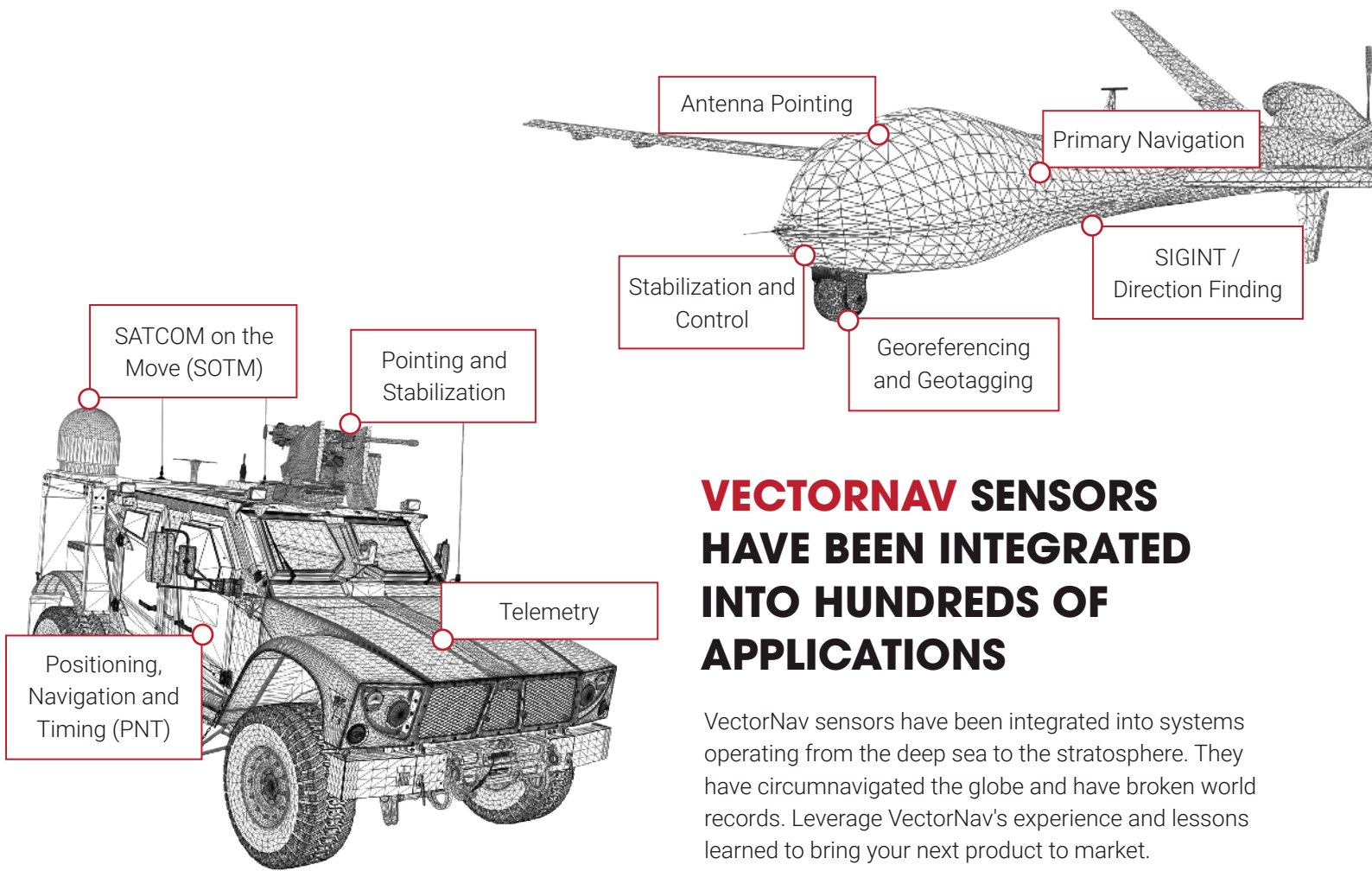

VECTORNAV SENSORS HAVE BEEN INTEGRATED INTO HUNDREDS OF APPLICATIONS

VectorNav sensors have been integrated into systems operating from the deep sea to the stratosphere. They have circumnavigated the globe and have broken world records. Leverage VectorNav's experience and lessons learned to bring your next product to market.

FIELD PROVEN

Since 2008, tens of thousands of VectorNav sensors have been put to the test in real world, mission critical applications and come out on top time and again.

UNMATCHED PERFORMANCE

VectorNav continually develops and improves its proprietary algorithms to produce more accurate and reliable navigation data for any application, no matter what the challenge.

STEADFAST SUPPORT

All VectorNav products are backed by the industry's most customer-focused, robust and responsive support ecosystem. Count on VectorNav's support through your entire development cycle and product lifetime to ensure your success.

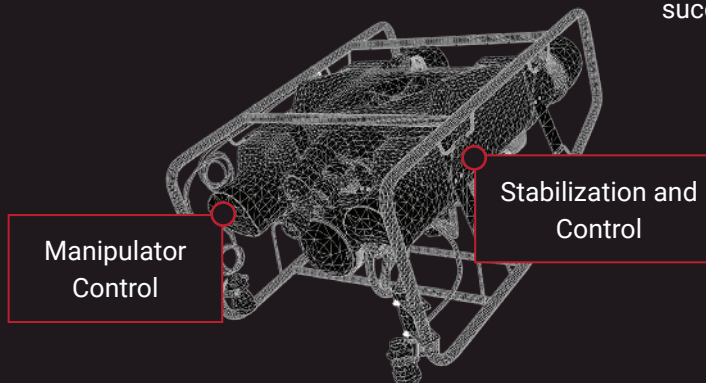

VECTORNAV PRODUCT LINE OVERVIEW

Each individual VectorNav sensor undergoes a robust calibration and acceptance testing process at VectorNav's AS9100 certified manufacturing facility.

Performance specifications are based on comprehensive field testing and results from real-world applications. VectorNav regularly conducts comprehensive testing on all products to verify continued conformance to all performance specifications.

INERTIAL MEASUREMENT UNIT / ATTITUDE HEADING REFERENCE SYSTEM

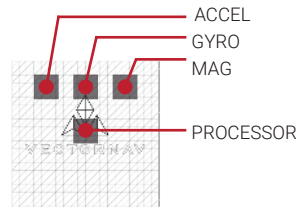

- IMU Measurements
Accel/Gyro/Mag
- Attitude Filter
Yaw/Pitch/Roll
- Magnetic Heading
Hard/Soft Iron Calibration



VN-100



VN-110

Accel Range	±16 g	±15 g
Accel In-Run Bias (Allan Variance)	< 0.04 mg	< 10 µg
Accel Noise Density (VRW)	0.14 mg/√Hz	< 0.04 mg/√Hz
Gyro Range	±2,000°/s	±490°/s
Gyro In-Run Bias (Allan Variance)	5-7°/hr typ.	0.4-0.7°/hr typ.
Gyro Noise Density (ARW)	0.0035 °/s /√Hz	5 °/hr /√Hz
Heading (Magnetic)	2.0° RMS	2.0° RMS
Heading (Dynamic, INS)	-	-
Heading (GNSS Compass)	-	-
Pitch/Roll (Static, AHRS)	0.5° RMS	0.05° RMS
Pitch/Roll (Dynamic, INS)	-	-
Horizontal Position	-	-
Vertical Position	-	-
RTK Positioning	-	-
Heave	5 % or 5 cm	-

PACKAGING OPTIONS

Industrial Series

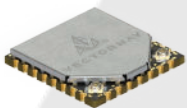

- ▶ Surface Mount Device
- ▶ < 5 g
- ▶ 3.2 V to 5.5 V Input Voltage
- ▶ Designed for deep integration

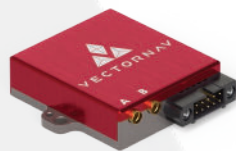

- ▶ Precision Aluminum Enclosure
- ▶ < 30 g
- ▶ 3.2 V to 17 V Input Voltage
- ▶ Designed for ease of use and quick integration and evaluation

Tactical Series



- ▶ Board Mountable Device
- ▶ < 15 g
- ▶ 3.2 V to 3.5 V Input Voltage
- ▶ Designed for deep integration



- ▶ MIL-STD, DO-160G Certified
- ▶ < 160 g
- ▶ 12 V to 34 V Input Voltage
- ▶ Designed to meet the most demanding environmental and operating requirements

GNSS-AIDED INERTIAL NAVIGATION SYSTEM

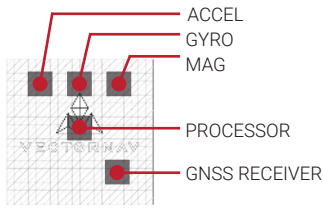

INS Filter Position, Velocity
and Attitude

IMU Measurements
Accel/Gyro/Mag

Attitude Filter
Yaw/Pitch/Roll



VN-200



VN-210

DUAL GNSS-AIDED INERTIAL NAVIGATION SYSTEM

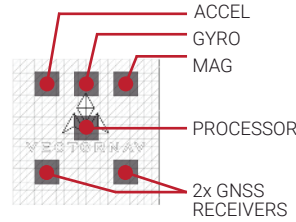

GNSS Compass Static Heading

INS Filter Position, Velocity
and Attitude

IMU Measurements
Accel/Gyro/Mag

Attitude Filter
Yaw/Pitch/Roll



VN-300



VN-310

±16 g	±15 g	±16 g	±15 g
< 0.04 mg	< 10 µg	< 0.04 mg	< 10 µg
0.14 mg/√Hz	< 0.04 mg/√Hz	0.14 mg/√Hz	< 0.04 mg/√Hz
±2,000°/s	±490°/s	±2,000°/s	±490°/s
5-7°/hr typ.	0.4-0.7°/hr typ.	5-7°/hr typ.	0.4-0.7°/hr typ.
0.0035 °/s /√Hz	5 °/hr /√Hz	0.0035 °/s /√Hz	5 °/hr /√Hz
2.0° RMS	2.0° RMS	2.0° RMS	2.0° RMS
0.2°, 1σ	0.05°-0.1°, 1σ	0.2°, 1σ	0.05°-0.1°, 1σ
-	-	0.15° RMS	0.15° RMS
0.5° RMS	0.05° RMS	0.5° RMS	0.05° RMS
0.03°, 1σ	0.015°, 1σ	0.03°, 1σ	0.015°, 1σ
1.0 m RMS	1.0 m RMS	1.0 m RMS	1.0 m RMS
1.5 m RMS	1.5 m RMS	1.5 m RMS	1.5 m RMS
-	1 cm + 1 ppm CEP	-	1 cm + 1 ppm CEP
5% or 5 cm	-	-	-

FREE INERTIAL COMPARISON

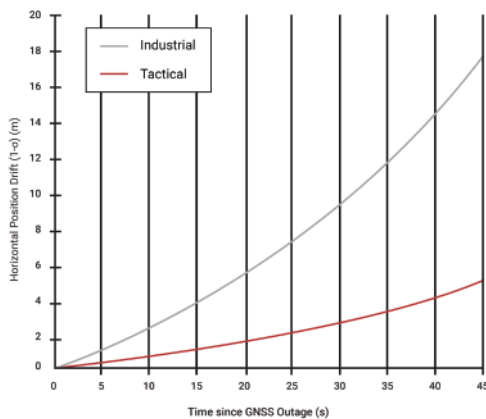

► Horizontal Position Drift after loss of GNSS (post INS alignment)

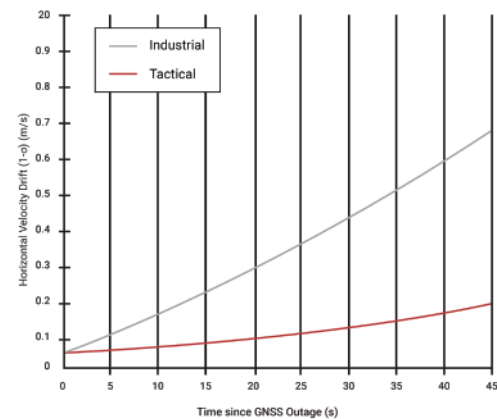

► Horizontal Velocity Drift after loss of GNSS (post INS alignment)

VN-100 IMU/AHRS

Inertial Measurement Unit /
Attitude Heading Reference System

INTRODUCTION

The VN-100 is a miniature, light weight, low power, high-performance Inertial Measurement Unit (IMU) and Attitude and Heading Reference System (AHRS) available in a surface mount package or aluminum encased Rugged module.

The VN-100 computes and outputs a real-time, drift-free attitude solution (i.e. 3D orientation) that is continuous over a complete range of 360° motion.



VN-100 SMD

VN-100 Rugged

PRODUCT HIGHLIGHTS

2.0° Magnetic Heading Accuracy	5-7°/hr (typ.) Gyro In-Run Bias Stability	400 Hz Onboard Extended Kalman Filter Update Rate	Rugged 36 x 33 x 9 mm; 15 grams; 220 mW
0.5° Pitch/Roll Accuracy	< 0.04 mg Accel In-Run Bias Stability	800 Hz IMU Data	Surface Mount (SMD) 24 x 22 x 3 mm; 3.5 grams; 185 mW

INDUSTRY LEADING ALGORITHMS - VPE

The VN-100 features a robust Kalman Filter (EKF) along with a proprietary suite of high performance algorithms that run completely onboard the sensors. VectorNav's industry leading Vector Processing Engine (VPE) algorithms provide real-time magnetic and acceleration disturbance rejection, adaptive signal filtering, dynamic filter tuning and onboard Hard & Soft Iron compensation.

DEVELOPMENT KIT OPTIONS



VN-100 Rugged



VN-100 Surface Mount

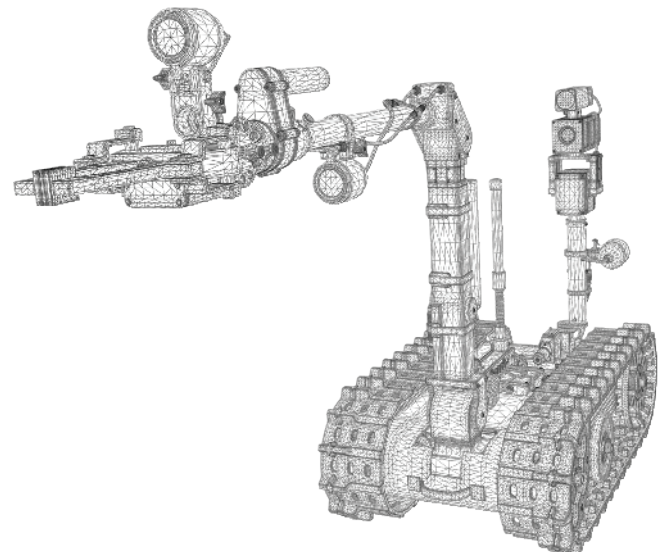

Kit Contents

Complete hardware Development Kits include VectorNav sensor, applicable cabling, documentation, hardware tools and rugged carrying case.

Sensor Summary

- ▶ VectorNav proprietary AHRS delivers a continuous attitude solution over the complete 360° range of operation
- ▶ VectorNav Processing Engine (VPE) for disturbance rejection, adaptive filtering, dynamic filter tuning
- ▶ Real-time gyro bias tracking and compensation
- ▶ Hard/Soft Iron Compensation (Real-time and Manual 2D & 3D)
- ▶ Individually calibrated for bias, scale factor, misalignment, and temperature over full operating range (-40°C to +85°C)
- ▶ Available with standard (@ 25° C) or full temperature compensation (-40° C to +85° C)
- ▶ Real-time and delayed heave estimation
- ▶ Coning and sculling integrals (ΔV 's, $\Delta \theta$'s)
- ▶ Data output format: ASCII (VectorNav), Binary (VectorNav)
- ▶ World Magnetic & Gravity Reference Models
- ▶ VectorNav Control Center GUI (available for free download at www.vectornav.com) provides a practical tool for easy sensor setup, configuration and data viewing/logging
- ▶ ITAR-Free

Performance Specifications

ATTITUDE / HEAVE

Range (Heading/Yaw, Roll).....	± 180°
Range (Pitch).....	± 90°
Heading (Magnetic) ¹	2.0° RMS
Pitch/Roll (Static).....	0.5° RMS
Pitch/Roll (Dynamic) ²	1.0° RMS
Heave Accuracy.....	5 % or 5 cm
Delayed Heave Accuracy.....	2 % or 2 cm
Angular Resolution.....	0.001°

IMU Specifications

	ACCELEROMETER	GYROSCOPE	MAGNETOMETER	BAROMETER
Range	±16 g	±2,000°/s	±2.5 Gauss	10 to 1200 mbar
In-Run Bias Stability (Allan Variance)	< 0.04 mg	< 10°/hr (5-7°/hr typ.)	-	-
Noise Density	0.14 mg/√Hz	0.0035 °/s /√Hz	140 μGauss/√Hz	-
Bandwidth	260 Hz	256 Hz	200 Hz	200 Hz
Cross-Axis Sensitivity	±0.05 °	< 0.05 °	±0.05 °	-

Mechanical

	SIZE	WEIGHT	INTERFACE
Rugged	36 x 33 x 9 mm	15 g	10-pin Harwin
SMD	24 x 22 x 3 mm	3.5 g	30-pin LGA

Electrical

	INPUT VOLTAGE	CURRENT DRAW	POWER
Rugged	4.5 to 5.5 V	40 mA @ 5 V	220 mW
SMD	3.2 to 5.5 V	45 mA @ 3.3 V	185 mW

1. With proper magnetic declination, suitable magnetic environment and valid hard/soft iron calibration.
2. Typical; Velocity Aiding required for applications with sustained linear accelerations.
3. Contact VectorNav for higher IMU data output rates.

Environmental

Operating Temperature.....	-40° to +85° C
Storage Temperature.....	-40° to +85° C
MTBF (Rugged).....	> 240,000 hours
MTBF (SMD).....	> 280,000 hours

Interfacing

Output Data Rate (IMU) ³	up to 800 Hz
Output Data Rate (Attitude).....	up to 400 Hz
Interface (VN-100 Rugged).....	RS-232, Serial TTL
Interface (VN-100 SMD).....	Serial TTL, SPI
Input.....	Sync-in
Output.....	Sync-out

VN-200 GNSS/INS

GNSS-Aided Inertial Navigation System

INTRODUCTION

The VN-200 is a miniature, high performance GNSS-Aided Inertial Navigation System (GNSS/INS) that combines 3-axis gyros, accelerometers and magnetometers, a high-sensitivity GNSS receiver, and advanced Kalman filtering algorithms to provide optimal estimates of position, velocity, and attitude.



VN-200 SMD

VN-200 Rugged

PRODUCT HIGHLIGHTS

0.2° Dynamic Heading Accuracy (INS)	5-7°/hr (typ.) Gyro In-Run Bias Stability	400 Hz Position, Velocity and Attitude Data	800 Hz IMU Data
0.03° Dynamic Pitch/Roll Accuracy (INS)	< 0.04 mg Accel In-Run Bias Stability	1.0 m / 1.5 m Horizontal / Vertical Position Accuracy	Surface Mount (SMD) 24 x 22 x 3 mm; 4 grams; 445 mW

VECTORNAV INS FILTER

Each VectorNav product features a robust Kalman Filter (EKF) along with proprietary suite of high performance algorithms that run completely onboard the sensors. VectorNav's industry leading algorithms provide high-accuracy position, velocity and attitude estimates along with compensated inertial measurements at rates between 400 and 800 Hz.

DEVELOPMENT KIT OPTIONS



VN-200 Rugged



VN-200 Surface Mount

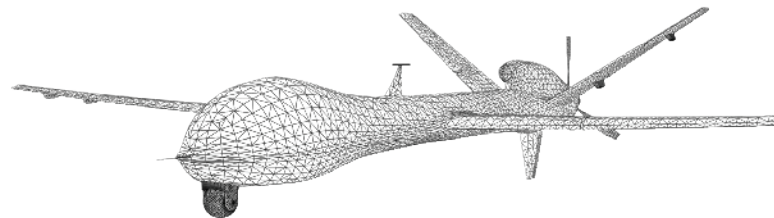

Kit Contents

Complete hardware Development Kits include VectorNav sensor, applicable cabling, GNSS antenna, documentation, hardware tools and rugged carrying case.

Sensor Summary

- ▶ VectorNav proprietary Extended Kalman Filter INS delivers coupled position, velocity, and a continuous attitude solution over the complete 360° range of operation
- ▶ True INS Filter, no mounting restrictions, modes of operation or constraints required
- ▶ Real-time gyro & accel bias tracking & compensation
- ▶ VectorNav Processing Engine (VPE) for disturbance rejection, adaptive filtering, dynamic filter tuning
- ▶ Hard/Soft Iron Compensation (Real-time and Manual 2D & 3D)
- ▶ Individually calibrated for bias, scale factor, misalignment, and temperature over full operating range (-40°C to +85 °C)
- ▶ Raw Pseudorange, Doppler and Carrier Phase outputs
- ▶ Real-time and delayed heave estimation
- ▶ Coning and sculling integrals (ΔV 's, $\Delta \theta$'s)
- ▶ Data output format: ASCII (VectorNav), NMEA-0183, Binary (VectorNav)
- ▶ VectorNav Control Center GUI (available for free download at www.vectornav.com) provides a practical tool for easy sensor setup, configuration and data viewing/logging
- ▶ ITAR-Free

Performance Specifications

ATTITUDE

Range (Heading/Yaw, Roll)	$\pm 180^\circ$
Range (Pitch)	$\pm 90^\circ$
Heading (Magnetic) ¹	2.0° RMS
Heading (INS) ²	0.2°, 1 σ
Pitch/Roll (Static)	0.5° RMS
Pitch/Roll (INS) ²	0.03°, 1 σ
Heading Mounting Misalignment (Rugged) ³	0.15°, 1 σ
Pitch/Roll Mounting Misalignment ³	0.1°, 1 σ
Angular Resolution	0.001°

POSITION/VELOCITY

Horizontal Position Accuracy ⁴	1.0 m RMS
Vertical Position Accuracy ⁴	1.5 m RMS
Free Inertial Position Drift ⁵	3.0 cm/s ²
Velocity Accuracy	< 0.05 m/s
Heave Accuracy	5 % or 5 cm
Delayed Heave Accuracy	2 % or 2 cm

IMU Specifications

	ACCELEROMETER	GYROSCOPE	MAGNETOMETER	BAROMETER
Range	± 16 g	$\pm 2,000^\circ/\text{s}$	± 2.5 Gauss	10 to 1200 mbar
In-Run Bias Stability (Allan Variance)	< 0.04 mg	< 10°/hr (5-7°/hr typ.)	-	-
Noise Density	0.14 mg/ $\sqrt{\text{Hz}}$	0.0035 °/s / $\sqrt{\text{Hz}}$	140 $\mu\text{Gauss}/\sqrt{\text{Hz}}$	-
Bandwidth	260 Hz	256 Hz	200 Hz	200 Hz
Cross-Axis Sensitivity	$\pm 0.05^\circ$	< 0.05 °	$\pm 0.05^\circ$	-

GNSS Receiver

Receiver Type	72 Channel, L1C/A, L10F, E1, B1I GNSS
Constellations ⁶	GPS, GLONASS, Galileo, BeiDou, QZSS, SBAS
Time-To-First-Fix (Cold)	29 s
Time-To-First-Fix (Hot)	1 s
Altitude Limit	50,000 m
Velocity Limit	500 m/s

Interfacing

Output Data Rate (IMU) ⁷	up to 800 Hz
Output Data Rate (Position, Velocity & Attitude)	up to 400 Hz
Interface (VN-200 Rugged)	RS-232, Serial TTL
Interface (VN-200 SMD)	Serial TTL, SPI
GNSS PPS	30 ns RMS, 60 ns 99%
Input	Sync-in
Output	Sync-out

Environmental

Operating Temperature	-40° to +85° C
Storage Temperature	-40° to +85° C
MTBF (Rugged)	> 150,000 hours
MTBF (SMD)	> 240,000 hours

Mechanical/Electrical

	SIZE	WEIGHT	INPUT VOLTAGE	CURRENT DRAW ⁸	POWER ⁸
Rugged	36 x 33 x 9.5 mm	16 g	3.3 to 17 V	80 mA @ 5 V	500 mW
SMD	24 x 22 x 3 mm	4 g	3.2 to 5.5 V	105 mA @ 3.3 V	445 mW

1. With proper magnetic declination, suitable magnetic environment and valid hard/soft iron calibration.

2. With sufficient motion for dynamic alignment.

3. Constant on a per part basis. Can be calibrated out during system integration using boresighting or other alignment processes.

4. Dependant on SBAS, clear view of GNSS satellites, good multipath environment, compatible GNSS antenna, and measurement duration period.

5. Typical rate of growth in error of position estimates after loss of GNSS signal, provided INS full alignment prior to loss.

6. Only GPS, Galileo and SBAS constellations used in VN-200 default configuration.

7. Contact VectorNav for higher IMU data output rates.

8. Not including active antenna power consumption.

VN-300 GNSS/INS

Dual GNSS-Aided Inertial Navigation System

INTRODUCTION

The VN-300 is a miniature, high-performance Dual Antenna GNSS-Aided Inertial Navigation System (Dual GNSS/INS) that combines high-performance inertial sensors, two high-sensitivity GNSS receivers, and advanced Kalman filtering algorithms to provide optimal estimates of position, velocity, and attitude under static and dynamic conditions.



VN-300 SMD

VN-300 Rugged

PRODUCT HIGHLIGHTS

0.2°	0.15°	< 0.04 mg	400 Hz
Dynamic Heading Accuracy (INS)	Static Heading Accuracy (GNSS-Compass)	Accel In-Run Bias Stability	Position, Velocity and Attitude Data
0.03°	5-7°/hr (typ.)	1.0 m / 1.5 m	Surface Mount (SMD)
Dynamic Pitch/Roll Accuracy (INS)	Gyro In-Run Bias Stability	Horizontal / Vertical Position Accuracy	24 x 22 x 3 mm; 5 grams; < 1.25 W

GNSS-COMPASS

The **GNSS-COMPASS** technique uses a form of Real-Time Kinematic Positioning (RTK) known as **Moving Baseline RTK** to determine a system's **heading**.

When a GNSS-Compass is combined with an INS, the combined system operates similar to a GNSS/INS system with the additional advantage that when the system experiences **static or low dynamic conditions**, the GNSS Compass is used to determine the system's heading.

► VN-300 GNSS-Compass Heading Accuracy and Start-Up Time as a function of GPS Antenna baseline separation distance.

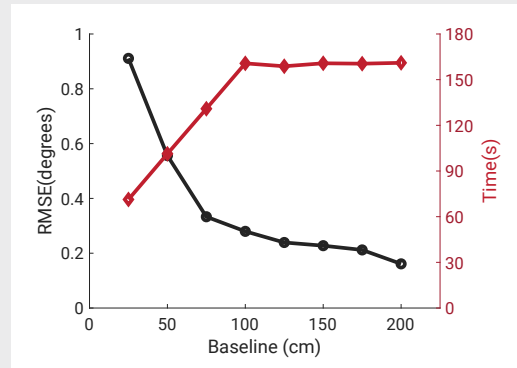

DEVELOPMENT KIT OPTIONS



VN-300 Rugged



VN-300 Surface Mount

Kit Contents

Complete hardware Development Kits include VectorNav sensor, applicable cabling, GNSS antennas, documentation, hardware tools and rugged carrying case.

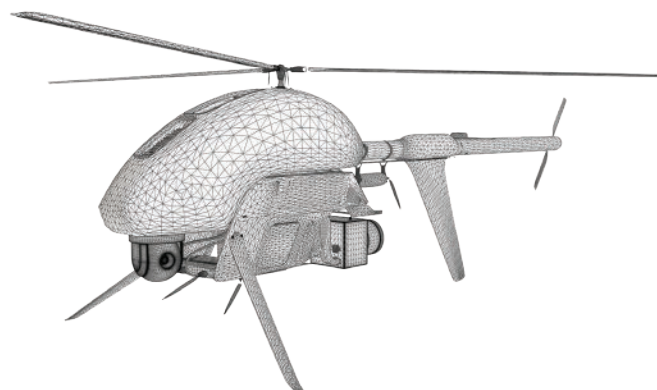

Sensor Summary

- ▶ VectorNav proprietary Extended Kalman Filter INS delivers coupled position, velocity, and a continuous attitude solution over the complete 360° range of operation
- ▶ GNSS-Compass for static and low dynamic heading accuracy
- ▶ Automatic transitioning between AHRS, INS & GNSS-Compass
- ▶ True INS Filter, no mounting restrictions, modes of operation or constraints required
- ▶ VectorNav Processing Engine (VPE) for disturbance rejection, adaptive filtering, dynamic filter tuning
- ▶ Hard/Soft Iron Compensation (Real-time and Manual 2D & 3D)
- ▶ All sensors are individually calibrated for bias, scale factor, misalignment, and temperature over full operating range (-40°C to +85 °C)
- ▶ Raw Pseudorange, Doppler and carrier phase outputs
- ▶ Coning and sculling integrals (ΔV 's, $\Delta \theta$'s)
- ▶ Data output format: ASCII (VectorNav), NMEA-0183, Binary (VectorNav)
- ▶ VectorNav Control Center GUI (available for free download at www.vectornav.com) provides a practical tool for easy sensor setup, configuration and data viewing/logging
- ▶ ITAR-free

Performance Specifications

ATTITUDE

Range (Heading/Yaw, Roll).....	$\pm 180^\circ$
Range (Pitch).....	$\pm 90^\circ$
Heading (Magnetic) ¹	2.0° RMS
Heading (INS) ²	0.2°, 1 σ
Heading (GNSS-Compass) ³	
0.5 m Baseline.....	0.3° to 0.6° RMS
1.0 m Baseline.....	0.15° to 0.3° RMS
2.0 m Baseline.....	0.08° to 0.15° RMS
Pitch/Roll (Static).....	0.5° RMS
Pitch/Roll (INS) ²	0.03°, 1 σ
Heading Mounting Misalignment (Rugged) ⁴	0.15°, 1 σ
Pitch/Roll Mounting Misalignment ⁴	0.1°, 1 σ
Angular Resolution.....	0.001°

POSITION/VELOCITY

Horizontal Position Accuracy ³	1.0 m RMS
Vertical Position Accuracy ³	1.5 m RMS
Free Inertial Position Drift ⁵	3.0 cm/s ²
Velocity Accuracy.....	< 0.05 m/s

IMU Specifications

	ACCELEROMETER	GYROSCOPE	MAGNETOMETER	BAROMETER
Range	± 16 g	$\pm 2,000^\circ/\text{s}$	± 2.5 Gauss	10 to 1200 mbar
In-Run Bias Stability (Allan Variance)	< 0.04 mg	< 10°/hr (5-7°/hr typ.)	-	-
Noise Density	0.14 mg/ $\sqrt{\text{Hz}}$	0.0035 °/s/ $\sqrt{\text{Hz}}$	140 $\mu\text{Gauss}/\sqrt{\text{Hz}}$	-
Bandwidth	260 Hz	256 Hz	200 Hz	200 Hz
Cross-Axis Sensitivity	$\pm 0.05^\circ$	< 0.05 °	$\pm 0.05^\circ$	-

GNSS Receiver

Receiver Type.....	72 Channel, L1C/A, L10F, E1, B1I GNSS
Constellations ⁶	GPS, GLONASS, Galileo, BeiDou, QZSS, SBAS
Time-To-First-Fix (Cold).....	29 s
Time-To-First-Fix (Hot).....	1 s
Altitude Limit.....	50,000 m
Velocity Limit.....	500 m/s

Interfacing

Output Data Rate (IMU) ⁷	up to 400 Hz
Output Data Rate (Position, Velocity & Attitude).....	up to 400 Hz
Interface (VN-300 Rugged).....	RS-232, Serial TTL
Interface (VN-300 SMD).....	Serial TTL, SPI
GNSS PPS.....	30 ns RMS, 60 ns 99%
Input.....	Sync-in
Output.....	Sync-out

Environmental

Operating Temperature.....	-40° to +85° C
Storage Temperature.....	-40° to +85° C
MTBF (Rugged).....	> 125,000 hours
MTBF (SMD).....	> 165,000 hours

Mechanical/Electrical

	SIZE	WEIGHT	INPUT VOLTAGE	CURRENT DRAW ⁸	POWER ⁸
Rugged	45 x 44 x 11 mm	30 g	3.3 to 14 V	250 mA @ 5 V	1.25 W
SMD	24 x 22 x 3 mm	5 g	3.2 to 5.5 V	185 mA @ 3.3 V	1.25 W

1. With proper magnetic declination, suitable magnetic environment and valid hard/soft iron calibration.
2. With sufficient motion for dynamic alignment.
3. Dependant on SBAS, clear view of GNSS satellites, good multipath environment, compatible GNSS antenna, and measurement duration period.
4. Constant on a per part basis. Can be calibrated out during system integration using boresighting of other alignment processes.

5. Typical rate of growth in error of position estimates after loss of GNSS signal, provided INS full alignment prior to loss.
6. Only GPS, Galileo and SBAS constellations used in VN-300 default configuration.
7. Contact VectorNav for higher IMU data output rates.
8. Not including active antenna power consumption.

VN-110 IMU/AHRS

Inertial Measurement Unit /
Attitude Heading Reference System

INTRODUCTION

The VN-110 is a miniature, light weight, low power, high-performance Inertial Measurement Unit (IMU) and Attitude and Heading Reference System (AHRS) available in a embedded module package for mounting to Printed Circuit Boards or aluminum encased rugged module.

The VN-110 computes and outputs a real-time, drift-free attitude solution (i.e. 3D orientation) that is continuous over a complete range of 360° motion.



VN-110E

VN-110

PRODUCT HIGHLIGHTS

< 1°/hr

Gyro In-Run Bias Stability

< 10 μ g

Accel In-Run Bias Stability

0.05°

Pitch/Roll Accuracy

MIL-STD VN-110

MIL-STD-810; MIL-STD-461G;
DO-160G; IP 68

5°/hr / \sqrt Hz

Gyro Noise Density
(ARW)

< 0.04 mg/ \sqrt Hz

Accelerometer Noise Density
(VRW)

800 Hz

IMU Data

Low SWaP VN-110E

31 x 31 x 12 mm;
12 grams; < 1 W

INDUSTRY LEADING ALGORITHMS - VPE

The VN-110 features a robust Kalman Filter (EKF) along with a proprietary suite of high performance algorithms that run completely onboard the sensors. VectorNav's industry leading Vector Processing Engine (VPE) algorithms provide real-time magnetic and acceleration disturbance rejection, adaptive signal filtering, dynamic filter tuning and onboard Hard & Soft Iron compensation.

PACKAGING OPTIONS

Embedded

The VN-110E brings unprecedented capability and performance to SWaP-C constrained applications.

- ▶ Miniature footprint:
31 x 31 x 12 mm
- ▶ Lightweight:
12 grams
- ▶ Low Power:
< 1 W
- ▶ 24-pin 1mm pitch
board-to-board interface
connector
- ▶ Software compatible with
VectorNav's full product line



Tactical

The VN-110 is designed to meet the demands of the most demanding military and aerospace applications.

- ▶ IP 68 per IEC 60529
- ▶ Temperature (DO-160G)
- ▶ Electrical (MIL-STD-1275E)
- ▶ Vibration & Shock (MIL-STD-810G)
- ▶ EMI & Radiation (MIL-STD-461G)
- ▶ Circular push-pull 10-pin connectors
- ▶ Wide input voltage range (12 to 34 V)



Sensor Summary

- ▶ Continuous attitude solution over the complete 360° range of operation
- ▶ VectorNav Processing Engine (VPE) for disturbance rejection, adaptive filtering, dynamic filter tuning
- ▶ Real-time gyro bias tracking and compensation
- ▶ Hard/Soft Iron Compensation (Real-time and Manual 2D & 3D)
- ▶ Inputs for external magnetometers or velocity measurements (Airspeed, GPS)
- ▶ Individually calibrated for bias, scale factor, misalignment, and temperature over full operating range (-40°C to +85°C)
- ▶ Data output format: ASCII (VectorNav), Binary (VectorNav)

- ▶ Coning and sculling integrals (ΔV 's, $\Delta \theta$'s)
- ▶ World Magnetic & Gravity Reference Models
- ▶ VectorNav Control Center GUI (available for free download at www.vectornav.com) provides a practical tool for easy sensor setup, configuration and data viewing/logging
- ▶ ITAR-Free

Performance Specifications

ATTITUDE

Range (Heading/Yaw, Roll).....	$\pm 180^\circ$
Range (Pitch).....	$\pm 90^\circ$
Heading (Magnetic) ¹	2.0° RMS
Pitch/Roll (Static).....	0.05° RMS
Angular Resolution.....	0.001°

Environmental

Operating Temperature.....	-40° to +85° C
Storage Temperature.....	-40° to +85° C
MTBF (VN-110).....	> 35,000 hours
MTBF (VN-110E).....	> 45,000 hours

Interfacing

Output Data Rate (IMU) ²	up to 800 Hz
Output Data Rate (Attitude).....	up to 400 Hz
Primary Interface (VN-110).....	RS-422 (Optional RS-232)
Auxiliary Interface (VN-110).....	RS-422
Interface (VN-110E).....	(2) Serial TTL
Input.....	Sync-in
Output.....	Sync-out

IMU Specifications

	ACCELEROMETER	GYROSCOPE	MAGNETOMETER
Range ³	± 15 g	$\pm 490^\circ/\text{s}$	± 2.5 Gauss
In-Run Bias Stability (Allan Variance)	< 10 μg	< 1°/hr (0.4-0.7°/hr typ.)	-
Noise Density	< 0.04 mg/ $\sqrt{\text{Hz}}$	5°/hr $\sqrt{\text{Hz}}$	140 $\mu\text{Gauss}/\sqrt{\text{Hz}}$
Bandwidth	240 Hz	240 Hz	200 Hz
Cross-Axis Sensitivity	$\pm 0.05^\circ$	< 0.05°	$\pm 0.05^\circ$

Mechanical

	SIZE	WEIGHT	INTERFACE
VN-110	56 x 56 x 23 mm	125 g	10-pin Circular push-pull
VN-110E	31 x 31 x 12 mm	12 g	24-pin Board-to-Board

Electrical

	INPUT VOLTAGE	CURRENT DRAW	POWER
VN-110	12 to 34 V	80 mA @ 24 V	< 2 W
VN-110E	3.2 to 3.5 V	280 mA @ 3.3 V	< 1 W

1. Contact VectorNav for higher IMU data output rates.

2. With proper magnetic declination, suitable magnetic environment and valid hard/soft iron calibration.

3. Contact VectorNav for Extended Range Gyro Option.

VN-210 GNSS/INS

GNSS Aided Inertial Navigation System

INTRODUCTION

The VN-210 is a miniature, high performance GNSS-Aided Inertial Navigation System (GNSS/INS) that combines tactical-grade inertial sensors, a Multi-band GNSS receiver, and advanced Kalman filtering algorithms to provide optimal estimates of position, velocity, and attitude.



VN-210E

VN-210

PRODUCT HIGHLIGHTS

0.05°-0.1°

Dynamic Heading Accuracy (INS)

< 1°/hr

Gyro In-Run Bias Stability

RTK/PPK Capable

External RTCM 3 Inputs; Exportable RINEX

MIL-STD VN-210

MIL-STD-810; MIL-STD-461G; DO-160G; IP 68 Rated

0.015°

Dynamic Pitch/Roll Accuracy (INS)

Multi-band GNSS

Integrated L1/L2/E1/E5b GNSS Receiver

External GNSS

Support for External RTK/PPK & SAASM/M-Code GPS

Low SWaP VN-210E

31 x 31 x 12 mm; 14 grams; < 1.5 W

VECTORNAV INS FILTER

Each VN-210 and VN-210E features a robust Kalman Filter (EKF) along with proprietary suite of high performance algorithms that run completely onboard the sensors. VectorNav's industry leading INS provides high-accuracy position, velocity and attitude estimates along with compensated inertial measurements at rates between 400 and 800 Hz.

PACKAGING OPTIONS

Tactical

The VN-210 is designed to meet the needs of the most demanding military and aerospace applications.

- ▶ IP 68 per IEC 60529
- ▶ Temperature (DO-160G)
- ▶ Electrical (MIL-STD-1275E)
- ▶ Vibration & Shock (MIL-STD-810G)
- ▶ EMI & Radiation (MIL-STD-461G)
- ▶ Wide input voltage range (12 to 34 V)

Embedded

The VN-210E brings unprecedented capability and performance to SWaP-C constrained applications.

- ▶ Miniature footprint: 31 x 31 x 12 mm
- ▶ Light weight: 14 grams
- ▶ Low Power: < 1.5 W



RTK, PPK & M-CODE GPS

The VN-210 features an onboard RTK/PPK capable GNSS receiver, as well as support for external RTK/PPK and SAASM/M-Code GNSS receivers.

RTK & PPK GNSS Receivers

- ▶ Onboard RTK/PPK Capable Multi-band L1/L2/E1/E5b GNSS Receiver
- ▶ Support for external NovAtel & Septentrio RTK/PPK GNSS Receivers

SAASM Receivers

- ▶ Support for external SAASM/M-Code GPS receivers with ICD-GPS-153

Sensor Summary

- ▶ VectorNav proprietary Extended Kalman Filter INS delivers coupled position, velocity, and a continuous attitude solution over the complete 360° range of operation
- ▶ VectorNav Processing Engine (VPE) for disturbance rejection, adaptive filtering, dynamic filter tuning
- ▶ Hard/Soft Iron Compensation (Real-time and Manual 2D & 3D)
- ▶ Individually calibrated for bias, scale factor, misalignment, and temperature over full operating range (-40°C to +85 °C)
- ▶ RTK Capable: Support for External RTCM 3 Inputs
- ▶ Raw GNSS Data: Exportable RINEX Data for PPK; Raw Pseudorange, Doppler and Carrier Phase outputs
- ▶ Support for external RTK GNSS receivers (NovAtel, Septentrio) & SAASM/M-Code GPS receivers (ICD-GPS-153)
- ▶ Coning and sculling integrals (ΔV 's, $\Delta \theta$'s)
- ▶ Data output format: ASCII (VectorNav), NMEA-0183, Binary (VectorNav), ARINC 429¹
- ▶ VN-210:
 - IP 68 per IEC 60529
 - Vibration & Shock (MIL-STD-810G)
 - Temperature (DO-160G)
 - EMI & Radiation (MIL-STD-461G)
 - Electrical (MIL-STD-1275E)
- ▶ VN-210E: 24-pin 1mm pitch board-to-board interface connector with U.FL for GNSS antenna connection

Performance Specifications

ATTITUDE

Range (Heading/Yaw, Roll).....	± 180°
Range (Pitch).....	± 90°
Heading (Magnetic) ²	2.0° RMS
Heading (INS) ^{3,4}	0.05° to 0.1°, 1 σ
Pitch/Roll (Static).....	0.05° RMS
Pitch/Roll (INS) ⁴	0.015°, 1 σ
Heading Mounting Misalignment (VN-210) ⁵	< 0.05°, 1 σ
Heading Mounting Misalignment (VN-210E) ⁵	0.15°, 1 σ
Pitch/Roll Mounting Misalignment ⁵	< 0.05°, 1 σ
Angular Resolution.....	0.001°

POSITION/VELOCITY

Horizontal Position Accuracy ⁶	1.0 m RMS
Vertical Position Accuracy ⁶	1.5 m RMS
RTK Position Accuracy ⁷	0.01 m + 1 ppm CEP
Free Inertial Position Drift ⁸	0.5 cm/s ²
Velocity Accuracy.....	< 0.02 m/s

IMU Specifications

	ACCELEROMETER	GYROSCOPE	MAGNETOMETER
Range ⁹	±15 g	±490°/s	±2.5 Gauss
In-Run Bias Stability (Allan Variance)	< 10 μ g	< 1°/hr (0.4-0.7°/hr typ.)	-
Noise Density	< 0.04 mg/ \sqrt Hz	5°/hr/ \sqrt Hz	140 μ Gauss/ \sqrt Hz
Bandwidth	240 Hz	240 Hz	200 Hz
Cross-Axis Sensitivity	±0.05°	< 0.05°	±0.05°

GNSS Receiver

Receiver Type.....	184 Channel, L1C/A, L10F, E1, B1I, L2C, L20F, E5b, B2I GNSS
Constellations ¹⁰	GPS, GLONASS, Galileo, BeiDou, QZSS, SBAS
Time-To-First-Fix (Cold / Hot).....	24 s / 2 s
Altitude Limit.....	50,000 m
Velocity Limit.....	500 m/s

Environmental

Operating Temperature.....	-40° to +85° C
Storage Temperature.....	-40° to +85° C
MTBF (VN-210).....	> 25,000 hours
MTBF (VN-210E).....	> 45,000 hours

Interfacing

Output Data Rate (IMU) ¹¹	up to 800 Hz
Output Data Rate (Position, Velocity & Attitude).....	up to 400 Hz
Primary Interface (VN-210).....	RS-422 (Optional RS-232)
Auxiliary Interface (VN-210).....	RS-422
Interface (VN-210E).....	(2) Serial TTL
GNSS PPS.....	30 ns RMS, 60 ns 99%
Input.....	Sync-in
Output.....	Sync-out

Mechanical/Electrical

	SIZE	WEIGHT	INPUT VOLTAGE	CURRENT DRAW ¹²	POWER ¹²
VN-210	56 x 56 x 31 mm	155 g	12 to 34 V	110 mA @ 24 V	< 2.7 W
VN-210E	31 x 31 x 12 mm	14 g	3.2 to 3.5 V	420 mA @ 3.3 V	< 1.5 W

1. Contact VectorNav for ARINC 429 option.

2. With proper magnetic declination, suitable magnetic environment and valid hard/soft iron calibration.

3. Dependant on a number of factors, contact VectorNav to discuss expected performance in your application.

4. With sufficient motion for dynamic alignment.

5. Constant on a per part basis. Can be calibrated out during system integration using boresighting or other alignment processes.

6. Dependant on SBAS, clear view of GNSS satellites, good multipath environment, compatible GNSS antenna, and measurement duration period.

7. Dependant on atmospheric conditions, baseline length, GNSS antenna, multipath conditions, satellite visibility and geometry.

8. Typical rate of growth in error of position estimates after loss of GNSS signal, provided INS full alignment prior to loss.

9. Contact VectorNav for Extended Range Gyro Option.

10. Only GPS, Galileo and SBAS constellations used in VN-210 default configuration.

11. Contact VectorNav for higher IMU data output rates.

12. Not including active antenna power consumption.

VN-310 GNSS/INS

Dual GNSS Aided Inertial Navigation System

INTRODUCTION

The VN-310 is a miniature, high-performance Dual Antenna GNSS-Aided Inertial Navigation System that combines tactical-grade inertial sensors, two Multi-band L1/L2/E1/E5b GNSS receivers, and advanced Kalman filtering algorithms to provide optimal estimates of position, velocity, and attitude.



VN-310E

VN-310

PRODUCT HIGHLIGHTS

0.05°-0.1°

Dynamic Heading Accuracy (INS)

0.15°

Static Heading Accuracy (GNSS-Compass)

Multi-band GNSS

Integrated L1/L2/E1/E5b GNSS Receiver

MIL-STD VN-310

MIL-STD-810; MIL-STD-461G; DO-160G; IP 68 Rated

0.015°

Dynamic Pitch/Roll Accuracy (INS)

< 1°/hr

Gyro In-Run Bias Stability

RTK/PPK Capable

Support for External RTCM 3 Inputs; Exportable RINEX

Low SWaP VN-310E

31 x 31 x 12 mm; 15 grams; < 1.6 W

GNSS-COMPASS

The **GNSS-COMPASS** technique uses a form of Real-Time Kinematic Positioning (RTK) known as **Moving Baseline RTK** to determine a system's **heading**.

When a GNSS-Compass is combined with an INS, the combined system operates similar to a GNSS/INS system with the additional advantage that when the system experiences **static or low dynamic conditions**, the GNSS Compass is used to determine the system's heading.

► VN-310 GNSS-Compass Heading Accuracy and Start-Up Time as a function of GPS Antenna baseline separation distance.

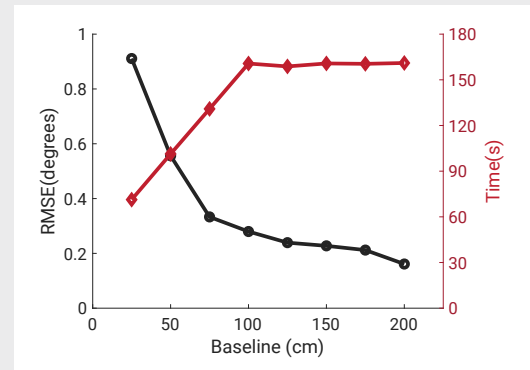

PACKAGING OPTIONS

Embedded

The VN-310E brings unprecedented capability and performance to SWaP-C constrained applications.

- Miniature footprint: 31 x 31 x 12 mm
- Light weight: 16 grams
- Low Power: < 1.6 W
- 24-pin 1mm pitch board-to-board interface connector

Tactical

The VN-310 is designed to meet the demands of the most demanding military and aerospace applications.

- IP 68 per IEC 60529
- Temperature (DO-160G)
- Electrical (MIL-STD-1275E)
- Vibration & Shock (MIL-STD-810G)
- EMI & Radiation (MIL-STD-461G)



Sensor Summary

- ▶ VectorNav proprietary Extended Kalman Filter INS delivers coupled position, velocity, and a continuous attitude solution over the complete 360° range of operation
- ▶ GNSS-Compass for static and low dynamic heading accuracy
- ▶ Adjustable GNSS antenna baseline lengths for shorter start-up times or increased heading accuracy (heading accuracy between 0.08° and 0.6° RMS)
- ▶ Automatic transition between AHRS, INS and GNSS-Compass
- ▶ VectorNav Processing Engine (VPE) for disturbance rejection, adaptive filtering, dynamic filter tuning
- ▶ Real-time gyro & accel bias tracking and compensation
- ▶ Hard/Soft Iron Compensation (Real-time and Manual 2D & 3D)
- ▶ Individually calibrated for bias, scale factor, misalignment, and temperature over full operating range (-40°C to +85°C)
- ▶ RTK Capable: Support for External RTCM 3 Inputs
- ▶ Raw GNSS Data: Exportable RINEX Data for PPK; Raw Pseudorange, Doppler and Carrier Phase outputs
- ▶ Coning and sculling integrals (ΔV 's, $\Delta \theta$'s)
- ▶ Data output format: ASCII (VectorNav), NMEA-0183, Binary (VectorNav), ARINC 429¹

Performance Specifications

ATTITUDE

Range (Heading/Yaw, Roll)	± 180°
Range (Pitch)	± 90°
Heading (Magnetic) ²	2.0° RMS
Heading (INS) ^{3,4}	0.05° to 0.1°, 1 σ
Heading (GNSS-Compass) ⁵	
0.5 m Baseline	0.3° to 0.6° RMS
1.0 m Baseline	0.15° to 0.3° RMS
2.0 m Baseline	0.08° to 0.15° RMS
Pitch/Roll (Static)	0.05° RMS
Pitch/Roll (INS) ⁴	0.015°, 1 σ
Heading Mounting Misalignment (VN-310) ⁶	< 0.05°, 1 σ
Heading Mounting Misalignment (VN-310E) ⁶	0.15°, 1 σ
Pitch/Roll Mounting Misalignment ⁶	< 0.05°, 1 σ
Angular Resolution	0.001°

POSITION/VELOCITY

Horizontal Position Accuracy ⁵	1.0 m RMS
Vertical Position Accuracy ⁵	1.5 m RMS
RTK Position Accuracy ⁷	0.01 m + 1 ppm CEP
Free Inertial Position Drift ⁸	0.5 cm/s ²
Velocity Accuracy	< 0.02 m/s

IMU Specifications

	ACCELEROMETER	GYROSCOPE	MAGNETOMETER
Range ⁹	±15 g	±490°/s	±2.5 Gauss
In-Run Bias Stability (Allan Variance)	< 10 μ g	< 1°/hr (0.4-0.7°/hr typ.)	-
Noise Density	< 0.04 mg/ \sqrt Hz	5°/hr/ \sqrt Hz	140 μ Gauss/ \sqrt Hz
Bandwidth	240 Hz	240 Hz	200 Hz
Cross-Axis Sensitivity	±0.05°	< 0.05°	±0.05°

GNSS Receivers

Receiver Type.....	184 Channel, L1C/A, L10F, E1, B1I, L2C, L20F, E5b, B2I GNSS
Constellations ¹⁰	GPS, GLONASS, Galileo, BeiDou, QZSS, SBAS
Time-To-First-Fix (Cold / Hot)	24 s / 2 s
Altitude Limit	50,000 m
Velocity Limit	500 m/s

Environmental

Operating Temperature.....	-40° to +85° C
Storage Temperature.....	-40° to +85° C
MTBF (VN-310)	> 25,000 hours
MTBF (VN-310E).....	> 45,000 hours

Interfacing

Output Data Rate (IMU) ¹¹	up to 800 Hz
Output Data Rate (Position, Velocity & Attitude)	up to 400 Hz
Primary Interface (VN-310)	RS-422 (Optional RS-232)
Auxiliary Interface (VN-310)	RS-422
Interface (VN-310E)	(2) Serial TTL
GNSS PPS.....	30 ns RMS, 60 ns 99%
Input	Sync-in
Output	Sync-out

Mechanical/Electrical

	SIZE	WEIGHT	INPUT VOLTAGE	CURRENT DRAW ¹²	POWER ¹²
VN-310	56 x 56 x 31 mm	160 g	12 to 34 V	135 mA @ 24 V	< 3.3 W
VN-310E	31 x 31 x 12 mm	15 g	3.2 to 3.5 V	480 mA @ 3.3 V	< 1.6 W

1. Contact VectorNav for ARINC 429 option.

2. With proper magnetic declination, suitable magnetic environment and valid hard/soft iron calibration.

3. Dependant on a number of factors, contact VectorNav to discuss expected performance in your application.

4. With sufficient motion for dynamic alignment.

5. Dependant on SBAS, clear view of GNSS satellites, good multipath environment, compatible GNSS antenna, and measurement duration period.

6. Constant on a per part basis. Can be calibrated out during system integration using boresighting or other alignment processes.

7. Dependant on atmospheric conditions, baseline length, GNSS antenna, multipath conditions, satellite visibility and geometry.

8. Typical rate of growth in error of position estimates after loss of GNSS signal, provided INS full alignment prior to loss.

9. Contact VectorNav for Extended Range Gyro Option.

10. Only GPS, Galileo and SBAS constellations used in VN-310 default configuration.

11. Contact VectorNav for higher IMU data output rates.

12. Not including active antenna power consumption.

CONTROL CENTER

VectorNav Software Configuration Tool

INTRODUCTION

VectorNav Control Center provides you with a wide assortment of tools to visualize and inspect the diverse set of output data made available by your VectorNav sensor.

Downloadable at: www.vectornav.com

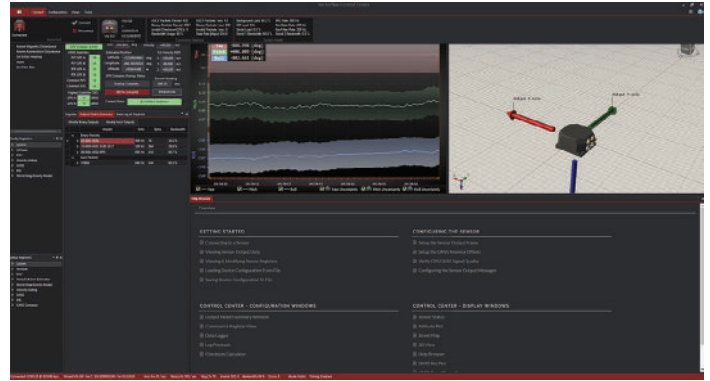

PRODUCT HIGHLIGHTS

3D Visualization

An intuitive visualization of the current configuration of your sensor including the placement of the GNSS antennas relative to the sensors reference frame, simplifying sensor setup.

GNSS Antenna Alignment

The 3D display provides a real-time view of how the antennas are positioned relative to the sensor based on the current register configuration. Changes made to the registers are immediately shown in the 3D visualization window.

Data Logging

Provides users with the ability to log all communication with the sensor to a file for later playback or analysis.

Configuration and Control

Access to all configuration registers and commands supported by your VectorNav sensor. This provides a quick method of getting your device up and running during initial configuration.

Data Export

Any output from the sensor can be exported to CSV comma delimited text file, or MATLAB. Simply select the desired output, right click and select output to CSV or MATLAB.

Reference Frame Rotation

Control Center simplifies the process of configuring the sensors reference frame relative to your vehicle or output frame.

VECTORNAV SUPPORT

For every challenge
you know of, and every
challenge you don't.



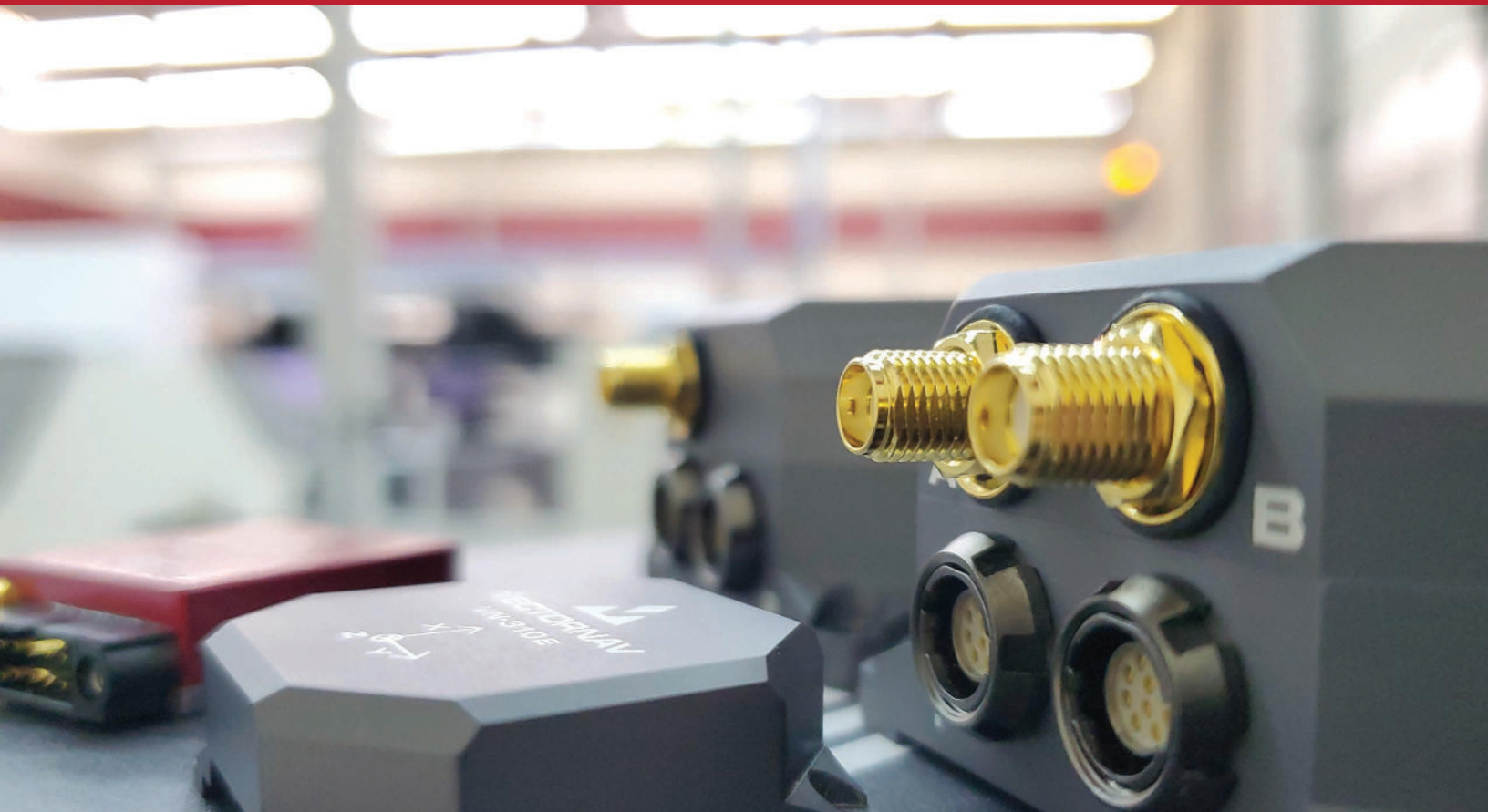

VECTORNAV

VectorNav Technologies is a leading developer and manufacturer of high performance inertial navigation systems. Founded in 2008, VectorNav has provided system integrators in Military, Aerospace, Marine and Robotics industries with embedded navigation solutions optimized for SWAP-C constraints.

PRODUCT SUPPORT

All our products are backed by the industry's most customer-focused, robust and responsive support ecosystem. VectorNav's mission is to ensure successful evaluation, development, testing, and integration of VectorNav sensors into your application.

FIELDIED OVER

40K

Proven and reliable products for the most challenging applications and demanding environments.

PRODUCTS USED IN

65

Countries around the world since 2008.

KEY BENEFITS

- ▶ AS9100D, ISO 9001 Certified
- ▶ ITAR-Free
- ▶ Made in USA
- ▶ 45,000 ft² (13,500 m²) facility with high volume production capability
- ▶ < 24-hour sales and support response time
- ▶ 1-2 day lead time on Development Kits
- ▶ Online Library of inertial navigation knowledge
- ▶ Common communication protocol across all VectorNav products
- ▶ C/C++, .NET, MATLAB & LabVIEW support for Windows and Linux
- ▶ Standard 1-Year Warranty
- ▶ Calibration Reports



Contact NavtechGPS for product details. www.NavtechGPS.com
+1-703-256-8900 • 800-628-0885 • info@navtechgps.com



HEADQUARTERS

VectorNav Technologies
10501 Markison Road
Dallas, TX 75238
USA

Tel: +1.512.772.3615
Fax: +1.512.772.3086
Email: sales@vectornav.com
Web: www.vectornav.com