

# S O C

Fuses

Fuseholders

Fuse clips

Protectors for all electronic circuits  
and equipment

# How to use this catalog

## Example fuse requirements

Rated voltage:	DC 70 V or greater	Step 1
Terminal / mounting method:	Surface mount type	Step 2
Dimensions:	$W2\text{ mm} \times H1.2\text{ mm} \times L4\text{ mm}$ or less	Step 2
Characteristic:	Inrush-withstand	Step 3
Region of use:	North America	Step 4
Rated current ( $I_N$ ):	1.25 A	Step 5

$I_N$  refers to the fuse's rated current (e.g.,  $1.1 I_N$  is 1.1 times the rated current).

## Using the "Search by rated voltage" pages

- Step 1** Select a rated voltage for the fuse suitable for the circuit in which it is to be inserted. Only select fuses with DC rated voltage for DC circuits, and those with AC rated voltage for AC circuits. Select a rated voltage higher than the voltage of the circuit.
- Step 2** Select a fuse that meets your mounting and dimensional requirements.
- Step 3** Select the characteristic.
- Step 4** Select the certification mark according to the region of use.
- Step 5** Confirm the type name of the selected fuse and proceed to the indicated product specification page.

## Search by rated voltage (DC)

Step 1	Step 2	Step 3	Step 4					Step 5			
Rated voltage	Dimensions (mm)	Characteristic	PS *	UL or RUL	SE or CE	S	⊖	Type name	Rated current	Page	
DC 72 V	$W1.6 \times H1.05 \times L3.2$ 	Quick-acting	<input type="checkbox"/>	<input checked="" type="checkbox"/>	<input checked="" type="checkbox"/>	<input type="checkbox"/>	<input type="checkbox"/>	11CF	100 mA–10 A	19	
			<input type="checkbox"/>	<input checked="" type="checkbox"/>	<input checked="" type="checkbox"/>	<input type="checkbox"/>	<input type="checkbox"/>	11CFB	100 mA–10 A	18	
			<input type="checkbox"/>	<input type="checkbox"/>	<input type="checkbox"/>	<input type="checkbox"/>	<input type="checkbox"/>	P11CF	100 mA–10 A	22	
		Inrush-withstand	<input type="checkbox"/>	<input checked="" type="checkbox"/>	<input checked="" type="checkbox"/>	<input type="checkbox"/>	<input type="checkbox"/>	<input type="checkbox"/>	11CT	100 mA–10 A	19
			<input type="checkbox"/>	<input checked="" type="checkbox"/>	<input checked="" type="checkbox"/>	<input type="checkbox"/>	<input type="checkbox"/>	<input type="checkbox"/>	11CTB	100 mA–10 A	18
			<input type="checkbox"/>	<input type="checkbox"/>	<input type="checkbox"/>	<input type="checkbox"/>	<input type="checkbox"/>	<input type="checkbox"/>	P11CT	100 mA–10 A	22

If you cannot find a fuse satisfying your requirements, please contact your SOC sales representative. This catalog does not include fuses that treat 130% of the rated current as a non-fusing current in order to protect equipment used domestically in Japan. Please contact a sales representative for these products.

## IMPORTANT







Before proceeding with final fuse selection, be sure to read Fuse Selection Process on p. 139 and Safety Precautions on p. 158.

The pre-arcing time-current characteristics on the individual product specification pages are plots of the average values of measurements obtained under conditions specified by us. These data are for reference only and are not intended to infer any guaranteed values.

## Product name composition

■ Surface mount type	Ex.	11CT	1A	R08B4	
		↓	↓	↓	
		Type name	Rated current	Packaging code (refer to p. 135)	
■ Sub-miniature type with leads	Ex.	25RT	500mA	F003	
		↓	↓	↓	
		Type name	Rated current	Forming number (refer to p. 138)	
■ Cartridge type	Ex.	MT3	2.5A	N1	F013
		↓	↓	↓	↓
		Type name	Rated current	Certification combination code	Forming number (refer to p. 137)

Certification combinations (● : Certification acquired)

Code		 / 	 / 		
N1	●	●	●	—	—
N2	●	—	●	—	—
N3	●	●	—	—	—
N4	●	●	●	●	—
N5	●	●	●	●	●
N6	—	●	●	●	●
N7	—	●	●	●	—

Please contact your sales representative for information on products with certification combinations not included in this catalog.

## RoHS-compliant

All products contained in this catalog are RoHS-compliant.

Products without the Pb-free indication use high melting temperature type solder containing 85% by weight or more lead. Application of lead in such solder is exempted from the RoHS Directive.









## Terminology / Abbreviations

11CT Type	Type name for products with the same size and dimensions as the 11CT. For example: 11CT, 11CF, P11CT, P11CF, DC35V11CT, DC35VP11CT, DC35VP11CF, DC86V11CT, 32V11CF, 11CFB, 11CTB
25CT Type	Type name for products with the same size and dimensions as the 25CT. For example: 25CT, 25CF, P25CT, P25CF, DC35VP25CT, DC35VP25CF, DC300V25CF
25RT Type	Type name for products with the same size and dimensions as the 25RT. For example: 25RT, 25RF, P25RT, P25RF, DC35VP25RT, DC35VP25RF









## Search by rated voltage (AC)

Rated voltage	Dimensions (mm)	Characteristic	PS *	UL or RU	SE or SA	S	⚡	Type name	Rated current	Page
AC 500 V	$\phi$ 6.35 × L31.8	Inrush-withstand		●	●			SHV4	1 A–10 A	37
AC 500 V	$\phi$ 5.2 × L20	Inrush-withstand		●	●			SHV12	100 mA–6.3 A	39
AC 500 V	$\phi$ 6.35 × L31.8	Inrush-withstand		●	●			SHV33	10 A–30 A	43
								NSHV3	1 A–10 A	44
AC 500 V	$\phi$ 10 × L32	-		●	●			500VBL1030A	5 A–50 A	54
AC 500 V	$\phi$ 10 × L31	-		●	●			500VBI1030	5 A–50 A	54
AC 450 V	$\phi$ 10 × L32	-						AC450VBL1030C	60 A	52
AC 400 V	$\phi$ 6.35 × L31.8	Inrush-withstand		●	●	●		SHV14	10 A–20 A	40
									1 A–20 A	
AC 400 V	$\phi$ 5.2 × L20	Inrush-withstand		●	●	●		SHV12	1 A–6.3 A	39
									100 mA–6.3 A	

\* Fuses with rated currents of less than 1 A are not considered electrical products per the Electrical Appliance and Material Safety Law.

Rated voltage	Dimensions (mm)	Characteristic	PS *	UL or RU	SE or SA	S	⚡	Type name	Rated current	Page
AC 400 V	$\phi 6.35 \times L31.8$ 	Inrush-withstand						NSHV13	5 A–25 A	44
								NSHV23A	1 A–20 A	47
AC 400 V	$\phi 5.2 \times L20$ 	Inrush-withstand		●	●			SHV11	100 mA–6.3 A	38
AC 380 V	$\phi 6.35 \times L31.8$ 	Inrush-withstand		●	●			SHV4	Over 10 A–20 A	37
AC 380 V	$\phi 5.2 \times L20$ 	Inrush-withstand		●	●			SHV2	1 A–6.3 A	37
AC 380 V	$\phi 5.2 \times L20$ 	Inrush-withstand		●	●			SHV1	1 A–6.3 A	36
AC 300 V	$\phi 6.35 \times L31.8$ 	Inrush-withstand	●					SHV4	1 A–20 A	37
AC 300 V	$\phi 5.2 \times L20$ 	Inrush-withstand	●					SHV2	1 A–6.3 A	37
AC 300 V	$\phi 5.2 \times L20$ 	Inrush-withstand	●					SHV1	1 A–6.3 A	36







\* Fuses with rated currents of less than 1 A are not considered electrical products per the Electrical Appliance and Material Safety Law.

Rated voltage	Dimensions (mm)	Characteristic	PS *	UL or RU	SE or SA	S	⚡	Type name	Rated current	Page	
AC 250 V	$W3.6 \times H3.6 \times L17$ 	Inrush-withstand	●	●	●	●		36CT	1 A–6.3 A	34	
AC 250 V	$W2.57 \times H2.57 \times L6.1$ 	Quick-acting		●	●			25CF	63 mA–4 A	24	
		Inrush-withstand		●	●			25CT	100 mA–3.15 A	25	
AC 250 V	$W2.57 \times H2.57 \times L9$ 	Quick-acting		●	●			25RF	100 mA–10 A	28	
AC 250 V	$W4 \times H7.7 \times L8.4$ 	Inrush-withstand	●	●	●	●		SMC N4	4 A	35	
AC 250 V	$\phi 10.3 \times L38.1$ 	Normal-acting	●					250V Ⓐ LLC	500 mA–30 A	124	
			●					250V Ⓐ TLLC	500 mA–30 A	129	
		Inrush-withstand	●	●	●				KST2	1 A–30 A	70
			●	●	●				KST2 N1	6.3 A–30 A	70
			●	●	●				SKM10	100 mA–30 A	90
			●	●	●				SKM10 N1	1 A–25 A	90
AC 250 V	$\phi 6.35 \times L31.8$ 	Normal-acting	●					250V Ⓐ LNC	100 mA–20 A	123	
			●	●	●			SS2	50 mA–5 A	94	
			●	●	●			SS2 N1	50 mA–5 A	94	
			●	●	●			SS6	Over 5 A–8 A	95	
			●	●	●			SS6 N1	Over 5 A–8 A	97	
		Inrush-withstand	●						250V Ⓐ TLNC	100 mA–20 A	128
			●	●	●				CES14	100 mA–10 A	67
			●	●	●				CES14 N1	100 mA–10 A	
			●	●	●				CES14 N2	Over 10 A–15 A	68
			●	●	●				ST4	100 mA–30 A	99
●	●	●				ST4 N1	100 mA–8 A	99			
AC 250 V	$\phi 6.35 \times L30$ 	Normal-acting	●					250V Ⓐ LC	100 mA–20 A	122	
		Inrush-withstand	●					250V Ⓐ TLC	100 mA–30 A	127	
			●	●	●	●			TLC N4	8 A–25 A	106
AC 250 V	$\phi 6.35 \times L25.4$ 	Normal-acting		●	●			SL4	80 mA–2 A	91	

\* Fuses with rated currents of less than 1 A are not considered electrical products per the Electrical Appliance and Material Safety Law.







Rated voltage	Dimensions (mm)	Characteristic	PS *	UL or RUL	SE or SCL	S	⚡	Type name	Rated current	Page		
AC 250 V	$\phi 5.2 \times L20$	Quick-acting	●			●	●	EQ	80 mA–6.3 A	57		
			●			●		HQ N7	400 mA–6.3 A	61		
			●					250V Ⓐ SC	100 mA–10 A	121		
		Normal-acting	●		●				MQ4	62 mA–3 A	74	
			●		●				MQ4 N1	62 mA–3 A		
			●		●				MT4	100 mA–3.5 A	80	
		●		●				MT4 D	100 mA–15 A			
		Inrush-withstand	●		●				MT4 N1	100 mA–3.5 A	80	
			●		●				MT4 N1D	100 mA–3.5 A		
			●		●				MT4 N2	Over 3.5 A–15 A	81	
			●		●				MT4 N2D	Over 3.5 A–15 A	84	
			●		●				250V Ⓐ TSC	100 mA–10 A	126	
			Time-lag	●		●		●	●	ET	50 mA–6.3 A	58
				●		●		●	●	ET6	1 A–6.3 A	59
		●			●		●	●	HT N5	1 A–10 A	62	
AC 250 V	$\phi 4.6 \times L16$	Normal-acting	●					250V Ⓐ MSC	100 mA–5 A	120		
		Inrush-withstand	●					250V Ⓐ TMSC	100 mA–5 A	125		
AC 250 V	$\phi 10.3 \times L38.1$	Normal-acting	●					250V Ⓐ LLCR	500 mA–30 A	124		
		Inrush-withstand	●					250V Ⓐ TLLCR	500 mA–30 A	129		
			●		●				SKM7	100 mA–30 A	89	
AC 250 V	$\phi 6.35 \times L31.8$	Normal-acting	●					250V Ⓐ LNCR	100 mA–20 A	123		
			●		●			SS1	50 mA–5 A	93		
			●		●			SS1 N1	50 mA–5 A	93		
			●		●			SS5	Over 5 A–8 A	95		
		Inrush-withstand	●		●				SS5 N1	Over 5 A–8 A	96	
			●		●				250V Ⓐ TLNCR	100 mA–20 A	128	
			●		●				CES15	100 mA–30 A	68	
			●		●				CES15 N1	100 mA–25 A	69	
AC 250 V	$\phi 6.35 \times L30$	Normal-acting	●					250V Ⓐ LCR	100 mA–20 A	122		
			●					250V Ⓐ TLCR	100 mA–30 A	127		
		Inrush-withstand	●		●		●		TLCR N4	8 A–25 A	107	
AC 250 V	$\phi 6.35 \times L20$	Inrush-withstand	●		●			250VTMCR N1	1 A–20 A	64		

\* Fuses with rated currents of less than 1 A are not considered electrical products per the Electrical Appliance and Material Safety Law.

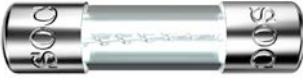







Rated voltage	Dimensions (mm)	Characteristic	PS*	UL or IEC	UL or IEC	S	⚡	Type name	Rated current	Page	
AC 250 V	$\phi 5.2 \times L20$ 	Normal-acting	●					250V Ⓜ SCR	100 mA–10 A	121	
			●	●				MQ3	62 mA–3 A	73	
			●	●				MQ3 N1	62 mA–3 A		
		Inrush-withstand	●	●	●				MT3	100 mA–3.5 A	75
			●	●	●				MT3 D	100 mA–3.5 A	
			●	●	●				MT3 N1	100 mA–3.5 A	75
			●	●	●				MT3 N1D	100 mA–3.5 A	78
			●	●					MT3 N2	Over 3.5 A–15 A	76
			●	●					MT3 N2D	Over 3.5 A–15 A	79
			●						250V Ⓜ TSCR	100 mA–10 A	126
		Time-lag	●	●	●	●			ET6R	1 A–6.3 A	60
			●	●	●	●	●		HTR N5	1 A–10 A	63
		AC 250 V	$\phi 4.6 \times L16$ 	Normal-acting	●					250V Ⓜ MSCR	100 mA–5 A
Inrush-withstand	●							250V Ⓜ TMSCR	100 mA–5 A	125	
AC 250 V	$\phi 4 \times L9$ 	Quick-acting		●	●			NQ3	62 mA–10 A	87	
		Inrush-withstand		●	●			NT3	100 mA–10 A	88	
AC 250 V	$\phi 10 \times L32$ 	-	●	●	●			AC250VBL1030C	40 A–60 A	52	
AC 125 V	$W2.57 \times H2.57 \times L6.1$ 	Quick-acting		●	●			25CF	Over 4 A–15 A	24	
			●	●	●				Over 4 A–6.3 A		
Inrush-withstand	●	●	●				25CT	Over 3.15 A–5 A	25		
	●							100 mA–5 A			
AC 125 V	$W2.57 \times H2.57 \times L9$ 	Quick-acting	●			●		25RF	200 mA–5 A	28	
			●						100 mA–5 A		
		Inrush-withstand		●	●				25RT	100 mA–5 A	28

\* Fuses with rated currents of less than 1 A are not considered electrical products per the Electrical Appliance and Material Safety Law.









Rated voltage	Dimensions (mm)	Characteristic	PS*	UL or IEC	or	or	S	⚡	Type name	Rated current	Page	
AC 125 V	$\phi$ 10.3 × L38.1 	Normal-acting	●						Ⓐ LLC	500 mA–30 A	114	
		Inrush-withstand	●						Ⓐ TLLC	500 mA–30 A	119	
			●							SKM2	3 A–15 A	89
AC 125 V	$\phi$ 6.35 × L31.8 	Normal-acting	●						Ⓐ LNC	100 mA–20 A	113	
			●	●	●				SS6	Over 8 A–15 A	95	
			●	●	●				SS6 N1	Over 8 A–15 A	97	
		Inrush-withstand	●							Ⓐ TLNC	100 mA–20 A	118
				●	●					CES6	100 mA–15 A	65
				●						100 mA–20 A		
			●	●	●					CES6 N1	100 mA–15 A	65
			●	●	●					ST6	100 mA–30 A	102
●	●	●					ST6 N1	100 mA–15 A	103			
AC 125 V	$\phi$ 6.35 × L30 	Normal-acting	●						Ⓐ LC	100 mA–20 A	112	
		Inrush-withstand	●						Ⓐ TLC	100 mA–30 A	117	
AC 125 V	$\phi$ 6.35 × L25.4 	Normal-acting		●	●				SL2	80 mA–6 A	91	
AC 125 V	$\phi$ 6.35 × L15.9 	Normal-acting		●					SU2	100 mA–20 A	104	
AC 125 V	$\phi$ 5.2 × L20 	Normal-acting	●						Ⓐ SC	100 mA–10 A	111	
			●	●					MQ2	62 mA–10 A	72	
				●						62 mA–15 A		
		Inrush-withstand	●	●	●					MQ2 N1	62 mA–10 A	72
			●							Ⓐ TSC	100 mA–10 A	116
				●	●					ULTSC	100 mA–10 A	108
●	●	●					ULTSC N1	100 mA–10 A	108			
AC 125 V	$\phi$ 4.6 × L16 	Normal-acting	●						Ⓐ MSC	100 mA–5 A	110	
		Inrush-withstand	●						Ⓐ TMSC	100 mA–5 A	115	

\* Fuses with rated currents of less than 1 A are not considered electrical products per the Electrical Appliance and Material Safety Law.









Rated voltage	Dimensions (mm)	Characteristic	UL or PS or	UL or PS or	S	⚡	Type name	Rated current	Page	
AC 125 V	$\phi 4.6 \times L14$ 	Normal-acting	●	●			SQ8	80 mA–3 A	92	
		Inrush-withstand	●	●			MT8	100 mA–3 A	85	
AC 125 V	$\phi 10.3 \times L38.1$ 	Normal-acting	●				Ⓐ LLCR	500 mA–30 A	114	
		Inrush-withstand	●				Ⓐ TLLCR	500 mA–30 A	119	
AC 125 V	$\phi 6.35 \times L31.8$ 	Normal-acting	●				Ⓐ LNCR	100 mA–20 A	113	
			●	●			SS5	Over 8 A–15 A	95	
			●	●	●		SS5 N1	Over 8 A–15 A	96	
		Inrush-withstand	●					Ⓐ TLNCR	100 mA–20 A	118
			●	●				CES7	100 mA–15 A	66
			●	●	●			CES7 N1	100 mA–15 A	66
			●	●	●			ST5	100 mA–30 A	100
●	●	●			ST5 N1	100 mA–15 A	101			
AC 125 V	$\phi 6.35 \times L30$ 	Normal-acting	●				Ⓐ LCR	100 mA–20 A	112	
		Inrush-withstand	●				Ⓐ TLCR	100 mA–30 A	117	
AC 125 V	$\phi 6.35 \times L15.9$ 	Normal-acting	●				SU1	80 mA–5 A	104	
AC 125 V	$\phi 5.2 \times L20$ 	Normal-acting	●				Ⓐ SCR	100 mA–10 A	111	
			●	●			MQ1	62 mA–10 A	71	
				●			MQ1 N1	62 mA–15 A		
		Inrush-withstand	●	●	●			Ⓐ TSCR	100 mA–10 A	116
			●	●	●			ULTSCR	100 mA–10 A	109
●	●	●				ULTSCR N1	100 mA–10 A	109		
AC 125 V	$\phi 4.6 \times L16$ 	Normal-acting	●				Ⓐ MSCR	100 mA–5 A	110	
		Inrush-withstand	●				Ⓐ TMSCR	100 mA–5 A	115	
AC 125 V	$\phi 4.6 \times L14$ 	Normal-acting	●	●			SQ7	80 mA–3 A	92	
		Inrush-withstand	●	●			MT7	100 mA–3 A	85	

\* Fuses with rated currents of less than 1 A are not considered electrical products per the Electrical Appliance and Material Safety Law.









Rated voltage	Dimensions (mm)	Characteristic	PS*	UL or	SP or			Type name	Rated current	Page
AC 125 V	$\phi 4 \times L9$ 	Quick-acting		●	●			NQ1	62 mA–10 A	87
		Inrush-withstand		●	●			NT1	100 mA–10 A	88
AC 90 V	$^w 2.57 \times ^h 2.57 \times ^l 9$ 	Quick-acting						P25RF	100 mA–10 A	29
		Inrush-withstand						P25RT	100 mA–6.3 A	29
AC 42 V	$\phi 5.2 \times L20$ 	Inrush-withstand						PMT4	100 mA–20 A	86
AC 32 V	$^w 1.6 \times ^h 1.05 \times ^l 3.2$ 	Inrush-withstand				●		32V11CF	800 mA–6.3 A	21
AC 32 V	$^w 1.5 \times ^h 1.2 \times ^l 2.4$ 	Quick-acting		●	●			MCF3	28 mA–250 mA	31
AC 25 V	$^w 1.5 \times ^h 1.2 \times ^l 2.4$ 	Quick-acting		●	●			MCF3	260 mA–1 A	31
AC 12.5 V	$^w 1.5 \times ^h 1.2 \times ^l 2.4$ 	Quick-acting		●	●			MCF3	1.1 A–2.5 A	31

\* Fuses with rated currents of less than 1 A are not considered electrical products per the Electrical Appliance and Material Safety Law.









# Search by rated voltage (DC)

Rated voltage	Dimensions (mm)	Characteristic	PS*	UL or IEC	or	or	S	or	Type name	Rated current	Page
DC 800 V	$\phi 40 \times L65$ 	-							PT4065	400A	56
DC 700 V	$\phi 6.35 \times L31.8$ 	Inrush-withstand		●	●				SHV16	1 A–4 A	41
DC 700 V	$\phi 6.35 \times L31.8$ 	Inrush-withstand							NSHV15	1 A–4 A	46
DC 600 V	$W3.6 \times H3.6 \times L11$ 	Quick-acting		●	●				36CFA	63 mA–3.15 A	35
DC 600 V	$\phi 10.3 \times L38.1$ 	Normal-acting							LLD6500	15 A	105
DC 600 V	$\phi 6.35 \times L24.6$ 	-							DC600VBI625C	30 A	51
DC 550 V	$\phi 6.35 \times L24.6$ 	-							DC550VBI625C	35 A	50
DC 500 V	$\phi 40 \times L65$ 	-							PT4065	400 A–500 A	56
DC 500 V	$\phi 10.3 \times L38.1$ 	Inrush-withstand		●	●				SHV22	1 A–10 A	42









\* Fuses with rated currents of less than 1 A are not considered electrical products per the Electrical Appliance and Material Safety Law.

Rated voltage	Dimensions (mm)	Characteristic	PS*	UL or IEC	SE or IEC	S	⚡	Type name	Rated current	Page
DC 500 V	$\phi 6.35 \times L31.8$ 	Inrush-withstand						NSHV14	10 A	46
DC 500 V	$\phi 6.35 \times L25.4$ 	Inrush-withstand		● ●				SHV18	1 A–30 A	41
DC 500 V	$\phi 6.35 \times L25.4$ 	Inrush-withstand						NSHV17	1 A–30 A	47
DC 500 V	$\phi 25 \times L42.6$ 	-						DC500VBT2543	225 A	55
DC 500 V	$\phi 10 \times L32$ 	-		● ●				500VBL1030A	5 A–50 A	54
								DC500VBL1030F	60 A	
DC 500 V	$\phi 6.35 \times L31.8$ 	-						DC500VBC635C	5 A–30 A	51
DC 500 V	$\phi 6.35 \times L24.6$ 	-						DC500VBC625A	5 A–35 A	49
DC 500 V	$\phi 10 \times L31$ 	-		● ●				500VBI1030	5 A–50 A	54
									5 A–40 A	

\* Fuses with rated currents of less than 1 A are not considered electrical products per the Electrical Appliance and Material Safety Law.

Rated voltage	Dimensions (mm)	Characteristic	PS*	UL or IEC	or	or	S	or	Type name	Rated current	Page
DC 500 V	$\phi 6.35 \times L24.6$ 	-							DC500VBI625C	5 A–35 A	50
DC 450 V	$\phi 5.2 \times L20$ 	Inrush-withstand		●	●				SHV20	500 mA–6.3 A	42
									NSHV12	100 mA–6.3 A	45
DC 450 V	$\phi 6.35 \times L25.4$ 	Inrush-withstand		●	●				SHV27	6.3 A	43
DC 450 V	$\phi 31 \times L51$ 	-							DC450VPT3050	250 A–350 A	49
DC 450 V	$\phi 30 \times L50$ 	-							DC450VBT3050	250 A–350 A	56
DC 450 V	$\phi 26 \times L46$ 	-							DC450VPT2545	180 A–225 A	48
DC 450 V	$\phi 20 \times L35$ 	-							DC450VPT2035	100 A–150 A	48
DC 425 V	$w3.6 \times H3.6 \times L11$ 	Quick-acting		●	●				36CFA	4 A	35
DC 420 V	$\phi 6.35 \times L25.4$ 	Inrush-withstand		●	●				SHV27	8 A–30 A	43

\* Fuses with rated currents of less than 1 A are not considered electrical products per the Electrical Appliance and Material Safety Law.









Rated voltage	Dimensions (mm)	Characteristic	PS*	UL or IEC	or	or	S	⚡	Type name	Rated current	Page
DC 400 V	$\phi 6.35 \times L31.8$ 	Inrush-withstand		●	●	●			SHV14	10 A–20 A 1 A–20 A	40
DC 400 V	$\phi 5.2 \times L20$ 	Inrush-withstand		●	●	●			SHV12	1 A–6.3 A 100 mA–6.3 A	39
DC 400 V	$\phi 6.35 \times L31.8$ 	Inrush-withstand							NSHV13	5 A–25 A	44
									NSHV23A	1 A–20 A	47
DC 400 V	$\phi 5.2 \times L20$ 	Inrush-withstand		●	●				SHV11	100 mA–6.3 A	38
DC 300 V	$W3.6 \times H3.6 \times L17$ 	Inrush-withstand		●	●				36CT	1 A–6.3 A	34
DC 300 V	$W2.57 \times H2.57 \times L6.1$ 	Quick-acting		●	●				DC300V25CF	63 mA–2 A	25
DC 300 V	$\phi 6.35 \times L24.6$ 	–							DC550VBI625C	35 A	50
DC 250 V	$\phi 5.2 \times L20$ 	Inrush-withstand		●	●				SHV12	100 mA–6.3 A	39
DC 150 V	$W2.57 \times H2.57 \times L6.1$ 	Quick-acting		●	●				25CF	63 mA–15 A	24

\* Fuses with rated currents of less than 1 A are not considered electrical products per the Electrical Appliance and Material Safety Law.







Rated voltage	Dimensions (mm)	Characteristic	PS	UL or	SE or	S	Type name	Rated current	Page
DC 125 V	${}^w2.57 \times {}^h2.57 \times {}^L6.1$	Inrush-withstand	●	●			25CT	100 mA–5 A	25
DC 125 V	${}^w2.57 \times {}^h2.57 \times {}^L9$	Quick-acting	●	●			25RF	100 mA–10 A	28
			●	●	●	200 mA–5 A			
		Inrush-withstand	●	●			25RT	100 mA–5 A	28
DC 125 V	$\phi 6.35 \times {}^L31.8$	Inrush-withstand	●	●			ST6	100 mA–30 A	102
			●	●			ST6 N1	100 mA–15 A	103
DC 125 V	$\phi 5.2 \times {}^L20$	Inrush-withstand	●				MT4 D	100 mA–15 A	82
			●				MT4 N1D	100 mA–3.5 A	83
			●				MT4 N2D	Over 3.5 A–15 A	84
DC 125 V	$\phi 6.35 \times {}^L31.8$	Inrush-withstand	●	●			ST5	Over 8 A–30 A	100
			●	●			ST5 N1	Over 8 A–15 A	101
DC 125 V	$\phi 6.35 \times {}^L30$	Inrush-withstand	●	●			DC125VTLKR	800 mA–35 A	64
DC 125 V	$\phi 5.2 \times {}^L20$	Inrush-withstand	●				MT3 D	100 mA–15 A	77
			●				MT3 N1D	100 mA–3.5 A	78
			●				MT3 N2D	Over 3.5 A–15 A	79
DC 100 V	$\phi 4 \times {}^L9$	Inrush-withstand					PNT5	100 mA–10 A	86
DC 90 V	${}^w2.57 \times {}^h2.57 \times {}^L9$	Quick-acting					P25RF	100 mA–10 A	29

\* Fuses with rated currents of less than 1 A are not considered electrical products per the Electrical Appliance and Material Safety Law.



Rated voltage	Dimensions (mm)	Characteristic	PS*	UL or IEC	or	or	S	⚡	Type name	Rated current	Page	
DC 86 V	${}^w2.57 \times {}^H2.57 \times {}^L6.1$ 	Quick-acting	●	●					25CF	63 mA–5 A	24	
		Inrush-withstand	●	●					25CT	100 mA–5 A	25	
DC 86 V	${}^w1.6 \times {}^H1.05 \times {}^L3.2$ 	Inrush-withstand	●	●					DC86V11CT	100 mA–8 A	20	
DC 72 V	${}^w2.57 \times {}^H2.57 \times {}^L6.1$ 	Quick-acting	●						25CF	18 A	24	
DC 72 V	${}^w1.6 \times {}^H1.05 \times {}^L3.2$ 	Quick-acting	●	●					11CF	100 mA–10 A	19	
			●	●					11CFB	100 mA–10 A	18	
									P11CF	100 mA–10 A	22	
		Inrush-withstand	●	●						11CT	100 mA–10 A	19
			●	●						11CTB	100 mA–10 A	18
										P11CT	100 mA–10 A	22
DC 72 V	${}^w1.5 \times {}^H1.2 \times {}^L2.4$ 	Quick-acting	●	●				MCF3	28 mA–250 mA	31		
DC 72 V	$\phi 10 \times {}^L32$ 	–						DC72VBL1030	50 A–70 A	53		
DC 60 V	${}^w2.57 \times {}^H2.57 \times {}^L6.1$ 	Quick-acting							P25CF	63 mA–18 A	26	
		Inrush-withstand							P25CT	100 mA–5 A	26	
DC 60 V	${}^w2.57 \times {}^H2.57 \times {}^L9$ 	Inrush-withstand							P25RT	100 mA–6.3 A	29	

\* Fuses with rated currents of less than 1 A are not considered electrical products per the Electrical Appliance and Material Safety Law.

Rated voltage	Dimensions (mm)	Characteristic	PS*	UL or IEC	SP or S	or	Type name	Rated current	Page
DC 60 V	$\phi 6.35 \times L15.9$ 	Normal-acting		●			DCSU2	Over 5 A–20 A	105
DC 42 V	$\phi 5.2 \times L20$ 	Inrush-withstand					PMT4	100 mA–20 A	86
DC 35 V	$W2.57 \times H2.57 \times L6.1$ 	Quick-acting					DC35VP25CF	63 mA–18 A	27
		Inrush-withstand					DC35VP25CT	100 mA–5 A	27
DC 35 V	$W1.6 \times H1.05 \times L3.2$ 	Quick-acting					DC35VP11CF	100 mA–10 A	23
		Inrush-withstand		●			DC35V11CT	100 mA–10 A	20
							DC35VP11CT	100 mA–10 A	23
DC 35 V	$W2.57 \times H2.57 \times L9$ 	Quick-acting					DC35VP25RF	100 mA–10 A	30
		Inrush-withstand					DC35VP25RT	100 mA–6.3 A	30
DC 32 V	$W1.6 \times H1.05 \times L3.2$ 	Inrush-withstand		●	●	●	32V11CF	800 mA–6.3 A	21
DC 32 V	$W1.5 \times H1.2 \times L2.4$ 	Quick-acting		●	●		MCF3	260 mA–1 A	31
DC 25 V	$W1.5 \times H1.2 \times L2.4$ 	Quick-acting		●	●		MCF3	1.1 A–2.5 A	31

\* Fuses with rated currents of less than 1 A are not considered electrical products per the Electrical Appliance and Material Safety Law.

# 11CFB

Quick-acting

RoHS-compliant

Pb free

This product increases the 11CF's maximum usage temperature to 125 °C

Representative pre-arcing time-current characteristics

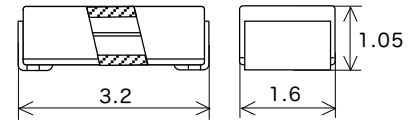
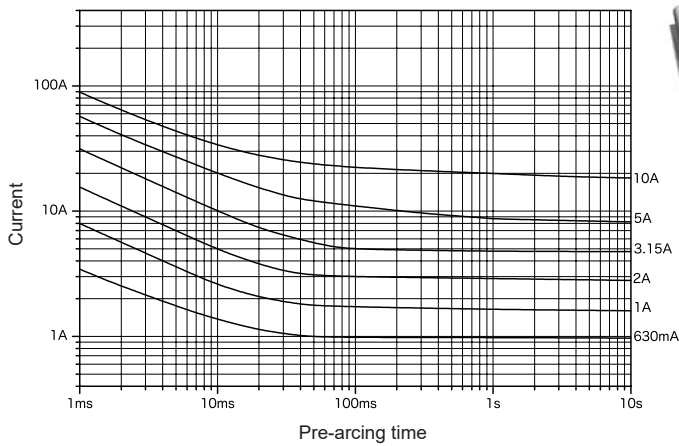

Land pattern for reflow soldering (reference dimensions)

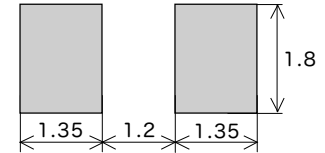

Scale: 8/1 (mm)

Rated voltage	Certification	Rated current ( $I_N$ ) *1	Rated breaking current		Temp. rise	Current carrying capacity	Overload operation
DC 72 V		100 mA–10 A	50 A	Resistive circuit	75 K or less at 1.0 $I_N$	1.0 $I_N$ until temperature stabilization occurs	Within 60 s at 2.0 $I_N$

\*1: Customer-requested rated current values can be supplied from within the given range.

# 11CTB

Inrush-withstand

RoHS-compliant

Pb free

This product increases the 11CT's maximum usage temperature to 125 °C

Representative pre-arcing time-current characteristics

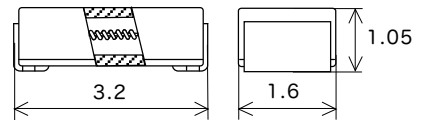
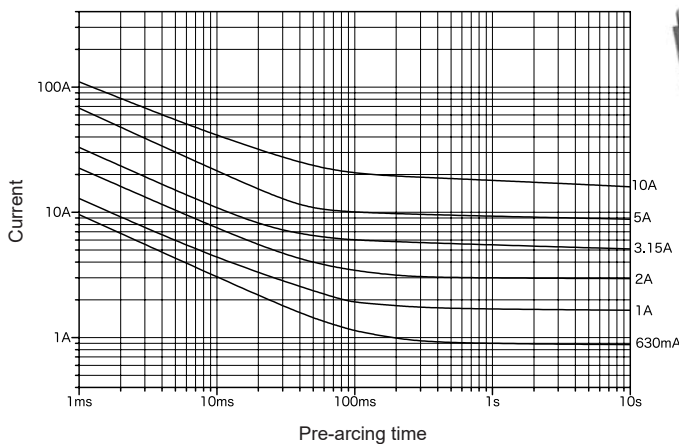

Land pattern for reflow soldering (reference dimensions)



Scale: 8/1 (mm)

Rated voltage	Certification	Rated current ( $I_N$ ) *1	Rated breaking current		Temp. rise	Current carrying capacity	Overload operation
DC 72 V		100 mA–10 A	50 A	Resistive circuit	75 K or less at 1.0 $I_N$	1.0 $I_N$ until temperature stabilization occurs	Within 60 s at 2.0 $I_N$

\*1: Customer-requested rated current values can be supplied from within the given range.

# 11CF

Quick-acting

RoHS-compliant

Pb free

Representative pre-arcing time-current characteristics

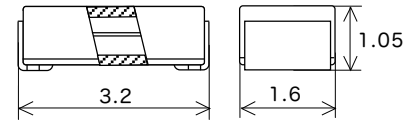
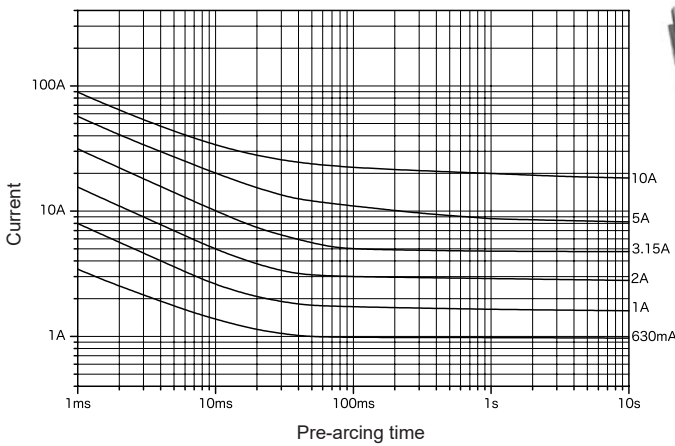

Land pattern for reflow soldering (reference dimensions)

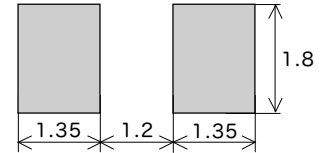

Scale: 8/1 (mm)

Rated voltage	Certification	Rated current ( $I_N$ ) *1	Rated breaking current		Temp. rise	Current carrying capacity	Overload operation
DC 72 V		100 mA–10 A	50 A	Resistive circuit	75 K or less at 1.0 $I_N$	1.0 $I_N$ until temperature stabilization occurs	Within 60 s at 2.0 $I_N$

\*1: Customer-requested rated current values can be supplied from within the given range.

# 11CT

Inrush-withstand

RoHS-compliant

Pb free

Representative pre-arcing time-current characteristics

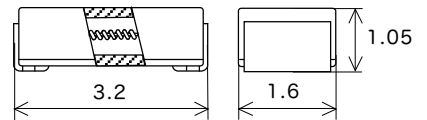
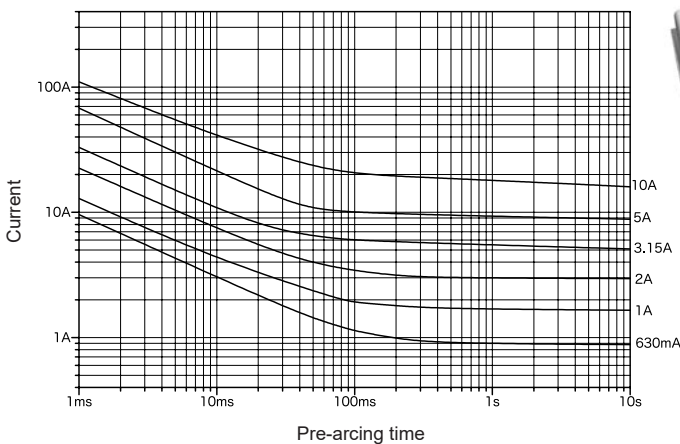

Land pattern for reflow soldering (reference dimensions)

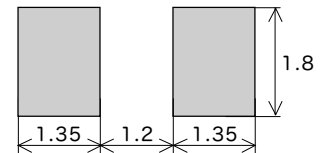

Scale: 8/1 (mm)

Rated voltage	Certification	Rated current ( $I_N$ ) *1	Rated breaking current		Temp. rise	Current carrying capacity	Overload operation
DC 72 V		100 mA–10 A	50 A	Resistive circuit	75 K or less at 1.0 $I_N$	1.0 $I_N$ until temperature stabilization occurs	Within 60 s at 2.0 $I_N$

\*1: Customer-requested rated current values can be supplied from within the given range.

# DC35V11CT

Inrush-withstand

RoHS-compliant

Pb free

Representative pre-arcing time-current characteristics

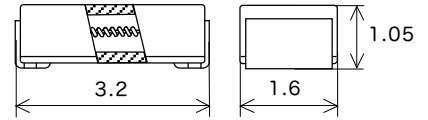
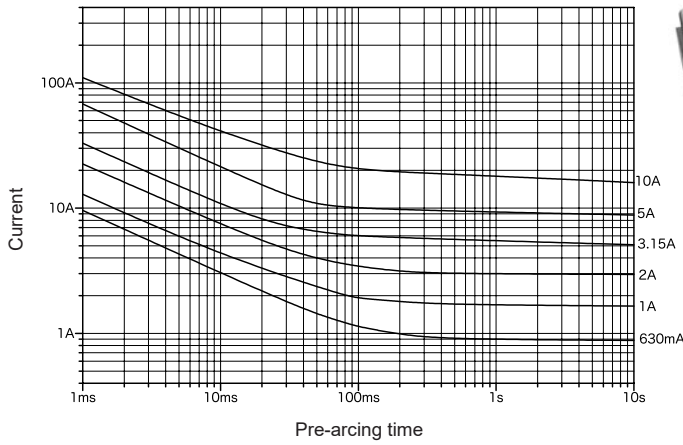

Land pattern for reflow soldering (reference dimensions)

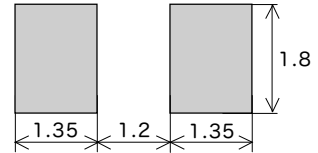

Scale: 8/1 (mm)

Rated voltage	Certification	Rated current ( $I_N$ ) *1	Rated breaking current		Temp. rise	Current carrying capacity	Overload operation
DC 35 V		100 mA–10 A	50 A	Resistive circuit	75 K or less at 1.0 $I_N$	1.0 $I_N$ until temperature stabilization occurs	Within 60 s at 2.0 $I_N$

\*1: Customer-requested rated current values can be supplied from within the given range.

# DC86V11CT

Inrush-withstand

RoHS-compliant

Pb free

Representative pre-arcing time-current characteristics

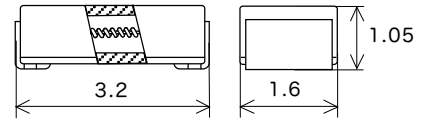
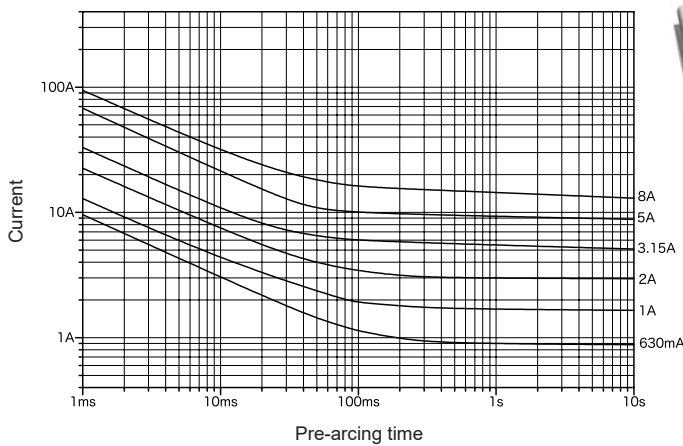

Land pattern for reflow soldering (reference dimensions)

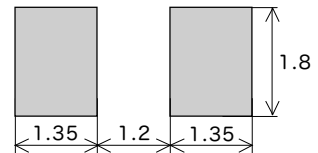

Scale: 8/1 (mm)

Rated voltage	Certification	Rated current ( $I_N$ ) *1	Rated breaking current		Temp. rise	Current carrying capacity	Overload operation
DC 86 V		100 mA–8 A	50 A	Resistive circuit	75 K or less at 1.0 $I_N$	1.0 $I_N$ until temperature stabilization occurs	Within 60 s at 2.0 $I_N$

\*1: Customer-requested rated current values can be supplied from within the given range.

## Pre-arcing time-current characteristics

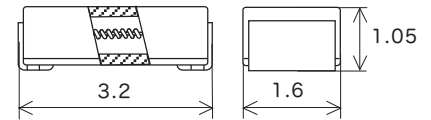
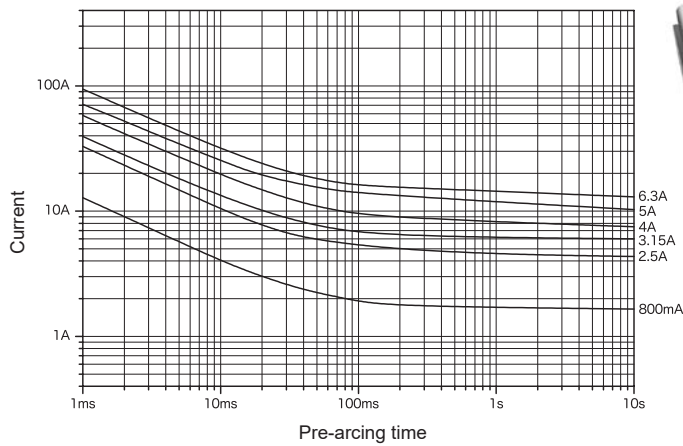

Land pattern for reflow soldering (reference dimensions)

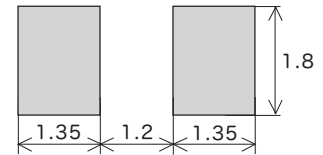

Scale: 8/1 (mm)

Rated voltage	Certification	Rated current ( $I_N$ )	Rated breaking current		Temp. rise	Current carrying capacity / Endurance test	Overload operation
AC / DC 32 V		800 mA 2.5 A 3.15 A	50 A	Resistive circuit	*2	*3	Within 2 min at 2.0 $I_N$ 0.001 s–0.01 s at 10 $I_N$
DC 32 V		4 A 5 A 6.3 A					

\*1: This fuse is categorized as "Inrush-withstand" within SOC; however, it is referred to as Type F (Quick-acting) in the certificate issued by SEMKO.

\*2: The temperature rise of the terminals is 70 K or less when measured during the last five minutes of carrying a 1.25  $I_N$  current for endurance testing.

\*3: Endurance test: After 100 cycles of 1.05  $I_N$  1 h on / 15 min off, 1.25  $I_N$  is passed through the fuse for 1 h.

# P11CF

Protector

Quick-acting

RoHS-compliant

Pb free

Representative pre-arcing time-current characteristics

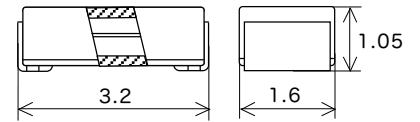
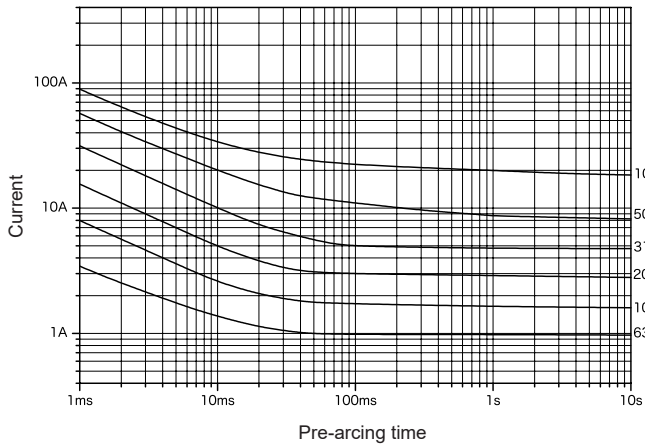

Land pattern for reflow soldering (reference dimensions)

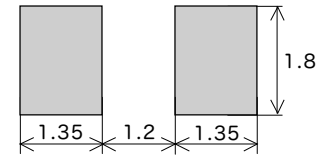

Scale: 8/1 (mm)

Maximum working voltage	Certification	Rated current ( $I_N$ ) *1	Maximum breaking current		Temp. rise	Current carrying capacity	Overload operation
DC 72 V	-	100 mA–10 A	50 A	Resistive circuit	75 K or less at 1.0 $I_N$	1.0 $I_N$ until temperature stabilization occurs	Within 60 s at 2.0 $I_N$

\*1: Customer-requested rated current values can be supplied from within the given range.

Note: The rated current (in amperes) multiplied by 1,000 is indicated on the product and its packaging (e.g., "630" for the 0.63 A version). The product name is the type name followed by this value.

# P11CT

Protector

Inrush-withstand

RoHS-compliant

Pb free

Representative pre-arcing time-current characteristics

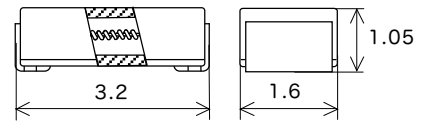
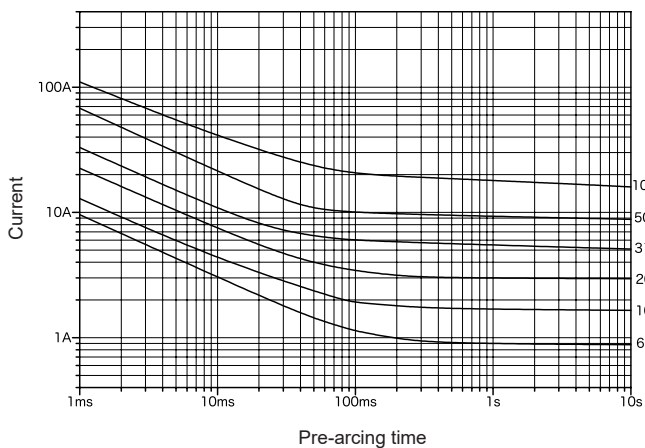

Land pattern for reflow soldering (reference dimensions)

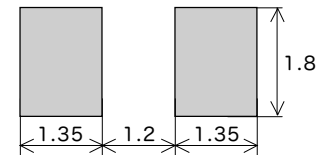

Scale: 8/1 (mm)

Maximum working voltage	Certification	Rated current ( $I_N$ ) *1	Maximum breaking current		Temp. rise	Current carrying capacity	Overload operation
DC 72 V	-	100 mA–10 A	50 A	Resistive circuit	75 K or less at 1.0 $I_N$	1.0 $I_N$ until temperature stabilization occurs	Within 60 s at 2.0 $I_N$

\*1: Customer-requested rated current values can be supplied from within the given range.

Note: The rated current (in amperes) multiplied by 1,000 is indicated on the product and its packaging (e.g., "630" for the 0.63 A version). The product name is the type name followed by this value.

# DC35VP11CF

Protector

Quick-acting

RoHS-compliant

Pb free

Representative pre-arcing time-current characteristics

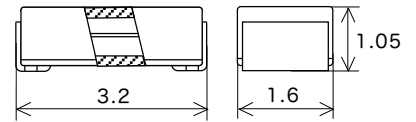
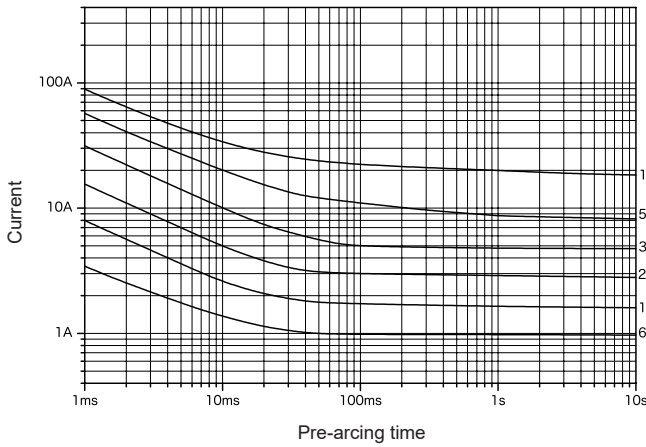

Land pattern for reflow soldering (reference dimensions)

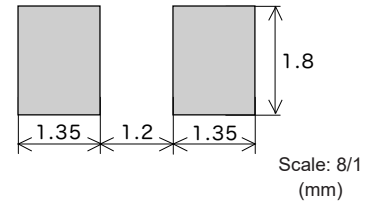

Maximum working voltage	Certification	Rated current ( $I_N$ ) *1	Maximum breaking current		Temp. rise	Current carrying capacity	Overload operation
DC 35 V	-	100 mA–10 A	50 A	Resistive circuit	75 K or less at 1.0 $I_N$	1.0 $I_N$ until temperature stabilization occurs	Within 60 s at 2.0 $I_N$

\*1: Customer-requested rated current values can be supplied from within the given range.

Note: The rated current (in amperes) multiplied by 1,000 is indicated on the product and its packaging (e.g., "630" for the 0.63 A version). The product name is the type name followed by this value.

# DC35VP11CT

Protector

Inrush-withstand

RoHS-compliant

Pb free

Representative pre-arcing time-current characteristics

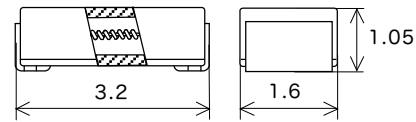
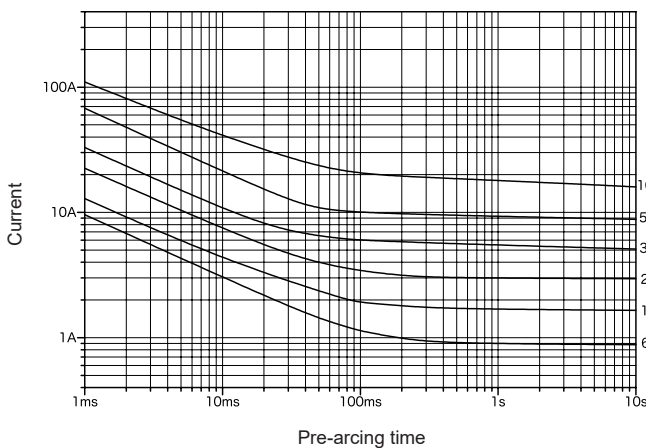

Land pattern for reflow soldering (reference dimensions)

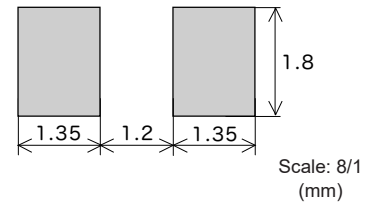

Maximum working voltage	Certification	Rated current ( $I_N$ ) *1	Maximum breaking current		Temp. rise	Current carrying capacity	Overload operation
DC 35 V	-	100 mA–10 A	50 A	Resistive circuit	75 K or less at 1.0 $I_N$	1.0 $I_N$ until temperature stabilization occurs	Within 60 s at 2.0 $I_N$

\*1: Customer-requested rated current values can be supplied from within the given range.

Note: The rated current (in amperes) multiplied by 1,000 is indicated on the product and its packaging (e.g., "630" for the 0.63 A version). The product name is the type name followed by this value.



Representative pre-arcing time-current characteristics

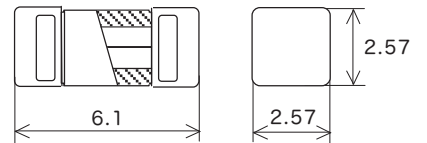
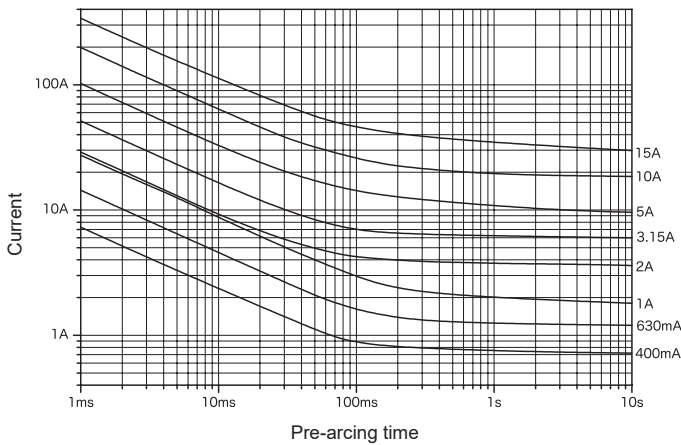

Land pattern for reflow soldering (reference dimensions)

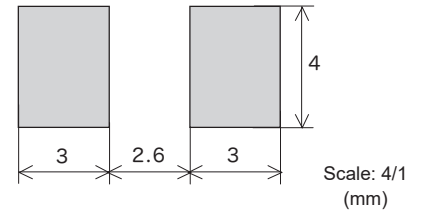

Rated voltage	Certification	Rated current ( $I_N$ ) *1	Rated breaking current	Temp. rise	Current carrying capacity / Endurance test	Overload operation
AC 250 V		63 mA–4 A	50 A	75 K or less at 1.0 $I_N$	1.0 $I_N$ until temperature stabilization occurs	Within 60 s at 2.0 $I_N$
AC 125 V		Over 4 A–10 A				
	AC 125 V		Over 10 A–15 A	Resistive circuit	100 K or less at 1.0 $I_N$	*5
			63 mA–6.3 A		*4	
DC 150 V		63 mA–10 A	350 A	75 K or less at 1.0 $I_N$	1.0 $I_N$ until temperature stabilization occurs	Within 60 s at 2.0 $I_N$
		Over 10 A–15 A				
DC 86 V		63 mA–5 A	10000 A	75 K or less at 1.0 $I_N$		
DC 72 V		18 A	100 A			

\*1: Customer-requested rated current values can be supplied from within the given range.  
 \*2: Fuses with rated currents of less than 1 A are not considered electrical products per the Electrical Appliance and Material Safety Law.  
 \*3: 50 A or 10  $I_N$ , whichever is greater.  
 \*4: The temperature rise of the terminals is 70 K or less when measured during the last five minutes of carrying a 1.25  $I_N$  current for endurance testing.  
 \*5: Endurance test: After 100 cycles of 1.05  $I_N$  1 h on / 15 min off, 1.25  $I_N$  is passed through the fuse for 1 h.

Representative pre-arcing time-current characteristics

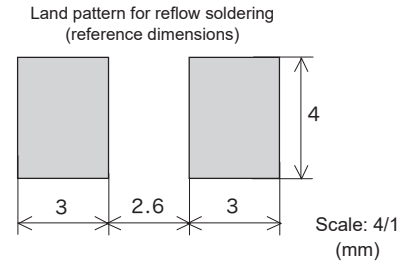
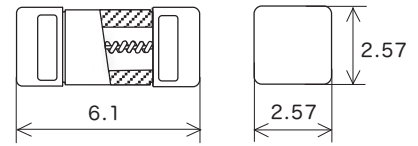
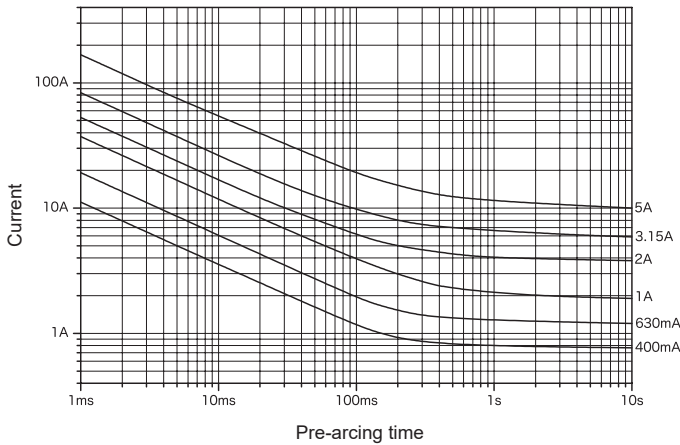

Rated voltage	Certification	Rated current ( $I_N$ ) *1	Rated breaking current	Temp. rise	Current carrying capacity/ Endurance test	Overload operation
AC 250 V	UL US	100 mA–3.15 A	50 A	75 K or less at 1.0 $I_N$	1.0 $I_N$ until temperature stabilization occurs	Within 60 s at 2.0 $I_N$
AC 125 V		Over 3.15 A–5 A				
DC 125 V	UL US	100 mA–5 A	350 A	*3	*4	Within 2 min at 2.0 $I_N$
DC 86 V			10000 A			

\*1: Customer-requested rated current values can be supplied from within the given range.  
 \*2: Fuses with rated currents of less than 1 A are not considered electrical products per the Electrical Appliance and Material Safety Law.  
 \*3: The temperature rise of the terminals is 70 K or less when measured during the last five minutes of carrying a 1.25  $I_N$  current for endurance testing.  
 \*4: Endurance test: After 100 cycles of 1.05  $I_N$  1 h on / 15 min off, 1.25  $I_N$  is passed through the fuse for 1 h.

DC300V25CF

Representative pre-arcing time-current characteristics

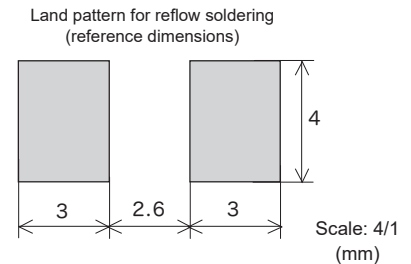
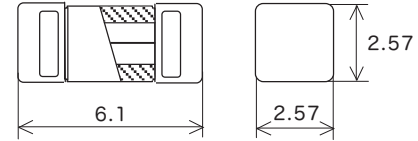
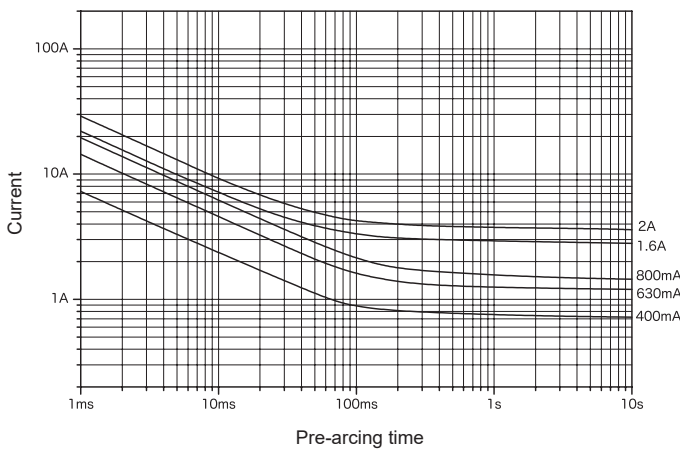

Rated voltage	Certification	Rated current ( $I_N$ ) *1	Rated breaking current	Temp. rise	Current carrying capacity	Overload operation
DC 300 V	UL US	63 mA–2 A	50 A	75 K or less at 1.0 $I_N$	1.0 $I_N$ until temperature stabilization occurs	Within 60 s at 2.0 $I_N$

\*1: Customer-requested rated current values can be supplied from within the given range.

# P25CF

Protector

Quick-acting

RoHS-compliant

Pb free

Representative pre-arcing time-current characteristics

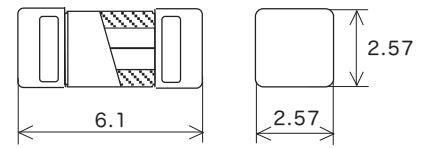
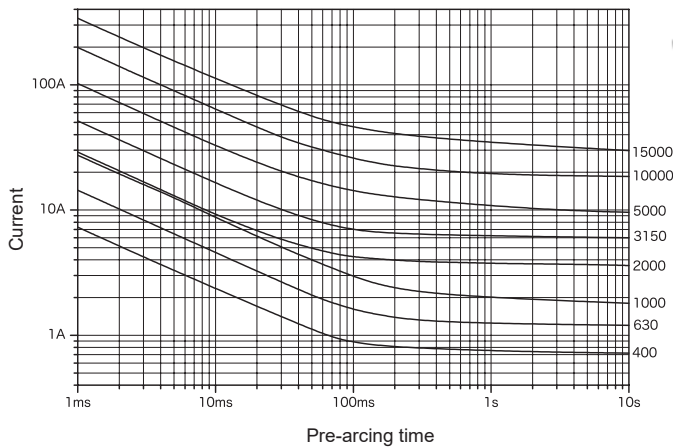

Land pattern for reflow soldering (reference dimensions)

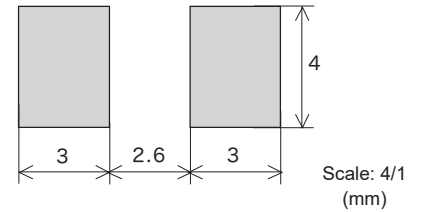

Maximum working voltage	Certification	Rated current ( $I_N$ ) *1	Maximum breaking current	Temp. rise	Current carrying capacity	Overload operation
DC 60 V	-	63 mA–10 A	50 A	Resistive circuit	1.0 $I_N$ until temperature stabilization occurs	Within 60 s at 2.0 $I_N$
		Over 10 A–15 A				
		Over 15 A–18 A				
				75 K or less at 1.0 $I_N$		
				100 K or less at 1.0 $I_N$		
				75 K or less at 1.0 $I_N$		

\*1: Customer-requested rated current values can be supplied from within the given range.

Note: The rated current (in amperes) multiplied by 1,000 is indicated on the product and its packaging (e.g., "630" for the 0.63 A version). The product name is the type name followed by this value.

# P25CT

Protector

Inrush-withstand

RoHS-compliant

Pb free

Representative pre-arcing time-current characteristics

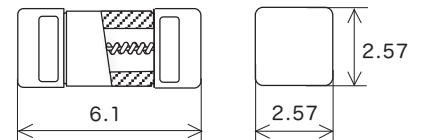
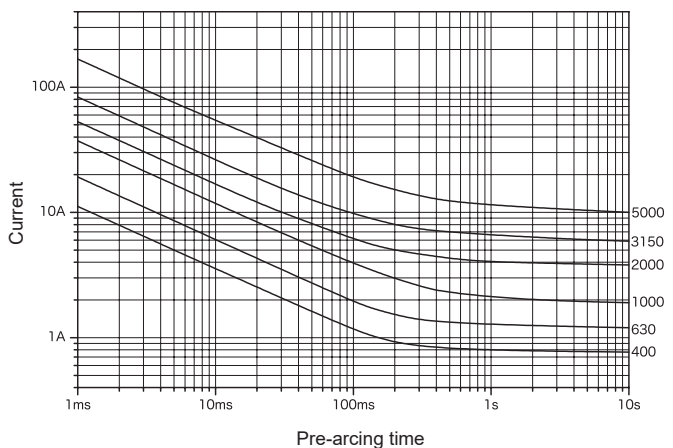

Land pattern for reflow soldering (reference dimensions)

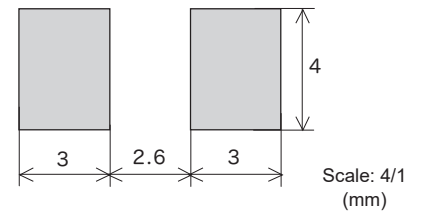

Maximum working voltage	Certification	Rated current ( $I_N$ ) *1	Maximum breaking current	Temp. rise	Current carrying capacity	Overload operation
DC 60 V	-	100 mA–5 A	50 A	Resistive circuit	1.0 $I_N$ until temperature stabilization occurs	Within 60 s at 2.0 $I_N$
				75 K or less at 1.0 $I_N$		

\*1: Customer-requested rated current values can be supplied from within the given range.

Note: The rated current (in amperes) multiplied by 1,000 is indicated on the product and its packaging (e.g., "630" for the 0.63 A version). The product name is the type name followed by this value.

# DC35VP25CF

Protector

Quick-acting

RoHS-compliant

Pb free

Representative pre-arcing time-current characteristics

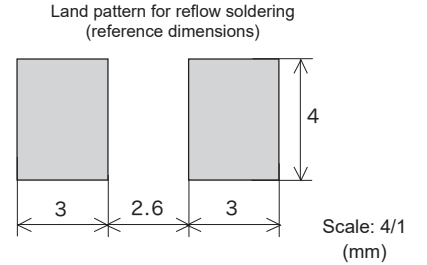
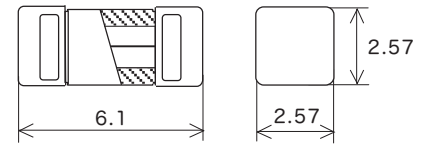
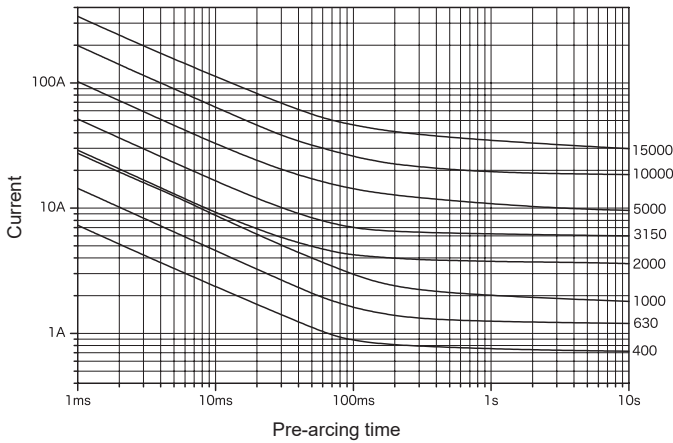

Maximum working voltage	Certification	Rated current ( $I_N$ ) *1	Maximum breaking current	Temp. rise	Current carrying capacity	Overload operation
DC 35 V	-	63 mA–10 A	50 A	Resistive circuit	1.0 $I_N$ until temperature stabilization occurs	Within 60 s at 2.0 $I_N$
		Over 10 A–15 A				
		Over 15 A–18 A				
				75 K or less at 1.0 $I_N$		
				100 K or less at 1.0 $I_N$		
				75 K or less at 1.0 $I_N$		

\*1: Customer-requested rated current values can be supplied from within the given range.

Note: The rated current (in amperes) multiplied by 1,000 is indicated on the product and its packaging (e.g., "630" for the 0.63 A version). The product name is the type name followed by this value.

# DC35VP25CT

Protector

Inrush-withstand

RoHS-compliant

Pb free

Representative pre-arcing time-current characteristics

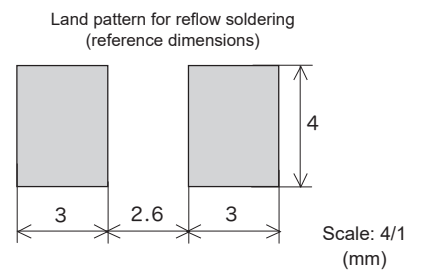
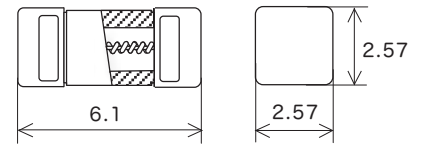
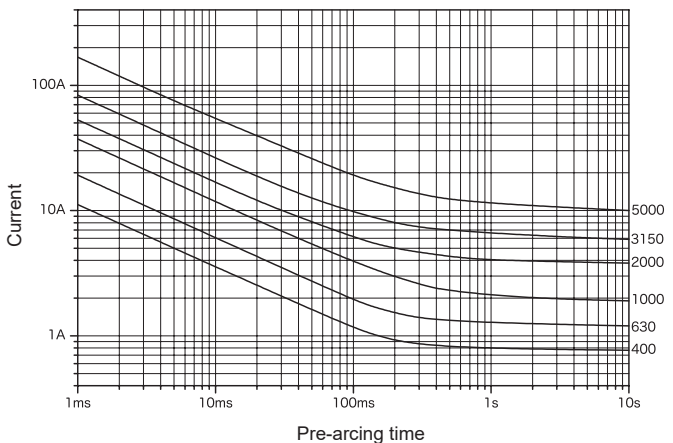

Maximum working voltage	Certification	Rated current ( $I_N$ ) *1	Maximum breaking current	Temp. rise	Current carrying capacity	Overload operation
DC 35 V	-	100 mA–5 A	50 A	Resistive circuit	1.0 $I_N$ until temperature stabilization occurs	Within 60 s at 2.0 $I_N$
				75 K or less at 1.0 $I_N$		

\*1: Customer-requested rated current values can be supplied from within the given range.

Note: The rated current (in amperes) multiplied by 1,000 is indicated on the product and its packaging (e.g., "630" for the 0.63 A version). The product name is the type name followed by this value.

Representative pre-arcing time-current characteristics

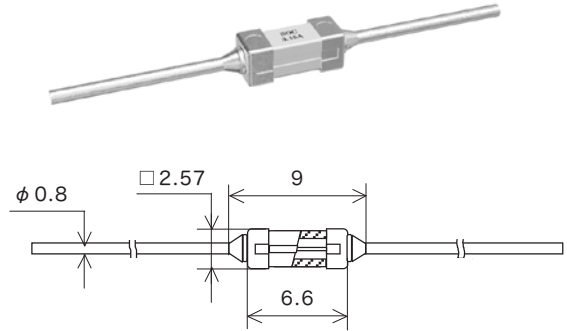
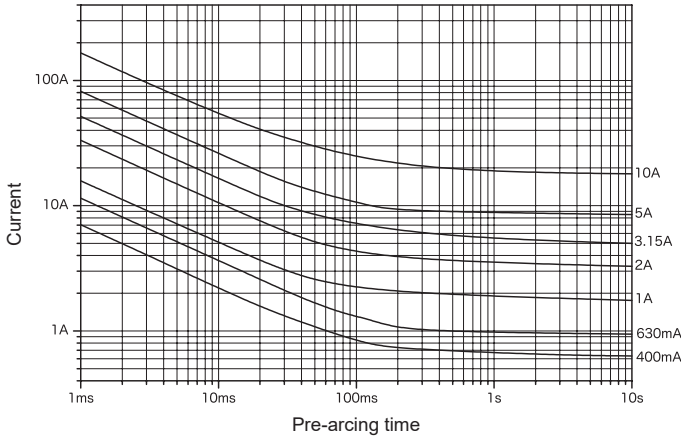

Scale: 2/1 (mm)

Rated voltage	Certification	Rated current (I <sub>N</sub> )	Rated breaking current	Temp. rise	Current carrying capacity	Overload operation	Endurance test
AC 125 V	S	200 mA, 250 mA 315 mA, 400 mA 500 mA, 630 mA 800 mA, 1 A 1.25 A, 1.6 A 2 A, 2.5 A, 3.15 A 4 A, 5 A	50 A	PF over 0.95	4 h or more at 1.0 I <sub>N</sub>	*4	After passing 0.8 I <sub>N</sub> for 100 h, 1.0 I <sub>N</sub> can be passed for 1 h or more
DC 125 V							
AC 125 V	PS E *2	100 mA–5 A *1				Within 5 s at 2.0 I <sub>N</sub>	
AC 250 V	c UL US	100 mA–10 A *1	100 A	Resistive circuit	75 K or less at 1.0 I <sub>N</sub>	1.0 I <sub>N</sub> until temperature stabilization occurs	Within 60 s at 2.0 I <sub>N</sub>
DC 125 V			300 A				

\*1: Customer-requested rated current values can be supplied from within the given range.  
 \*2: Fuses with rated currents of less than 1 A are not considered electrical products per the Electrical Appliance and Material Safety Law.  
 \*3: After passing the rated current through the fuse for 15 min, the current is increased by 0.1 I<sub>N</sub> every 15 min until the fuse operates. While the current is being increased, the temperature rise at each part of the fuse shall not exceed 135 K.

\*4:

2.0 I <sub>N</sub>	2.75 I <sub>N</sub>	4.0 I <sub>N</sub>	10 I <sub>N</sub>
Within 5 s	Within 0.3 s	Within 0.03 s	Within 0.004 s

# 25RT

Representative pre-arcing time-current characteristics

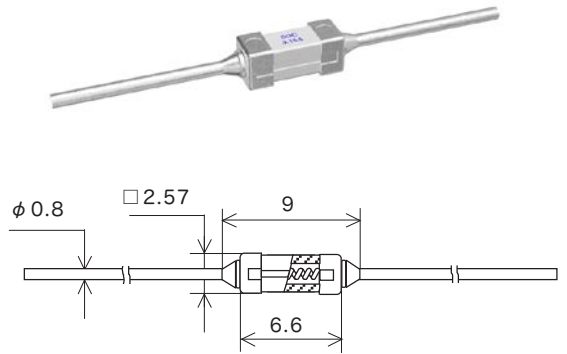
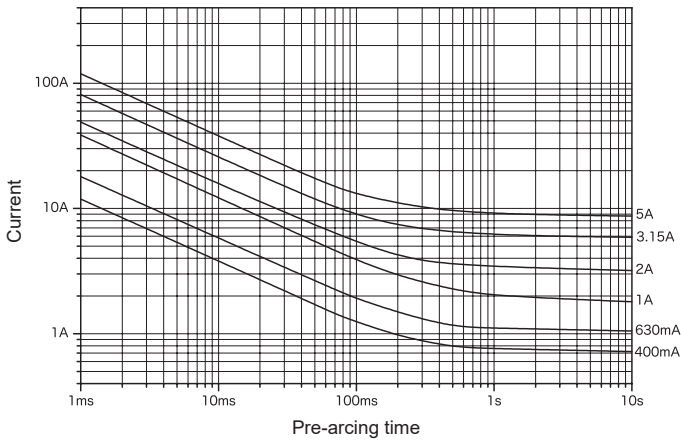

Scale: 2/1 (mm)

Rated voltage	Certification	Rated current (I <sub>N</sub> ) *1	Rated breaking current	Temp. rise	Current carrying capacity	Overload operation
AC 125 V	c UL US	100 mA–5 A	100 A	Resistive circuit	75 K or less at 1.0 I <sub>N</sub>	1.0 I <sub>N</sub> until temperature stabilization occurs
DC 125 V			300 A			

\*1: Customer-requested rated current values can be supplied from within the given range.

# P25RF

Protector

Quick-acting

RoHS-compliant

Pb free

Representative pre-arcing time-current characteristics

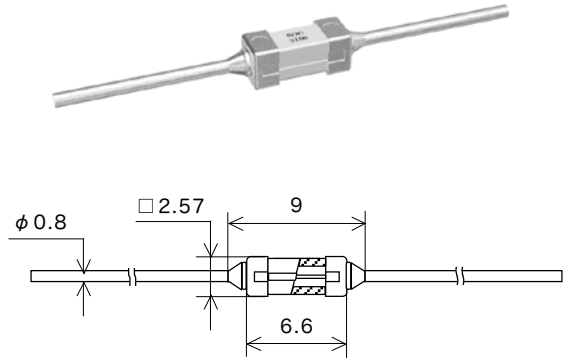
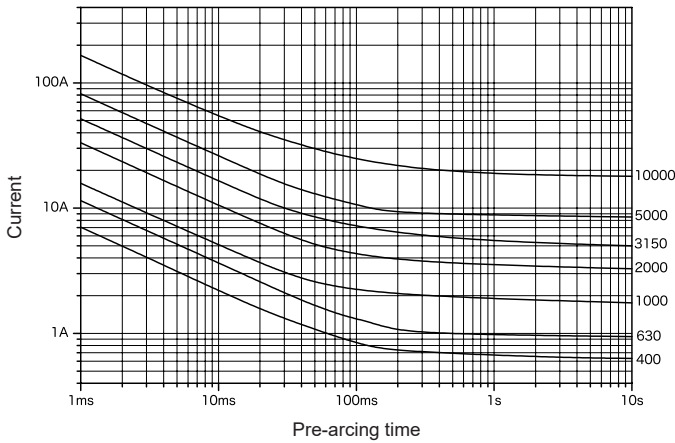

Scale: 2/1 (mm)

Maximum working voltage	Certification	Rated current ( $I_N$ ) <sup>*1</sup>	Maximum breaking current		Temp. rise	Current carrying capacity	Overload operation
AC 90 V DC 90 V	-	100 mA–10 A	50 A	Resistive circuit	75 K or less at 1.0 $I_N$	1.0 $I_N$ until temperature stabilization occurs	Within 60 s at 2.0 $I_N$

\*1: Customer-requested rated current values can be supplied from within the given range.

Note: The rated current (in amperes) multiplied by 1,000 is indicated on the product and its packaging (e.g., "630" for the 0.63 A version). The product name is the type name followed by this value.

# P25RT

Protector

Inrush-withstand

RoHS-compliant

Pb free

Representative pre-arcing time-current characteristics

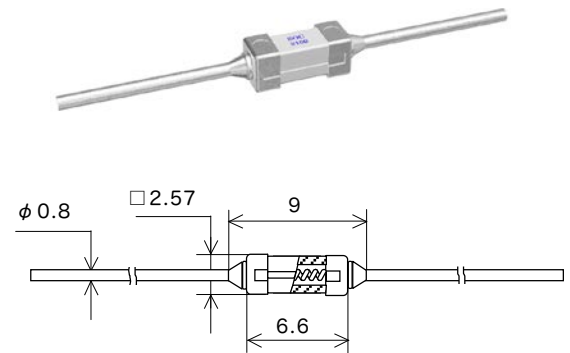
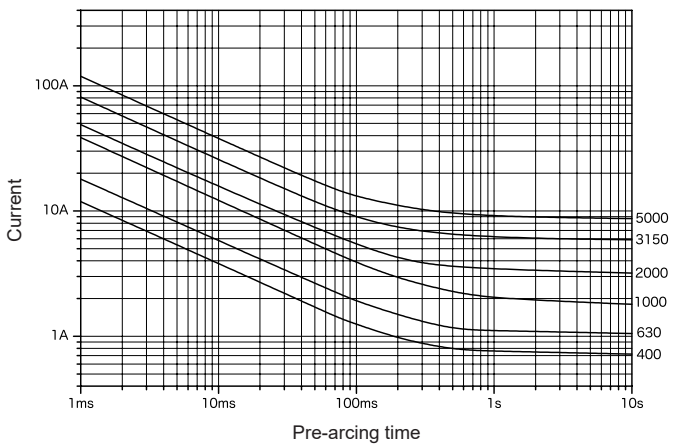

Scale: 2/1 (mm)

Maximum working voltage	Certification	Rated current ( $I_N$ ) <sup>*1</sup>	Maximum breaking current		Temp. rise	Current carrying capacity	Overload operation
AC 90 V DC 60 V	-	100 mA–6.3 A	50 A	Resistive circuit	75 K or less at 1.0 $I_N$	1.0 $I_N$ until temperature stabilization occurs	Within 60 s at 2.0 $I_N$

\*1: Customer-requested rated current values can be supplied from within the given range.

Note: The rated current (in amperes) multiplied by 1,000 is indicated on the product and its packaging (e.g., "630" for the 0.63 A version). The product name is the type name followed by this value.

# DC35VP25RF

Protector

Quick-acting

RoHS-compliant

Pb free

Representative pre-arcing time-current characteristics

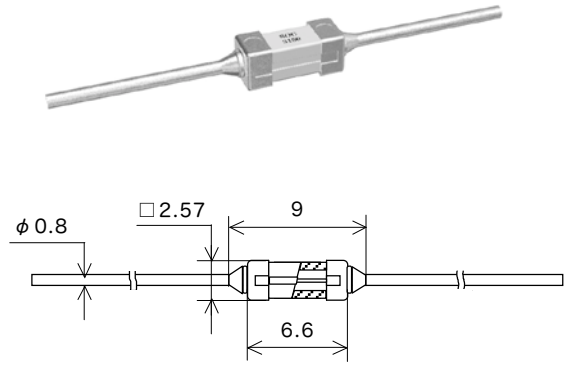
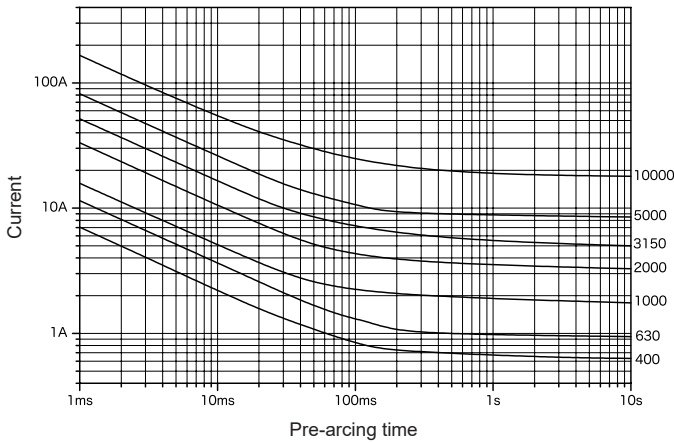

Scale: 2/1 (mm)

Maximum working voltage	Certification	Rated current ( $I_N$ ) *1	Maximum breaking current		Temp. rise	Current carrying capacity	Overload operation
DC 35 V	-	100 mA–10 A	50 A	Resistive circuit	75 K or less at 1.0 $I_N$	1.0 $I_N$ until temperature stabilization occurs	Within 60 s at 2.0 $I_N$

\*1: Customer-requested rated current values can be supplied from within the given range.

Note: The rated current (in amperes) multiplied by 1,000 is indicated on the product and its packaging (e.g., "630" for the 0.63 A version). The product name is the type name followed by this value.

# DC35VP25RT

Protector

Inrush-withstand

RoHS-compliant

Pb free

Representative pre-arcing time-current characteristics

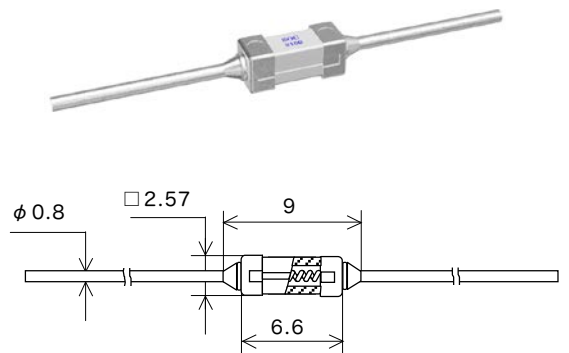
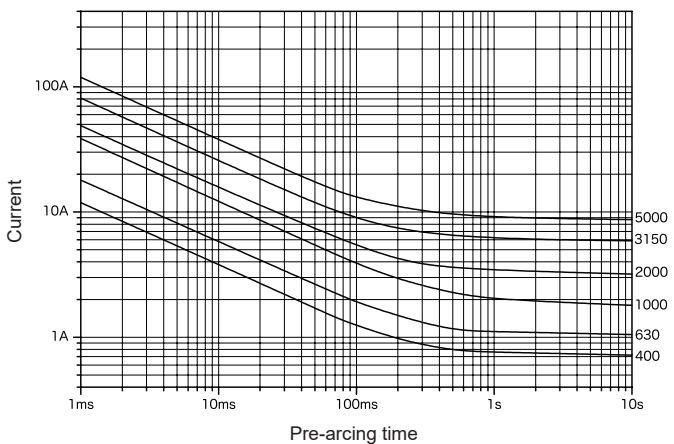

Scale: 2/1 (mm)

Maximum working voltage	Certification	Rated current ( $I_N$ ) *1	Maximum breaking current		Temp. rise	Current carrying capacity	Overload operation
DC 35 V	-	100 mA–6.3 A	50 A	Resistive circuit	75 K or less at 1.0 $I_N$	1.0 $I_N$ until temperature stabilization occurs	Within 60 s at 2.0 $I_N$

\*1: Customer-requested rated current values can be supplied from within the given range.

Note: The rated current (in amperes) multiplied by 1,000 is indicated on the product and its packaging (e.g., "630" for the 0.63 A version). The product name is the type name followed by this value.

Airtight construction is achieved through use of highly precise insert molding techniques. \*2

Representative pre-arcing time-current characteristics

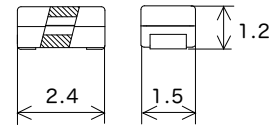
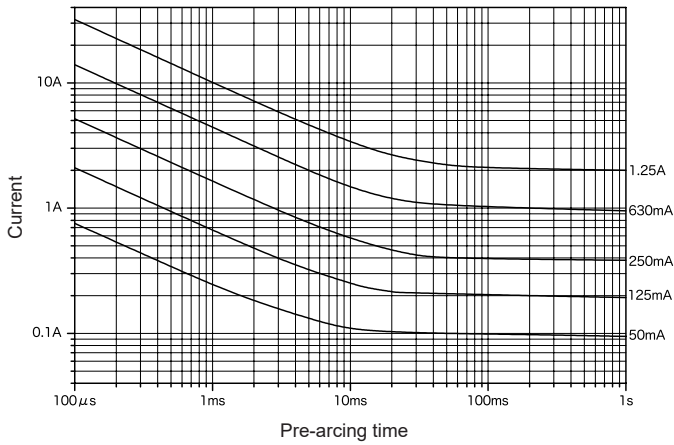

Land pattern for reflow soldering (reference dimensions)

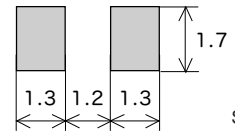

Scale: 5/1 (mm)

Rated voltage	Certification	Rated current (I <sub>N</sub> ) *1	Rated breaking current	Temp. rise	Current carrying capacity	Overload operation
AC 32 V		28 mA–250 mA	50 A	75 K or less at 1.0 I <sub>N</sub>	1.0 I <sub>N</sub> until temperature stabilization occurs	Within 60 s at 2.0 I <sub>N</sub>
DC 72 V						
AC 25 V		260 mA–1 A	Resistive circuit			
DC 32 V			PF 0.95–1			
AC 12.5 V		1.1 A–2.5 A	Resistive circuit			
DC 25 V			PF 0.95–1			

\*1: Customer-requested rated current values can be supplied from within the given range.

\*2: This product satisfies the requirements of IEC 60079-11 10.6.2.



Intentionally blank

Intentionally blank

Representative pre-arcing time-current characteristics

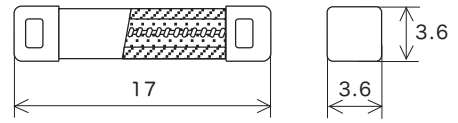
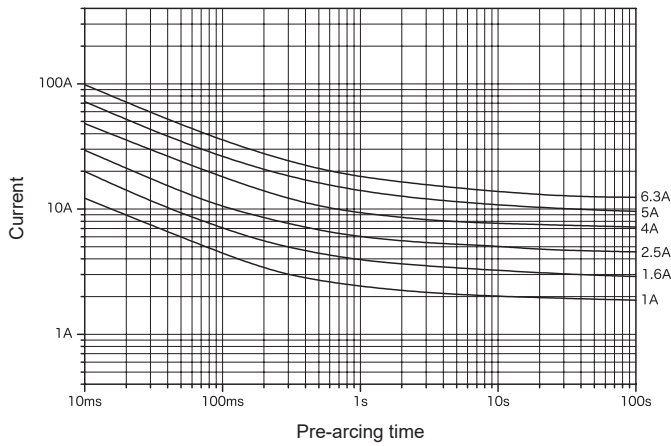

Land pattern for reflow soldering (reference dimensions)

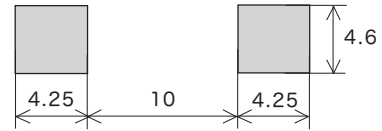

Scale: 2/1 (mm)

Rated voltage	Certification	Rated current ( $I_N$ )	Rated breaking current		Temp. rise	Current carrying capacity / Endurance test	Overload operation
AC 250 V		1A–6.3 A *1	1500 A	PF 0.7–0.8	75 K or less at 1.0 $I_N$	1.0 $I_N$ until temperature stabilization occurs	Within 2 min at 2.0 $I_N$
		1 A 1.25 A 1.6 A 2 A 2.5 A 3.15 A 4 A 5 A 6.3 A			*2	*3	Within 2 min at 2.0 $I_N$ 0.01 s–0.1 s at 10 $I_N$
		1A–6.3 A *1			500 A	At 1.0 $I_N$ , 140 K or less at the center, 60 K or less at the contact	1.0 $I_N$ until constant temperature is obtained on each part
DC 300 V		200 A	Resistive circuit	75 K or less at 1.0 $I_N$	1.0 $I_N$ until temperature stabilization occurs		

\*1: Customer-requested rated current values can be supplied from within the given range.

\*2: The temperature rise of the terminals is 95 K or less when measured during the last five minutes of carrying a 1.25  $I_N$  current for endurance testing.

\*3: Endurance test: After 100 cycles of 1.05  $I_N$  1 h on / 15 min off, 1.25  $I_N$  is passed through the fuse for 1 h.

Representative pre-arcing time-current characteristics

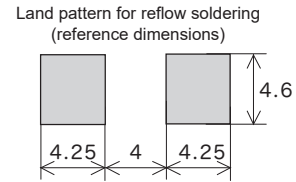
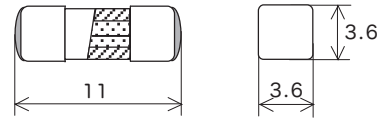
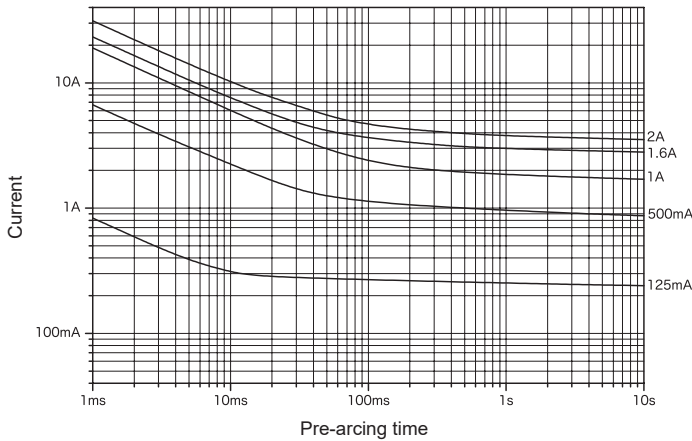

Scale: 2/1 (mm)

Rated voltage	Certification	Rated current ( $I_N$ )	Rated breaking current		Temp. rise	Current carrying capacity	Overload operation
DC 600 V		63 mA–3.15 A *1	100 A	Resistive circuit	75 K or less at 1.0 $I_N$	1.0 $I_N$ until temperature stabilization occurs	Within 60 s at 2.0 $I_N$
DC 425 V		4 A					

\*1: Customer-requested rated current values can be supplied from within the given range.

\*2: This product uses high melting temperature type solder containing 85% by weight or more lead. This type of solder is exempted from the RoHS Directive.

# SMC N4

Pre-arcing time-current characteristics

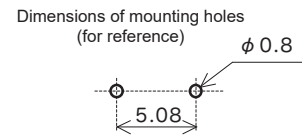
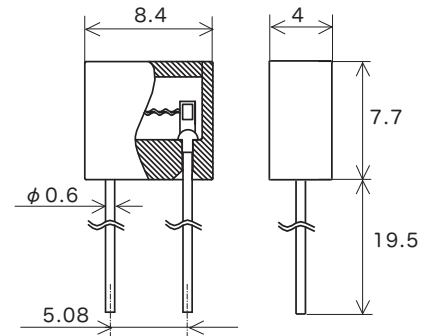
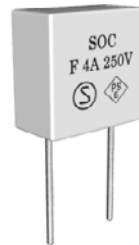
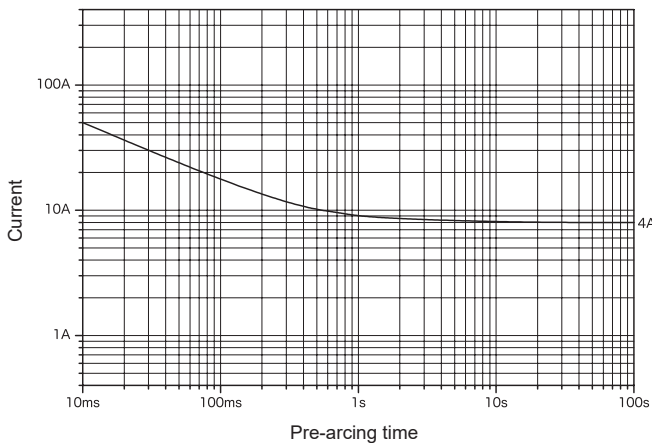

Scale: 2/1 (mm)

Rated voltage	Certification	Rated current ( $I_N$ )	Rated breaking current		Temp. rise	Endurance test / Current carrying capacity	Pre-arcing time-current characteristics
AC 250 V		4 A	40 A	PF over 0.95	*1	*2	*3
			50 A		75 K or less at 1.0 $I_N$	1.0 $I_N$ until temperature stabilization occurs	Within 30 min at 2.1 $I_N$

\*1: After passing 1.5  $I_N$  through 15 min, the current is increased by 0.1  $I_N$  every 15 min until the fuse operates. While the current is being increased, the temperature rise at each part of the fuse shall not exceed 135 K.

\*2: After repeating 100 cycles of the rated current 1 h on / 15 min off, 1.5  $I_N$  is passed through the fuse for 1 h.

*3:	2.1 $I_N$	2.75 $I_N$	4.0 $I_N$	10 $I_N$
	Within 30 min	0.01 s–3 s	0.003 s–0.3 s	Within 0.02 s

Representative pre-arcing time-current characteristics

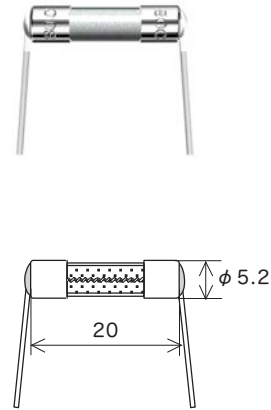
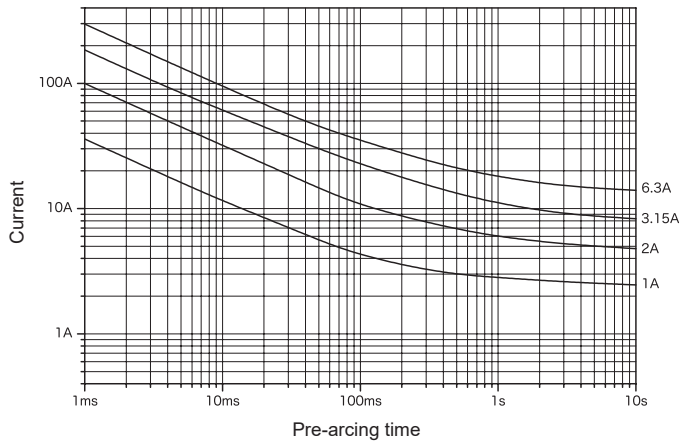

Lead wire diameter  $\phi$  0.8

Scale: 1/1 (mm)

Rated voltage	Certification	Rated current ( $I_N$ ) *1	Rated breaking current	Temp. rise	Current carrying capacity	Overload operation
AC 380 V		1 A–6.3 A	500 A	Resistive circuit	75 K or less at 1.0 $I_N$	1.0 $I_N$ until temperature stabilization occurs
AC 300 V				PF 0.7–0.8	At 1.0 $I_N$ , 140 K or less at the center, 60 K or less at the contact	1.0 $I_N$ until constant temperature is obtained on each part

\*1: Customer-requested rated current values can be supplied from within the given range.

\*2: This product uses high melting temperature type solder containing 85% by weight or more lead. This type of solder is exempted from the RoHS Directive.

Representative pre-arcing time-current characteristics

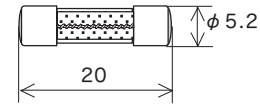
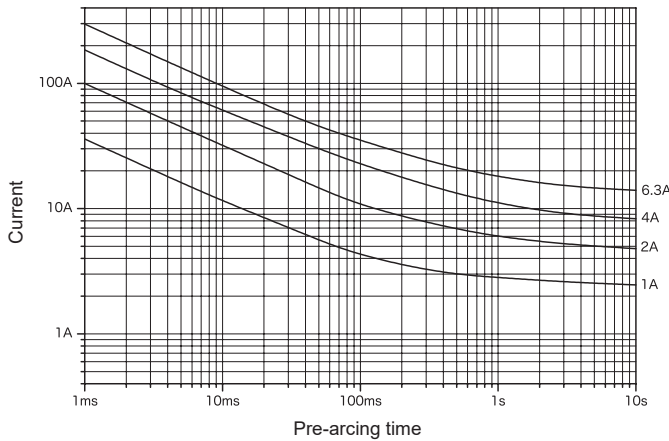

Scale: 1/1 (mm)

Rated voltage	Certification	Rated current (I <sub>N</sub> ) *1	Rated breaking current	Temp. rise	Current carrying capacity	Overload operation
AC 380 V		1 A–6.3 A	500 A	Resistive circuit	75 K or less at 1.0 I <sub>N</sub>	1.0 I <sub>N</sub> until temperature stabilization occurs
AC 300 V				PF 0.7–0.8	At 1.0 I <sub>N</sub> , 140 K or less at the center, 60 K or less at the contact	

\*1: Customer-requested rated current values can be supplied from within the given range.

\*2: This product uses high melting temperature type solder containing 85% by weight or more lead. This type of solder is exempted from the RoHS Directive.

Representative pre-arcing time-current characteristics

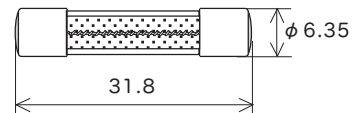
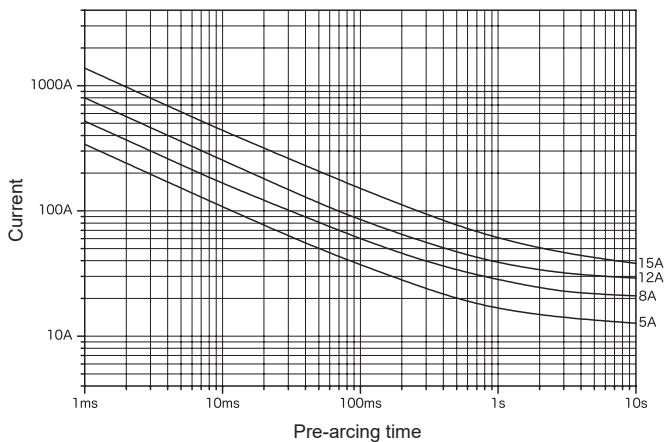

Scale: 1/1 (mm)

Rated voltage	Certification	Rated current (I <sub>N</sub> ) *1	Rated breaking current	Temp. rise	Current carrying capacity	Overload operation
AC 500 V		1 A–10 A	500 A	75 K or less at 1.0 I <sub>N</sub>	1.0 I <sub>N</sub> until temperature stabilization occurs	Within 60 min at 2.1 I <sub>N</sub>
AC 380 V		Over 10 A–20 A				
AC 300 V		1 A–20 A		PF 0.7–0.8	–	

\*1: Customer-requested rated current values can be supplied from within the given range.

\*2: 1 A–6.3 A Pb free  
Over 6.3 A–20 A This product uses high melting temperature type solder containing 85% by weight or more lead. This type of solder is exempted from the RoHS Directive.

Representative pre-arcing time-current characteristics

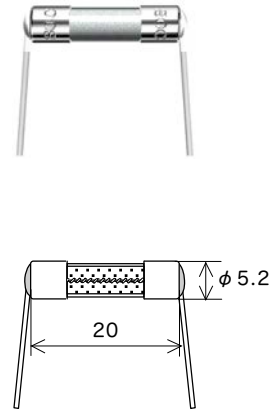
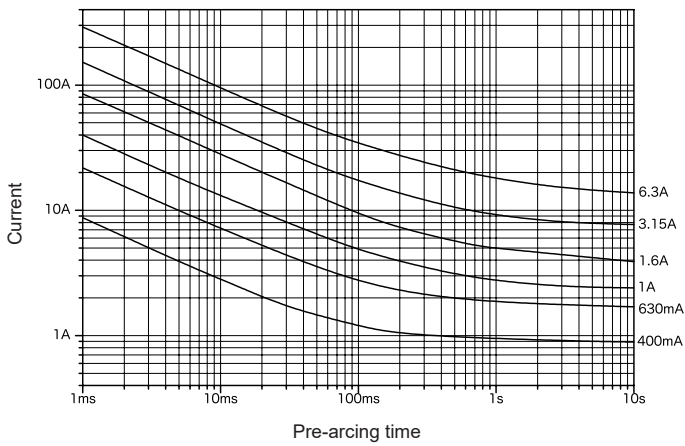

Lead wire diameter  $\phi$  0.8

Scale: 1/1 (mm)

Rated voltage	Certification	Rated current ( $I_N$ ) *1	Rated breaking current	Temp. rise	Current carrying capacity	Overload operation
AC 400 V		100 mA–6.3 A	500 A	Resistive circuit	75 K or less at 1.0 $I_N$	1.0 $I_N$ until temperature stabilization occurs
DC 400 V			200 A			
	- *3	100 mA–2.5 A	1500 A			

\*1: Customer-requested rated current values can be supplied from within the given range.

\*2: This product uses high melting temperature type solder containing 85% by weight or more lead. This type of solder is exempted from the RoHS Directive.

\*3: This specification is based on SOC internal testing.

## Representative pre-arcing time-current characteristics

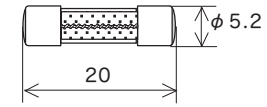
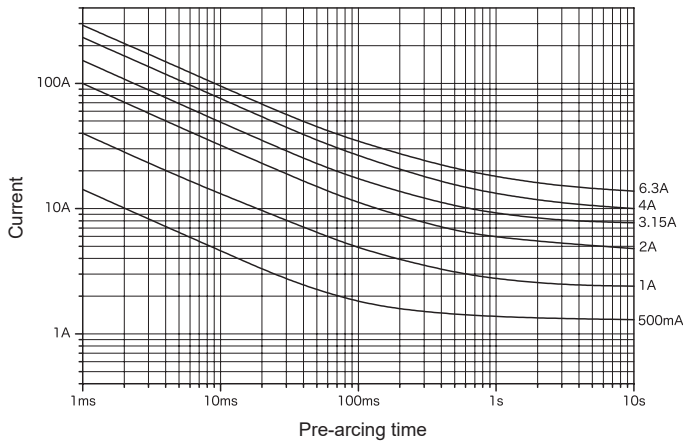

Scale: 1/1 (mm)

Rated voltage	Certification	Rated current ( $I_N$ )	Rated breaking current	Temp. rise	Current carrying capacity / Endurance test	Pre-arcing time-current characteristics
AC 500 V		100 mA–6.3 A *1	80 A	75 K or less at 1.0 $I_N$	1.0 $I_N$ until temperature stabilization occurs	Within 30 min at 2.1 $I_N$
AC 400 V			500 A			
DC 400 V		1 A, 1.6 A, 2 A 3 A, 3.15 A, 4 A 5 A, 6.3 A	200 A	-	*3	*4
			1500 A			
DC 250 V		100 mA–6.3 A *1	2000 A	75 K or less at 1.0 $I_N$	1.0 $I_N$ until temperature stabilization occurs	Within 30 min at 2.1 $I_N$

\*1: Customer-requested rated current values can be supplied from within the given range.

\*2: This product uses high melting temperature type solder containing 85% by weight or more lead. This type of solder is exempted from the RoHS Directive.

\*3: Endurance Test: After 100 cycles of 1.2  $I_N$  1 h on / 15 min off, 1.5  $I_N$  is passed through the fuse for 1 h.

Rated current	2.1 $I_N$	2.75 $I_N$	4.0 $I_N$	10 $I_N$
1 A	Within 30 min	0.3 s–2 s	0.095 s–0.5 s	0.01 s–0.03 s
1.6 A, 2 A		1 s–30 s	0.095 s–1 s	0.01 s–0.05 s
3 A, 3.15 A 4 A, 5 A, 6.3 A			0.15 s–1 s	0.02 s–0.1 s



### Representative pre-arcing time-current characteristics

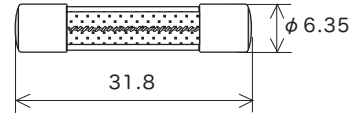
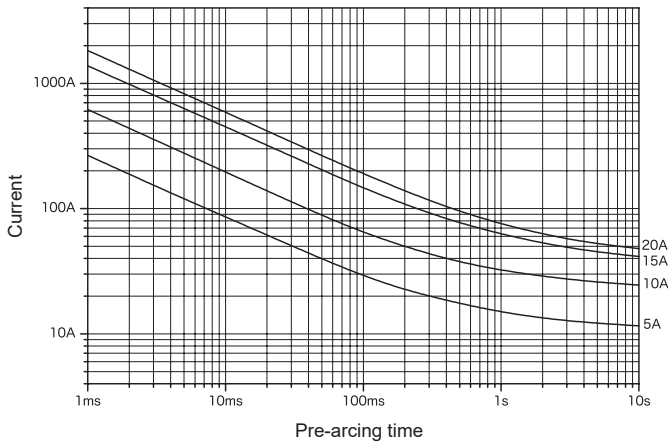

Scale: 1/1 (mm)

Rated voltage	Certification	Rated current ( $I_N$ )	Rated breaking current		Temp. rise	Current carrying capacity / Endurance test	Pre-arcing time-current characteristics
AC 400 V DC 400 V		1 A–20 A *1	500 A	Resistive circuit	75 K or less at 1.0 $I_N$	1.0 $I_N$ until temperature stabilization occurs	Within 30 min at 2.1 $I_N$
		10 A 15 A 20 A			–	*3	*4

\*1: Customer-requested rated current values can be supplied from within the given range.

\*2: This product uses high melting temperature type solder containing 85% by weight or more lead. This type of solder is exempted from the RoHS Directive.

\*3: Endurance Test: After 100 cycles of 1.2  $I_N$  1 h on / 15 min off, 1.5  $I_N$  is passed through the fuse for 1 h.

*4:	2.1 $I_N$	2.75 $I_N$	4.0 $I_N$	10 $I_N$
	Within 30 min	1 s–80 s	0.15 s–5 s	0.02 s–0.1 s

Representative pre-arcing time-current characteristics

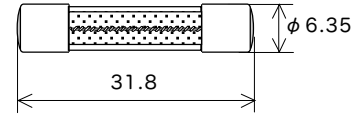
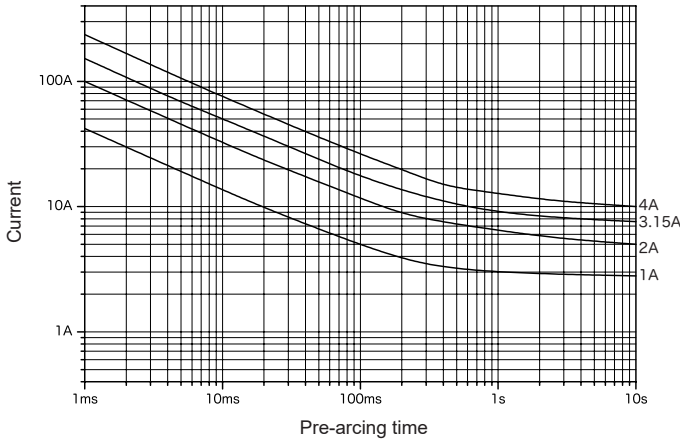

Scale: 1/1 (mm)

Rated voltage	Certification	Rated current (I <sub>N</sub> ) *1	Rated breaking current		Temp. rise	Current carrying capacity	Overload operation
DC 700 V		1 A–4 A	500 A	Resistive circuit	75 K or less at 1.0 I <sub>N</sub>	1.0 I <sub>N</sub> until temperature stabilization occurs	Within 30 min at 2.1 I <sub>N</sub>

\*1: Customer-requested rated current values can be supplied from within the given range.  
 \*2: This product uses high melting temperature type solder containing 85% by weight or more lead. This type of solder is exempted from the RoHS Directive.

Representative pre-arcing time-current characteristics

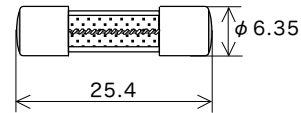
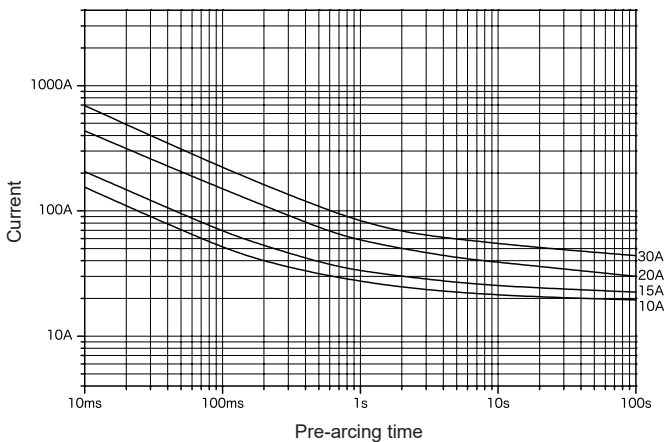

Scale: 1/1 (mm)

Rated voltage	Certification	Rated current (I <sub>N</sub> ) *1	Rated breaking current		Temp. rise	Current carrying capacity	Overload operation
DC 500 V		1 A–30 A	1000 A	Resistive circuit	–	1.0 I <sub>N</sub> until temperature stabilization occurs	Within 30 min at 2.1 I <sub>N</sub>

\*1: Customer-requested rated current values can be supplied from within the given range.  
 \*2: This product uses high melting temperature type solder containing 85% by weight or more lead. This type of solder is exempted from the RoHS Directive.

# SHV20

Inrush-withstand

RoHS-compliant

Pb free

Representative pre-arcing time-current characteristics

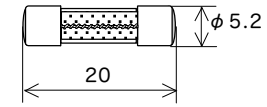
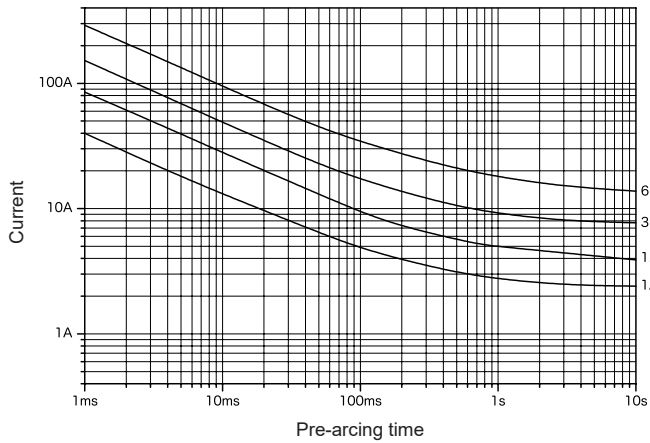

Scale: 1/1 (mm)

Rated voltage	Certification	Rated current ( $I_N$ ) *1	Rated breaking current		Temp. rise	Current carrying capacity	Overload operation
DC 450 V		500 mA–6.3 A	200 A	Resistive circuit	75 K or less at 1.0 $I_N$	1.0 $I_N$ until temperature stabilization occurs	Within 30 min at 2.1 $I_N$

\*1: Customer-requested rated current values can be supplied from within the given range.

# SHV22

Inrush-withstand

RoHS-compliant\*2

Pb free\*2

Representative pre-arcing time-current characteristics

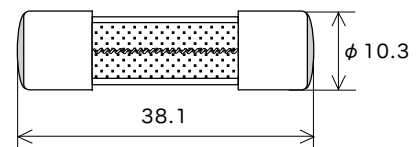
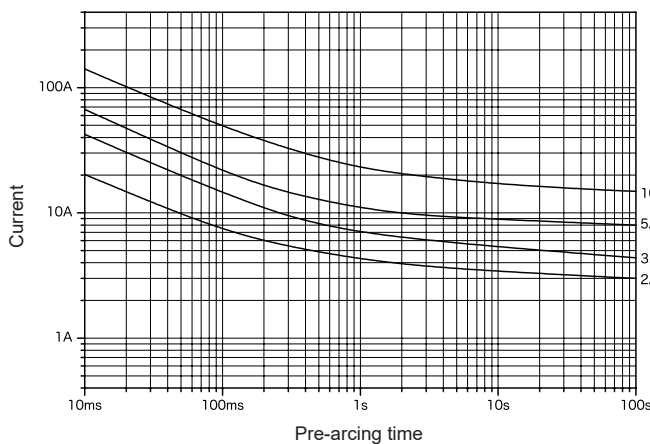

Scale: 1/1 (mm)

Rated voltage	Certification	Rated current ( $I_N$ ) *1	Rated breaking current		Temp. rise	Current carrying capacity	Overload operation
DC 500 V		1 A–10 A	1000 A	Resistive circuit	75 K or less at 1.0 $I_N$	1.0 $I_N$ until temperature stabilization occurs	Within 60 min at 1.35 $I_N$ Within 2 min at 2.0 $I_N$

\*1: Customer-requested rated current values can be supplied from within the given range.

\*2: 1 A–5 A Pb free  
Over 5 A–10 A This product uses high melting temperature type solder containing 85% by weight or more lead. This type of solder is exempted from the RoHS Directive.

Representative pre-arcing time-current characteristics

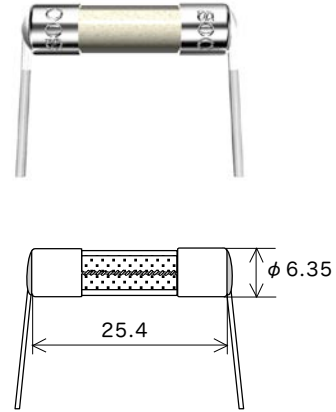
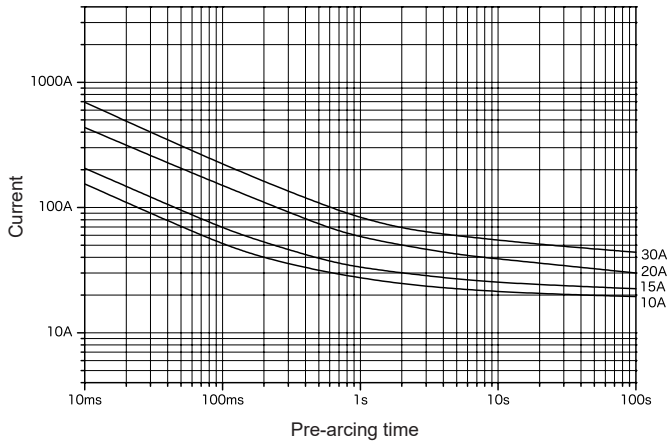

Lead wire diameter  $\phi$  1.2

Scale: 1/1 (mm)

Rated voltage	Certification	Rated current ( $I_N$ ) *1	Rated breaking current		Temp. rise	Current carrying capacity	Overload operation
DC 450 V		6.3 A	400 A	Resistive circuit	120 K or less at 1.0 $I_N$	1.0 $I_N$ until temperature stabilization occurs	Within 30 min at 2.1 $I_N$
DC 420 V		8 A–30 A					

\*1: Customer-requested rated current values can be supplied from within the given range.

\*2: This product uses high melting temperature type solder containing 85% by weight or more lead. This type of solder is exempted from the RoHS Directive.

Representative pre-arcing time-current characteristics

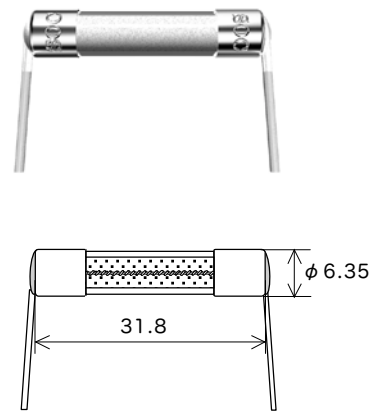
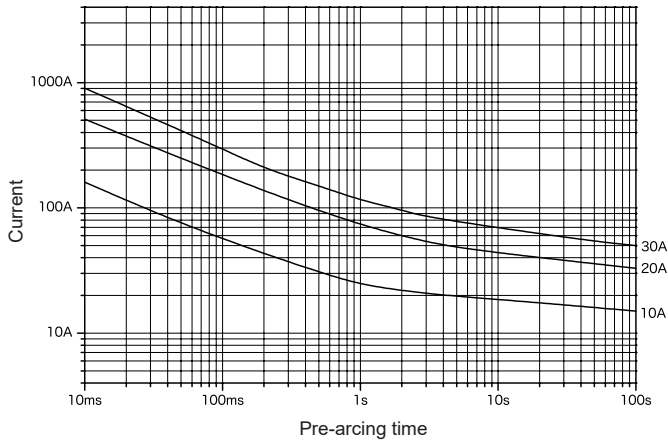

Lead wire diameter  $\phi$  1.0 (10 A)  
 $\phi$  1.2 (Over 10 A–30 A)

Scale: 1/1 (mm)

Rated voltage	Certification	Rated current ( $I_N$ ) *1	Rated breaking current		Temp. rise	Current carrying capacity	Overload operation
AC 500 V		10 A–30 A	500 A	Resistive circuit	150 K or less at 1.0 $I_N$	1.0 $I_N$ until temperature stabilization occurs	Within 2 min at 2.0 $I_N$

\*1: Customer-requested rated current values can be supplied from within the given range.

\*2: This product uses high melting temperature type solder containing 85% by weight or more lead. This type of solder is exempted from the RoHS Directive.

# NSHV3

Protector

Inrush-withstand

RoHS-compliant\*2

Pb free\*2

Representative pre-arcing time-current characteristics

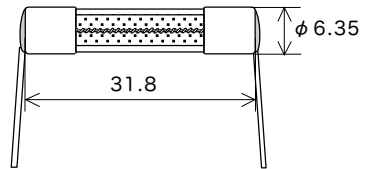
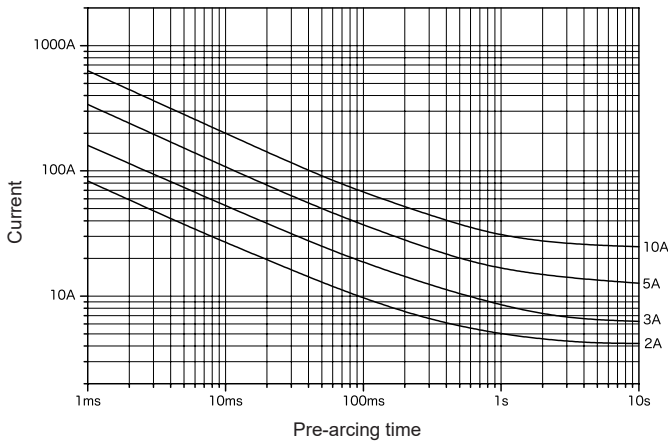

Lead wire diameter  $\phi$  1.0 Scale: 1/1 (mm)

Maximum working voltage	Certification	Rated current ( $I_N$ ) *1	Maximum breaking current		Temp. rise	Current carrying capacity	Overload operation
AC 500 V	-	1 A–10 A	500 A	Resistive circuit	75 K or less at 1.0 $I_N$	-	Within 60 min at 2.1 $I_N$

\*1: Customer-requested rated current values can be supplied from within the given range.

\*2: 1 A–6.3 A Pb free

Over 6.3 A–10 A This product uses high melting temperature type solder containing 85% by weight or more lead. This type of solder is exempted from the RoHS Directive.

# NSHV13

Protector

Inrush-withstand

RoHS-compliant\*2

Representative pre-arcing time-current characteristics

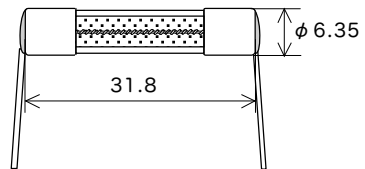
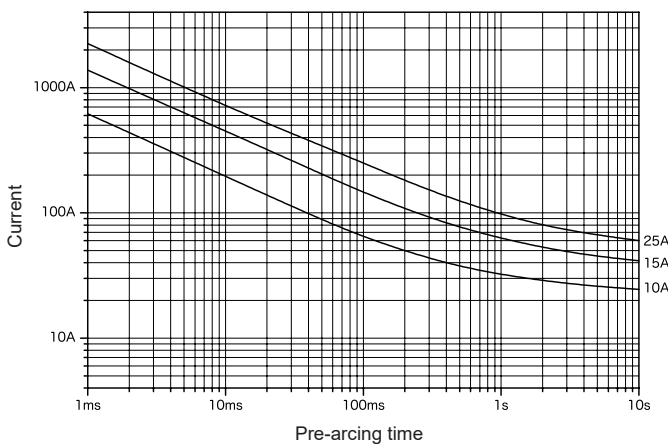

Lead wire diameter  $\phi$  0.8 (5 A to less than 10 A)  
 $\phi$  1.0 (10 A–15 A)  
 $\phi$  1.2 (Over 15 A–25 A) Scale: 1/1 (mm)

Maximum working voltage	Certification	Rated current ( $I_N$ ) *1	Maximum breaking current		Temp. rise	Endurance test	Overload operation
AC 400 V DC 400 V	-	5 A–25 A	500 A	Resistive circuit	75 K or less at 1.0 $I_N$	*3	Within 30 min at 2.1 $I_N$

\*1: Customer-requested rated current values can be supplied from within the given range.

\*2: This product uses high melting temperature type solder containing 85% by weight or more lead. This type of solder is exempted from the RoHS Directive.

\*3: After 100 cycles of 1.2  $I_N$  1 h on / 15 min off, 1.5  $I_N$  is passed through the fuse for 1 h.

Representative pre-arcing time-current characteristics

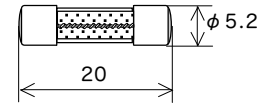
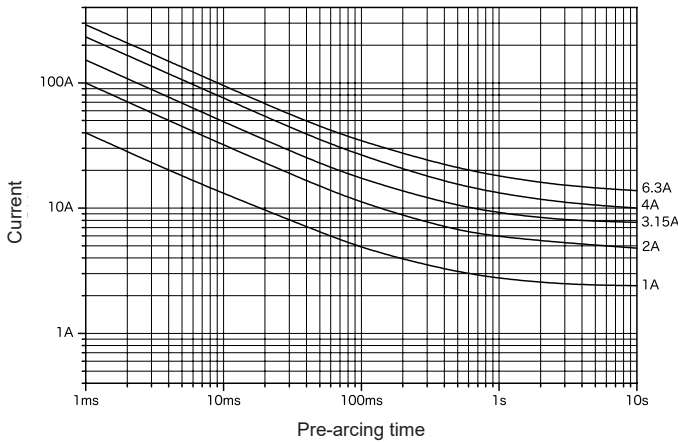

Scale: 1/1 (mm)

Maximum working voltage	Certification	Rated current ( $I_N$ ) <sup>*1</sup>	Maximum breaking current		Temp. rise	Current carrying capacity / Endurance test	Overload operation
DC 450 V	-	100 mA to less than 1 A	200 A	Resistive circuit	75 K or less at 1.0 $I_N$	1.0 $I_N$ until temperature stabilization occurs	Within 30 min at 2.1 $I_N$
		1 A–6.3 A			-	<sup>*3</sup>	<sup>*4</sup>

<sup>\*1</sup>: Customer-requested rated current values can be supplied from within the given range.

<sup>\*2</sup>: This product uses high melting temperature type solder containing 85% by weight or more lead. This type of solder is exempted from the RoHS Directive.

<sup>\*3</sup>: Endurance Test: After 100 cycles of 1.2  $I_N$  1 h on / 15 min off, 1.5  $I_N$  is passed through the fuse for 1 h.

<sup>\*4</sup>:

Rated current	2.1 $I_N$	2.75 $I_N$	4.0 $I_N$	10 $I_N$
1 A	Within 30 min	0.3 s–2 s	0.095 s–0.5 s	0.01 s–0.03 s
1.25 A–2.5 A		1 s–30 s	0.095 s–1 s	0.01 s–0.05 s
3 A–6.3 A			0.15 s–1 s	0.02 s–0.1 s

Pre-arcing time-current characteristics

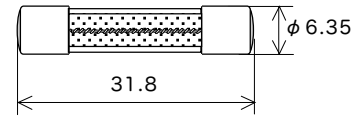
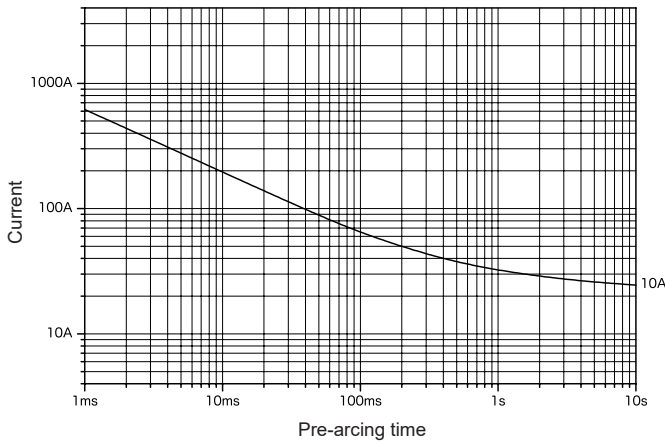

Scale: 1/1 (mm)

Maximum working voltage	Certification	Rated current ( $I_N$ )	Maximum breaking current		Temp. rise	Endurance test	Overload operation
DC 500 V	-	10 A	30 A	Resistive circuit	75 K or less at 1.0 $I_N$	*2	Within 30 min at 2.1 $I_N$

\*1: This product uses high melting temperature type solder containing 85% by weight or more lead. This type of solder is exempted from the RoHS Directive.  
 \*2: After 100 cycles of 1.2  $I_N$  1 h on / 15 min off, 1.5  $I_N$  is passed through the fuse for 1 h.

Representative pre-arcing time-current characteristics

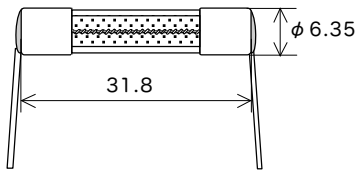
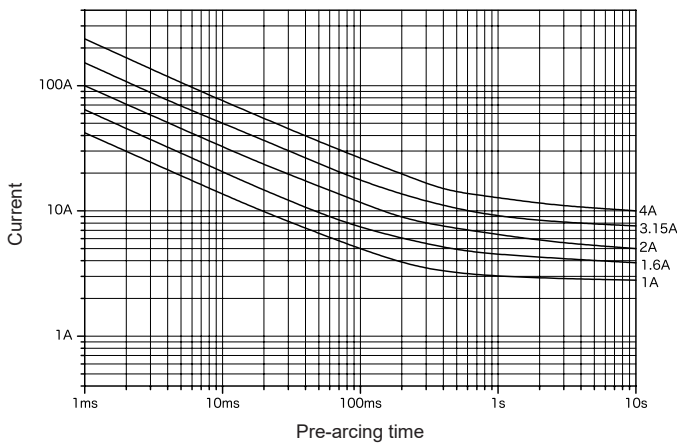

Lead wire diameter  $\phi$  0.8  
 Scale: 1/1 (mm)

Maximum working voltage	Certification	Rated current ( $I_N$ ) *1	Maximum breaking current		Temp. rise	Current carrying capacity	Overload operation
DC 700 V	-	1 A–4 A	500 A	Resistive circuit	75 K or less at 1.0 $I_N$	1.0 $I_N$ until temperature stabilization occurs	Within 30 min at 2.1 $I_N$

\*1: Customer-requested rated current values can be supplied from within the given range.  
 \*2: This product uses high melting temperature type solder containing 85% by weight or more lead. This type of solder is exempted from the RoHS Directive.

Representative pre-arcing time-current characteristics

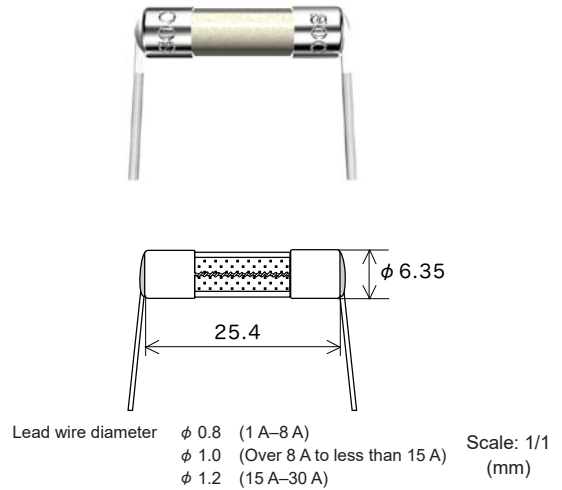
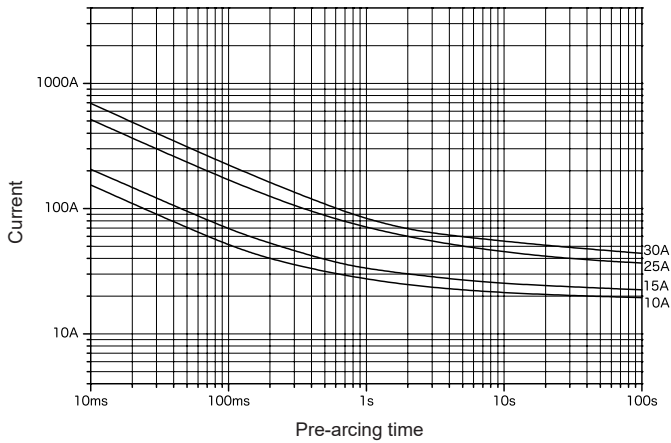

Maximum working voltage	Certification	Rated current (I <sub>N</sub> ) *1	Maximum breaking current		Temp. rise	Current carrying capacity	Overload operation
DC 500 V	-	1 A-30 A	1000 A	Resistive circuit	75 K or less at 0.5 I <sub>N</sub>	1.0 I <sub>N</sub> until temperature stabilization occurs	Within 2 min at 2.0 I <sub>N</sub>

\*1: Customer-requested rated current values can be supplied from within the given range.

\*2: This product uses high melting temperature type solder containing 85% by weight or more lead. This type of solder is exempted from the RoHS Directive.

Representative pre-arcing time-current characteristics

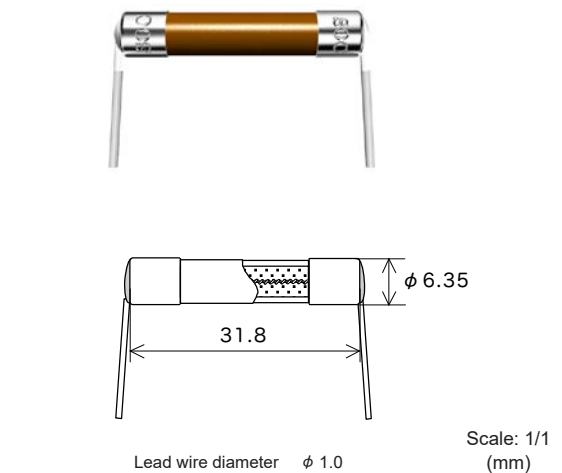
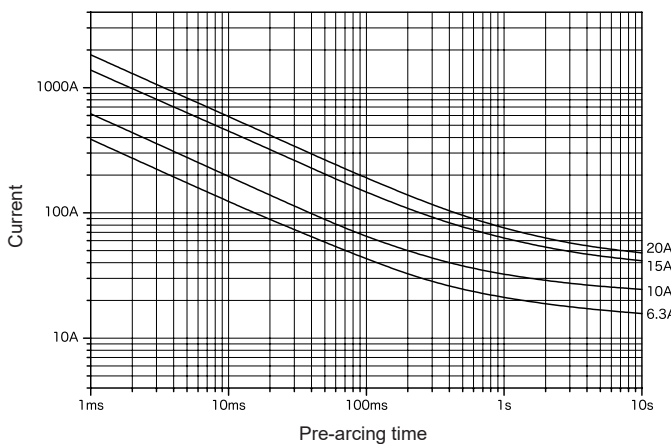

Maximum working voltage	Certification	Rated current (I <sub>N</sub> ) *1	Maximum breaking current		Temp. rise	Endurance Test	Overload operation
AC 400 V DC 400 V	-	1 A-20 A	500 A	Resistive circuit	75 K or less at 1.0 I <sub>N</sub>	*3	Within 30 min at 2.1 I <sub>N</sub>

\*1: Customer-requested rated current values can be supplied from within the given range.

\*2: This product uses high melting temperature type solder containing 85% by weight or more lead. This type of solder is exempted from the RoHS Directive.

\*3: After 100 cycles of 1.2 I<sub>N</sub> 1 h on / 15 min off, 1.5 I<sub>N</sub> is passed through the fuse for 1 h.



# DC450VPT2035

RoHS-compliant Pb free

Representative pre-arcing time-current characteristics

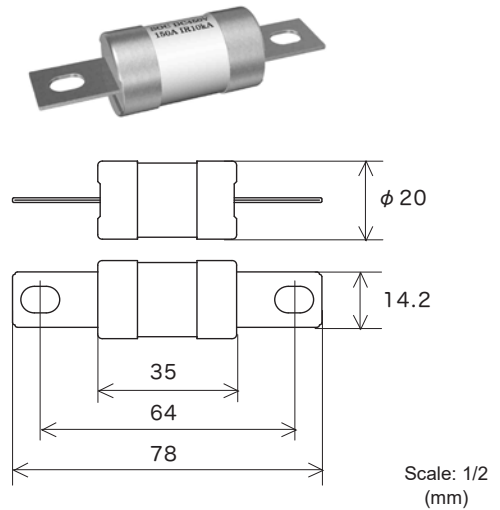
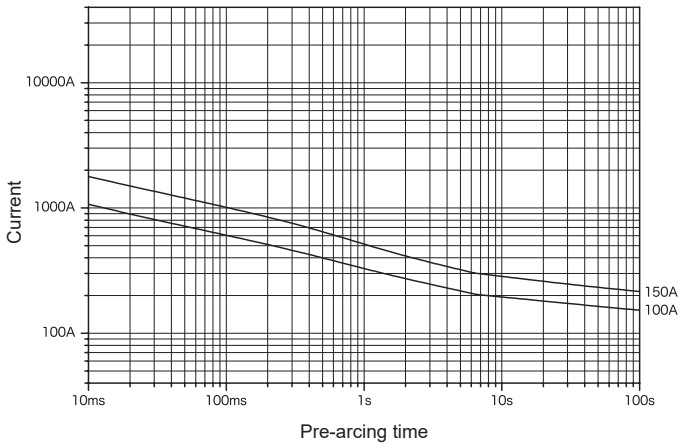

Rated voltage	Certification	Rated current ( $I_N$ ) *1	Rated breaking current	Min. breaking current	Temp. rise	Overload operation
DC 450 V	-	100 A 125 A 150 A	10000 A Resistive circuit	2.0 $I_N$	50 K or less at 0.5 $I_N$	*2

\*1: Please contact your local SOC sales representative for rated currents which are not listed.

\*2:

2.0 $I_N$	3.0 $I_N$	5.0 $I_N$
1 s–300 s	0.2 s–30 s	0.05 s–1 s

# DC450VPT2545

RoHS-compliant Pb free

Representative pre-arcing time-current characteristics

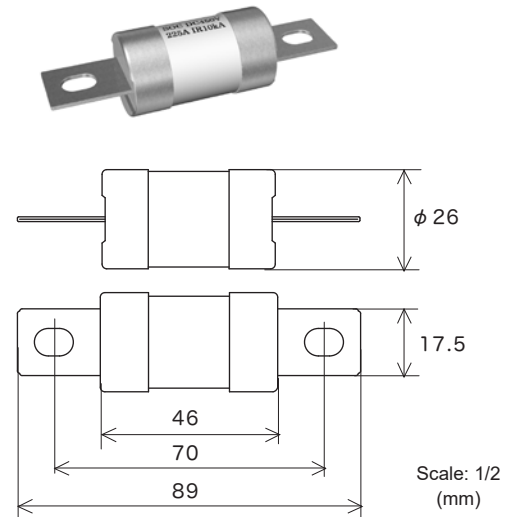
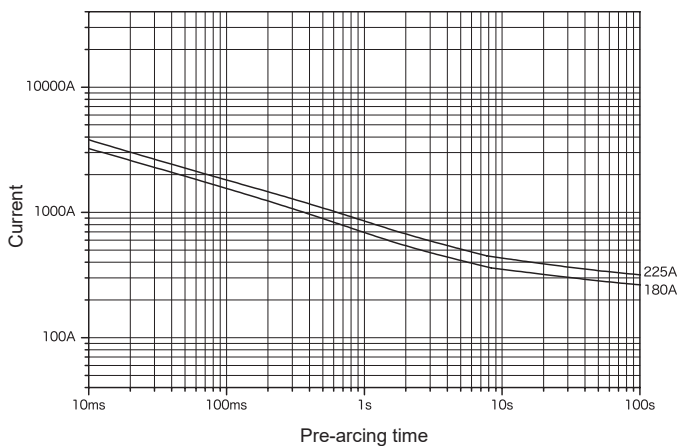

Rated voltage	Certification	Rated current ( $I_N$ ) *1	Rated breaking current	Min. breaking current	Temp. rise	Overload operation
DC 450 V	-	180 A 200 A 225 A	10000 A Resistive circuit	2.0 $I_N$	50 K or less at 0.5 $I_N$	*2

\*1: Please contact your local SOC sales representative for rated currents which are not listed.

\*2:

2.0 $I_N$	3.0 $I_N$	5.0 $I_N$
1 s–300 s	0.2 s–30 s	0.05 s–1 s

# DC450VPT3050

RoHS-compliant

Pb free

Representative pre-arcing time-current characteristics

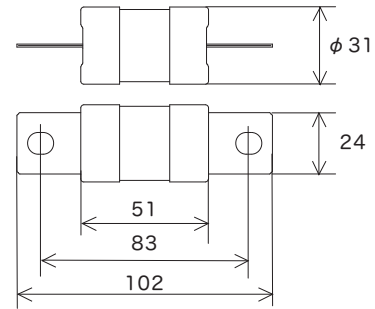
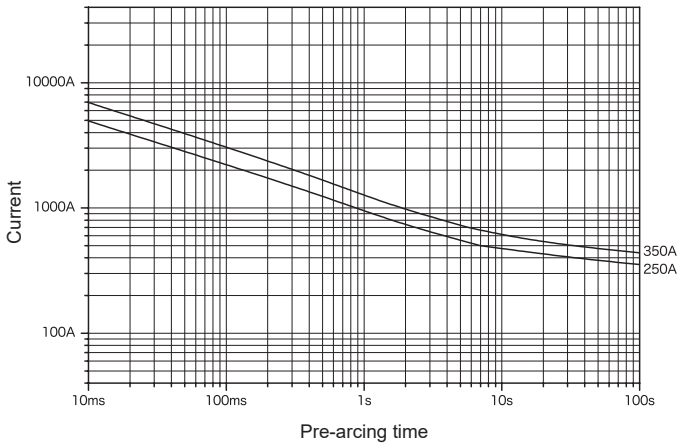

Scale: 1/3 (mm)

Rated voltage	Certification	Rated current ( $I_N$ ) <sup>*1</sup>	Rated breaking current	Min. breaking current	Temp. rise	Overload operation
DC 450 V	-	250 A 300 A 350 A	16000 A Resistive circuit	2.0 $I_N$	50 K or less at 0.5 $I_N$	<sup>*2</sup>

<sup>\*1</sup>: Please contact your local SOC sales representative for rated currents which are not listed.

<sup>\*2</sup>:

2.0 $I_N$	3.0 $I_N$	5.0 $I_N$
1 s–300 s	0.2 s–30 s	0.05 s–1 s

# DC500VBC625A

RoHS-compliant<sup>\*2</sup>

Representative pre-arcing time-current characteristics

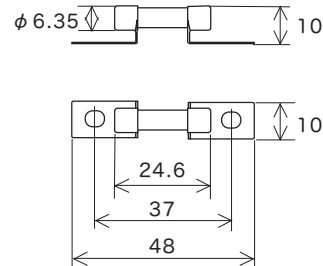
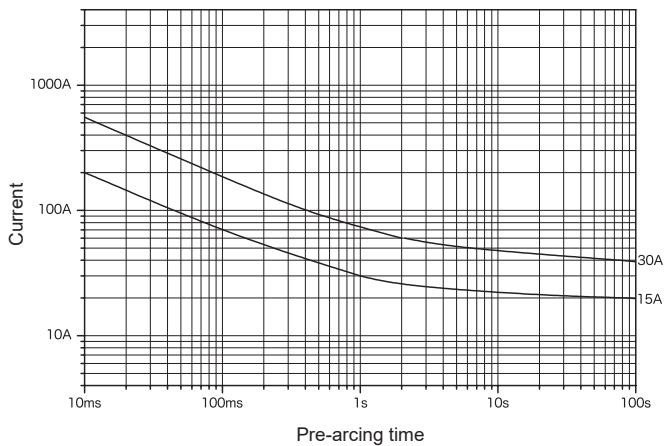

Scale: 1/2 (mm)

Rated voltage	Certification	Rated current ( $I_N$ ) <sup>*1</sup>	Rated breaking current	Min. breaking current	Temp. rise	Current carrying capacity	Overload operation
DC 500 V	-	5 A, 10 A, 15 A 20 A, 25 A 30 A, 35 A	1000 A Resistive circuit	2.0 $I_N$	75 K or less at 0.5 $I_N$	1.0 $I_N$ until temperature stabilization occurs	Within 2 min at 2.0 $I_N$

<sup>\*1</sup>: Please contact your local SOC sales representative for rated currents which are not listed.

<sup>\*2</sup>: This product uses high melting temperature type solder containing 85% by weight or more lead. This type of solder is exempted from the RoHS Directive.

Representative pre-arcing time-current characteristics

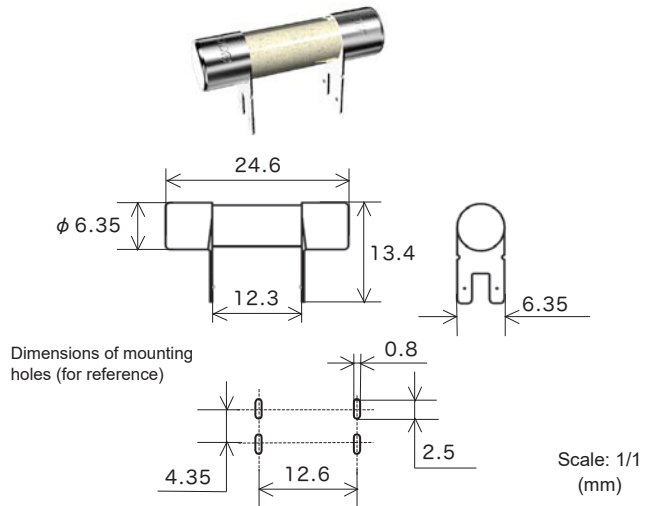
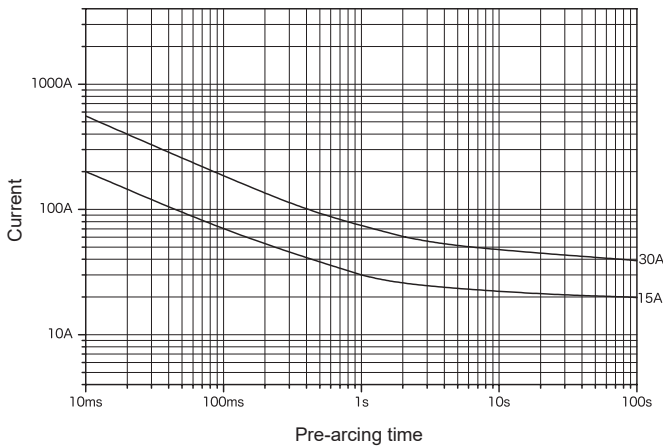

Rated voltage	Certification	Rated current (I <sub>N</sub> ) *1	Rated breaking current		Min. breaking current	Temp. rise	Current carrying capacity	Overload operation
DC 500 V	-	5 A, 10 A, 15 A 20 A, 25 A 30 A, 35 A	1000 A	Resistive circuit	2.0 I <sub>N</sub>	75 K or less at 0.5 I <sub>N</sub>	1.0 I <sub>N</sub> until temperature stabilization occurs	Within 2 min at 2.0 I <sub>N</sub>

\*1: Please contact your local SOC sales representative for rated currents which are not listed.

\*2: This product uses high melting temperature type solder containing 85% by weight or more lead. This type of solder is exempted from the RoHS Directive.

Representative pre-arcing time-current characteristics

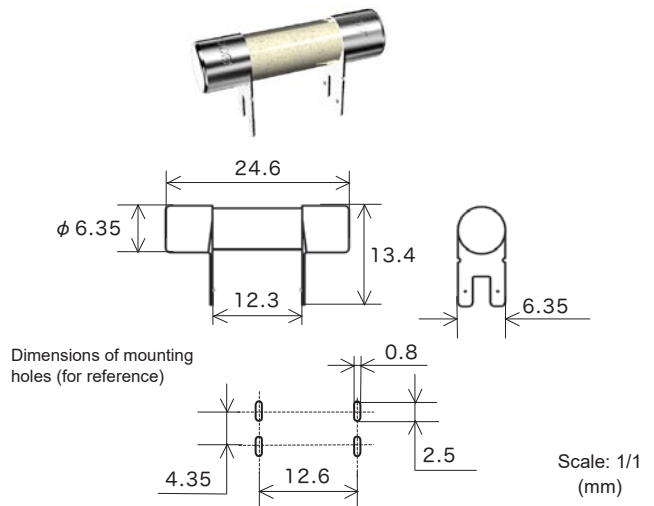
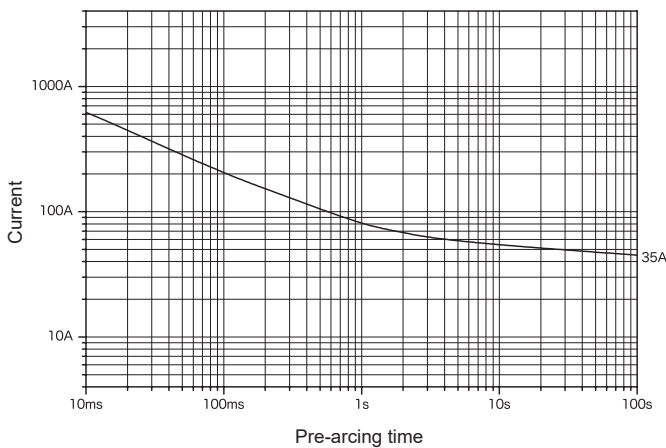

Rated voltage	Certification	Rated current (I <sub>N</sub> ) *1	Rated breaking current		Min. breaking current	Temp. rise	Current carrying capacity	Overload operation
DC 550 V	-	35 A	1000 A	Resistive circuit	500 A	75 K or less at 0.5 I <sub>N</sub>	1.0 I <sub>N</sub> until temperature stabilization occurs	Within 1 s at 500 A
DC 300 V			2000 A		70 A			

\*1: Please contact your local SOC sales representative for rated currents which are not listed.

\*2: This product uses high melting temperature type solder containing 85% by weight or more lead. This type of solder is exempted from the RoHS Directive.

Representative pre-arcing time-current characteristics

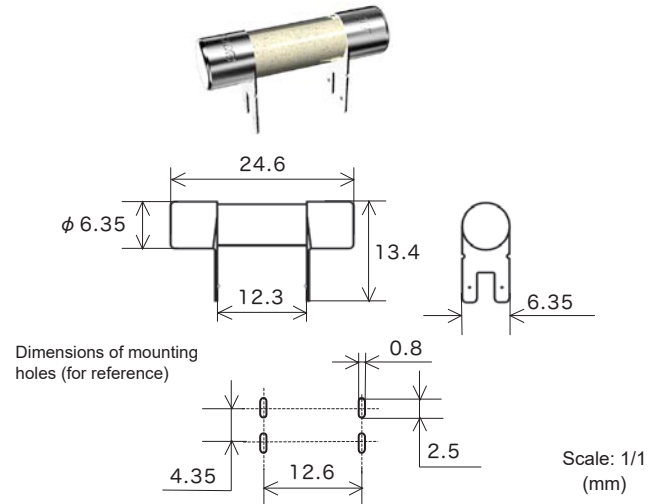
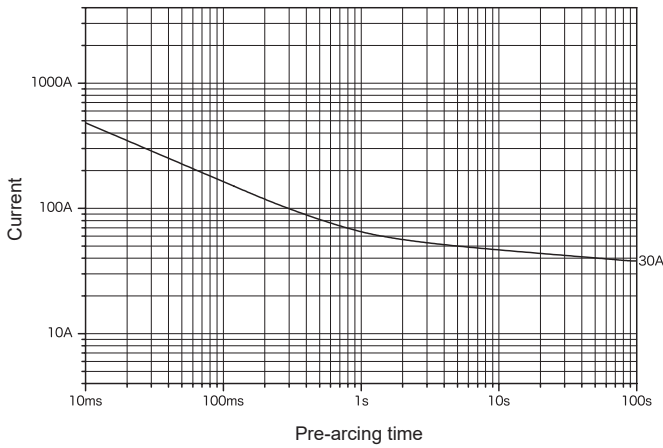

Rated voltage	Certification	Rated current (I <sub>N</sub> ) *1	Rated breaking current	Min. breaking current	Temp. rise	Current carrying capacity	Overload operation
DC 600 V	-	30 A	1000 A Resistive circuit	5.0 I <sub>N</sub>	75 K or less at 0.5 I <sub>N</sub>	1.0 I <sub>N</sub> until temperature stabilization occurs	Within 1 s at 5.0 I <sub>N</sub>

\*1: Please contact your local SOC sales representative for rated currents which are not listed.

\*2: This product uses high melting temperature type solder containing 85% by weight or more lead. This type of solder is exempted from the RoHS Directive.

# DC500VBC635C

Representative pre-arcing time-current characteristics

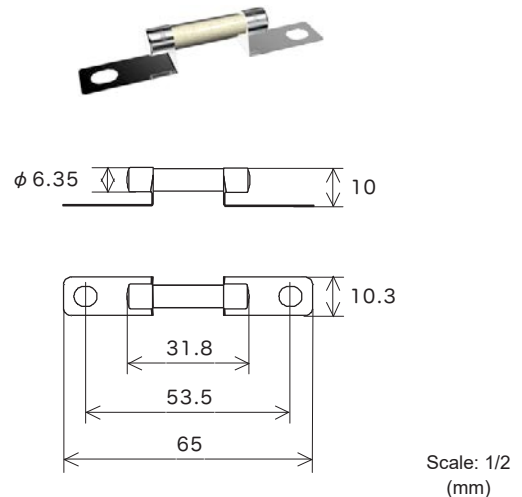
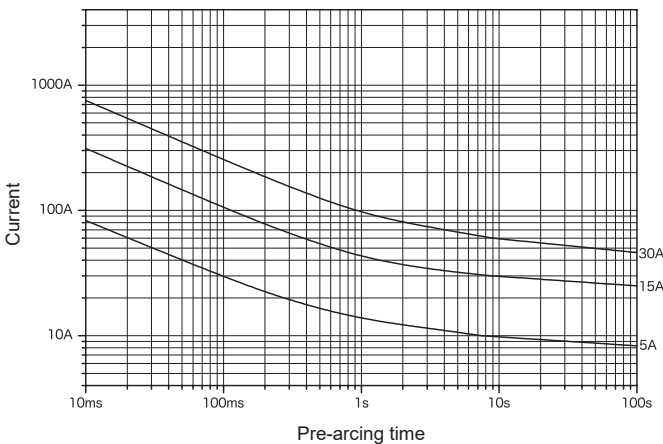

Rated voltage	Certification	Rated current (I <sub>N</sub> ) *1	Rated breaking current	Min. breaking current	Temp. rise	Current carrying capacity	Overload operation
DC 500 V	-	5 A 15 A 30 A	2000 A Resistive circuit	2.0 I <sub>N</sub>	50 K or less at 0.7 I <sub>N</sub>	4 h or more at 1.1 I <sub>N</sub>	*2

\*1: Please contact your local SOC sales representative for rated currents which are not listed.

\*2:

2.0 I <sub>N</sub>	3.0 I <sub>N</sub>	5.0 I <sub>N</sub>
0.5 s–100 s	0.1 s–15 s	0.05 s–1 s

# AC250VBL1030C

RoHS-compliant

Pb free

Representative pre-arcing time-current characteristics

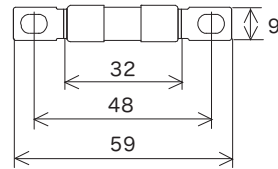
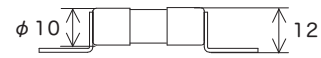
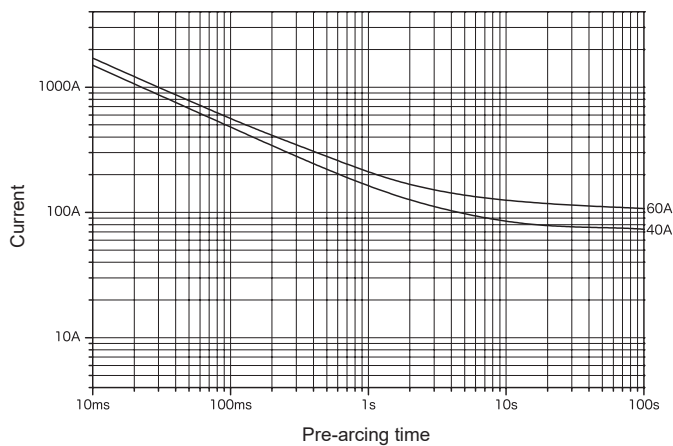

Scale: 1/2 (mm)

Rated voltage	Certification	Rated current ( $I_N$ ) *1	Rated breaking current		Temp. rise	Current carrying capacity	Overload operation
AC 250 V		40 A	1500 A	PF 0.7-0.8	75 K or less at 1.0 $I_N$	1.0 $I_N$ until temperature stabilization occurs	Within 4 min at 2.0 $I_N$
		50 A					

\*1: Please contact your local SOC sales representative for rated currents which are not listed.

# AC450VBL1030C

RoHS-compliant

Pb free

Representative pre-arcing time-current characteristics

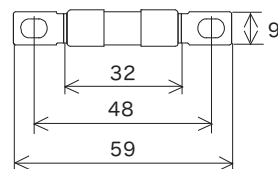
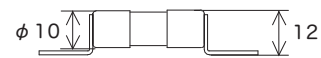
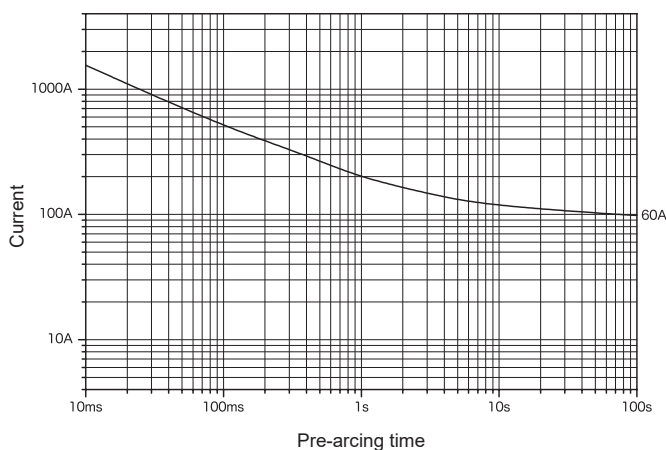

Scale: 1/2 (mm)

Rated voltage	Certification	Rated current ( $I_N$ ) *1	Rated breaking current	Min. breaking current	Temp. rise	Current carrying capacity	Overload operation	
AC 450 V	-	60 A	500 A	Resistive circuit	2.0 $I_N$	150 K or less at 1.0 $I_N$	1.0 $I_N$ until temperature stabilization occurs	Within 2 min at 2.0 $I_N$

\*1: Please contact your local SOC sales representative for rated currents which are not listed.

# DC72VBL1030

RoHS-compliant Pb free

Representative pre-arcing time-current characteristics

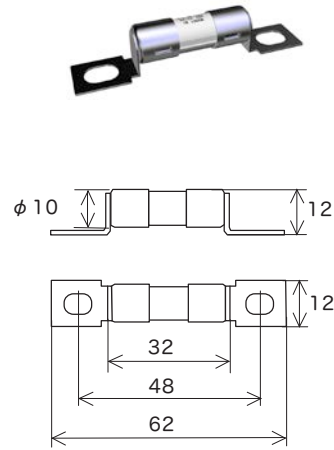
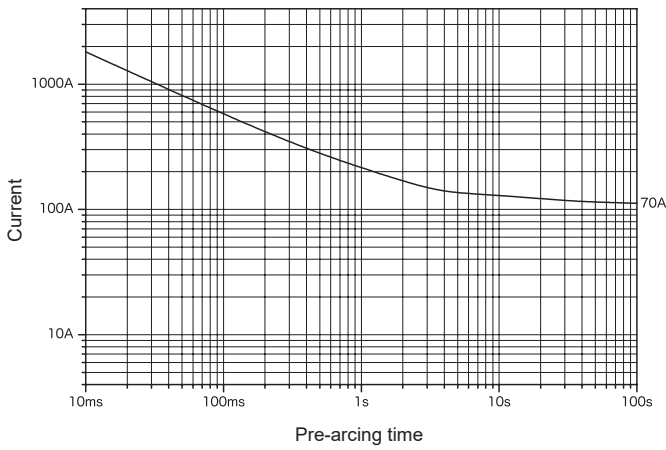

Scale: 1/2 (mm)

Rated voltage	Certification	Rated current (I <sub>N</sub> ) *1	Rated breaking current		Temp. rise	Current carrying capacity	Overload operation
DC 72 V	-	50 A 70 A	1000 A	Resistive circuit	75 K or less at 1.0 I <sub>N</sub>	1.0 I <sub>N</sub> until temperature stabilization occurs	Within 2 min at 2.0 I <sub>N</sub>

\*1: Please contact your local SOC sales representative for rated currents which are not listed.

# DC500VBL1030F

RoHS-compliant Pb free

Representative pre-arcing time-current characteristics

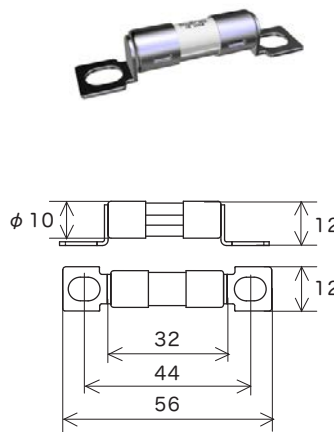
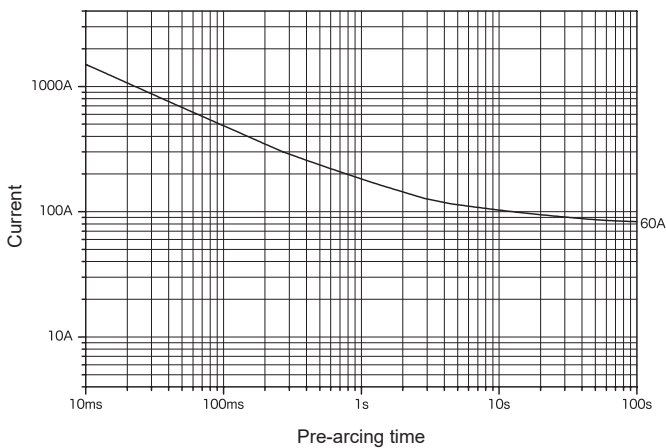

Scale: 1/2 (mm)

Rated voltage	Certification	Rated current (I <sub>N</sub> ) *1	Rated breaking current	Min. breaking current	Temp. rise	Current carrying capacity	Overload operation	
DC 500 V	-	60 A	500 A	Resistive circuit	5.0 I <sub>N</sub>	25 K or less at 0.5 I <sub>N</sub>	1.0 I <sub>N</sub> until temperature stabilization occurs	Within 1 s at 5.0 I <sub>N</sub>

\*1: Please contact your local SOC sales representative for rated currents which are not listed.

# 500VBI1030

RoHS-compliant

Pb free

Representative pre-arcing time-current characteristics

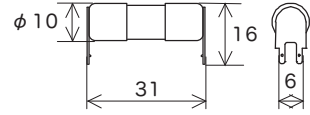
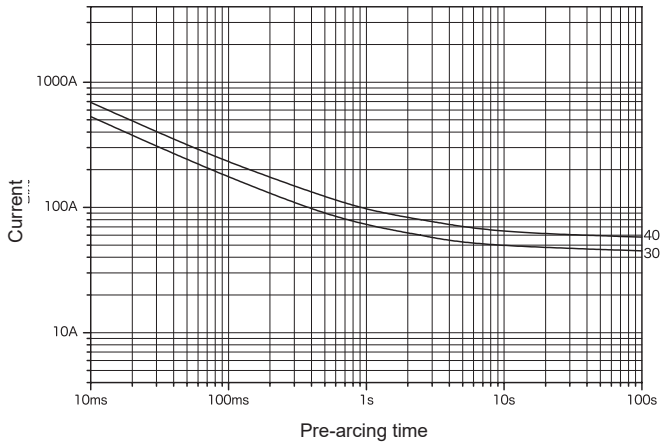

Dimensions of mounting holes (For reference)

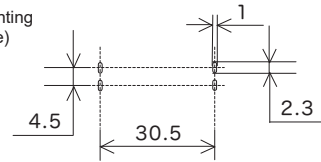

Scale: 1/2 (mm)

Rated voltage	Certification	Rated current (I <sub>N</sub> ) *1	Rated breaking current	Min. breaking current	Temp. rise	Current carrying capacity	Overload operation	
DC 500 V	cRU <sup>®</sup> US	5 A–50 A	1000 A	Resistive circuit	2.0 I <sub>N</sub>	150 K or less at 1.0 I <sub>N</sub>	1.0 I <sub>N</sub> until temperature stabilization occurs	Within 2 min at 2.0 I <sub>N</sub>
AC 500 V			500 A					
DC 500 V	–	5 A–40 A	2000 A					

\*1: Please contact your local SOC sales representative for rated currents which are not listed.

# 500VBL1030A

RoHS-compliant

Pb free

Representative pre-arcing time-current characteristics

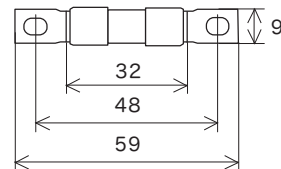
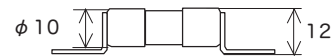
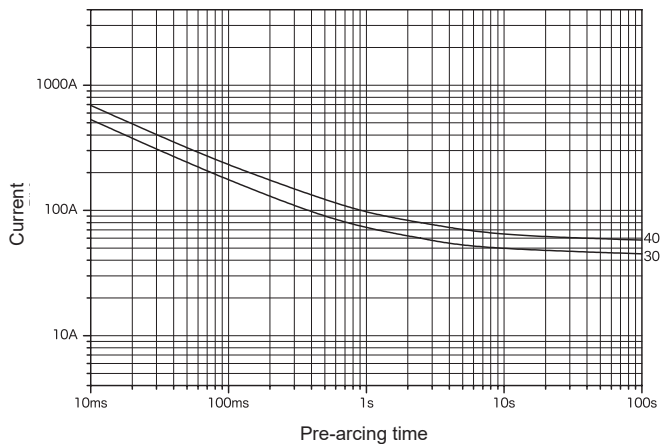

Scale: 1/2 (mm)

Rated voltage	Certification	Rated current (I <sub>N</sub> ) *1	Rated breaking current	Min. breaking current	Temp. rise	Current carrying capacity	Overload operation	
DC 500 V	cRU <sup>®</sup> US	5 A–50 A	1000 A	Resistive circuit	2.0 I <sub>N</sub>	At 1.0 I <sub>N</sub> 5 A–25 A 100 K or less 30 A 120 K or less 35 A–50 A 150 K or less	1.0 I <sub>N</sub> until temperature stabilization occurs	Within 2 min at 2.0 I <sub>N</sub>
AC 500 V			500 A					
DC 500 V	–	5 A–40 A	2000 A					

\*1: Please contact your local SOC sales representative for rated currents which are not listed.

Representative pre-arcing time-current characteristics

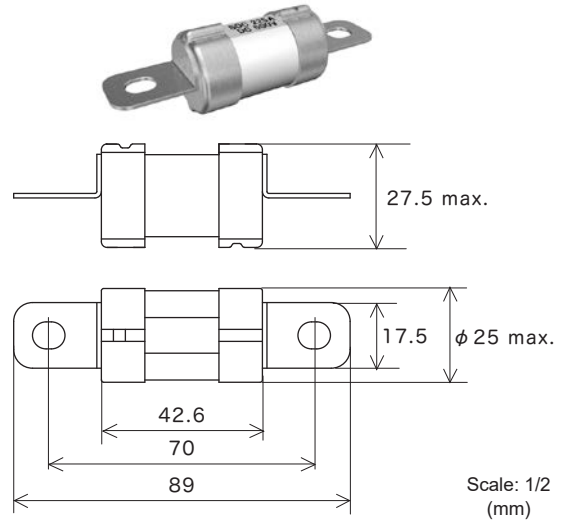
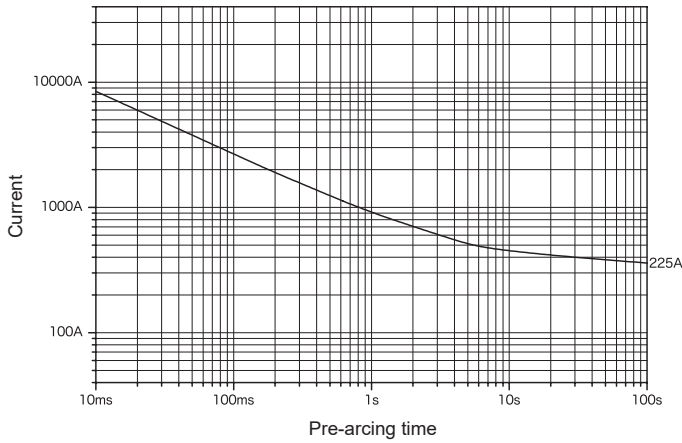

Rated voltage	Certification	Rated current ( $I_N$ ) *1	Rated breaking current		Min. breaking current	Temp. rise	Overload operation
DC 500 V	-	225 A	2000 A	Resistive circuit	5.0 $I_N$	50 K or less at 0.5 $I_N$	0.05 s–1 s at 5.0 $I_N$

\*1: Please contact your local SOC sales representative for rated currents which are not listed.



# DC450VBT3050

RoHS-compliant

Pb free

Representative pre-arcing time-current characteristics

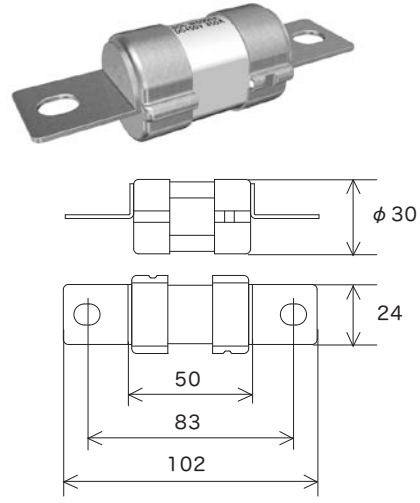
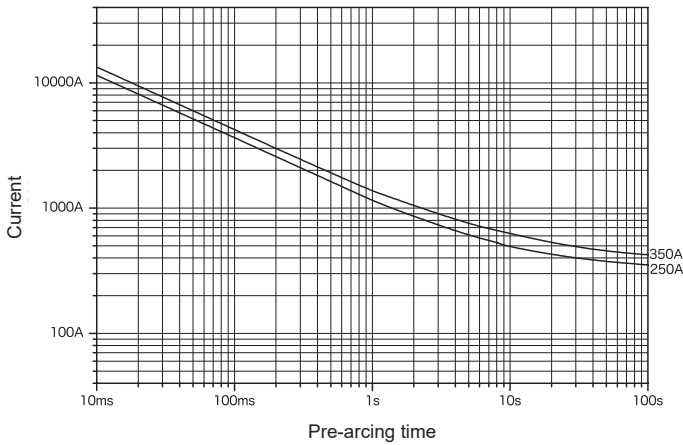

Scale: 1/3 (mm)

Rated voltage	Certification	Rated current ( $I_N$ ) *1	Rated breaking current	Min. breaking current	Temp. rise	Overload operation
DC 450 V	-	250 A 350 A	5000 A Resistive circuit	2.0 $I_N$	50 K or less at 0.5 $I_N$	0.05 s–1 s at 5.0 $I_N$

\*1: Please contact your local SOC sales representative for rated currents which are not listed.

# PT4065

RoHS-compliant

Pb free

Representative pre-arcing time-current characteristics

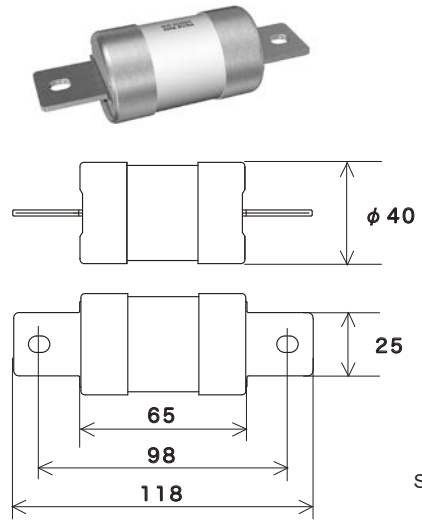
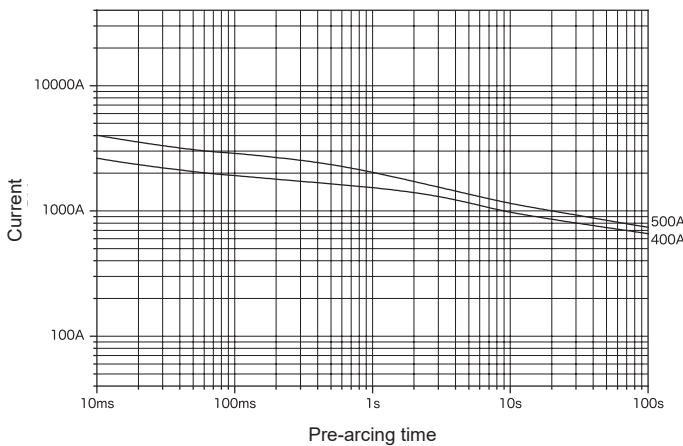

Scale: 1/3 (mm)



Rated voltage	Certification	Rated current ( $I_N$ ) *1	Rated breaking current	Min. breaking current	Current carrying capacity	Overload operation
DC 800 V	-	400 A	10000 A ( $\tau \leq 1$ ms)	20.0 $I_N$	0.75 $I_N$ until temperature stabilization occurs	-
DC 500 V			20000 A ( $\tau \leq 1$ ms)	2.0 $I_N$		1 s–300 s at 2.0 $I_N$

\*1: Please contact your local SOC sales representative for rated currents which are not listed.

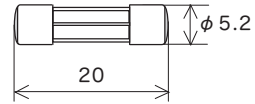
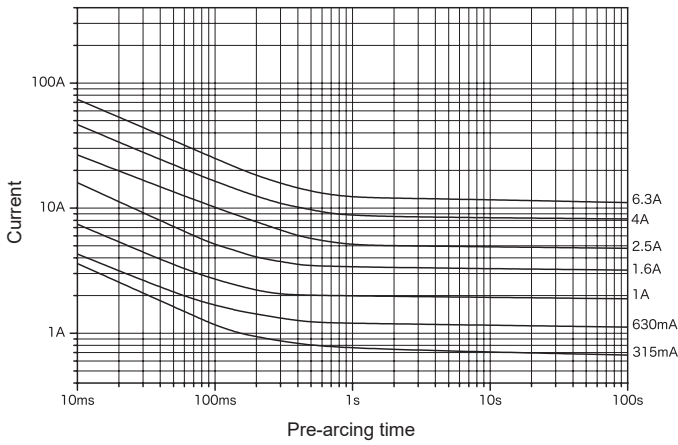
Representative pre-arcing time-current characteristics



Scale: 1/1 (mm)

Rated voltage	Certification	Rated current ( $I_N$ )	Rated breaking current		Endurance test	Pre-arcing time-current characteristics
AC250V	  	80 mA 100 mA 125 mA 160 mA 200 mA 250 mA 315 mA 400 mA 500 mA 630 mA 800 mA 1 A 1.25 A 1.6 A 2 A 2.5 A 3.15 A 4 A 5 A 6.3 A	35 A or 10 $I_N$ , whichever is greater	Resistive circuit	*1	*2

\*1: After 100 cycles of 1.2  $I_N$  1 h on / 15 min off, 1.5  $I_N$  is passed through the fuse for 1 h.

Rated current	2.1 $I_N$	2.75 $I_N$	4.0 $I_N$	10 $I_N$
80 mA, 100 mA	Within 30 min	0.01 s–0.5 s	0.003 s–0.1 s	Within 0.02 s
125 mA–6.3 A		0.05 s–2 s	0.01 s–0.3 s	

Representative pre-arcing time-current characteristics

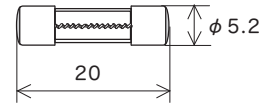
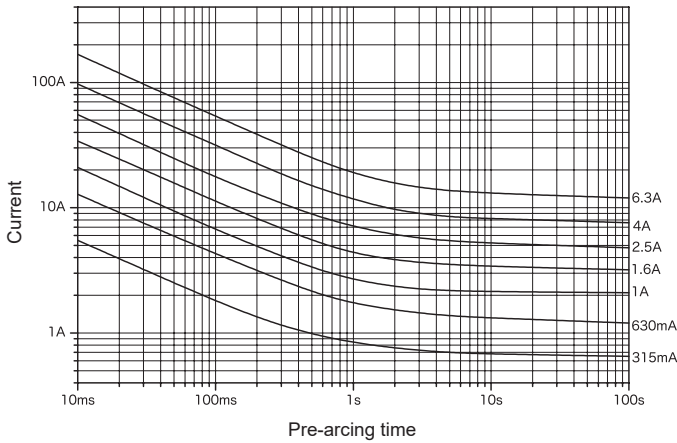

Scale: 1/1 (mm)

Rated voltage	Certification	Rated current ( $I_N$ )	Rated breaking current		Endurance test	Test at elevated temperature	Pre-arcing time-current characteristics
AC 250 V	    *1	315 mA 400 mA 500 mA 630 mA 800 mA 1 A 1.25 A 1.6 A 2 A 2.5 A 3.15 A 4 A 5 A 6.3 A	35 A or 10 $I_N$ , whichever is greater	Resistive circuit	*2	*3	*4

\*1: Fuses with rated currents of less than 1A are not considered electrical products per the Electrical Appliance and Material Safety Law.

\*2: After 100 cycles of 1.2  $I_N$  1 h on / 15 min off, 1.5  $I_N$  is passed through the fuse for 1 h.

\*3: A current of 1.1  $I_N$  is passed through the fuse for 1 h at a temperature of 70±2 °C.

\*4:

2.1 $I_N$	2.75 $I_N$	4.0 $I_N$	10 $I_N$
Within 2 min	0.6 s–10 s	0.15 s–3 s	0.02 s–0.3 s

Representative pre-arcing time-current characteristics

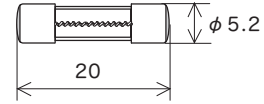
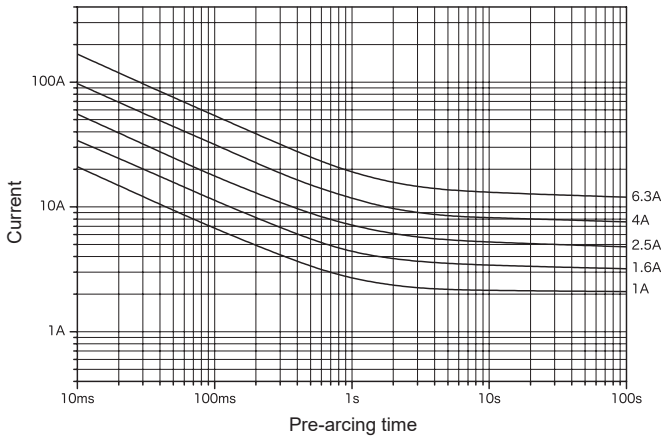

Scale: 1/1 (mm)

Rated voltage	Certification	Rated current (I <sub>N</sub> )	Rated breaking current		Temp. rise	Current carrying capacity / Endurance test	Test at elevated temperature	Pre-arcing time-current characteristics
AC 250 V		1 A 1.25 A 1.6 A	150 A	Resistive circuit	75 K or less at 1.0 I <sub>N</sub>	1.0 I <sub>N</sub> until temperature stabilization occurs	-	Within 30 min at 2.1 I <sub>N</sub>
		2 A 2.5 A 3.15 A			-	*1	*2	*3
		4 A 5 A 6.3 A	100 A	PF 0.7-0.8	At 1.0 I <sub>N</sub> , 140 K or less at the center, 60 K or less at the contact	1.0 I <sub>N</sub> until constant temperature is obtained on each part	-	Within 30 min at 2.1 I <sub>N</sub>

\*1: Endurance Test: After 100 cycles of 1.2 I<sub>N</sub> 1 h on / 15 min off, 1.5 I<sub>N</sub> is passed through the fuse for 1 h.

\*2: A current of 1.1 I<sub>N</sub> is passed through the fuse for 1 h at a temperature of 70±2 °C.

\*3:

2.1 I <sub>N</sub>	2.75 I <sub>N</sub>	4.0 I <sub>N</sub>	10 I <sub>N</sub>
Within 2 min	0.6 s-10 s	0.15 s-3 s	0.02 s-0.3 s

Representative pre-arcing time-current characteristics

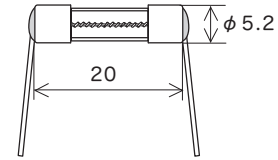
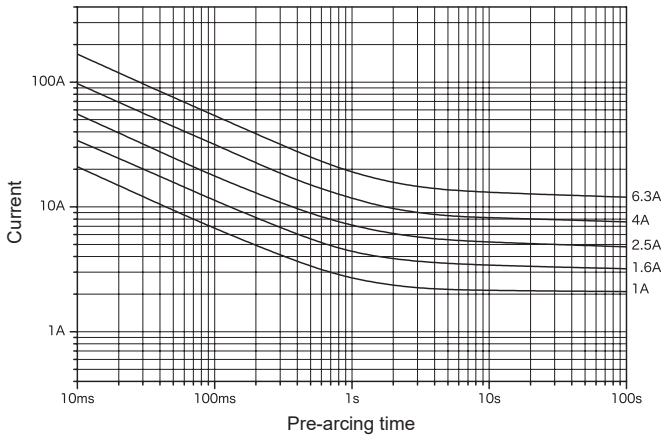

Lead wire diameter  $\phi$  0.8

Scale: 1/1 (mm)

Rated voltage	Certification	Rated current ( $I_N$ )	Rated breaking current		Temp. rise	Current carrying capacity / Endurance test	Test at elevated temperature	Pre-arcing time-current characteristics
AC250V		1 A 1.25 A 1.6 A	150 A	Resistive circuit	75 K or less at 1.0 $I_N$	1.0 $I_N$ until temperature stabilization occurs	-	Within 30 min at 2.1 $I_N$
		2 A 2.5 A 3.15 A			-	*1	*2	*3
		4 A 5 A 6.3 A	100 A	PF 0.7-0.8	At 1.0 $I_N$ , 140 K or less at the center, 60 K or less at the contact	1.0 $I_N$ until constant temperature is obtained on each part	-	Within 30 min at 2.1 $I_N$

\*1: Endurance Test: After 100 cycles of 1.2  $I_N$  1 h on / 15 min off, 1.5  $I_N$  is passed through the fuse for 1 h.

\*2: A current of 1.1  $I_N$  is passed through the fuse for 1 h at a temperature of 70±2 °C.



\*3:

2.1 $I_N$	2.75 $I_N$	4.0 $I_N$	10 $I_N$
Within 2 min	0.6 s-10 s	0.15 s-3 s	0.02 s-0.3 s

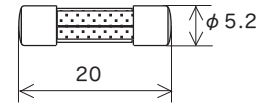
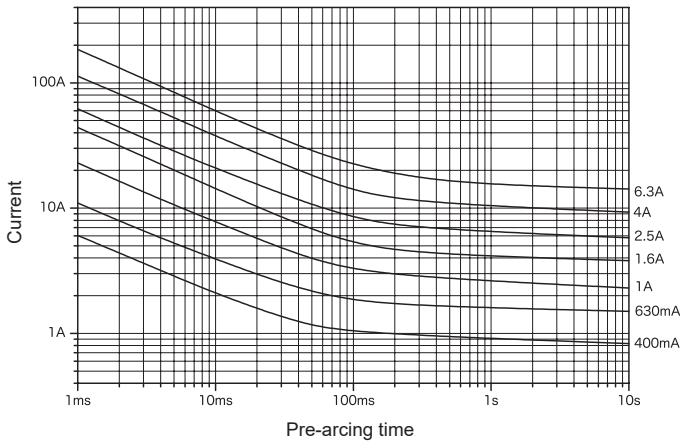
Representative pre-arcing time-current characteristics



Scale: 1/1 (mm)

Rated voltage	Certification	Rated current ( $I_N$ )	Rated breaking current		Endurance test	Pre-arcing time-current characteristics
AC 250 V	  	400 mA 500 mA 630 mA 800 mA 1 A 1.25 A 1.6 A 2 A 2.5 A 3.15 A 4 A 5 A 6.3 A	1500 A	PF 0.7-0.8	*1	*2

\*1: After 100 cycles of 1.2  $I_N$  1 h on / 15 min off, 1.5  $I_N$  is passed through the fuse for 1 h.

\*2:

Rated current	2.1 $I_N$	2.75 $I_N$	4.0 $I_N$	10 $I_N$
400 mA-3.15 A	Within 30 min	0.01 s-2 s	0.003 s-0.3 s	Within 0.02 s
4 A-6.3 A		0.01 s-3 s		

Representative pre-arcing time-current characteristics

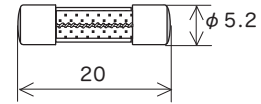
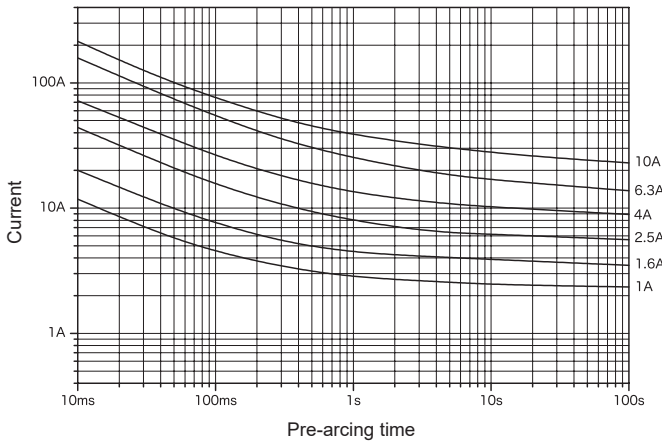

Scale: 1/1 (mm)

Rated voltage	Certification	Rated current ( $I_N$ )	Rated breaking current		Endurance test	Test at elevated temperature	Pre-arcing time-current characteristics
AC 250 V		1 A 1.25 A 1.6 A 2 A 2.5 A 3.15 A 4 A 5 A 6.3 A	1500 A	PF 0.7-0.8	*1	*2	*3
		8 A 10 A					

\*1: After 100 cycles of 1.2  $I_N$  1 h on / 15 min off, 1.5  $I_N$  is passed through the fuse for 1 h.

\*2: A current of 1.1  $I_N$  is passed through the fuse for 1 h at a temperature of 70±2 °C.

\*3:

Rated current	2.1 $I_N$	2.75 $I_N$	4.0 $I_N$	10 $I_N$
1 A-3.15 A	Within 30 min	0.75 s-80 s	0.095 s-5 s	0.01 s-0.15 s
4 A-10 A			0.15 s-5 s	

\*4: 1 A-6.3 A Pb free  
 8 A-10 A This product uses high melting temperature type solder containing 85% by weight or more lead. This type of solder is exempted from the RoHS Directive.

Representative pre-arcing time-current characteristics

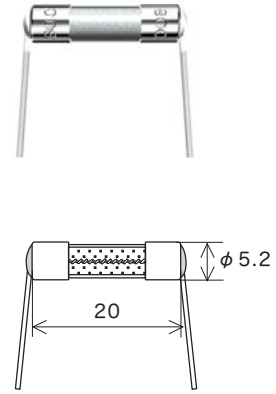
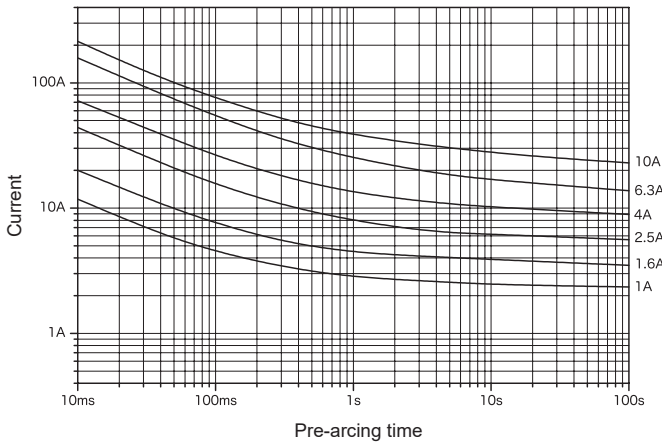

Lead wire diameter  $\phi$  0.8 (1 A–6.3 A)  $\phi$  1.0 (8 A–10 A) Scale: 1/1 (mm)

Rated voltage	Certification	Rated current ( $I_N$ )	Rated breaking current		Endurance test	Test at elevated temperature	Pre-arcing time-current characteristics
AC 250 V		1 A 1.25 A 1.6 A 2 A 2.5 A 3.15 A 4 A 5 A 6.3 A 8 A 10 A	1500 A	PF 0.7–0.8	*1	*2	*3

\*1: After 100 cycles of 1.2  $I_N$  1 h on / 15 min off, 1.5  $I_N$  is passed through the fuse for 1 h.

\*2: A current of 1.1  $I_N$  is passed through the fuse for 1 h at a temperature of 70±2 °C.

\*3:

Rated current	2.1 $I_N$	2.75 $I_N$	4.0 $I_N$	10 $I_N$
1 A–3.15 A	Within 30 min	0.75 s–80 s	0.095 s–5 s	0.01 s–0.15 s
4 A–10 A			0.15 s–5 s	

\*4: 1 A–6.3 A Pb free  
 8 A–10 A This product uses high melting temperature type solder containing 85% by weight or more lead. This type of solder is exempted from the RoHS Directive.



# 250VTMCR N1

Inrush-withstand

RoHS-compliant\*2

Representative pre-arcing time-current characteristics

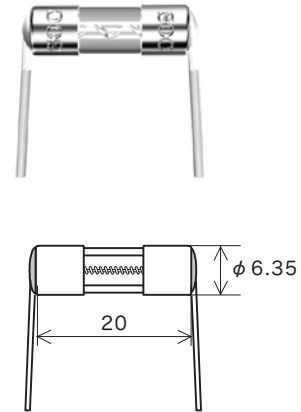
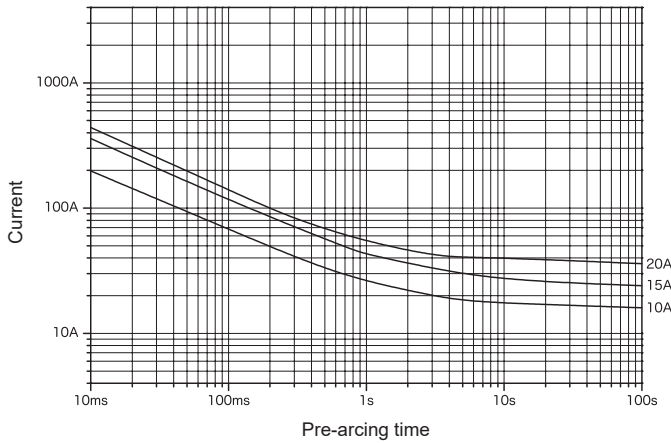

Lead wire diameter  $\phi$  1.2

Scale: 1/1 (mm)

Rated voltage	Certification	Rated current ( $I_N$ ) *1	Rated breaking current		Temp. rise	Current carrying capacity	Overload operation
AC 250 V		1 A–20 A	100 A	PF 0.7–0.8	75 K or less at 1.0 $I_N$	1.0 $I_N$ until temperature stabilization occurs	Within 2 min at 2.0 $I_N$
					At 1.15 $I_N$ , 140 K or less at the center, 60 K or less at the contact	1.3 $I_N$ until constant temperature is obtained on each part	Within 60 min at 1.6 $I_N$ Within 2 min at 2.0 $I_N$

\*1: Customer-requested rated current values can be supplied from within the given range.

\*2: This product uses high melting temperature type solder containing 85% by weight or more lead. This type of solder is exempted from the RoHS Directive.

# DC125VTLKR

Inrush-withstand

RoHS-compliant\*2

Pb free\*2

Representative pre-arcing time-current characteristics

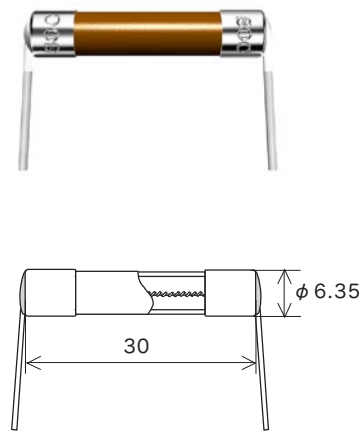
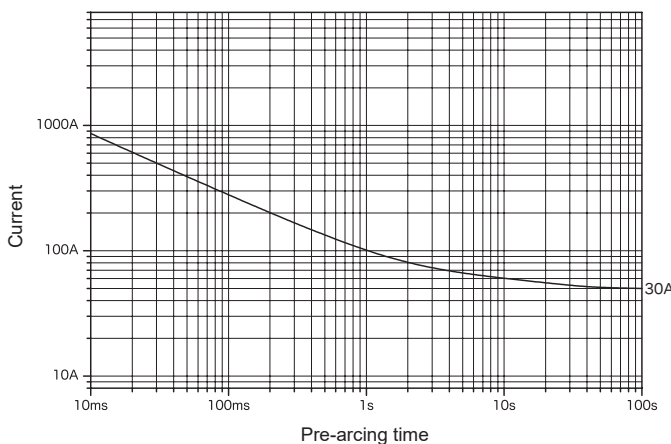

Lead wire diameter  $\phi$  1.2

Scale: 1/1 (mm)

Rated voltage	Certification	Rated current ( $I_N$ ) *1	Rated breaking current		Temp. rise	Current carrying capacity	Overload operation
DC 125 V		800 mA–35 A	1000 A	Resistive circuit	110 K or less at 1.0 $I_N$	1.0 $I_N$ until temperature stabilization occurs	Within 2 min at 2.0 $I_N$

\*1: Customer-requested rated current values can be supplied from within the given range.

\*2: 8 A or less Pb free  
Over 8 A–35 A This product uses high melting temperature type solder containing 85% by weight or more lead. This type of solder is exempted from the RoHS Directive.

Representative pre-arcing time-current characteristics

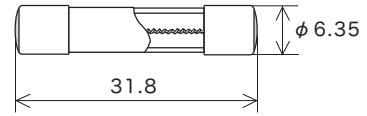
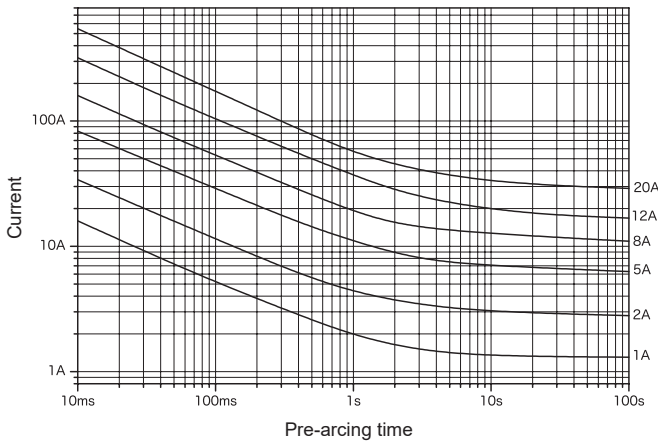

Note: Rated currents of over 15 A–20 A are soldered internally.

Scale: 1/1 (mm)

Rated voltage	Certification	Rated current (I <sub>N</sub> ) *1	Rated breaking current	Temp. rise	Current carrying capacity	Overload operation
AC 125 V	UL, SA	100 mA–15 A	10000 A	PF 0.7–0.8	70 K or less at 1.1 I <sub>N</sub>	Within 60 min at 1.35 I <sub>N</sub> Within 2 min at 2.0 I <sub>N</sub>
	RU	Over 15 A–20 A			70 K or less at 1.0 I <sub>N</sub>	

\*1: Customer-requested rated current values can be supplied from within the given range.

\*2: 100 mA–8 A, over 15 A–20 A Pb free  
Over 8 A–15 A This product uses high melting temperature type solder containing 85% by weight or more lead. This type of solder is exempted from the RoHS Directive.

Representative pre-arcing time-current characteristics

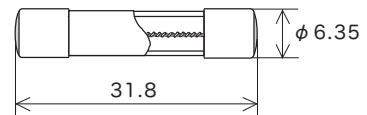
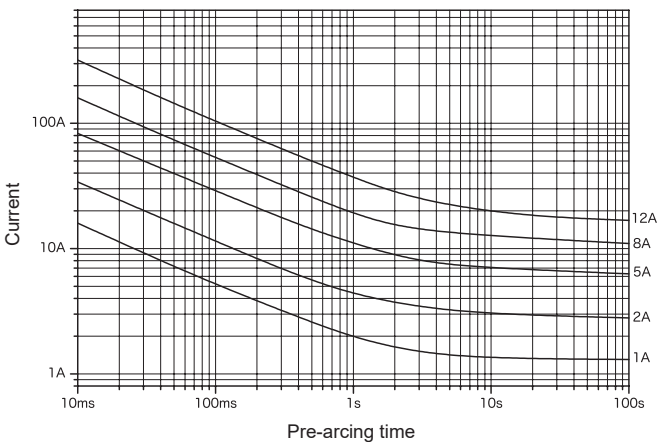

Scale: 1/1 (mm)

Rated voltage	Certification	Rated current (I <sub>N</sub> ) *1	Rated breaking current	Temp. rise	Current carrying capacity	Overload operation
AC 125 V	UL, SA	100 mA–15 A	10000 A	PF 0.7–0.8	70 K or less at 1.1 I <sub>N</sub>	Within 60 min at 1.35 I <sub>N</sub> Within 2 min at 2.0 I <sub>N</sub>
	PS E *2		500 A		At 1.1 I <sub>N</sub> , 140 K or less at the center, 60 K or less at the contact	

\*1: Customer-requested rated current values can be supplied from within the given range.

\*2: Fuses with rated currents of less than 1 A are not considered electrical products per the Electrical Appliance and Material Safety Law.

\*3: 100 mA–8 A Pb free  
Over 8 A–15 A This product uses high melting temperature type solder containing 85% by weight or more lead. This type of solder is exempted from the RoHS Directive.

# CES7

Inrush-withstand

RoHS-compliant\*2

Pb free\*2

Representative pre-arcing time-current characteristics

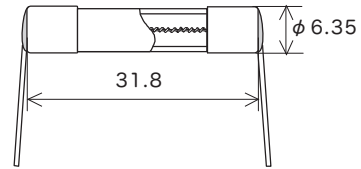
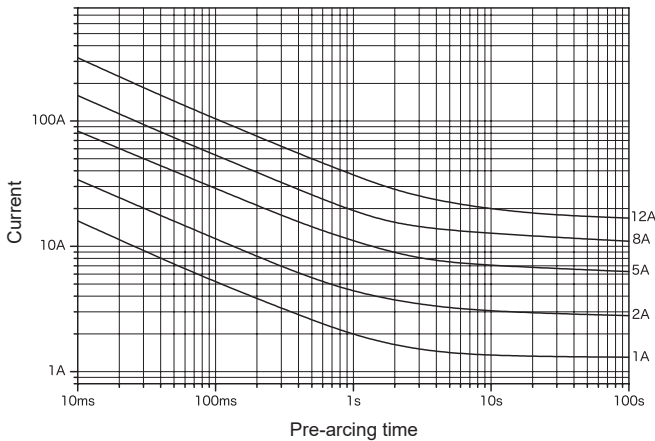

Lead wire diameter  $\phi$  0.8 (100 mA–8 A)  $\phi$  1.2 (Over 8 A–15 A) Scale: 1/1 (mm)

Rated voltage	Certification	Rated current (I <sub>N</sub> ) *1	Rated breaking current		Temp. rise	Current carrying capacity	Overload operation
AC 125 V		100 mA–15 A	10000 A	PF 0.7–0.8	70 K or less at 1.1 I <sub>N</sub>	1.1 I <sub>N</sub> for 15 min or more after temperature stabilization occurs	Within 60 min at 1.35 I <sub>N</sub> Within 2 min at 2.0 I <sub>N</sub>

\*1: Customer-requested rated current values can be supplied from within the given range.

\*2: 100 mA–8 A Pb free

Over 8 A–15 A This product uses high melting temperature type solder containing 85% by weight or more lead. This type of solder is exempted from the RoHS Directive.

# CES7 N1

Inrush-withstand

RoHS-compliant\*3

Pb free\*3

Representative pre-arcing time-current characteristics

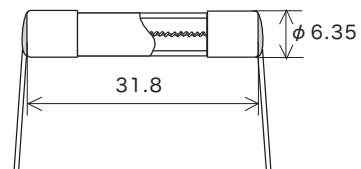
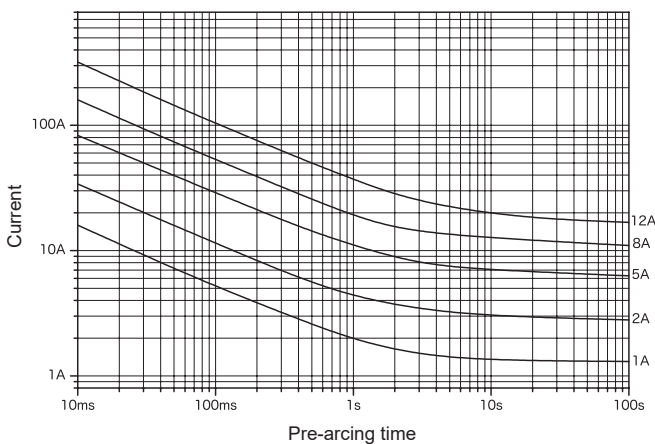

Lead wire diameter  $\phi$  0.8 (100 mA–8 A)  $\phi$  1.2 (Over 8 A–15 A) Scale: 1/1 (mm)

Rated voltage	Certification	Rated current (I <sub>N</sub> ) *1	Rated breaking current		Temp. rise	Current carrying capacity	Overload operation
AC 125 V		100 mA–15 A	10000 A	PF 0.7–0.8	70 K or less at 1.1 I <sub>N</sub>	1.1 I <sub>N</sub> for 15 min or more after temperature stabilization occurs	Within 60 min at 1.35 I <sub>N</sub> Within 2 min at 2.0 I <sub>N</sub>
			500 A		At 1.1 I <sub>N</sub> , 140 K or less at the center, 60 K or less at the contact	1.1 I <sub>N</sub> until constant temperature is obtained on each part	

\*1: Customer-requested rated current values can be supplied from within the given range.

\*2: Fuses with rated currents of less than 1 A are not considered electrical products per the Electrical Appliance and Material Safety Law.

\*3: 100 mA–8 A Pb free

Over 8 A–15 A This product uses high melting temperature type solder containing 85% by weight or more lead. This type of solder is exempted from the RoHS Directive.

Representative pre-arcing time-current characteristics

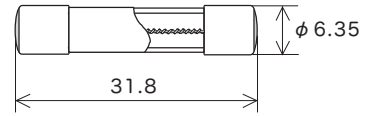
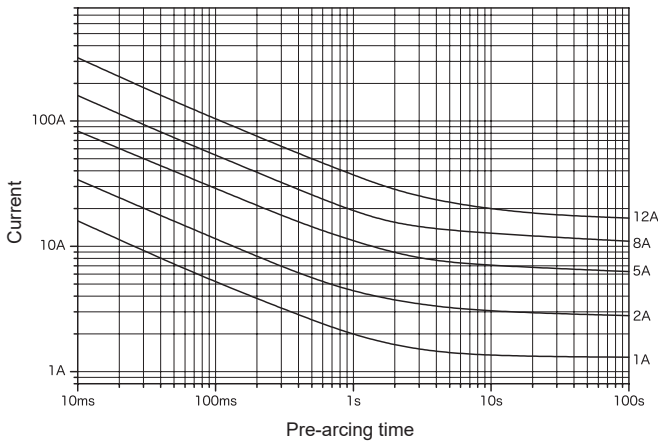

Scale: 1/1 (mm)

Rated voltage	Certification	Rated current (I <sub>N</sub> ) *1	Rated breaking current	Temp. rise	Current carrying capacity	Overload operation
AC 250 V	UL, SA, IEC	100 mA–10 A	200 A	PF 0.7–0.8	70 K or less at 1.1 I <sub>N</sub>	1.1 I <sub>N</sub> for 15 min or more after temperature stabilization occurs
	UL	Over 10 A–15 A	100 A			

\*1: Customer-requested rated current values can be supplied from within the given range.

\*2: 100 mA–8 A Pb free

Over 8 A–15 A This product uses high melting temperature type solder containing 85% by weight or more lead. This type of solder is exempted from the RoHS Directive.

Representative pre-arcing time-current characteristics

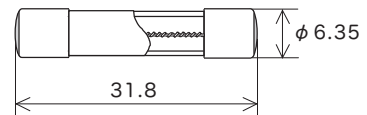
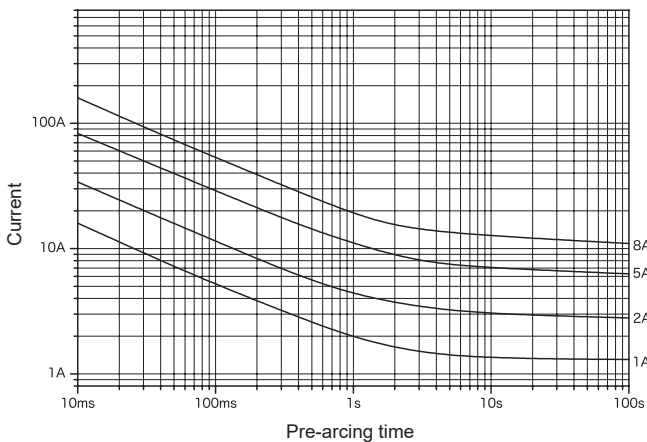

Scale: 1/1 (mm)

Rated voltage	Certification	Rated current (I <sub>N</sub> ) *1	Rated breaking current	Temp. rise	Current carrying capacity	Overload operation
AC 250 V	UL, SA, IEC	100 mA–10 A	200 A	PF 0.7–0.8	70 K or less at 1.1 I <sub>N</sub>	1.1 I <sub>N</sub> for 15 min or more after temperature stabilization occurs
	UL, PS E *2		100 A			

\*1: Customer-requested rated current values can be supplied from within the given range.

\*2: Fuses with rated currents of less than 1 A are not considered electrical products per the Electrical Appliance and Material Safety Law.

\*3: 100 mA–8 A Pb free

Over 8 A–10 A This product uses high melting temperature type solder containing 85% by weight or more lead. This type of solder is exempted from the RoHS Directive.

# CES14 N2

Inrush-withstand

RoHS-compliant\*2

Representative pre-arcing time-current characteristics

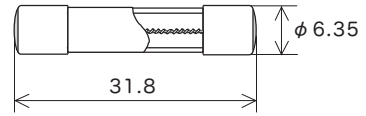
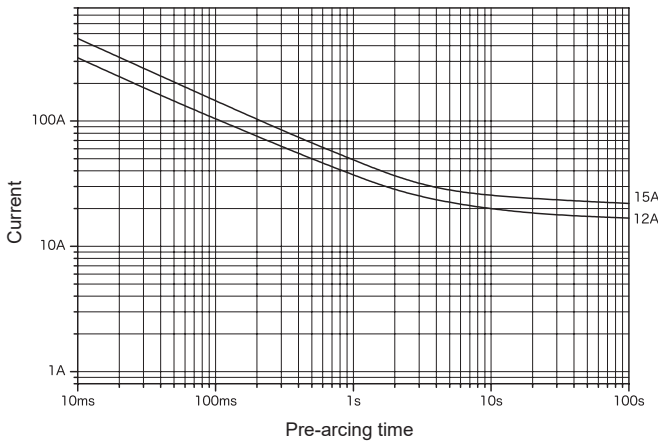

Scale: 1/1 (mm)

Rated voltage	Certification	Rated current (I <sub>N</sub> ) *1	Rated breaking current		Temp. rise	Current carrying capacity	Overload operation
AC 250 V		Over 10 A–15 A	100 A	PF 0.7–0.8	70 K or less at 1.1 I <sub>N</sub>	1.1 I <sub>N</sub> for 15 min or more after temperature stabilization occurs	Within 60 min at 1.35 I <sub>N</sub> Within 2 min at 2.0 I <sub>N</sub>
					At 1.1 I <sub>N</sub> , 140 K or less at the center, 60 K or less at the contact	1.1 I <sub>N</sub> until constant temperature is obtained on each part	

\*1: Customer-requested rated current values can be supplied from within the given range.

\*2: This product uses high melting temperature type solder containing 85% by weight or more lead. This type of solder is exempted from the RoHS Directive.

# CES15

Inrush-withstand

RoHS-compliant\*2

Pb free\*2

Representative pre-arcing time-current characteristics

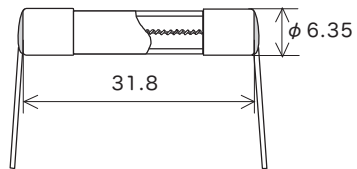
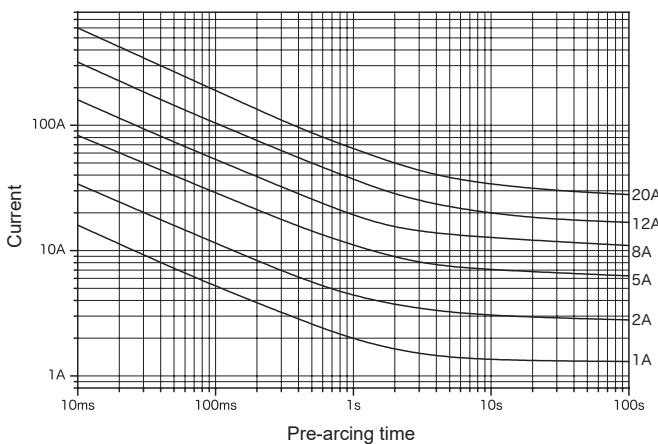

Lead wire diameter  $\phi$  0.8 (100 mA–8 A)  
 $\phi$  1.2 (Over 8 A–30 A)

Scale: 1/1 (mm)

Rated voltage	Certification	Rated current (I <sub>N</sub> ) *1	Rated breaking current		Temp. rise	Current carrying capacity	Overload operation
AC 250 V		100 mA–15 A	200 A	PF 0.7–0.8	70 K or less at 1.1 I <sub>N</sub>	1.1 I <sub>N</sub> for 15 min or more after temperature stabilization occurs	Within 60 min at 1.35 I <sub>N</sub> Within 2 min at 2.0 I <sub>N</sub>
		Over 15 A–30 A			–	1.0 I <sub>N</sub> until temperature stabilization occurs	

\*1: Customer-requested rated current values can be supplied from within the given range.

\*2: 100 mA–8 A, over 15 A–25 A Pb free

Over 8 A–15 A, over 25 A–30 A This product uses high melting temperature type solder containing 85% by weight or more lead. This type of solder is exempted from the RoHS Directive.

Representative pre-arcing time-current characteristics

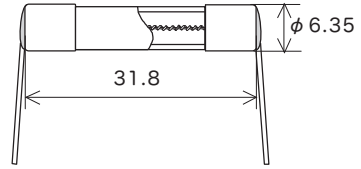
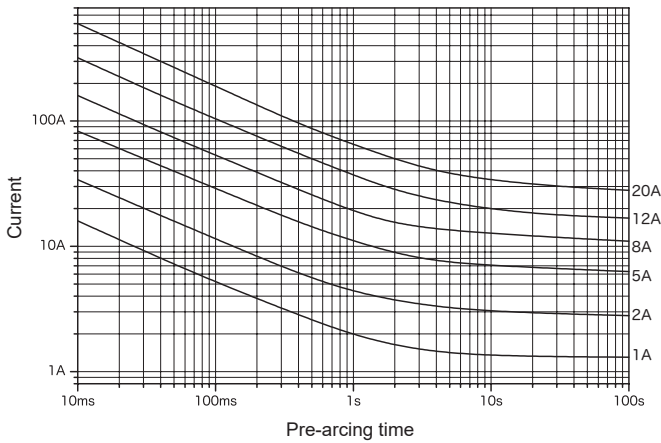

Lead wire diameter  $\phi$  0.8 (100 mA–8 A)  
 $\phi$  1.2 (Over 8 A–25 A)

Scale: 1/1 (mm)

Rated voltage	Certification	Rated current ( $I_N$ ) *1	Rated breaking current		Temp. rise	Current carrying capacity	Overload operation
AC 250 V		100 mA–15 A	200 A	PF 0.7–0.8	70 K or less at 1.1 $I_N$	1.1 $I_N$ for 15 min or more after temperature stabilization occurs	Within 60 min at 1.35 $I_N$ Within 2 min at 2.0 $I_N$
		Over 15 A–25 A			–	1.0 $I_N$ until temperature stabilization occurs	
		100 mA–25 A	100 A		At 1.1 $I_N$ , 140 K or less at the center, 60 K or less at the contact	1.1 $I_N$ until constant temperature is obtained on each part	

\*1: Customer-requested rated current values can be supplied from within the given range.

\*2: Fuses with rated currents of less than 1 A are not considered electrical products per the Electrical Appliance and Material Safety Law.

\*3: 100 mA–8 A, over 15 A–25 A Pb free

Over 8 A–15 A This product uses high melting temperature type solder containing 85% by weight or more lead. This type of solder is exempted from the RoHS Directive.

# KST2

Inrush-withstand

RoHS-compliant\*2

Pb free\*2

Representative pre-arcing time-current characteristics

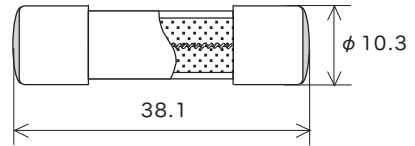
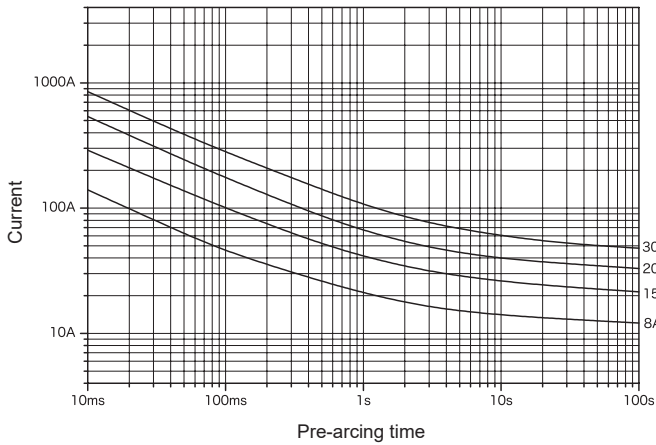

Scale: 1/1 (mm)

Rated voltage	Certification	Rated current (I <sub>N</sub> ) *1	Rated breaking current		Temp. rise	Current carrying capacity	Overload operation
AC 250 V		1 A–30 A	10000 A	PF 0.7–0.8	120 K or less at 1.0 I <sub>N</sub>	1.0 I <sub>N</sub> until temperature stabilization occurs	Within 60 min at 1.35 I <sub>N</sub> Within 2 min at 2.0 I <sub>N</sub>

\*1: Customer-requested rated current values can be supplied from within the given range.

\*2: 1 A–12 A Pb free  
Over 12 A–30 A This product uses high melting temperature type solder containing 85% by weight or more lead. This type of solder is exempted from the RoHS Directive.

# KST2 N1

Inrush-withstand

RoHS-compliant\*2

Pb free\*2

Representative pre-arcing time-current characteristics

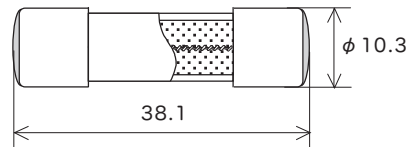
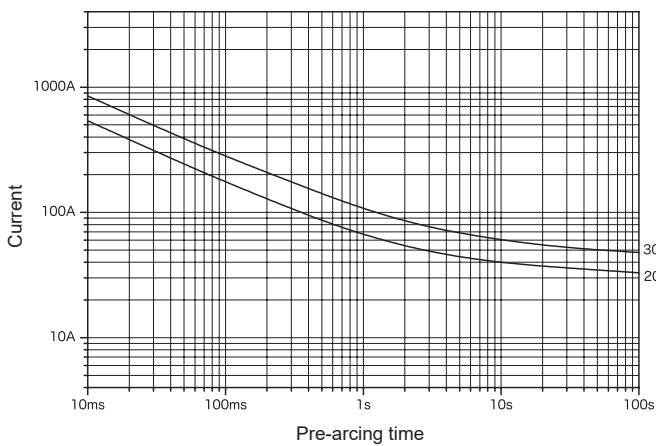

Scale: 1/1 (mm)

Rated voltage	Certification	Rated current (I <sub>N</sub> ) *1	Rated breaking current		Temp. rise	Current carrying capacity	Overload operation
AC 250 V		6.3 A–30 A	10000 A	PF 0.7–0.8	120 K or less at 1.0 I <sub>N</sub>	1.0 I <sub>N</sub> until temperature stabilization occurs	Within 60 min at 1.35 I <sub>N</sub> Within 2 min at 2.0 I <sub>N</sub>
			1500 A		At 1.0 I <sub>N</sub> , 140 K or less at the center, 60 K or less at the contact	1.0 I <sub>N</sub> until constant temperature is obtained on each part	Within 60 min at 1.5 I <sub>N</sub>

\*1: Customer-requested rated current values can be supplied from within the given range.

\*2: 6.3 A–12 A Pb free  
Over 12 A–30 A This product uses high melting temperature type solder containing 85% by weight or more lead. This type of solder is exempted from the RoHS Directive.

Representative pre-arcing time-current characteristics

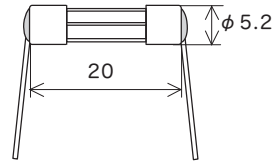
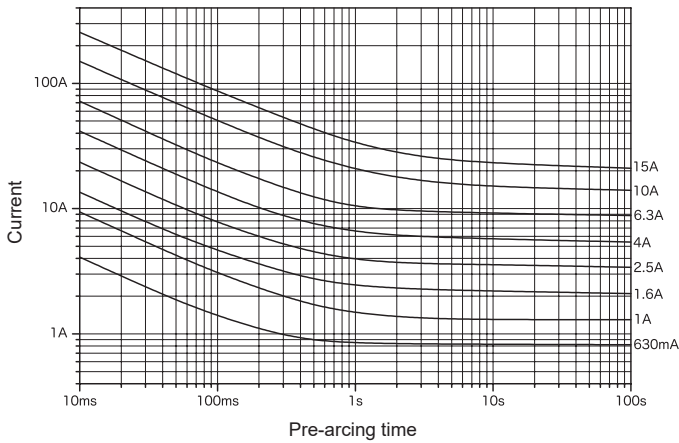

Lead wire diameter  $\phi$  0.5 (62 mA–5 A)  
 $\phi$  0.8 (Over 5 A–10 A)  
 $\phi$  1.0 (Over 10 A–15 A)  
 Scale: 1/1 (mm)

Rated voltage	Certification	Rated current (I <sub>N</sub> ) *1	Rated breaking current	Temp. rise	Current carrying capacity	Overload operation
AC 125 V		62 mA–5 A	10000 A	PF 0.7–0.8	70 K or less at 1.1 I <sub>N</sub>	Within 60 min at 1.35 I <sub>N</sub> Within 2 min at 2.0 I <sub>N</sub>
		Over 5 A–10 A			90 K or less at 1.1 I <sub>N</sub>	
		Over 10 A–15 A			75 K or less at 1.0 I <sub>N</sub>	

\*1: Customer-requested rated current values can be supplied from within the given range.

\*2: 62 mA–8 A Pb free  
 Over 8 A–15 A This product uses high melting temperature type solder containing 85% by weight or more lead. This type of solder is exempted from the RoHS Directive.

Representative pre-arcing time-current characteristics

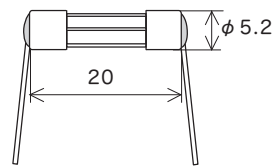
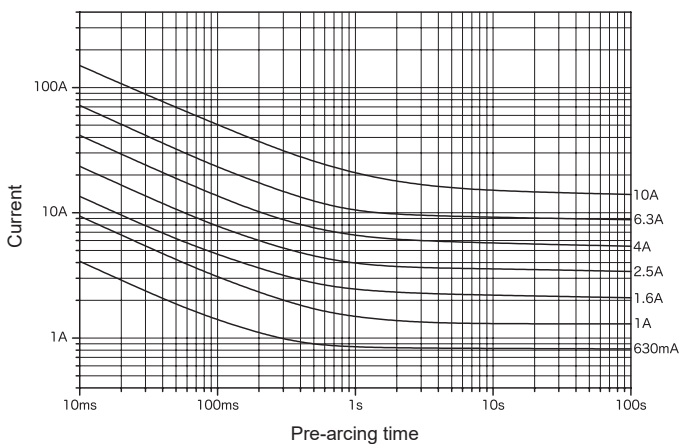

Lead wire diameter  $\phi$  0.5 (62 mA–5 A)  
 $\phi$  0.8 (Over 5 A–10 A)  
 Scale: 1/1 (mm)

Rated voltage	Certification	Rated current (I <sub>N</sub> ) *1	Rated breaking current	Temp. rise	Current carrying capacity	Overload operation
AC 125 V		62 mA–5 A	10000 A	PF 0.7–0.8	70 K or less at 1.1 I <sub>N</sub>	Within 60 min at 1.35 I <sub>N</sub> Within 2 min at 2.0 I <sub>N</sub>
		Over 5 A–10 A			90 K or less at 1.1 I <sub>N</sub>	
		62 mA–10 A	500 A		At 1.1 I <sub>N</sub> , 140 K or less at the center, 60 K or less at the contact	

\*1: Customer-requested rated current values can be supplied from within the given range.

\*2: Fuses with rated currents of less than 1 A are not considered electrical products per the Electrical Appliance and Material Safety Law.

\*3: 62 mA–8 A Pb free  
 Over 8 A–10 A This product uses high melting temperature type solder containing 85% by weight or more lead. This type of solder is exempted from the RoHS Directive.



Representative pre-arcing time-current characteristics

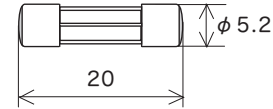
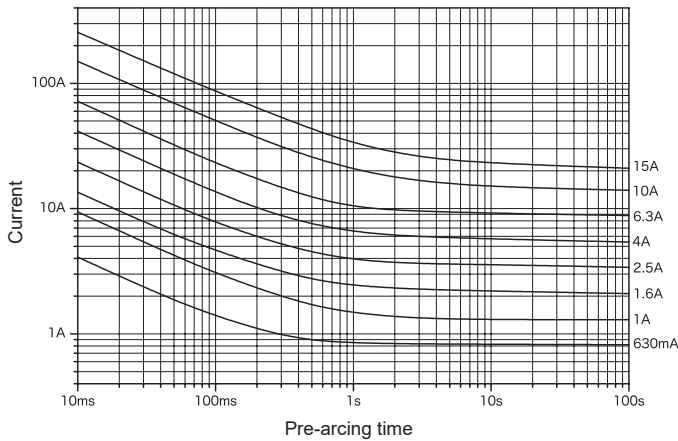

Scale: 1/1 (mm)

Rated voltage	Certification	Rated current (I <sub>N</sub> ) *1	Rated breaking current	Temp. rise	Current carrying capacity	Overload operation
AC 125 V		62 mA–5 A	10000 A	PF 0.7–0.8	70 K or less at 1.1 I <sub>N</sub>	Within 60 min at 1.35 I <sub>N</sub> Within 2 min at 2.0 I <sub>N</sub>
		Over 5 A–10 A			90 K or less at 1.1 I <sub>N</sub>	
		Over 10 A–15 A			75 K or less at 1.0 I <sub>N</sub>	

\*1: Customer-requested rated current values can be supplied from within the given range.  
 \*2: 62 mA–8 A Pb free  
 Over 8 A–15 A This product uses high melting temperature type solder containing 85% by weight or more lead. This type of solder is exempted from the RoHS Directive.

Representative pre-arcing time-current characteristics

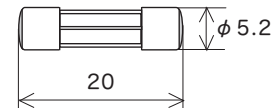
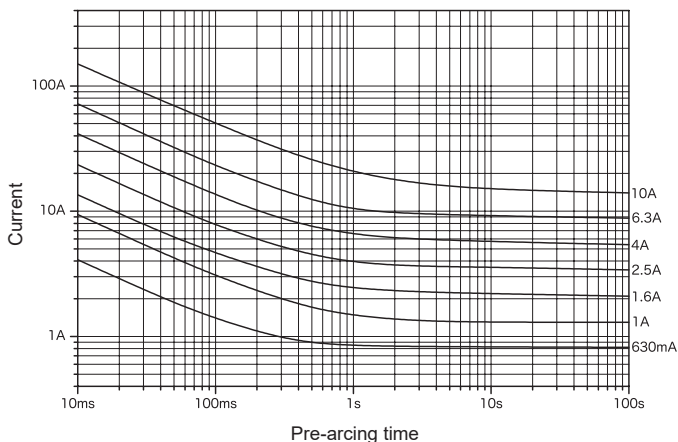

Scale: 1/1 (mm)

Rated voltage	Certification	Rated current (I <sub>N</sub> ) *1	Rated breaking current	Temp. rise	Current carrying capacity	Overload operation
AC 125 V		62 mA–5 A	10000 A	PF 0.7–0.8	70 K or less at 1.1 I <sub>N</sub>	Within 60 min at 1.35 I <sub>N</sub> Within 2 min at 2.0 I <sub>N</sub>
		Over 5 A–10 A			90 K or less at 1.1 I <sub>N</sub>	
		62 mA–10 A	500 A		At 1.1 I <sub>N</sub> , 140 K or less at the center, 60 K or less at the contact	

\*1: Customer-requested rated current values can be supplied from within the given range.  
 \*2: Fuses with rated currents of less than 1 A are not considered electrical products per the Electrical Appliance and Material Safety Law.  
 \*3: 62 mA–8 A Pb free  
 Over 8 A–10 A This product uses high melting temperature type solder containing 85% by weight or more lead. This type of solder is exempted from the RoHS Directive.

Representative pre-arcing time-current characteristics

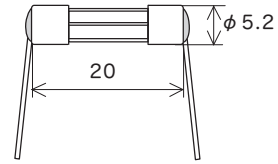
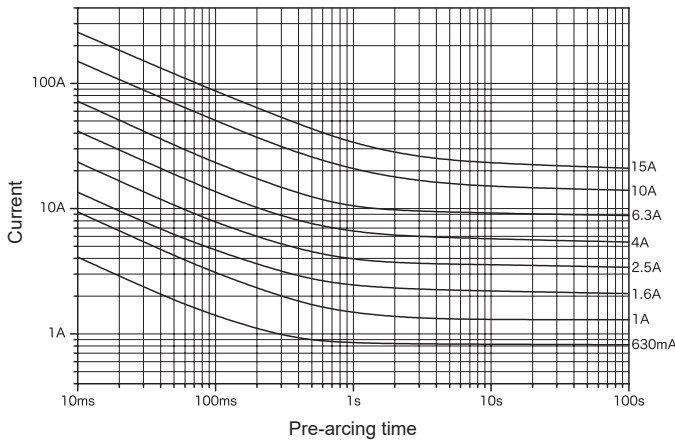

Lead wire diameter  $\phi$  0.5 (62 mA–3 A)  
 $\phi$  0.8 (Over 3 A–10 A)  
 $\phi$  1.0 (Over 10 A–15 A) Scale: 1/1 (mm)

Rated voltage	Certification	Rated current ( $I_N$ ) *1	Rated breaking current	Temp. rise	Current carrying capacity	Overload operation
AC 250 V	UL SP	62 mA–3 A	100 A	PF 0.7–0.8	70 K or less at 1.1 $I_N$	1.1 $I_N$ for 15 min or more after temperature stabilization occurs
	RU	Over 3 A–15 A			70 K or less at 1.0 $I_N$	
						Within 60 min at 1.35 $I_N$ Within 2 min at 2.0 $I_N$

\*1: Customer-requested rated current values can be supplied from within the given range.

\*2: 62 mA–8 A Pb free  
 Over 8 A–15 A This product uses high melting temperature type solder containing 85% by weight or more lead. This type of solder is exempted from the RoHS Directive.

Representative pre-arcing time-current characteristics

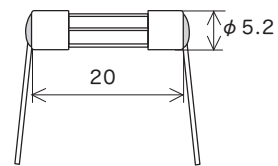
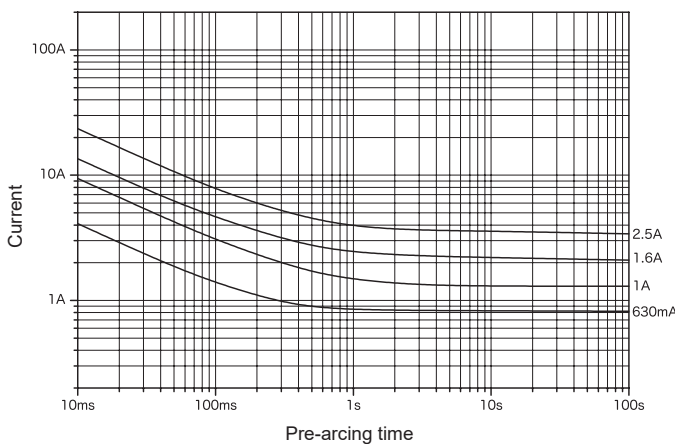

Lead wire diameter  $\phi$  0.5 Scale: 1/1 (mm)

Rated voltage	Certification	Rated current ( $I_N$ ) *1	Rated breaking current	Temp. rise	Current carrying capacity	Overload operation
AC 250 V	UL SP	62 mA–3 A	100 A	PF 0.7–0.8	70 K or less at 1.1 $I_N$	1.1 $I_N$ for 15 min or more after temperature stabilization occurs
	PS E *2				At 1.1 $I_N$ , 140 K or less at the center, 60 K or less at the contact	
						Within 60 min at 1.35 $I_N$ Within 2 min at 2.0 $I_N$

\*1: Customer-requested rated current values can be supplied from within the given range.

\*2: Fuses with rated currents of less than 1 A are not considered electrical products per the Electrical Appliance and Material Safety Law.

Representative pre-arcing time-current characteristics

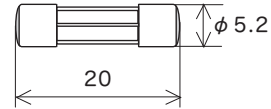
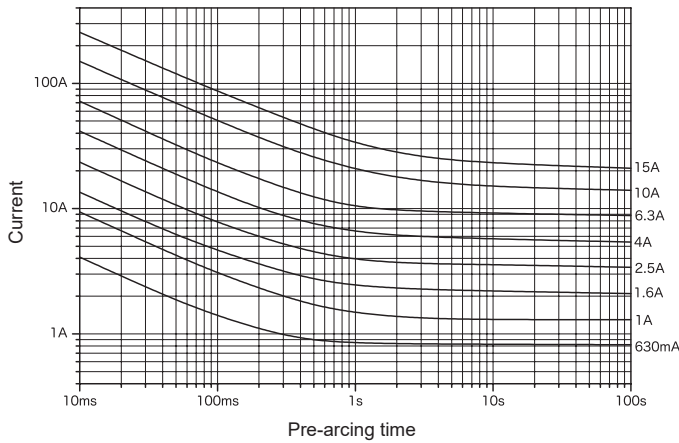

Scale: 1/1 (mm)

Rated voltage	Certification	Rated current (I <sub>N</sub> ) *1	Rated breaking current		Temp. rise	Current carrying capacity	Overload operation
AC 250 V	UL SP	62 mA–3 A	100 A	PF 0.7–0.8	70 K or less at 1.1 I <sub>N</sub>	1.1 I <sub>N</sub> for 15 min or more after temperature stabilization occurs	Within 60 min at 1.35 I <sub>N</sub> Within 2 min at 2.0 I <sub>N</sub>
	RU	Over 3 A–15 A			70 K or less at 1.0 I <sub>N</sub>	1.0 I <sub>N</sub> for 15 min or more after temperature stabilization occurs	

\*1: Customer-requested rated current values can be supplied from within the given range.

\*2: 62 mA–8 A Pb free

Over 8 A–15 A This product uses high melting temperature type solder containing 85% by weight or more lead. This type of solder is exempted from the RoHS Directive.

Representative pre-arcing time-current characteristics

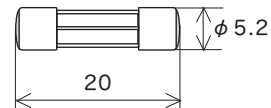
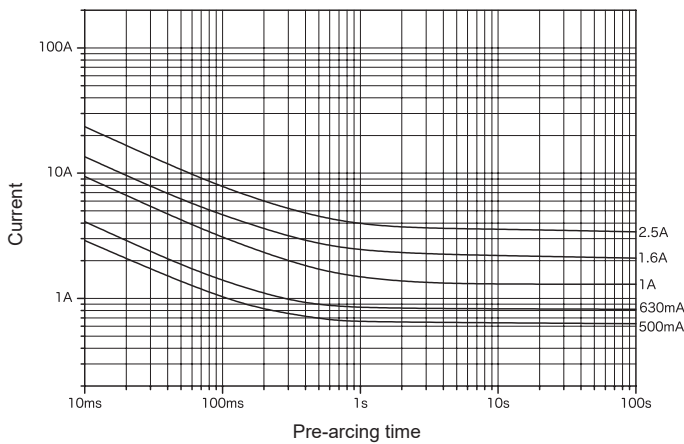

Scale: 1/1 (mm)

Rated voltage	Certification	Rated current (I <sub>N</sub> ) *1	Rated breaking current		Temp. rise	Current carrying capacity	Overload operation
AC 250 V	UL SP	62 mA–3 A	100 A	PF 0.7–0.8	70 K or less at 1.1 I <sub>N</sub>	1.1 I <sub>N</sub> for 15 min or more after temperature stabilization occurs	Within 60 min at 1.35 I <sub>N</sub> Within 2 min at 2.0 I <sub>N</sub>
	PS E *2				At 1.1 I <sub>N</sub> , 140 K or less at the center, 60 K or less at the contact	1.1 I <sub>N</sub> until constant temperature is obtained on each part	

\*1: Customer-requested rated current values can be supplied from within the given range.

\*2: Fuses with rated currents of less than 1 A are not considered electrical products per the Electrical Appliance and Material Safety Law.

# MT3

Inrush-withstand

RoHS-compliant\*2

Pb free\*2

Representative pre-arcing time-current characteristics

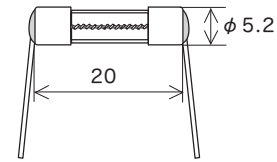
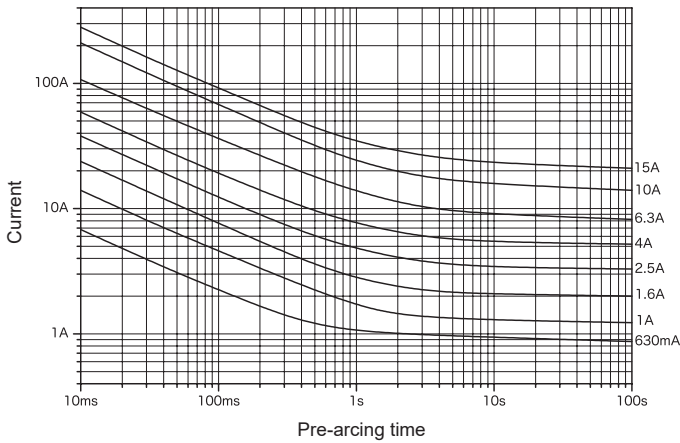

Lead wire diameter  $\phi$  0.5 (100 mA–1 A)  $\phi$  0.8 (Over 1 A–10 A)  $\phi$  1.0 (Over 10 A–15 A) Scale: 1/1 (mm)

Rated voltage	Certification	Rated current (I <sub>N</sub> ) *1	Rated breaking current	Temp. rise	Current carrying capacity	Overload operation		
AC 250 V	UL, CSA	100 mA–3.5 A	100 A	PF 0.7–0.8	70 K or less at 1.1 I <sub>N</sub>	1.1 I <sub>N</sub> for 15 min or more after temperature stabilization occurs		
	RU	Over 3.5 A–8 A					70 K or less at 1.0 I <sub>N</sub>	1.0 I <sub>N</sub> for 15 min or more after temperature stabilization occurs
		Over 8 A–15 A						

\*1: Customer-requested rated current values can be supplied from within the given range.

\*2: 100 mA–8 A Pb free  
Over 8 A–15 A This product uses high melting temperature type solder containing 85% by weight or more lead. This type of solder is exempted from the RoHS Directive.

# MT3 N1

Inrush-withstand

RoHS-compliant

Pb free

Representative pre-arcing time-current characteristics

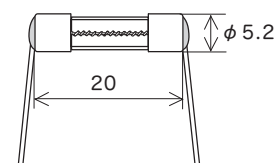
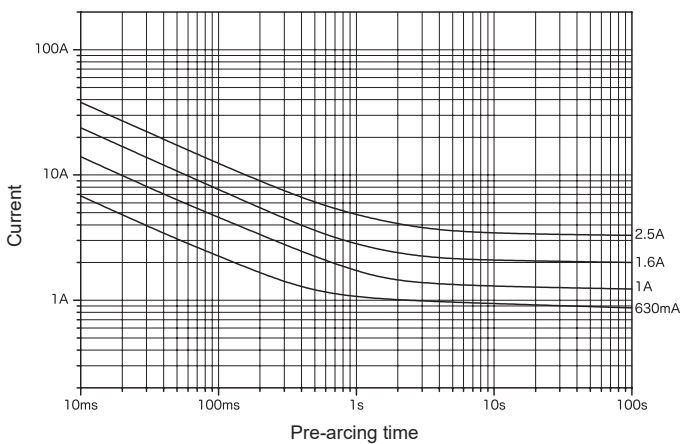

Lead wire diameter  $\phi$  0.5 (100 mA–1 A)  $\phi$  0.8 (Over 1 A–3.5 A) Scale: 1/1 (mm)

Rated voltage	Certification	Rated current (I <sub>N</sub> ) *1	Rated breaking current	Temp. rise	Current carrying capacity	Overload operation
AC 250 V	UL, CSA	100 mA–3.5 A	100 A	PF 0.7–0.8	70 K or less at 1.1 I <sub>N</sub>	1.1 I <sub>N</sub> for 15 min or more after temperature stabilization occurs
	PS E *2					

\*1: Customer-requested rated current values can be supplied from within the given range.

\*2: Fuses with rated currents of less than 1 A are not considered electrical products per the Electrical Appliance and Material Safety Law.

Representative pre-arcing time-current characteristics

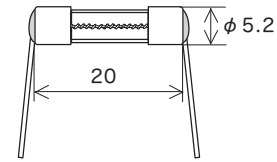
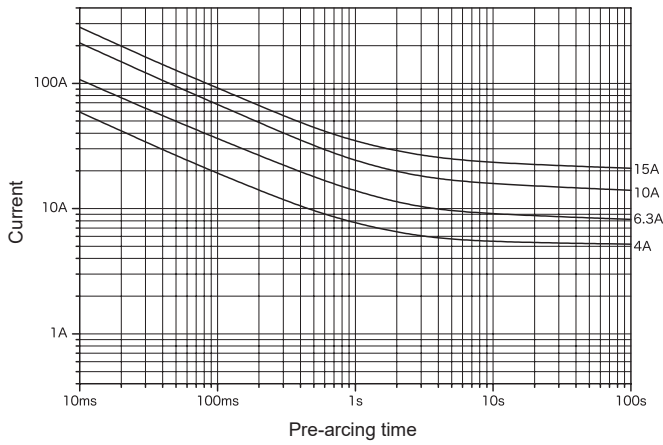

Lead wire diameter  $\phi$  0.8 (Over 3.5 A–10 A)  
 $\phi$  1.0 (Over 10 A–15 A)

Scale: 1/1 (mm)

Rated voltage	Certification	Rated current (I <sub>N</sub> ) *1	Rated breaking current		Temp. rise	Current carrying capacity	Overload operation
AC 250 V		Over 3.5 A–8 A	100 A	PF 0.7–0.8	70 K or less at 1.1 I <sub>N</sub>	1.1 I <sub>N</sub> for 15 min or more after temperature stabilization occurs	Within 60 min at 1.35 I <sub>N</sub> Within 2 min at 2.0 I <sub>N</sub>
		Over 8 A–15 A			70 K or less at 1.0 I <sub>N</sub>	1.0 I <sub>N</sub> for 15 min or more after temperature stabilization occurs	
		Over 3.5 A–15 A			At 1.1 I <sub>N</sub> , 140 K or less at the center, 60 K or less at the contact	1.1 I <sub>N</sub> until constant temperature is obtained on each part	

\*1: Customer-requested rated current values can be supplied from within the given range.

\*2: Over 3.5 A–8 A Pb free  
 Over 8 A–15 A This product uses high melting temperature type solder containing 85% by weight or more lead. This type of solder is exempted from the RoHS Directive.

Representative pre-arcing time-current characteristics

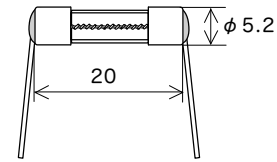
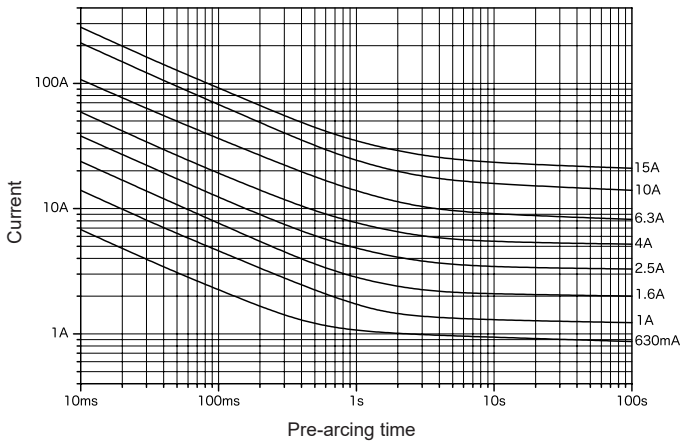

Lead wire diameter  $\phi$  0.5 (100 mA–1 A)  
 $\phi$  0.8 (Over 1 A–10 A)  
 $\phi$  1.0 (Over 10 A–15 A)      Scale: 1/1 (mm)

Rated voltage	Certification	Rated current (I <sub>N</sub> ) *1	Rated breaking current		Temp. rise	Current carrying capacity	Overload operation
AC 250 V		100 mA–3.5 A	100 A	PF 0.7–0.8	70 K or less at 1.1 I <sub>N</sub>	1.1 I <sub>N</sub> for 15 min or more after temperature stabilization occurs	Within 60 min at 1.35 I <sub>N</sub> Within 2 min at 2.0 I <sub>N</sub>
		Over 3.5 A–8 A					
		Over 8 A–15 A					
DC 125 V		100 mA–3.5 A	500 A	Resistive circuit	70 K or less at 1.1 I <sub>N</sub>	1.1 I <sub>N</sub> for 15 min or more after temperature stabilization occurs	
		Over 3.5 A–8 A					
		Over 8 A–15 A					

\*1: Customer-requested rated current values can be supplied from within the given range.

\*2: 100 mA–8 A      Pb free  
 Over 8 A–15 A      This product uses high melting temperature type solder containing 85% by weight or more lead. This type of solder is exempted from the RoHS Directive.

Representative pre-arcing time-current characteristics

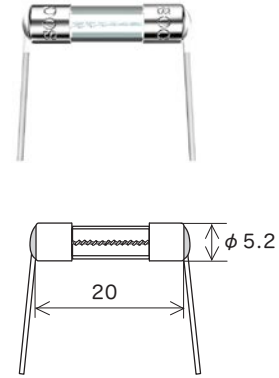
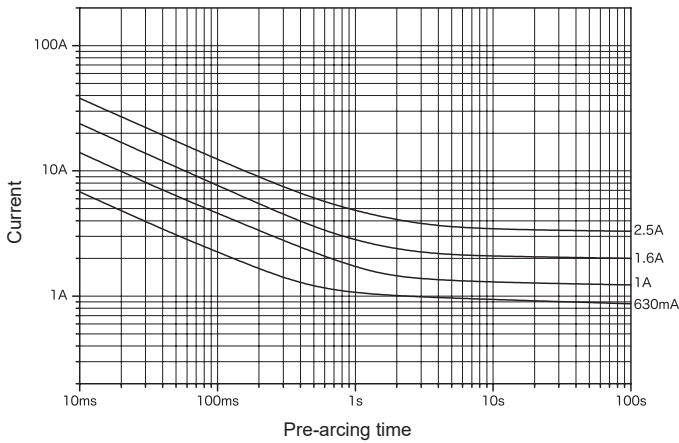

Lead wire diameter  $\phi$  0.5 (100 mA–1 A)  $\phi$  0.8 (Over 1 A–3.5 A) Scale: 1/1 (mm)

Rated voltage	Certification	Rated current ( $I_N$ ) *1	Rated breaking current		Temp. rise	Current carrying capacity	Overload operation
AC 250 V	UL, SP	100 mA–3.5 A	100 A	PF 0.7–0.8	70 K or less at 1.1 $I_N$	1.1 $I_N$ for 15 min or more after temperature stabilization occurs	Within 60 min at 1.35 $I_N$ Within 2 min at 2.0 $I_N$
	PS E *2				At 1.1 $I_N$ , 140 K or less at the center, 60 K or less at the contact	1.1 $I_N$ until constant temperature is obtained on each part	
DC 125 V	UL	500 A	Resistive circuit	70 K or less at 1.1 $I_N$	1.1 $I_N$ for 15 min or more after temperature stabilization occurs		

\*1: Customer-requested rated current values can be supplied from within the given range.

\*2: Fuses with rated currents of less than 1 A are not considered electrical products per the Electrical Appliance and Material Safety Law.

Representative pre-arcing time-current characteristics

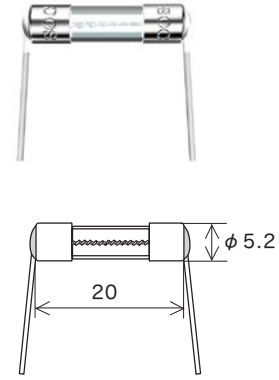
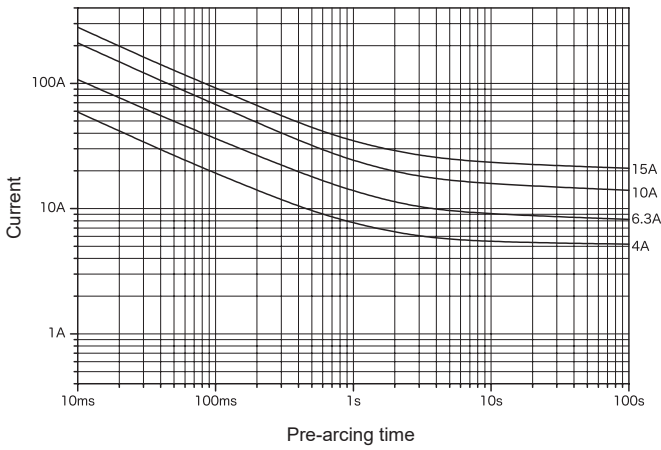

Lead wire diameter  $\phi$  0.8 (Over 3.5 A–10 A)  $\phi$  1.0 (Over 10 A–15 A) Scale: 1/1 (mm)

Rated voltage	Certification	Rated current (I <sub>N</sub> ) *1	Rated breaking current	Temp. rise	Current carrying capacity	Overload operation	
AC 250 V		Over 3.5 A–8 A	100 A	PF 0.7–0.8	70 K or less at 1.1 I <sub>N</sub>	1.1 I <sub>N</sub> for 15 min or more after temperature stabilization occurs	
		Over 8 A–15 A			70 K or less at 1.0 I <sub>N</sub>	1.0 I <sub>N</sub> for 15 min or more after temperature stabilization occurs	
		Over 3.5 A–15 A			At 1.1 I <sub>N</sub> , 140 K or less at the center, 60 K or less at the contact	1.1 I <sub>N</sub> until constant temperature is obtained on each part	Within 60 min at 1.35 I <sub>N</sub> Within 2 min at 2.0 I <sub>N</sub>
DC 125 V		Over 3.5 A–8 A	500 A	Resistive circuit	70 K or less at 1.1 I <sub>N</sub>	1.1 I <sub>N</sub> for 15 min or more after temperature stabilization occurs	
		Over 8 A–15 A			70 K or less at 1.0 I <sub>N</sub>	1.0 I <sub>N</sub> for 15 min or more after temperature stabilization occurs	

\*1: Customer-requested rated current values can be supplied from within the given range.

\*2: Over 3.5 A–8 A Pb free  
Over 8 A–15 A This product uses high melting temperature type solder containing 85% by weight or more lead. This type of solder is exempted from the RoHS Directive.



Representative pre-arcing time-current characteristics

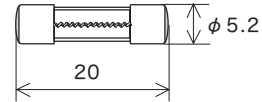
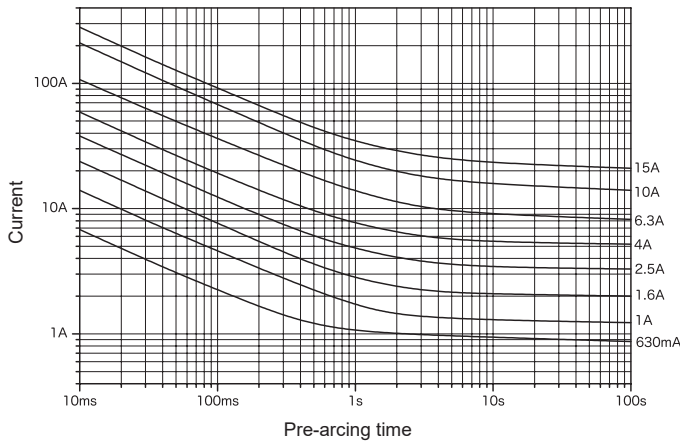

Scale: 1/1 (mm)

Rated voltage	Certification	Rated current (I <sub>N</sub> ) *1	Rated breaking current		Temp. rise	Current carrying capacity	Overload operation
AC 250 V	UL, SA	100 mA–3.5 A	100 A	PF 0.7–0.8	70 K or less at 1.1 I <sub>N</sub>	1.1 I <sub>N</sub> for 15 min or more after temperature stabilization occurs	Within 60 min at 1.35 I <sub>N</sub> Within 2 min at 2.0 I <sub>N</sub>
	RU	Over 3.5 A–8 A				70 K or less at 1.0 I <sub>N</sub>	
		Over 8 A–15 A					

\*1: Customer-requested rated current values can be supplied from within the given range.

\*2: 100 mA–8 A Pb free

Over 8 A–15 A This product uses high melting temperature type solder containing 85% by weight or more lead. This type of solder is exempted from the RoHS Directive.

# MT4 N1

Representative pre-arcing time-current characteristics

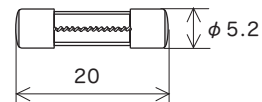
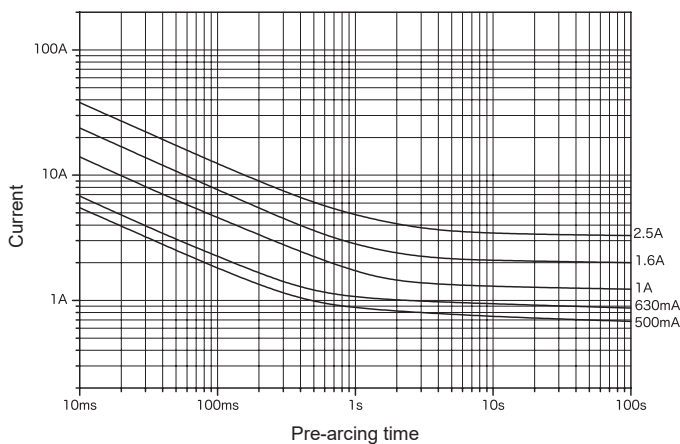

Scale: 1/1 (mm)

Rated voltage	Certification	Rated current (I <sub>N</sub> ) *1	Rated breaking current		Temp. rise	Current carrying capacity	Overload operation
AC 250 V	UL, SA	100 mA–3.5 A	100 A	PF 0.7–0.8	70 K or less at 1.1 I <sub>N</sub>	1.1 I <sub>N</sub> for 15 min or more after temperature stabilization occurs	Within 60 min at 1.35 I <sub>N</sub> Within 2 min at 2.0 I <sub>N</sub>
	PS E *2				At 1.1 I <sub>N</sub> , 140 K or less at the center, 60 K or less at the contact	1.1 I <sub>N</sub> until constant temperature is obtained on each part	



\*1: Customer-requested rated current values can be supplied from within the given range.

\*2: Fuses with rated currents of less than 1 A are not considered electrical products per the Electrical Appliance and Material Safety Law.

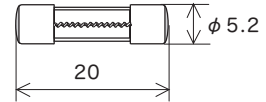
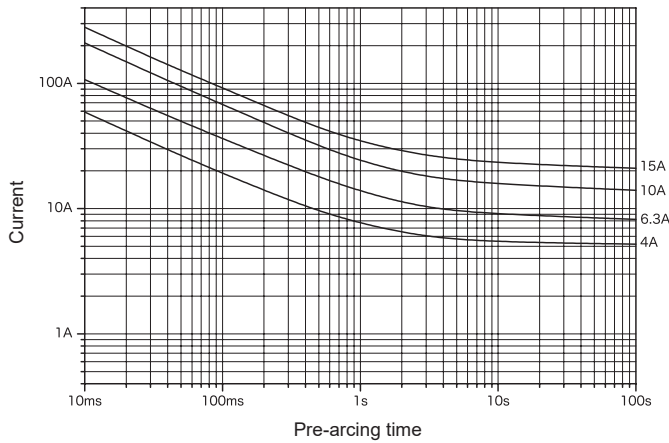
Representative pre-arcing time-current characteristics



Scale: 1/1 (mm)

Rated voltage	Certification	Rated current (I <sub>N</sub> ) *1	Rated breaking current		Temp. rise	Current carrying capacity	Overload operation
AC 250 V		Over 3.5 A–8 A	100 A	PF 0.7–0.8	70 K or less at 1.1 I <sub>N</sub>	1.1 I <sub>N</sub> for 15 min or more after temperature stabilization occurs	Within 60 min at 1.35 I <sub>N</sub> Within 2 min at 2.0 I <sub>N</sub>
		Over 8 A–15 A			70 K or less at 1.0 I <sub>N</sub>	1.0 I <sub>N</sub> for 15 min or more after temperature stabilization occurs	
		Over 3.5 A–15 A			At 1.1 I <sub>N</sub> , 140 K or less at the center, 60 K or less at the contact	1.1 I <sub>N</sub> until constant temperature is obtained on each part	

\*1: Customer-requested rated current values can be supplied from within the given range.

\*2: Over 3.5 A–8 A Pb free  
 Over 8 A–15 A This product uses high melting temperature type solder containing 85% by weight or more lead. This type of solder is exempted from the RoHS Directive.

Representative pre-arcing time-current characteristics

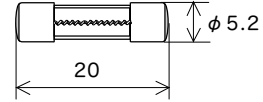
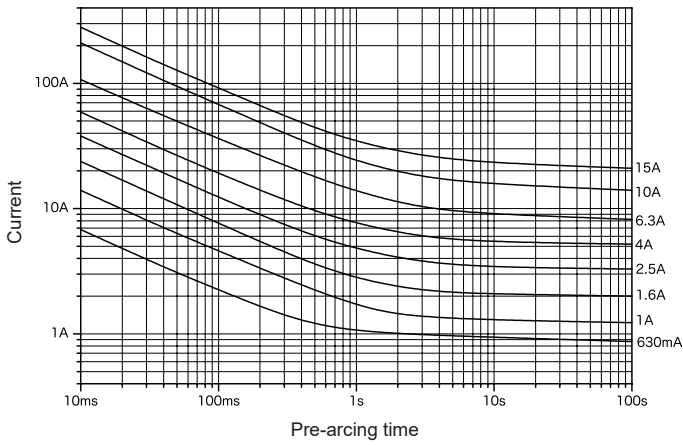

Scale: 1/1 (mm)

Rated voltage	Certification	Rated current (I <sub>N</sub> ) *1	Rated breaking current		Temp. rise	Current carrying capacity	Overload operation
AC 250 V	UL, SFA	100 mA–3.5 A	100 A	PF 0.7–0.8	70 K or less at 1.1 I <sub>N</sub>	1.1 I <sub>N</sub> for 15 min or more after temperature stabilization occurs	Within 60 min at 1.35 I <sub>N</sub> Within 2 min at 2.0 I <sub>N</sub>
	RU	Over 3.5 A–8 A					
		Over 8 A–15 A					
DC 125 V	UL	100 mA–3.5 A	500 A	Resistive circuit	70 K or less at 1.1 I <sub>N</sub>	1.1 I <sub>N</sub> for 15 min or more after temperature stabilization occurs	
	RU	Over 3.5 A–8 A					
		Over 8 A–15 A					

\*1: Customer-requested rated current values can be supplied from within the given range.

\*2: 100 mA–8 A Pb free  
Over 8 A–15 A This product uses high melting temperature type solder containing 85% by weight or more lead. This type of solder is exempted from the RoHS Directive.

Representative pre-arcing time-current characteristics

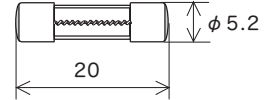
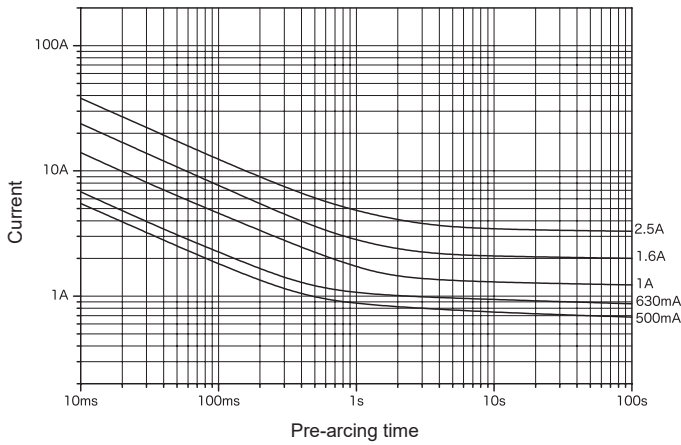

Scale: 1/1 (mm)

Rated voltage	Certification	Rated current (I <sub>N</sub> ) *1	Rated breaking current		Temp. rise	Current carrying capacity	Overload operation
AC 250 V	UL, CSA	100 mA–3.5 A	100 A	PF 0.7–0.8	70 K or less at 1.1 I <sub>N</sub>	1.1 I <sub>N</sub> for 15 min or more after temperature stabilization occurs	Within 60 min at 1.35 I <sub>N</sub> Within 2 min at 2.0 I <sub>N</sub>
	PS E *2				At 1.1 I <sub>N</sub> , 140 K or less at the center, 60 K or less at the contact	1.1 I <sub>N</sub> until constant temperature is obtained on each part	
DC 125 V	UL	500 A	Resistive circuit	70 K or less at 1.1 I <sub>N</sub>	1.1 I <sub>N</sub> for 15 min or more after temperature stabilization occurs		

\*1: Customer-requested rated current values can be supplied from within the given range.

\*2: Fuses with rated currents of less than 1 A are not considered electrical products per the Electrical Appliance and Material Safety Law.

Representative pre-arcing time-current characteristics

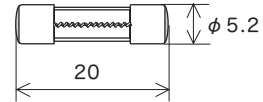
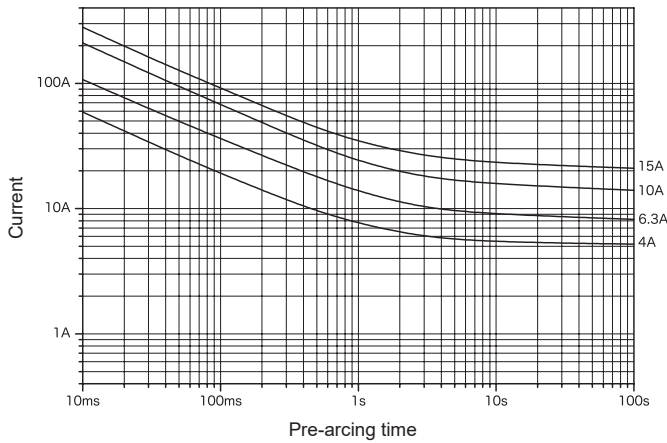

Scale: 1/1 (mm)

Rated voltage	Certification	Rated current (I <sub>N</sub> ) *1	Rated breaking current		Temp. rise	Current carrying capacity	Overload operation
AC 250V		Over 3.5 A–8 A	100 A	PF 0.7–0.8	70 K or less at 1.1 I <sub>N</sub>	1.1 I <sub>N</sub> for 15 min or more after temperature stabilization occurs	Within 60 min at 1.35 I <sub>N</sub> Within 2 min at 2.0 I <sub>N</sub>
		Over 8 A–15 A			70 K or less at 1.0 I <sub>N</sub>	1.0 I <sub>N</sub> for 15 min or more after temperature stabilization occurs	
		Over 3.5 A–15 A			At 1.1 I <sub>N</sub> , 140 K or less at the center, 60 K or less at the contact	1.1 I <sub>N</sub> until constant temperature is obtained on each part	
DC 125V		Over 3.5 A–8 A	500 A	Resistive circuit	70 K or less at 1.1 I <sub>N</sub>	1.1 I <sub>N</sub> for 15 min or more after temperature stabilization occurs	
		Over 8 A–15 A			70 K or less at 1.0 I <sub>N</sub>	1.0 I <sub>N</sub> for 15 min or more after temperature stabilization occurs	

\*1: Customer-requested rated current values can be supplied from within the given range.

\*2: Over 3.5 A–8 A Pb free  
Over 8 A–15 A This product uses high melting temperature type solder containing 85% by weight or more lead. This type of solder is exempted from the RoHS Directive.

# MT7

Inrush-withstand

RoHS-compliant

Pb free

Representative pre-arcing time-current characteristics

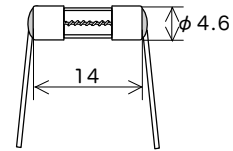
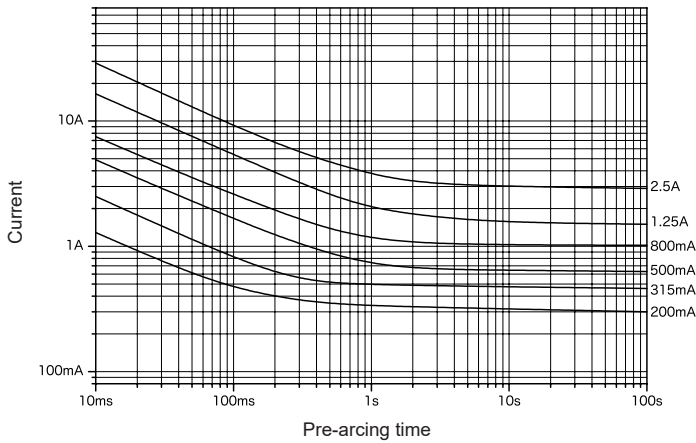

Lead wire diameter  $\phi 0.8$  Scale: 1/1 (mm)

Rated voltage	Certification	Rated current (I <sub>N</sub> ) *1	Rated breaking current		Temp. rise	Current carrying capacity	Overload operation
AC 125 V		100 mA–3 A	10000 A	PF 0.7–0.8	70 K or less at 1.1 I <sub>N</sub>	1.1 I <sub>N</sub> for 15 min or more after temperature stabilization occurs	Within 60 min at 1.35 I <sub>N</sub> Within 2 min at 2.0 I <sub>N</sub>

\*1: Customer-requested rated current values can be supplied from within the given range.

# MT8

Inrush-withstand

RoHS-compliant

Pb free

Representative pre-arcing time-current characteristics

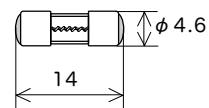
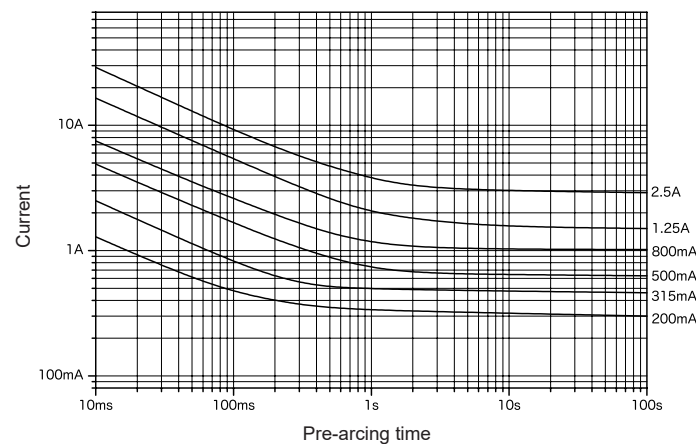

Scale: 1/1 (mm)

Rated voltage	Certification	Rated current (I <sub>N</sub> ) *1	Rated breaking current		Temp. rise	Current carrying capacity	Overload operation
AC 125 V		100 mA–3 A	10000 A	PF 0.7–0.8	70 K or less at 1.1 I <sub>N</sub>	1.1 I <sub>N</sub> for 15 min or more after temperature stabilization occurs	Within 60 min at 1.35 I <sub>N</sub> Within 2 min at 2.0 I <sub>N</sub>

\*1: Customer-requested rated current values can be supplied from within the given range.

Representative pre-arcing time-current characteristics

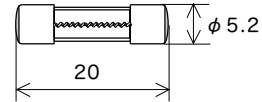
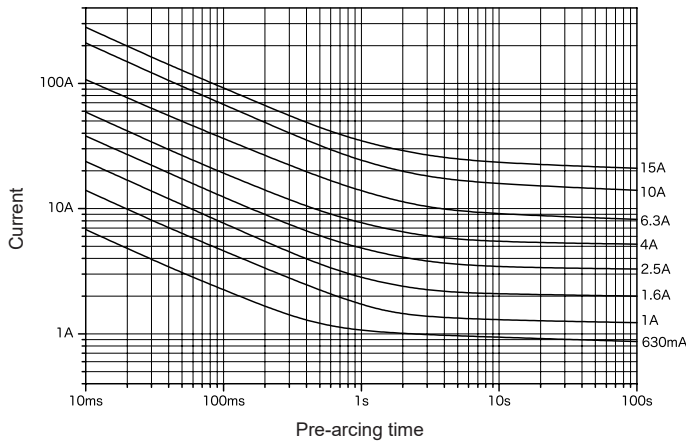

Scale: 1/1 (mm)

Maximum working voltage	Certification	Rated current (I <sub>N</sub> ) *1	Maximum breaking current		Temp. rise	Current carrying capacity	Overload operation
AC 42 V DC 42 V	-	100 mA–20 A	100 A	Resistive circuit	70 K or less at 1.0 I <sub>N</sub>	1.0 I <sub>N</sub> for 15 min or more after temperature stabilization occurs	Within 60 min at 1.35 I <sub>N</sub> Within 2 min at 2.0 I <sub>N</sub>

\*1: Customer-requested rated current values can be supplied from within the given range.

\*2: 100 mA–8 A Pb free  
Over 8 A–20 A This product uses high melting temperature type solder containing 85% by weight or more lead. This type of solder is exempted from the RoHS Directive.

Representative pre-arcing time-current characteristics

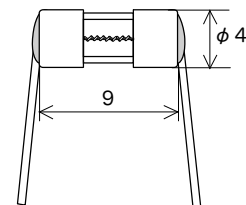
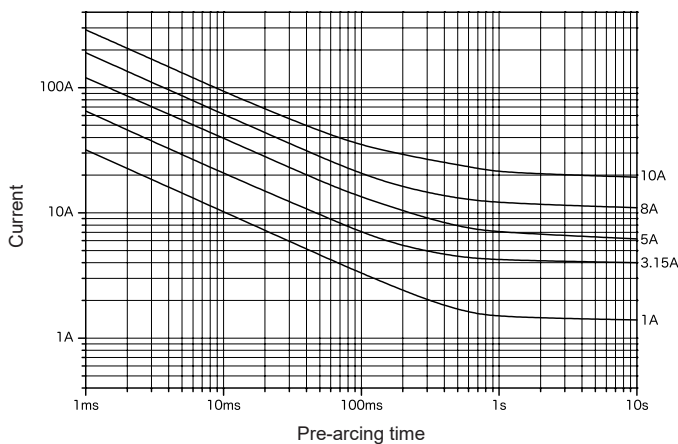

Lead wire diameter  $\phi$  0.8

Scale: 2/1 (mm)

Maximum working voltage	Certification	Rated current (I <sub>N</sub> ) *1	Maximum breaking current		Temp. rise	Current carrying capacity	Overload operation
DC 100 V	-	100 mA–10 A	100 A	Resistive circuit	75 K or less at 1.0 I <sub>N</sub>	1.0 I <sub>N</sub> for 15 min or more after temperature stabilization occurs	Within 60 s at 2.0 I <sub>N</sub>

\*1: Customer-requested rated current values can be supplied from within the given range.





# NT1

Inrush-withstand

RoHS-compliant\*2

Representative pre-arcing time-current characteristics

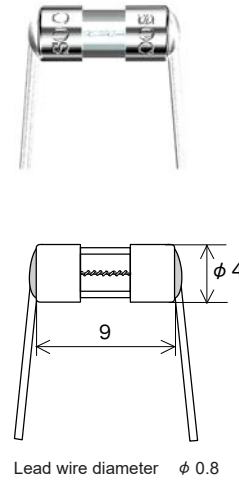
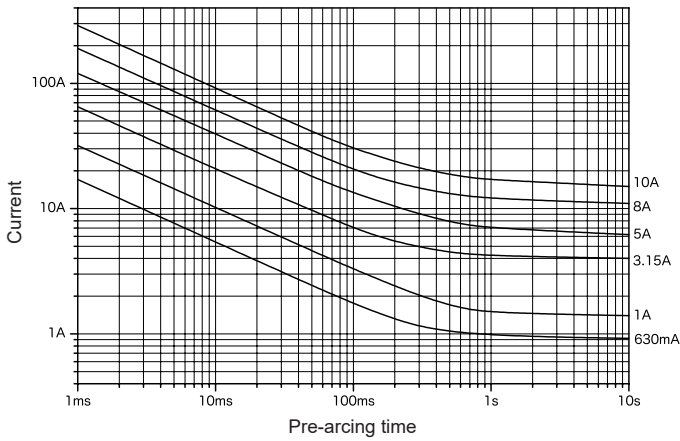

Scale: 2/1 (mm)

Rated voltage	Certification	Rated current (I <sub>N</sub> ) *1	Rated breaking current	Temp. rise	Current carrying capacity	Overload operation
AC 125 V		100 mA–10 A	50 A	70 K or less at 1.0 I <sub>N</sub>	1.0 I <sub>N</sub> for 15 min or more after temperature stabilization occurs	Within 10 min at 1.5 I <sub>N</sub> Within 60 s 2.0 I <sub>N</sub>

\*1: Customer-requested rated current values can be supplied from within the given range.

\*2: This product uses high melting temperature type solder containing 85% by weight or more lead. This type of solder is exempted from the RoHS Directive.

# NT3

Inrush-withstand

RoHS-compliant\*2

Representative pre-arcing time-current characteristics

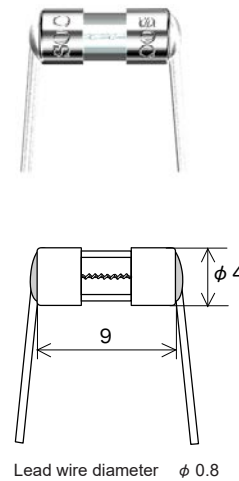
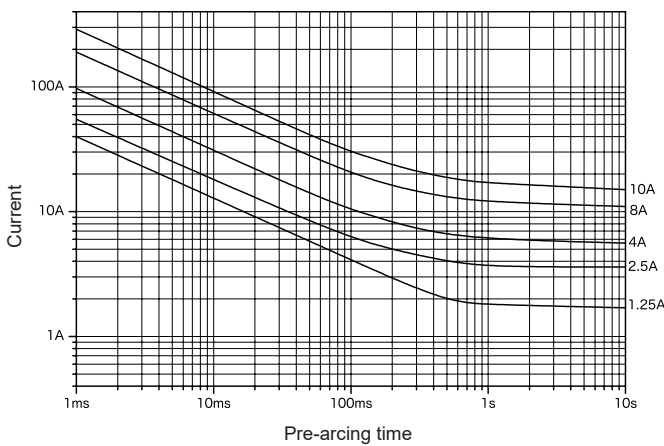

Scale: 2/1 (mm)

Rated voltage	Certification	Rated current (I <sub>N</sub> ) *1	Rated breaking current	Temp. rise	Current carrying capacity	Overload operation
AC 250V		100 mA–10 A	50 A	70 K or less at 1.0 I <sub>N</sub>	1.0 I <sub>N</sub> for 15 min or more after temperature stabilization occurs	Within 10 min at 1.5 I <sub>N</sub> Within 60 s 2.0 I <sub>N</sub>

\*1: Customer-requested rated current values can be supplied from within the given range.

\*2: This product uses high melting temperature type solder containing 85% by weight or more lead. This type of solder is exempted from the RoHS Directive.

Representative pre-arcing time-current characteristics

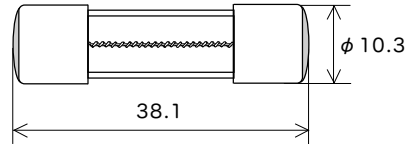
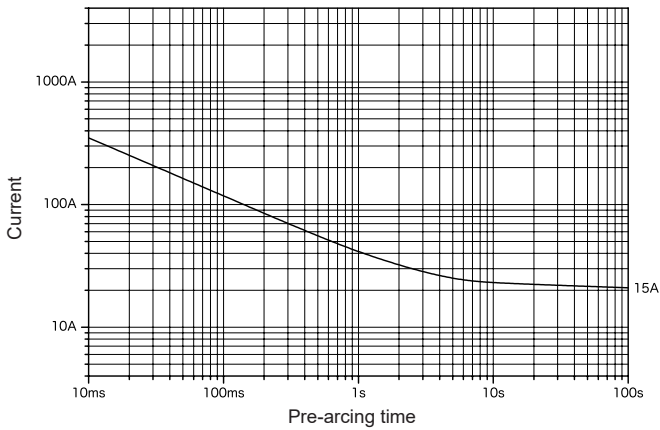

Scale: 1/1 (mm)

Rated voltage	Certification	Rated current (I <sub>N</sub> ) *1	Rated breaking current		Temp. rise	Current carrying capacity	Overload operation
AC 125 V		3 A–15 A	10000 A	PF 0.7–0.8	70 K or less at 1.1 I <sub>N</sub>	1.1 I <sub>N</sub> for 15 min or more after temperature stabilization occurs	Within 60 min at 1.35 I <sub>N</sub> Within 2 min at 2.0 I <sub>N</sub>

\*1: Customer-requested rated current values can be supplied from within the given range.

\*2: 3 A–12 A Pb free  
Over 12 A–15 A This product uses high melting temperature type solder containing 85% by weight or more lead. This type of solder is exempted from the RoHS Directive.

Representative pre-arcing time-current characteristics

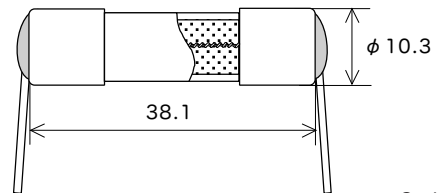
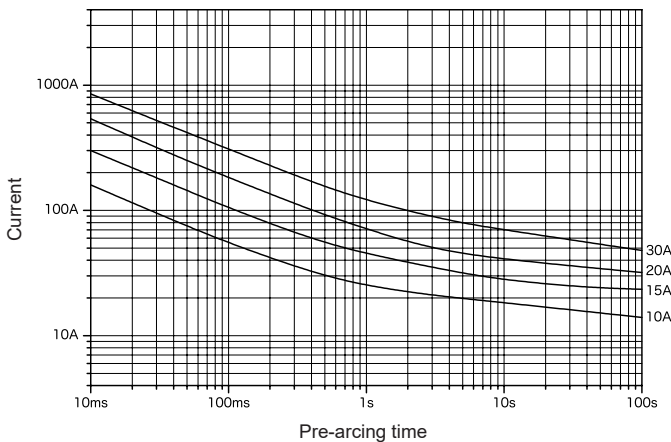

Scale: 1/1 (mm)  
Lead wire diameter  $\phi$  1.2

Rated voltage	Certification	Rated current (I <sub>N</sub> ) *1	Rated breaking current		Temp. rise	Current carrying capacity	Overload operation
AC 250 V		100 mA–30 A	1500 A	PF 0.7–0.8	75 K or less at 1.0 I <sub>N</sub>	1.0 I <sub>N</sub> for 15 min or more after temperature stabilization occurs	Within 60 min at 1.35 I <sub>N</sub> Within 2 min at 2.0 I <sub>N</sub>

\*1: Customer-requested rated current values can be supplied from within the given range.

\*2: 100 mA–12 A Pb free  
Over 12 A–30 A This product uses high melting temperature type solder containing 85% by weight or more lead. This type of solder is exempted from the RoHS Directive.

# SKM10

Inrush-withstand

RoHS-compliant\*2

Pb free\*2

Representative pre-arcing time-current characteristics

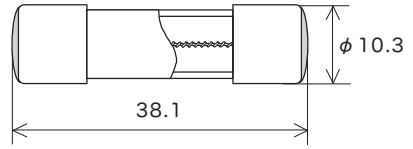
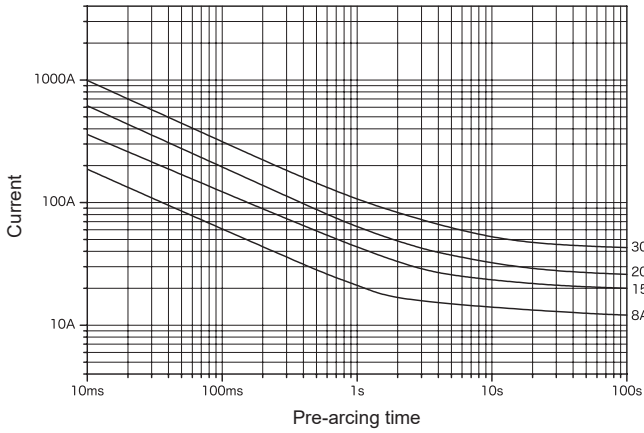

Scale: 1/1 (mm)

Rated voltage	Certification	Rated current ( $I_N$ ) *1	Rated breaking current		Temp. rise	Current carrying capacity	Overload operation
AC 250 V		100 mA–30 A	1000 A	Resistive circuit	100 K or less at 1.0 $I_N$	1.0 $I_N$ until temperature stabilization occurs	Within 60 min at 1.35 $I_N$ Within 2 min at 2.0 $I_N$

\*1: Customer-requested rated current values can be supplied from within the given range.

\*2: 100 mA–12 A Pb free

Over 12 A–30 A This product uses high melting temperature type solder containing 85% by weight or more lead. This type of solder is exempted from the RoHS Directive.

# SKM10 N1

Inrush-withstand

RoHS-compliant\*2

Pb free\*2

Representative pre-arcing time-current characteristics

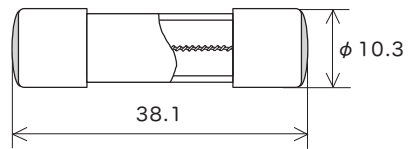
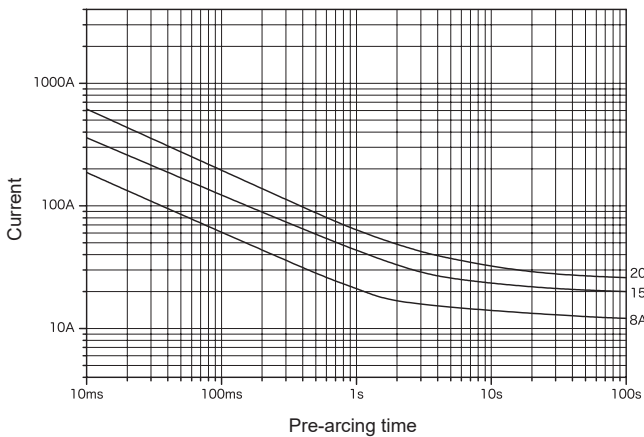

Scale: 1/1 (mm)

Rated voltage	Certification	Rated current ( $I_N$ ) *1	Rated breaking current		Temp. rise	Current carrying capacity	Overload operation
AC 250 V		1 A–25 A	1000 A	Resistive circuit	100 K or less at 1.0 $I_N$	1.0 $I_N$ until temperature stabilization occurs	Within 60 min at 1.35 $I_N$ Within 2 min at 2.0 $I_N$
			100 A	PF 0.7–0.8	At 1.1 $I_N$ , 140 K or less at the center, 60 K or less at the contact	1.1 $I_N$ until constant temperature is obtained on each part	

\*1: Customer-requested rated current values can be supplied from within the given range.

\*2: 1 A–12 A Pb free

Over 12 A–25 A This product uses high melting temperature type solder containing 85% by weight or more lead. This type of solder is exempted from the RoHS Directive.

# SL2

Normal-acting

RoHS-compliant

Pb free

Representative pre-arcing time-current characteristics

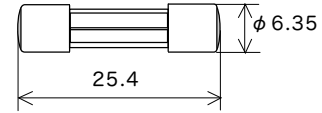
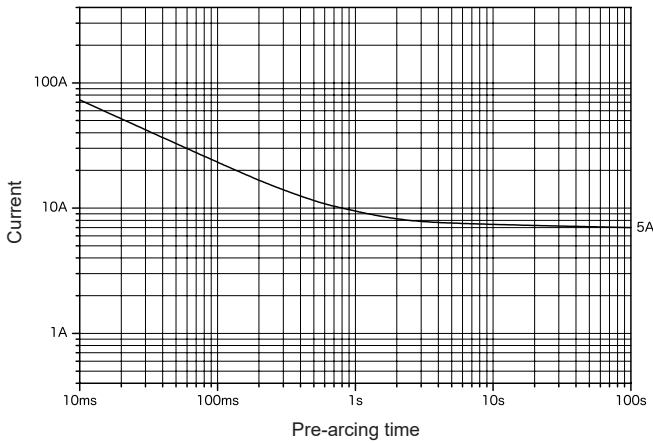

Scale: 1/1 (mm)

Rated voltage	Certification	Rated current (I <sub>N</sub> ) *1	Rated breaking current		Temp. rise	Current carrying capacity	Overload operation
AC 125 V		80 mA–6 A	10000 A	PF 0.7–0.8	70 K or less at 1.1 I <sub>N</sub>	1.1 I <sub>N</sub> for 15 min or more after temperature stabilization occurs	Within 60 min at 1.35 I <sub>N</sub> Within 2 min at 2.0 I <sub>N</sub>

\*1: Customer-requested rated current values can be supplied from within the given range.

# SL4

Normal-acting

RoHS-compliant

Pb free

Representative pre-arcing time-current characteristics

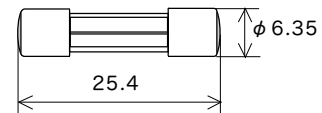
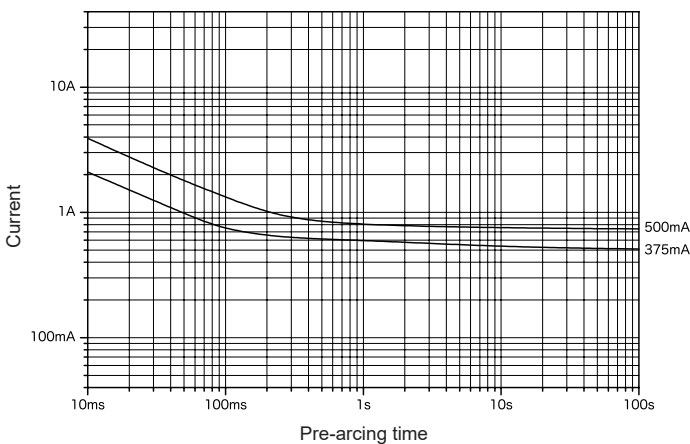

Scale: 1/1 (mm)

Rated voltage	Certification	Rated current (I <sub>N</sub> ) *1	Rated breaking current		Temp. rise	Current carrying capacity	Overload operation
AC 250 V		80 mA–2 A	100 A	PF 0.7–0.8	70 K or less at 1.1 I <sub>N</sub>	1.1 I <sub>N</sub> for 15 min or more after temperature stabilization occurs	Within 60 min at 1.35 I <sub>N</sub> Within 2 min at 2.0 I <sub>N</sub>

\*1: Customer-requested rated current values can be supplied from within the given range.

# SQ7

Normal-acting

RoHS-compliant

Pb free

Representative pre-arcing time-current characteristics

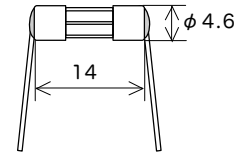
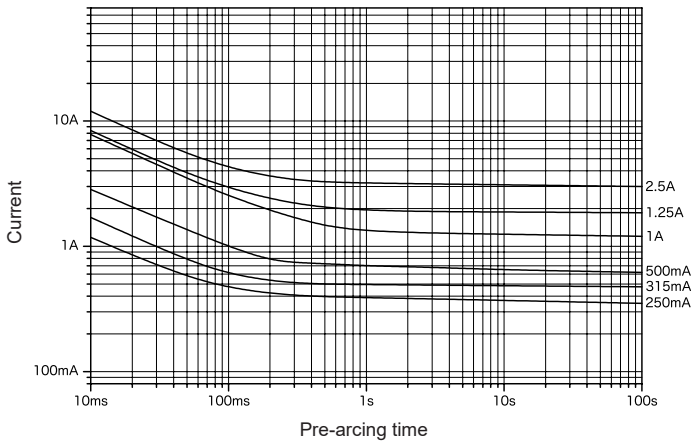

Lead wire diameter  $\phi$  0.8

Scale: 1/1 (mm)

Rated voltage	Certification	Rated current (I <sub>N</sub> ) *1	Rated breaking current		Temp. rise	Current carrying capacity	Overload operation
AC 125 V		80 mA–3 A	10000 A	PF 0.7–0.8	70 K or less at 1.1 I <sub>N</sub>	1.1 I <sub>N</sub> for 15 min or more after temperature stabilization occurs	Within 60 min at 1.35 I <sub>N</sub> Within 2 min at 2.0 I <sub>N</sub>

\*1: Customer-requested rated current values can be supplied from within the given range.

# SQ8

Normal-acting

RoHS-compliant

Pb free

Representative pre-arcing time-current characteristics

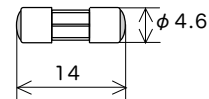
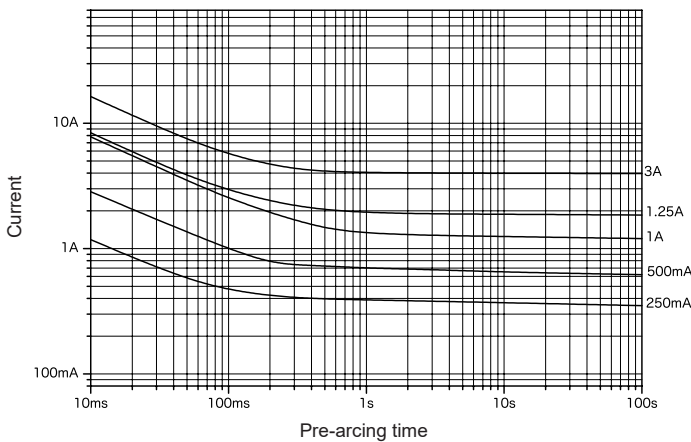

Scale: 1/1 (mm)

Rated voltage	Certification	Rated current (I <sub>N</sub> ) *1	Rated breaking current		Temp. rise	Current carrying capacity	Overload operation
AC 125 V		80 mA–3 A	10000 A	PF 0.7–0.8	70 K or less at 1.1 I <sub>N</sub>	1.1 I <sub>N</sub> for 15 min or more after temperature stabilization occurs	Within 60 min at 1.35 I <sub>N</sub> Within 2 min at 2.0 I <sub>N</sub>

\*1: Customer-requested rated current values can be supplied from within the given range.

Representative pre-arcing time-current characteristics

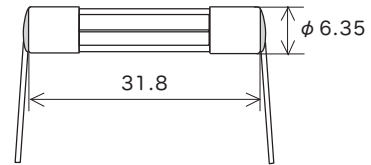
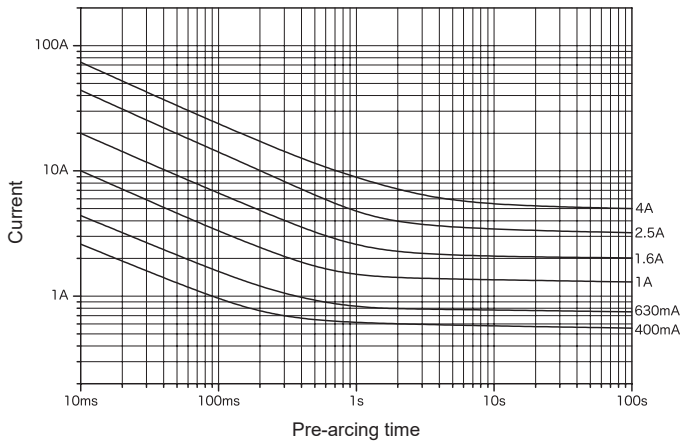

Lead wire diameter  $\phi$  0.8 Scale: 1/1 (mm)

Rated voltage	Certification	Rated current (I <sub>N</sub> ) *1	Rated breaking current	Temp. rise	Current carrying capacity	Overload operation
AC 250 V		50 mA–5 A	10000 A PF 0.7–0.8	70 K or less at 1.1 I <sub>N</sub>	1.1 I <sub>N</sub> for 15 min or more after temperature stabilization occurs	Within 60 min at 1.35 I <sub>N</sub> Within 2 min at 2.0 I <sub>N</sub>

\*1: Customer-requested rated current values can be supplied from within the given range.

Representative pre-arcing time-current characteristics

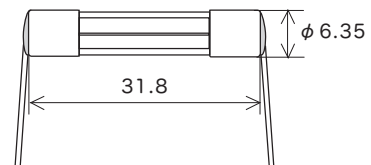
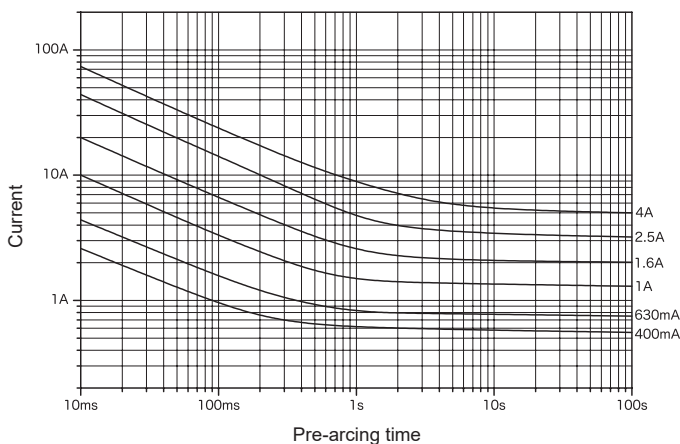

Lead wire diameter  $\phi$  0.8 Scale: 1/1 (mm)

Rated voltage	Certification	Rated current (I <sub>N</sub> ) *1	Rated breaking current	Temp. rise	Current carrying capacity	Overload operation
AC 250 V		50 mA–5 A	10000 A	70 K or less at 1.1 I <sub>N</sub>  At 1.1 I <sub>N</sub> , 140 K or less at the center, 60 K or less at the contact	1.1 I <sub>N</sub> for 15 min or more after temperature stabilization occurs	Within 60 min at 1.35 I <sub>N</sub> Within 2 min at 2.0 I <sub>N</sub>
			500 A		1.1 I <sub>N</sub> until constant temperature is obtained on each part	

\*1: Customer-requested rated current values can be supplied from within the given range.

\*2: Fuses with rated currents of less than 1 A are not considered electrical products per the Electrical Appliance and Material Safety Law.

Representative pre-arcing time-current characteristics

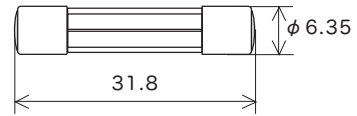
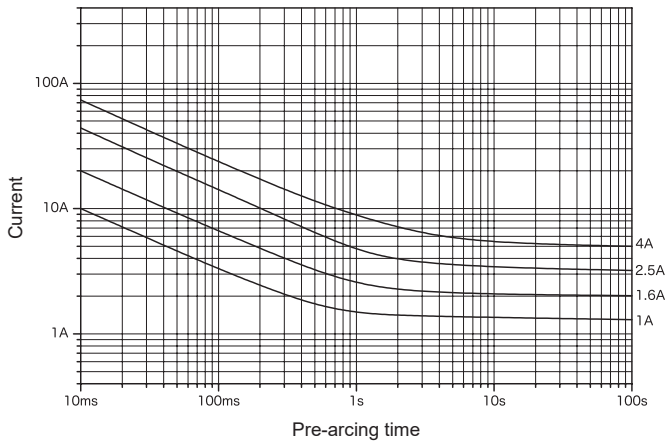

Scale: 1/1 (mm)

Rated voltage	Certification	Rated current (I <sub>N</sub> ) *1	Rated breaking current	Temp. rise	Current carrying capacity	Overload operation
AC 250 V	UL, SFA	50 mA–5 A	10000 A PF 0.7–0.8	70 K or less at 1.1 I <sub>N</sub>	1.1 I <sub>N</sub> for 15 min or more after temperature stabilization occurs	Within 60 min at 1.35 I <sub>N</sub> Within 2 min at 2.0 I <sub>N</sub>

\*1: Customer-requested rated current values can be supplied from within the given range.

Representative pre-arcing time-current characteristics

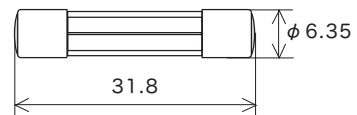
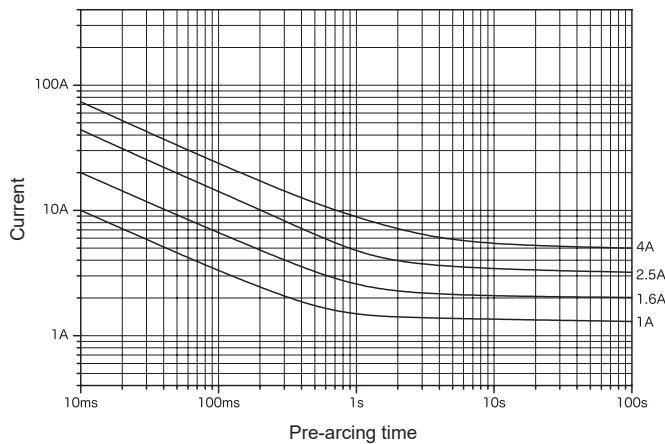

Scale: 1/1 (mm)

Rated voltage	Certification	Rated current (I <sub>N</sub> ) *1	Rated breaking current	Temp. rise	Current carrying capacity	Overload operation
AC 250 V	UL, SFA	50 mA–5 A	10000 A	70 K or less at 1.1 I <sub>N</sub>  At 1.1 I <sub>N</sub> , 140 K or less at the center, 60 K or less at the contact	1.1 I <sub>N</sub> for 15 min or more after temperature stabilization occurs	Within 60 min at 1.35 I <sub>N</sub> Within 2 min at 2.0 I <sub>N</sub>
	PS E *2		500 A		1.1 I <sub>N</sub> until constant temperature is obtained on each part	

\*1: Customer-requested rated current values can be supplied from within the given range.

\*2: Fuses with rated currents of less than 1 A are not considered electrical products per the Electrical Appliance and Material Safety Law.

Representative pre-arcing time-current characteristics

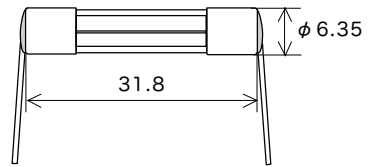
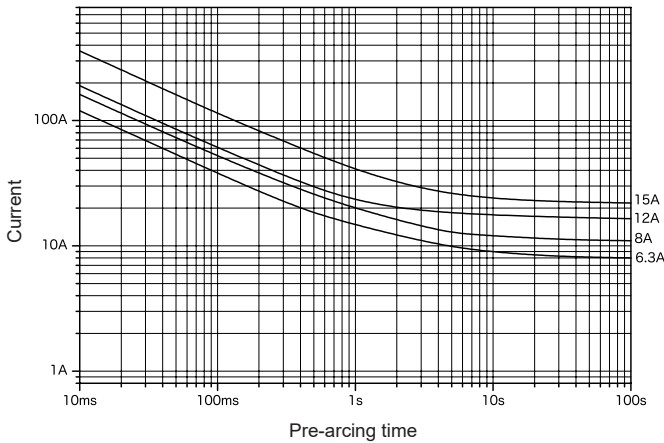

Lead wire diameter  $\phi$  0.8 (Over 5 A–8 A)  $\phi$  1.0 (Over 8 A–15 A) Scale: 1/1 (mm)

Rated voltage	Certification	Rated current (I <sub>N</sub> ) *1	Rated breaking current	Temp. rise	Current carrying capacity	Overload operation
AC 250 V	UL, SA	Over 5 A–8 A	200 A	PF 0.7–0.8	70 K or less at 1.1 I <sub>N</sub>	1.1 I <sub>N</sub> for 15 min or more after temperature stabilization occurs
AC 125 V	RU, SA	Over 8 A–15 A	10000 A		70 K or less at 1.0 I <sub>N</sub>	1.0 I <sub>N</sub> for 15 min or more after temperature stabilization occurs

\*1: Customer-requested rated current values can be supplied from within the given range.

\*2: Over 5 A–8 A Pb free  
Over 8 A–15 A This product uses high melting temperature type solder containing 85% by weight or more lead. This type of solder is exempted from the RoHS Directive.

Representative pre-arcing time-current characteristics

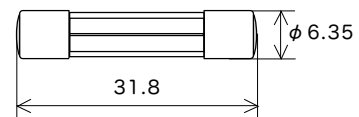
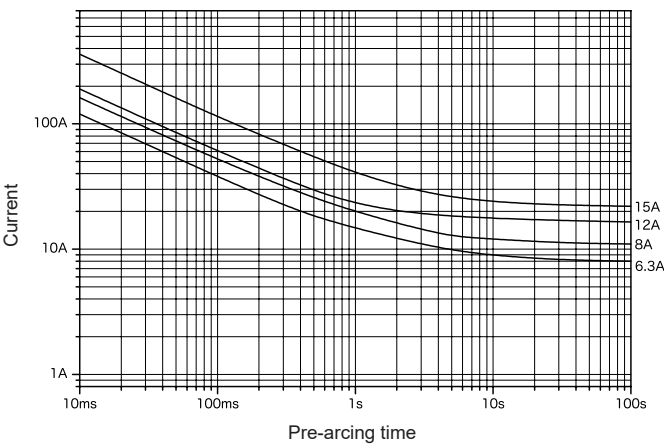

Scale: 1/1 (mm)

Rated voltage	Certification	Rated current (I <sub>N</sub> ) *1	Rated breaking current	Temp. rise	Current carrying capacity	Overload operation
AC 250 V	UL, SA	Over 5 A–8 A	200 A	PF 0.7–0.8	70 K or less at 1.1 I <sub>N</sub>	1.1 I <sub>N</sub> for 15 min or more after temperature stabilization occurs
AC 125 V	RU, SA	Over 8 A–15 A	10000 A		70 K or less at 1.0 I <sub>N</sub>	1.0 I <sub>N</sub> for 15 min or more after temperature stabilization occurs

\*1: Customer-requested rated current values can be supplied from within the given range.

\*2: Over 5 A–8 A Pb free  
Over 8 A–15 A This product uses high melting temperature type solder containing 85% by weight or more lead. This type of solder is exempted from the RoHS Directive.



Representative pre-arcing time-current characteristics

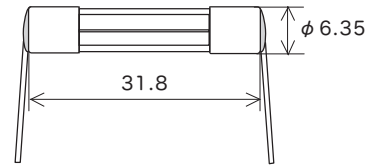
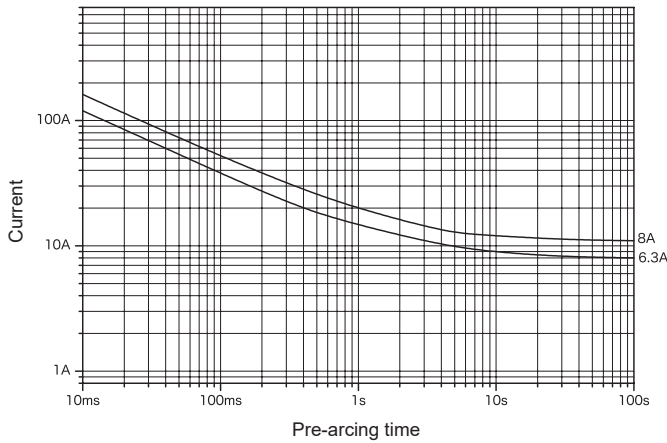

Lead wire diameter  $\phi$  0.8 (Over 5 A–8 A)  $\phi$  1.0 (Over 8 A–15 A) Scale: 1/1 (mm)

Rated voltage	Certification	Rated current (I <sub>N</sub> ) *1	Rated breaking current	Temp. rise	Current carrying capacity	Overload operation
AC 250 V	UL, SA	Over 5 A–8 A	200 A	70 K or less at 1.1 I <sub>N</sub>	1.1 I <sub>N</sub> for 15 min or more after temperature stabilization occurs	Within 60 min at 1.35 I <sub>N</sub> Within 2 min at 2.0 I <sub>N</sub>
	PS E		100 A		At 1.1 I <sub>N</sub> , 140 K or less at the center, 60 K or less at the contact	
AC 125 V	RU, SA	Over 8 A–15 A	10000 A	70 K or less at 1.0 I <sub>N</sub>	1.0 I <sub>N</sub> for 15 min or more after temperature stabilization occurs	
	PS E		500 A		At 1.1 I <sub>N</sub> , 140 K or less at the center, 60 K or less at the contact	

\*1: Customer-requested rated current values can be supplied from within the given range.

\*2: Over 5 A–8 A Pb free  
Over 8 A–15 A This product uses high melting temperature type solder containing 85% by weight or more lead. This type of solder is exempted from the RoHS Directive.

Representative pre-arcing time-current characteristics

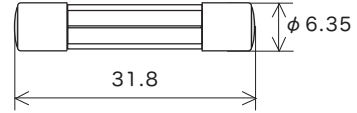
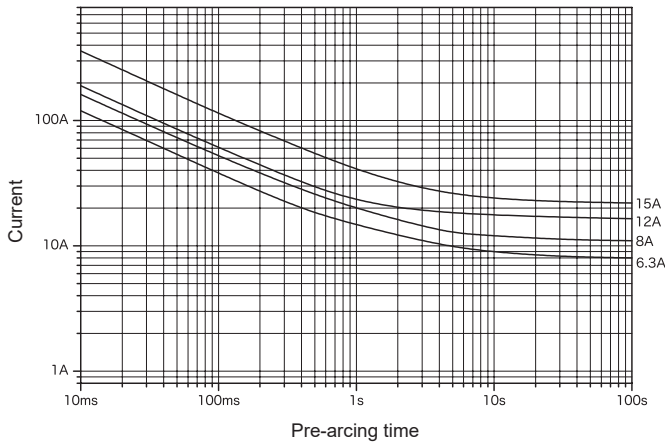

Scale: 1/1 (mm)

Rated voltage	Certification	Rated current (I <sub>N</sub> ) *1	Rated breaking current	Temp. rise	Current carrying capacity	Overload operation
AC 250 V	UL, SA	Over 5 A–8 A	200 A	70 K or less at 1.1 I <sub>N</sub>	1.1 I <sub>N</sub> for 15 min or more after temperature stabilization occurs	Within 60 min at 1.35 I <sub>N</sub> Within 2 min at 2.0 I <sub>N</sub>
	PS E		100 A		At 1.1 I <sub>N</sub> , 140 K or less at the center, 60 K or less at the contact	
AC 125 V	RU, SA	Over 8 A–15 A	10000 A	70 K or less at 1.0 I <sub>N</sub>	1.0 I <sub>N</sub> for 15 min or more after temperature stabilization occurs	
	PS E		500 A		At 1.1 I <sub>N</sub> , 140 K or less at the center, 60 K or less at the contact	

PF 0.7–0.8

\*1: Customer-requested rated current values can be supplied from within the given range.

\*2: Over 5 A–8 A Pb free  
Over 8 A–15 A This product uses high melting temperature type solder containing 85% by weight or more lead. This type of solder is exempted from the RoHS Directive.

# ST3

Inrush-withstand

RoHS-compliant\*2

Pb free\*2

Representative pre-arcing time-current characteristics

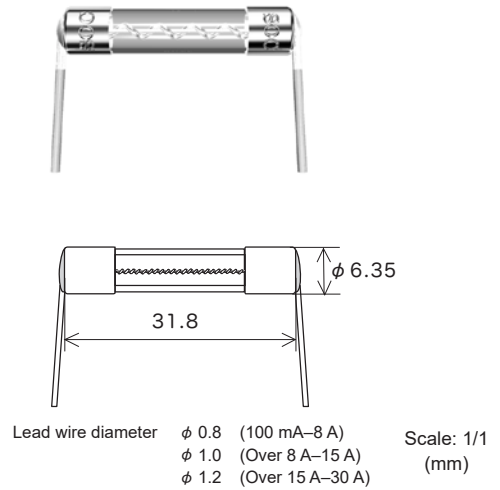
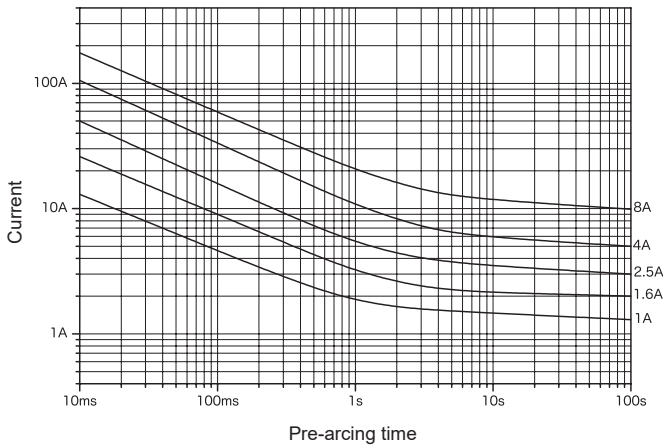

Rated voltage	Certification	Rated current (I <sub>N</sub> ) *1	Rated breaking current	Temp. rise	Current carrying capacity	Overload operation
AC 250 V		100 mA-1 A	10000 A	PF 0.7-0.8	70 K or less at 1.1 I <sub>N</sub>	Within 60 min at 1.35 I <sub>N</sub> Within 2 min at 2.0 I <sub>N</sub>
		Over 1 A-8 A	200 A			
		Over 8 A-30 A		-	1.0 I <sub>N</sub> until constant temperature is obtained on each part	

\*1: Customer-requested rated current values can be supplied from within the given range.

\*2: 100 mA-8 A Pb free  
 Over 8 A-30 A This product uses high melting temperature type solder containing 85% by weight or more lead. This type of solder is exempted from the RoHS Directive.

# ST3 N1

Inrush-withstand

RoHS-compliant

Pb free

Representative pre-arcing time-current characteristics

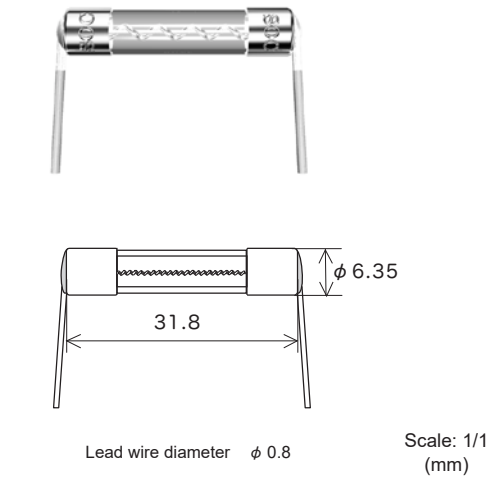
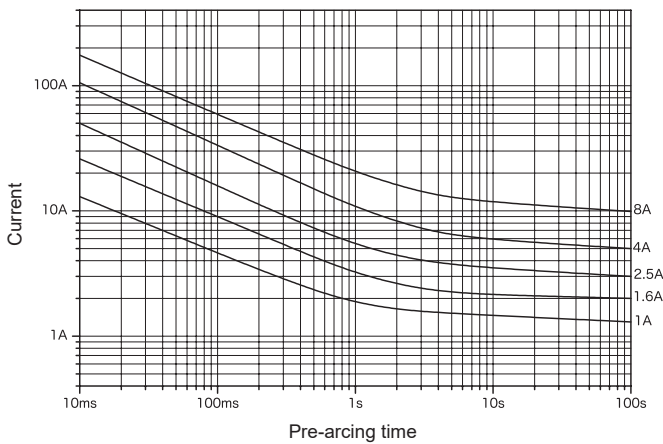

Rated voltage	Certification	Rated current (I <sub>N</sub> ) *1	Rated breaking current	Temp. rise	Current carrying capacity	Overload operation
AC 250 V		100 mA-1 A	10000 A	PF 0.7-0.8	70 K or less at 1.1 I <sub>N</sub>	Within 60 min at 1.35 I <sub>N</sub> Within 2 min at 2.0 I <sub>N</sub>
		Over 1 A-8 A	200 A			
		100 mA-1 A	500 A	At 1.1 I <sub>N</sub> , 140 K or less at the center, 60 K or less at the contact	1.1 I <sub>N</sub> until constant temperature is obtained on each part	
		Over 1 A-8 A	100 A			

\*1: Customer-requested rated current values can be supplied from within the given range.

\*2: Fuses with rated currents of less than 1 A are not considered electrical products per the Electrical Appliance and Material Safety Law.

Representative pre-arcing time-current characteristics

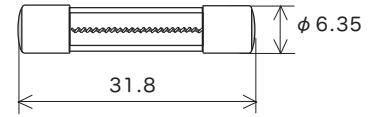
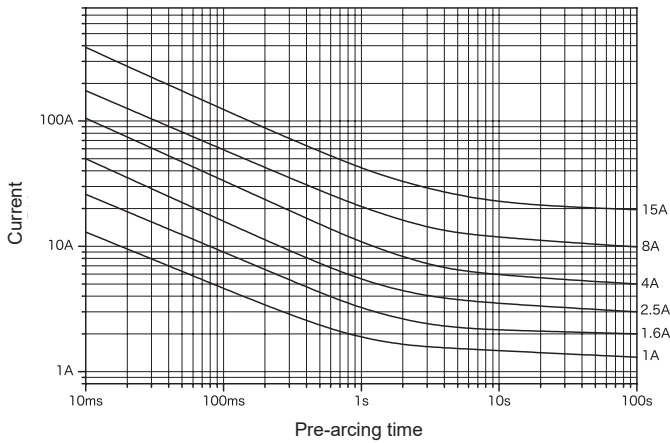

Scale: 1/1 (mm)

Rated voltage	Certification	Rated current (I <sub>N</sub> ) *1	Rated breaking current	Temp. rise	Current carrying capacity	Overload operation
AC 250 V		100 mA–1 A	10000 A	PF 0.7–0.8	70 K or less at 1.1 I <sub>N</sub>	Within 60 min at 1.35 I <sub>N</sub> Within 2 min at 2.0 I <sub>N</sub>
		Over 1 A–8 A	200 A			
		Over 8 A–30 A		–	1.0 I <sub>N</sub> until constant temperature is obtained on each part	

\*1: Customer-requested rated current values can be supplied from within the given range.

\*2: 100 mA–8 A Pb free  
 Over 8 A–30 A This product uses high melting temperature type solder containing 85% by weight or more lead. This type of solder is exempted from the RoHS Directive.

Representative pre-arcing time-current characteristics

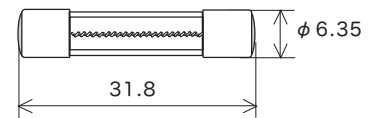
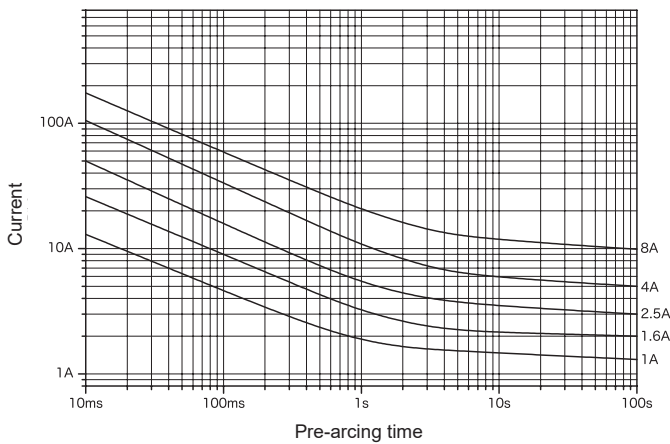

Scale: 1/1 (mm)

Rated voltage	Certification	Rated current (I <sub>N</sub> ) *1	Rated breaking current	Temp. rise	Current carrying capacity	Overload operation	
AC 250 V		100 mA–1 A	10000 A	PF 0.7–0.8	70 K or less at 1.1 I <sub>N</sub>	Within 60 min at 1.35 I <sub>N</sub> Within 2 min at 2.0 I <sub>N</sub>	
		Over 1 A–8 A	200 A				
		100 mA–1 A	500 A		At 1.1 I <sub>N</sub> , 140 K or less at the center, 60 K or less at the contact		1.1 I <sub>N</sub> until constant temperature is obtained on each part
		Over 1 A–8 A	100 A				

\*1: Customer-requested rated current values can be supplied from within the given range.

\*2: Fuses with rated currents of less than 1 A are not considered electrical products per the Electrical Appliance and Material Safety Law.

Representative pre-arcing time-current characteristics

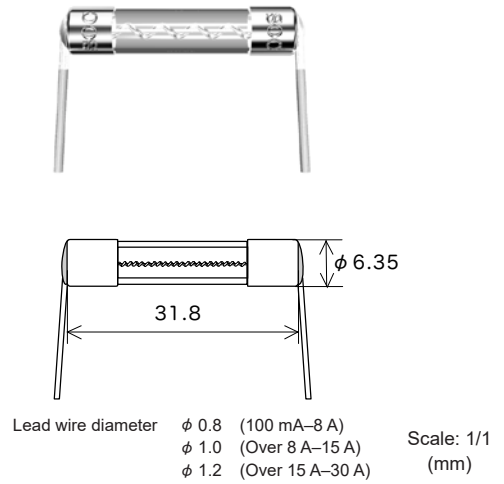
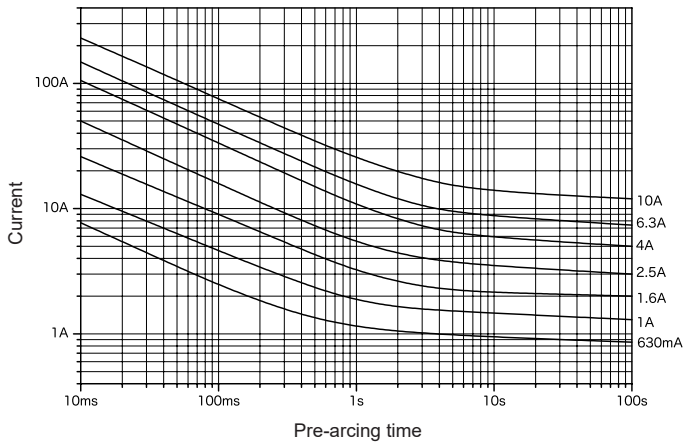

Rated voltage	Certification	Rated current ( $I_N$ ) *1	Rated breaking current	Temp. rise	Current carrying capacity	Overload operation
AC 125 V	UL, SP	100 mA–8 A	10000 A	PF 0.7–0.8	70 K or less at 1.1 $I_N$	Within 60 min at 1.35 $I_N$ Within 2 min at 2.0 $I_N$
DC 125 V	RU, SP	Over 8 A–30 A	500 A		200 K or less at 1.0 $I_N$	

\*1: Customer-requested rated current values can be supplied from within the given range.

\*2: 100 mA–8 A Pb free  
Over 8 A–30 A This product uses high melting temperature type solder containing 85% by weight or more lead. This type of solder is exempted from the RoHS Directive.

Representative pre-arcing time-current characteristics

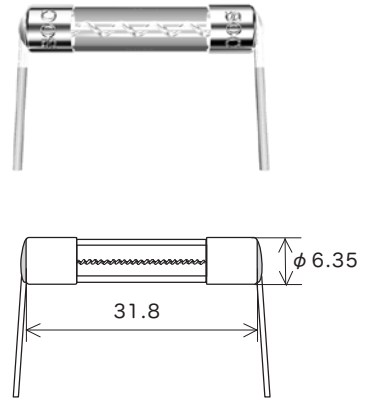
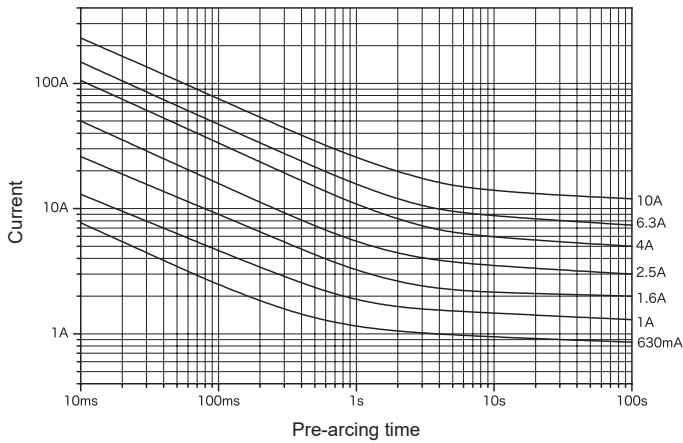

Lead wire diameter  $\phi$  0.8 (100 mA–8 A)  $\phi$  1.0 (Over 8 A–15 A) Scale: 1/1 (mm)

Rated voltage	Certification	Rated current (I <sub>N</sub> ) *1	Rated breaking current	Temp. rise	Current carrying capacity	Overload operation
AC 125 V	UL, SFA	100 mA–8 A	10000 A	70 K or less at 1.1 I <sub>N</sub>	1.1 I <sub>N</sub> for 15 min or more after temperature stabilization occurs	Within 60 min at 1.35 I <sub>N</sub> Within 2 min at 2.0 I <sub>N</sub>
	RU, SFA	Over 8 A–15 A	500 A	200 K or less at 1.0 I <sub>N</sub>	1.0 I <sub>N</sub> until temperature stabilization occurs	
	PS E *2	100 mA–15 A		At 1.1 I <sub>N</sub> , 140 K or less at the center, 60 K or less at the contact	1.1 I <sub>N</sub> until constant temperature is obtained on each part	
DC 125 V	RU, SFA	Over 8 A–15 A	Resistive circuit	200 K or less at 1.0 I <sub>N</sub>	1.0 I <sub>N</sub> until temperature stabilization occurs	

\*1: Customer-requested rated current values can be supplied from within the given range.

\*2: Fuses with rated currents of less than 1 A are not considered electrical products per the Electrical Appliance and Material Safety Law.

\*3: 100 mA–8 A Pb free  
Over 8 A–15 A This product uses high melting temperature type solder containing 85% by weight or more lead. This type of solder is exempted from the RoHS Directive.

Representative pre-arcing time-current characteristics

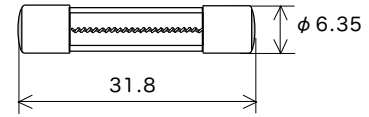
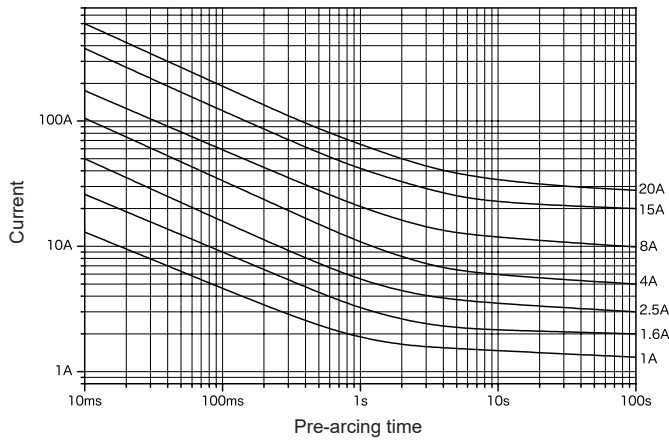

Scale: 1/1 (mm)

Rated voltage	Certification	Rated current (I <sub>N</sub> ) *1	Rated breaking current	Temp. rise	Current carrying capacity	Overload operation
AC 125 V	UL, SP	100 mA–8 A	10000 A	PF 0.7–0.8	70 K or less at 1.1 I <sub>N</sub>	1.1 I <sub>N</sub> for 15 min or more after temperature stabilization occurs
	RU, SP	Over 8 A–30 A			120 K or less at 0.9 I <sub>N</sub>	
DC 125 V	UL, SP	100 mA–8 A	500 A	Resistive circuit	70 K or less at 1.1 I <sub>N</sub>	1.1 I <sub>N</sub> for 15 min or more after temperature stabilization occurs
	RU, SP	Over 8 A–30 A			120 K or less at 0.9 I <sub>N</sub>	

Within 60 min at 1.35 I<sub>N</sub>  
Within 2 min at 2.0 I<sub>N</sub>

\*1: Customer-requested rated current values can be supplied from within the given range.

\*2: 100 mA–8 A Pb free  
Over 8 A–30 A This product uses high melting temperature type solder containing 85% by weight or more lead. This type of solder is exempted from the RoHS Directive.

Representative pre-arcing time-current characteristics

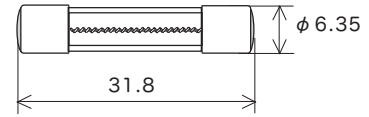
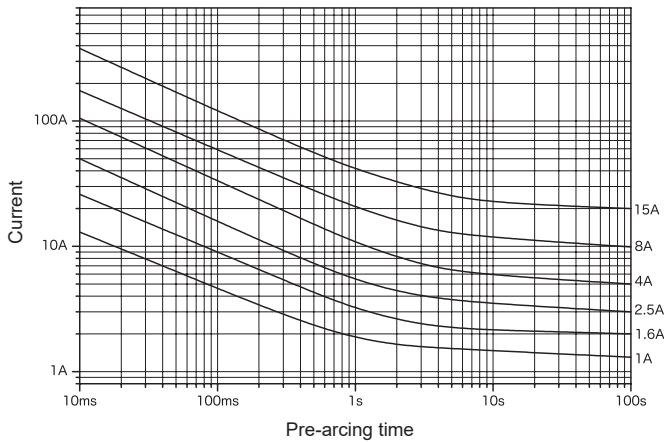

Scale: 1/1 (mm)

Rated voltage	Certification	Rated current (I <sub>N</sub> ) *1	Rated breaking current	Temp. rise	Current carrying capacity	Overload operation
AC 125 V	UL, SP	100 mA–8 A	10000 A	70 K or less at 1.1 I <sub>N</sub>	1.1 I <sub>N</sub> for 15 min or more after temperature stabilization occurs	Within 60 min at 1.35 I <sub>N</sub> Within 2 min at 2.0 I <sub>N</sub>
	RU, SP	Over 8 A–15 A	500 A	120 K or less at 0.9 I <sub>N</sub>	0.9 I <sub>N</sub> for 15 min or more after temperature stabilization occurs	
	PS E *2	100 mA–15 A		At 1.1 I <sub>N</sub> , 140 K or less at the center, 60 K or less at the contact	1.1 I <sub>N</sub> until constant temperature is obtained on each part	
DC 125 V	UL, SP	100 mA–8 A	Resistive circuit	70 K or less at 1.1 I <sub>N</sub>	1.1 I <sub>N</sub> for 15 min or more after temperature stabilization occurs	
	RU, SP	Over 8 A–15 A		120 K or less at 0.9 I <sub>N</sub>	0.9 I <sub>N</sub> for 15 min or more after temperature stabilization occurs	

\*1: Customer-requested rated current values can be supplied from within the given range.

\*2: Fuses with rated currents of less than 1 A are not considered electrical products per the Electrical Appliance and Material Safety Law.

\*3: 100 mA–8 A Pb free

Over 8 A–15 A This product uses high melting temperature type solder containing 85% by weight or more lead. This type of solder is exempted from the RoHS Directive.



# SU1

Normal-acting

RoHS-compliant

Pb free

Representative pre-arcing time-current characteristics

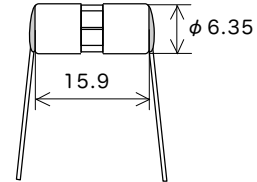
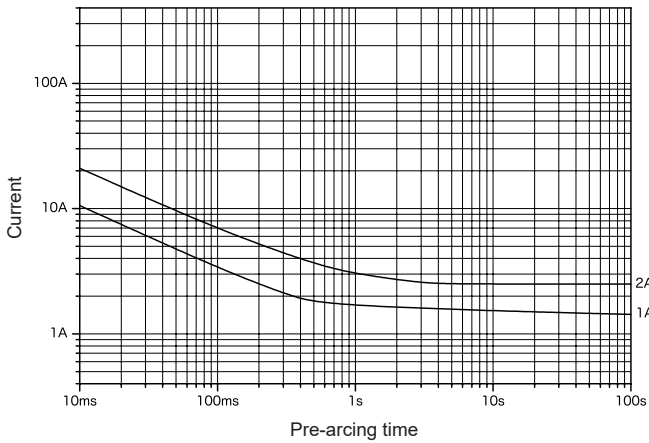

Lead wire diameter  $\phi$  0.8

Scale: 1/1 (mm)

Rated voltage	Certification	Rated current (I <sub>N</sub> ) *1	Rated breaking current	Temp. rise	Current carrying capacity	Overload operation
AC 125 V		80 mA–5 A	200 A PF 0.7–0.8	70 K or less at 1.1 I <sub>N</sub>	1.1 I <sub>N</sub> for 15 min or more after temperature stabilization occurs	Within 60 min at 1.35 I <sub>N</sub> Within 2 min at 2.0 I <sub>N</sub>

\*1: Customer-requested rated current values can be supplied from within the given range.

# SU2

Normal-acting

RoHS-compliant\*2

Pb free\*2

Representative pre-arcing time-current characteristics

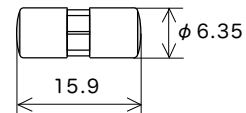
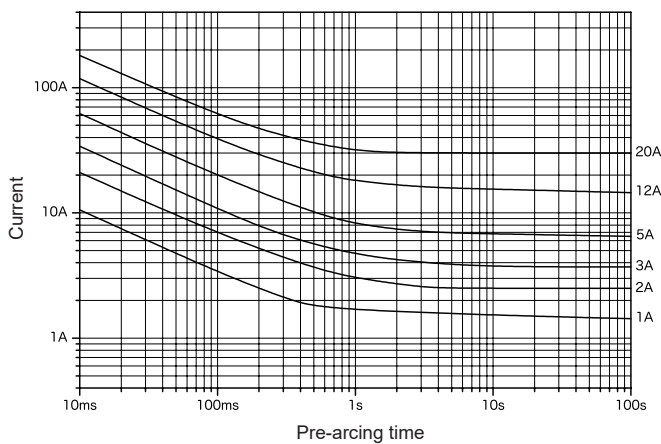

Scale: 1/1 (mm)

Rated voltage	Certification	Rated current (I <sub>N</sub> ) *1	Rated breaking current	Temp. rise	Current carrying capacity	Overload operation
AC 125 V		100 mA–5 A	200 A	PF 0.7–0.8	70 K or less at 1.1 I <sub>N</sub>	1.1 I <sub>N</sub> for 15 min or more after temperature stabilization occurs
		Over 5 A–20 A		Resistive circuit		

\*1: Customer-requested rated current values can be supplied from within the given range.

\*2: 100 mA–15 A Pb free  
Over 15 A–20 A This product uses high melting temperature type solder containing 85% by weight or more lead. This type of solder is exempted from the RoHS Directive.

Representative pre-arcing time-current characteristics

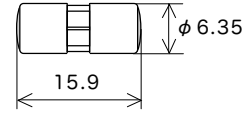
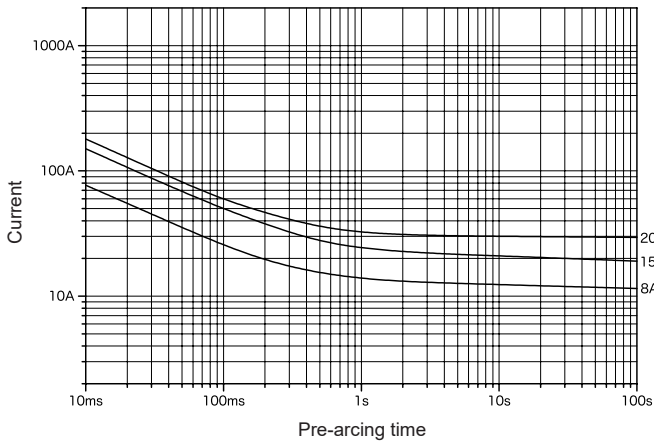

Scale: 1/1 (mm)

Rated voltage	Certification	Rated current (I <sub>N</sub> ) *1	Rated breaking current		Temp. rise	Current carrying capacity	Overload operation
DC 60 V		Over 5 A–20 A	100 A	Resistive circuit	–	1.0 I <sub>N</sub> for 15 min or more after temperature stabilization occurs	Within 60 min at 1.35 I <sub>N</sub> Within 2 min at 2.0 I <sub>N</sub>

\*1: Customer-requested rated current values can be supplied from within the given range.

\*2: Over 5 A–15 A Pb free

Over 15 A–20 A This product uses high melting temperature type solder containing 85% by weight or more lead. This type of solder is exempted from the RoHS Directive

# LLD6500

Pre-arcing time-current characteristics

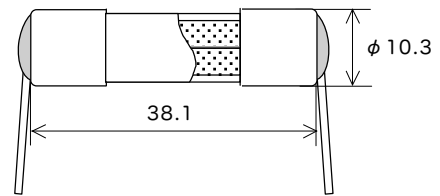
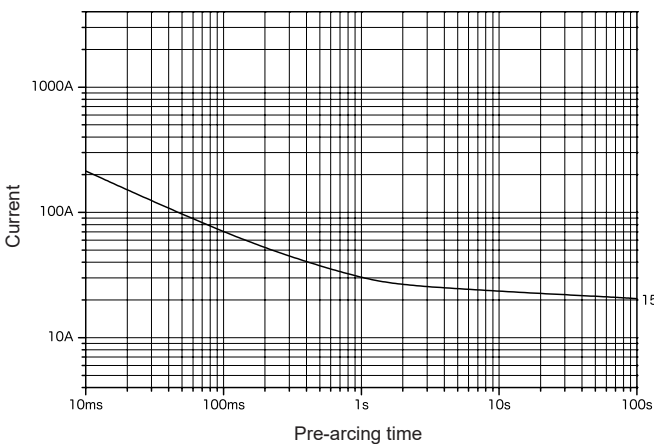

Lead wire diameter φ 1.2

Scale: 1/1 (mm)

Maximum working voltage	Certification	Rated current (I <sub>N</sub> )	Maximum breaking current		Temp. rise	Current carrying capacity	Overload operation
DC 600 V	–	15 A	500 A	Resistive circuit	150 K or less at 1.0 I <sub>N</sub>	1.0 I <sub>N</sub> until temperature stabilization occurs	Within 2 min at 2.0 I <sub>N</sub>

\*1: This product uses high melting temperature type solder containing 85% by weight or more lead. This type of solder is exempted from the RoHS Directive.

## Representative pre-arcing time-current characteristics

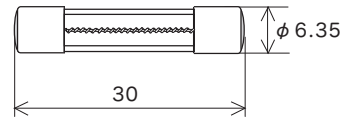
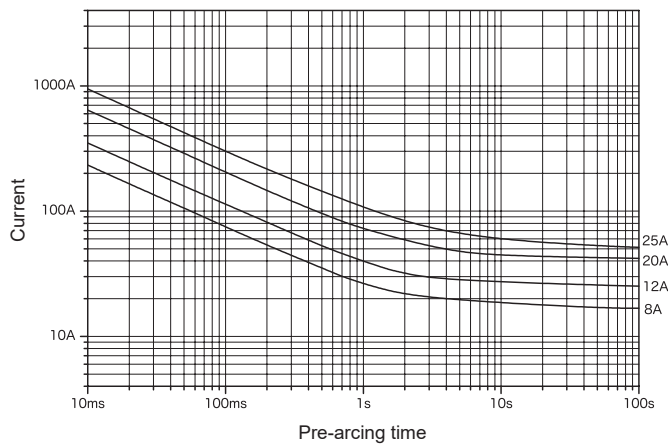

Scale: 1/1  
(mm)

Rated voltage	Certification	Rated current ( $I_N$ )	Rated breaking current		Endurance test	Test at elevated temperature	Pre-arcing time-current characteristics
AC 250 V		8 A	250 A	Resistive circuit	*1	*2	*3
		10 A					
		12 A	100 A	PF 0.7-0.8			
		15 A					
		20 A					
		25 A					

\*1: After 100 cycles of 1.2  $I_N$  1 h on / 15 min off, 1.5  $I_N$  is passed through the fuse for 1 h.

\*2: A current of 1.1  $I_N$  is passed through the fuse for 1 h at a temperature of 70±2 °C.

\*3:

2.1 $I_N$	2.75 $I_N$	4.0 $I_N$	10 $I_N$
Within 30 min	0.6 s-10 s	0.15 s-3 s	0.02 s-0.3 s

\*4: This product uses high melting temperature type solder containing 85% by weight or more lead. This type of solder is exempted from the RoHS Directive.

Representative pre-arcing time-current characteristics

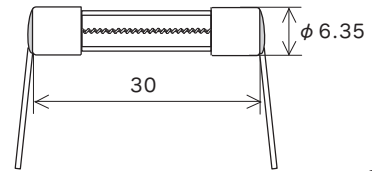
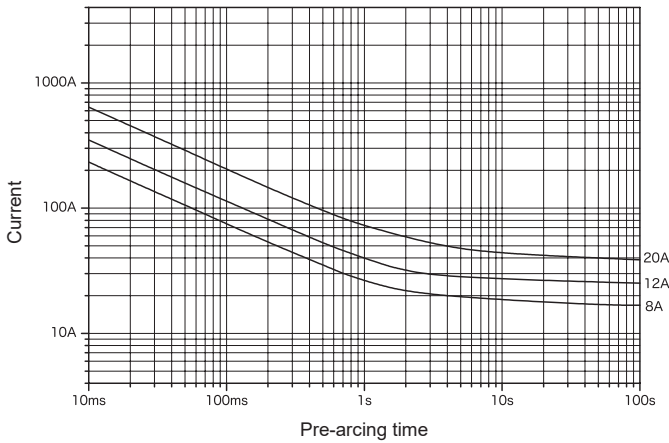

Lead wire diameter  $\phi$  1.2

Scale: 1/1 (mm)

Rated voltage	Certification	Rated current ( $I_N$ )	Rated breaking current		Temp. rise	Current carrying capacity / Endurance test	Test at elevated temperature	Pre-arcing time-current characteristics
AC 250 V		8 A 10 A 12 A 15 A 20 A 25 A	250 A	Resistive circuit	-	*	*	*
			100 A	PF 0.7-0.8	At 1.0 $I_N$ , 140 K or less at the center, 60 K or less at the contact	1.0 $I_N$ until constant temperature is obtained on each part	-	Within 30 min at 2.1 $I_N$

\*1: Endurance Test: After passing 0.8  $I_N$  through the fuse for 100 h, the rated current is passed through the fuse for 1 h.

\*2: A current of 1.1  $I_N$  is passed through the fuse for 1 h at a temperature of 70±2 °C.

\*3:

2.1 $I_N$	2.75 $I_N$	4.0 $I_N$	10 $I_N$
Within 30 min	0.6 s-10 s	0.15 s-3 s	0.02 s-0.3 s

\*4: This product uses high melting temperature type solder containing 85% by weight or more lead. This type of solder is exempted from the RoHS Directive.

Representative pre-arcing time-current characteristics

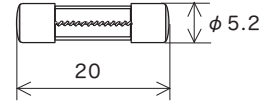
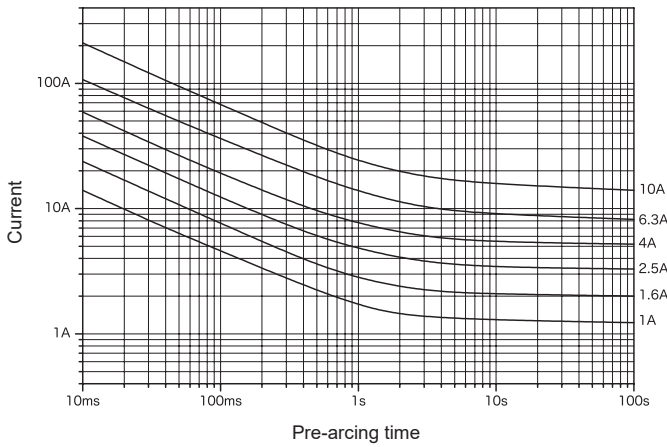

Scale: 1/1 (mm)

Rated voltage	Certification	Rated current ( $I_N$ ) *1	Rated breaking current		Temp. rise	Current carrying capacity	Overload operation
AC 125 V		100 mA–10 A	10000 A	PF 0.7–0.8	70 K or less at 1.1 $I_N$	1.1 $I_N$ for 15 min or more after temperature stabilization occurs	Within 60 min at 1.35 $I_N$ Within 2 min at 2.0 $I_N$

\*1: Customer-requested rated current values can be supplied from within the given range.

# ULTSC N1

Representative pre-arcing time-current characteristics

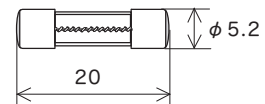
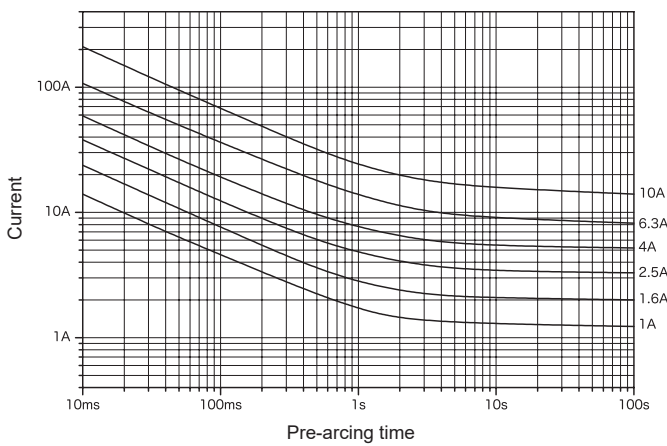

Scale: 1/1 (mm)

Rated voltage	Certification	Rated current ( $I_N$ ) *1	Rated breaking current		Temp. rise	Current carrying capacity	Overload operation
AC 125 V		100 mA–10 A	10000 A	PF 0.7–0.8	70 K or less at 1.1 $I_N$	1.1 $I_N$ for 15 min or more after temperature stabilization occurs	Within 60 min at 1.35 $I_N$ Within 2 min at 2.0 $I_N$
			500 A		At 1.1 $I_N$ , 140 K or less at the center, 60 K or less at the contact	1.1 $I_N$ until constant temperature is obtained on each part	

\*1: Customer-requested rated current values can be supplied from within the given range.

\*2: Fuses with rated currents of less than 1 A are not considered electrical products per the Electrical Appliance and Material Safety Law.

Representative pre-arcing time-current characteristics

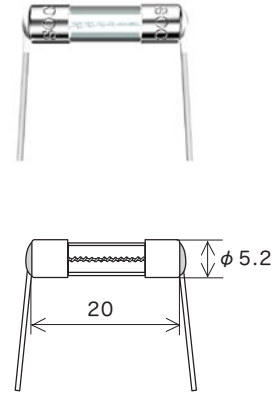
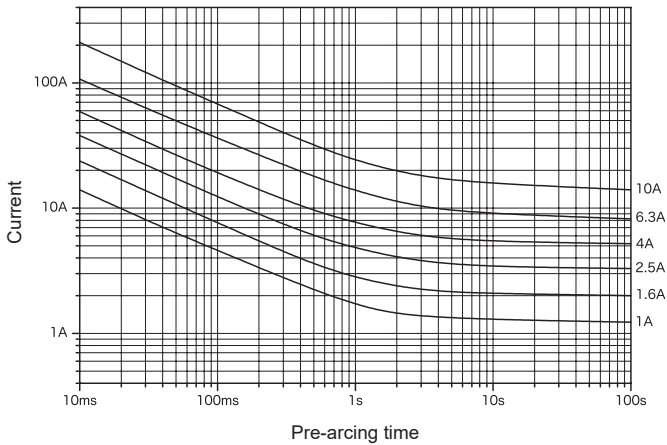

Lead wire diameter  $\phi$  0.5 (100 mA–4 A)  $\phi$  0.8 (Over 4 A–10 A) Scale: 1/1 (mm)

Rated voltage	Certification	Rated current (I <sub>N</sub> ) *1	Rated breaking current		Temp. rise	Current carrying capacity	Overload operation
AC 125 V	UL SF	100 mA–10 A	10000 A	PF 0.7–0.8	70 K or less at 1.1 I <sub>N</sub>	1.1 I <sub>N</sub> for 15 min or more after temperature stabilization occurs	Within 60 min at 1.35 I <sub>N</sub> Within 2 min at 2.0 I <sub>N</sub>

\*1: Customer-requested rated current values can be supplied from within the given range.

# ULTSCR N1

Representative pre-arcing time-current characteristics

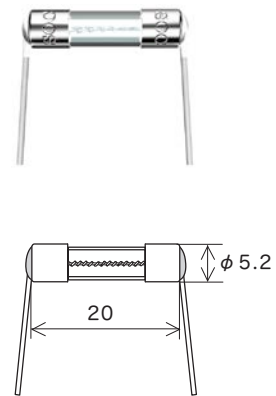
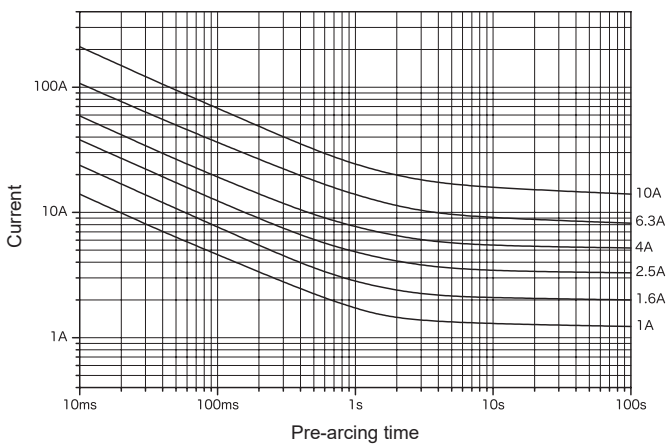

Lead wire diameter  $\phi$  0.5 (100 mA–4 A)  $\phi$  0.8 (Over 4 A–10 A) Scale: 1/1 (mm)

Rated voltage	Certification	Rated current (I <sub>N</sub> ) *1	Rated breaking current		Temp. rise	Current carrying capacity	Overload operation
AC 125 V	UL SF	100 mA–10 A	10000 A	PF 0.7–0.8	70 K or less at 1.1 I <sub>N</sub>	1.1 I <sub>N</sub> for 15 min or more after temperature stabilization occurs	Within 60 min at 1.35 I <sub>N</sub> Within 2 min at 2.0 I <sub>N</sub>
	PS E *2		500 A		At 1.1 I <sub>N</sub> , 140 K or less at the center, 60 K or less at the contact	1.1 I <sub>N</sub> until constant temperature is obtained on each part	

\*1: Customer-requested rated current values can be supplied from within the given range.

\*2: Fuses with rated currents of less than 1 A are not considered electrical products per the Electrical Appliance and Material Safety Law.

Representative pre-arcing time-current characteristics

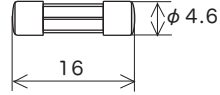
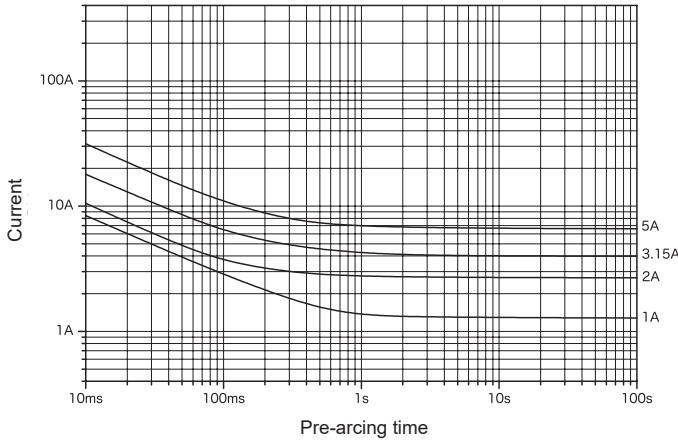

Scale: 1/1 (mm)

Rated voltage	Certification	Rated current (I <sub>N</sub> ) *1	Rated breaking current	Temp. rise	Current carrying capacity	Overload operation
AC 125 V	*2	100 mA–5 A	500 A	PF 0.7–0.8 At 1.1 I <sub>N</sub> , 140 K or less at the center, 60 K or less at the contact	1.1 I <sub>N</sub> until constant temperature is obtained on each part	Within 60 min at 1.35 I <sub>N</sub> Within 2 min at 2.0 I <sub>N</sub>

\*1: Customer-requested rated current values can be supplied from within the given range.  
 \*2: Fuses with rated currents of less than 1 A are not considered electrical products per the Electrical Appliance and Material Safety Law.

Representative pre-arcing time-current characteristics

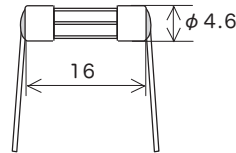
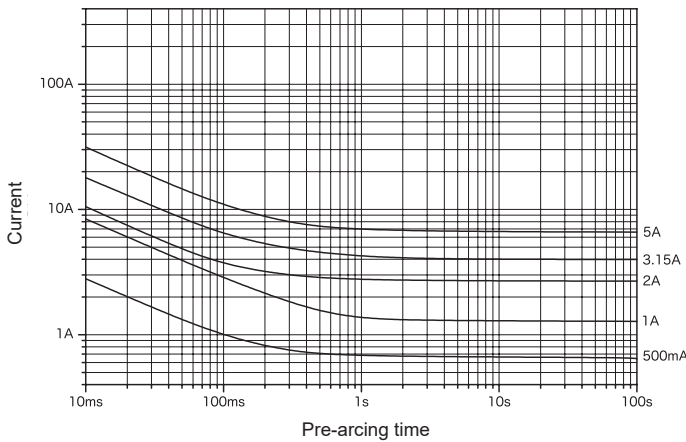

Lead wire diameter  $\phi$  0.5 (100 mA to less than 5 A)  $\phi$  0.8 (5 A) Scale: 1/1 (mm)

Rated voltage	Certification	Rated current (I <sub>N</sub> ) *1	Rated breaking current	Temp. rise	Current carrying capacity	Overload operation
AC 125 V	*2	100 mA–3 A	500 A	PF 0.7–0.8 At 1.1 I <sub>N</sub> , 140 K or less at the center, 60 K or less at the contact	1.1 I <sub>N</sub> until constant temperature is obtained on each part	Within 60 min at 1.35 I <sub>N</sub> Within 2 min at 2.0 I <sub>N</sub>
		Over 3 A–5 A	100 A			

\*1: Customer-requested rated current values can be supplied from within the given range.  
 \*2: Fuses with rated currents of less than 1 A are not considered electrical products per the Electrical Appliance and Material Safety Law.  
 \*3: 100 mA to less than 5 A Pb free  
 5 A This product uses high melting temperature type solder containing 85% by weight or more lead. This type of solder is exempted from the RoHS Directive.

Representative pre-arcing time-current characteristics

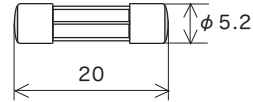
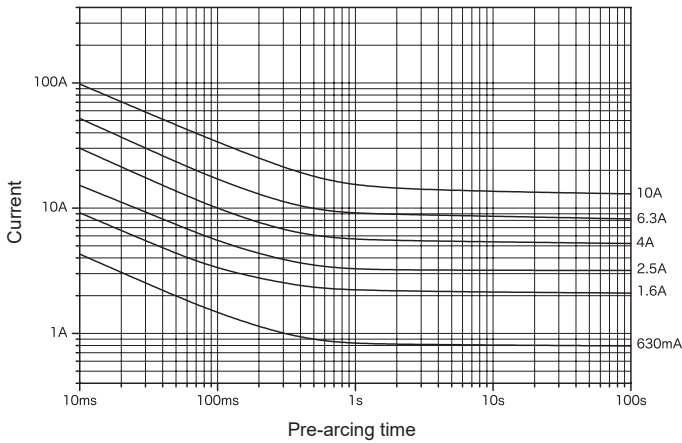

Scale: 1/1 (mm)

Rated voltage	Certification	Rated current (I <sub>N</sub> ) *1	Rated breaking current	Temp. rise	Current carrying capacity	Overload operation
AC 125 V	*2	100 mA–10 A	500 A	PF 0.7–0.8 At 1.1 I <sub>N</sub> , 140 K or less at the center, 60 K or less at the contact	1.1 I <sub>N</sub> until constant temperature is obtained on each part	Within 60 min at 1.35 I <sub>N</sub> Within 2 min at 2.0 I <sub>N</sub>

\*1: Customer-requested rated current values can be supplied from within the given range.

\*2: Fuses with rated currents of less than 1 A are not considered electrical products per the Electrical Appliance and Material Safety Law.

Representative pre-arcing time-current characteristics

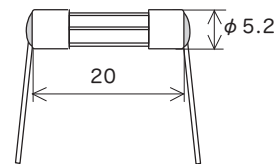
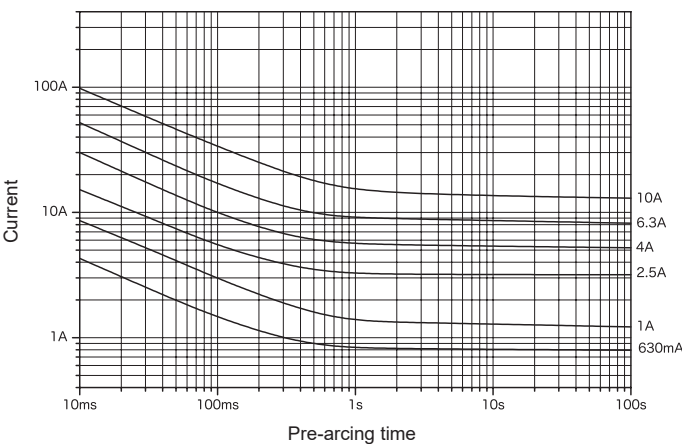

Lead wire diameter  $\phi$  0.5 (100 mA to less than 5 A)  $\phi$  0.8 (5 A–10 A) Scale: 1/1 (mm)

Rated voltage	Certification	Rated current (I <sub>N</sub> ) *1	Rated breaking current	Temp. rise	Current carrying capacity	Overload operation
AC 125 V	*2	100 mA–5 A	500 A	PF 0.7–0.8 At 1.1 I <sub>N</sub> , 140 K or less at the center, 60 K or less at the contact	1.1 I <sub>N</sub> until constant temperature is obtained on each part	Within 60 min at 1.35 I <sub>N</sub> Within 2 min at 2.0 I <sub>N</sub>
		Over 5 A–10 A	100 A			

\*1: Customer-requested rated current values can be supplied from within the given range.

\*2: Fuses with rated currents of less than 1 A are not considered electrical products per the Electrical Appliance and Material Safety Law.



Representative pre-arcing time-current characteristics

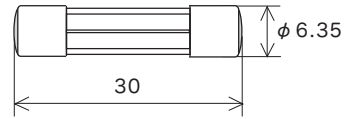
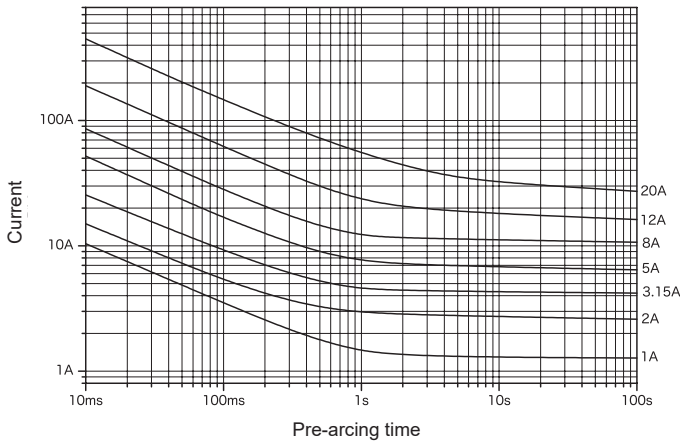

Scale: 1/1 (mm)

Rated voltage	Certification	Rated current (I <sub>N</sub> ) *1	Rated breaking current	Temp. rise	Current carrying capacity	Overload operation
AC 125 V	*2	100 mA–20 A	500 A	PF 0.7–0.8 At 1.1 I <sub>N</sub> , 140 K or less at the center, 60 K or less at the contact	1.1 I <sub>N</sub> until constant temperature is obtained on each part	Within 60 min at 1.35 I <sub>N</sub> Within 2 min at 2.0 I <sub>N</sub>

\*1: Customer-requested rated current values can be supplied from within the given range.  
 \*2: Fuses with rated currents of less than 1 A are not considered electrical products per the Electrical Appliance and Material Safety Law.  
 \*3: 100 mA–12 A Pb free  
 Over 12 A–20 A This product uses high melting temperature type solder containing 85% by weight or more lead. This type of solder is exempted from the RoHS Directive.

Representative pre-arcing time-current characteristics

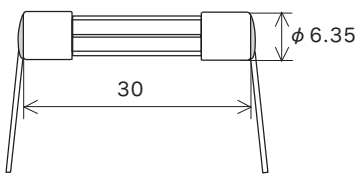
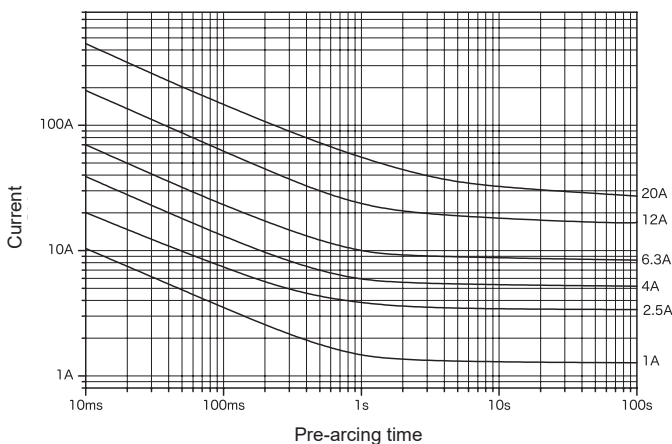

Lead wire diameter  $\phi$  0.8 (100 mA–8 A)  
 $\phi$  1.0 (Over 8 A–15 A)  
 $\phi$  1.2 (Over 15 A–20 A)  
 Scale: 1/1 (mm)

Rated voltage	Certification	Rated current (I <sub>N</sub> ) *1	Rated breaking current	Temp. rise	Current carrying capacity	Overload operation
AC 125 V	*2	100 mA–15 A	500 A	PF 0.7–0.8 At 1.1 I <sub>N</sub> , 140 K or less at the center, 60 K or less at the contact	1.1 I <sub>N</sub> until constant temperature is obtained on each part	Within 60 min at 1.35 I <sub>N</sub> Within 2 min at 2.0 I <sub>N</sub>
		Over 15 A–20 A	100 A			

\*1: Customer-requested rated current values can be supplied from within the given range.  
 \*2: Fuses with rated currents of less than 1 A are not considered electrical products per the Electrical Appliance and Material Safety Law.  
 \*3: 100 mA–12 A Pb free  
 Over 12 A–20 A This product uses high melting temperature type solder containing 85% by weight or more lead. This type of solder is exempted from the RoHS Directive.

Representative pre-arcing time-current characteristics

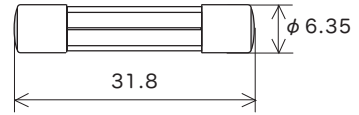
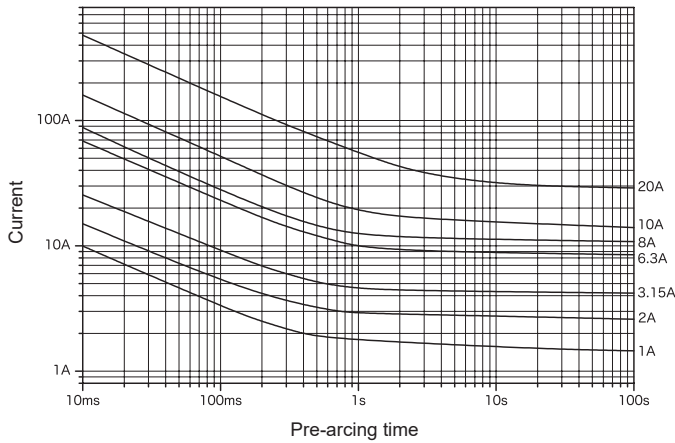

Scale: 1/1 (mm)

Rated voltage	Certification	Rated current (I <sub>N</sub> ) *1	Rated breaking current	Temp. rise	Current carrying capacity	Overload operation
AC 125 V	*2	100 mA–20 A	500 A	PF 0.7–0.8 At 1.1 I <sub>N</sub> , 140 K or less at the center, 60 K or less at the contact	1.1 I <sub>N</sub> until constant temperature is obtained on each part	Within 60 min at 1.35 I <sub>N</sub> Within 2 min at 2.0 I <sub>N</sub>

\*1: Customer-requested rated current values can be supplied from within the given range.  
 \*2: Fuses with rated currents of less than 1 A are not considered electrical products per the Electrical Appliance and Material Safety Law.  
 \*3: 100 mA–12 A Pb free  
 Over 12 A–20 A This product uses high melting temperature type solder containing 85% by weight or more lead. This type of solder is exempted from the RoHS Directive.

Representative pre-arcing time-current characteristics

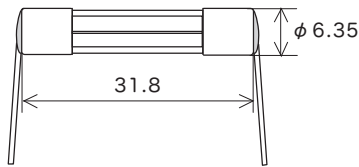
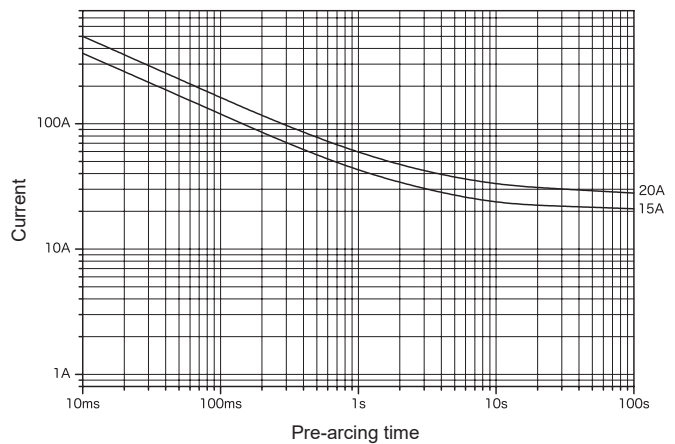

Lead wire diameter  $\phi$  0.8 (100 mA–8 A)  
 $\phi$  1.0 (Over 8 A–15 A)  
 $\phi$  1.2 (Over 15 A–20 A)  
 Scale: 1/1 (mm)

Rated voltage	Certification	Rated current (I <sub>N</sub> ) *1	Rated breaking current	Temp. rise	Current carrying capacity	Overload operation
AC 125 V	*2	100 mA–15 A	500 A	PF 0.7–0.8 At 1.1 I <sub>N</sub> , 140 K or less at the center, 60 K or less at the contact	1.1 I <sub>N</sub> until constant temperature is obtained on each part	Within 60 min at 1.35 I <sub>N</sub> Within 2 min at 2.0 I <sub>N</sub>
		Over 15 A–20 A	100 A			

\*1: Customer-requested rated current values can be supplied from within the given range.  
 \*2: Fuses with rated currents of less than 1 A are not considered electrical products per the Electrical Appliance and Material Safety Law.  
 \*3: 100 mA–12 A Pb free  
 Over 12 A–20 A This product uses high melting temperature type solder containing 85% by weight or more lead. This type of solder is exempted from the RoHS Directive.

Representative pre-arcing time-current characteristics

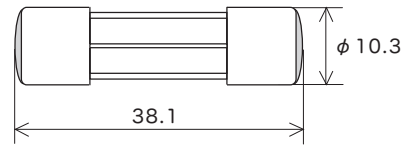
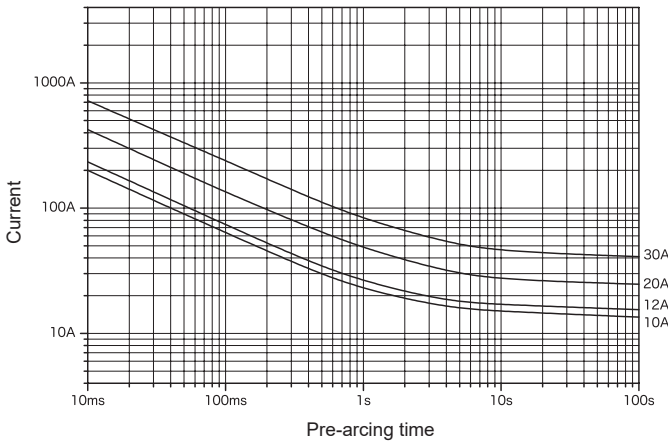

Scale: 1/1 (mm)

Rated voltage	Certification	Rated current (I <sub>N</sub> ) *1	Rated breaking current	Temp. rise	Current carrying capacity	Overload operation
AC 125 V	*2	500 mA–30 A	500 A	PF 0.7–0.8 At 1.1 I <sub>N</sub> , 140 K or less at the center, 60 K or less at the contact	1.1 I <sub>N</sub> until constant temperature is obtained on each part	Within 60 min at 1.35 I <sub>N</sub> Within 2 min at 2.0 I <sub>N</sub>

\*1: Customer-requested rated current values can be supplied from within the given range.  
 \*2: Fuses with rated currents of less than 1 A are not considered electrical products per the Electrical Appliance and Material Safety Law.  
 \*3: 500 mA–12 A Pb free  
 Over 12 A–30 A This product uses high melting temperature type solder containing 85% by weight or more lead. This type of solder is exempted from the RoHS Directive.

Representative pre-arcing time-current characteristics

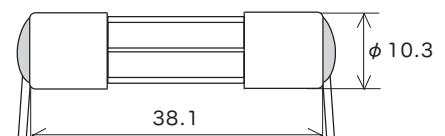
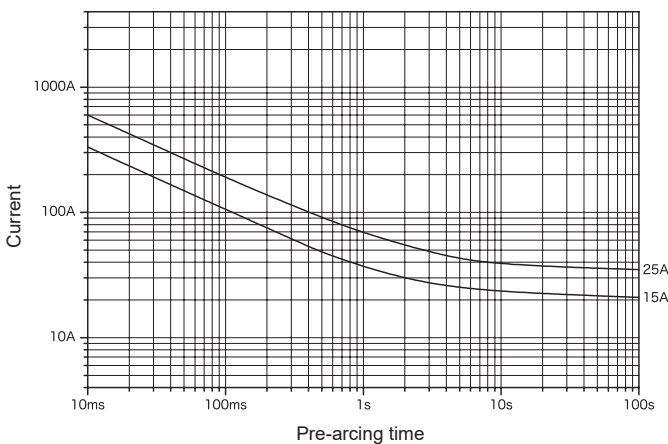

Lead wire diameter φ 0.8 (500 mA–8 A)  
 φ 1.0 (Over 8 A–15 A)  
 φ 1.2 (Over 15 A–30 A)  
 Scale: 1/1 (mm)

Rated voltage	Certification	Rated current (I <sub>N</sub> ) *1	Rated breaking current	Temp. rise	Current carrying capacity	Overload operation
AC 125 V	*2	500 mA–15 A	500 A	PF 0.7–0.8 At 1.1 I <sub>N</sub> , 140 K or less at the center, 60 K or less at the contact	1.1 I <sub>N</sub> until constant temperature is obtained on each part	Within 60 min at 1.35 I <sub>N</sub> Within 2 min at 2.0 I <sub>N</sub>
		Over 15 A–30 A	100 A			

\*1: Customer-requested rated current values can be supplied from within the given range.  
 \*2: Fuses with rated currents of less than 1 A are not considered electrical products per the Electrical Appliance and Material Safety Law.  
 \*3: 500 mA–12 A Pb free  
 Over 12 A–30 A This product uses high melting temperature type solder containing 85% by weight or more lead. This type of solder is exempted from the RoHS Directive.

Representative pre-arcing time-current characteristics

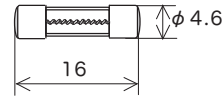
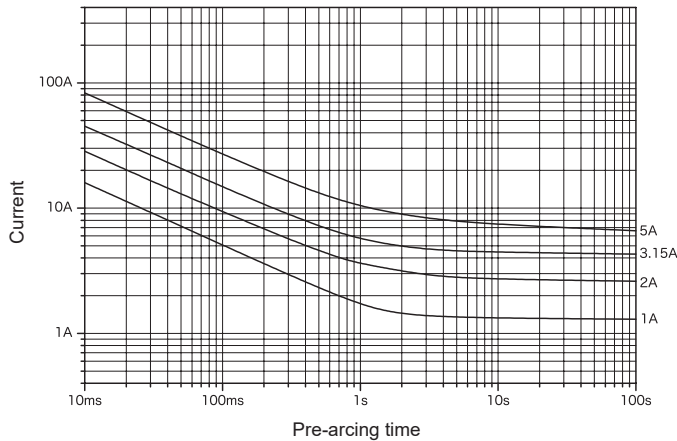

Scale: 1/1 (mm)

Rated voltage	Certification	Rated current (I <sub>N</sub> ) *1	Rated breaking current	Temp. rise	Current carrying capacity	Overload operation
AC 125 V	*2	100 mA–5 A	500 A	PF 0.7–0.8 At 1.1 I <sub>N</sub> , 140 K or less at the center, 60 K or less at the contact	1.1 I <sub>N</sub> until constant temperature is obtained on each part	Within 60 min at 1.35 I <sub>N</sub> Within 2 min at 2.0 I <sub>N</sub>

\*1: Customer-requested rated current values can be supplied from within the given range.  
\*2: Fuses with rated currents of less than 1 A are not considered electrical products per the Electrical Appliance and Material Safety Law.

Representative pre-arcing time-current characteristics

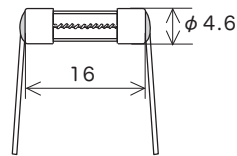
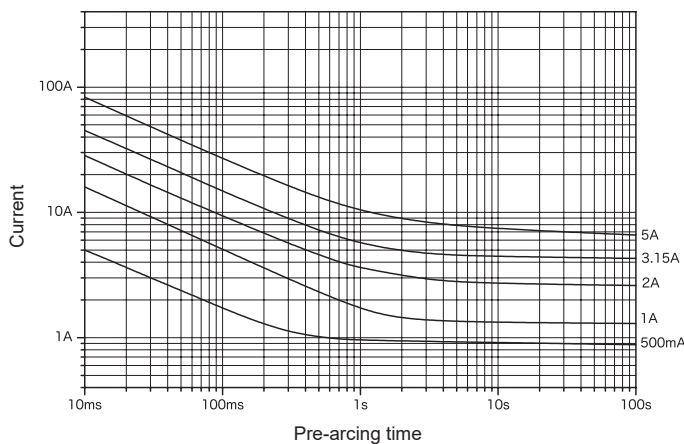

Lead wire diameter  $\phi$  0.5 (100 mA to less than 5 A)  $\phi$  0.8 (5 A) Scale: 1/1 (mm)

Rated voltage	Certification	Rated current (I <sub>N</sub> ) *1	Rated breaking current	Temp. rise	Current carrying capacity	Overload operation
AC 125 V	*2	100 mA–3 A	500 A	PF 0.7–0.8 At 1.1 I <sub>N</sub> , 140 K or less at the center, 60 K or less at the contact	1.1 I <sub>N</sub> until constant temperature is obtained on each part	Within 60 min at 1.35 I <sub>N</sub> Within 2 min at 2.0 I <sub>N</sub>
		Over 3 A–5 A	100 A			

\*1: Customer-requested rated current values can be supplied from within the given range.  
\*2: Fuses with rated currents of less than 1 A are not considered electrical products per the Electrical Appliance and Material Safety Law.  
\*3: 100 mA to less than 5 A Pb free  
5 A This product uses high melting temperature type solder containing 85% by weight or more lead. This type of solder is exempted from the RoHS Directive.

Representative pre-arcing time-current characteristics

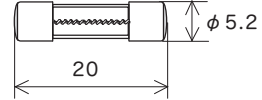
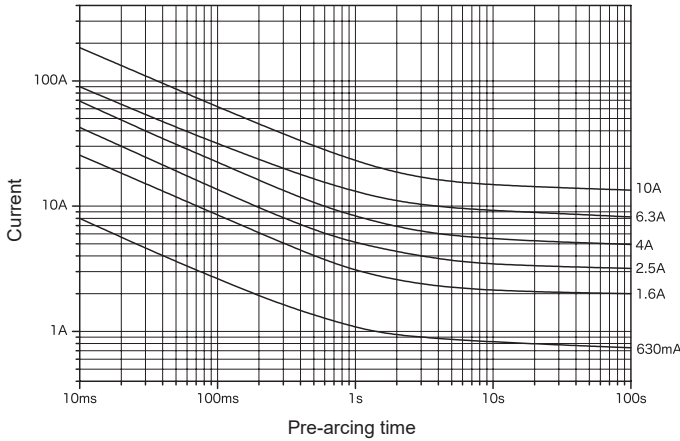

Scale: 1/1 (mm)

Rated voltage	Certification	Rated current (I <sub>N</sub> ) *1	Rated breaking current	Temp. rise	Current carrying capacity	Overload operation
AC 125 V	*2	100 mA–10 A	500 A	PF 0.7–0.8 At 1.1 I <sub>N</sub> , 140 K or less at the center, 60 K or less at the contact	1.1 I <sub>N</sub> until constant temperature is obtained on each part	Within 60 min at 1.35 I <sub>N</sub> Within 2 min at 2.0 I <sub>N</sub>

\*1: Customer-requested rated current values can be supplied from within the given range.  
\*2: Fuses with rated currents of less than 1 A are not considered electrical products per the Electrical Appliance and Material Safety Law.

Representative pre-arcing time-current characteristics

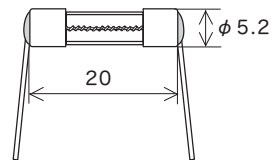
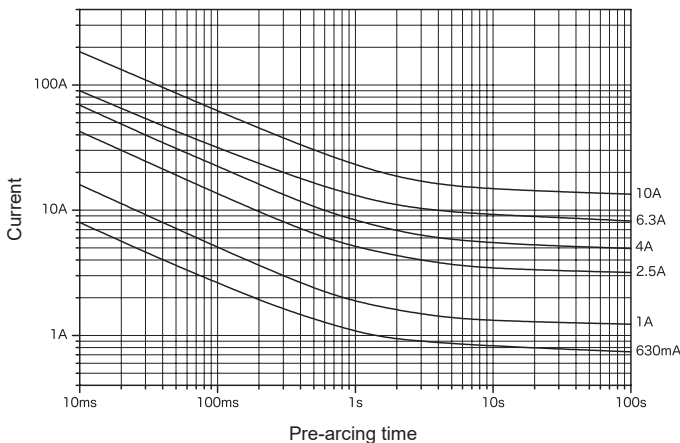

Lead wire diameter  $\phi$  0.5 (100 mA to less than 5 A)  $\phi$  0.8 (5 A–10 A) Scale: 1/1 (mm)

Rated voltage	Certification	Rated current (I <sub>N</sub> ) *1	Rated breaking current	Temp. rise	Current carrying capacity	Overload operation
AC 125 V	*2	100 mA–5 A	500 A	PF 0.7–0.8 At 1.1 I <sub>N</sub> , 140 K or less at the center, 60 K or less at the contact	1.1 I <sub>N</sub> until constant temperature is obtained on each part	Within 60 min at 1.35 I <sub>N</sub> Within 2 min at 2.0 I <sub>N</sub>
		Over 5 A–10 A	100 A			

\*1: Customer-requested rated current values can be supplied from within the given range.  
\*2: Fuses with rated currents of less than 1 A are not considered electrical products per the Electrical Appliance and Material Safety Law.

Representative pre-arcing time-current characteristics

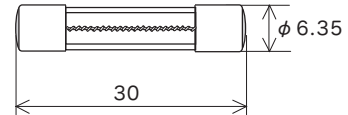
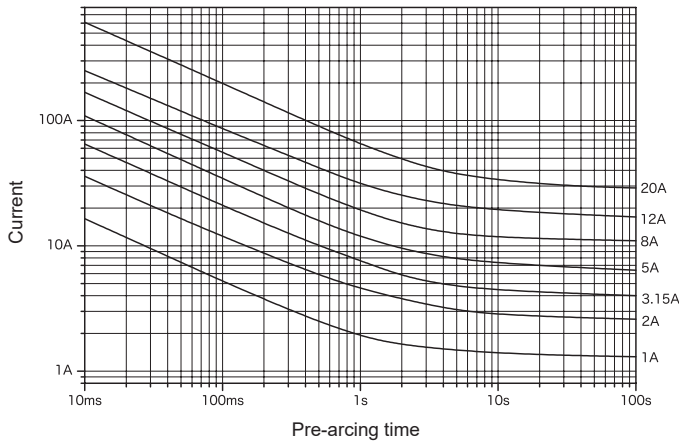

Scale: 1/1 (mm)

Rated voltage	Certification	Rated current (I <sub>N</sub> ) *1	Rated breaking current	Temp. rise	Current carrying capacity	Overload operation
AC 125 V	*2	100 mA–30 A	500 A PF 0.7–0.8	At 1.1 I <sub>N</sub> , 140 K or less at the center, 60 K or less at the contact	1.1 I <sub>N</sub> until constant temperature is obtained on each part	Within 60 min at 1.35 I <sub>N</sub> Within 2 min at 2.0 I <sub>N</sub>

\*1: Customer-requested rated current values can be supplied from within the given range.  
 \*2: Fuses with rated currents of less than 1 A are not considered electrical products per the Electrical Appliance and Material Safety Law.  
 \*3: 100 mA–12 A Pb free  
 Over 12 A–30 A This product uses high melting temperature type solder containing 85% by weight or more lead. This type of solder is exempted from the RoHS Directive.

Representative pre-arcing time-current characteristics

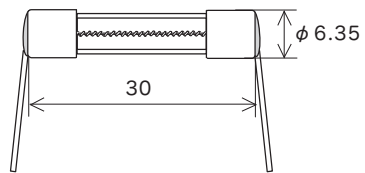
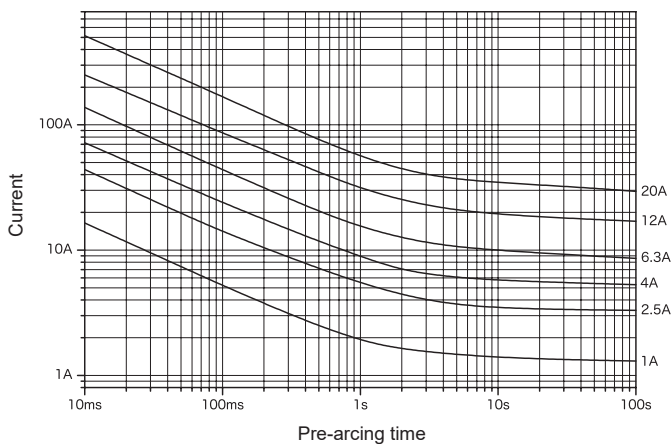

Lead wire diameter  $\phi$  0.8 (100 mA–8 A)  
 $\phi$  1.0 (Over 8 A–15 A)  
 $\phi$  1.2 (Over 15 A–30 A)  
 Scale: 1/1 (mm)

Rated voltage	Certification	Rated current (I <sub>N</sub> ) *1	Rated breaking current	Temp. rise	Current carrying capacity	Overload operation
AC 125 V	*2	100 mA–15 A	500 A	PF 0.7–0.8	1.1 I <sub>N</sub> until constant temperature is obtained on each part	Within 60 min at 1.35 I <sub>N</sub> Within 2 min at 2.0 I <sub>N</sub>
		Over 15 A–30 A	100 A			

\*1: Customer-requested rated current values can be supplied from within the given range.  
 \*2: Fuses with rated currents of less than 1 A are not considered electrical products per the Electrical Appliance and Material Safety Law.  
 \*3: 100 mA–12 A Pb free  
 Over 12 A–30 A This product uses high melting temperature type solder containing 85% by weight or more lead. This type of solder is exempted from the RoHS Directive.

Representative pre-arcing time-current characteristics

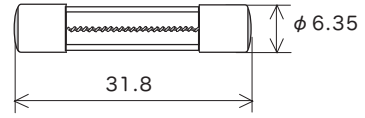
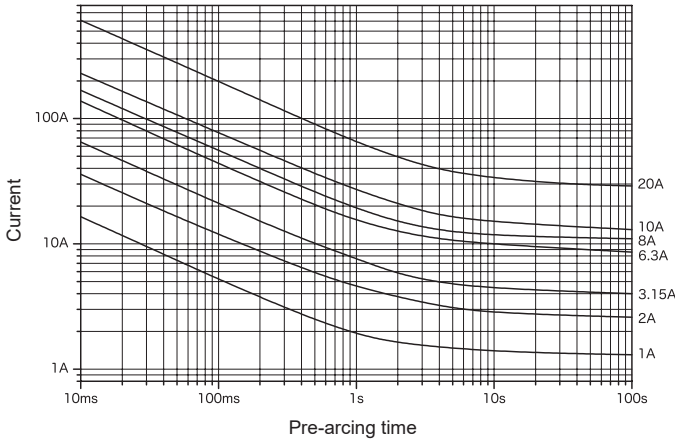

Scale: 1/1 (mm)

Rated voltage	Certification	Rated current (I <sub>N</sub> ) *1	Rated breaking current	Temp. rise	Current carrying capacity	Overload operation
AC 125 V	*2	100 mA–20 A	500 A	PF 0.7–0.8 At 1.1 I <sub>N</sub> , 140 K or less at the center, 60 K or less at the contact	1.1 I <sub>N</sub> until constant temperature is obtained on each part	Within 60 min at 1.35 I <sub>N</sub> Within 2 min at 2.0 I <sub>N</sub>

\*1: Customer-requested rated current values can be supplied from within the given range.  
 \*2: Fuses with rated currents of less than 1 A are not considered electrical products per the Electrical Appliance and Material Safety Law.  
 \*3: 100 mA–12 A Pb free  
 Over 12 A–20 A This product uses high melting temperature type solder containing 85% by weight or more lead. This type of solder is exempted from the RoHS Directive.

Representative pre-arcing time-current characteristics

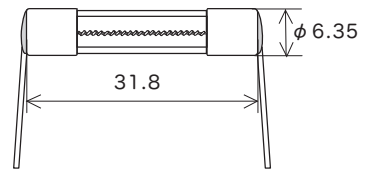
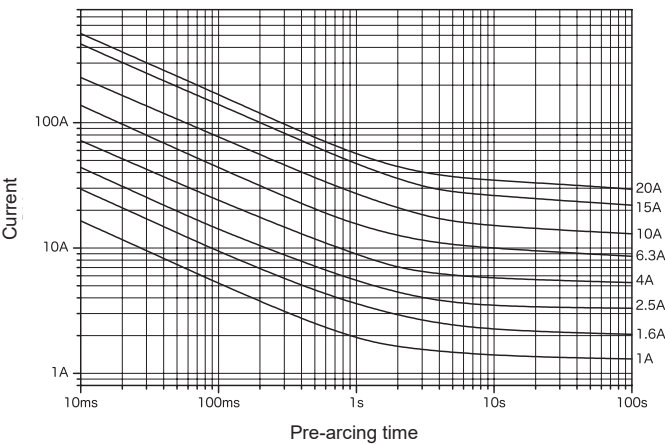

Lead wire diameter  $\phi$  0.8 (100 mA–8 A)  
 $\phi$  1.0 (Over 8 A–15 A)  
 $\phi$  1.2 (Over 15 A–20 A) Scale: 1/1 (mm)

Rated voltage	Certification	Rated current (I <sub>N</sub> ) *1	Rated breaking current	Temp. rise	Current carrying capacity	Overload operation
AC 125 V	*2	100 mA–15 A	500 A	PF 0.7–0.8 At 1.1 I <sub>N</sub> , 140 K or less at the center, 60 K or less at the contact	1.1 I <sub>N</sub> until constant temperature is obtained on each part	Within 60 min at 1.35 I <sub>N</sub> Within 2 min at 2.0 I <sub>N</sub>
		Over 15 A–20 A	100 A			

\*1: Customer-requested rated current values can be supplied from within the given range.  
 \*2: Fuses with rated currents of less than 1 A are not considered electrical products per the Electrical Appliance and Material Safety Law.  
 \*3: 100 mA–12 A Pb free  
 Over 12 A–20 A This product uses high melting temperature type solder containing 85% by weight or more lead. This type of solder is exempted from the RoHS Directive.

Representative pre-arcing time-current characteristics

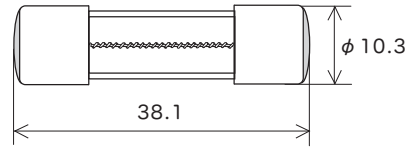
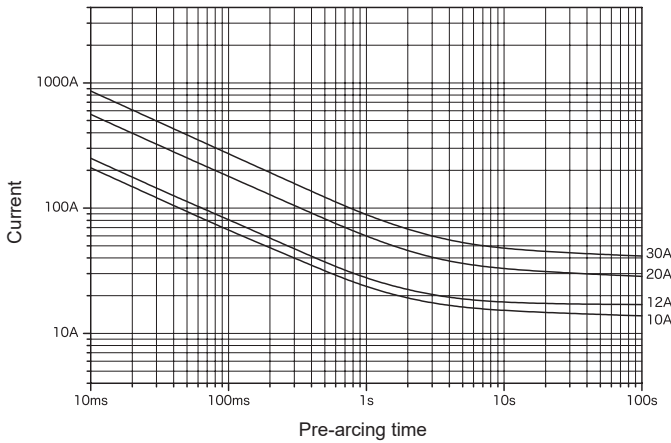

Scale: 1/1 (mm)

Rated voltage	Certification	Rated current (I <sub>N</sub> ) *1	Rated breaking current	Temp. rise	Current carrying capacity	Overload operation
AC 125 V	*2	500 mA–30 A	500 A	PF 0.7–0.8 At 1.1 I <sub>N</sub> , 140 K or less at the center, 60 K or less at the contact	1.1 I <sub>N</sub> until constant temperature is obtained on each part	Within 60 min at 1.35 I <sub>N</sub> Within 2 min at 2.0 I <sub>N</sub>

\*1: Customer-requested rated current values can be supplied from within the given range.  
 \*2: Fuses with rated currents of less than 1 A are not considered electrical products per the Electrical Appliance and Material Safety Law.  
 \*3: 500 mA–12 A Pb free  
 Over 12 A–30 A This product uses high melting temperature type solder containing 85% by weight or more lead. This type of solder is exempted from the RoHS Directive.

Representative pre-arcing time-current characteristics

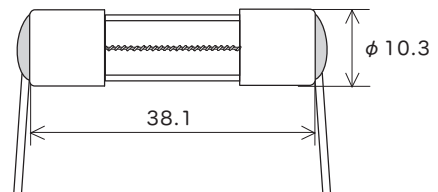
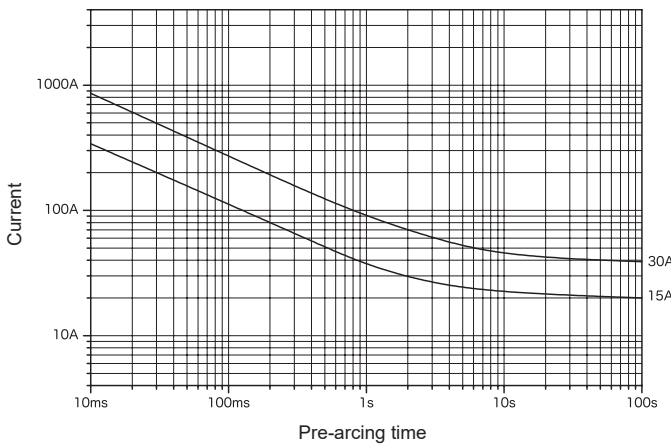

Lead wire diameter  $\phi$  0.8 (500 mA–8 A)  
 $\phi$  1.0 (Over 8 A–15 A)  
 $\phi$  1.2 (Over 15 A–30 A)  
 Scale: 1/1 (mm)

Rated voltage	Certification	Rated current (I <sub>N</sub> ) *1	Rated breaking current	Temp. rise	Current carrying capacity	Overload operation
AC 125 V	*2	500 mA–15 A	500 A	PF 0.7–0.8 At 1.1 I <sub>N</sub> , 140 K or less at the center, 60 K or less at the contact	1.1 I <sub>N</sub> until constant temperature is obtained on each part	Within 60 min at 1.35 I <sub>N</sub> Within 2 min at 2.0 I <sub>N</sub>
		Over 15 A–30 A	100 A			

\*1: Customer-requested rated current values can be supplied from within the given range.  
 \*2: Fuses with rated currents of less than 1 A are not considered electrical products per the Electrical Appliance and Material Safety Law.  
 \*3: 500 mA–12 A Pb free  
 Over 12 A–30 A This product uses high melting temperature type solder containing 85% by weight or more lead. This type of solder is exempted from the RoHS Directive.



# 250V ⓐ MSC

Normal-acting

RoHS-compliant

Pb free

Representative pre-arcing time-current characteristics

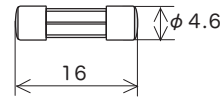
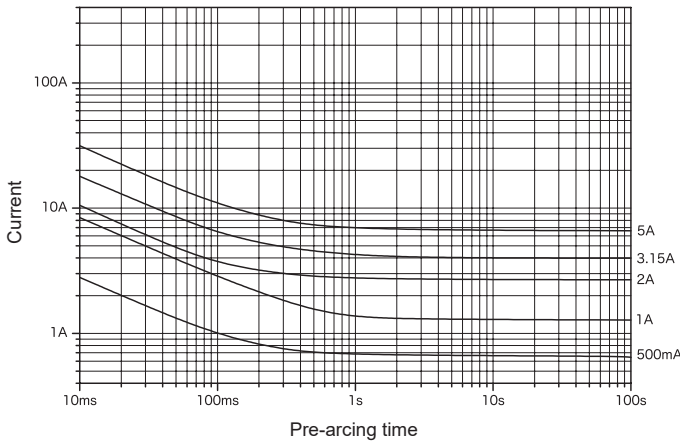

Scale: 1/1 (mm)

Rated voltage	Certification	Rated current (I <sub>N</sub> ) *1	Rated breaking current		Temp. rise	Current carrying capacity	Overload operation
AC 250 V	*2	100 mA–5 A	100 A	PF 0.7–0.8	At 1.1 I <sub>N</sub> , 140 K or less at the center, 60 K or less at the contact	1.1 I <sub>N</sub> until constant temperature is obtained on each part	Within 60 min at 1.35 I <sub>N</sub> Within 2 min at 2.0 I <sub>N</sub>

\*1: Customer-requested rated current values can be supplied from within the given range.  
 \*2: Fuses with rated currents of less than 1 A are not considered electrical products per the Electrical Appliance and Material Safety Law.

# 250V ⓐ MSCR

Normal-acting

RoHS-compliant\*3

Pb free\*3

Representative pre-arcing time-current characteristics

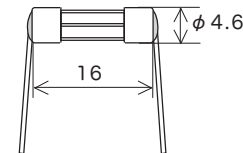
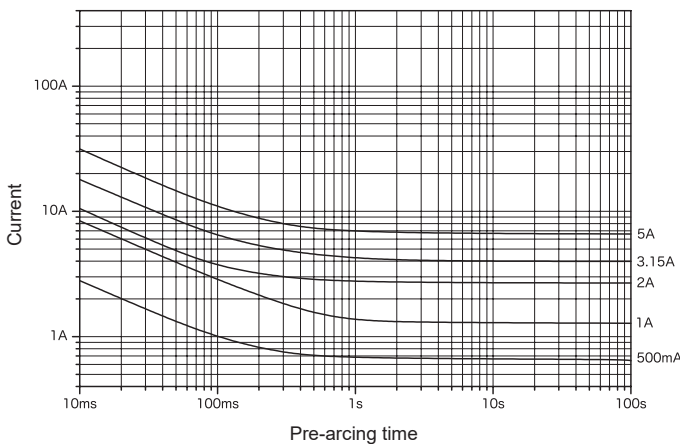

Lead wire diameter  $\phi$  0.5 (100 mA to less than 5 A)  $\phi$  0.8 (5 A) Scale: 1/1 (mm)

Rated voltage	Certification	Rated current (I <sub>N</sub> ) *1	Rated breaking current		Temp. rise	Current carrying capacity	Overload operation
AC 250 V	*2	100 mA–5 A	100 A	PF 0.7–0.8	At 1.1 I <sub>N</sub> , 140 K or less at the center, 60 K or less at the contact	1.1 I <sub>N</sub> until constant temperature is obtained on each part	Within 60 min at 1.35 I <sub>N</sub> Within 2 min at 2.0 I <sub>N</sub>

\*1: Customer-requested rated current values can be supplied from within the given range.  
 \*2: Fuses with rated currents of less than 1 A are not considered electrical products per the Electrical Appliance and Material Safety Law.  
 \*3: 100 mA to less than 5 A Pb free  
 5 A This product uses high melting temperature type solder containing 85% by weight or more lead. This type of solder is exempted from the RoHS Directive.

# 250V ⓐ SC

Normal-acting

RoHS-compliant

Pb free

Representative pre-arcing time-current characteristics

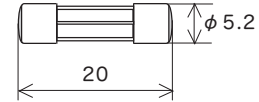
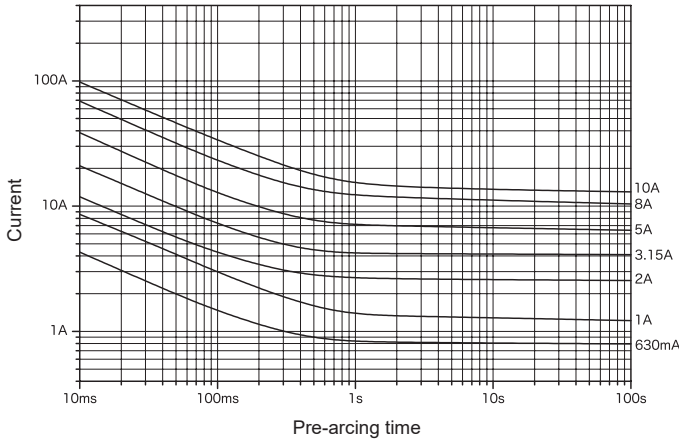

Scale: 1/1 (mm)

Rated voltage	Certification	Rated current (I <sub>N</sub> ) *1	Rated breaking current	Temp. rise	Current carrying capacity	Overload operation
AC 250 V	*2	100 mA–10 A	100 A PF 0.7–0.8	At 1.1 I <sub>N</sub> , 140 K or less at the center, 60 K or less at the contact	1.1 I <sub>N</sub> until constant temperature is obtained on each part	Within 60 min at 1.35 I <sub>N</sub> Within 2 min at 2.0 I <sub>N</sub>

\*1: Customer-requested rated current values can be supplied from within the given range.

\*2: Fuses with rated currents of less than 1 A are not considered electrical products per the Electrical Appliance and Material Safety Law.

# 250V ⓐ SCR

Normal-acting

RoHS-compliant

Pb free

Representative pre-arcing time-current characteristics

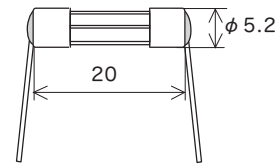
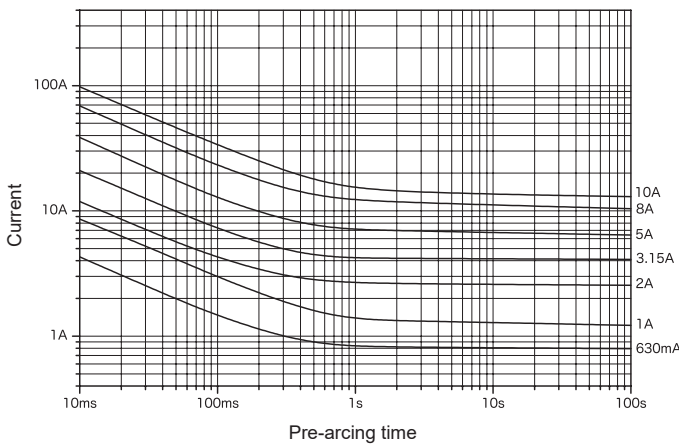

Lead wire diameter  
 $\phi$  0.5 (100 mA to less than 5 A)  
 $\phi$  0.8 (5 A–10 A)

Scale: 1/1 (mm)

Rated voltage	Certification	Rated current (I <sub>N</sub> ) *1	Rated breaking current	Temp. rise	Current carrying capacity	Overload operation
AC 250 V	*2	100 mA–10 A	100 A PF 0.7–0.8	At 1.1 I <sub>N</sub> , 140 K or less at the center, 60 K or less at the contact	1.1 I <sub>N</sub> until constant temperature is obtained on each part	Within 60 min at 1.35 I <sub>N</sub> Within 2 min at 2.0 I <sub>N</sub>

\*1: Customer-requested rated current values can be supplied from within the given range.

\*2: Fuses with rated currents of less than 1 A are not considered electrical products per the Electrical Appliance and Material Safety Law.

# 250V ⓐ LC

Normal-acting

RoHS-compliant\*3

Pb free\*3

Representative pre-arcing time-current characteristics

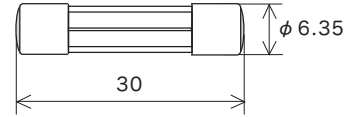
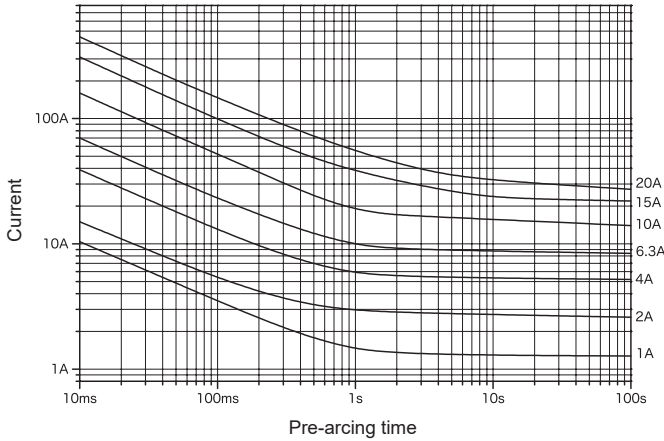

Scale: 1/1 (mm)

Rated voltage	Certification	Rated current (I <sub>N</sub> ) *1	Rated breaking current	Temp. rise	Current carrying capacity	Overload operation
AC 250 V	*2	100 mA–20 A	100 A PF 0.7–0.8	At 1.1 I <sub>N</sub> , 140 K or less at the center, 60 K or less at the contact	1.1 I <sub>N</sub> until constant temperature is obtained on each part	Within 60 min at 1.35 I <sub>N</sub> Within 2 min at 2.0 I <sub>N</sub>

\*1: Customer-requested rated current values can be supplied from within the given range.  
 \*2: Fuses with rated currents of less than 1 A are not considered electrical products per the Electrical Appliance and Material Safety Law.  
 \*3: 100 mA–12 A Pb free  
 Over 12 A–20 A This product uses high melting temperature type solder containing 85% by weight or more lead. This type of solder is exempted from the RoHS Directive.

# 250V ⓐ LCR

Normal-acting

RoHS-compliant\*3

Pb free\*3

Representative pre-arcing time-current characteristics

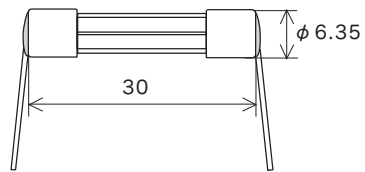
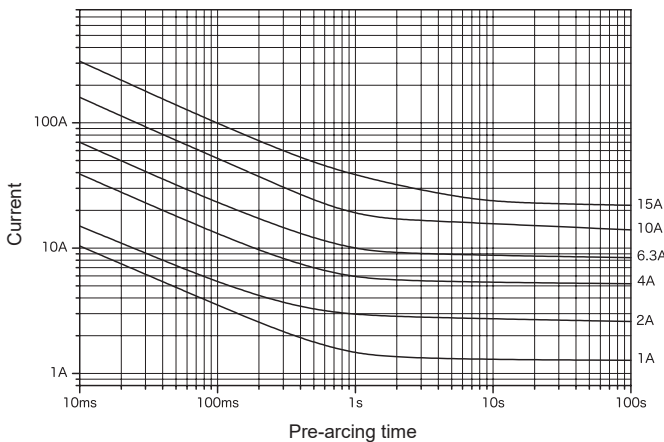

Lead wire diameter  $\phi$  0.8 (100 mA–8 A)  
 $\phi$  1.0 (Over 8 A–15 A)  
 $\phi$  1.2 (Over 15 A–20 A)  
 Scale: 1/1 (mm)

Rated voltage	Certification	Rated current (I <sub>N</sub> ) *1	Rated breaking current	Temp. rise	Current carrying capacity	Overload operation
AC 250 V	*2	100 mA–20 A	100 A PF 0.7–0.8	At 1.1 I <sub>N</sub> , 140 K or less at the center, 60 K or less at the contact	1.1 I <sub>N</sub> until constant temperature is obtained on each part	Within 60 min at 1.35 I <sub>N</sub> Within 2 min at 2.0 I <sub>N</sub>

\*1: Customer-requested rated current values can be supplied from within the given range.  
 \*2: Fuses with rated currents of less than 1 A are not considered electrical products per the Electrical Appliance and Material Safety Law.  
 \*3: 100 mA–12 A Pb free  
 Over 12 A–20 A This product uses high melting temperature type solder containing 85% by weight or more lead. This type of solder is exempted from the RoHS Directive.

Representative pre-arcing time-current characteristics

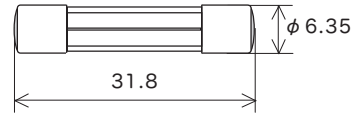
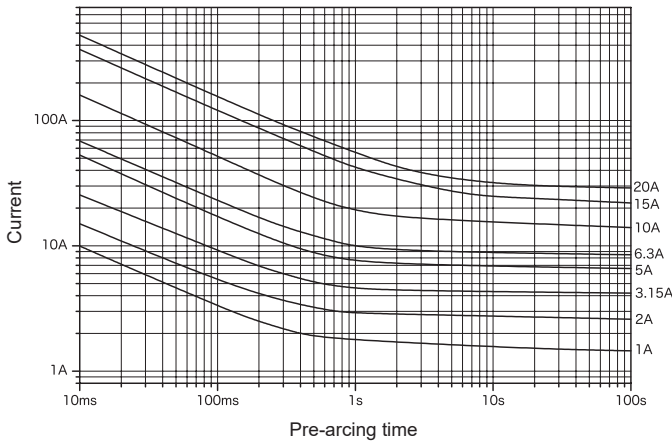

Scale: 1/1 (mm)

Rated voltage	Certification	Rated current (I <sub>N</sub> ) *1	Rated breaking current	Temp. rise	Current carrying capacity	Overload operation
AC 250 V	*2	100 mA–20 A	100 A PF 0.7–0.8	At 1.1 I <sub>N</sub> , 140 K or less at the center, 60 K or less at the contact	1.1 I <sub>N</sub> until constant temperature is obtained on each part	Within 60 min at 1.35 I <sub>N</sub> Within 2 min at 2.0 I <sub>N</sub>

\*1: Customer-requested rated current values can be supplied from within the given range.  
 \*2: Fuses with rated currents of less than 1 A are not considered electrical products per the Electrical Appliance and Material Safety Law.  
 \*3: 100 mA–12 A Pb free  
 Over 12 A–20 A This product uses high melting temperature type solder containing 85% by weight or more lead. This type of solder is exempted from the RoHS Directive.

Representative pre-arcing time-current characteristics

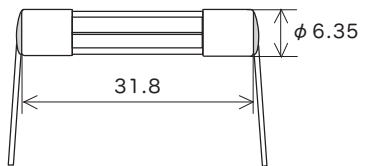
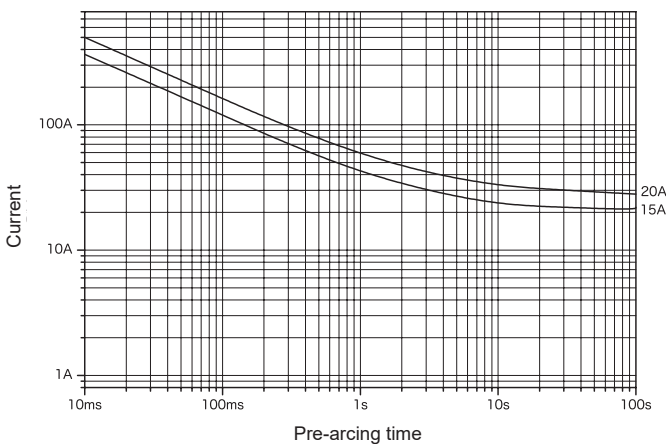

Lead wire diameter φ 0.8 (100 mA–8 A)  
 φ 1.0 (Over 8 A–15 A)  
 φ 1.2 (Over 15 A–20 A)  
 Scale: 1/1 (mm)

Rated voltage	Certification	Rated current (I <sub>N</sub> ) *1	Rated breaking current	Temp. rise	Current carrying capacity	Overload operation
AC 250 V	*2	100 mA–20 A	100 A PF 0.7–0.8	At 1.1 I <sub>N</sub> , 140 K or less at the center, 60 K or less at the contact	1.1 I <sub>N</sub> until constant temperature is obtained on each part	Within 60 min at 1.35 I <sub>N</sub> Within 2 min at 2.0 I <sub>N</sub>

\*1: Customer-requested rated current values can be supplied from within the given range.  
 \*2: Fuses with rated currents of less than 1 A are not considered electrical products per the Electrical Appliance and Material Safety Law.  
 \*3: 100 mA–12 A Pb free  
 Over 12 A–20 A This product uses high melting temperature type solder containing 85% by weight or more lead. This type of solder is exempted from the RoHS Directive.

# 250V (A) LLC

Normal-acting

RoHS-compliant\*3

Pb free\*3

Representative pre-arcing time-current characteristics

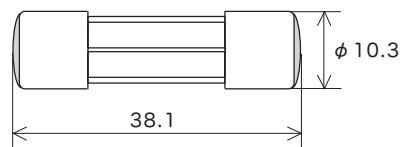
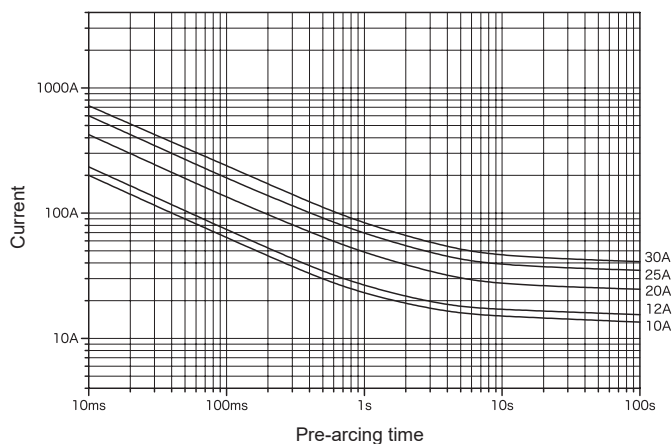

Scale: 1/1 (mm)

Rated voltage	Certification	Rated current (I <sub>N</sub> ) *1	Rated breaking current	Temp. rise	Current carrying capacity	Overload operation
AC 250 V	*2	500 mA–30 A	100 A PF 0.7–0.8	At 1.1 I <sub>N</sub> , 140 K or less at the center, 60 K or less at the contact	1.1 I <sub>N</sub> until constant temperature is obtained on each part	Within 60 min at 1.35 I <sub>N</sub> Within 2 min at 2.0 I <sub>N</sub>

\*1: Customer-requested rated current values can be supplied from within the given range.

\*2: Fuses with rated currents of less than 1 A are not considered electrical products per the Electrical Appliance and Material Safety Law.

\*3: 500 mA–12 A Pb free  
Over 12 A–30 A This product uses high melting temperature type solder containing 85% by weight or more lead. This type of solder is exempted from the RoHS Directive.

# 250V (A) LLCR

Normal-acting

RoHS-compliant\*3

Pb free\*3

Representative pre-arcing time-current characteristics

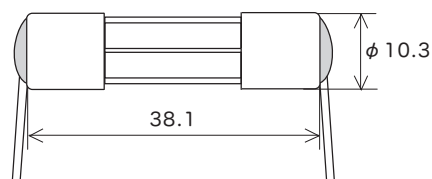
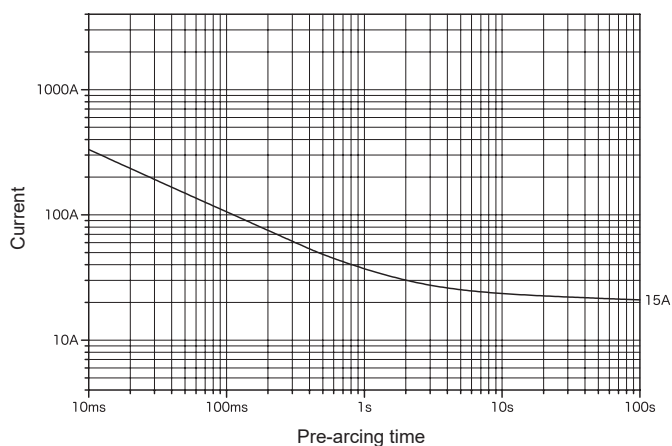

Lead wire diameter  $\phi$  0.8 (500 mA–8 A)  
 $\phi$  1.0 (Over 8 A–15 A)  
 $\phi$  1.2 (Over 15 A–30 A)

Scale: 1/1 (mm)

Rated voltage	Certification	Rated current (I <sub>N</sub> ) *1	Rated breaking current	Temp. rise	Current carrying capacity	Overload operation
AC 250 V	*2	500 mA–30 A	100 A PF 0.7–0.8	At 1.1 I <sub>N</sub> , 140 K or less at the center, 60 K or less at the contact	1.1 I <sub>N</sub> until constant temperature is obtained on each part	Within 60 min at 1.35 I <sub>N</sub> Within 2 min at 2.0 I <sub>N</sub>

\*1: Customer-requested rated current values can be supplied from within the given range.

\*2: Fuses with rated currents of less than 1 A are not considered electrical products per the Electrical Appliance and Material Safety Law.

\*3: 500 mA–12 A Pb free  
Over 12 A–30 A This product uses high melting temperature type solder containing 85% by weight or more lead. This type of solder is exempted from the RoHS Directive.

Representative pre-arcing time-current characteristics

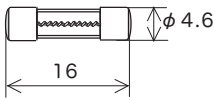
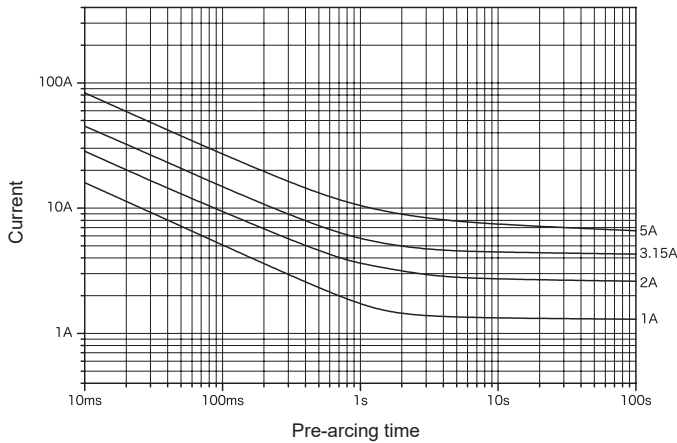

Scale: 1/1 (mm)

Rated voltage	Certification	Rated current (I <sub>N</sub> ) *1	Rated breaking current	Temp. rise	Current carrying capacity	Overload operation
AC 250 V	*2	100 mA–5 A	100 A PF 0.7–0.8	At 1.1 I <sub>N</sub> , 140 K or less at the center, 60 K or less at the contact	1.1 I <sub>N</sub> until constant temperature is obtained on each part	Within 60 min at 1.35 I <sub>N</sub> Within 2 min at 2.0 I <sub>N</sub>

\*1: Customer-requested rated current values can be supplied from within the given range.  
 \*2: Fuses with rated currents of less than 1 A are not considered electrical products per the Electrical Appliance and Material Safety Law.

Representative pre-arcing time-current characteristics

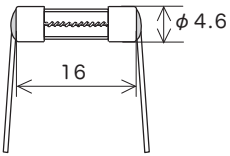
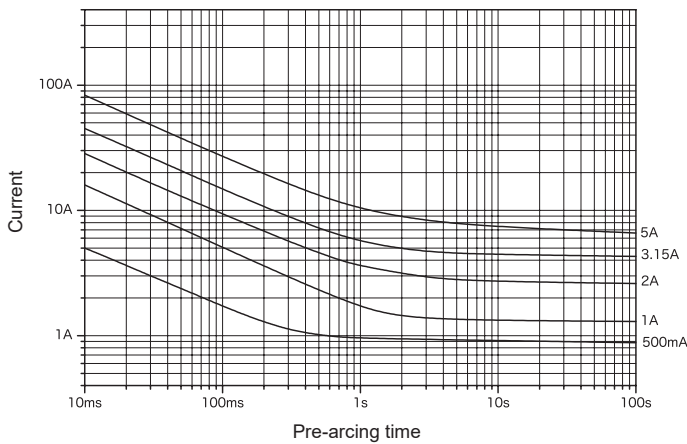

Lead wire diameter  $\phi$  0.5 (100 mA to less than 5 A)  $\phi$  0.8 (5 A) Scale: 1/1 (mm)

Rated voltage	Certification	Rated current (I <sub>N</sub> ) *1	Rated breaking current	Temp. rise	Current carrying capacity	Overload operation
AC 250 V	*2	100 mA–5 A	100 A PF 0.7–0.8	At 1.1 I <sub>N</sub> , 140 K or less at the center, 60 K or less at the contact	1.1 I <sub>N</sub> until constant temperature is obtained on each part	Within 60 min at 1.35 I <sub>N</sub> Within 2 min at 2.0 I <sub>N</sub>

\*1: Customer-requested rated current values can be supplied from within the given range.  
 \*2: Fuses with rated currents of less than 1 A are not considered electrical products per the Electrical Appliance and Material Safety Law.  
 \*3: 100 mA to less than 5 A Pb free  
 5 A This product uses high melting temperature type solder containing 85% by weight or more lead. This type of solder is exempted from the RoHS Directive.

Representative pre-arcing time-current characteristics

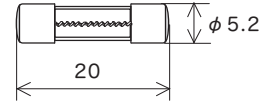
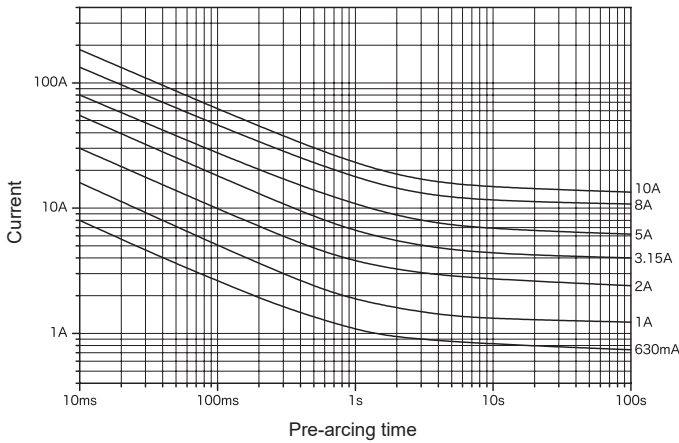

Scale: 1/1 (mm)

Rated voltage	Certification	Rated current (I <sub>N</sub> ) *1	Rated breaking current		Temp. rise	Current carrying capacity	Overload operation
AC 250 V	*2	100 mA–10 A	100 A	PF 0.7–0.8	At 1.1 I <sub>N</sub> , 140 K or less at the center, 60 K or less at the contact	1.1 I <sub>N</sub> until constant temperature is obtained on each part	Within 60 min at 1.35 I <sub>N</sub> Within 2 min at 2.0 I <sub>N</sub>

\*1: Customer-requested rated current values can be supplied from within the given range.  
\*2: Fuses with rated currents of less than 1 A are not considered electrical products per the Electrical Appliance and Material Safety Law.

Representative pre-arcing time-current characteristics

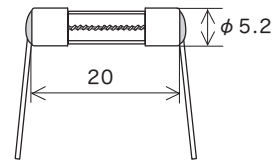
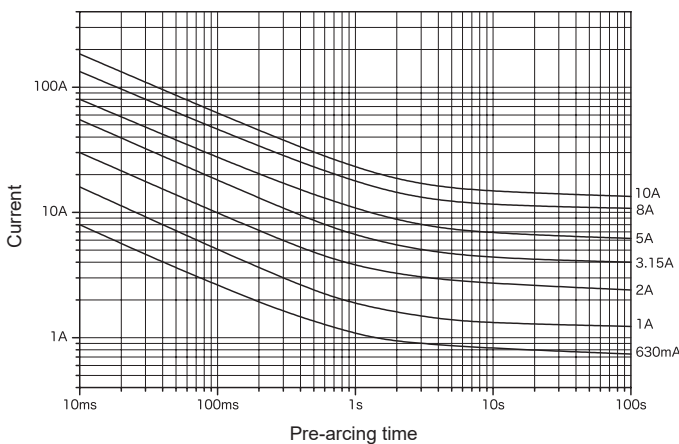

Lead wire diameter  $\phi$  0.5 (100 mA to less than 5 A)  $\phi$  0.8 (5 A–10 A) Scale: 1/1 (mm)

Rated voltage	Certification	Rated current (I <sub>N</sub> ) *1	Rated breaking current		Temp. rise	Current carrying capacity	Overload operation
AC 250 V	*2	100 mA–10 A	100 A	PF 0.7–0.8	At 1.1 I <sub>N</sub> , 140 K or less at the center, 60 K or less at the contact	1.1 I <sub>N</sub> until constant temperature is obtained on each part	Within 60 min at 1.35 I <sub>N</sub> Within 2 min at 2.0 I <sub>N</sub>

\*1: Customer-requested rated current values can be supplied from within the given range.  
\*2: Fuses with rated currents of less than 1 A are not considered electrical products per the Electrical Appliance and Material Safety Law.

Representative pre-arcing time-current characteristics

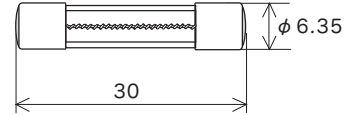
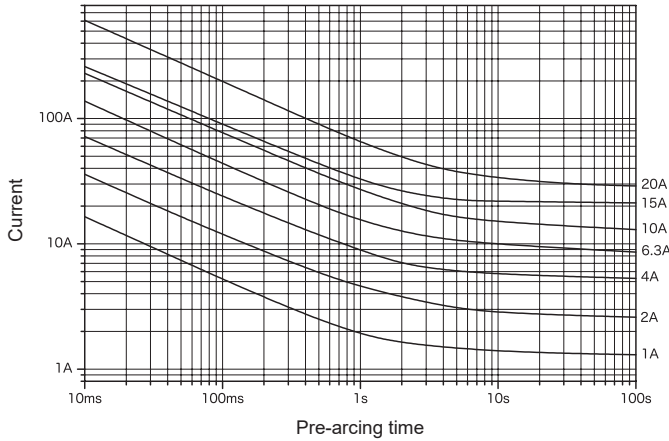

Scale: 1/1 (mm)

Rated voltage	Certification	Rated current (I <sub>N</sub> ) *1	Rated breaking current	Temp. rise	Current carrying capacity	Overload operation
AC 250 V	*2	100 mA–5 A	500 A	PF 0.7–0.8	1.1 I <sub>N</sub> until constant temperature is obtained on each part	Within 60 min at 1.35 I <sub>N</sub> Within 2 min at 2.0 I <sub>N</sub>
		Over 5 A–30 A	100 A			

\*1: Customer-requested rated current values can be supplied from within the given range.  
 \*2: Fuses with rated currents of less than 1 A are not considered electrical products per the Electrical Appliance and Material Safety Law.  
 \*3: 100 mA–12 A Pb free  
 Over 12 A–30 A This product uses high melting temperature type solder containing 85% by weight or more lead. This type of solder is exempted from the RoHS Directive.

Representative pre-arcing time-current characteristics

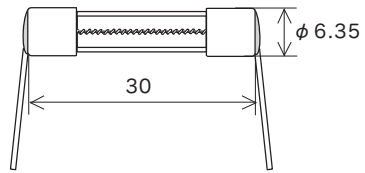
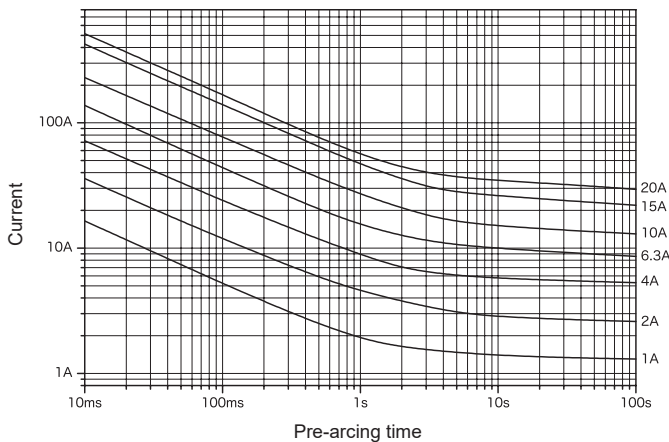

Lead wire diameter φ 0.8 (100 mA–8 A)  
 φ 1.0 (Over 8 A–15 A)  
 φ 1.2 (Over 15 A–30 A) Scale: 1/1 (mm)

Rated voltage	Certification	Rated current (I <sub>N</sub> ) *1	Rated breaking current	Temp. rise	Current carrying capacity	Overload operation
AC 250 V	*2	100 mA–5 A	500 A	PF 0.7–0.8	1.1 I <sub>N</sub> until constant temperature is obtained on each part	Within 60 min at 1.35 I <sub>N</sub> Within 2 min at 2.0 I <sub>N</sub>
		Over 5 A–30 A	100 A			

\*1: Customer-requested rated current values can be supplied from within the given range.  
 \*2: Fuses with rated currents of less than 1 A are not considered electrical products per the Electrical Appliance and Material Safety Law.  
 \*3: 100 mA–12 A Pb free  
 Over 12 A–30 A This product uses high melting temperature type solder containing 85% by weight or more lead. This type of solder is exempted from the RoHS Directive.



# 250V Ⓐ TLNC

Inrush-withstand

RoHS-compliant\*3

Pb free\*3

Representative pre-arcing time-current characteristics

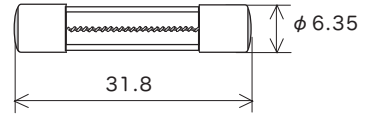
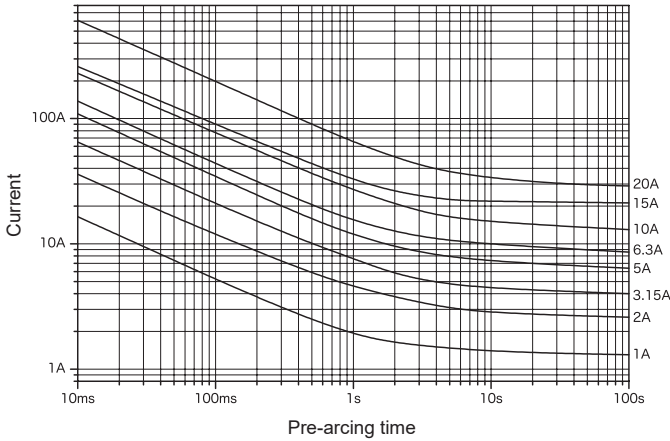

Scale: 1/1 (mm)

Rated voltage	Certification	Rated current (I <sub>N</sub> ) *1	Rated breaking current	Temp. rise	Current carrying capacity	Overload operation
AC 250 V	*2	100 mA–5 A	500 A	PF 0.7–0.8	1.1 I <sub>N</sub> until constant temperature is obtained on each part	Within 60 min at 1.35 I <sub>N</sub> Within 2 min at 2.0 I <sub>N</sub>
		Over 5 A–20 A	100 A			

\*1: Customer-requested rated current values can be supplied from within the given range.  
 \*2: Fuses with rated currents of less than 1 A are not considered electrical products per the Electrical Appliance and Material Safety Law.  
 \*3: 100 mA–12 A Pb free  
 Over 12 A–20 A This product uses high melting temperature type solder containing 85% by weight or more lead. This type of solder is exempted from the RoHS Directive.

# 250V Ⓐ TLNCR

Inrush-withstand

RoHS-compliant\*3

Pb free\*3

Representative pre-arcing time-current characteristics

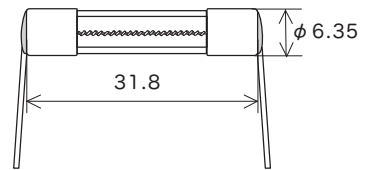
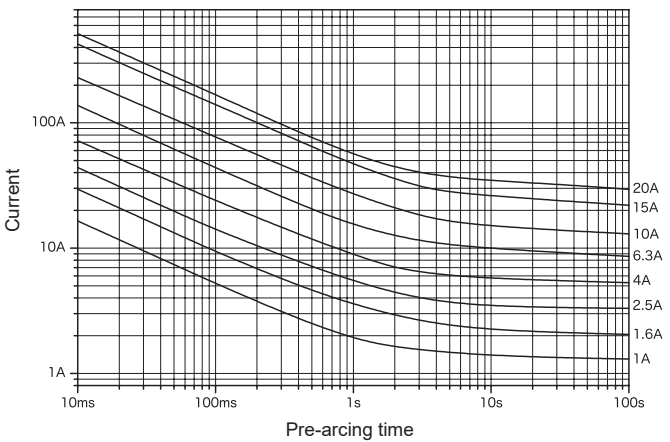

Lead wire diameter  $\phi$  0.8 (100 mA–8 A)  
 $\phi$  1.0 (Over 8 A–15 A)  
 $\phi$  1.2 (Over 15 A–20 A) Scale: 1/1 (mm)

Rated voltage	Certification	Rated current (I <sub>N</sub> ) *1	Rated breaking current	Temp. rise	Current carrying capacity	Overload operation
AC 250 V	*2	100 mA–5 A	500 A	PF 0.7–0.8	1.1 I <sub>N</sub> until constant temperature is obtained on each part	Within 60 min at 1.35 I <sub>N</sub> Within 2 min at 2.0 I <sub>N</sub>
		Over 5 A–20 A	100 A			

\*1: Customer-requested rated current values can be supplied from within the given range.  
 \*2: Fuses with rated currents of less than 1 A are not considered electrical products per the Electrical Appliance and Material Safety Law.  
 \*3: 100 mA–12 A Pb free  
 Over 12 A–20 A This product uses high melting temperature type solder containing 85% by weight or more lead. This type of solder is exempted from the RoHS Directive.

# 250V Ⓐ TLLC

Inrush-withstand

RoHS-compliant\*3

Pb free\*3

Representative pre-arcing time-current characteristics

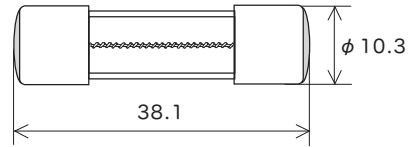
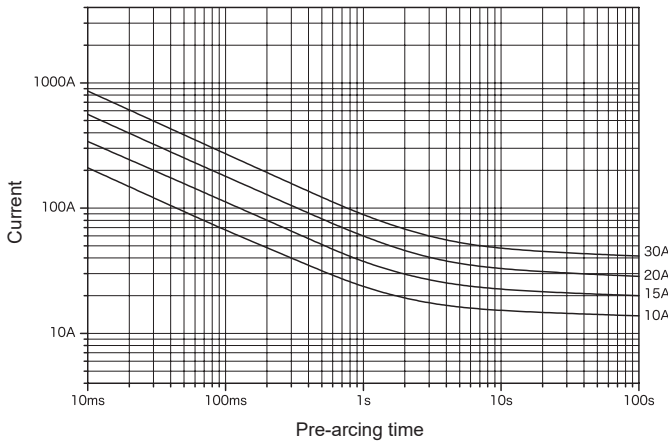

Scale: 1/1 (mm)

Rated voltage	Certification	Rated current (I <sub>N</sub> ) *1	Rated breaking current	Temp. rise	Current carrying capacity	Overload operation
AC 250 V	*2	500 mA–5 A	500 A	PF 0.7–0.8	1.1 I <sub>N</sub> until constant temperature is obtained on each part	Within 60 min at 1.35 I <sub>N</sub> Within 2 min at 2.0 I <sub>N</sub>
		Over 5 A–30 A	100 A			

- \*1: Customer-requested rated current values can be supplied from within the given range.
- \*2: Fuses with rated currents of less than 1 A are not considered electrical products per the Electrical Appliance and Material Safety Law.
- \*3: 500 mA–12 A Pb free  
Over 12 A–30 A This product uses high melting temperature type solder containing 85% by weight or more lead. This type of solder is exempted from the RoHS Directive.

# 250V Ⓐ TLLCR

Inrush-withstand

RoHS-compliant\*3

Pb free\*3

Representative pre-arcing time-current characteristics

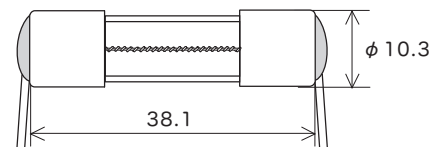
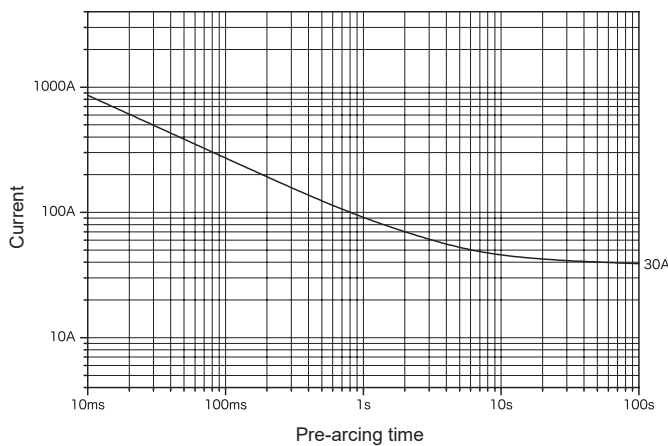

Lead wire diameter  $\phi$  0.8 (500 mA–8 A)  
 $\phi$  1.0 (Over 8 A–15 A)  
 $\phi$  1.2 (Over 15 A–30 A) Scale: 1/1 (mm)

Rated voltage	Certification	Rated current (I <sub>N</sub> ) *1	Rated breaking current	Temp. rise	Current carrying capacity	Overload operation
AC 250 V	*2	500 mA–5 A	500 A	PF 0.7–0.8	1.1 I <sub>N</sub> until constant temperature is obtained on each part	Within 60 min at 1.35 I <sub>N</sub> Within 2 min at 2.0 I <sub>N</sub>
		Over 5 A–30 A	100 A			

- \*1: Customer-requested rated current values can be supplied from within the given range.
- \*2: Fuses with rated currents of less than 1 A are not considered electrical products per the Electrical Appliance and Material Safety Law.
- \*3: 500 mA–12 A Pb free  
Over 12 A–30 A This product uses high melting temperature type solder containing 85% by weight or more lead. This type of solder is exempted from the RoHS Directive.

## BM-SS-I-14

Fuse size:  $\phi$  5.2 mm  $\times$  L20 mm  
 Rating: AC 250 V 15 A  
 Certification: UL Recognized  
 Base material: Phenolic resin  
 (UL94V-0)  
 Surface treatment: Nickel plated

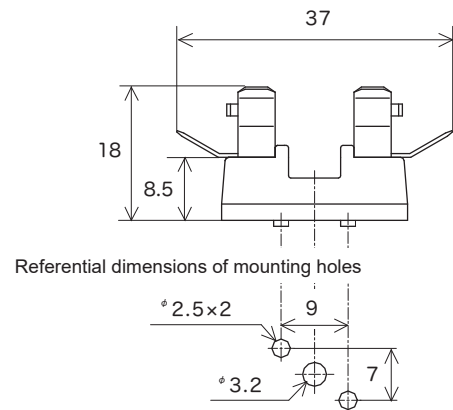

## BM-LQ-I-13

Fuse size:  $\phi$  6.35 mm  $\times$  L30 mm  
 $\phi$  6.35 mm  $\times$  L31.8 mm  
 Rating: AC 250 V 30 A  
 Certification: UL Recognized  
 Base material: Phenolic resin  
 (UL94V-0)  
 Surface treatment: Tin plated

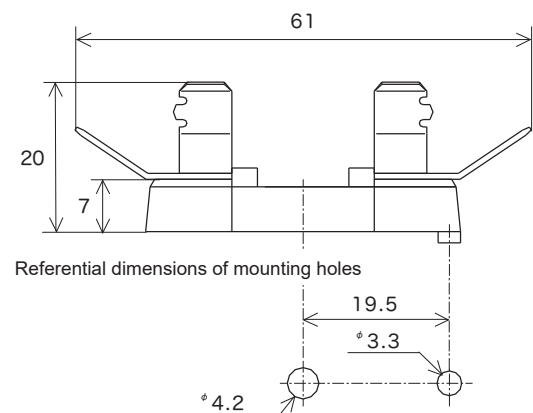

## BM-LQ-I-15

Fuse size:  $\phi$  10.3 mm  $\times$  L38.1 mm  
 Rating: AC 250 V 30 A  
 Certification: UL Recognized  
 Base material: Phenolic resin  
 (UL94V-0)  
 Surface treatment: Nickel plated

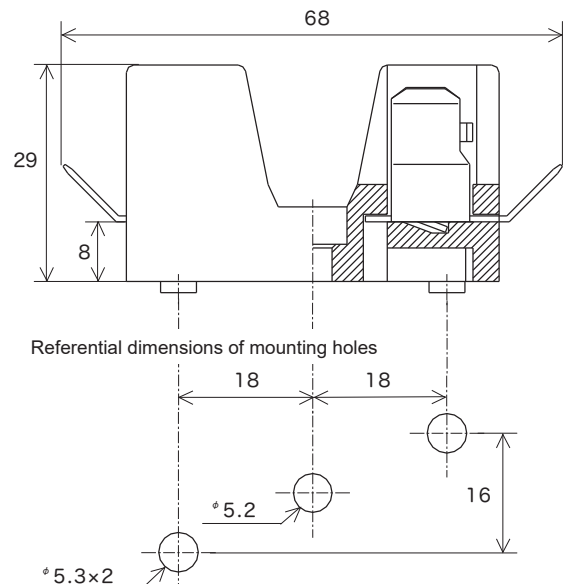

### ⚠ CAUTION

- The fuseholder ratings shown above represent the maximum ratings for fuses that can be used under normal circumstances. Rated currents are based on the assumption that a fuse inserted in a fuseholder will operate at less than or equal to 1.35 times the fuseholder's rating. For all other cases, please contact your SOC representative.
- When inserting a fuse into a fuseholder, please do not force the fuse into the holder or hit the fuse. Contact failure caused by damage to the fuse or deformation of the fuseholder's clips due to impact or forcing the fuse into the holder may significantly alter the fuse's electrical characteristics and lifetime, and may lead to accidents including nuisance operations.

# Fuse clips

RoHS-compliant

Pb free

Unit: mm

## H-0016-2

Fuse size:  $\phi$  5.2 mm  
 Rating: AC / DC 10 A  
 Thickness: 0.4 mm  
 Material: C5191  
 phosphor bronze  
 Surface treatment: Tin plated

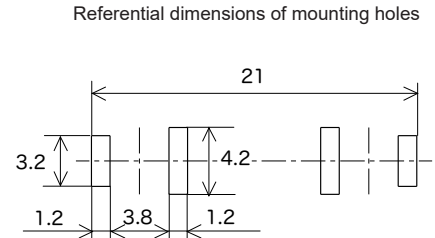
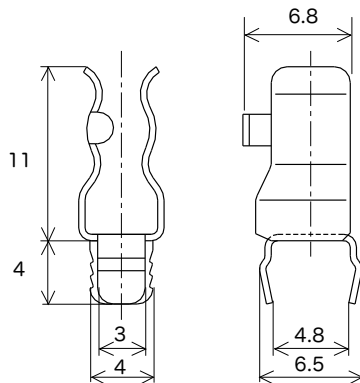

## H-0032-2

Fuse size:  $\phi$  5.2 mm  
 Rating: AC / DC 10 A  
 Thickness: 0.35 mm  
 Material: C5191  
 phosphor bronze  
 Surface treatment: Tin plated

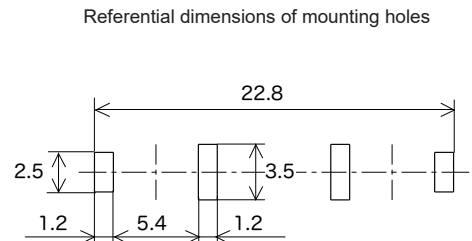
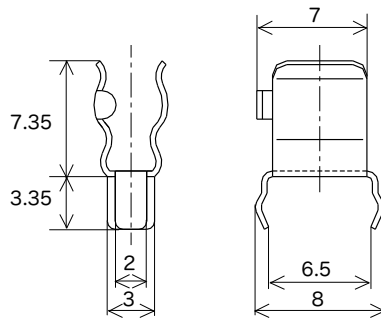

## H-0014-2

Fuse size:  $\phi$  6.35 mm  
 Rating: AC / DC 15 A  
 Thickness: 0.4 mm  
 Material: C5191  
 phosphor bronze  
 Surface treatment: Tin plated

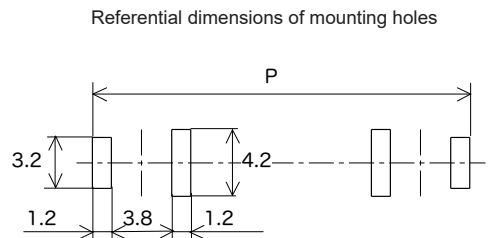
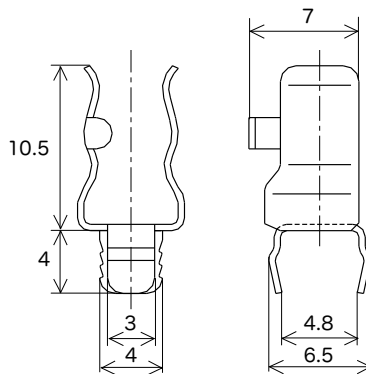

P=31 for  $\phi$  6.35  $\times$  L30 mm fuses  
 P=33 for  $\phi$  6.35  $\times$  L31.8 mm fuses

# Fuse clips

RoHS-compliant

Pb free

Unit: mm

## H-0017-2

Fuse size:  $\phi$  6.35 mm  
 Rating: AC / DC 15A  
 Thickness: 0.5 mm  
 Material: C5191 phosphor bronze  
 Surface treatment: Tin plated

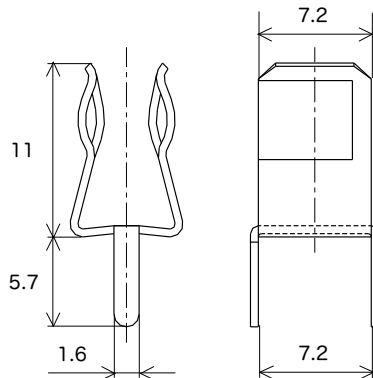

Referential dimensions of mounting holes

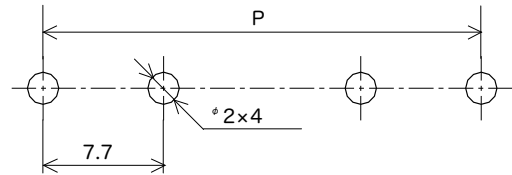

P=34.7 for  $\phi$  6.35  $\times$  L30 mm fuses  
 P=36.7 for  $\phi$  6.35  $\times$  L31.8 mm fuses

## H-0048-2

Fuse size:  $\phi$  5.2 mm  
 $\phi$  6.35 mm  
 Rating: AC / DC 15 A  
 Thickness: 0.4 mm  
 Material: C5191 phosphor bronze  
 Surface treatment: Tin plated

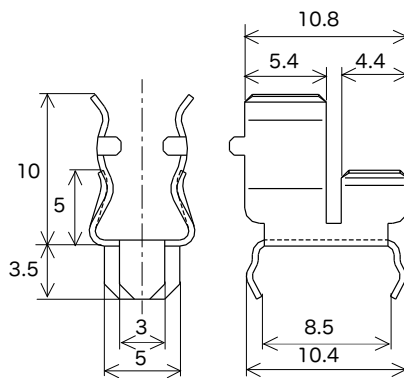

Referential dimensions of mounting holes

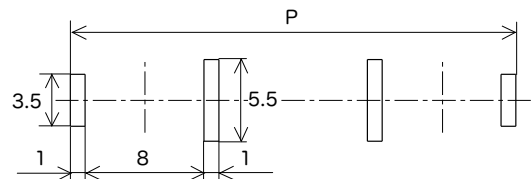

P=30.6 for  $\phi$  5.2  $\times$  L20 mm fuses  
 P=29.8 for  $\phi$  6.35  $\times$  L30 mm fuses  
 P=31.6 for  $\phi$  6.35  $\times$  L31.8 mm fuses

## H-0084-2

Fuse size:  $\phi$  10.3 mm  
 Rating: AC / DC 30 A  
 Thickness: 0.7 mm  
 Material: C5191 phosphor bronze  
 Surface treatment: Tin plated

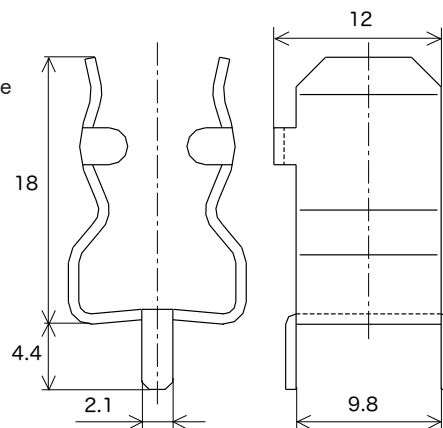

Referential dimensions of mounting holes

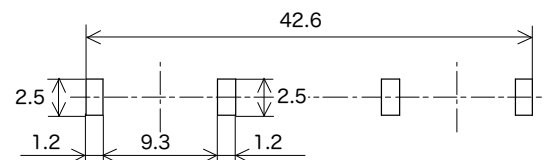

# Technical information

## Resistance to soldering heat

■ Fuses are heat-sensitive components. The soldering conditions shown below are examples based on the use of our facilities. Sufficiently evaluate and examine your company's soldering conditions as they may vary depending on such factors as available facilities, solder type, solder quantity, board size, and board materials.

■ Board and solder used

Board: Glass epoxy, thickness 1.6 mm

Solder: Sn-3.0Ag-0.5Cu

■ Surface mount fuses: Reflow soldering  
(11CT Type / 25CT Type / 36CFA / 36CT)

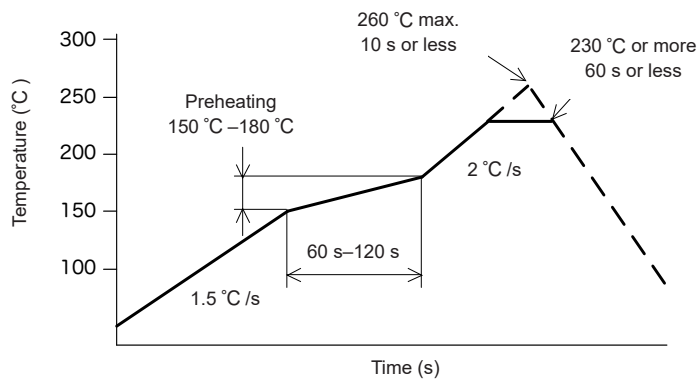

Soldering can be repeated a maximum of two times under these conditions.

※ For 36CFA fuses, please ensure that the height of the fillets is not more than one-third of the entire height of the fuse.

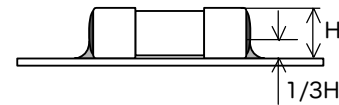

**Note:** Please contact your sales representative for information concerning the MCF3.

■ Sub-miniature fuses with leads (25RT Type)

• Wave soldering

Solder bath temp.: 260 °C or less

Duration: 10 s or less

• Hand soldering with soldering iron

Soldering iron tip temp.: 380 °C or less

Duration: 5 s or less

■ Pin terminal fuses (SMC N4)

• Wave soldering

Solder bath temp.: 265 °C or less

Duration: 5 s or less

• Hand soldering with soldering iron

Soldering iron tip temp.: 350 °C or less

Duration: 2 s or less

■ Cartridge fuses with leads

• Wave soldering

Preheating temp.: 80 °C–140 °C  
 Preheating time: 30 s–60 s  
 Solder bath temp.: 260 °C or less  
 Duration: 7 s or less

• Hand soldering with soldering iron

Soldering iron tip temp.: 380 °C or less  
 Duration: 3 s or less

Lead wire diameter	Distance between the fuse body and the side to be soldered (L)
φ 0.5 mm φ 0.6 mm	5 mm or more
φ 0.8 mm φ 1.0 mm φ 1.2 mm	8 mm or more

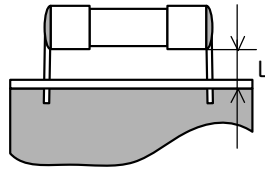

Lead wire diameter	Distance between the fuse body and the side to be soldered (L)
φ 0.5 mm φ 0.6 mm φ 0.8 mm φ 1.0 mm φ 1.2 mm	5 mm or more

**Whiskers**

The following tests are performed to ensure there is no whisker generation on the tin-plated parts of our products.

■ Temperature cycling test

After test samples are subjected to 500 cycles of temperature cycling as specified below, there shall be no whisker generation when observed using a microscope with a magnification of 40 times.

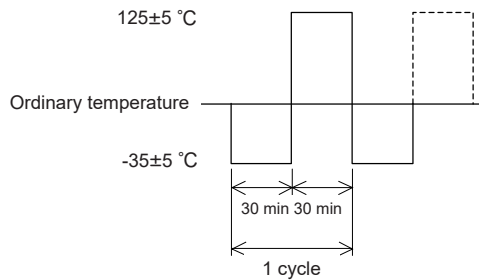

■ Constant temperature and humidity test

After test samples are left at a temperature of 85 °C and an RH of 85% for 500 h, there shall be no whisker generation when observed using a microscope with a magnification of 40 times.

**Storage conditions**

- Prerequisite: Products shall be packaged as delivered.
- Ambient temperature: -20 °C–+40 °C
- Ambient humidity: 85% RH or less
- Storage environment: Not exposed to corrosive gas or sea breeze.  
Not exposed to direct sunlight.  
Not subjected to loads which could cause deformation of the products.
- Storage period: Within one year from the date on the product packaging.

## Packaging specifications

### ■ Surface mount fuses

Packaging method	Tape and reel packaging			Bag packaging	
Packaging code	R08B4	R12A4	R24D4	B	
Qty. packed	2000 pcs.	1000 pcs.	2000 pcs.	100 pcs.	
Dimensions (mm)	A	4	4	-	
	B	8	12		
	C	11.4	15.6		
	D	180	178		
Type name	11CF 11CT 32V11CF P11CF P11CT DC35V11CT DC35VP11CF DC35VP11CT	DC86V11CT 11CFB 11CTB MCF3	25CF 25CT DC300V25CF P25CF P25CT DC35VP25CF DC35VP25CT	36CFA 36CT	Used for all fuse types

Tape and reel configuration / packing method (unit: mm)

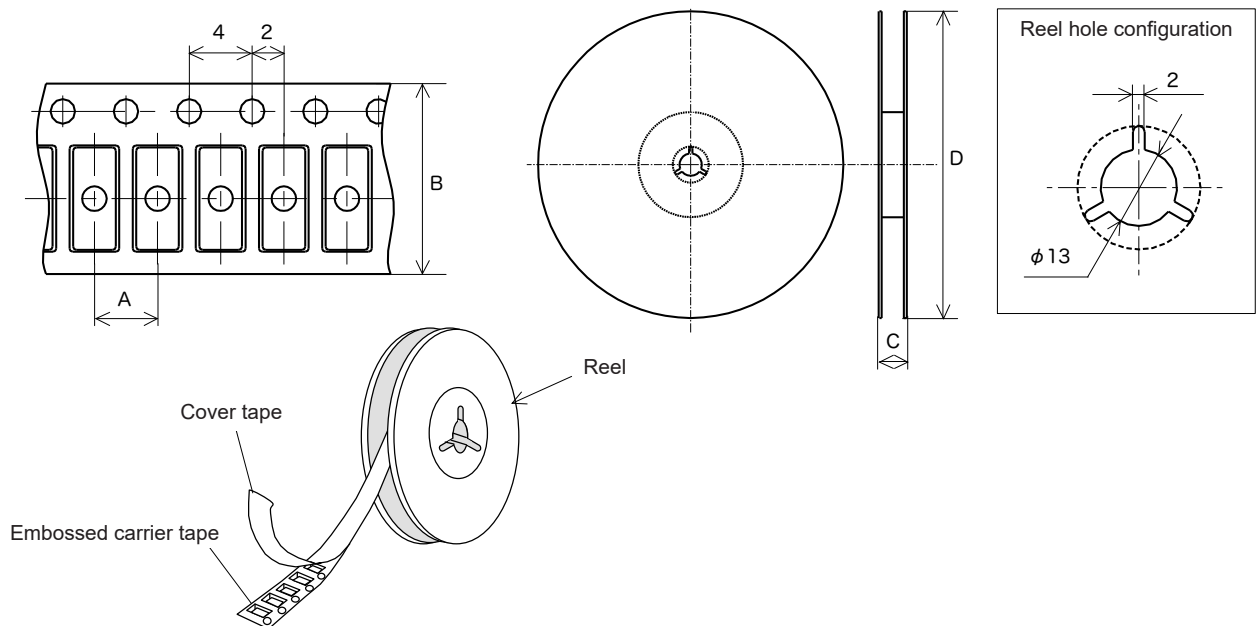

### ■ Bag packaging for sub-miniature fuses with leads

Type name	Forming specification	Standard total qty. per box	Packaging method
25RF	F002	2000 pcs.	100 pcs. x 20 bags
P25RF	F003		
DC35VP25RF	F006	1000 pcs.	100 pcs. x 10 bags
25RT	F007		
P25RT	F116		
DC35VP25RT			



■ Bag / tape packaging for pin terminal fuses

Type name	Standard total qty. per box	Packaging method
SMC N4	1000 pcs.	Tape packaging

Tape configuration / packing method for SMC N4 (unit: mm)

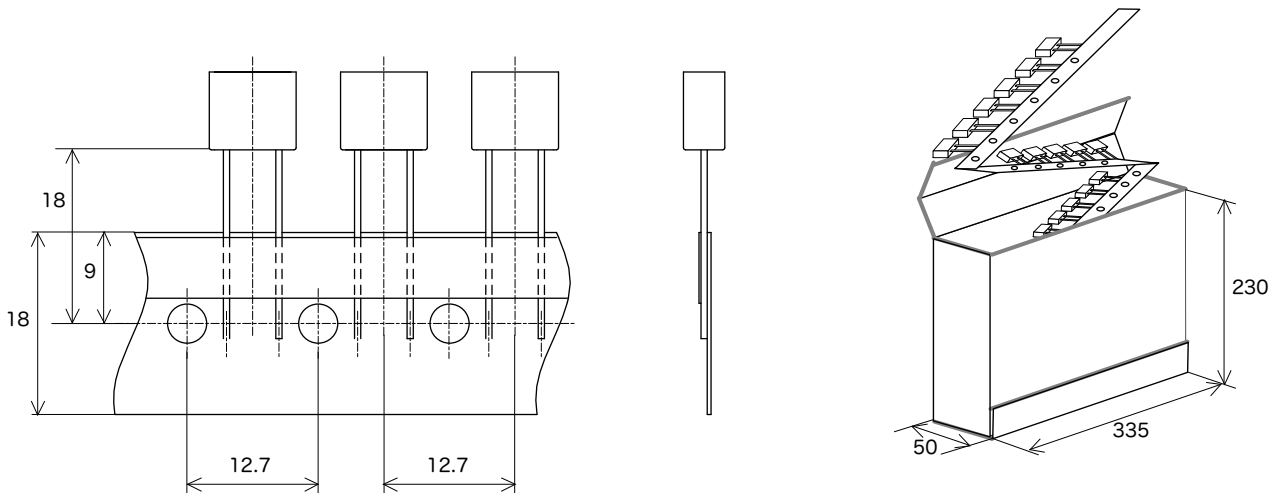

■ Bag packaging for cartridge fuses

Fuse dimensions (mm)	Standard total quantity per box		
	Cartridge type	Cartridge type with leads	
		Leads of $\phi$ 0.6mm or less	Leads of $\phi$ 0.8mm or greater
$\phi$ 4 × L9	2000 pcs. (1000 pcs. × 2 bags)	400 pcs. (100 pcs. × 4 bags)	400 pcs. (100 pcs. × 4 bags)
$\phi$ 4.6 × L14	1000 pcs. (1000 pcs. × 1 bag)	-	200 pcs. (100 pcs. × 2 bags)
$\phi$ 4.6 × L16	1000 pcs. (1000 pcs. × 1 bag)	400 pcs. (100 pcs. × 4 bags)	200 pcs. (100 pcs. × 2 bags)
$\phi$ 5.2 × L20	1000 pcs. (1000 pcs. × 1 bag)	400 pcs. (100 pcs. × 4 bags)	200 pcs. (100 pcs. × 2 bags)
$\phi$ 6.35 × L15.9	500 pcs. (500 pcs. × 1 bag)	-	200 pcs. (100 pcs. × 2 bags)
$\phi$ 6.35 × L20	-	-	100 pcs. (100 pcs. × 1 bag)
$\phi$ 6.35 × L25.4	500 pcs. (500 pcs. × 1 bag)	-	100 pcs. (100 pcs. × 1 bag)
$\phi$ 6.35 × L30	500 pcs. (500 pcs. × 1 bag)	-	100 pcs. (100 pcs. × 1 bag)
$\phi$ 6.35 × L31.8	400 pcs. (400 pcs. × 1 bag)	-	100 pcs. (100 pcs. × 1 bag)
$\phi$ 7.14 × L31.8	300 pcs. (300 pcs. × 1 bag)	-	-
$\phi$ 10.3 × L38.1	100 pcs. (100 pcs. × 1 bag)	-	50 pcs. (50 pcs. × 1 bag)

Please contact your sales representative for product packaging specifications not listed in this catalog.

## Forming specifications

Please contact your sales representative for forming specifications not listed below and for questions regarding dimensional tolerances.

### ■ Cartridge fuses with leads (unit: mm)

The D dimensions in parentheses are for reference purposes only, and are not intended to infer any guaranteed values.

Fig. No.	Fuse dimensions	Lead wire diameter	Forming No.	Dimensions			
				A	B	C	D
* 1	$\phi 4 \times L9$	0.8	F451	5.2	10	9	(10)
	$\phi 4.6 \times L16$	0.8	F051	5.2	10	16	(17)
	$\phi 5.2 \times L20$	0.8	F013	5	9.5	20	(21)
		1.0	F057	5	8.6	20	(21.4)
	$\phi 6.35 \times L30$	1.0	F916	5	9.7	30	(32.2)
	$\phi 6.35 \times L31.8$	1.0	F019	5	40	31.8	(33)
		1.2	F021	5	9	31.8	(33)
0.8		F918	5	9	31.8	(33)	
* 2	$\phi 6.35 \times L30$	1.2	F915	5	9.7	30	(32.2)
* 3	$\phi 6.35 \times L30$	1.2	F502	5	9.7	30	(25)
* 4	$\phi 4.6 \times L14$	0.8	F024	5	10	14	(15)
	$\phi 4.6 \times L16$	0.8	F025	5	10	16	(17)
	$\phi 5.2 \times L20$	0.8	F026	5	10	20	(21)
		1.0	F036	5	10	20	(21)

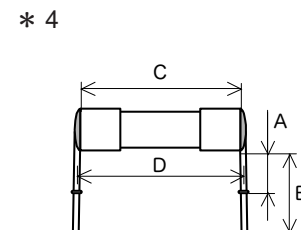
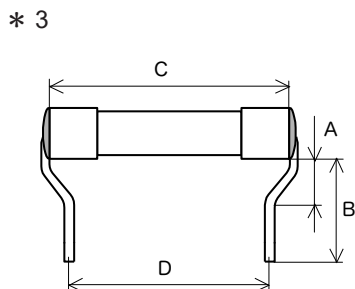
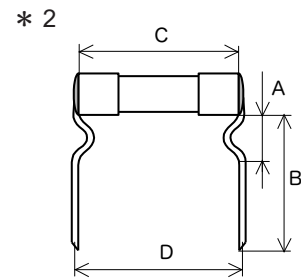
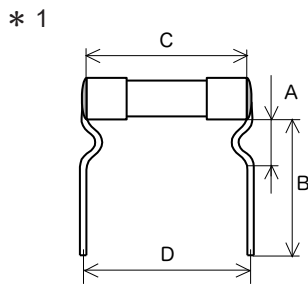

■ 25RT Type fuses (unit: mm, lead wire diameter:  $\phi$  0.8mm)

Forming No. F002

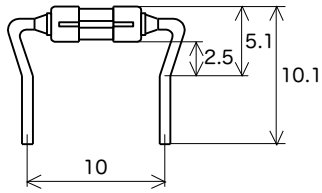

Forming No. F003

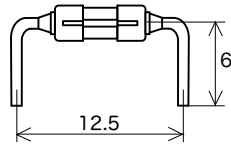

Forming No. F006

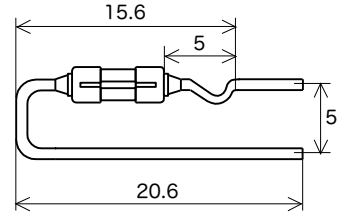

Forming No. F007

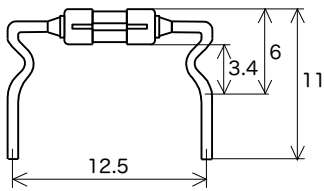

Forming No. F116

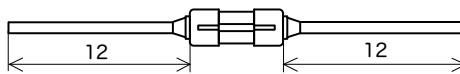

■ Lead wire forming

When forming by hand

○ Correct

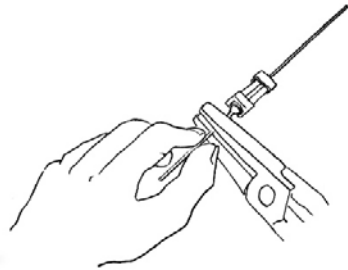

× Incorrect

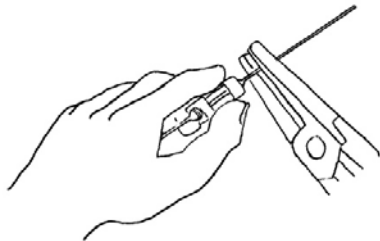

When forming with forming dies

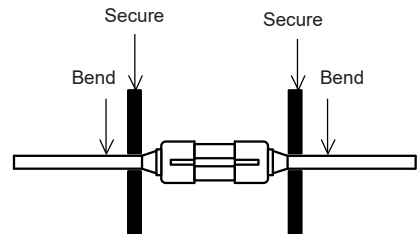

When forming lead wires, always secure the area between the fuse body and the part of the lead wire to be formed as shown in the figure above. Make sure not to put any stress on the area connecting the fuse body and the lead wire.

# Fuse selection process

## Fuse selection process

Properly selected fuses prevent accidents by breaking abnormal currents when they flow through electric circuits. Improper selection, however, can result in nuisance operations, continued flow of abnormal currents, generation of smoke and/or fire, and other dangers.

## Safety precautions when selecting fuses

■ What is the voltage of the circuit the fuse will be used in?

Make sure to select a fuse that has a rated voltage higher than the voltage of the circuit.

The rated voltage of a fuse is the maximum voltage at which the fuse can safely interrupt an abnormal current. If the voltage of the circuit is higher than the fuse's rated voltage, there is a danger the fuse may be destroyed as shown below. Please exercise caution.



Example of a breaking test where the circuit voltage is higher than the rated voltage of the fuse

■ Will the fuse be used in an AC circuit or a DC circuit?

Only select DC rated fuses for DC circuits, and AC rated fuses for AC circuits.

For AC circuits, there is a tendency for arc discharges to be extinguished when the power supply voltage goes to zero as shown in Figure 1 below. Caution should be exercised regarding use of DC circuits as DC voltage does not go to zero, and therefore there is the risk that an arc discharge may not be extinguished which may result in destruction of the fuse.

Therefore, due to the difference in circuit characteristics for AC and DC circuits, mistakenly using an AC fuse in a DC circuit or a DC fuse in an AC circuit may cause an accident.

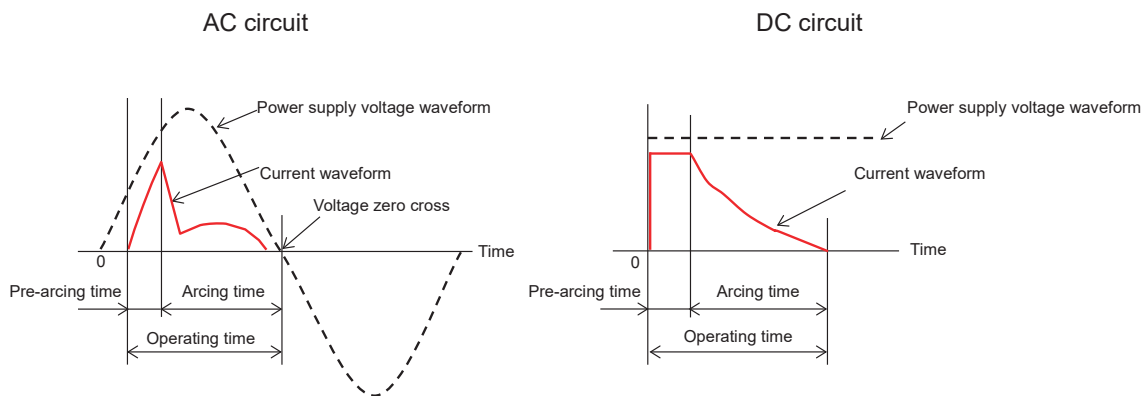

Figure 1 - Fuse operation waveforms and showing the difference between AC and DC circuits (actual waveforms may differ from the above)

■ What is the power factor / time constant of the circuit in which the fuse is to be installed?

The amount of the inductance of the circuit relates to the magnitude of the power factor or the time constant. When interrupting an abnormal current in a circuit with a large inductance, an arc voltage greater than that of the power supply may occur, and the fuse may be unable to safely break the current. The larger the inductance, the greater the arc energy generated at the fuse. The fuse is destroyed if it cannot withstand the arc energy.

When selecting fuses, please confirm that the fuse you have selected can safely clear abnormal currents in the equipment in which it is to be used.

■ How will the fuse be mounted?

(1) Mounting directly to a wiring circuit board

a) Surface mount type

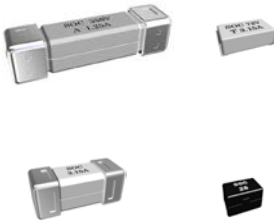

b) Terminals passed through holes in a wiring circuit board (pin terminals, lead terminals, and others)



(2) Mounting a fuse in a fuseholder (or clips)



(3) Directly bolted to a circuit



Please contact us for development of custom-designed fuses based on your shape and dimensional requirements.

■ How large current will be passed through the circuit the fuse will be used in?

A rated current is defined for each fuse, and this value is marked on it. Understanding the following circuit currents (including their waveforms) is important for selecting the appropriate rated current and rated breaking current<sup>\*1</sup> for a fuse in order to prevent nuisance operations and ensure the fuse is able to interrupt abnormal currents.

- Steady-state current
- Inrush current
- Abnormal current

\*1 "Rated breaking capacity" is used in IEC 60127 (Miniature fuses) series, "interrupting rating" in the UL/CSA 248 series (Low-voltage fuses), and "rated breaking capacity" in JIS C 6575 (Miniature fuses) series, but all of these refer to the rated breaking current.

(1) Evaluation of a steady-state current

In order to avoid nuisance operation over long-term use, please select a fuse which has pre-arcing time-current characteristics<sup>\*2</sup> such that the fusing current is sufficiently larger than the steady-state current (root mean squared value) of the actual circuit in which the fuse will be installed. Figure 2 shows an example of the necessary difference (margin) between fusing current and actual circuit current.

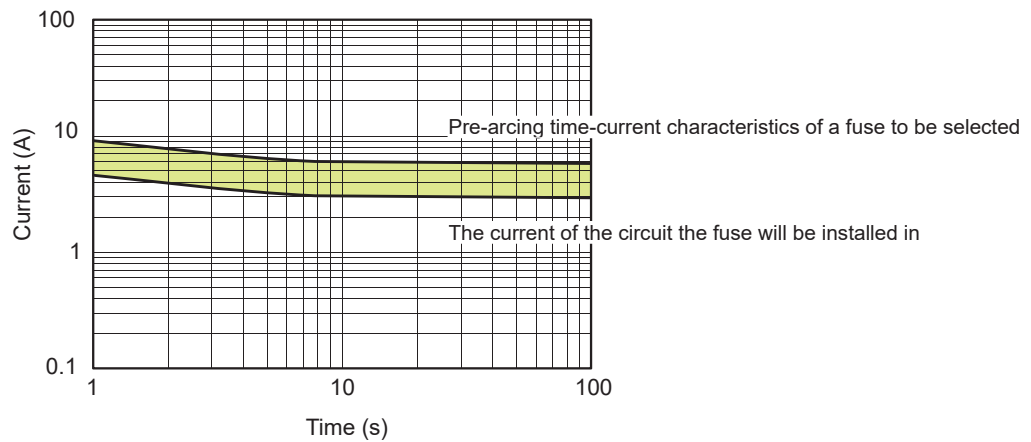

Figure 2 - Fuse selection example for a steady-state current

\*2 Pre-arcing time-current characteristics:

As shown in Figure 3, pre-arcing time-current characteristics are created from the average pre-arcing time values for a number of constant currents. These are not guarantees of a fuse's characteristics. This current is a current that would flow in the circuit if a fuse were replaced by a link of negligible impedance (prospective current).

Prospective current	Average pre-arcing time
30 A	0.018 s
20 A	0.058 s
10A	0.33 s
7 A	0.91 s
5 A	3.9 s
4.5 A	82 s

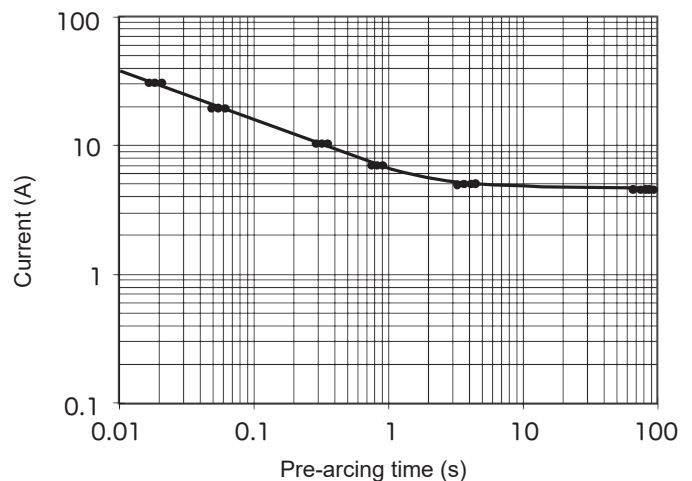

Figure 3 - Example of how to plot pre-arcing time-current characteristics

(2) Evaluation of an inrush current

Generally it is not possible to evaluate inrush currents with pre-arcing time-current characteristics, since the peak values of inrush currents change dramatically with time. However, it is possible to evaluate the occurrence of nuisance operations by comparing the circuit's Joule integral ( $I_m^2t$ , the integral of the square of the instantaneous current passed through the circuit over a certain time interval) with the pre-arcing Joule integral of the fuse ( $I_f^2t$ ) in the short-time range where heat release from fuse-element to fuse body or fuse-terminations is not large.

### Evaluation process

- i) Repeatedly measure the current waveform of the circuit from when the equipment is powered on (inrush current) to the steady-state current.
- ii) Discharge the remaining electric charge in the circuit's capacitor and measure the current waveform. If there is a component like a thermistor with a resistance that changes depending on the temperature, measure the current waveform at the minimum resistance.
- iii) Based on the measured current waveform, calculate the circuit's Joule integral ( $I_m^2 t$ ) for each time. For example, the circuit's Joule integral is calculated as follows when you have the Joule integral for 0.01 s and the sampling interval  $\Delta t$  is equal to 0.001 s. Note that the instantaneous value of the current that flows through the circuit is represented by  $i_m(t)$ . In actual practice, an even smaller sampling interval is used. A larger value was selected to explain the process. 0.01 s divided by 0.001 s is equal to 10. Therefore:

$$I_m^2 t \Big|_{t=0.01} = \int_{t=0}^{0.01} [i_m(t)]^2 dt \approx \sum_{k=1}^{10} \{ [i_m(\Delta t \cdot k)]^2 \times \Delta t \}$$

- iv) Calculate the Joule integral for each time and plot the values on a graph as in Figure 4.
- v) As in Figure 5, plot the graph with the circuit's maximum Joule integral and the fuse's pre-arcing Joule integral as functions of the time. In order to prevent nuisance operation, the relationship of maximum circuit Joule integral  $\leq$  fuse pre-arcing Joule integral is always necessary, and in order to prevent nuisance operations caused by aging, it is necessary to select fuses with sufficient margin (for example, the shaded region in Figure 5). As the necessary margin differs depending on the usage conditions, it is necessary to perform evaluations in the actual equipment the fuse will be used in.

### (3) Evaluation of an abnormal current

Measure the maximum possible abnormal current and select a fuse with a rated breaking current that can interrupt that abnormal current. Additionally, the minimum possible abnormal current should also be measured. In the comparatively short-time region, the fuse's Joule integral shall be less than or equal to the Joule integral of the circuit when the minimum abnormal current flows through it. In the comparatively long-time region, the fuse's minimum pre-arcing current shall be less than or equal to the abnormal current. The judgement whether or not these two relationships are fulfilled, depending upon the protection conditions at what point and over what time the abnormal current is required to be interrupted, can be difficult in most cases. Therefore it is both necessary and important to confirm whether the fuse can safely interrupt the abnormal current in the actual application.

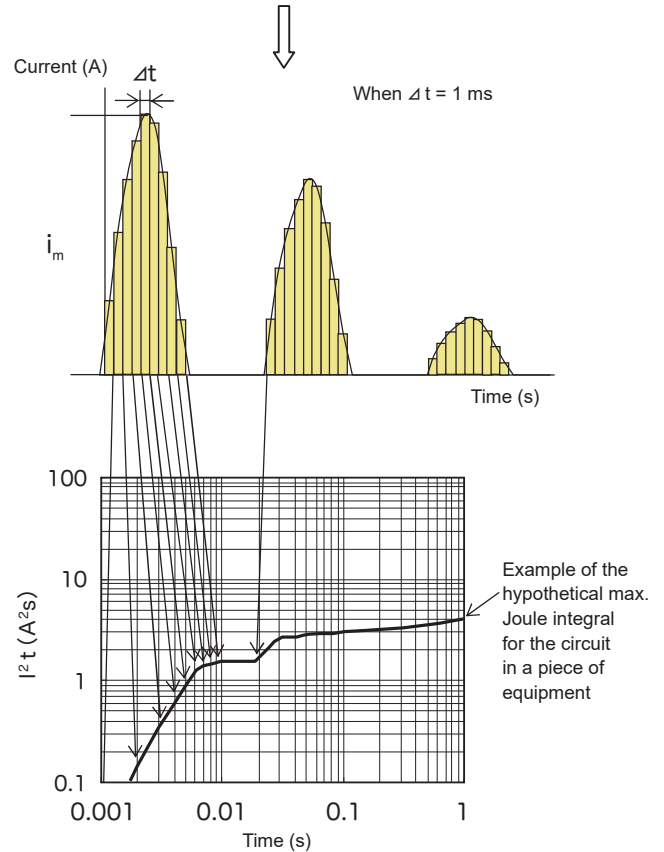
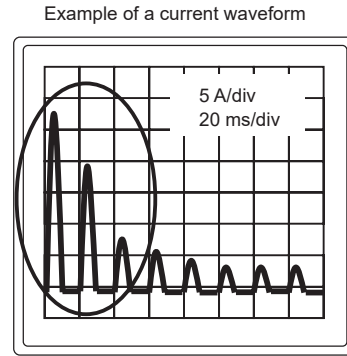

Figure 4

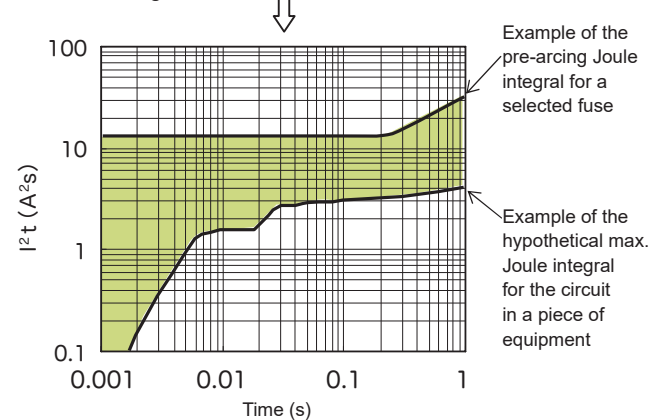

Figure 5 - Fuse selection example for an inrush current

Before final fuse selection, always test the proposed fuse in your actual equipment to ensure that the fuse satisfies all your operational and safety requirements. Please contact your local SOC sales representative for help in selecting fuses.

■ Explanation of rated current

The requirements stipulated by each standard differ even among fuses with the same rated current, and each standard specifies pre-arcing (operating) times for multiples of the rated current ( $I_N$ ). In other words, pre-arcing time-current characteristics differ depending on the standard even when the rated current is the same.

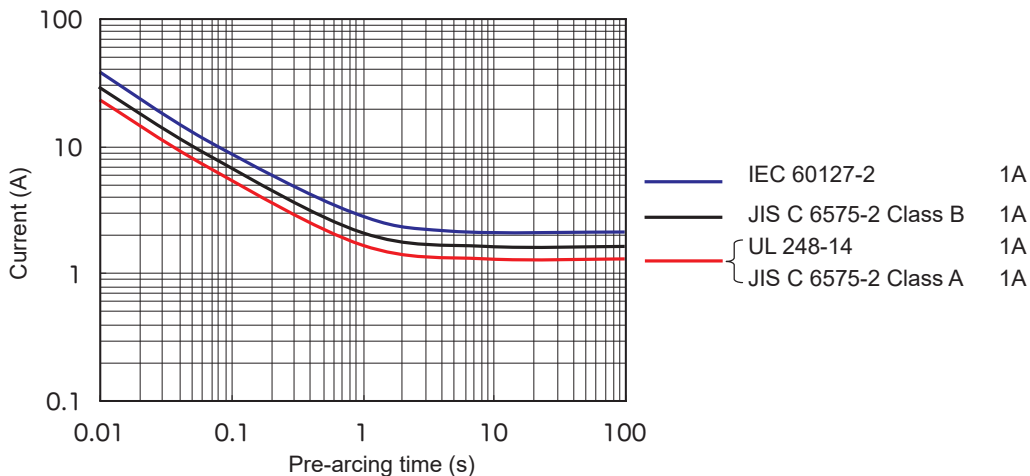

Figure 6 - Examples of pre-arcing time-current characteristics for the same rated current based on different standards

On July 1, 2013, the Ministry of Economy, Trade and Industry (hereinafter called "METI") Order establishing technical requirements for electrical appliances and materials was completely revised (with implementation from January 1, 2014) in order to change detailed specification requirements to safety performance requirements. The third table appended to the order prior to the revision (hereinafter called the "prior technical requirements") is, at the current moment, approved to be used as one of the criteria for safety performance requirements for fuses according to the interpretation of the Ministerial Order. Specifications stipulated in the prior technical requirements for miniature fuses have been partially modified and incorporated into the JIS C 6575 (Miniature fuses) series step by step, taking into consideration consistency with the IEC 60127 series.

Within the JIS C 6575 series, specifications in the standard sheets containing the letter "J" are based on the prior technical requirements, while those with only Arabic numerals are based on the IEC standard. Revision of JIS standards can take a long time, and new versions may be delayed in some cases.

Tables 2-1, 2-2, and 2-3 show examples of minimum fusing currents and pre-arcing/operating times stipulated by different standards.

Table 2-1: UL 248-14 (CSA C22.2 No. 248.14) Supplemental fuses with rated currents

	Operating time <sup>*3</sup> & current	Current carrying capacity
Microfuse <sup>*4</sup>	Within 1 min at 2 $I_N$	$I_N$ until temperature stabilization
All other fuses	Within 60 min at 1.35 $I_N$	

<sup>\*3</sup> An operating time is the sum of a pre-arcing time and an arcing time. In the low-current region, pre-arcing times are much longer than arcing times, making operating times and pre-arcing times roughly equivalent in this region.

<sup>\*4</sup> Each of the main dimensions (total length, width, height, and diameter) must be less than or equal to 10 mm, not including lead or in terminals.

Table 2-2: JIS C 6575-2 (Cartridge fuses) Standard sheet J1

Class	Pre-arcing time & current	Current carrying capacity
A	Within 60 min at 1.35 $I_N$	1.1 $I_N$ for at least 60 min
B	Within 60 min at 1.6 $I_N$	1.3 $I_N$ for at least 60 min
Special	Within the manufacturer's indicated time at the indicated current	$I_N$ for at least 60 min



Table 2-3: IEC 60127 series

Standard and standard sheet number	Pre-arcing time & current	Current carrying capacity at endurance test end
IEC 60127-2 <sup>*5</sup> SS 1, 2, 5, 7, 9, 10	Within 30 min at 2.1 $I_N$	1.5 $I_N$ for 60 min for $I_N$ of 6.3 A or less 1.5 $I_N$ for 30 min for $I_N$ greater than 6.3 A
SS 3, 6	Within 2 min at 2.1 $I_N$	
SS 8	Within 2 min at 2.1 $I_N$ (however, for $I_N$ greater than or equal to 8 A, the pre-arcing time shall be within 10 min)	
SS 4	Within 20 s at 2 $I_N$	1.15 $I_N$ for 60 min
IEC 60127-3 <sup>*6</sup> SS 1, 2	Within 5 s at 2 $I_N$	$I_N$ value for 4 h
SS 3	Within 30 min at 2.1 $I_N$	1.5 $I_N$ for 60 min
SS 4	Within 2 min at 2.1 $I_N$ (however, for $I_N$ greater than 6.3 A, the pre-arcing time shall be within 5 min)	
IEC 60127-4 <sup>*7</sup> SS 1, 2	Within 2 min at 2 $I_N$	1.25 $I_N$ for 60 min
IEC 60127-7 <sup>*8</sup> SS 1	Within the manufacturer's indicated time, but not more than 60 min at 2 $I_N$ or 2.1 $I_N$	The manufacturer's indicated current for 60 min

- \*5 Cartridge fuse-links (fuses are referred to as "fuse-links" in the IEC standard)
- \*6 Sub-miniature fuse-links, with no principal dimension (length, width, height, and diameter) exceeding 10 mm
- \*7 Universal modular fuse-links
- \*8 Miniature fuse-links for special applications

■ Time-current characteristics

As per Figure 7, it is possible to design fuses having the same rated current, but with differing pre-arcing time-current characteristics. Please consult with SOC sales representatives when it is necessary to prevent nuisance operation due to an inrush current, or when an abnormal current should be interrupted more quickly.

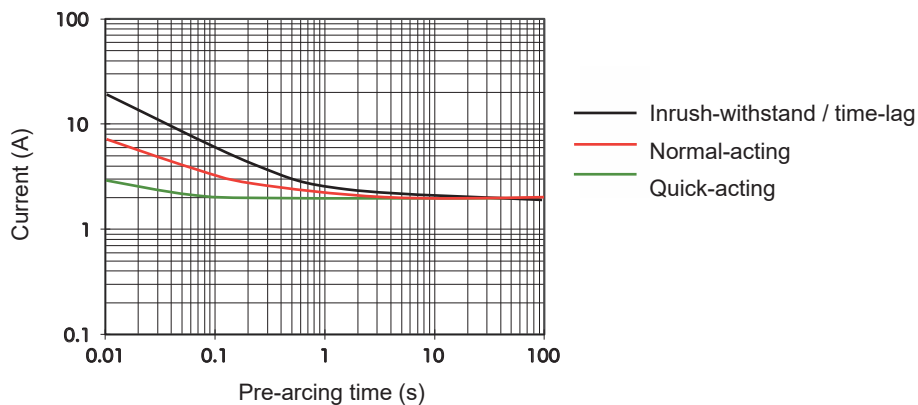

Figure 7 - Imaginal figure to explain differences in pre-arcing-time current characteristics for the same rated current

■ Rated breaking current

The rated breaking current is the upper limit value of prospective current that a fuse is capable of safely breaking under test conditions defined in a standard. Generally, breaking capacity tests are conducted using a circuit with a voltage 1–1.05 times the rated voltage of the fuse. As shown in Table 4-1 and 4-2, values of the rated breaking current differ depending on the standard. The lower limit value of current which a fuse can safely break is referred to as the minimum breaking current. For fuses with a minimum breaking current that is greater than the minimum fusing current, care should be taken as it cannot protect against overload currents between the minimum fusing current and minimum breaking current.

Table 4-1: UL 248-14 (CSA C22.2 No. 248.14) Supplemental fuses

	Rated breaking current	Power factor (lagging)
Microfuses	50 A or more	0.95–1
All other fuses	As a rule, the rated breaking current shall be 10,000 A for rated voltages greater than or equal to AC 125 V; however, a fuse rated AC 250 V may have a dual rating and this rating shall be 10,000 A at AC 125 V and the following at AC 250 V	0.7–0.8
	$I_N \leq 1 \text{ A}$ 35 A	
	$1.1 \text{ A} \leq I_N \leq 3.5 \text{ A}$ 100 A	
	$3.6 \text{ A} \leq I_N \leq 10 \text{ A}$ 200 A	
	$10.1 \text{ A} \leq I_N \leq 15 \text{ A}$ 750 A	
	$15.1 \text{ A} \leq I_N \leq 30 \text{ A}$ 1,500 A	
	50,000 A or 100,000 A	0.2 or less
	Equal to or less than 10,000 A is permitted for ratings less than AC 125 V	0.85–1

Table 4-2: Breaking capacities stipulated in the JIS and IEC standards (excluding fuses for special applications according to IEC 60127-7<sup>\*9</sup>)

Standard number	Standard sheet number	Rated breaking current	Power factor (lagging)
JIS C 6575-2	SS J1	Low-breaking capacity	100A
		Intermediate-breaking capacity	300 A or 500 A
		High-breaking capacity	1,500 A or 2,500 A
JIS C 6575-3	SS J1, J2	Low-breaking capacity	100 A
		Intermediate-breaking capacity	300 A or 500 A
JIS C 6575-4	SS J1, J2	Low-breaking capacity	100 A
		Intermediate-breaking capacity	300 A or 500 A
		High-breaking capacity	1,000 A or 1,500 A
IEC 60127-2	SS 1, 5, 9, 10	High-breaking capacity	1,500 A
	SS 2, 3, 4	Low-breaking capacity	35 A or 10 $I_N$ , whichever is greater
	SS 6	Enhanced breaking capacity	150 A
	SS 7, 8	Low-breaking capacity	200 A
IEC 60127-3	SS 1, 2	Low-breaking capacity	50 A
	SS 3, 4		35 A or 10 $I_N$ , whichever is greater
IEC 60127-4	SS 1, 2 (Rated voltage 250 V)	High-breaking capacity	1,500 A
		Intermediate-breaking capacity	500 A
		Low-breaking capacity	100 A
	SS 1, 2 (Rate voltage 125 V)	Low-breaking capacity	50 A or 10 $I_N$ , whichever is greater
SS 1, 2 (Rated voltage 63 V or less)	Low-breaking capacity	35 A or 10 $I_N$ , whichever is greater	

\*9 For the rated breaking current, manufacturers can specify any value equal to or less than 50,000 A but equal to or greater than 10 times the rated current.

■ What is the fuse's ambient temperature?

A fuse will operate when the temperature of the fuse-element exceeds the melting point of the metal it is comprised of, due to Joule heating caused by overcurrents. The temperature of the fuse-element is strongly influenced by heat dissipation. As can be imagined from Figure 8, heat dissipation differs according to the heat conductivity of the surrounding components, including fuse clips, fuseholders, wiring, and the circuit board, as well as the ambient temperature conditions. The pre-arcing time-current characteristics, for example, vary depending on ambient temperature conditions as in Figure 9. Therefore it is essential for final equipment testing to be conducted with the end application subjected to actual mechanical, electrical, and ambient conditions in order to assure achievement of satisfactory results and desired reliability. The effect of ambient temperature on pre-arcing time-current characteristics can be confirmed by temperature re-rating as shown in Figure 10. Please contact your SOC sales representative for temperature re-rating information.

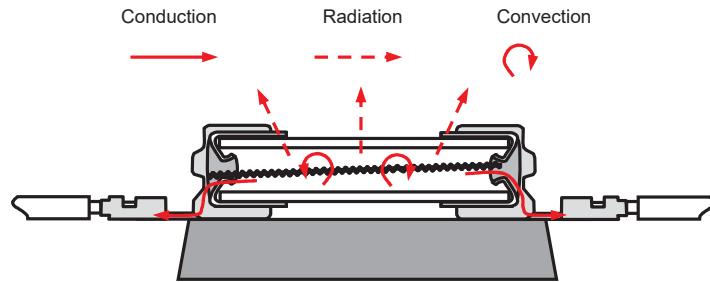

Figure 8 - Image showing heat transfer for a glass cartridge fuse

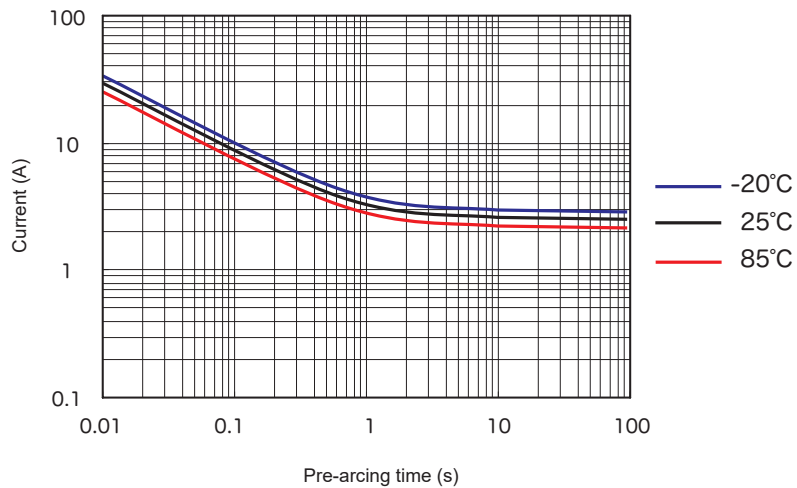

Figure 9 - Example of the effects of a changing ambient temperature on pre-arcing time-current characteristics

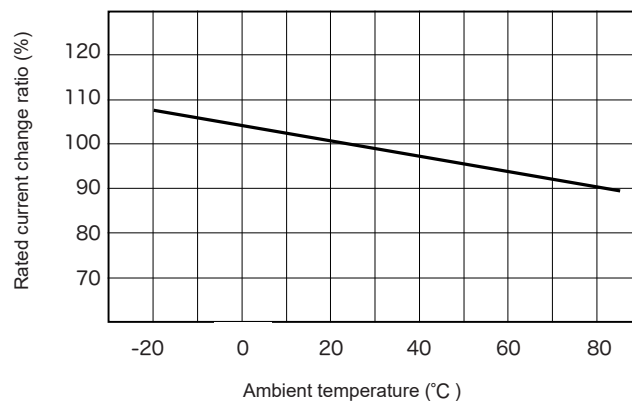

Figure 10 - Example of re-rating of rated current by ambient temperature

# Certifications

Certification is the process by which an independent third-party, through a product and factory inspection, verifies whether an industrial product's functionality or quality satisfies certain standards. For fuses, products which have obtained certification have the certification mark displayed on the actual product or the packaging.

We have concluded separate contracts with four certification organizations: UL (Underwriters Laboratories Inc.), CSA (Canadian Standards Association), SEMKO (Intertek Semko AB), and BSI (British Standards Institution), and we have received permission to use their certification marks for certain fuses.

Fuses which display a certification mark in accordance with these contracts are called "certified fuses." Generally, certification bodies inspect and run tests on the fuse and verify whether it meets certain conditions. In order to ensure future compliance, factory inspections and sample tests are conducted.

The PSE mark differs from certification marks. This mark shall be displayed on fuses, which are regulated by the Electrical Appliance and Material Safety Act as electrical products. Below is an explanation of the mark displayed on the product and packaging.

## PSE Mark

The PSE Mark is based on the Electrical Appliance and Material Safety Law (EAMSL) of Japan. As per the EAMSL, parts of electrical facilities for general use, or machines, appliances, or materials for use in connection thereto, stipulated by the Order for Enforcement of the EAMSL, are regulated as electrical appliances and materials.



In regard to fuses, those rated AC 100 V to 300 V and 1 A to 200 A are categorized as electrical appliances and materials according to this order. As a Notifying Supplier for enclosed fuses, SOC notifies the METI of the type classifications, specified in the Regulation for Enforcement of the EAMSL, for enclosed fuses that we manufacture in accordance with the EAMSL.

The fuses SOC manufactures which are rated AC 100 V to 300 V and with rated currents equal to or greater than 1 A (hereinafter called "the relevant fuses") are categorized as specific electrical appliances and materials per the above order. Unless the relevant fuses satisfy the requirements provided in the EAMSL, they cannot, as a general rule, be sold in Japan.

One of these requirements is that the relevant fuses must be marked as stipulated in the Enforcement Regulations.

In order to bear the markings, the relevant fuses are required to be in compliance with the technical requirements stipulated in the METI Order establishing technical requirements for electrical appliances and materials. Sample fuses that fall within each type classification as the relevant fuses must be tested by a test house registered with the METI in order to receive at least one valid conformity certificate for each type classification.

SOC applies to the Japan Electrical Safety & Environment Technology Laboratories (JET) for conformity certificates (which are valid for seven years from the date of issue) such that at least one certificate is valid for each type classification of the relevant fuses that SOC sells to the Japanese market.

In principle, packing labels for the relevant fuses for the Japanese market are marked with the PSE Mark  and **JET**, the abbreviated name of the Japan Electrical Safety & Environment Technology Laboratories, as well as our trademark "SOC" and the fuse's electrical ratings. The position of **JET** is beneath or on the right side of . The relevant fuses themselves are also marked with "SOC," and if there is sufficient space, with .



Example of PSE Mark

Fuses which have been manufactured entirely for export to countries outside of Japan, however, are not marked with  **JET**, nor are their packaging.

## Certification Marks for North America

The following is an explanation of the markings shown on products, and/or packaging, which have received either UL (Underwriters Laboratories Inc.) or CSA (Canadian Standards Association) product certification services.

### ■ UL Listing Mark

This is a mark based on the UL Listing and Follow-Up Services. UL tests product samples (fuses) to check conformity with the applicable UL standards. After a set of reports are issued by UL, authorization to use the UL Listing Mark is provided based on the conditions listed in the reports.

In order to ensure that all future fuses continue to be in conformance to the requirements described in the reports, UL conducts quarterly on-site inspections and sampling tests as part of their Follow-Up Services.

The standard with which SOC fuses must conform is UL 248-14: Supplemental Fuses. This standard is Part 14 of UL 248 Low-Voltage Fuses, which consists of 20 parts. The UL 248 standards are coordinated among the United States, Canada, and Mexico. The requirements of the UL and CSA standards are the same for Part 14 as listed below:

ANSI / UL 248-14 = CAN / CSA C22.2 No.248.14

In 1992, the Standards Council of Canada (SCC) granted UL Canadian Certification Organization and Testing Organization status providing services for Canada. This enabled UL to begin conducting tests and issuing certifications for Canada.

SOC began requesting certifications for both Canada and the USA when we apply for Listing Services for a new product. As the requirements of both the UL and CSA standards are the same, use of the C-UL US Listing Mark is accepted in the issued reports without the need for additional testing, with a description stating that, in addition to UL 248-14, the requirements of CSA C22.2 No. 248.14 have also been evaluated.

When space permits, the UL Listing Mark is marked on our applicable fuses. For cartridge fuses, the mark is die-stamped on the side of one of the end-caps. Along with either the UL Listing Mark or the C-UL Listing Mark, "Listed," "360C" (the control number assigned to SOC), and the product identity ("SUPPLEMENTAL FUSE," "MISCELLANEOUS FUSE," "MINIATURE FUSE," or "MICRO-FUSE") are also printed on the packaging.

### ■ UL Recognized Component Mark

This mark is based on the UL Component Recognition and Follow-Up Services. In the same way as the UL Listing and Follow-Up Service, UL tests product samples (either fuses or fuseholders) in order to issue a set of reports and authorize the use of the UL Recognized Component Mark under the conditions specified in the reports. Additionally, in order to confirm that the fuses produced afterward continue to be in conformance with the requirements described in the reports, UL conducts quarterly on-site inspections and sampling tests as part of their Follow-Up Services.



UL Listing Mark



C-UL US  
Listing Mark  
UL Listing Mark  
for Canada and  
the United States



UL Recognized  
Component Mark

Although the Listing Service requires that the fuses conform to the UL standard, the Component Recognition Service does not necessarily require this as it is possible to change a portion of the UL standard requirements. For example, although 5 x 20 mm cartridge fuses based on IEC 60127-2 do not meet the time-current characteristics of the UL standards, SOC can apply for the Component Recognition Service for these fuses according to the characteristics and breaking capacities stipulated by the IEC standard. Applications for this service can also be made for fuses having only the DC rating. SOC applies for these services for some of our fuseholders as well.



C-UL US Recognized  
Component Mark  
( Recognized Component  
Mark for Canada  
and the United States )

Recognized Components which have undergone the Component Recognition and Follow-Up Services are components that are used in equipment. UL evaluates whether the fuse or fuseholder is appropriate for use in the end-equipment, and if it is a fuse, whether the fuse can appropriately protect the equipment.

As with the Listing and Follow-Up Services, when certification for both the USA and Canada is applied for under the Component Recognition and Follow-Up Services, use of the C-UL US Recognized Component Mark is permitted.

In most cases, we mark the Recognized Component Mark or the C-UL US Recognized Component Mark on the packaging instead of on the product itself.

■ CSA Mark

This mark is based on the CSA Certification Service, which is essentially the same as the UL Listing and Follow-Up Services. Use of this mark is authorized under the conditions stated in the reports issued under this service. On-site inspections and sampling tests are conducted during factory audits.



CSA Mark

When space permits, this mark is placed on our fuses. For cartridge fuses, the mark is die-stamped on the side of one of the end-caps. This mark is also printed on our packaging.

■ CSA Component Acceptance Mark

This mark is based on the CSA Component Acceptance Service, which is fundamentally the same as the UL Component Recognition and Follow-Up Services. For the CSA Component Acceptance Mark, a triangle is added to the CSA Mark. On-site inspections and sampling tests are conducted during factory audits for this mark as well.



CSA Component  
Acceptance Mark

SOC prints the CSA Component Acceptance Mark on the packaging instead of on the product itself.

## Certification Marks for Europe

### ■ S Mark

This mark is based on the certification service provided by Intertek Semko AB (SEMKO).

SEMKO tests product samples in accordance with the requirements of the applicable EN standards, and issues certificates and permits use of the S Mark for products which can be confirmed as meeting the requirements.

When SEMKO considers that a product conforms to the minimum safety requirements, usage of the S Mark is permitted for the product tested under the conditions modified from EN standards after the issuance of a certificate.

Unlike UL or CSA, the same S Mark is permitted to be used for products which satisfy the minimum safety requirements regardless of conformity to the EN standard.

The S Mark is indicated on the packaging for our fuses which have received this certification. For marking on the fuse itself, however, use of the S mark without "Intertek" is accepted due to the limited space on the fuse.



S Mark without "Intertek"

### ■ Kitemark

This mark is based on the Kitemark certificate issued by the British Standards Institution (BSI). BSI issues the Kitemark certificate in those cases where product samples are confirmed by testing to meet the relevant British Standards (BS EN 60127-2), and additionally where the quality system for its production conforms to BS EN ISO 9001. BSI grants the right to use the Kitemark based on the Kitemark certificate. At least once a year on-site inspections and sampling tests are conducted for continued use of the mark. One of end-caps of the certified fuses is marked with the Kitemark.



Kitemark

## Quality System

SOC has obtained certification of our quality management system for designing and manufacturing fuses.





Location	Certification agency	Certification
Tochigi Factory	DNV <sup>*1</sup>	Standard ISO 9001: 2015
	DNV <sup>*2</sup>	Standard IATF 16949: 2016 (only for vehicles)
Akita Factory	BSI <sup>*3</sup>	Standard ISO 9001: 2015

<sup>\*1</sup> DNV Business Assurance UK Limited

<sup>\*2</sup> DNV Business Assurance USA Inc.





<sup>\*3</sup> British Standards Institution

# Search by certification







					Shape	Dimensions (mm)	Rated voltage	Characteristic	Type name	Rated current	Page	
●	●	●	●	●	Cartridge type	φ 5.2 × L20	AC 250 V	Time-lag	ET	50 mA–6.3 A	58	
●	●	●	●	●					HT N5	1 A–10 A	62	
●	●	●	●	●	Cartridge type with leads	HTR N5			1 A–10 A	63		
●	●	●	●	●		Surface mount type		w <sub>3.6</sub> × H <sub>3.6</sub> × L <sub>17</sub>	Inrush-withstand	36CT	1 A–6.3 A	34
●	●	●	●	●	φ 6.35 × L30			TLC N4		8 A–25 A	106	
●	●	●	●	●	Cartridge type	φ 5.2 × L20		Time-lag	ET6	1 A–6.3 A	59	
●	●	●	●	●		φ 6.35 × L30			Inrush-withstand	TLCR N4	8 A–25 A	107
●	●	●	●	●	Cartridge type with leads	φ 5.2 × L20		Time-lag		ET6R	1 A–6.3 A	60
●	●	●	●	●		Pin terminal type			w <sub>4</sub> × H <sub>7.7</sub> × L <sub>8.4</sub>	Inrush-withstand	SMC N4	4 A
●	●	●	●	●	Surface mount type			w <sub>2.57</sub> × H <sub>2.57</sub> × L <sub>6.1</sub>	AC 125 V		Quick-acting	25CF
●	●	●	●	●		Cartridge type	φ 10.3 × L38.1	AC 250 V		Inrush-withstand	KST2 N1	6.3 A–30 A
●	●	●	●	●	SKM10 N1				1 A–25 A		90	
●	●	●	●	●	Normal-acting			SS2 N1	50 mA–5 A	94		
●	●	●	●	●				SS6 N1	Over 5 A–8 A	97		
●	●	●	●	●	φ 6.35 × L31.8		AC 250 V	Inrush-withstand	CES14 N1	100 mA–10 A	67	
●	●	●	●	●					ST4 N1	100 mA–8 A	99	
●	●	●	●	●			AC 125 V	Normal-acting	SS6 N1	Over 8 A–15 A	97	
●	●	●	●	●					Inrush-withstand	CES6 N1	100 mA–15 A	65
●	●	●	●	●	φ 5.2 × L20		AC 250 V	Inrush-withstand		ST6 N1	100 mA–15 A	103
●	●	●	●	●					AC 125 V	Normal-acting	MQ4 N1	62 mA–3 A
●	●	●	●	●	Inrush-withstand		MT4 N1	100 mA–3.5 A			80	
●	●	●	●	●			φ 5.2 × L20	AC 250 V	Inrush-withstand	MT4 N1D	100 mA–3.5 A	83
●	●	●	●	●	AC 125 V					Normal-acting	MQ2 N1	62 mA–10 A
●	●	●	●	●			Inrush-withstand	ULTSC N1	100 mA–10 A		108	
●	●	●	●	●	Cartridge type with leads			φ 6.35 × L31.8	AC 250 V	Normal-acting	SS1 N1	50 mA–5 A
●	●	●	●	●			SS5 N1				Over 5 A–8 A	96
●	●	●	●	●			Inrush-withstand		CES15 N1	100 mA–25 A	69	
●	●	●	●	●					ST3 N1	100 mA–8 A	98	
●	●	●	●	●			AC 125 V	Normal-acting	SS5 N1	Over 8 A–15 A	96	
●	●	●	●	●					Inrush-withstand	CES7 N1	100 mA–15 A	66
●	●	●	●	●		φ 6.35 × L20	AC 250 V	Inrush-withstand		ST5 N1	100 mA–15 A	101
●	●	●	●	●					250VTMCR N1	1 A–20 A	64	
●	●	●	●	●	φ 5.2 × L20	AC 250 V	Normal-acting	MQ3 N1	62 mA–3 A	73		
●	●	●	●	●				Inrush-withstand	MT3 N1	100 mA–3.5 A	75	
●	●	●	●	●		AC 125 V	Normal-acting		MT3 N1D	100 mA–3.5 A	78	
●	●	●	●	●				MQ1 N1	62 mA–10 A	71		
●	●	●	●	●	Bolted connection type	φ 10 × L32	AC 250 V	-	ULTSCR N1	100 mA–10 A	109	
●	●	●	●	●					Cartridge type	φ 6.35 × L31.8	AC 400 V	Inrush-withstand
●	●	●	●	●	DC 400 V	φ 5.2 × L20	Inrush-withstand	SHV14				
●	●	●	●	●				AC 250 V		φ 5.2 × L20	Quick-acting	SHV12
●	●	●	●	●	Inrush-withstand	HQ N7	400 mA–6.3 A					61
●	●	●	●	●		φ 6.35 × L31.8	AC 250 V	Quick-acting		EQ	80 mA–6.3 A	57
●	●	●	●	●	φ 5.2 × L20					AC 250 V	Inrush-withstand	CES14 N2
●	●	●	●	●		MT4 N2	Over 3.5 A–15 A	81				

\* Fuses with rated currents of less than 1 A are not considered electrical products per the Electrical Appliance and Material Safety Law.







					Shape	Dimensions (mm)	Rated voltage	Characteristic	Type name	Rated current	Page	
●	●				Cartridge type	φ 5.2 × L20	AC 250 V	Inrush-withstand	MT4 N2D	Over 3.5 A–15 A	84	
●	●			Cartridge type with leads	MT3 N2				Over 3.5 A–15 A	76		
●	●				MT3 N2D				Over 3.5 A–15 A	79		
●			●		Sub-miniature type with leads	W2.57 × H2.57 × L9	AC 125 V	Quick-acting	25RF	200 mA–5 A	28	
	●	●			Surface mount type	W3.6 × H3.6 × L17	AC 250 V DC 300 V	Inrush-withstand	36CT	1 A–6.3 A	34	
	●	●				W3.6 × H3.6 × L11	DC 600 V DC 425 V	Quick-acting	36CFA	63 mA–3.15 A 4 A	35	
	●	●				W2.57 × H2.57 × L6.1	DC 300 V			DC300V25CF		63 mA–2 A
	●	●					AC 250 V DC 150 V			25CF	63 mA–4 A Over 4 A–15 A 63 mA–5 A	24
	●	●					AC 125 V DC 150 V					
	●	●				DC 86 V						
	●	●				W1.6 × H1.05 × L3.2	AC 250 V DC 125 V	Inrush-withstand	25CT	100 mA–3.15 A Over 3.15 A–5 A 100 mA–5 A	25	
	●	●					AC 125 V DC 125 V					
	●	●					DC 86 V					
	●	●				W1.5 × H1.2 × L2.4	DC 86 V		DC86V11CT	100 mA–8 A	20	
	●	●					DC 72 V	Quick-acting	11CF	100 mA–10 A	19	
	●	●								DC 72 V	Inrush-withstand	11CFB
	●	●					11CT	100 mA–10 A	19			
	●	●							11CTB	100 mA–10 A	18	
	●	●				Sub-miniature type with leads	W2.57 × H2.57 × L9	AC 250 V DC 125 V	Quick-acting	MCF3	28 mA–250 mA 260 mA–1 A 1.1 A–2.5 A	31
	●	●			AC 25 V DC 32 V							
	●	●			AC 12.5 V DC 25 V							
	●	●			Cartridge type	φ 6.35 × L31.8	AC 250 V DC 125 V	Inrush-withstand	25RF	100 mA–10 A	28	
	●	●					AC 125 V DC 125 V					
	●	●			Cartridge type	φ 10.3 × L38.1	AC 250 V	Inrush-withstand	KST2	1 A–30 A	70	
	●	●					DC 500 V		SKM10	100 mA–30 A	90	
	●	●					AC 500 V		SHV22	1 A–10 A	42	
	●	●					AC 400 V DC 400 V		SHV4	1 A–10 A	37	
	●	●					AC 380 V		SHV14	1 A–20 A	40	
	●	●						SHV4	Over 10 A–20 A	37		
	●	●					AC 250 V	Normal-acting	SS2	50 mA–5 A	94	
	●	●							SS6	Over 5 A–8 A	95	
	●	●						Inrush-withstand	CES14	100 mA–10 A	67	
	●	●							ST4	100 mA–30 A	99	
	●	●			AC 125 V	Normal-acting	SS6	Over 8 A–15 A	95			





\* Fuses with rated currents of less than 1 A are not considered electrical products per the Electrical Appliance and Material Safety Law.

	 or 	 or 			Shape	Dimensions (mm)	Rated voltage	Characteristic	Type name	Rated current	Page
●	●	●			Cartridge type	φ 6.35 × L31.8	AC 125 V	Inrush-withstand	CES6	100 mA–15 A	65
●	●	●					AC 125 V		ST6	100 mA–30 A	102
●	●	●					DC 125 V		ST6 N1	100 mA–15 A	103
●	●	●					DC 700 V	Inrush-withstand	SHV16	1 A–4 A	41
●	●	●				φ 6.35 × L25.4	AC 250 V	Normal-acting	SL4	80 mA–2 A	91
●	●	●					AC 125 V		SL2	80 mA–6 A	91
●	●	●					DC 500 V	Inrush-withstand	SHV18	1 A–30 A	41
●	●	●				φ 5.2 × L20	AC 500 V DC 400 V	Inrush-withstand	SHV12	100 mA–6.3 A	39
●	●	●					AC 380 V		SHV2	1 A–6.3 A	37
●	●	●					AC 250 V	Normal-acting	MQ4	62 mA–3 A	74
●	●	●						Inrush-withstand	MT4	100 mA–3.5 A	80
●	●	●					AC 125 V	Normal-acting	MT4 D	100 mA–3.5 A	82
●	●	●							MQ2	62 mA–10 A	72
●	●	●					DC 450 V	Inrush-withstand	ULTSC	100 mA–10 A	108
●	●	●							SHV20	500 mA–6.3 A	42
●	●	●				φ 4.6 × L14	AC 125 V	Normal-acting	SQ8	80 mA–3 A	92
●	●	●					Inrush-withstand	MT8	100 mA–3 A	85	
●	●	●				Cartridge type- with leads	φ 10.3 × L38.1	AC 250 V	Inrush-withstand	SKM7	100 mA–30 A
●	●	●			AC 500 V			SHV33		10 A–30 A	43
●	●	●			φ 6.35 × L31.8		AC 250 V	Normal-acting	SS1	50 mA–5 A	93
●	●	●						SS5	Over 5 A–8 A	95	
●	●	●					Inrush-withstand	CES15	100 mA–30 A	68	
●	●	●						ST3	100 mA–30 A	98	
●	●	●						SS5	Over 8 A–15 A	95	
●	●	●			AC 125 V		Inrush-withstand	CES7	100 mA–15 A	66	
●	●	●						ST5	100 mA–30 A Over 8 A–30 A	100	
●	●	●			AC 125 V DC 125 V		ST5 N1	Over 8 A–15 A	101		
●	●	●			φ 6.35 × L30		DC 125 V	Inrush-withstand	DC125VTLKR	800 mA–35 A	64
●	●	●					φ 6.35 × L25.4		DC 450 V	SHV27	6.3 A 8 A–30 A
●	●	●			DC 420 V				SHV11	100 mA–6.3 A	38
●	●	●			φ 5.2 × L20		AC 400 V DC 400 V		SHV1	1 A–6.3 A	36
●	●	●					AC 380 V	Normal-acting	MQ3	62 mA–3 A	73
●	●	●					AC 250 V	Inrush-withstand	MT3	100 mA–3.5 A	75
●	●	●			MT3 D				100 mA–3.5 A	77	
●	●	●			φ 4.6 × L14		AC 125 V	Normal-acting	MQ1	62 mA–10 A	71
●	●	●				Inrush-withstand		ULTSCR	100 mA–10 A	109	
●	●	●				Normal-acting		SQ7	80 mA–3 A	92	
●	●	●					Inrush-withstand	MT7	100 mA–3 A	85	

\* Fuses with rated currents of less than 1 A are not considered electrical products per the Electrical Appliance and Material Safety Law.

					Shape	Dimensions (mm)	Rated voltage	Characteristic	Type name	Rated current	Page
●	●	●			Cartridge type with leads	$\phi 4 \times {}^L 9$	AC 250 V	Quick-acting	NQ3	62 mA–10 A	87
●	●			Inrush-withstand				NT3	100 mA–10 A	88	
●	●			AC 125 V			Quick-acting	NQ1	62 mA–10 A	87	
●	●						Inrush-withstand	NT1	100 mA–10 A	88	
●	●			Bolted connection type	$\phi 10 \times {}^L 32$	AC 500 V	-	500VBL1030A	5 A–50 A	54	
●	●			Board mount type	$\phi 10 \times {}^L 31$	DC 500 V		500VBI1030	5 A–50 A	54	
●	●	●		Surface mount type	${}^W 1.6 \times {}^H 1.05 \times {}^L 3.2$	DC 32 V	Inrush-withstand	32V11CF	800 mA–6.3 A	21	
●					${}^W 2.57 \times {}^H 2.57 \times {}^L 6.1$	AC 125 V	Quick-acting	25CF	63 mA–6.3 A	24	
●							Inrush-withstand	25CT	100 mA–5 A	25	
●				Sub-miniature type with leads	${}^W 2.57 \times {}^H 2.57 \times {}^L 9$	AC 125 V	Quick-acting	25RF	100 mA–5 A	28	
●				Cartridge type	$\phi 10.3 \times {}^L 38.1$	AC 250 V	Normal-acting	250V Ⓐ LLC	500 mA–30 A	124	
●							Inrush-withstand	250V Ⓐ TLLC	500 mA–30 A	129	
●						AC 125 V	Normal-acting	Ⓐ LLC	500 mA–30 A	114	
●							Inrush-withstand	Ⓐ TLLC	500 mA–30 A	119	
●					$\phi 6.35 \times {}^L 31.8$	AC 300 V	Inrush-withstand	SHV4	1 A–20 A	37	
●							AC 250 V	Normal-acting	250V Ⓐ LNC	100 mA–20 A	123
●						AC 125 V		Inrush-withstand	250V Ⓐ TLNC	100 mA–20 A	128
●							Normal-acting	Ⓐ LNC	100 mA–20 A	113	
●						AC 125 V	Inrush-withstand	Ⓐ TLNC	100 mA–20 A	118	
●							AC 250 V	Normal-acting	250V Ⓐ LC	100 mA–20 A	122
●					AC 125 V	Inrush-withstand		250V Ⓐ TLC	100 mA–30 A	127	
●						AC 125 V	Normal-acting	Ⓐ LC	100 mA–20 A	112	
●					AC 125 V		Inrush-withstand	Ⓐ TLC	100 mA–30 A	117	
●						$\phi 5.2 \times {}^L 20$	AC 300 V	Inrush-withstand	SHV2	1 A–6.3 A	37
●					AC 250 V			Normal-acting	250V Ⓐ SC	100 mA–10 A	121
●							AC 125 V	Inrush-withstand	250V Ⓐ TSC	100 mA–10 A	126
●					Normal-acting			Ⓐ SC	100 mA–10 A	111	
●					AC 125 V		Inrush-withstand	Ⓐ TSC	100 mA–10 A	116	
●							AC 250 V	Normal-acting	250V Ⓐ MSC	100 mA–5 A	120
●					AC 125 V	Inrush-withstand		250V Ⓐ TMSC	100 mA–5 A	125	
●						AC 125 V	Normal-acting	Ⓐ MSC	100 mA–5 A	110	
●					AC 125 V		Inrush-withstand	Ⓐ TMSC	100 mA–5 A	115	
●						$\phi 10.3 \times {}^L 38.1$	AC 250 V	Normal-acting	250V Ⓐ LLCR	500 mA–30 A	124
●					AC 125 V			Inrush-withstand	250V Ⓐ TLLCR	500 mA–30 A	129
●							AC 125 V	Normal-acting	Ⓐ LLCR	500 mA–30 A	114
●					AC 125 V			Inrush-withstand	Ⓐ TLLCR	500 mA–30 A	119
●						$\phi 6.35 \times {}^L 31.8$	AC 250 V	Normal-acting	250V Ⓐ LNCR	100 mA–20 A	123
●					AC 125 V			Inrush-withstand	250V Ⓐ TLNCR	100 mA–20 A	128
●				AC 125 V			Normal-acting	Ⓐ LNCR	100 mA–20 A	113	
●					AC 125 V		Inrush-withstand	Ⓐ TLNCR	100 mA–20 A	118	
●				$\phi 6.35 \times {}^L 30$		AC 250 V	Normal-acting	250V Ⓐ LCR	100 mA–20 A	122	
●					AC 125 V		Inrush-withstand	250V Ⓐ TLCR	100 mA–30 A	127	
●						AC 125 V	Normal-acting	Ⓐ LCR	100 mA–20 A	112	
●					AC 125 V		Inrush-withstand	Ⓐ TLCR	100 mA–30 A	117	

\* Fuses with rated currents of less than 1 A are not considered electrical products per the Electrical Appliance and Material Safety Law.

					Shape	Dimensions (mm)	Rated voltage	Characteristic	Type name	Rated current	Page
●					Cartridge type with leads	φ 5.2 × L20	AC 300 V	Inrush-withstand	SHV1	1 A–6.3 A	36
●				AC 250 V			Normal-acting	250V Ⓐ SCR	100 mA–10 A	121	
●							Inrush-withstand	250V Ⓐ TSCR	100 mA–10 A	126	
●				AC 125 V		Normal-acting	Ⓐ SCR	100 mA–10 A	111		
●						Inrush-withstand	Ⓐ TSCR	100 mA–10 A	116		
●				φ 4.6 × L16		AC 250 V	Normal-acting	250V Ⓐ MSCR	100 mA–5 A	120	
●							Inrush-withstand	250V Ⓐ TMSCR	100 mA–5 A	125	
●						AC 125 V	Normal-acting	Ⓐ MSCR	100 mA–5 A	110	
●							Inrush-withstand	Ⓐ TMSCR	100 mA–5 A	115	
	●			Surface mount type	W2.57 × H2.57 × L6.1	DC 72 V	Quick-acting	25CF	18 A	24	
	●				W1.6 × H1.05 × L3.2	DC 35 V	Inrush-withstand	DC35V11CT	100 mA–10 A	20	
	●			Cartridge type	φ 10.3 × L38.1	AC 125 V	Inrush-withstand	SKM2	3 A–15 A	89	
	●							φ 6.35 × L31.8	AC 250 V	CES14	Over 10 A–15 A
	●				AC 125 V	CES6	Over 15 A–20 A		65		
	●				φ 6.35 × L15.9	AC 125 V	Normal-acting	SU2	100 mA–20 A	104	
	●					DC 60 V		DCSU2	Over 5 A–20 A	105	
	●				φ 5.2 × L20	AC 250 V	Inrush-withstand	MQ4	Over 3 A–15 A	74	
	●							MT4	Over 3.5 A–15 A	80	
	●					DC 125 V	MT4 D	Over 3.5 A–15 A	82		
	●						100 mA–15 A				
	●						MT4 N1D	100 mA–3.5 A	83		
	●						MT4 N2D	Over 3.5 A–15 A	84		
	●				φ 6.35 × L15.9	AC 125 V	Normal-acting	SU1	80 mA–5 A	104	
	●			MQ3				Over 3 A–15 A	73		
	●			AC 250 V		Inrush-withstand	MT3	Over 3.5 A–15 A	75		
	●						MT3 D	Over 3.5 A–15 A	77		
	●			DC 125 V		MT3 N1D	100 mA–3.5 A	78			
	●					MT3 N2D	Over 3.5 A–15 A	79			
		●		Cartridge type	φ 5.2 × L20	AC 125 V	Normal-acting	MQ2	Over 10 A–15 A	72	
		●		Cartridge type with leads				MQ1	Over 10 A–15 A	71	
			●	Surface mount type	W1.6 × H1.05 × L3.2	AC 32 V DC 32 V	Inrush-withstand	32V11CF	800 mA–6.3 A	21	
			●	Sub-miniature type with leads	W2.57 × H2.57 × L9	AC 125 V DC 125 V	Quick-acting	25RF	200 mA–5 A	28	

\* Fuses with rated currents of less than 1 A are not considered electrical products per the Electrical Appliance and Material Safety Law.

		Shape	Dimensions (mm)	Rated voltage	Characteristic	Type name	Rated current	Page	
	Surface mount type	$w_{2.57} \times h_{2.57} \times l_{6.1}$	DC 60 V	Quick-acting	P25CF	63 mA–18 A	26		
				Inrush-withstand	P25CT	100 mA–5 A	26		
			DC 35 V	Quick-acting	DC35VP25CF	63 mA–18 A	27		
				Inrush-withstand	DC35VP25CT	100 mA–5 A	27		
		$w_{1.6} \times h_{1.05} \times l_{3.2}$	DC 72 V	Quick-acting	P11CF	100 mA–10 A	22		
				Inrush-withstand	P11CT	100 mA–10 A	22		
			DC 35 V	Quick-acting	DC35VP11CF	100 mA–10 A	23		
				Inrush-withstand	DC35VP11CT	100 mA–10 A	23		
		Sub-miniature type with leads	$w_{2.57} \times h_{2.57} \times l_9$	AC 90 V DC 90 V	Quick-acting	P25RF	100 mA–10 A	29	
					AC 90 V DC 60 V	Inrush-withstand	P25RT	100 mA–6.3 A	29
				DC 35 V		Quick-acting	DC35VP25RF	100 mA–10 A	30
					Inrush-withstand	DC35VP25RT	100 mA–6.3 A	30	
	Cartridge type			$\phi_{6.35} \times l_{31.8}$	DC 500 V	Inrush-withstand	NSHV14	10 A	46
							$\phi_{5.2} \times l_{20}$	AC 42 V DC 42 V	PMT4
		DC 450 V	NSHV12	100 mA–6.3 A	45				
			Cartridge type with leads	$\phi_{10.3} \times l_{38.1}$	DC 600 V		Normal-acting	LLD6500	15 A
	$\phi_{6.35} \times l_{31.8}$	AC 500 V			Inrush-withstand	NSHV3	1 A–10 A	44	
		AC 400 V		NSHV13		5 A–25 A	44		
		DC 400 V		NSHV23A		1 A–20 A	47		
		DC 700 V		NSHV15		1 A–4 A	46		
	$\phi_{6.35} \times l_{25.4}$	DC 500 V		NSHV17		1 A–30 A	47		
	$\phi_4 \times l_9$	DC 100 V		PNT5		100 mA–10 A	86		
	Bolted connection type	$\phi_{40} \times l_{65}$		DC 800 V DC 500 V		-	PT4065	400 A–500 A	56
			$\phi_{31} \times l_{51}$	DC 450 V			DC450VPT3050	250 A–350 A	49
		DC450VBT3050			250 A–350 A		56		
		DC450VPT2545			180 A–225 A		48		
		$\phi_{26} \times l_{46}$	DC 500 V	DC500VBT2543	225 A		55		
				DC450VPT2035	100 A–150 A		48		
$\phi_{25} \times l_{42.6}$		DC 500 V	AC450VBL1030C	60 A	52				
			500VBL1030A	5 A–40 A	54				
			DC500VBL1030F	60 A	53				
			DC72VBL1030	50 A–70 A	53				
$\phi_{20} \times l_{35}$		DC 450 V	DC500VBC635C	5 A–30 A	51				
			DC500VBC625A	5 A–35 A	49				
Board mount type		$\phi_{10} \times l_{31}$	DC 500 V	-	500VBI1030		5 A–40 A	54	
			$\phi_{6.35} \times l_{24.6}$		DC 600 V		DC600VBI625C	30 A	51
	DC 550 V DC 300 V	DC550VBI625C			35 A	50			
	DC 500 V	DC500VBI625C	5 A–35 A		50				

# Search by type name

■ Fuses / Protectors		Page			Page			Page			
1	11CF	19	A	Ⓐ TLNCR	118	M	MCF3	31	S	SHV2	37
	11CFB	18		Ⓐ TMSC	115		MQ1	71		SHV20	42
	11CT	19		Ⓐ TMSCR	115		MQ1 N1	71		SHV22	42
	11CTB	18		Ⓐ TSC	116		MQ2	72		SHV27	43
2	250V Ⓐ LC	122	C	Ⓐ TSCR	116	MQ2 N1	72	SHV33	43		
	250V Ⓐ LCR	122		CES14	67	MQ3	73	SHV4	37		
	250V Ⓐ LLC	124		CES14 N1	67	MQ3 N1	73	SKM10	90		
	250V Ⓐ LLCR	124		CES14 N2	68	MQ4	74	SKM10 N1	90		
	250V Ⓐ LNC	123		CES15	68	MQ4 N1	74	SKM2	89		
	250V Ⓐ LNCR	123		CES15 N1	69	MT3	75	SKM7	89		
	250V Ⓐ LMSC	120		CES6	65	MT3 D	77	SL2	91		
	250V Ⓐ MSCR	120	CES6 N1	65	MT3 N1	75	SL4	91			
	250V Ⓐ SC	121	CES7	66	MT3 N1D	78	SMC N4	35			
	250V Ⓐ SCR	121	CES7 N1	66	MT3 N2	76	SQ7	92			
	250V Ⓐ TLC	127	D	DC125VTLKR	64	MT3 N2D	79	SQ8	92		
	250V Ⓐ TLCR	127		DC300V25CF	25	MT4	80	SS1	93		
	250V Ⓐ TLLC	129		DC35V11CT	20	MT4 D	82	SS1 N1	93		
	250V Ⓐ TLLCR	129		DC35VP11CF	23	MT4 N1	80	SS2	94		
	250V Ⓐ TLNC	128		DC35VP11CT	23	MT4 N1D	83	SS2 N1	94		
	250V Ⓐ TLNCR	128		DC35VP25CF	27	MT4 N2	81	SS5	95		
	250V Ⓐ TMSC	125		DC35VP25CT	27	MT4 N2D	84	SS5 N1	96		
	250V Ⓐ TMSCR	125		DC35VP25RF	30	MT7	85	SS6	95		
	250V Ⓐ TSC	126		DC35VP25RT	30	MT8	85	SS6 N1	97		
	250V Ⓐ TSCR	126		DC450VBT3050	56	N	NQ1	87	ST3	98	
	250V TMCN1	64	DC450VPT2035	48	NQ3		87	ST3 N1	98		
	25CF	24	DC450VPT2545	48	NSHV12		45	ST4	99		
	25CT	25	DC450VPT3050	49	NSHV13		44	ST4 N1	99		
	25RF	28	DC500VBC625A	49	NSHV14		46	ST5	100		
	25RT	28	DC500VBC635C	51	NSHV15		46	ST5 N1	101		
3	32V11CF	21	DC500VBI625C	50	NSHV17		47	ST6	102		
	36CFA	35	DC500VBL1030F	53	NSHV23A		47	ST6 N1	103		
	36CT	34	DC500VBT2543	55	NSHV3		44	SU1	104		
	5	500VBI1030	54	DC550VBI625C	50		NT1	88	SU2	104	
500VBL1030A		54	DC600VBI625C	51	NT3	88	T	TLC N4	106		
A		AC250VBL1030C	52	DC72VBL1030	53	P		P11CF	22	TLCR N4	107
		AC450VBL1030C	52	DC86V11CT	20		P11CT	22	U	ULTSC	108
	Ⓐ LC	112	DCSU2	105	P25CF		26	ULTSC N1		108	
	Ⓐ LCR	112	E	EQ	57		P25CT	26		ULTSCR	109
Ⓐ LLC	114	ET		58	P25RF		29	ULTSCR N1		109	
Ⓐ LLCR	114	ET6		59	P25RT		29	■ Fuseholders / Fuse clips	BM-LQ-I-13	130	
Ⓐ LNC	113	ET6R		60	PMT4		86		BM-LQ-I-15	130	
Ⓐ LNCR	113	H	HQ N7	61	PNT5		86		BM-SS-I-14	130	
Ⓐ MSC	110		HT N5	62	PT4065		56		H-0014-2	131	
Ⓐ MSCR	110		HTR N5	63	S		SHV1		36	H-0016-2	131
Ⓐ SC	111		K	KST2		70	SHV11		38	H-0017-2	132
Ⓐ SCR	111	KST2 N1		70		SHV12	39		H-0032-2	131	
Ⓐ TLC	117	L		LLD6500		105	SHV14		40	H-0048-2	132
Ⓐ TLCR	117					SHV16	41		H-0084-2	132	
Ⓐ TLLC	119				SHV18	41					
Ⓐ TLLCR	119										
Ⓐ TLNC	118										

## Safety Precautions

### **WARNING**

Failure to properly select, install, and use fuses may result not only in property damage due to fire and other disasters, but also bodily harm, serious injury, and/or death. This catalog contains as references only a portion of the data available for the products listed. Before selecting a fuse, confirm the latest product specifications and parameters with one of SOC's local sales representatives.

- Use fuses within their specified limits. Use outside of specified conditions can cause nuisance operations and disconnection of the fuse-element, among other things, and may lead to the occurrence of accidents. Please note that breaking conditions for currents below the minimum breaking current and which exceed the rated breaking current are outside the range of the specification conditions. Please use this product after ensuring that the actual breaking conditions in the application are not included in this range.
- Product specification will depend on the product type. Please confirm this with your sales representative.
- Before final fuse selection, always test the proposed fuse in your actual equipment to ensure the fuse satisfies all operational and safety requirements.
- Be aware the breaking ability of a fuse will differ depending on whether the circuit is an AC or DC circuit. Fuses intended for use in AC circuits should not be employed in DC circuits, and vice versa, as this may result in accidents such as explosions, property damage, and/or serious injury. (Refer to p. 139 of this catalog.)
- In regard to environmental conditions, represented by the following, use outside of specifications may cause changes to a fuse's electrical characteristics, nuisance operations, and disconnection of the fuse-element, among other things. Please confirm specifications with your SOC sales representative.
  - \* Ambient temperature and/or temperature changes
  - \* High-temperature and/or high-humidity
  - \* Vibrations and/or impacts
  - \* Condensation
- Do not use fuses where they may be exposed to corrosive and/or flammable gasses. Doing so may result in nuisance operations, disconnection of the fuse-element, and/or explosions.
- Do not use ultrasonic cleaning on fuses as this can result in disconnection of the fuse-element, which may lead to an accident.
- Coating or potting a fuse may change its electrical characteristics. Please consult your SOC sales representative before applying treatment as this may result in an accident.
- Never force a fuse into a fuseholder/fuse clip. Contact failure caused by damage to the fuse or deformation of the fuseholder's clips due to impact or forcing the fuse into the holder may significantly alter the fuse's electrical characteristics and lifetime, and may lead to accidents including nuisance operations.
- Turn off all power leading to a fuse before touching it. Failure to do so may result in electrocution or serious burns.
- Products in this catalog are intended for use in standard electronic equipment. Please consult your SOC sales representative before using fuses in life-critical equipment, equipment which requires a high degree of quality and reliability, and any other similar equipment.
- Use sample fuses only for evaluation. Do not reuse sample or other previously used fuses. Properly dispose of fuses in accordance with local laws and regulations.

### **IMPORTANT NOTICES**

- Operating, electrical, and/or mechanical characteristic limits for products covered in this catalog, as well as product availability, are subject to change without prior notice.
- The content of this catalog was considered to be reliable at the time of its preparation (March 2024); however, the accuracy of information herein cannot be guaranteed. Check with your local SOC sales representative before finalizing fuse selection.
- Questions related to product applications, specifications, or performance characteristics may be directed to SOC sales representatives.

## SOC Corporation

Headquarters	3-16-17 Takanawa, Minato-ku, Tokyo 108-0074, Japan TEL +81-3-5420-1011 FAX +81-3-5420-6699
SOC America Inc.	414 S Service Rd #519, Patchogue, NY 11772 USA TEL +1-631-472-6666
SOC Asia Pte. Ltd.	15 Jalan Kilang Barat, #07-02 Frontech Centre, Singapore 159357 TEL +65-6376-4115
SOC Europe B.V.	Databankweg 1, 3821 AL Amersfoort, the Netherlands TEL +31-33-450-4000