

# table of contents



Cole Hersee Co has been manufacturing reliable electrical products since 1924.

This Master Catalog describes our complete line, but we can adapt many of these products to order by changing terminals, knobs, by adding seals or by PVC-coating (to name but a few variants). Contact us to discuss the possibilities. Our engineers are on hand to design from the ground up the best switching solution to your application.

Cole Hersee is trusted world wide for reliable switches.

## Availability of products:

- ★ Rapid Ship: Items that are likely to be in stock at Cole Hersee 95% of the time, on average.
- \* Minimum order quantities may apply to these items. Consult Cole Hersee.

Copyright © Cole Hersee Company

Section Page

## A ROCKER SWITCHES

|                                |           |           |
|--------------------------------|-----------|-----------|
| Weather-resistant switches     | A1        | 3         |
| Standard series, plastic bezel | A2        | 7         |
| Standard series, metal bezel   | A3        | 8         |
| Narrow body switches           | A4        | 10        |
| Bracket-mounting switches      | A5        | 10        |
| Dual switches                  | A6        | 11        |
| Accessories                    | A7        | 12        |
| <b>Wiring diagrams</b>         | <b>A8</b> | <b>13</b> |

## B TOGGLE SWITCHES

|   |            |           |
|---|------------|-----------|
| Weather-resistant switches              | B1         | 17        |
| 1" paddle handle switches               | B2         | 19        |
| Freightliner replacement switches       | B3         | 20        |
| Lighted tip switches                    | B4         | 20        |
| Heavy-duty switches                     | B5         | 21        |
| Medium-duty On-Off switches             | B6         | 24        |
| Heavy-duty and extra HD switches        | B7         | 24        |
| Specialized switches                    | B8         | 26        |
| Accessories                             | B9         | 28        |
| <b>Information (poles &amp; throws)</b> | <b>B10</b> | <b>30</b> |

## C IGNITION SWITCHES

|                      |    |    |
|----------------------|----|----|
| 956 series switches  | C1 | 31 |
| Universal switches   | C2 | 34 |
| Marine switches      | C3 | 36 |
| Specialized switches | C4 | 38 |
| Accessories          | C5 | 43 |
| Information          | C6 | 44 |

## D ROTARY SWITCHES & HEADLAMP SWITCHES

|  |    |    |
|--|----|----|
| Universal switches                     | D1 | 45 |
| Universal reversing switches           | D2 | 48 |
| Rotary headlamp & light switches       | D3 | 49 |
| Rotary temperature & rheostat switches | D4 | 50 |
| Push-pull headlamp switches            | D5 | 51 |
| Electronic dimmer switches             | D6 | 53 |
| Foot-operated switches                 | D7 | 54 |

## E WINDSHIELD WIPER SWITCHES

|                             |    |    |
|-----------------------------|----|----|
| Electronic switches         | E1 | 57 |
| Electric two-speed switches | E2 | 58 |

# displays & literature



T

|                        |    |
|------------------------|----|
| CLAMSHELL PACKAGING    | T1 |
| MERCHANDISING DISPLAYS | T2 |
| DISPLAY CARDS          | T3 |
| MERCHANDISING AIDS     | T4 |
| DEMONSTRATION KITS     | T5 |
| LITERATURE             | T6 |

## displays & literature

### T1 CLAMSHELL PACKAGING

#### Clamshell Packaging

Many of our popular product items are packaged in see-through clamshells. Items that are available in clamshell are denoted throughout this catalog with a symbol, and in the price list with the suffix 'BP'. If you want clamshell items, be sure to order using the BP suffix.

Planogramming of clamshells is easy because most items fit in one of three clamshell pegboard profiles. Clamshell packaging is crush resistant and recloseable, and protects the contents during shipping. Product description and information is trilingual (English, Spanish and French.)

For more information on how the clamshell can maximize planogram space, download sheet D-597 from our website.



All BP items are packed 6 per inner-pack, 6 inner-packs per case pack, 36 items per case pack.

MERCHANDISING T2

### Merchandising Displays

Plastic countertop spinner display is available free when you order three sets of products (one of which is assembled on the display), or you can order one set of products (ready assembled on the display) and be billed the cost of the display cost. Be sure to order the appropriate display number. Each spinner unit displays 34 SKUs. Size: 12 1/2" H, spins within a 12" diameter (311 x 305mm).



SD-38-6 Display

#### With Master Disconnect Switch 75908

SD-38-5 with one set of merchandise. Cost of display will be invoiced. SD-38-6 free display with an order for 3 sets of merchandise. For details of the merchandise and display, request sheet D-580 or view it on the Cole Hersee website.

#### With Master Disconnect Switch M-284-01

SD-38-3 with one set of merchandise. Cost of display will be invoiced. SD-38-4 free display with an order for 3 sets of merchandise. For details of the merchandise and display, request sheet D-569 or view it on the Cole Hersee website.

#### With Master Disconnect Switch 2484-16

SD-38-1 with one set of merchandise. Cost of display will be invoiced. SD-38-2 free display with an order for 3 sets of merchandise. For details of the merchandise and display, request sheet D-568 or view it on the Cole Hersee website.

| SKU Number | SD-38-2 <sup>▲</sup> | SD-38-4 <sup>▲</sup> | SD-38-6 <sup>▲</sup> | SKU Description                |
|------------|----------------------|----------------------|----------------------|--------------------------------|
| 2484-16    | 1-2                  | -                    | -                    | Master disconnect switch       |
| 30055-10   | 1-2                  | 1-2                  | 1-2                  | Circuit breaker                |
| 30409-10   | 1-2                  | 1-2                  | 1-2                  | Circuit breaker                |
| 30409-30   | 1-2                  | 1-2                  | 1-2                  | Circuit breaker                |
| 30410-10   | 1-2                  | 1-2                  | 1-2                  | Fuse clip                      |
| 30410-15   | 1-2                  | 1-2                  | 1-2                  | Fuse clip                      |
| 46210-02   | 1-2                  | 1-2                  | 1-2                  | Jumper terminal                |
| 46377-6    | 1-2                  | 1-2                  | 1-2                  | Fuse block                     |
| 5011       | 1-2                  | -                    | 1-2                  | Push-pull switch               |
| 54107-01   | 1-2                  | 1-2                  | 1-2                  | Toggle switch                  |
| 54109      | 1-2                  | 1-2                  | 1-2                  | Toggle switch                  |
| 55017-02   | 1-2                  | 1-2                  | 1-2                  | Toggle switch                  |
| 55020      | 1-2                  | 1-2                  | 1-2                  | Toggle switch                  |
| 55021      | 1-2                  | 1-2                  | 1-2                  | Toggle switch                  |
| 55057      | 1-2                  | -                    | 1-2                  | Toggle switch                  |
| 551840     | 1-2                  | 1-2                  | 1-2                  | Toggle switch                  |
| 5582       | 1-2                  | -                    | 1-2                  | Toggle switch                  |
| 5582-10    | 1-2                  | 1-2                  | 1-2                  | Toggle switch                  |
| 5586       | 1-2                  | 1-2                  | 1-2                  | Toggle switch                  |
| 5590       | 1-2                  | 1-2                  | 1-2                  | Toggle switch                  |
| 55057      | 1-2                  | 1-2                  | -                    | Toggle switch                  |
| 58328-13   | 1-2                  | 1-2                  | 1-2                  | Rocker switch                  |
| 58328-22   | 1-2                  | 1-2                  | 1-2                  | Rocker switch                  |
| 58328-35   | 1-2                  | 1-2                  | 1-2                  | Rocker switch                  |
| 59024-200  | 1-2                  | 1-2                  | 1-2                  | Toggle switch                  |
| 75908      | -                    | -                    | 1-2                  | Master disconnect switch       |
| 81264      | 1-2                  | 1-2                  | 1-2                  | Boot for toggle switch         |
| 82065      | 1-2                  | 1-2                  | -                    | Face plate - disconnect switch |
| 82065-02   | -                    | -                    | 1-2                  | Face plate - disconnect switch |
| 82159-1    | 2-4                  | 2-4                  | 2-4                  | Rocker switch mounting         |
| 82159-2    | 1-2                  | 1-2                  | 1-2                  | Rocker switch mounting         |
| 90030      | 1-2                  | -                    | 1-2                  | Pushbutton switch              |
| M-284-01   | -                    | 1-2                  | -                    | Master disconnect switch       |
| M-320-RC   | -                    | 1-2                  | -                    | Pilot Light                    |
| M-426      | 1-2                  | 1-2                  | 1-2                  | Terminal block                 |
| M-482      | -                    | 1-2                  | -                    | Push-pull switch               |
| M-484      | -                    | 1-2                  | -                    | Toggle switch                  |
| M-54111-01 | 1-2                  | 1-2                  | 1-2                  | Toggle switch                  |
| M-606      | 1-2                  | 1-2                  | 1-2                  | Push-pull switch               |
| M-626-02   | -                    | 1-2                  | -                    | Pushbutton switch              |
| M-674      | 1-2                  | 1-2                  | 1-2                  | Fuse block                     |
| PL-19-RC   | 1-2                  | -                    | 1-2                  | Pilot light                    |

<sup>▲</sup> 1-2 indicates that for each SKU that one item is mounted on the display, with 2 items stock. Similarly, 2-4 indicates 2 items of the SKU are mounted on the display, with a stock of 4 items provided.

#### BX-2 Shelf Box

Corrugated board box is ideal for bulk, boxed or BP items – helps locate Cole Hersee products on the shelf. 6" wide x 12" deep x 4 1/2" high. Low front panel is 2 1/2" high. Ships flat.

**T3** DISPLAY CARDS

## Display Cards

*These single-SKU displays are ready to merchandise. Each display consists of items of one SKU, individually poly-bagged and affixed to a backer card. Card display measures 10 1/2"W x 13 1/2"H (267 x 343mm) and has holes from which the display can be hung or fixed on two peghooks.*



SD-5582

| Display Order No. | Product Description                     | Product Item No. |
|-------------------|---|------------------|
| SD-19-RC          | 12 Red pilot lights                     | PL-19-RC         |
| SD-320-RC         | 12 Red pilot lights                     | M-320-RC         |
| SD-426            | 12 Fuse blocks                          | M-426            |
| SD-550            | 6 Ignition starter switches             | M-550            |
| SD-626            | 9 Momentary push-button switches        | M-626            |
| SD-3031-0         | 18 In-line fuse holders without fuse    | 3031-0           |
| SD-3031-20        | 18 In-line fuse holders with 20A fuse   | 3031-20          |
| SD-4112-RC        | 9 Dual alarms                           | 4112-RC          |
| SD-5007           | 12 Push-pull switches                   | 5007             |
| SD-5582           | 18 Toggle switches                      | 5582             |
| SD-9095           | 12 Pushbutton momentary switches        | 9095             |
| SD-9579           | 9 Ignition starter switches             | 9579             |
| SD-11134          | 12 4-Pole in-line connectors            | 11134            |
| SD-30410-20       | 18 Snap-in circuit breakers, 20A        | 30410-20         |
| SD-46210-02       | 6 Positive jumper terminals             | 46210-02         |
| SD-46210-03       | 6 Negative jumper terminals             | 46210-03         |
| SD-46210-23       | 3 Positive, 3 negative jumper terminals | 46210-02 & -03   |
| SD-46211-01       | 6 Battery feeder studs                  | 46211-01         |
| SD-54100          | 15 Toggle switches                      | 54100            |
| SD-55055-01       | 12 Toggle switches                      | 55055-01         |
| SD-56000-08       | 12 Rocker switches                      | 56000-08         |
| SD-90030          | 12 Momentary pushbutton switches        | 90030            |
| SD-551840         | 12 Toggle switches                      | 551840           |

# displays & literature

**T4** MERCHANDISING AIDS

## Merchandising Aids

*These signs are available free of charge.*

### F-1245 Metal Sign

Lightweight aluminum sign is supplied with foam tape for adhesion to any smooth flat surface, or it can be tacked to a wall. Size: 24" X 15" (610 x 381mm).



### F-1244 Large Card Sign

Two-sided card sign can be hung, or attached to a pegboard display of Cole Hersee products. Size: 19" x 7" (483 x 178mm).

### F-1243 Small Card Sign

Two-sided card sign can be hung, or attached to a pegboard display of Cole Hersee products. Size: 10 1/2" x 5" (267 x 127mm).



### F-1240 Decal

With adhesive on the back: suitable for counters, walls, windows, and vehicles.



### F-1241 With adhesive on the front

Same as F-1240, but with adhesive on the front: suitable for windows, and glass doors.

DEMONSTRATION KITS **T5**

### Demonstration Kits

Demonstration kits contain an assortment of rotary switches or relays, and are very helpful at the counter, to assist a customer in making a purchase. Plastic compartment box measures 8" x 6" x 1 7/8" (203 x 158 x 46mm).

#### SD-39 Rotary Switch Demo Kit\*

For more details, request sheet D-599 or view it on the Cole Hersee website.



#### SD-40 Relays Demo Kit\*

Contains a selection of 40A and 70A relays. For more details, request sheet D-608 or view it on the Cole Hersee website.



# displays & literature

### Literature

#### D-275 Master Catalog

Contains the broadest range of our products. Also available in downloadable PDF format on our website.



#### D-357 Heavy Duty Catalog

Contains products suitable for heavy duty and off-road vehicles.

#### 39-6 Marine Catalog

Contains products suitable for marine applications.

#### 'Hot Feed' Spec Sheets

A range of sheets that give details on specific products or groups of products. For a complete listing see our website: Resource Center > Our Literature – where they are available in downloadable PDF format.



★ Rapid ship item. BP Available in retail clamshell pack. ★ Minimum order quantity may apply.



# knobs & nuts



S

|                    |    |
|--------------------|----|
| STANDARD KNOBS     | S1 |
| FACENUTS & HEXNUTS | S2 |

## knobs & nuts

### S1 STANDARD KNOBS

#### Plated Brass Knobs

*Chrome-plated solid brass, no imprint*

##### 8113-10

Face diameter 7/8" (22.2mm),  
10-32 thread.



##### 8197-10

Face diameter 3/4" (19.0mm),  
10-32 thread.



##### 8106\* with set screw

Face diameter 7/8" (22.2mm).  
8-32 thread tapped set screw hole.  
Accepts shaft 3/16"  
(4.8mm) diameter.



##### 81355\*

Face diameter 1/2" (12.7mm),  
10-32 thread.

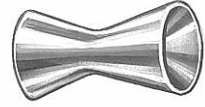

#### Plastic Knobs

##### Knurled disk design

*Available with or without imprint.*

*Cole Hersee stocks many knobs of this type with a wide variety of standard SAE imprints – contact Cole Hersee. Black plastic with textured matte finish. 1 3/16" (30.2mm) face diameter.*



##### 81270-508\* 10-32, no imprint

10-32 thread.

##### 81270-608\* 3/16", no imprint

Accepts 3/16" (4.9mm) diameter shaft.

##### 81298-03 headlamp symbol

10-32 thread. Imprinted with upper beam headlamp symbol.

##### 81298-04\* headlamp symbol

Accepts 3/16" (4.9mm) diameter shaft. Imprinted with upper beam headlamp symbol.

##### 81298-01\* wiper symbol

10-32 thread. Imprinted with windshield wiper symbol.

CONTINUED **S1**

*\*Minimum order quantity may apply. Please consult factory or current price list.*

**81298-02 wiper symbol**

Accepts 3/16" (4.9mm) diameter shaft. Imprinted with windshield wiper symbol.

**81298-34 wiper-washer symbol**

Accepts 1/4" (6.4mm) diameter shaft. Imprinted with windshield wiper symbol.

**81298-13\* 10-32 temperature**

10-32 thread. Imprinted 'Temperature, Hot'

**81298-14\* 3/16 temperature**

Accepts 3/16" (4.9mm) diameter shaft. Imprinted 'Temperature, Hot'

**Bar design**

*Knobs are without imprint unless specified.*

**Metal insert with set screw**

Face diameter 7/8" (22.2mm).  
8-32 thread tapped set screw hole.

**8155-01 black, 3/16" shaft**

Accepts 3/16" (4.9mm) diameter shaft.

**8157-01\* black**

10-32 thread.

**8157-12\* black, imprinted 'Lights'**

10-32 thread.

**8157-02\* ivory**

10-32 thread.

**8166-01\* black, 1/4" shaft**

Accepts 1/4" (6.4mm) diameter shaft

**8166-02\* ivory, 1/4" shaft**

Accepts 1/4" (6.4mm) diameter shaft

**Metal insert without set screw**

Face diameter 7/8" (22.2mm),  
shaft size 10-32 thread.

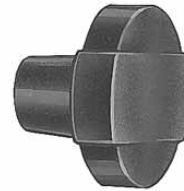
**8163-01 black****8163-02 ivory****8163-03 tan****8163-12 black, imprinted 'Lights'****Other designs**

*Black. 1" (25.0mm) face diameter. 8-32 thread tapped set screw hole.*



1" round design

**8138-03\* no imprint**

10-32 thread.

**8138-06\* imprinted 'Lights'**

10-32 thread.

**81363 imprinted 'Wiper'**

Imprinted 'Wiper' and with a right to left arrow.  
Accepts 3/16" (4.8mm) diameter shaft.

*Black. 1 3/16" (30.2mm) face diameter, 10-32 thread.*



Flared design

**81260 no imprint**

*Black. 1 1/4" (31.8mm) long, 1/4" (6.4mm) diameter shaft.  
With set screw. White line on the pointer.*



Pointer design

**8145 with metal insert**

No imprint.

*\*Minimum order quantity may apply. Please consult factory or current price list.*

## Facenuts

*Chrome-plated brass, nickel-plated brass or aluminum.*  
More facenuts – Section C5.

### Brass

#### 83274 for protection of button



Deep design protects the switch button against accidental operation. Round knurl 29/32" (23.0mm) diameter, 9/16" (14.3mm) thickness. 5/8"-32 thread. Chrome-plated brass.

#### 8340 to fit 3/16" shaft



5/8" (15.9mm) hex, 1/4" (6.4mm) thickness. 3/8"-24 thread to fit 3/16" (4.8mm) shaft. Chrome-plated brass.

#### 8343 to fit 1/4" shaft

5/8" (15.9mm) hex, 1/4" (6.4mm) thickness. 7/16"-28 thread to fit 1/4" (6.4mm) shaft. Chrome-plated brass.

#### 83337 to fit 5/8" shaft



7/8" (22.2mm) hex, 15/64" (6.0mm) thickness. 13/16"-24 thread to fit 5/8" (15.9mm) shaft. Chrome-plated brass.

#### 8304



Round knurl 3/4" (19.0mm) diameter, 1/4" (6.4mm) thickness. 5/8"-32 thread. Chrome-plated brass.

#### 83307 For toggle switches



Nickel-plated brass. Round knurl 9/16" (14.3mm) diameter, 1/16" (1.6mm) thickness. 15/32"-32 thread.

## Aluminum

#### 8361 7/8" diameter for use with rubber caps



Round knurl 7/8" (22.2mm) diameter, 17/64" (6.8mm) thickness. 5/8"-32 thread to fit 1/2" (12.7mm) shaft.

Use with snap-on rubber caps 407-01 and 407-03. See Section G6.

#### 83348 15/16" diameter



Round knurl 15/16" (8.0mm) diameter, 3/8" (9.5mm) thickness. 3/4"-24 thread to fit 5/8" (15.9mm) shaft.

#### 8367 1" diameter



Round knurl 1" (25.0mm) diameter, 19/64" (7.5mm) thickness. 3/4"-20 thread to fit 5/8" (15.9mm) shaft.

#### 83296 1 3/16" diameter



Round knurl 1 3/16" (30.2mm) diameter, 13/32" (10.3mm) thickness. 1"-24 thread to fit 5/8" (15.9mm) shaft.



See Section C5.

CONTINUED **S2**

\*Minimum order quantity may apply. Please consult factory or current price list.



**Hexnuts***Brass or plated steel***For mounting of switches****Brass****8346 3/8-32**

1/2" (12.7mm) hex, 3/32" (2.4mm) thick.

**8338 5/8-32**

7/8" (22.2mm) hex, 1/8" (3.2mm) thick.

**8349 11/16-32**

7/8" (22.2mm) hex, 1/8" (3.2mm) thick.

**Plated Steel****8316\* 5/16-24**

7/16" (11.1mm) hex, 3/32" (2.4mm) thick.

**8310 3/8-24**

9/16" (14.3mm) hex, 3/32" (2.4mm) thick.

**8311 3/8-32**

1/2" (12.7mm) hex, 3/32" (2.4mm) thick.

**8322 7/16-20**

5/8" (15.9mm) hex, 1/8" (3.2mm) thick.

**8334 7/16-28**

5/8" (15.9mm) hex, 1/8" (3.2mm) thick.

**83272 15/32-32 for toggle switches**

9/16" (14.3mm) hex, 3/16" (4.8mm) thick.

**8325 1/2-20**

5/8" (15.9mm) hex, 1/8" (3.2mm) thick.

**8328 5/8-32**

3/4" (19.0mm) hex, 3/32" (2.4mm) thick.

**8307 5/8-32**

7/8" (22.2mm) hex, 1/8" (3.2mm) thick.

**DL-21-7 11/16-32**

7/8" (22.2mm) hex, 1/8" (3.2mm) thick.

**85753 3/4-32**

7/8" (22.2mm) hex, 1/8" (3.2mm) thick.

**85754 7/8-27**

1" (25.0mm) hex, 1/8" (3.2mm) thick.

**84002 3/4-20 Pal nut**

1 1/16" (27.0mm) hex, 13/64" (5.2mm) thick.

**For threaded terminals***Brass or plated steel***84012 5/16-24 brass**

1/2" (12.7mm) hex, 3/16" (4.8mm) thick.

**84000 3/8-16 brass**

9/16" (14.3mm) hex, 21/64" (8.3mm) thick.

**84013 3/8-24 brass**

9/16" (14.3mm) hex, 7/32" (5.6mm) thick.

**8249 10-32 steel**

3/8" (9.5mm) hex, 1/8" (3.2mm) thick.

**84005 5/16-24 steel**

1/2" (12.7mm) hex, 3/16" (4.8mm) thick.

**interactive catalog**

Check the Cole Hersee website at HYPERLINK  
<http://www.colehersee.com> **www.colehersee.com**  
 You can do an interactive search for the exact item  
 you need by going to 'Product Catalog'. And there's  
 an abundance of other product information, such as  
 technical drawings and specs.

\*Minimum order quantity may apply. Please consult factory or current price list.



# special purpose switches



R

|   |    |
|---|----|
| MECHANICAL NEUTRAL SAFETY SWITCHES          | R1 |
| NEUTRAL SAFETY & BACK-UP LAMP SWITCHES      | R2 |
| BACK-UP SWITCHES                            | R3 |
| OVERDRIVE KICKDOWN SWITCHES                 | R4 |
| EXTRA HEAVY-DUTY WEATHER-RESISTANT SWITCHES | R5 |
| VOLTAGE REDUCERS                            | R6 |
| FOOT-OPERATED TURN SWITCHES                 | R7 |

## special purpose switches

### R1 MECHANICAL NEUTRAL SAFETY SWITCHES

Heavy-duty switches for applications to 36V DC.

#### Normally Off Ball Switches

SPST. On with ball depressed, spring return to Off. Silver contacts. 35A at 12V DC, 20A at 24V DC, except where noted. Moisture-resistant insulators, corrosion-resistant metal housings.

9242 ★



Two screw terminals. Mounting stem 9/16" -18 UNF-2A thread, 5/16" (7.9mm) long.  
Replaces: International 863187-R91.

9242-01

Same as 9242, but with brass gasket/washer.

9242-07\* self-grounding



Same as 9242 except one terminal is grounded to the switch housing and terminal insulator is sealed against moisture and dirt.  
Replaces: John Deere AT71501.

9242-04 with Delphi (Packard) connector



22" (559mm) harness includes 2-pole Delphi (Packard) connector 2984855, with two female blade terminals 6288106. Mounting stem 9/16" -18 UNF-2A thread, 5/16" (7.9mm) long. Plasticized housing provides protection against moisture and dirt. Internal gasket seal.  
Replaces: GMC 702733.

92102



15A at 12V DC. Two-button head accepts standard female blade terminals, and will mate with Delphi (Packard) 2-pole connector 2962679, or equivalent. Mounting stem 9/16" -18 UNF-2A thread, 21/32" (16.7mm) long.

92102-03\*

Same as 92102, but with aluminum gasket/washer.

CONTINUED **R1**

92107-04



20A at 12V DC. Two-screw terminals. Mounting stem 3/4" -16 UNF-2A thread, 31/64" (12.3mm) long.

9162



35A at 12V DC. Two female bullet terminals. Mounting stem 3/4" -16 UNF-2A thread, 31/64" (12.3mm) long. Replaces: Chrysler 1527835, Clark 73631.

9162-03

Same as 9162, except with gasket on the mounting stem. Replaces: Massey 181140M94.

## Normally On Ball Switches

*SPST. Off with ball depressed. Spring return to On. Silver contacts. 5A at 12V DC, 3A at 24V DC, except where noted. Moisture-resistant insulators, corrosion-resistant metal housings.*

9224 ★



Two screw terminals. Mounting stem 3/4" -16 UNF-2A thread, 31/64" (12.3mm) long, with aluminum gasket/washer. Replaces: Clark 224620

9224-07



Two screw terminals. Mounting stem 9/16" -18 UNF-2A thread.

92105



Two female bullet terminals. Mounting stem 3/4" -16 UNF-2A thread, 31/64" (12.3mm) long, with aluminum gasket/washer.

## Lever-actuated Switch

8486-05

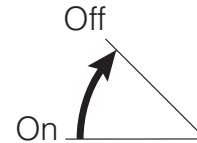

10A at 12V DC. SPST, Normally Off, contacts Open. Lever-actuated to On, spring return to Off. Two bullet terminals. Two 10-32 tapped mounting holes, 5/8" (15.9mm) on centers. 2 7/8" (73.0mm) long lever.

Replaces: John Deere AM38713

## Vacuum Neutral Safety Switches

### Normally On, SPST

*Contacts open at rising vacuum, contacts close at falling vacuum. Mounting stem: 1/8" -27 dryseal thread. Operating range: 9 - 12 inches of mercury, break (30.5 - 40.6 kPa).*

8641 Self-grounding



Replaces AMC 3157693, 3202448, International 196198-R91.

# special purpose switches

R

## R2 NEUTRAL SAFETY & BACK-UP LAMP SWITCHES

SPST, normally Off. On with plunger depressed, spring return to Off. For use with automatic transmissions.

### 91105 Back-up Lamp Switch



10A at 12V DC. Plasticized housing protects against moisture and dirt. Two 18AWG wire leads, 7" long. Button-head actuator, 3/8" (9.5mm) long. 7/16" -20 (7.9mm) diameter mounting stem with two flats for mounting in double-D holes. Replaces: AMC 3171244.

### 83377 Protective Boot



For Neutral Safety and Back-up Lamp Switches.

Molded of durable PVC to resist moisture and dirt. Internal ring forms a seal with the groove around the switch housing.

Fits Cole Hersee switches with a 1 1/8" (28.6mm) hex housing: 9134, 9162, 9224, 9242, 9242-07, 92102, 92103, 92105, 92107-04.

### 92001\* Neutral Safety and Back-up Lamp Switch



Replaces: Delco D2200, GMC 1993556, 613, 618, 619, 658, 659, 669, 1998677, Motorcraft SW-496.

# special purpose switches

## R3 BACK-UP SWITCHES

SPST, normally Off. On with plunger depressed, spring return to Off.

### 9134



35A at 12V DC. Silver contacts. Transmission-mounted, extra heavy-duty. Compact design for mounting in areas where space is limited. Two female bullet terminals. 9/16" -18 thread mounting stem, 5/16" (7.9mm) long. Replaces: Chrysler 1343998, 2198779, Motorcraft SW-410

### 9025\*

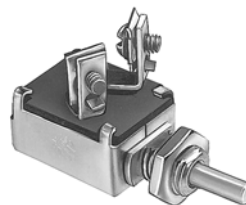

10A at 12V DC. Two screw terminals. 7/16" (7.9mm) diameter mounting stem, 7/16" -20 (7.9mm) long, with two flats for mounting in double-D hole. 1/2" (12.7mm) long plunger. Replaces: Superior School Bus B67176.

### 91113 ★



20A at 12V DC. Silver contacts. Transmission-mounted, extra heavy-duty. Compact design for mounting in areas where space is limited. Two screw terminals. 9/16" -18 thread mounting stem, 5/16" (7.9mm) long. Replaces: Autocar 8E-01360, Brockway 128537, Diamond Reo 560-65, Kenworth AT-91-69 Mack 1MR-1320, Oshkosh 13320-F1, White 1743529.

### 75125 Back-up Alarm Switch

SPST. Normally Off. Spring lever actuated to On, spring return to Off. Two screw terminals. Two 13/64" (5.2mm) diameter mounting holes, 1/2" (12.7mm) on centers. 5" (127mm) lever.

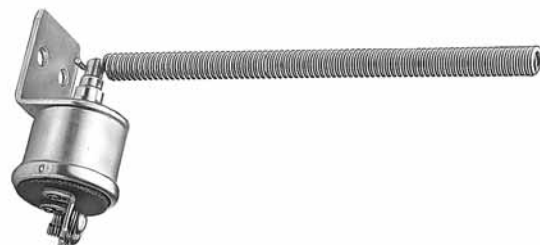

CONTINUED R4

## R3 BACK-UP SWITCHES

9052

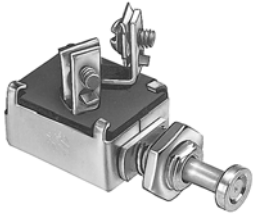

10A at 12V DC. Two screw terminals. 7/16" (7.9mm) diameter mounting stem, 7/16" -20 (7.9mm) long, with two flats for mounting in double-D hole. 1/2" (12.7mm) long button-head plunger. *Replaces: Ford B9AF, COAF, 51-A15520A, Jeep 710412, 721028, Motorcraft SW-410.*

9176\*

Same as 9052, except with blade terminals.  
*Replaces: AMC 3147682.*

9054\*

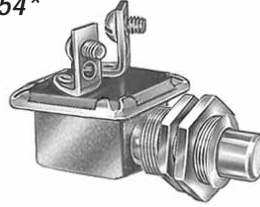

20A at 12V DC. O-ring seal in stem, and gasket under the terminal insulator. Two screw terminals. 5/8 -32 thread mounting stem, 5/8" (15.9mm) long.  
*Replaces: Ward School Bus 009 31 014-00.*

## special purpose switches

## R4 OVERDRIVE KICKDOWN SWITCHES

## SPST, normally On

*Off with plunger depressed, spring return to On.*

9096-02



15A at 12V DC. With special diaphragm/mounting bracket, sealed to protect the mounting shaft. Plasticized body protects against moisture and dirt. Two 16AWG wire leads, 3" (76.2mm) long with female bullet terminals. Insulator sleeves protect the connections. 13/64" (5.2mm) diameter mounting holes, 1 1/2" (38.1mm) on centers. 1/4" (6.4mm) long plunger.

9208\*

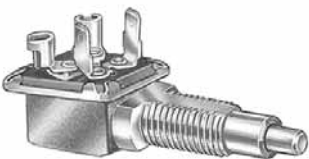

10A at 12V DC. Gasket-sealed terminal insulator. Two blade and two female terminals. 7/16" (7.9mm) diameter mounting stem, 5/8" (15.9mm) long with two flats on the stem for mounting in double-D hole.  
*Replaces: AMC 3146726.*

## SPST, On - Momentary On

9106-02\*

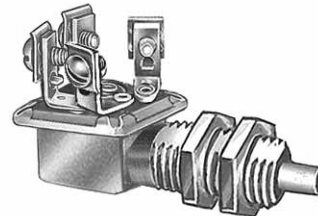

10A at 12V DC per circuit. Two circuits: No.1 normally On, No.2 On with plunger depressed, spring return to No.1. Four screw terminals. 7/16" -20 (7.9mm) diameter mounting stem, 7/8" (22.2mm) long with flat on stem for mounting in D-shaped hole. Gasket-sealed terminal insulator. Plunger: 7/32" (5.6mm) long.  
*Replaces: Chrysler 1479527, Jeep 717589.*



## pilot lights

See Section N2.

# special purpose switches

R

## R5 EXTRA HEAVY-DUTY WEATHER-RESISTANT SWITCHES

Universal application. Suitable for Back-up Lamp, Neutral Safety, Overdrive Switches.

### SPST Normally On

Off with plunger depressed, spring return to On.

91042

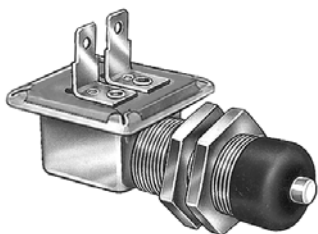

10A at 12V DC. Rubber cap/seal snaps into grooves in the plunger and mounting stem to protect the operating shaft from moisture and dirt. Two blade terminals mate with two-pole Delphi (Packard) connector 2977647 or equivalent. 5/8" -32 (15.9mm) diameter mounting stem, 11/16" (17.5mm) long. Gasket-sealed terminal insulator. 3/8" (9.5mm) long plunger, protrudes through the cap.

91042-05\*

Same as 91042, except with two screw terminals.  
Replaces: Fiat Allis 7307175501.

90043 ★



20A at 12V DC, 10A at 24V DC. Silver contacts. Rubber cap snaps into special groove and is secured to the mounting stem by a deep-threaded nut for a positive seal. Two blade terminals mate with two-pole Delphi (Packard) connector 2977647 or equivalent. 5/8" -32 thread mounting stem, .625" (15.9mm) long. Gasket-sealed case. Steel plunger protrudes through the cap.

### SPST Normally Off

On with plunger depressed, spring return to Off.

92116

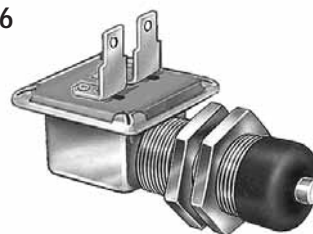

20A at 12V DC, 10A at 24V DC. Silver contacts. Rubber cap/seal snaps into grooves in the plunger and mounting stem to protect the operating shaft from moisture and dirt. Two blade terminals mate with two-pole Delphi (Packard) connector 2977647 or equivalent. 5/8" -32 (15.9mm) diameter mounting stem, 11/16" (17.5mm) long. Gasket-sealed terminal insulator. 3/8" (9.5mm) long plunger, protrudes through the cap.

### SPDT On - Momentary On

91127

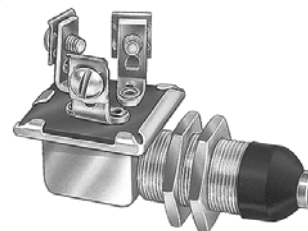

10A at 12V DC per circuit. Two circuits: No.1 normally On, No.2 On with plunger depressed, spring return to No.1. Three screw terminals. Rubber cap/seal snaps into grooves in the plunger and mounting stem to protect the operating shaft from moisture and dirt. Gasket-sealed terminal insulator. 5/8" -32 (15.9mm) diameter mounting stem.

# special purpose switches

## R6 VOLTAGE REDUCERS

Allow the use of 6V accessories in 12V electrical systems. The resistor coil is embedded into the ceramic insulator for effective heat dissipation. Voltage reducers can be wired singly in series or in parallel. For use with low amperage load accessories. Two screw terminals with lockwashers. 7/16" -28 thread mounting stem. Size: 2" x 2 9/16" x 1 1/2."

### 68068 for 6A maximum load

1.0 Ohm resistance, 35W.

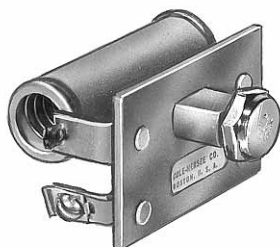

### 68003 for 4A maximum load

1.5 Ohm resistance, 25W.

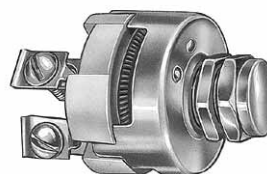

FOOT OPERATED R8

## R7 FOOT-OPERATED TURN SWITCHES

Through-floorboard mounting. Depress to On, spring return to Off. Two switches are needed for left and right turn signals. Sealed switches are plastic coated, providing protection against moisture dust and roadsplash. 7/8" (9.5mm) diameter stem. Three 1/4" -20 tapped mounting holes, 3/4" (19.0mm) and 1 3/4" (44.4mm) on centers. 12A at 12V DC.

7792-01 with screw terminals



7792 sealed, with screw terminals



7785 sealed, with wire leads



## relays

40A at 12V DC and 70A at 12V DC, Form A, Form C and Form 2A  
See Section H5



## types of thread

Information on most threads can be found in the ANSI standards, the SAE Handbook, and the National Institute of Standards and Technology Handbook H-28.

**UNC** is the most commonly used thread on general-purpose fasteners. UNC threads are deeper than UNF threads and are easier to assemble without cross threading. Manufacturing tolerances can be larger than for finer threads, allowing for higher plating tolerances. Because of their looser fit, UNC threads are usually easier to remove when corroded.

**UNF** thread has a larger minor diameter than UNC thread, which gives UNF fasteners slightly higher load-carrying and better torque-locking capabilities than UNC fasteners of the same material and OD. UNF threads have a smaller lead angle that allows for finer tension adjustment. They also have more stringent manufacturing tolerances than UNC threads.

**The most common thread systems in the US are:**

- UNC – Unified National Coarse
- UNF – Unified National Fine
- UNEF – Unified National Extra Fine
- NC – American National Coarse
- NF – American National Fine
- NEF – American National Extra Fine

# electrical connectors



Q

|                                      |    |
|--------------------------------------|----|
| TRACTOR-TRAILER CONNECTORS           | Q1 |
| 1- TO 6-POLE CONNECTORS              | Q2 |
| SOCKET & PLUG INTERIORS              | Q3 |
| AUTOMOTIVE TRAILER CONNECTORS        | Q4 |
| FARM EQUIPMENT CONNECTORS            | Q5 |
| ACCESSORIES                          | Q6 |
| INFORMATION ON ELECTRICAL CONNECTORS | Q7 |

## electrical connectors

### Q1 TRACTOR-TRAILER CONNECTORS

Heavy duty sockets, plugs and assemblies that withstand the rigors of trucking thousands of miles in dust and dirt, rain and snow, heat and cold, yet maintain the all-important electrical continuity between tractor unit and trailer. With the increased need for more circuits on the trailer comes the need for more poles in the connectors. The 13-pole connector contains added circuits, yet is able to link up with standard 7-pole trailers when necessary. Green connectors clearly indicate dedicated ABS plugs and sockets, yellow identifies a 13-pole connector. Tractor-trailer connectors are also employed in agricultural vehicles.

#### 13-pole connectors

Provides six additional tractor-trailer circuits within the dimensions of traditional 7-pole connectors. Adaptable to a wide variety of wiring combinations, including multiplexed circuits. Surpasses SAE J560b performance standards. Conforms to this standard for interchangeability between 7-pole and 13-pole connectors. Distinctive bright yellow identifies 13-pole connectors. Robust glass-filled plastic housings cannot rust or corrode. Ground terminals accept up to 8AWG wire, 7 pole terminals up to 10AWG, smaller 6 pole terminals up to 14AWG.

#### 12300 Socket ★

Gasket-sealed socket door is spring-loaded and locks onto the plug. Solid brass contact pins. Rain hood extends beyond the pins to protect the interior. The 5° downward pitch drain channel inside the socket reduces water retention. Three mounting holes on the flange: .33" (8.4mm) diameter, 2.93" (74.6mm) on centers. Includes six 31784 crimp-on connectors to mate with the six smaller pole terminals. See Section Q6



81356 Rubber Boot gives added protection to the terminals. Not included. See Section Q6.

#### 12301 Plug ★



Plug locks into the socket, utilizing the spring-loaded socket door. Spring-grip contacts have self-adjusting spring bands to maintain long-term uniform electrical contact with socket pins. O-ring at the plug end prevents water from reaching the contacts. Strain relief and grommet seal isolates the contacts from mechanical strain, and provides extra moisture protection. Cable retainer maintains secure cable connection. Replaceable interior. Includes six 31784 crimp-on connectors to mate with the six smaller pole terminals. See Section Q6.

#### Cable

See Section Q6.

#### Interiors

See Section Q3.

CONTINUED **Q1**



### 7-pole connectors

Sockets and plugs conform to ATA, RCCC (RP-102), SAE (J560b), FMVSS-121, FIEI TTMA (RP 40-73) standards or recommendations, and are compatible with other standard (J560b) connectors.

#### Sockets

Ground terminal accepts wires up to 8AWG, other terminals up to 10AWG. Solid brass contacts are aligned to assure proper contact and minimal voltage drop. Wiring codes are embossed on the insulator. The door is spring-loaded and fits over a mating ridge on the socket face to minimize penetration of dirt and moisture. Housings are constructed from corrosion-resistant diecast metal or rugged glass-filled plastic. Contacts are either self-grounding or insulated. See Section Q3 for socket interiors.

### 3 Mounting Holes

#### 12310 High-Performance Socket



Surpasses SAE J560b performance standards. Accepts all seven-pole plugs conforming to SAE J560b or Cole Hersee 13-pole plug 12301. Superior environmental protection gives extended product life. Glass-filled plastic housing cannot rust or corrode.

Gasket-sealed socket door is spring-loaded and locks onto the plug. Solid brass contact pins. Rain hood extends beyond the pins to protect the interior: drain channel inside the socket has drain channel at 5° downward pitch to reduce water retention. Three mounting holes on the flange: .33" (8.4mm) diameter, 2.93" (74.6mm) on centers.

81356 Rubber Boot gives added protection to the terminals. Not included. See Section Q6.



keeps plugs clean

When the plug is not in use, keep it secure in the Stor-A-Way housing. Accepts all SAE 7-pole plugs and 13-pole plugs. See Section Q6.

#### 12080-11 ABS ★



Color-fast green glass-filled plastic insures quick identification. Spring-loaded door is marked 'Trailer ABS' to further lessen any chance of misconnection. Mounting holes on the flanges are oval, .488" x .328" (12.4 x 8.3mm), 2.93" (74.6mm) on centers. Mounts through 2" (50.8mm) diameter hole.

#### 12080 glass-filled plastic, insulated ★

Mounting holes on the flanges are oval, .488" x .328" (12.4 x 8.3mm), 2.93" (74.6mm) on centers. Mounts through 2" (50.8mm) diameter hole. Black plastic.

#### 12080-01 glass-filled plastic, insulated, split pins

Same as 12080, but with split-pin contacts.

### 2 Mounting Holes

#### 12063 diecast, self-grounding ★



Mounting holes on the flanges are oval, .488" x .328" (12.4 x 8.3mm), 2.93" (74.6mm) on centers. Mounts through 2" (50.8mm) diameter hole.

#### 12063-01 diecast, self-grounding, split pins ★

Same as 12063, but with split-pin contacts.

#### 12075 diecast, insulated



Mounting holes on the flanges : 5/16" (7.9mm) diameter, 4 1/2" (114.3mm) on centers, with additional knockouts 2 15/16" (74.7mm) on centers. Mounts through 2 5/8" (58.7mm) through 3 7/8" (98.4mm) diameter hole.

★ Rapid ship item. BP Available in retail clamshell pack. ★ Minimum order quantity may apply.

**Q1** TRACTOR-TRAILER CONNECTORS

**12075-01 diecast, insulated, split pins**

Same as 12075, but with split-pin contacts.

**12077-01 for ISO type (24V) ★**



Diecast housing, polarized ground terminal, insulated. Replacement for ISO 3731-1976 (E) road vehicles, type 24S (supplementary). Contact pins: one spring-grip female, and six solid male. Mounting holes on the flanges are oval, .488" x .328" (12.4 x 8.3mm), 2.93" (74.6mm) on centers. Mounts through 2" (50.8mm) diameter hole. Mates with Cole Hersee 11100-02 and 11100-01 plugs.

**Plugs**

*Ground terminal accepts wires up to 8AWG, other terminals up to 10AWG. Cable protectors are constructed of plated steel, and provide strain relief and protection against abrasion.*

**Plug Interiors**

See Section Q3.

**12311 High-Performance Plug**



Surpasses SAE J560b performance standards. Superior environmental protection gives extended product life. Black glass-filled plastic housing cannot rust or corrode. Plug locks onto opening on spring-loaded socket door. Spring-grip contacts have self-adjusting spring bands to maintain long-term uniform electrical contact with socket pins. O-ring at the plug end prevents water from reaching the contacts. Strain relief and grommet seal isolates the contacts from mechanical strain, and provides extra moisture protection. Cable retainer maintains secure cable connection. Replaceable interior. Connects with all SAE J560b sockets, and Cole Hersee 13-pole sockets.

**With Spring Grip Electrical Contacts**

Cole Hersee spring grip contacts contain a self-adjusting spring band that maintains contact pressure from socket to pin. Greater contact pressure not only gives greater electrical efficiency, but also makes coupling and uncoupling uniform, and minimizes buildup of dirt. In competitive plugs, conventional contacts tend to widen after repeated use: the Cole Hersee plug has individually sprung sockets to insure maximum contact year after year.

Diecast metal housing. Replaceable interior. Wiring codes are identified on the insulator. Cable clamp holds all wires securely.

**1222 ★**



**1255 with cable protector ★**

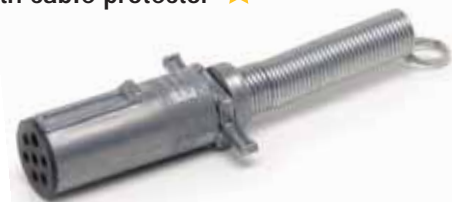

Same as 1222, except with cable protector.

**11100-01 ISO type (24V)**



Diecast housing, polarized ground terminal, insulated. Replacement for ISO 3731-1976 (E) road vehicles, type 24S (supplementary). Contacts: six spring-grip female, and one solid male pin. Mates with Cole Hersee 12077-01 ISO socket.

**11100-02 ISO type (24V), with cable protector**



Same as 11100-01, except with cable protector.

CONTINUED **Q1**

★ Rapid ship item. **BP** Available in retail clamshell pack. ★ Minimum order quantity may apply.

### With Quick Release Plug Interiors

Interiors can be readily removed by loosening the single set screw in the cable clamp, and then depressing on the spring clip release with a screwdriver. The interior then readily slides out. The interior slides back into the housing and locks securely into place with a high-tension metal clip. After the cable clamp is tightened, the plug is ready for use.

#### 12091 diecast ★



#### 12092 diecast, with cable protector ★



#### 12081 glass-filled plastic ★



#### 12082 glass-filled plastic, with cable protector ★



### Cable

See Section Q6 for a full description.

### Assemblies

*Available with one or two plastic or diecast metal plugs. Conform to ATA, RCCC, SAE and TTMA standards. Superior coil memory minimizes snagging, small diameter coil reduces tangling with other lines. Temperature-resistant coil will not crack or stiffen at -70°F (-57°C). Cable jacketing is abrasion- and cut-resistant, repels oil, gas and chemicals. 100% electrical copper conductors give maximum conductivity. Six 12AWG and one 10AWG wires.*

### Coiled Cable

12ft working length



#### 11216-04 two metal plugs, spring grip contacts

With two 1222 plugs: metal housings, spring grip electrical contacts.

#### 11247 two metal plugs, spring grip contacts, protectors

With two 1255 plugs: metal housings, spring grip electrical contacts and cable protectors.

#### 11216 one metal plug, spring grip contacts

With one 1222 plug: metal housing, spring grip electrical contacts.

#### 11217 one metal plug, spring grip contacts, protector

With one 1255 plug: metal housing, spring grip electrical contacts and cable protector.

#### 11247-01 two metal plugs, quick-release interiors, protectors

With two 12092 plugs: metal housings, quick-release plug interiors and cable protectors.

#### 11216-05 one metal plug, quick-release interior

With one 12091 plug: metal housing, quick-release plug interior.

#### 11217-06 one metal plug, quick-release interior, protectors

With one 12092 plug: metal housing, quick-release plug interior and cable protector.

#### 11247-02 two plastic plugs, quick-release interiors, protectors

With two 12082 plugs: glass-filled plastic housings, quick-release plug interiors and cable protectors.

### Straight Cable

10' 8" long (3.25m)

#### 11217 two metal plugs, spring grip contacts, protectors

With two 1255 plugs: metal housings, spring grip electrical contacts and cable protectors.

#### 11218 two metal plugs, spring grip contacts, protectors

With two 1255 plugs: metal housings, spring grip electrical contacts and cable protectors.

#### 11217-05 two metal plugs, quick-release interiors, protectors

With two 12092 plugs: metal housings, quick-release plug interiors and cable protectors.

★ Rapid ship item. BP Available in retail clamshell pack. ★ Minimum order quantity may apply.



**Q2 1- TO 6-POLE CONNECTORS**

Normally used with a trailer where limited functionality (taillights, brake lights) is needed. Ideal for boat trailers, or RVs towing a car on a flatbed trailer. See also Section Q6 'RV & Automotive Connectors' for a different kind of connector. Diecast metal housings. Screw terminals accept up to 12AWG wire. Replaceable interiors.

## Sockets

Brass split-pin contacts are aligned to assure proper contact and minimal voltage drop. Spring-loaded socket doors, plug locks securely into the opening. Wiring codes are identified on the insulator. Two mounting holes on the flange 17/64" (6.7mm) diameter, 2 15/16" (74.6mm) on centers. Mount through 1 3/8" (34.9mm) diameter hole.

### 1258 6-pole

Exposed terminal screws.



### 1268 6-pole, self-grounding

Same as 1258, but self-grounding and with recessed terminal screws.



### 1235 6-pole, protective housing ★

Same as 1258, but with special housing that protects terminals from road splash.



### 1232 4-pole, protective housing BP ★

With special housing that protects terminals from road splash.



### 1257 4-pole

Same as 1232, but with exposed terminal screws.

## Plugs

Contacts float for best alignment and connection. Cable clamps hold all size cables firmly in place. Cable protectors (where present) are constructed from plated steel, and provide strain relief and protection against abrasion.

### 1236 6-pole ★



### 1254 6-pole, cable protector ★

Same as 1236, but with cable protector.



### 1233 4-pole BP ★



### 1253 4-pole, cable protector ★

Same as 1233, but with cable protector.



## Cable

See Section Q6.

## Interiors

See Section Q3.

CONTINUED **J2**

★ Rapid ship item. BP Available in retail clamshell pack. ★ Minimum order quantity may apply.

## 2-Pole Power Take-Off Connector

*Provides a high-integrity two-circuit path for on- and off-road vehicles and in agricultural applications. Plug latches solidly with the socket cover. Suitable replacement for connectors in tarping applications. Vertically-aligned machined brass contacts, diecast zinc plug and socket housings, engineering-grade plastic. Terminations accept 6AWG wire. Polarized.*

### 11041-06 socket



Gasket-sealed socket keeps out dirt and moisture when plug is not in use.

### 11042-05 plug



For use with 2-pole socket 11041-06. Durable, flexible spring coil protects the cable.

### 11250-01 plug and socket

Set of 11041-06 and 11042-05.

Photo: Roll-Rite LLC.



## tarping apps

The two-pole power take-off is perfect for tarping applications... but it's also used in liftgate connections and to supply power to a broad range of auxiliary equipment that's part of the truck or utility vehicle. It also finds use in powering on-site equipment.

## 1-Pole Power Take-Off Connector

*Provides power to auxiliary equipment. Accepts up to 0AWG cable. Diecast metal housings. Electrical conductors and connections are designed for maximum efficiency and long life.*

### 11041 socket ★



Self-grounding. Solid brass 3/8" (9.5mm) diameter male contact, with insulated tip to prevent short circuits. Rubber boot protects the terminals and connections from moisture and dirt. Fits 2" (50.8mm) diameter hole. Two mounting holes on the flange 21/64" (8.6mm) diameter, 2 5/16" (74.6mm) on centers.

### 11042 plug ★



With ground return terminal. Brass female contact with spring grip tension provides solid engagement with the mating socket. Cable clamp holds cable firmly in place.

## External Ground/Universal Line Connector

*Provides an external ground where grounding cannot be obtained through the vehicle frame. Can be used in conjunction with 11041 and other primary electrical take-off units.*

### 11157 socket



Brass contacts and terminals. Accepts up to 6AWG cable. Corrosion-resistant plated steel housing. Stainless steel spring on the cover locks the plug in place, closes securely to protect the contacts. Rubber boot protects terminals and cable connection. Integral mounting bracket has two .218" (5.6mm) diameter mounting holes, 1.25" (31.8mm) on centers.

### 11156 plug



Plated brass housing. Threaded cable grip prevents loosening of cable.

★ Rapid ship item. BP Available in retail clamshell pack. ★ Minimum order quantity may apply.

## Q3 SOCKET AND PLUG INTERIORS

Impact-resistant insulators repel oil and water. Permanent molded-in wire codes provide easy identification. Contacts and connections are carefully designed to ensure maximum electrical efficiency. Terminal screws, socket mounting or plug mounting screws are provided.

### 13-pole

Accepts up to 8AWG and 10AWG wire.

#### 12302 plug interior



For 12301 plug. Glass-filled plastic insulator, spring-grip brass contacts. O-ring seal.

### 7-pole

Accept up to 8AWG and 10AWG wire. Spring-grip contacts have self-adjusting spring bands that ensure uniform contact with socket pins. Contacts float for best alignment and connection. Bumper construction protects the end of the plug housing.

#### 12312 plug interior, spring-grip contacts



For 12311 plug. O-ring seal.

#### 1286 plug interior



For 1222 and 1255 plugs.

### 6-pole

Accept up to 12AWG wire.

#### 1296 plug interior



For 1236 and 1254 plugs.

#### 1158 plug interior, straight body



For 1236 and 1254 plugs, and many other makes of plug.

#### 1159 socket interior



For 1235 socket. Split contact pins.

### 4-pole

Accept up to 12AWG wire.

#### 1295\* plug interior



For 1253 and 1233 plugs.

#### 1156\* socket interior



For 1232 socket. Split contact pins.



## keeps plugs clean

For 7-pole plugs. Stainless steel wire brush cleans corroded contacts in seconds. See Section Q6.

TRAILER CONNECTORS **Q4**

See also Section Q2 '1- to 6-pole Connectors'.

### In-line Trailer Connectors

Flat profile design provides a robust 7-pole or 12-pole connection. Housings are molded thermoplastic material, resistant to ultraviolet solar radiation. Nickel-plated brass terminals with split contact pins give a positive connection. Insulators between each terminal provide protection from short circuits. Spring-loaded socket lid protects the terminals when not in use. Insulated cable clamp secures the cable, minimizing vibration and strain. Terminal covers are easily removed for access to terminals.

#### Circuit Identification:

- |  |               |
|--|---------------|
| 1. Left turn signal                      | 8. Accessory  |
| 2. Accessory                             | 9. Accessory  |
| 3. Ground                                | 10. Ground    |
| 4. Right turn signal                     | 11. Accessory |
| 5. Accessory                             | 12. Accessory |
| 6. Brake lights                          |               |
| 7. Rear, clearance and side marker lamps |               |

7-pole connectors have circuits 1-7 only.

### 7-pole

Connectors accept up to 14AWG wire.

#### 12400 socket



#### 12401 plug



### 12-pole

Pins 1-7 accept up to 14AWG wire, pins 8-12 accept up to 8AWG wire.

#### 12500 socket



Accepts 12-pole plug or 7-pole plug.

#### 12501 plug



### Universal Trailer Connectors

Weatherproof connectors & wire lead assemblies. Polarized to assure proper mating of circuits. Molded bodies. Color-coded 16AWG wire, 6" long (152.4mm). Conductors are properly aligned and bonded into the insulation, to assure minimal voltage drop, and for ease in connecting.

#### 11135 5-pole pair



#### 11134 4-pole pair BP ★



#### 11134-08BP 4-pole pair, with splicers BP

Retail pack with 11134 and eight 30223 Quick-Tap wire splicers.

#### 11173 3-pole pair BP



#### 11172 2-pole pair BP ★



#### 11171\* 1-pole



Single unit, mates with standard female bullet terminal.

★ Rapid ship item. BP Available in retail clamshell pack. ★ Minimum order quantity may apply.

## Connectors with Screw-on Caps

*Molded insulator bodies. Precision-machined contacts. Knurled caps unscrew for easy connection of wires, and protect against weather and dirt. Terminal ID .110" (2.8mm) accepts up to 12AWG stranded wire.*

### 1107-F\* 2-pole female plug



### 1107-M\* 2-pole male plug



### 11076 1-pole female plug



Mates with 11075 socket. 11075 socket on page 156.

### 1107\* 2-pole pair



One 1107-M (male) and one 1107-F (female).

### 1102\* 2-pole pair, polarized

Same as 1107, except polarized.

### M-118 2-pole pair, polarized, brass screws BP

Same as 1107, except polarized, and with brass terminal screws.

### 1102-F 2-pole plug, polarized



Female polarized plug.

### 1238 2-pole polarized plug and socket



Screw-on cap protects the socket from dirt and moisture when not in use. Polarized for proper mating of circuits. Includes one 1102-F plug. Mount in 45/64" (17.9mm) diameter hole in panels up to 3/8" (9.5mm) thick. Plated steel cap and housing.

### 1292\* 2-pole socket with variable spacer



Mounting nut, lockwasher and spacer are adjustable for different panel thicknesses. Mounts flush in 11/16" (17.5mm) diameter hole. Polarized for proper mating of circuits. Mates with 1102-F plug (not supplied).

## Connectors with Rubber Caps

*Polarized to assure proper mating of circuits. Molded insulator bodies. Precision-machined brass contacts. Rubber caps protect connectors.*

### 1134 BP 4-pole pair



Circuit identification printed on the insulator.

### M-115 4-pole pair, brass screws BP

Same as 1134, but with brass terminal screws.

### M-114 3-pole pair, brass screws BP



Brass terminal screws.

### M-121 2-pole pair, brass screws BP ★



Brass terminal screws.

CONTINUED **Q4**

★ Rapid ship item. BP Available in retail clamshell pack. ★ Minimum order quantity may apply.



# Q electrical connectors

## Q4 AUTOMOTIVE TRAILER CONNECTORS

### Flush-mount Flanged Socket Connectors

Corrosion-resistant socket housings. Two .147" (3.73mm) diameter mounting holes, 1/19" (30.23mm) on centers.

#### 11075\* 1-pole male socket



Insulated male contact.

Mates with 11076 plug. 11076 plug on page 155.

#### 1110\* 2-pole male socket



Mates with 1107-F plug.

#### 1109\* 2-pole female socket



Mates with 1107-M plug.

#### 1145\* 2-pole male socket, with cover



Mates with 1102-F plug.

Pivot cover protects against moisture and dust. Polarized.

#### 1214 2-pole male socket, with cover and plug

1102-F plug and 1145 socket. Polarized.

# electrical connectors

## Q5 FARM EQUIPMENT CONNECTORS

Two-pole breakaway unit: plug automatically releases at approximately 20lbs pull. Mate with all connectors of comparable design. Polarized. 20A maximum capacity.

#### 1282 socket with mounting bracket



Plated steel housing. High impact-resistant molded plastic insulator. Brass contacts and brass screw terminals. Stainless steel spring on the cover locks the plug in place. Integral mounting bracket with two .218" (5.6mm) diameter mounting holes, 1.25" (31.8mm) on centers.

#### 12001\* flanged socket



Plated steel housing. Molded plastic insulator. Cover locks firmly in place when not in use. Two .20" (5.2mm) diameter mounting holes, 1.87" (47.4mm) on centers.

#### 1283-325\* plug



Plated brass housing. Threaded cable grip.

ag. app.



Several of the 'tractor trailer' plugs are also useful in agricultural applications. Two of the most popular are the 7-pole connectors 12080/12081/12082 and 12310/12311 as well as the 13-pole connectors 12300/12301.

See Section Q1.

★ Rapid ship item. BP Available in retail clamshell pack. ★ Minimum order quantity may apply.

## Cable

*Straight cable, available by the foot. Conductor wires are color-coded for easy recognition. Durable insulation resists abrasion.*

### 98647 13-conductor

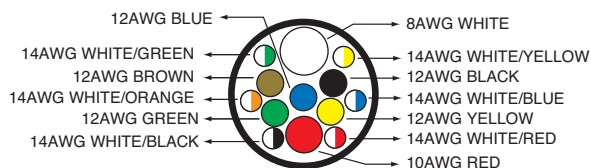

Will not crack or stiffen at -70°F (-57°C). One 8AWG, one 10AWG, five 12AWG and six 14AWG wires, 100% electrical copper for maximum conductivity.

### 4077 7-conductor

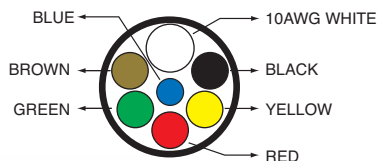

Six 12AWG wires and one 10AWG white wire.

### 4076 6-conductor

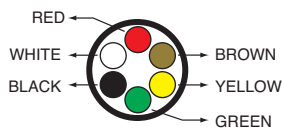

Six 14AWG wires.

### 4075 4-conductor



Four 14AWG wires.

## Cable Protector

### 81192 Cable Protector



Protects against strain and kinking. Plated steel. For Cole Hersee plugs: 11042-05, 12081, 12082, 12091, 12092.

## Trailer Connector Adapters

*These adapter assemblies are useful to conveniently connect a 6-pole system to a 7-pole system, and eliminate makeshift jumpers. Connect the appropriate adapter to your existing cable assembly to link a vehicle with a 6-pole male socket to a vehicle with a 7-pole male socket. Brass pins, brass female contacts.*

### 11011 for use with a 7-pole cable assembly

Consists of a 6-pole female diecast plug connected by a 12" cable to a 7-pole male plug. The 7-pole plug is plastic with a plastic boot.

### 11017 for use with a 6-pole cable assembly



Consists of a 6-pole male plastic plug connected by a 12" cable to a 7-pole female diecast plug.

## Protective Boots

*Protect against road splash, dirt and moisture.*

### 81356 Boot for 12300 and 12310 sockets



Fits over the back of the flange, and covers the terminal connectors. Protects against road splash, dirt and moisture. For 12310 7-pole socket and 12300 13-pole socket.

### 11178 Boot for 7-pole sockets ★



Inner ridge locks over the heads of the terminal screws and to the edge of the casting. For Cole Hersee sockets 12063, 12063-01, 12080, 12080-01, 12080-11, 12077-01 and other 7-pole sockets of comparable design.

CONTINUED **Q6**

★ Rapid ship item. BP Available in retail clamshell pack. ★ Minimum order quantity may apply.

## Surface mounting of sockets

For attachment of 4-, 6-, and 7-pole sockets of standard design (without integral circuit breakers).

### 11167 Adapter plate



Heavy duty adapter provides secure seating for attachment of sockets, and permits installation of fuse/breaker block or terminal block in the rear. Mounting holes 5/16" (7.9mm) diameter, 4 1/2" (114.3mm) on center. Mounting hardware included.

### 11165 Mounting bracket



Eliminates the need for cutting a hole in the trailer to accept a socket. Mounting hardware included. Center hole is 2" (50.8mm) diameter.

Mounting hardware included.

### 11164 Mounting Gasket for Sockets



Neoprene gasket for plastic or metal sockets. For Cole Hersee sockets 12063, 12063-01, 12080, 12080-01.

### 11187 Plug Cleaner Brush



For 7-pole plugs. Durable plastic body with snap-on cover. Stainless steel wire will not rust. Brush cleans corroded contacts in seconds, and with regular use extends the life of connectors

### 11750 Stor-A-Way Plug Holder ★



Cole Hersee patent. Keeps plugs clean when not in use, and extends life, by protecting electrical contacts from dirt and road splash. For all SAE J560b 7-pole plugs and 13-pole plugs. Spring-loaded for secure locking. Heavy duty glass-filled plastic housing.

Fits 11100-02, 12311, 1222, 1255, 12091, 12092, 12081, 12082, 12301 and 11042-05.

11751 Plug Holder fits 1236 and 1254 and all similar six pole plugs.

### 31784 Female Pin Terminal

Crimp-on brass connector mates with the 6 smaller pins in the 12301 13-pole plug and 12300 13-pole socket. Pre-tinned brass. 6 required for each 13-pole plug.

### 1160 License Holder Tube



Weatherproof tube protects important papers. 5" x 1 1/8" (127.0 x 28.6mm). Captive brass screw-on cap. Brass flange, aluminum body. Three 3/16" (4.8mm) diameter mounting holes in the flange.

★ Rapid ship item. BP Available in retail clamshell pack. ★ Minimum order quantity may apply.

## Wiring colors

Colors are not universal, so it's wise to check proprietary instructions, and to make an electrical test.

The following colors are very commonly used.

### 4-pole

- Green - Right turn and brake lights
- Yellow - Left turn and brake lights
- Brown - Taillights and clearance lights
- White - Ground

### 5-pole

- In addition to the above.
- Red - Backup lights

### 6-pole

#### Typical coding convention for 6-pole circuits

| Wire Color    | Conductor Number | Cole Hersee Terminal Marking | Function   |
|---------------|------------------|------------------------------|--|
| White         | 1                | GD                           | Ground return to towing vehicle                  |
| Brown         | 2                | TM                           | Clearance, side marker, and identification lamps |
| Yellow        | 3                | LT                           | Left turn signal and hazard lamps                |
| Red           | 4                | S                            | Stop lamps and antilock device                   |
| Green         | 5                | RT                           | Right turn signal and hazard lamps               |
| Black or Blue | 6                | A                            | Continuous ABS power/Auxiliary                   |

Tail lamp load goes with marker circuit 2.

### 7-pole

- Brown - Right turn and brake lights
- Red - Left turn and brake lights
- Green - Taillights and clearance lights
- Yellow - Auxiliary
- White - Ground
- Blue - Electric trailer brakes
- Black - Auxiliary Power/Battery Charge

#### SAE coding convention for 7-pole connectors

| Wire Color | Conductor Number | Cole Hersee Terminal Marking | Function   |
|------------|------------------|------------------------------|--|
| White      | 1                | W                            | Ground return to towing vehicle                  |
| Black      | 2                | BK                           | Clearance, side marker, and identification lamps |
| Yellow     | 3                | Y                            | Left turn signal and hazard lamps                |
| Red        | 4                | R                            | Stop lamps and ABS device                        |
| Green      | 5                | G                            | Right turn signal and hazard lamps               |
| Brown      | 6                | BR                           | Tail and license plate lamps                     |
| Blue       | 7                | BL                           | Continuous ABS power/Auxiliary                   |

## AWG conversion

American Wire Gauge (AWG) is a US standard set of non-ferrous wire conductor sizes. Non-ferrous usually implies copper, but it includes aluminum and other metals and alloys.

The "gauge" refers to the diameter. Typical household wiring is AWG number 12 or 14. Telephone wire is much thinner at 22, 24, or 26. The higher the gauge number, the smaller the diameter and the thinner the wire and the less current it will safely carry. Thicker wire carries more current because it has less electrical resistance over a given length. Thus larger wire is used with high currents and when the voltage drop along its length must be minimized. For example: High output alternator wiring might be 2 AWG and the starter cable for a mid-sized engine 1 or 0 AWG.

The metric equivalent is simply the diameter expressed in millimeters, and thus can be easily measured with calipers.

| AWG | mm    | AWG | mm     | AWG  | mm      |
|-----|-------|-----|--------|------|---------|
| 26  | 0.128 | 16  | 1.308  | 6    | 13.292  |
| 25  | 0.162 | 15  | 1.652  | 5    | 16.755  |
| 24  | 0.205 | 14  | 2.088  | 4    | 21.137  |
| 23  | 0.255 | 13  | 2.629  | 3    | 26.653  |
| 22  | 0.322 | 12  | 3.302  | 2    | 33.606  |
| 21  | 0.411 | 11  | 4.156  | 1    | 42.384  |
| 20  | 0.516 | 10  | 6.271  | 0    | 53.454  |
| 19  | 0.653 | 9   | 6.626  | 00   | 67.399  |
| 18  | 0.823 | 8   | 8.350  | 000  | 84.004  |
| 17  | 1.039 | 7   | 10.544 | 0000 | 104.091 |



### trailer tail light converter

Electronic unit permits a towing vehicle with two lighting circuits for each side to operate lights on a trailer with a single circuit each side. Eliminates the need to rewire the trailer or to add additional lights. US laws require stoplights, turn signals and tail lights on trailers. See Section K4.

CONTINUED **Q7**

## Inline trailer connectors

12400, 12401, 12500, 12501

*Not supplied with wire, but the terminals are identified by numbers.*

## 7-pole connectors

Accept wire up to 14AWG

1. Left turn signal
2. Accessory
3. Ground
4. Right turn signal
5. Accessory
6. Brake lights
7. Rear, clearance and side marker lights

## 12-pole connectors

Pins 1-7 accept wire up to 14AWG, pins 8-12 up to 8AWG.

1. Left turn signal
2. Accessory
3. Ground
4. Right turn signal
5. Accessory
6. Brake lights
7. Rear, clearance and side marker lights
8. Accessory
9. Accessory
10. Ground
11. Accessory
12. Accessory

## 13-pole connectors

Pins 1-7 accept wire up to 14AWG, pins 8-13 up to 8AWG.

Pins 1-7 as for 7-pole connector, pins 8-13 auxiliary.

## Best practice for assembly of plugs and sockets

Properly installed tractor-trailer connectors are critical to the safe performance of a rig, which are routinely subjected to vibration, extreme weather conditions, as well as mechanical forces.

We highly recommend that a trained technician performs the installation. It is the responsibility of the end-user to take into account the mounting location and environment, conductor type, size, flexibility and other installation parameters.

Review the assembly procedure before assembly. A common error is to not slide a clamp, boot or housing onto the cable before connecting the wires. Recommended tools: screwdriver (preferably with torque limiter); soldering iron (preferably a solder pot), solder and flux; wire stripper and cutter; and ruler.

Cut the cable, and strip the jacket to the recommended length.

Strip the wires to the recommended length, and tin them. Maintain a tight strand bundle before tinning, so that there are no loose strands. Re-tin if necessary. This makes it easier to insert the wires into the terminal, and helps to properly position the tinned strands at the right depth.

Slide the housing, spring coil or boot over the cable.

Properly insert and position the tinned conductor into each terminal. Locate the tinned portion under the terminal screw before tightening the screw. Tighten the termination screws to the appropriate torques.

Inspect the terminated connection for cut or loose strands, fragments of wire insulation between the terminal/conductor connection, bent terminals, loose or stripped terminal screws and other visible problems.

Check that the correct connections have been made, by re-checking that the conductor jacket color matches the insulator coding.

Carefully slide the insulator into the connector housing, making sure that the insulator is fully seated. Don't twist or lever the terminated conductor after it has been inserted and locked into the insulator. This may damage the terminal and put stress on the terminated connection.

Finally tighten the housing screw or cable clamp.

In order to keep a plug clean when not inserted in a socket, we recommend the use of the 11750 Stor-A-Way Plug Holder – see Section Q6.

# circuit protection & wiring accessories

P

|                              |    |
|------------------------------|----|
| CIRCUIT BREAKERS             | P1 |
| BLOCKS & BUSBARS             | P2 |
| TERMINAL BLOCKS              | P3 |
| FUSES                        | P4 |
| CONNECTORS & TERMINALS       | P5 |
| CLAMPS, CLEATS, CLIPS & TIES | P6 |
| ACCESSORIES                  | P7 |

## circuit protection & wiring accessories

### P1 CIRCUIT BREAKERS

Circuit breakers and fuses are a cost-effective solution to protecting wiring, equipment and subsystems. While fuses are a one-time, disposable solution, circuit breakers can be re-used after overload. Part number suffixes indicate the amperage. eg: 30409-15 is a 15 ampere Type I ATC/ATO breaker.

#### Plug-in style, 12V

##### Mini Breakers

Conform to SAE J553

##### 30418 Type I

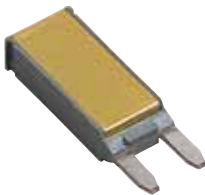

Gray plastic housing with gold cover.  
Available in: 10, 15, 20, 25A and  
10, 15, 20, 25A **BP**.  
Order Nos. 30418-25 or  
30418-25BP etc.

##### 30419 Type II



Gray plastic housing with silver cover.  
Available in: 10, 15, 20, 25A and  
10, 15, 20, 25A **BP**.  
Order Nos. 30419-25 or  
30419-25BP etc.

#### ATC/ATO Breakers

Conform to SAE J553. Replacement for ATC or ATO fuses. Color-coded housings with rating marked on the top: 10A red, 15A blue, 20A yellow, 25A silver, 30A green

##### 30409 Type I



Long terminals,  
as supplied

One segment  
snapped off

Two segments  
snapped off

Terminals are grooved so that they can be easily snapped off with pliers to fit the electrical blocks of different vehicles. Available in: 10, 15, 20, 25, 30A and 10, 15, 20, 25, 30A **BP**. All items are ★. Order Nos. 30409-30 or 30409-30BP etc.

Use as is (long terminals) for Kenworth trucks. Use with one segment snapped off each terminal for: Dodge trucks, Ford heavy trucks, Navistar trucks. Use with two segments snapped off (short terminals) for Ford pickup trucks.

CONTINUED P1

## 30411 Type II



Silver housing with rating marked on the top. Available in: 10, 15, 20, 25, 30A and 10, 15, 20, 25, 30A **BP**.  
Order Nos. 30411-30 or 30411-30BP etc.

## 30413 Type III



Available in: 10, 15, 20, 25, 30A and 10, 15, 20, 25, 30A **BP**.  
Order Nos. 30413-30 or 30413-30BP etc.

## Special Applications

## 30403 Mack Truck

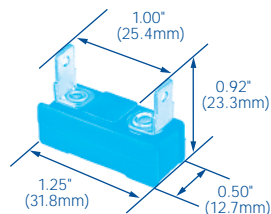

Type II, fits Mack Truck breaker blocks.  
Available in: 15, 20, 25, 30A.  
Order Nos. 30403-30 etc.

## 30408 Navistar Truck

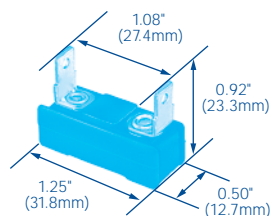

Type II, fits Navistar breaker blocks.  
Available in: 10, 15, 20, 25, 30, 35A and 20, 30A **BP**.  
Order Nos. 30408-30 or 30408-30BP etc.

## SAEJ553 for circuit breakers

Society of Automotive Engineers Standard J553 defines testing and performance requirements for three types of circuit breakers up to 50A for 6V, 12V, and 24V operation: Type I, Type II and Type III.

Conforming circuit breakers:

Must carry 100% of rated current continuously for a minimum of 1 hour.

Must open at 135% of rated current within 30 minutes.

Must open at 200% of rated current within 1 minute.

The specific current capacity of the circuit breaker is a function of the particular electrical system being utilized. It is recommended that the actual performance be verified through testing experimentally in the proposed application. Several factors should be considered:

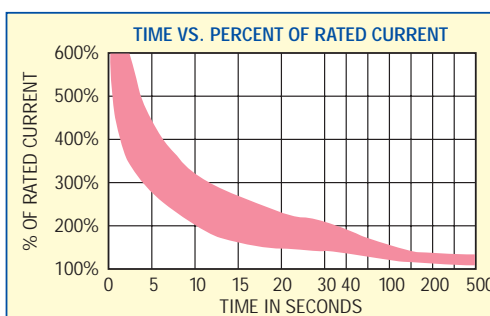

## Ambient temperature

Circuit breakers are thermal devices. Changes in the ambient temperature will have an effect on the current carrying capacity and on the effective limitation of current during overload cycling.

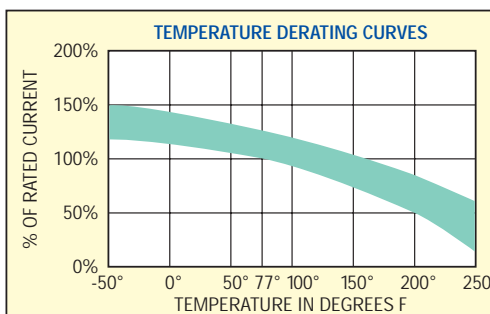

## Wire and Terminations

The connecting wires and their terminations will affect the heat dissipation characteristic of the breakers. Deviations from the breaker application specifications may affect the current carrying capacity or the effective limitation of current during overload cycling.

## Voltage Rating

The rating marked on breakers is the maximum value recommended. Use at higher voltages may significantly shorten product life under load conditions, and possibly cause damage to your equipment.

Circuit Protection components are thermal devices that create an open circuit under overcurrent conditions. They are deliberately designed as the sacrificial weakest link in a system, protecting components from costly damage. It is important to select a fuse or circuit breaker with a current rating equal to or lower than the lowest current rating of any part of the circuit.

## Stud or Blade Style

Conform to SAE J553. Plated steel or rugged plastic cases with or without bracket. Metal breakers without brackets snap securely into steel brackets (Series 30090) or attach with the stud to nylon brackets (Series 87128), see section P6.

Studs are 10-32, two blade types are .250" (6.4mm) wide. Breaker and bracket dimensions shown are similar on all breakers in this section.

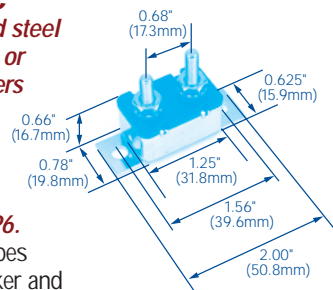

## 24V with studs, steel case

### 30171 Type I



Available in: 10, 15, 20, 30A.  
Order Nos. 30171-30 etc.

### 30172 Type I, with bracket



Available in: 10,\* 15, 20, 30A.  
Order Nos. 30172-30 etc.

## 12V with studs, steel case

### 30055 Type I, with bracket



Available in: 6, 8, 10, 15, 20, 25, 30, 40, 50A **BP**. Items 10, 15, 20, 25, 30, 40, 50A are ★.  
Order Nos. 30055-50 or 30055-50BP etc.

### 30056 Type I



Available in: 6, 8, 10, 15, 20, 25, 30, 40, 50A and 15, 20, 30, 40A **BP**. Items 10, 15, 20, 25, 30A are ★.  
Order Nos. 30056-40 or 30056-40BP etc.

### 30128 Type I, with cross-bracket



Available in: 6\*, 8\*, 10, 15, 20, 25, 30, 40A.  
Order Nos. 30128-40 etc.

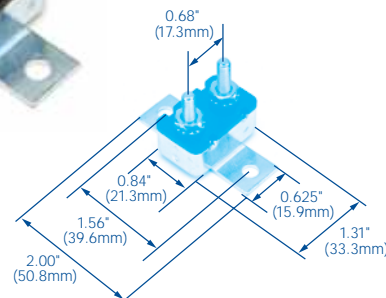

### 30137 Type I, sealed stud



Stud insulator is sealed.  
Available in: 6, 8\*, 10\*, 15, 20, 25\*, 30, 40A\*.  
Order Nos. 30137-40 etc.

### 30138 Type I, with bracket, sealed



Stud insulator is sealed.  
Available in: 6\*, 10, 15, 20, 25\*, 30, 40A\*.  
Order Nos. 30138-40 etc.

### 30144 Type II



Available in: 8\*, 10\*, 15\*, 20, 25\*, 30A.  
Order Nos. 30144-30 etc.

### 30145 Type II, with bracket



Available in: 6, 8, 10, 15A.  
Order Nos. 30145-15 etc.

CONTINUED P1

★ Rapid ship item. **BP** Available in retail clamshell pack. \*Minimum order quantity may apply.



**12V with studs, plastic case**

30414 Type I, with cross-bracket



Internally sealed.  
Available in: 30 and 50A.  
Order Nos. 30414-50 etc.

**12V with studs, gray plastic case**

30427 Type I



Weather-resistant.  
Available in: 15 and 40A.  
Other amperages are available  
by special order.  
Order Nos. 30427-40 etc.

**24V with studs, plastic case**

30423 Type III



Available in: 8\*, 10\*, 15, 20\*, 25\*,  
30\*, 40, 50A\*.  
Order Nos. 30423-50 etc.

30406 Type III



Available in: 15, 20, 25, 30,  
40, 50A.  
Order Nos. 30406-50 etc.

30407 Type III, with cross-bracket



Available in: 15, 20, 25\*, 30,  
40, 50A.  
Order Nos. 30407-50 etc.

**12V with blades**

Steel case

30401 Type I



Available in: 4\*, 6, 8\*, 10, 15, 20A.  
Order Nos. 30401-20 etc.

30402 with bracket

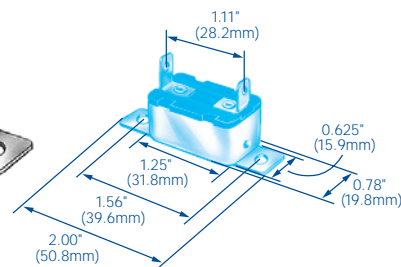
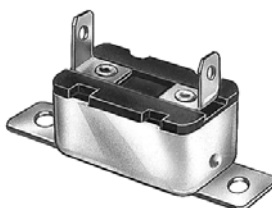

Available in: 4, 6, 15, 20A.  
Order Nos. 30402-20 etc.

30404 blade &amp; stud



Available in: 20 and 30A.  
Order Nos. 30404-30 etc.

**metal or plastic?****Which body best suits your application?**

There's not a lot of difference between metal body and plastic body circuit breakers: both are about the same weight and structural integrity, but the plastic type is more resistant to denting and corrosion. One type of plastic-body breaker, the 30427 series (on this page), is also weather-resistant.

## PVC coated, Type I

With PVC coated leads and body for added weather protection. Steel case. 10" (254.0mm) wire loop is readily cut to form two leads for splicing into the circuit. Wire is color-coded: 10A green 16AWG, 15A yellow 16AWG, 20A black 14AWG, 25A white 14AWG, 30A red 12AWG, 40A brown 12AWG. 12V DC.

30063



Available in: 10, 15\*, 20, 25\*, 30, 40A\*  
Order Nos. 30063-40 etc.

### 30062 with bracket.



2.0" (50.8mm) bracket has two mounting holes 1.56" (39.6mm) on centers.  
Available in: 15\*, 20, 30A.  
Order Nos. 30062-30 etc.

## Double breaker assemblies

12V, Type I. For high amp applications.

3088

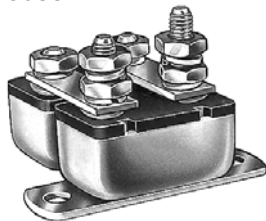

2.0" (50.8mm) bracket has two mounting holes 1.56" (39.6mm) on centers.  
Available in: 50, 60, 80A.  
Order Nos. 3088-80 etc.

### 30507 sealed

Same as 3088, but stud insulator is sealed.  
Available in: 60 and 80A. Order Nos. 30507-80 etc.

### 30510 with snap-in bracket

4.81" (122.2mm) bracket, with mounting holes 4" (101.6mm) on centers.  
Available in 80A.  
Order No. 30510-80

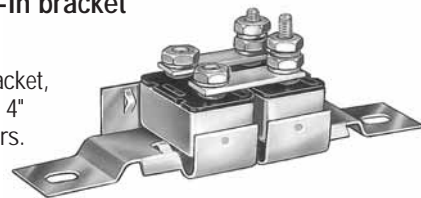

## Glass Fuse Style, 12V DC

30410 Type II



Breaker replaces 3AG (AGC) and SFE glass fuses: snaps into standard clips on Cole Hersee fuse blocks. See section H3. Available in 10, 15, 20, 25, 30, 40A. Order Nos. 30410-40 etc. 10A replaces Ford DOHB-14526-A, 15A DOVB-14526-A, 20A DOVB-14526-B, 25A DOHB-14526-B, 30A DOVB-14526-C.



## brackets & busbars

### Nylon Brackets and Busbars

Brackets in a range from 4-gang to 13-gang conveniently house and organize the stud-type circuit breakers and can be used with slotted busbars from 2-gang to 12-gang to create a variety of circuitries.

## breaker types

### SAE Type I

Automatic. Continuously resets until the overload is corrected.

### SAE Type II

Remains open as long as the overload exists. Resets after the power is turned Off and the overload is corrected.

### SAE Type III

Manual. Remains open until manually reset, using the button on the breaker.



SAE Type III

## For plug-in breakers & fuses

For ATC and ATO fuses and circuit breakers. Fuse/breaker contacts are recessed for safety. Recessed area in the center of the block accepts a label. Electrical ratings: 25A maximum per circuit at 12V to 24V DC. 150A maximum total for the block at 12V DC. For 24V DC applications use only ATC or ATO fuses.

Black thermoplastic block. Blade terminals are .25" wide (6.4mm). Stud terminal is 10-32 with hexnut, flat washer and lockwasher. Four .218" (5.5mm) diameter mounting holes take #10 screws. Size: 3.375" wide x .812" high (85.7 x 20.6mm). Mounting holes 1.06" (27.0mm) on centers, widthwise.

For more information, request sheet D-601.

## With common hot feed only

### 46377-6 6-gang BP ★



Length: 2.47" (62.7mm). Mounting holes .625" (15.9mm) on centers.

### 46377-8 8-gang ★

Length: 3.09" (78.5mm). Mounting holes 1.25" (31.8mm) on centers.

### 46377-10 10-gang BP

Length: 3.72" (94.5mm). Mounting holes 1.875" (47.6mm) on centers.

### 46377-12 12-gang

Length: 4.34" (110.0mm). Mounting holes 2.5" (63.5mm) on centers.

### 46377-14 14-gang

Length: 4.97" (126.2mm). Mounting holes 3.125" (79.4mm) on centers.

### 46377-18 18-gang

Length: 6.22" (158.0mm). Mounting holes 4.375" (111.1mm) on centers.

## With common hot feed & common ground

### 46379-6 6-gang BP

Length 3.77" (95.8mm). Mounting holes .625" (15.9mm) on centers.

### 46379-8 8-gang BP



Length 4.39" (111.5mm). Mounting holes 1.25" (31.8mm) on centers.

### 46379-10 10-gang BP

Length 5.02" (127.5mm). Mounting holes 1.88" (47.6mm) on centers.

## Other blocks

### 4766 Common Hot Feed with blade terminals



6-gang. Blade terminals on one side of the fuse clip. 5 3/4"L x 1 7/8"W x 23/32"H (146.6 x 47.6 x 18.3mm). Brass terminal screws with lockwashers. Solid brass busbar. Two mounting holes 11/16" (4.3mm) diameter, 3.75" (95.3mm) on centers.

### 4652\* Extra Heavy Duty Fuse Block for SAG (AGU) fuses



For SAG (AGU) fuses 13/32" diameter x 1 1/2" long (10.3 x 38.1mm), rated up to 60A. Screw terminals, phosphor-bronze fuse clips. Molded plastic base with two 3/16" (4.8mm) mounting holes, .812" (20.6mm) on centers.

### M-674 Combination Fuse Block & Terminal Block



For SFE 20A or 3AG (AGC) fuses. Common hot feed to four independently-fused circuits, and common ground strip for four circuits. Solid brass busbars, terminals and terminal screws. Nickel-plated phosphor-bronze fuse clips. Two eyelet holes for mounting with 3/16" (4.8mm) screws, 2.25" (57.2mm) on centers. 3 1/2"L x 2 3/4"W x 25/32"H (88.2 x 69.8 x 19.8mm).

★ Rapid ship item. BP Available in retail clamshell pack. ★ Minimum order quantity may apply.

## For Glass Fuses and 30410 Breakers

For SFE 20A or 3AG (AGC) fuses (see Section P2), and 30410 circuit breakers (see Section P1).

### Individual Hot Feed

#### Fiber base



Nickel-plated phosphor-bronze plated fuse clips. Hard fiber insulator base with 11/64" (4.4mm) diameter mounting holes. Width: 2 1/4" (57.2mm), height 5/8" (15.9mm). Plated steel terminals and screws or (with M- prefix numbers) with brass terminals and screws. Mounting holes .75" (19.0mm) on centers.

#### 4622\* Steel 2-gang

Length: 1 1/4" (31.8mm).

#### 4623\* Steel 3-gang

Length: 2" (50.8mm).

#### 4624 Steel 4-gang

Length: 2 3/4" (69.9mm).

#### 4625 Steel 5-gang

Length: 3 1/2" (88.9mm).

#### 4626 Steel 6-gang

Length: 4 1/4" (108.0mm).

#### M-412 Brass 2-gang BP

Length: 1 1/4" (31.8mm).

#### M-413 Brass 3-gang

Length: 2" (50.8mm).

#### M-414 Brass 4-gang

Length: 2 3/4" (69.9mm).

#### M-415 Brass 5-gang

Length: 3 1/2" (88.9mm).

### Plastic base

Breakable into various pole configurations. High performance molded plastic base. Up to 12-gang. For applications up to 48V.

#### 4650 Series with blade terminals

With tin-plated brass terminals. 20A per pole. 2.00" (50.8mm) wide (terminal tip to terminal tip), .56" (14.2mm) high. Mounting holes .62" (15.8mm) on centers. Available as 4650-04, 4650-04BP BP, 4650-08, and 4650-12.



#### 4651 Series with screw terminals

Same as 4650, but with screw terminals. Available as 4651-04, 4651-04BP BP, 4651-08, and 4651-12.

### Common Hot Feed

Fiber base, 2.24" (56.9mm) wide, with 11/64" (4.4mm) diameter mounting holes. Solid brass busbar, phosphor-bronze fuse clips. Height: 5/8" (15.9mm). Brass terminals and screws.



#### M-414-01 brass 4-gang BP

Length: 2 3/4" (98.5mm).

#### M-415-01 brass 5-gang

Length: 3 1/2" (88.9mm).

Also available with steel terminals and screws: 4625-01.

#### M-641-01 brass 6-gang BP ★

Length: 4 1/4" (108.0mm).

Also available with steel terminals and screws: 4626-01.

#### M-643-01 brass 8-gang BP

Length: 5 3/4" (146.1mm).

#### M-645-01 brass 10-gang

Length: 7 1/4" (184.2mm).

#### M-647-01 brass 12-gang

Length: 8 3/4" (222.3mm).

TERMINAL BLOCKS P3

★ Rapid ship item. BP Available in retail clamshell pack. ★ Minimum order quantity may apply.

## Terminal Blocks, Individual Feed

Moisture-repellent molded Bakelite insulator base with barrier strips. Nickel-plated brass terminal links and 8-32 binding head screws. Width: 1.31" (33.3mm), height: .67" (17.0mm).

### M-426 4-gang BP ★

Length: 3.22" (81.8mm).  
Paired mounting holes  
2.81" (71.4mm) on centers.



### M-427 6-gang BP ★

Length: 4.33" (110.1mm). Paired mounting holes 3.93" (99.9mm) on centers.

### M-428 8-gang BP ★



Length: 5.46" (138.7mm). Paired mounting holes 5.06" (128.5mm) on centers.

### M-429 10-gang BP ★

Length: 6.59" (167.4mm). Paired mounting holes 6.19" (157.2mm) on centers.

### M-456 14-gang

Length: 8.84" (224.5mm). Paired mounting holes 8.44" (214.4mm) on centers.

## With Stud Terminals

### Square end pattern

10-32 thread stud terminals with hexnuts, flat washers and lockwashers. Two eyelet mounting holes for 3/16" (4.8mm) screws (screws not included). Moisture-repellent phenolic insulator base. 5/8" (15.9mm) wide x 27/32" (21.4mm) high.

### 4721-P2 2-gang



Length: 2.62" (66.5mm). Eyelets are 1.87" (47.5mm) on centers.

### 4721-P3 3-gang

Length: 3.25" (82.6mm). Eyelets are 2.50" (63.5mm) on centers.

### 4721-P4 4-gang

Length: 3.87" (98.3mm). Eyelets are 3.12" (79.2mm) on centers.

### 4721-P5 5-gang

Length: 4.5" (114.3mm). Eyelets are 3.75" (95.3mm) on centers.

### 4721-P6 6-gang ★

Length: 5.12" (130.0mm). Eyelets are 4.38" (111.3mm) on centers.

### 4721-P8 8-gang ★



Length: 6.37" (161.8mm). Eyelets are 5.62" (142.7mm) on centers.

### 4721-P10 10-gang

Length: 7.62" (193.5mm). Eyelets are 6.87" (174.5mm) on centers.

### 4721-P12 12-gang

Length: 8.87" (225.3mm). Eyelets are 8.12" (206.2mm) on centers.

### 4721-P14 14-gang

Length: 10.12" (257.0mm). Eyelets are 9.37" (238.0mm) on centers.

### Round end pattern

10-24 thread stud terminals, hardware not included. Two mounting holes for 1/4" (6.3mm) screws (screws not included). Moisture-repellent molded insulator base with barrier strips. 5/8" (15.9mm) wide x 27/32" (21.4mm) high.

### 4758 4-gang



Length: 4.5" (114.4mm). Two mounting holes 3.75" (95.3mm) on centers.

### 4755 5-gang

Length: 5.25" (133.3mm). Two mounting holes 4.50" (114.3mm) on centers.

★ Rapid ship item. BP Available in retail clamshell pack. ★ Minimum order quantity may apply.

## Truck-trailer lighting pattern with stud identification

4744



Six-gang, with circuit identification printed in white lettering. Two mounting holes 5.25" (133.4mm) on centers. 10-24 thread stud terminals, with hexnuts. 4 7/8"L x 1 3/16"W x 3/4"H (149.2 x 38.1 x 19.1mm).

## Terminal Blocks, Common Busbar

### With one busbar

Available in solid brass or tin-plated solid brass.

M-449 10-gang BP ★



Solid brass busbar safely carries up to 150A. Two 1/4-20 brass studs with hexnuts. 8-32 round head screws for attachment of wires. Two mounting holes accept No.10 countersink flat-head screws. Moisture-resistant molded thermoplastic insulator base. 5 3/4"L x 1 1/4"W x 1 1/32"H (146.0 x 31.7 x 26.1mm). Two mounting holes 5.19" (131.8mm) on centers.

M-448 20-gang

Same as M-449, but with 20 outlets. Length: 8 7/8" (225.4mm). Two mounting holes 8.31" (211.1mm) on centers.

M-449-04 10-gang, tin-plated brass BP

Same as M-449, but all brass is tinned for corrosion-resistance.

M-448-02 20-gang, tin-plated brass



Same as M-448, but all brass is tinned for corrosion-resistance.

46206-04 BP ★



4-gang, with solid brass busbar. 10-32 stud terminals with hexnuts and lockwashers. Two eyelets for mounting with 3/16" (4.76mm) screws (not included). Eyelets are 3.125" (79.4mm) on centers. Moisture-repellent thermoset plastic insulator base. 3 7/8"L x 5/8"W x 27/32"H (44.4 x 15.9 x 21.4mm).

### With two busbars

Two solid brass busbars, hard fiber insulator base, 8-32 screws. Width: 2.25" (57.2mm), height: 3/8" (9.5mm). Mounting holes .75" (19.1mm) on centers.

M-649-04 4-gang BP



2.75" long (98.5mm).

M-649-06 6-gang BP

4.25" long (108.0mm).

M-649-08 8-gang BP

5.75" long (146mm).

Part number suffixes indicate the amperage, eg: AGC98113-10 is a 10A glass fuse. Note that all fuses have a 3-letter prefix to match industry standards. Circuit breakers and fuses are a cost-effective solution to protecting wiring, equipment and subsystems. Essentially, fuses are a one-time, disposable solution. Circuit breakers can be re-used after overload.

#### ATM98107 Mini Blade Fuse



Fast-acting type. Available in 5, 10, 15, 20, 25, 30A and 10, 15, 20, 30A **BP**.  
Order Nos. ATM98107-10 or ATM98107-10BP etc.

#### ATC98108 Blade Fuse



Available in 5, 10, 15, 20, 25, 30, 40A and 10, 15, 20, 30A **BP**.  
Order Nos. ATC98108-20 or ATC98108-20BP etc.

#### MAX98111 Maxi Blade Fuse



Available in 20, 30, 40, 50A and 20, 30, 40A **BP**.  
Order Nos. MAX98111-20 or MAX981011-20BP etc.

#### AGC98113 Glass Fuse



Available in 1/4, 1/2, 3/4, 1, 1 1/2, 2, 3, 4, 5, 6, 7, 8, 9, 10, 15, 20, 30, 40A and 1/4, 1/2, 1, 3, 4, 5, 7, 10, 20A **BP**.  
Order Nos. AGC98113-20 or AGC98108-20BP etc.  
For ordering, fractional amperages: -001 is 1/4 A, -002 is 1/2 A, -003 is 3/4 A, and -012 is 1 1/2 A.

# circuit protection & wiring

## Quick-Connect Taps

Female molded plastic tap connector provides a fully insulated connection. Tap leg (see below) is disconnectable for added flexibility.

30244\* for 12AWG wire



Coded yellow. 25 per pack.

30243\* for 18-14AWG wires

Coded blue. 25 per pack.

30242\* for 22-18AWG wires

Coded red. 25 per pack.

#### 31729 Tap leg for 16-14AWG

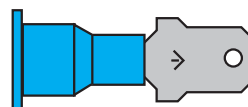

Male blade tap leg. Use with 30243 tap. Coded blue. 50 per pack.

#### 31728 Tap leg for 22-18AWG

Male blade tap leg. Use with 30242 tap. Coded red. 50 per pack.

## 30223 Quick-Tap Splicer and Tap BP



Use Quick-Tap to connect two wires or create a tap without stripping the wires. Two wires can be connected in-line or as a pigtail. Consists of a small molded plastic hinge unit. Insert the wires, close and snap shut with pliers. Fully insulated to prevent short circuits. Splicing instructions are included. 10 per pack.

## quick-tap wire splicer

### No need to strip the wire!

#### To make a Tap Splice

With the splicer open:  
Press the existing circuit wire (red wire in the picture) into the outer channel.  
Press the tap wire (yellow) into the inner channel.  
Snap the splicer cover into place.  
Squeeze with pliers.



#### To make an Inline Splice

With the splicer open:  
Press one wire (yellow) into the outer channel.  
Press the other wire (red) into the inner channel.  
Snap the splicer cover into place.  
Squeeze with pliers.



#### To make a Pigtail Splice

With the splicer open:  
Press one wire (red) into the outer channel.  
Press the other wire (yellow) into the inner channel.  
Snap the splicer cover into place.  
Squeeze with pliers.



## 30245 Quick-Connect Bullet Socket



Mates with bullet terminals (31731 and 31739). Self-stripping connector provides fast and easy connect and disconnect for many vehicle applications, including vehicle to trailer connections. For 18AWG to 14AWG wires. 20 per pack.

## Bullet terminals

For use with 3025. 50 per pack.

31731\* 16-14AWG. Blue

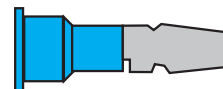

31739\* 22-18AWG. Red

## Inline Fuse/Breaker Holders

Protect circuits and equipment from damaging overloads.

30183 Mini Fuse Holder BP



Accepts Mini Fuses, or breakers 2-30A. Body material withstands high temperatures. Up to 32V at 30A.

30186 Maxi Fuse Holder



Accepts Maxi Fuses, or breakers 2-30A. Up to 32V at 30A.

CONTINUED P5



## Inline Fuse/Breaker Holders

Protect circuits and equipment from damaging overloads.

30147 for ATC/ATO Type **BP**



Accepts ATO and ATC fuses and circuit breakers from 3A to 20A. Easy to install and easy to change the fuse. 16AWG insulated copper wire leads, 4" (101.6mm) long. Brass contacts. Supplied without a fuse.

3031 for glass fuses



Accepts SFE fuses through 20A and 3AG (AGC) fuses through 30A. Positive twist-lock seal will not open accidentally; large brass contacts maintain solid contact with the fuse for maximum efficiency. 14AWG wire leads, 8" (203.2mm) long. Brass contacts. To install, cut wire loop.

3031-0 without fuse **BP** ★

3031-4\* with 4A fuse

3031-9\* with 9A fuse

3031-14 with 14A fuse

3031-20 with 20A fuse **BP** ★

3031-30 with 30A fuse

## Connectors with Quick-Connect Terminals

For fast wiring installation on vehicles and equipment. Molded insulators are made of durable, flexible polypropylene, which provides excellent resistance to moisture, chemicals and abrasion. Brass quick-connect terminals. Packaged 100 pieces per box.

### One Pole, single body connector

30200\* Insulator

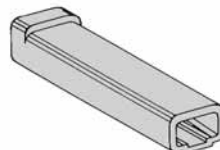

31102\* Male terminal for 14-16AWG wire

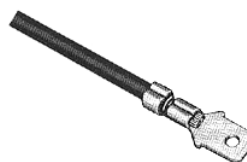

31103 Female terminal for 14-16AWG wire

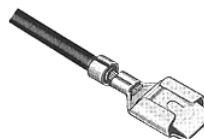

### One Pole, two-piece connector

30201\* Male insulator

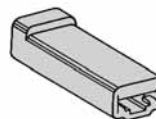

Receives one female terminal.

30202\* Female insulator

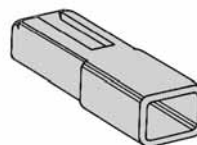

★ Rapid ship item. **BP** Available in retail clamshell pack. ★ Minimum order quantity may apply.

31100 Female terminal for 14-16AWG wire



31595-A Male terminal for 14-16AWG wire



## Two Pole, two-piece

30204 Female insulator

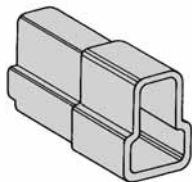

Receives two male terminals 31595-A.

## Three Pole, two-piece

30205\* Male insulator

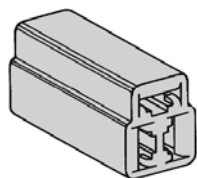

Receives three female terminals 31100.

30206\* Female insulator

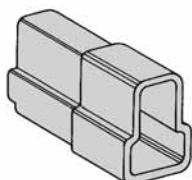

Receives three male terminals 31595-A.

## Bullet Terminals

*Brass. Terminals are packed 100 per box.*

3050 male, for 14-16AWG wire



3055\* male, for 14-16AWG wire



3125\* female, for 14-16AWG wire



3056\* male, for 12AWG wire



3013 Dual female bullet connector



For bullet terminals. Packed 25 per box. Bakelite. Mates with 3055 and 3056 bullet terminals. Connects three wires, one wire common to two leads.

## Insulated Terminals and Connectors

*For use with crimping tool. Tin-plated copper for resistance to corrosion and maximum conductivity. Vinyl insulator has ridge for positioning of crimping tool, and is flared for easy insertion of wire. Color-coded by wire size:*

22-18AWG wire: red  
16-14AWG wire: blue  
12-10AWG wire: yellow

## Ring Terminals

*Terminals are packed 100 per box.*

31302\* for 22-18AWG wire, stud size 8. Red

31304\* for 22-18AWG wire, stud size 10. Red

31301\* for 16-14AWG wire, stud size 6. Blue

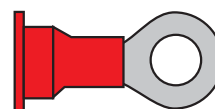

CONTINUED P5

★ Rapid ship item. BP Available in retail clamshell pack. ★ Minimum order quantity may apply.

31305\* for 16-14AWG wire, stud size 10. Blue

31732\* for 12-10AWG wire, stud size 6. Yellow

31734\* for 12-10AWG wire, stud size 10. Yellow

### Snap-on Spade Terminals

*Terminals are packed 100 per box.*

31322\* for 22-18AWG wire, stud size 8. Red

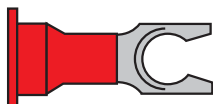

31324\* for 22-18AWG wire, stud size 10. Red

31321\* for 16-14AWG wire, stud size 6. Blue

31323\* for 16-14AWG wire, stud size 8. Blue

31325\* for 16-14AWG wire, stud size 10. Blue

31735\* for 12-10AWG wire, stud size 6. Yellow

31736\* for 12-10AWG wire, stud size 8. Yellow

31737\* for 12-10AWG wire, stud size 10. Yellow

### Female Blade Terminals

*Terminals are packed 100 per box.*

*Blade width .250" (6.4mm).*

31340\* for 22-18AWG wire. Red

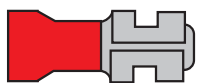

31341\* for 22-18AWG wire. Red

31738\* for 12-10AWG wire. Yellow

### Butt Connectors

*For efficient two-wire connections.*

*Blade width: 1.00" (25.4mm). Packed 50 per box.*

30238 for 12-10AWG wire. Yellow



30220\* for 16-14AWG wire. Blue

30219\* for 22-18AWG wire. Red

30240 Moisture-Resistant Butt Connectors. Blue



Weather-resistant connections can be made easily without a heat source or additional protective material. For 16-14AWG.

### Special Purpose Connectors

3032 Flasher Connector



Accepts standard 3-prong flasher units (not included). Molded plastic connector has 14AWG wire leads, with phosphor-bronze contacts. Comes with plated steel bracket that has two .203" (5.2mm) diameter mounting holes.

4028 Headlight Harness



For Chevrolet and GMC RVs. Accepts one 3-prong headlamp and one 2-prong headlamp. This harness attaches to a 3-pole Packard connector that is supplied with the vehicle chassis. Leads are 16AWG wire that connects into silvered bronze contacts in molded plastic connectors.

## Sealed Beam Connectors & Parts

Accepts sealed-beam headlamp terminals. 8" (203.0mm)  
14AWG thermoplastic wire leads with plated bronze contacts.

3029 Connector with 3 leads **BP**



3051 Connector with 2 leads

3028-1 Receptacle



Molded plastic connector/insulator accepts 3028-2 contacts.

3028-02 Receptacle with contacts

Molded plastic connector/insulator with 3028-2 contacts.  
Without wire leads, supplied unassembled.

3028-2 Contacts

Plated bronze contacts which fit 3028-1, 3028-02, 3029, 3051.

## Dimmer Switch Connectors

30155



Fits Cole Hersee foot switch 7762.  
Ford trucks 60-87, Dodge trucks 59-86.

30156



Fits Cole Hersee switches 7702 and 7776  
Trucks: Autocar 68-80, Chevrolet 61-86, GMC 69-86,  
International 61-80, Freightliner 63-67, 72-80,  
Kenworth 65-67, 72-74, 77-80.

# circuit protection & wiring

## Spring Clip

3118 **BP**



Teeth hold the clip in place after it is snapped over material up to 3/16" thick (4.8mm). Plated for corrosion resistance. 1/2" wide, 1 1/2" long (12.7 x 38.1mm).

## Nylon Cable Ties

31117 4" length (101.6mm)



For securing and positioning cables, wires and tubing. Self-locking design holds securely. Packed 50 ties per box.

31118 5 1/2" length (139.7mm)

31119 7 1/2" length (190.5mm)

## Steel Clamps

### Plastic-coated clamps

Plastic-coated for corrosion protection. Mounting hole diameter .281" (7.13mm) unless noted.

31230 .187" ID, .281" hole



.187" inside diameter (4.74mm).

31231 .281" ID, .281" hole

.281" inside diameter (7.13mm).

31232 .312" ID, .281" hole

.312" inside diameter (7.92mm).

CONTINUED **P6**

**31233** .437" ID, .281" hole  
.437" inside diameter (11.09mm).

**31234** .562" ID, .281" hole  
.562" inside diameter (14.27mm).

**31235** .750" ID, .250" hole  
.750" inside diameter (19.05mm),  
mounting hole diameter .250" (6.35mm).

**31236** .875" ID, .281" hole  
.875" inside diameter (22.22mm).

**31237** 1.187" ID, .343 hole  
1.187" inside diameter (30.14mm),  
mounting hole diameter .343" (8.71mm).

## Steel Clamps

*Plated for corrosion resistance.*

**31017\*** 7/16" ID

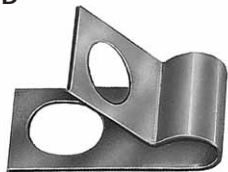

7/16" inside diameter (11.1mm),  
mounting hole diameter 13/32" (10.2mm).

**31018\*** 9/16" ID  
9/16" inside diameter (14.3mm),  
mounting hole diameter 9/32" (7.1mm).

**31019\*** 9/16" ID  
9/16" inside diameter (14.3mm),  
mounting hole diameter 1/4" (6.4mm).

## Nylon Clamps

*Inside edges are beveled to protect harnesses from chafing.  
Mounting hole diameter .167" (4.3mm) unless stated.*

**31240** 3/16" ID **BP**



3/16" inside diameter (4.8mm).

**31241** 1/4" ID **BP**  
1/4" inside diameter (6.4mm).

**31242** 5/16" ID **BP**  
5/16" inside diameter (8.0mm).

**31243** 3/8" ID  
3/8" inside diameter (9.52mm).

**31244** 1/2" ID **BP**  
1/2" inside diameter (12.7mm).

**31245** 5/8" ID **BP**  
5/8" inside diameter (15.9mm).  
Mounting hole diameter .203" (5.2mm).

**31246** 3/4" ID **BP**  
3/4" inside diameter (19.1mm).  
Mounting hole diameter .203" (5.2mm).

## Steel Cleats

### PVC coated

*Plastic coated for corrosion resistance.*

**31200\*** 1/4" ID



1/4" inside diameter (6.4mm),  
mounting hole diameter 13/64" (5.2mm).

**31201\*** 3/8" ID  
3/8" inside diameter (9.5mm),  
mounting hole diameter 13/64" (5.2mm).

**31202\*** 1/2" ID  
1/4" inside diameter (12.7mm),  
mounting hole diameter 13/64" (5.2mm).

**31203\*** 5/8" ID  
5/8" inside diameter (15.9mm),  
mounting hole diameter 17/64" (6.7mm).

**31204\*** 3/4" ID  
3/4" inside diameter (19.1mm),  
mounting hole diameter 17/64" (6.7mm).

**31205** 1" ID  
1" inside diameter (25.40mm),  
mounting hole diameter 17/64" (6.7mm).

★ Rapid ship item. **BP** Available in retail clamshell pack. ★ Minimum order quantity may apply.

## Plated steel

3160\* 1/4" ID



1/4" inside diameter (6.4mm),  
mounting hole diameter 13/64" (5.2mm).

3161 3/8" ID

3/8" inside diameter (9.5mm),  
mounting hole diameter 13/64" (5.2mm).

3162\* 1/2" ID

1/2" inside diameter (12.7mm),  
mounting hole diameter 13/64" (5.2mm).

3163\* 5/8" ID

5/8" inside diameter (15.9mm),  
mounting hole diameter 17/64" (6.7mm).

3164\* 3/4" ID

3/4" inside diameter (19.1mm),  
mounting hole diameter 17/64" (6.7mm).

# circuit protection & wiring

## Fuse & Breaker Tool

*Handy pocket-sized plastic tool makes extraction easy. Use with plug-in breakers and fuses, and glass fuses.*

30184 For fuses **BP**



30185 For fuses and breakers



## Breaker mounting brackets – steel

*For all steel case breakers without a bracket. Breakers snap into position, engaging with dimples in the case of the breaker. Heavy gauge steel. Brackets up to 12-gang are available. Contact Cole Hersee.*

30090-2, 2-gang



4.81" x 1.29" (122.2 x 32.8mm). Mounting hole 4.00" (101.6mm) on centers.

30090-3, 3-gang

5.71" x 1.29" (145.0 x 32.8mm). Mounting hole 4.90" (124.5mm) on centers.

30090-4, 4-gang

6.62" x 1.29" (160.1 x 32.8mm). Mounting hole 5.81" (147.6mm) on centers.

30090-6, 6-gang

8.43" x 1.29" (214.1 x 32.8mm). Mounting hole 7.62" (193.5mm) on centers.

30090-7\*, 7-gang

9.34" x 1.29" (237.2 x 32.8mm). Mounting hole 8.53" (216.7mm) on centers.

30090-8, 8-gang

10.25" x 1.29" (260.4 x 32.8mm). Mounting hole 9.43" (239.5mm) on centers.

CONTINUED **P7**

**Breaker mounting brackets – nylon**

For use with Cole Hersee 30056 series and 30137 series breakers. Durable, lightweight molded nylon. Breakers mount securely using stud and hexnut. Mounting holes .280" x .440" (7.1 x 11.2mm). Slots are .910" (23.1mm) on centers, and .210" (5.3mm) wide.

**87128-4, 4-gang** ★

5.69" long (114.5mm),  
mounting holes 4.89" (124.2mm) on centers.

**87128-5\*, 5-gang**

6.60" long (167.6mm),  
mounting holes 5.80" (147.3mm) on centers.

**87128-6, 6-gang**

7.51" long (190.8mm),  
mounting holes 6.71" (170.4mm) on centers.

**87128-7\*, 7-gang**

8.42" long (213.9mm),  
mounting holes 7.62" (193.5mm) on centers.

**87128-8, 8-gang**

9.33" long (237.0mm),  
mounting holes 8.53" (216.7mm) on centers.

**87128-9\*, 9-gang**

10.24" long (260.1mm),  
mounting holes 9.44" (239.8mm) on centers.

**87128-10, 10-gang**

11.15" long (233.2mm),  
mounting holes 10.35" (262.9mm) on centers.

**87128-12\*, 12-gang**

12.97" long (329.4mm),  
mounting holes 11.26" (268.0mm) on centers.

**87128-13\*, 13-gang**

13.88" long (352.6mm),  
mounting holes 13.08" (332.2mm) on centers.

**Busbars**

For connecting circuit breakers to provide higher amperage ratings. Holes/slots are .910" (23.1mm) on centers. Hole size: .210" (5.3mm).

**86046\*, 2-gang, plated steel**

Same style as brass busbars 86099.

**Brass Busbars****86099-2, 2-gang****86099-3, 3-gang****86099-4, 4-gang****86099-5, 5-gang****Copper Busbars**

Slotted. Recommended for use with nylon mounting brackets 87128. Slots are .910" on centers. Slot width: .210" (5.3mm). Width of bar: .560" (14.2mm).

**86126-2, 2-gang**

1.41" L (35.81mm).

**86126-3\*, 3-gang**

2.32" L (58.4mm).

**86126-4, 4-gang**

3.23" L (82.1mm).

**86126-5\*, 5-gang**

4.14" L (105.2mm).

**86126-6, 6-gang**

5.05" L (128.3mm).

**86126-8, 8-gang**

6.87" L (174.5mm).

**86126-9, 9-gang**

7.78" L (197.6mm).

**86126-10\*, 10-gang**

8.69" L (220.7mm).

**86126-12, 12-gang**

10.51" L (267.0mm).

★ Rapid ship item. BP Available in retail clamshell pack. ★ Minimum order quantity may apply.

# warning devices, pilot lights, panel lamps & sockets



N

|                            |    |
|----------------------------|----|
| WARNING DEVICES            | N1 |
| HEAVY-DUTY PILOT LIGHTS    | N2 |
| MARINE PILOT LIGHTS        | N3 |
| HOODED PANEL LAMPS         | N4 |
| LAMP SOCKETS & ACCESSORIES | N5 |

## warning devices, pilot lights, panel lamps, sockets

### N1 WARNING DEVICES

#### Buzzers & Alarms

##### 4099 Universal Buzzer 12V DC **BP** ★



Hundreds of uses. For 'door ajar' warning, bus driver alert, low air pressure, temperature, etc. Works with any temperature, pressure, door or momentary switch. Electrical contacts are designed for instant response and uninterrupted signal.

Impact-resistant ABS resin case. Moisture-repellent insulator. Two screw terminals with lockwashers. Size: 1 7/32"L x 2 1/2"W x 2 17/32"H (30.9 x 63.2 x 64.3mm).

Replaces: Ford FDM-2938-A, GMC 1116882, Superior Coach 76032, Divco-Wayne E-11811-A.

##### 4098\* 6V Buzzer

Same as 4099, but for 6V DC systems.  
Replaces: Ford IC-18736-A2, Superior Coach 76022, Divco-Wayne E-11809A.

##### 40151 24V Buzzer

Same as 4099, but for 24V DC systems.

##### 40100 Buzzer Pull Switch ★



Attaches to a cord. For use by passengers in buses and rapid transit vehicles. Extra heavy duty construction. Use with Cole Hersee buzzers or buzzer/flashers: 4099, 4112 RC, 4124-RD. SPST Off-Mom. On. Normally Off, pull to On, spring return to Off. For use with systems up to 36V DC. Two screw terminals. Neutral gray enamel finish cover. Operates with a pull cord.

Replaces: Delco 1998723, 18998802, 1998020.

##### 4112-RC Buzzer/LED Pilot Light "Dual Alarm" **BP** ★



Rugged combination warning light and buzzer give audible and visible alert. Universal application: use with any electrical switch. Red lens, long-life LED. 1 1/16" (17.46mm) diameter mounting stem, 17/32" (13.88mm) long. Body size: 1 7/8"L x 1"W x 1 11/32"H ( 47.6 x 25.4 x 34.1mm). Wiring instructions provided. 12V DC. Also available as 24V. Item No. 4124-RD.

CONTINUED **N1**

★ Rapid ship item. **BP** Available in retail clamshell pack. \*Minimum order quantity may apply.



**N1** WARNING DEVICES

**M-40177BP Marine Engine Warning Kit** BP



For inboard and outboard engines with 12V DC electrical system. Handy kit includes buzzer 4099, temperature switch 84251, see Section M1, and pressure switch 8606, see Section M3. Alarm sounds when oil pressure is too low and/or engine coolant temperature is too high. Installation instructions included.

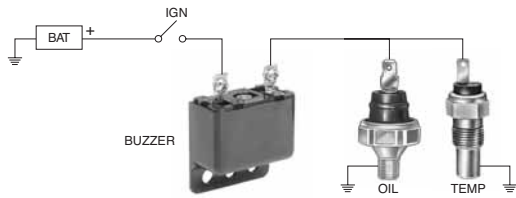

**40212 Dual Rate Electronic Alarm 12V DC** ★



Utilizes advanced integrated circuit surface mount technology. Negative ground. Use with two input sources to warn of two different hazardous conditions. Sounds at two different rates: one sensor triggers a fast-rate alarm, the second actuates a slower rate alarm tone.

Minimum sound level: 90dB. Lightweight molded plastic housing. Solid-state circuitry. Size: 2.005"L x 1.185"W x .930"H (50.4 x 30.3 x 23.6mm). Plugs into Cole Hersee Sealed Beam Connector 3032 or 3029, Delphi (Packard) 12033871, or accepts individual connectors for 1/4" (6.4mm) blades.

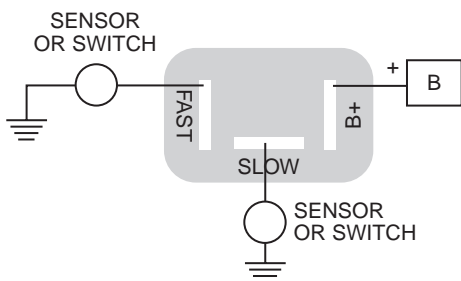

**Flashers**

**3034 motor-driven light alternating flasher**

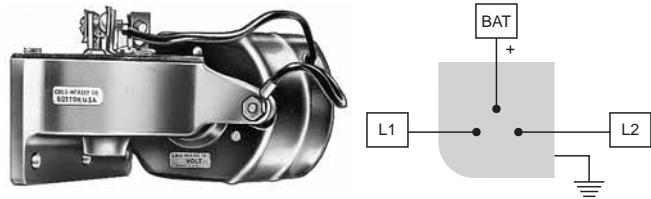

Heavy duty. 12V DC. Specially designed for school buses, sanding trucks, snowplows, fire, police, ambulance and other emergency vehicles. Alternate left and right flashing of one or more lights at a required number of cycles per minute. Cycling of flasher is constant, and not controlled or varied by the load. Performance tested by Electrical Testing Laboratory for three million cycles. Exceeds state regulations. Can be used as a regular flasher when only one load is used. Available also in 6V (3033) & 24V DC (30024) – contact Cole Hersee.

**6001 flasher repair kit**

Repair kit for 3034. Includes all non-motor parts.

**3261-01 Low Air Pressure Flasher Kit**



Lamp flashes when pressure switch triggers at 60+10 psi (413+69kPa). Includes heavy duty Air Pressure Switch 8640 (has 1/4-18 NPTF thread). Aluminum faceplate with red enamel finish, 2.94"W x 2.09"H (74.7 x 52.1mm). Pilot light with flashing bulb. Two 16AWG wire leads, one 18" (457.2mm) and one 8" (203.0mm). Installation instructions included.

**91052 Emergency Relay**

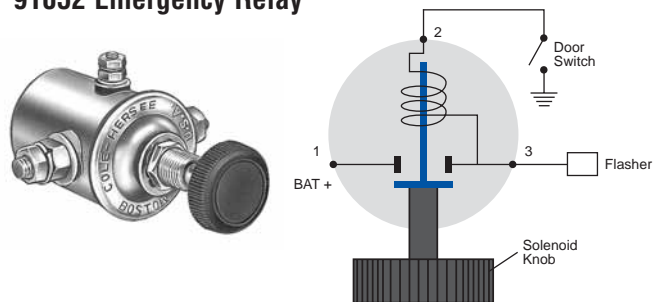

Manually-operated solenoid designed for school buses, to be used with 91050 momentary door switch to operate both amber and red flashing lights (for states where such a system is required). Normally Off. 12V DC. Copper contacts, plated steel housing. Copper terminals: large – 5/16" -24 thread, small – 10-32 thread. Brass mounting stem. 1/2" -20 thread, 5/8" (15.9mm) long for panel mounting. See Section G7 for 91050 specifications.

★ Rapid ship item. BP Available in retail clamshell pack. ★ Minimum order quantity may apply.

## N2 HEAVY-DUTY PILOT LIGHTS

**Incandescent Pilot Lights**

*Corrosion-resistant construction. Spring-actuated brass contacts assure proper contact with the bulb. 16AWG (1.0mm<sup>2</sup>) insulated stranded copper leads, 8" (203mm) long. Many items are available with custom imprinting: contact Cole Hersee*

**Single Contact, Insulated****Smooth Lens**

*Plastic socket.*

**PL-6-RC with small 5/16" lens, chrome bezel**

Red lens. Chrome-plated brass bezel, 7/8" (22.2mm) diameter. 3/4" (19.1mm) diameter mounting stem, 11/16" (17.5mm) long, 3/4-32 UN-2A. 5/16" (7.9mm) diameter lens. 12V #56 bulb supplied.

**PL-2 Series with small 3/16" lens**

12V #53 bulb supplied. 3/16" (4.76mm) diameter lens. 5/16" (7.9mm) diameter mounting stem, 3/8" (9.5mm) long. Plated brass bezel, satin finish, 1/2" (12.7mm) diameter.

**PL-2-AC\* amber lens****PL-2-BC blue lens****PL-2-GC green lens****PL-2-RC red lens****PL-118 Series, rear mounting**

Mount through rear of the panel. Satin finish or black aluminum bezel, 15/16" (23.8mm) diameter. 12V #1893 bulb supplied. 5/8" (15.9mm) diameter lens. 11/16" (7.5mm) diameter mounting stem, 1/4" (6.4mm) long. Available with custom imprinting: contact Cole Hersee.

**PL-118-AC satin bezel, amber lens****PL-118-GC satin bezel, green lens****PL-118-RC satin bezel, red lens****PL-118-AC001 black bezel, amber lens****PL-118-GC001 black bezel, green lens****PL-118-RC001 black bezel, red lens****24 volt**

All incandescent pilot lights are supplied with a 12V bulb. To convert to 24V use, replace the supplied bulb with a 24V bulb. Cole Hersee can provide pilot lights with 24V bulbs – contact us.

CONTINUED **N2**

**PL-116 Series, front mounting**

Mount from the front of the panel, fasten from the back. Satin finish or black aluminum bezel, 15/16" (23.8mm) diameter. 12V #1893 bulb supplied. 5/8" (15.9mm) diameter lens. 3/4" (19.1mm) diameter mounting stem, 3/8" (9.5mm) long. Available with custom imprinting: contact Cole Hersee.

**PL-116-AC\*** satin bezel, amber lens

**PL-116-BC\*** satin bezel, blue lens

**PL-116-GC** satin bezel, green lens

**PL-116-RC** satin bezel, red lens

**PL-116-GC001\*** black bezel, green lens

**PL-116-RC001** black bezel, red lens

**PL-20 Series with extra wire for ground**

12V #53 bulb supplied. 17/32" (13.5mm) diameter lens. 3/4" (19.1mm) diameter mounting stem, 11/16" (17.5mm) long. Chrome-plated brass bezel, 7/8" (22.2) diameter. Available with custom imprinting: contact Cole Hersee.

**PL-20-AC** amber lens

**PL-20-BC\*** blue lens

**PL-20-GC** green lens

**PL-20-RC** red lens ★

**PL-20-RC033** red lens, 'Oil' imprint

**PL-20-RC032\*** red lens, 'Low' imprint

**Faceted Lens****PL-36 Series with honeycomb lens, stainless bezel**

Lenses have honeycomb pattern on the internal side, smooth on the outside. Satin finish stainless steel bezel, 3/4" (19.1mm) diameter. 1/2" (12.7mm) diameter mounting stem, 3/8" (9.5mm) long. 5/16" (8.0mm) diameter lenses. 12V #53 bulb supplied.

**PL-36-AC** amber lens

**PL-36-BC** blue lens

**PL-36-GC** green lens

**PL-36-RC** red lens

**Single Contact, Grounding**

*Self-grounding to metal panels.*

**Smooth Lens****PL-1 Series with small 3/16" lens, chrome bezel**

12V #53 bulb supplied. 3/16" (4.8mm) diameter lens. 5/16" (7.9mm) diameter mounting stem, 3/8" (9.5mm) long. Chrome-plated brass bezel, satin finish, 1/2" (12.7mm) diameter.

**PL-1-BC** blue lens

**PL-1-GC** green lens

**PL-1-RC** red lens

**PL-5-RC with small 5/16" lens, chrome bezel**

Red lens. Chrome-plated brass bezel, 7/8" (22.2mm) diameter. 3/4" (19.1mm) diameter mounting stem, 11/16" (17.5mm) long. 5/16" (7.9mm) diameter lens. 12V #53 bulb supplied.

★ Rapid ship item. BP Available in retail clamshell pack. \*Minimum order quantity may apply.

## N2 HEAVY-DUTY PILOT LIGHTS

### PL-19 Series with chrome bezel



12V #53 bulb supplied. 17/32" (14.5mm) diameter lens. 3/4" (19.1mm) diameter mounting stem, 11/16" (17.5mm) long. Chrome-plated brass bezel, 7/8" (22.2mm) diameter. Available with custom imprinting: contact Cole Hersee.

#### PL-19-AC amber lens

#### PL-19-BC blue lens

#### PL-19-GC green lens

#### PL-19-RC red lens

#### PL-19-RC013\* 'Low' imprint

### PL-117 Series with extended snap-in lens.

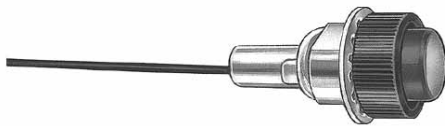

Mount through rear of the panel. Satin finish or black aluminum bezel, 15/16" (23.8mm) diameter. 12V #1893 bulb supplied. 5/8" (15.9mm) diameter lens. 11/16" (7.5mm) diameter mounting stem, 1/4" (6.4mm) long. Available with custom imprinting: contact Cole Hersee.

#### PL-117-RC red lens, satin bezel

#### PL-117-RC001 red lens, black bezel

### Faceted Lens

#### PL-85 Series



12V #67 bulb supplied. 15/16" (23.8mm) diameter lens, gasket-sealed. 7/8" (22.2mm) diameter mounting stem, 3/4" (19.1mm) long. Plated brass bezel, 1 1/4" (31.8mm) diameter. Faceted outer lens surface.

#### PL-85-AC amber lens

#### PL-85-BC\* blue lens

#### PL-85-GC green lens

#### PL-85-RC red lens

### PL-35-RC with honeycomb lens, stainless bezel



Red lens with honeycomb pattern on the internal side, smooth outer surface. Satin finish stainless steel bezel, 3/4" (19.1mm) diameter. 1/2" (12.7mm) diameter mounting stem, 3/8" (9.5mm) long. 12V #53 bulb supplied. 5/16" (8.0mm) diameter lenses.

### Double Contact

#### PL-86 Series large 15/16" lens



Insulated. 12V #68 bulb supplied. 15/16" (23.8mm) diameter faceted lens, gasket-sealed. 7/8" (22.2mm) diameter mounting stem, 3/4" (19.1mm) long. Plated brass bezel, 1 1/4" (31.8mm) diameter.

#### PL-86-AC amber lens

#### PL-86-BC blue lens

#### PL-86-GC green lens

#### PL-86-RC red lens

**N3 MARINE PILOT LIGHTS**

Marine construction. 16AWG (1.0mm<sup>2</sup>) insulated stranded copper leads, 8" (203mm) long. Many items are available with custom imprinting: contact Cole Hersee

**Single Contact**

*Plastic socket. Insulated*

**M-320 Series with smooth lens**

17/32" (13.5mm) diameter lens. Chrome-plated brass bezel, 7/8" (22.2mm) diameter. 3/4" (19.1mm) diameter mounting stem, 1 1/16" (27.0mm) long. 12V #53 bulb supplied. Available with custom imprinting: contact Cole Hersee.

**M-320-GC green lens****M-320-RC red lens** BP**M-328-RC with honeycomb lens**

Red lens, 5/8" (15.9mm) diameter with honeycomb pattern on the internal side. Satin finish stainless steel bezel, 3/4" (19.1mm) diameter. 1/2" (12.7mm) diameter mounting stem, 7/8" (22.2mm) long. 12V #53 bulb supplied.

**Double Contact**

*Metal socket.*

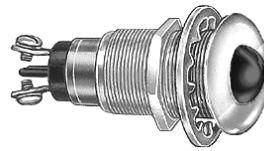
**PL-16 Series with smooth lens**

17/32" (13.5mm) diameter lens. Chrome-plated brass bezel, 1 1/8" (28.6mm) diameter. 7/8" (22.2mm) diameter mounting stem, 1 1/8" (28.6mm) long. 12V #68 bulb supplied. Moisture-repellent insulator. Available with custom imprinting: contact Cole Hersee.

**PL-16-AC amber lens****PL-16-GC green lens****PL-16-RC red lens****M-326 Series with faceted lens**

15/16" (23.8mm) diameter lens, gasket-sealed. Plated brass bezel, 1 1/4" (31.8mm) diameter. 7/8" (22.2mm) diameter mounting stem, 1 1/4" (31.8mm) long. 12V #68 bulb supplied. Moisture-repellent insulator.

**M-326-AC amber lens****M-326-GC\* green lens****M-326-RC red lens** BP

★ Rapid ship item. BP Available in retail clamshell pack. ★ Minimum order quantity may apply.

## N4 HOODED PANEL LAMPS

For illumination of maps or other items, with minimal interference of driving visibility. Hood can be rotated to direct the light beam (except DL-75-12V, which has a fixed hood). 16AWG (1.0mm<sup>2</sup>) insulated stranded copper leads, 8" (203mm) long, except where noted.

### Single Contact, Self-grounding Self-grounding in metal panels.



**DL-13 wide-aperture, chrome hood** BP  
Bright chrome-plated brass hood with wide aperture. Mount through the panel. 11/16" (17.5mm) diameter mounting stem, 3/8" (9.5mm) long. Accommodates single-contact bayonet bulb. Suggested lamps (not included): #63 (6V), #67 (12V), #623 (24V).

**DL-13-12V\***  
Same as DL-13, but with a 12V #67 bulb.

### DL-21 wide-aperture, black hood



Same as DL-13, but with black finish steel hood.

### DL-9 wide-aperture, flange mount, with switch



Bright chrome-plated brass hood with wide aperture. Flange mounting, with two 9/64" (3.6mm) diameter mounting holes, 1 3/16" (30.2mm) on centers. Bulb not included. Suggested lamps: #63 (6V), #67 (12V), #623 (24V). Integral On-Off switch in the stem.

### DL-3 small aperture

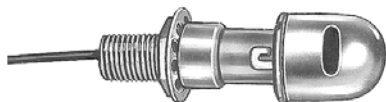

Bright chrome-plated brass hood with low illumination aperture. 3/8" (9.5mm) diameter mounting stem, 23/32" (18.3mm) long. Bulb not included. Suggested lamps: #51 (6V), #53 (12V), #356 (24V).

### Multi-purpose utility light with fixed hood

**DL-75-12V**



Snap-in mounting. Brass socket. One 18AWG (0.8mm) wire lead, 30" long (793mm), with blade terminal. Snaps into 1 1/4" (31.8mm) holes in panels .150" to .250" (3.8 to 6.4mm) thick. One spring prong is eliminated for indexing in keyed holes. Gasket-sealed lens and weatherproof sleeve. Frosted non-glare lens. Chrome-plated brass bezel/hood 1.52" (38.7mm) diameter. Supplied with 12V #67 bulb.

### Double Contact, Insulated Chrome-plated brass construction for exposed applications. M-458 through-panel mount



Bright chrome-plated brass hood. 11/16" (17.46mm) diameter mounting stem, 3/8" (9.5mm) long. Bulb not included: suggested lamps: #64 (6V), #68 (12V), #1252 (24V).

### M-451 flange mount, with switch BP



Bright chrome-plated brass hood. Flange mounting, with two 9/64" (3.6mm) diameter mounting holes, 1 3/16" (30.16mm) on centers. Two screw terminals. Integral On-Off switch in the stem. Bulb not included: suggested lamps: #64 (6V), #68 (12V), #1252 (24V).

## N5 LAMP SOCKETS &amp; ACCESSORIES

**Bayonet Base Sockets**

Sockets accept incandescent or LED bulbs with corresponding bases. 16AWG (1.0mm<sup>2</sup>) insulated stranded copper leads, 8" (203mm) long, except where noted.

**Single contact sockets accept BA15s base lamps.**

Suggested lamp numbers: 63, 67, 81, 87, 93, 97, 103, 209, 1073, 1129, 1133, 1141, 1156.

**Double contact sockets accept BA15d base lamps.**

Suggested lamp numbers: 64, 68, 82, 88, 90, 210, 1004, 1076, 1130, 1142, 1158, 1176, 1178.

**Double contact indexed sockets accept BA15z base lamps.**

Suggested lamp numbers: 1154, 1157, 1157A, 1157NA, 1534, 2057, 2057NA, 2357, 2357NA.

**Standard Base****Single Contact****26145**

For back-up, tail, stop, turn signal and cornering. Ground wire.

Replaces: GMC 8909518, International 57121C91, Motorcraft LS-22.

**Double Contact, indexed**

Indexed with J-slots.

**26152**

For back-up, marker, park, turn signal and cornering.

Replaces: GMC 8919916, 12013813.

**26146**

For tail, stop and turn signal. Accepts BAZ15d.

Replaces: Ford D0AZ, D1AZ, D20Z-13410B.

**26162**

For tail, stop, park and turn signal. Ground wire.

Replaces: AMC 3690736, 8124663, Chrysler 3588833, 3764123, Ford D4ZZ-13234A, D5VY-13410A, D3AZ-13410B.

**26144\***

For back-up, tail, stop, turn signal and cornering. Ground wire.

Replaces: GMC 8903202, 8914822, International 571722C91, Motorcraft LS-10.

**Wedge Base**

Accept lamp socket BA9 base lamps, lamp numbers 158, 161, 168, 194, 194A, 194NA (amber bulb).

**25104**

For side marker, tail, cornering and license plate.

Replaces: AMC 4489535, Ford D0DZ-15A434B, D4)Z-13410E, D5VY-15A442A, D7AZ, DD7FZ-13412A, E1FZ-13410A, GMC 6294015, 6298886, 6298892, 6298935, 8918527, International 4189977C91, Motorcraft LS-18.

**25106\***

For marker, stop, tail, turn signal, cornering and license plate.

Replaces: Ford E0SZ-15A442B, GMC 12001470.

**25102\***

For side marker and license plate.

Replaces: Chrysler 3588314, 3588650, Ford E25Y-13410B.

★ Rapid ship item. BP Available in retail clamshell pack. \*Minimum order quantity may apply.

## N5 LAMP SOCKETS & ACCESSORIES

**25103\***



For side marker, tail, turn signal and license plate.  
Replaces: Chrysler 3513686, 4055028.

### Nut & Lockwasher Mounting

*Screw terminals. 11/16" -32 mounting stem.  
Nut and lockwasher are included.*

**2106\* double contact**

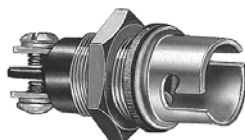

Socket accepts BA15d base bulb.

**2203 single contact**



Socket accepts BA15s base bulb.

**2013\* single contact**



Molded plastic insulator. Socket accepts BA15s base bulb.

**2014 double contact**

Molded plastic insulator. Same as 2013, except socket accepts BA15d base bulb.

**2319\* single contact**

Same as 2356, except socket accepts BA15s base bulb.

**2356\* double contact**



Socket accepts BA15d base bulb.

### With Flange

**2031\* single contact, rear mount**



Flange has two 9/64" (3.6mm) holes, 1 3/16" (30.2mm) on centers. Screw terminals, molded plastic insulator. Socket accepts BA15s base bulb.

**2035\* single contact, front mount**



Flange has two 9/64" (3.6mm) holes, 1 3/16" (30.2mm) on centers. Screw terminals, molded plastic insulator. Socket accepts BA15s base bulb.

**2097\* single contact, front mount**



Flange has two 9/64" (3.6mm) holes, 1 3/16" (30.2mm) on centers. Screw terminals, molded plastic insulator. Socket accepts BA15s base bulb.

**2098\* double contact, front mount**

Same as 2097, except double contact, and socket accepts BA15d base bulbs.

**26041\* single contact, wire lead, front mount**



Flange has two 3/16" (4.8mm) diameter holes 1 1/2" (38.1mm) on centers. Socket accepts BA15s base bulb.

**26042\* double contact, wire leads, front mount**

Same as 26041, but double contact, two wire leads. Socket accepts BA15d base bulb.

CONTINUED **N5**

★ Rapid ship item. **BP** Available in retail clamshell pack. ★ Minimum order quantity may apply.



**Without Flange****2645\* single contact**

43/64" (17.1mm) outside diameter. Socket accepts BA15s base bulb.

**2601\* single contact**

11/16" (17.5mm) outside diameter. Socket accepts BA15s base bulb.

**2602\* double contact**

Same as 2601, but double contact, two wire leads, and socket accepts BA15d base bulb.

**2006\* double contact**

11/16" (17.5mm) outside diameter. Screw terminals, molded plastic insulator. Socket accepts BA15d base bulb.

**2644\* double contact**

3/4" (19.0mm) outside diameter. Socket accepts BA15d base bulb.

**2316 double contact**

11/16" (17.5mm) outside diameter. Screw terminals. Can be used with 2911 brass sleeve for quicker socket assembly or replacement. Socket accepts BA15d base bulb.

**26114\* double contact, indexed**

Indexed J slots. 3/4" (19.0mm) outside diameter. 8" (203.0mm) wire leads. Socket accepts BAZ15d base bulb.

**26100 double contact, brass socket BP**

11/16" (17.5mm) outside diameter. Molded plastic insulator. Socket accepts BA15d base bulb.

**Snap-in Mounting**

*Plated steel, snap-in mounting sockets.*

**2611\* single contact**

Mounting fits 3/4" (19.0mm) diameter hole. Socket accepts BA15s base bulb.

**2612 double contact**

Mounting fits 3/4" (19.0mm) diameter hole. Socket accepts BA15d base bulb.

**26106\* double contact, indexed**

Indexed J slots. Mounting fits 3/4" (19.0mm) diameter hole. Molded plastic insulator. Socket accepts BAZ15d base bulb.

**2670\* double contact**

Mounting fits 7/8" (22.2mm) diameter hole. Socket accepts BA15d base bulb.

**26003\* single contact**

Mounting fits 7/8" (22.2mm) diameter hole. Socket accepts BA15s base bulb.

**26147\* single contact**

Same as 26003, except white ground wire is attached to the shell. Socket accepts BA15s base bulb.

★ Rapid ship item. BP Available in retail clamshell pack. ★ Minimum order quantity may apply.

## N5 LAMP SOCKETS & ACCESSORIES

### Bracket Mounting

*Plated steel.*

#### 2609 single contact, side bracket



Plated steel side bracket, with one 3/16" (4.8mm) hole. Socket accepts BA15s base bulb.

#### 2610 double contact, side bracket

Plated steel side bracket, with one 3/16" (4.8mm) hole. Socket accepts BA15d base bulb.

#### 3575 single contact, bottom bracket



Plated steel bottom bracket, with two 13/64" (5.2mm) holes, 1/2" (12.7mm) on centers. Socket accepts BA15s base bulb.

#### 2608\* double contact, bottom bracket



Plated steel bottom bracket, with one 10-32 hole. Socket accepts BA15d base bulb.

#### 2150\* double contact, clamp mount



Plated steel clamp. Screw terminals. Molded plastic insulator. Socket accepts BA15d base bulb.

### Miniature Base Sockets

*Plated steel sockets*

**Accept BA9 base lamps.**

*Suggested lamp numbers: 51 (6V), 53 (12V), 356 (24V).*

#### 2520\* single contact



7/16" (11.1mm) outside diameter. 8" (203.0mm) wire lead. Accepts BA9 base bulb.

### Snap-in mounting

*Single contact, snaps in to 5/8" (15.9mm) diameter hole. 8" (203.0mm) wire lead. Sockets accept BA9 base bulb.*

#### 2505



Also available: socket with spacer rings to fit other panel thicknesses. Consult Cole Hersee.

#### 2506



Ground lead is attached to the shell. Accepts BA9 base bulb.

### Bracket mounting

#### 2504\*



Side bracket mount, with one 9/64" (3.6mm) hole. 8" (203.0mm) wire lead. Accepts BA9 base bulb.

#### 2526\*



Same as 2504, but with a ground lead attached to the bracket. Accepts BA9 base bulb.

CONTINUED **N5**

★ Rapid ship item. BP Available in retail clamshell pack. ★ Minimum order quantity may apply.

## Prefocus Sockets

*Plated steel.*

### Single contact

*Accepts single contact prefocus P30s-10.3 base lamps.*

**2723-Y\*** with screw terminals



1 3/4" (22.45mm) outside diameter. Four 1/8" (3.2mm) holes, screw terminals.

**2721\*** with wire lead terminal



1 3/4" (44.4mm) outside diameter. Four 1/8" (3.2mm) holes. 8" (203.0mm) wire lead.

### Double contact

*Accepts double contact prefocus P30d-10.3 base lamps.*

**27018** with screw terminals



Unique configuration minimizes interference. 1 3/4" (44.4mm) outside diameter. Three 1/8" (3.2mm) holes, screw terminals.

**2702\*** with wire lead terminal, snap-in



Snap-in or press fit mounting. 1 5/16" (33.4mm) outside diameter. 8" (203.0mm) wire leads.

## Wedge Base Sockets

*Molded plastic shell, brass contacts. Twist lock into slotted hole. Accept lamp numbers 158, 161, 168, 192, 193, 193E, 194, 194A, 194NA (amber bulb).*

**25100** fits 1/2" hole



Fits 1/2" (12.7mm) diameter slotted hole.

**25101\*** fits 5/8" hole



Fits 5/8" (15.9mm) diameter slotted hole.

## lamp bases

Lamp bulbs are frequently classified by industry standard numbers (63, 103, 1156 etc.) which indicate the type of bulb.

Automotive-type bayonet base 15 (BA15) has other numbers to further characterize it: BAs refers to a single contact on the base of the socket (and bulb), and BA<sub>d</sub> refers to a double contact, with two projections on the lamp base. The Z (as in BAZ15d) refers to a special type in which the two bayonet projections on the base of the bulb are offset.

★ Rapid ship item. BP Available in retail clamshell pack. ★ Minimum order quantity may apply.

## N5 LAMP SOCKETS & ACCESSORIES

### Lamp Socket Accessories

#### 1624 Accessory Plug



Single contact. Permits the use of a 12V double wire circuit from a standard automotive accessory plug. .822" (20.9mm) diameter.

#### 3573 Boot



Protects wire connections for sockets with 11/16" (17.5mm) outside diameter.

#### 1465 Converter Plug



Converts double wire to single contact. .800" (15.2mm) diameter.

#### 1449\* GMC Lamp Socket Plug



For GMC vehicle tail lamps. Single contact. .800" (15.2mm) diameter.

### Pigtail assemblies

*Cole Hersee supplies pigtail assemblies for replacement and OEM applications. For different lead lengths, colors and materials, please contact Cole Hersee. Leads are made from high quality 16AWG (1.0mm<sup>2</sup>) thermoplastic jacketed wire. Phenolic washers insulate the assemblies.*

#### 2560 single contact



Fits the following sockets: 2601, 2609, 2611, 2645, 2670, 3575, 26003, 26041.

#### 2564 double contact, standard



Ears in line with contacts. Fits the following sockets: 2602, 2608, 2610, 2612, 26041.

#### 2561\* single contact miniature



Fits the following sockets: 2504, 2505, 2506, 2526, 2520.

★ Rapid ship item. BP Available in retail clamshell pack. ★ Minimum order quantity may apply.



# monitoring devices

M

|  |    |
|--|----|
| TEMPERATURE SWITCHES                   | M1 |
| TEMPERATURE SENDERS                    | M2 |
| OIL PRESSURE SWITCHES                  | M3 |
| OIL PRESSURE & ELECTRIC CHOKE SWITCHES | M4 |
| VACUUM SWITCHES                        | M5 |
| AIR PRESSURE SWITCHES                  | M6 |
| FUEL PUMP SWITCHES                     | M7 |

## monitoring devices

### M1 TEMPERATURE SWITCHES

All items are self-grounding, normally Off. Heavy duty, corrosion-resistant. Switches utilize PTF or NPTF dryseal thread which requires no sealant. Switches close a ground circuit to indicator lights or other warning devices that warn of a 'hot' or 'cold' condition. Cannot be used with gages. .250" blade (6.4mm) terminal except where noted.

#### For use with indicator light or buzzer

**84210**  
On at 239° to 271°F. 1/2" -14 thread.



1/2" -14 dryseal thread mounting stem (PTF-SAE short).  
Mounting hex flat 15/16". (115.0 – 132.8°C).

Replaces: Delco 1993426, 427, D-1879, GMC 6490970, 25036512, Motorcraft SWG-485.

**84218**  
On at 184° to 216°F. 1/2" -14 thread.



1/2" -14 dryseal thread mounting stem (PTF-SAE short).  
Mounting hex flat 15/16". (84.4 – 102.2°C).

**84227**  
On at 232° to 264°F. 1/2" -14 thread.



1/2" -14 dryseal thread mounting stem (PTF-SAE short).  
Mounting hex flat 15/16". (111.1 – 128.9°C).

Replaces: Delco 1993444, 445, 508, 513, 582, 588, 1994061, D1858, 59, 68, GMC 6490152, 25036507, Motorcraft SWG-485.

**84229**  
On at 246° to 266°F. 3/8" -18 thread.



3/8" -18 dryseal thread mounting stem (NPTF).  
Mounting hex flat 13/16". Stud terminal. (118.9 – 130.0°C).

Replaces: Delco F1853, Ford C8GY, D1FZ, D6AZ, E43Z-10884A, Motorcraft SW-663, SW-983, SW-1344, SW-1344.

CONTINUED **M1**

84236

On at 251° to 283°F. 1/2" -14 thread.



1/2" -14 dryseal thread mounting stem (PTF-SAE short).  
Mounting hex flat 15/16". (122.0 – 139.4°C).  
.250" blade terminal.

Replaces: Delco 1993445, 1993496, 1994061, D1867, D1879,  
GMC 6489179, 6489395, 6489766, 6490694, 6490970,  
25036512, Motorcraft SWG-1187, SWG-1340.

84248

On at 253° to 273°F. 3/8" -18 thread. ★



3/8" -18 dryseal thread mounting stem (NPTF).  
Mounting hex flat 13/16". (122.8 – 133.9°C).  
.250" blade terminal.

Replaces: Delco D-1896, GMC 8992347, 8993427, 25036035,  
042, 139, 300, 371, 452, 468, 535, Motorcraft SWG-2051.

84251

On at 190° to 210°F. 3/8" -18 thread. ★



3/8" -18 dryseal thread mounting stem (NPTF).  
Mounting hex flat 13/16". (87.8 – 98.9°C).  
.250" blade terminal.

Part of Cole Hersee marine engine warning kit M-40177BP  
(See Section N1).

### For use with two indicator lights

Green light is normally used for Cold/Off, Red for Hot/On.  
1/2" -14 thread.

84211\*



1/2" -14 dryseal thread mounting stem (PTF-SAE short).  
Mounting hex flat 1 1/16". Two bullet terminals.  
Cold: Normally On. Off at 106 - 118°F (41.1 - 47.8°C).  
Hot: Normally Off. On at 237 - 249°F (113.9 - 126.1°C).

Replaces: Delco 198683, 684, 740, 741, D862.

84213\*



1/2" -14 dryseal thread mounting stem (PTF-SAE short).  
Mounting hex flat 1 1/16". Two .250" blade terminals.  
Cold: Normally On. Off at 106 - 118°F (41.1 - 47.8°C).  
Hot: Normally Off. On at 247 - 259°F (119.4 - 126.1°C).

Replaces: Chrysler 2497651, 2580242, 2857562, CH-2515,  
CH-2516, CH-2520, Delco 1993181, 303, 350, 521, 561, 580,  
581, 1998189, 140, 181, 746, 6400211, 6402372, D-1851,  
D-1857, D-1860, GMC 6402778.

84230\*



1/2" -14 dryseal thread mounting stem (PTF-SAE short).  
Mounting hex flat 15/16". Two .250" blade terminals.  
Cold: Normally On. Off at 87 - 119°F (30.6 - 48.3°C).  
Hot: Normally Off. On at 259 - 291°F (126.1 - 143.9°C).

Replaces: Delco G1861, GMC 6489600, 6489903, 6490094,  
6490452, 8992238.

# monitoring devices

M

## M2 TEMPERATURE SENDERS

All items are self-ground. Senders utilize PTF dryseal thread which requires no sealant. Senders are wired to a temperature gauge to provide a continuous monitoring of engine temperature situation. Resistance is cited at 220°F (104.4°C). 1/4" -18 thread.

**84201\***  
43 to 51 Ohms



1/4" -18 dryseal thread mounting stem (PTF).  
Mounting hex flat 15/16".

Replaces: AMC 3144585, Chrysler 1507050, 1770732, 1842555, AL-14405A, 135550A, CH-2503, Delco C1850, Motorcraft SW-338, SW-339.

**84204\***  
11.5 to 13.5 Ohms



1/4" -18 dryseal thread mounting stem (PTF).  
Mounting hex flat 5/8". Stud terminal: 10-32.

Replaces: Delco 1994095, D1866, GMC 6490793.

# monitoring devices

## M3 OIL PRESSURE SWITCHES

Self-grounding SPST Normally On (except 86302-02). Contacts open at rising pressure, close at falling pressure. Heavy duty construction. Weather-resistant. Plated steel case. Molded moisture-repellent insulators. Conservative burst pressure: 750 psi (5171.1 kPa).

**8601\***  
Off at: 6 - 10 psi.  
1/4" -18 thread.



Normally On, Off at: 6 - 10 psi (41.4 - 68.9 kPa).  
1/4" -18 mounting stem.

Replaces Delco 1508434, 1997884, 1998113, 3632326, 488.

**8602\***  
Off at: 3 - 7 psi.  
1/4" -18 thread.



Normally On, Off at: 3 - 7 psi (20.7 - 48.3 kPa).  
1/4" -18 mounting stem.

Replaces Delco 1508754, 3751611, 3815935, 937, 6439312.

**8606** ★  
Off at: 2 - 6 psi.  
1/8" -27 thread.



Normally On, Off at: 2 - 6 psi (13.8 - 41.4 kPa).  
.250" blade terminal. 1/8" -27 mounting stem.

Replaces AMC 1539889, 3142826, Chrysler 4169629, Delco 499581, 534598, 1359289, 1408319, 1508319, 668, 1598319, 1994214, 1998713, 3200422, 3818783, 5653196, 397, 462, D-2471, Ford DORY-9278-A, International 280891-C91, 356079-C, 425491-R91, 31428266, Motorcraft Sw-334, SWG-334, SWE-1030, Trucks: Chevrolet 85-89, Dodge 85-86, GMC 85-89, International 59-67, 78-80.

**8607\***  
Off at: 3 - 7 psi.  
1/8" -27 thread.



Normally On, Off at: 3 - 7 psi (20.7 - 48.3 kPa).  
Terminal: male pin, .118" diameter. 1/8" -27 mounting stem.

Replaces Delco 1508245, 1998082.

CONTINUED **M3**



# M monitoring devices

## M3 OIL PRESSURE SWITCHES

**8609**  
Off at: 4.5 - 7.5 psi.  
1/8" -27 thread.



Normally On, Off at: 4.5 - 7.5 psi (31.0 – 51.7 kPa).  
8-32 stud terminal. 1/8" -27 mounting stem.

**8610**  
Off at: 4.5 - 7.5 psi.  
1/8" -27 thread.



Same as 8609, but with combination blade and stud terminal.

**86255**  
Off at: 3 - 7.5 psi.  
1/4" -18 thread.



Normally On, Off at: 3 - 7.5 psi (20.7 – 51.7 kPa).  
1/4" -18 mounting thread. Button terminal.

Replaces Delco 1350116, 1359288, Motorcraft SW-474.

**86263\***  
Off at: 2.5 - 5 psi.  
1/4" -18 thread.



Normally On, Off at: 2.5 - 5 psi (17.2 – 34.5 kPa).  
.250" blade terminal. 1/4" -18 mounting stem.

Replaces Chrysler 4379037, Delco 1370748, 1508648, D-1805,  
Motorcraft SW-611, SWG-611.

**86268\***  
Off at: 3.5 - 7.5 psi.  
1/4" -18 thread.



Normally On, Off at: 3.5 - 7.5 psi (24.1 – 51.7 kPa).  
1/4" -18 mounting stem.

Replaces Delco 2482378, F-1803, F-1804, Ford C8AZ, DOHZ-  
9278-A, D5AZ-9278C, D5AZ-9278-E, Motorcraft SW-670,  
SW-674, SW-1311, Trucks: Ford 67-89, GMC 66-72.

**86275\***  
Off at: 3.5 - 7.5 psi.  
1/8" -27 thread.



Normally On, Off at: 3.5 - 7.5 psi (24.1 - 51.7 kPa).  
1/8" -27 mounting stem.

Replaces Delco 549099, D-1802.



## connectors

See Section Q4.

## button terminals



These terminals accept standard female snap-on terminations that can be slid quickly onto the button terminal, and can be easily removed. When properly connected, terminations will stay securely attached to the button.

★ Rapid ship item. BP Available in retail clamshell pack. ★ Minimum order quantity may apply.



Cole Hersee Co. 20 Old Colony Ave, Boston, MA 02127-2467

110

T 617.268.2100 F 617.268.9490 www.colehersee.com

## SPST, Insulated, Normally Off

**86272**  
On at: 2 - 6 psi.  
1/8" -27 thread.



On at 2 - 6 psi (13.8 – 41.4 kPa).  
Mounting stem: 1/8"-27 dryseal thread.

Replaces Delco 45784, 10012967, 10018158, 10002798, 25036001, Motorcraft SWG-1702.

**86277\***  
On at: 2 - 6 psi.  
1/4" -18 thread.



On at 2 - 6 psi (13.8 – 41.4 kPa).  
Mounting stem: 1/4"-18 dryseal thread.

Replaces Delco 1260636, 25500672, 25502419, D-1819, Motorcraft SWG-1705.

**86284**  
On at: 2 - 6 psi.  
1/8" -27 thread.



On at 2 - 6 psi (13.8 – 41.4 kPa).  
Mounting stem: 1/8"-27 dryseal thread.

Replaces AMC 5758695, Delco 10001858, 14004902, 25036279, 533, D-1818, International 1324244-R91, Motorcraft SWG-1709.

**86302-02**  
On at: 4-11 psi.  
1/8" -27 thread.



On at: On at 4-11 psi (27.5 - 75.8 kPa).  
Two silver-plated male blade terminals .25" (6.4mm) wide.

## DPST, One grounded, one insulated circuit

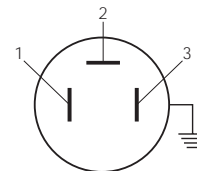

**8659**  
1/8" -27 thread.



Mounting stem: 1/8"-27 dryseal thread. Operation: circuit 1 – terminal 2 normally closed to ground, opens at 9 - 16 psi (62.1 – 110.3 kPa); circuit 2 - terminals 1 & 3 normally open, close at 9 - 16 psi.

**86279\***  
10 x 1mm thread.



Mounting stem: 10x1mm taper pipe thread. Operation: circuit 1 – terminal 2 normally closed to ground, opens at 4 - 6 psi (27.6 – 41.4 kPa); circuit 2 - terminals 1 & 3 normally open, close at 5 - 7 psi (34.5 – 48.3 kPa).

Replaces AMC 3250466, Chrysler 4186353, 4267021, 5209953, CH-2489, Motorcraft SWX-1707.

**86281**  
1/8" -27 thread.



Mounting stem: 1/8"-27 dryseal thread. Operation: circuit 1 – terminal 2 normally closed to ground, opens at 2 - 8 psi (13.8 – 55.2 kPa); circuit 2 - terminals 1 & 3 normally open, close at <11 psi (75.9 kPa).

Replaces AMC 331347, Chrysler 3747431, Delco 14057554, Jeep 4186352, Motorcraft SWG-1708.

CONTINUED **M4**

★ Rapid ship item. **BP** Available in retail clamshell pack. ★ Minimum order quantity may apply.

# M monitoring devices

## M4 OIL PRESSURE/ELECTRIC CHOKE SWITCHES

**86282\***  
10 x 1mm thread.



Mounting stem: 10x1mm taper pipe thread. Operation: circuit 1 – terminal 2 normally closed to ground, opens at 2 - 6 psi (13.8 – 41.4 kPa); circuit 2 - terminals 1 & 3 normally open, close at 9.5 psi or less (65.5 kPa).

Replaces AMC 3250466.

**86283\***  
3/8" -18 thread.



Mounting stem: 3/8"-18 dryseal thread. Operation: circuit 1 – terminal 2 normally closed to ground, opens at 4 - 7 psi (27.6 - 48.3 kPa); circuit 2 – terminals 1 & 3 normally open, close at 6 - 9 psi (41.4 - 62.0 kPa).

Replaces Chrysler 3747430, 3747722, 4205921, CH-2490, Motorcraft SWC-1710.

# monitoring devices

## M5 VACUUM SWITCHES

### Normally On, SPST

Contacts open at rising vacuum, contacts close at falling vacuum. Mounting stem: 1/8" -27 dryseal thread. Operating range: 9 - 12 inches of mercury, break (30.5 – 40.6 kPa).

**8641 Self-grounding**



Replaces AMC 3157693, 3202448, International 196198-R91.

**9253 Insulated** ★



Replaces AMC 3156149, Chrysler 1770093, CH-2569, Ford C2TA-11516-A.

### Normally Off, SPST

**92007**  
On at 7-13" Hg



Insulated. Contacts close at rising vacuum, contacts open at falling vacuum.

Operation: Make at 7 - 13 inches of mercury, (23.7 - 44.0 kPa). Mounting stem: 1/8" -27 dryseal thread.

★ Rapid ship item. BP Available in retail clamshell pack. ★ Minimum order quantity may apply.



Cole Hersee Co. 20 Old Colony Ave, Boston, MA 02127-2467

112

T 617.268.2100 F 617.268.9490 www.colehersee.com

**M6 AIR PRESSURE SWITCHES**

For dependable operation of low air pressure warning systems. Sealed contact design to prevent short circuits caused by moisture and contaminants.

### SPST Normally On

*Contacts open at rising pressure.*

**8604**

Off at: 55 - 65 psi.

1/4" -18 thread.



Mounting stem: 1/4" -18 dryseal thread 15/32" long. Insulated. Normally closed, open at 55 - 65 psi (379.2 - 448.2 kPa). 8-32 screw terminal.

### SPST Normally Off

*Contacts close at rising pressure.*

**8658**

On at: 2 - 5 psi.

1/4" -18 thread.



Contacts close at 2 - 5 psi (13.8 - 34.5 kPa). 8-32 screw terminals. Insulated.

**8640**

Off at: 60 - 70 psi.

1/4" -18 thread. ★



Mounting stem: 1/4" -18 dryseal thread. Normally closed, open at 60 - 70 psi (413.7 - 482.6 kPa). 8-32 stud terminal.

Replaces Chrysler 1787025, 1788700, Delco 3750911, 3929518, Ford B6Q, B8Q-18737A, C5TZ-2A574A, International 194702-R91, Motorcraft SW-377.

**8646**

Off at: 60 - 70 psi.

1/4" -18 thread.



Mounting stem: 1/4" -18 dryseal thread. Normally closed, open at 60 - 70 psi (413.7 - 482.6 kPa). 8-32 screw terminal.

Replaces Chrysler 1787025, Mack 1MR-1169AP1, White 495537.



pilot lights

See Section N2.

### 8647 Normally Off, Electric Fuel Pump Switch ★



Operation: Contacts close at 3.5 - 6.5 psi ( 44.9 - 24.2 kPa)  
Mounting stem: 1/8" -27 dryseal thread 11/32" long.  
.250" blade terminals. Insulated contacts.

Replaces Chrysler 1841416, 2510026, International 217552-R-91.

## switch or sender?

### What's the difference between a switch and a sender?

A switch is a make or break device that has two states — either On or Off. It is typically used to turn a warning device On or Off. For example: when a temperature switch reaches a preset temperature, it will cause a lamp to light or buzzer to sound so that the operator can take appropriate action.

A sender is a variable resistance device that's used in a circuit with a gauge or meter. For example: A temperature sender provides a continuous signal to a gauge as the temperature rises and falls.

Think of your car's engine temperature indicator on the dashboard. If there's a warning light, it's controlled by a switch. If there's a gauge, it's controlled by a sender or sensor.

## buzzers & alarms



Can be used with manual switches (toggles, rockers, etc.) or with switches in Section M.

## red light On – white light Off



Illuminated toggle switch clearly identifies On and Off positions. Available in SPST On-Off and SPDT On-Off-On. See Section B4.

# stoplamp switches



L

|            |    |
|------------|----|
| HYDRAULIC  | L1 |
| MECHANICAL | L2 |

## stoplamp switches

### L1 HYDRAULIC

SPST, Normally Off. Contacts close at rising pressure. Operate at 60 to 120 psi (414 to 827 kPa). Thread is NPTF dryseal thread for use without a sealant.

#### 8626 ★

Two 6-32 screw terminals. 1/8" -27 thread mounting stem, 11/32" (8.73mm) long.

Replaces: Delco 476S, 4760, FWD 4760, 4765, GMC 403936, 476592, 1316600, Ford 100810B, 510C, Mack 5CG-114, 11MR-1152, Motorcraft SW-311, Wagner FC-1201, FC5106, White 58012-F, 443106, 1319522.



#### 8638\*

Two button head terminals accept standard female terminals. Will mate with Packard connector 2962679 or equivalent. 1/8" -27 thread mounting stem, 11/32" (8.73mm) long.

Replaces: AMC 991216, Delco 4769, GMC 1171472, 1363959, Jeep 931126, International 257854C91, 258298C91, Motorcraft SWG-314, Wagner FC-23808.



#### 8628

Two female bullet terminals. 1/8" -27 thread mounting stem, 11/32" (8.73mm) long.

Replaces: AMC 99469, Chrysler 1450341, Delco 4765, Ford 91A-13480, Jeep 647801, Motorcraft SWC-312, Wagner FC-5550, FC-6370.



#### 8649\*

M10x1 taper pipe thread. Two 6-32 screw terminals.

Replaces: Bosch SHL02/1, VW 113945515.



#### 8629 ★

Two male bullet terminals. 1/8" -27 thread mounting stem, 11/32" (8.73mm) long.

Replaces: AMC 300356, 3145198, 3192194, 4488306, Delco 4766, 4733, D850, Ford B8A, B9SF, C1AZ-13480A, GMC 1320938, 1328118, 1997725, Jeep 70034, 201466, 647801, Motorcraft SW-24, Wagner FC-6780, FC-7715, 179-318, AC5812W.



### give warning

Looking for a pilot light or audible warning to connect to your switch? See Section N1: Buzzers & Alarms, and Section N2: Pilot Lights.

MECHANICAL L2

# L stoplamp switches

L2 MECHANICAL

## SPST Normally On

Spring return to On.

### 8645

1/2" -20 thread mounting stem, 3/8" long.  
Plunger 11/32" long.



### 8715 ★

Moisture-resistant plastic body and plunger.  
1/2" diameter mounting stem, 1 5/32" long.

Replaces: AMC 3189147, 3194569, 4488295, 5352620, 9770419, Chrysler 2809033, Delco D864, D866, D868, D873, U850, U851, U852, D885, Ford C8ZZ-13480A, C7TZ, D2TZ-13480B, GMC 536289, 1261219, 1362835, 959, 1993509, 1998192, 196, 667, 3631535, 3889606, 3889607, 3952426, 9772188, 9776994, 14074323, 25524844, International 312739C91, 358560C91, Motorcraft SWG-535, SW-691A, SW-1512, VW 175957656A, Wagner FC-32200, FC-32085, FC-66780.



### 8717\*

Moisture-resistant plastic body and plunger. 11/32" diameter mounting hole.

Replaces: Delco D879, GMC 1993595, Motorcraft SW-523.



### 8713\*

Moisture-resistant plastic body and plunger. 1/4"-28 mounting stem.

Replaces: Chrysler 2258864, 2496985, 249712, 2580998.



## 8486 lever actuated (R)

When viewed from the terminals, the lever projects to the right (see also 8487).  
Lever is 2 7/8" overall length.  
Two tapped 10-32 mounting holes, 5/8" on centers.

Replaces: Delco D851, D853, D855, GMC 1997901, 1997915, 1997922, Motorcraft SWG-317, Wagner FC-21630.



## 8487 lever actuated (L)

When viewed from the terminals, the lever projects to the left. Otherwise, the switch is identical to 8486.

Replaces: Delco D852, D854, DR-2401, GMC 1997913, 1997921, Motorcraft SWG-318, 319, Wagner FC-21632.

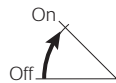

## SPST Normally Off

Spring return to Off.

### 8723\*

Contacts close at 10 to 14.5 lbs pressure.  
9/16" diameter mounting holes.

Replaces: Ford C5AZ, C7ZZ, C8ZZ, C9ZZ-13480B, C8ZZ-13480C, D5UZ-13480A. Motorcraft SW-752, 864, 1255.

### 8722\*

Contacts close at 24 to 34 lbs pressure.  
9/16" diameter mounting holes.

Replaces: Delco 1972544, Ford C5AZ, C7AZ, C7ZZ, C9ZZ-13480A, Motorcraft SW-863, 864.



### 8724\*

Contacts close at 24 to 34 lbs pressure.  
.562" diameter mounting holes. Two pole connector has one male and one female bullet connector.

Replaces: Ford C5CZ, C7TZ, C7UZ-13480A, Motorcraft SW-665.



### 8732\*

Contacts close at 20 to 29 lbs pressure.  
.562" diameter mounting holes. Two pole connector has one male and one female bullet connector.

Replaces: Ford C9AZ-13480C, D2AZ-13480A, Motorcraft SW-860.



### 8743\*

Contacts close at 14.5 to 20.5 lbs pressure.  
9/16" diameter mounting holes.

Replaces: Delco F857, Ford E04Y-13480A, Motorcraft SWX-1303.



### 8757\*

Contacts close at 5 to 8 lbs pressure.  
9/16" diameter mounting holes.

Replaces: Ford E3FZ, E6FZ-13480A, E1FZ-13480A, B, Motorcraft SW-1639, SW-1640, SW-1640-A.



## 8466 for push or pull operation

Push or pull to On, spring return to Off.  
11/32" long plunger with 9/64" diameter hole for attachment of cable or actuating device. Four 13/64" diameter mounting holes.  
1 1/2"L x 2"W center to center.

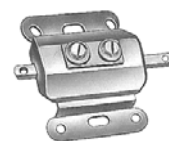

★ Rapid ship item. BP Available in retail clamshell pack. ★ Minimum order quantity may apply.



Cole Hersee Co. 20 Old Colony Ave, Boston, MA 02127-2467

106

T 617.268.2100 F 617.268.9490 www.colehersee.com

# electronic devices

K

|                                 |    |
|---------------------------------|----|
| MINIBUS™ DIGITAL DATABUS SYSTEM | K1 |
| TIMER/DIMMER MODULES            | K2 |
| DAYTIME RUNNING MODULE          | K3 |
| TAILLITE CONVERTER MODULE       | K4 |

## electronic devices

### K1 MINIBUS™ DIGITAL DATABUS SYSTEM

#### MiniBus™ Digital Databus System

*Controls and monitors electrical motors and lighting using very low currents.*

Modular scalable system.

Replaces conventional power distribution panels, and eliminates the need for complex and expensive wiring harnesses, and simplifies equipment wiring.

Connects as many as 128 switch functions to high-current devices.

#### System components

- 48408 Power Distribution Module (PDM)
- 48450 Switch Interface Module (SIM)
- 58500 Configurable Digital Rocker Switch
- 12800 Cable Assembly (Digital Rocker to SIM)
- 12801 Data Cable Assembly (SIM to PDM)
- 40225 Audible Alarm
- 48800 Series of Timer Modules. *See Section K2*
- 48850 MiniBus Applications Programming Kit

Digital switches feed commands to the SIM unit, which in turn communicates the instructions to the PDM unit via a dual twisted pair cable. The PDM filters the command messages and routes them to the appropriate target load, turning each load on or off (or to preset levels). The system continuously monitors each load and relays operational status information back to the switches (indicated by the switch pilot lights).

#### System Features

**System capacity:** 128 discrete switching channels, utilizing 16 daisy-chained PDM units (8 outputs each) and 8 SIM units (16 inputs each).

**Power outputs:** PDM units have 8 outputs. Each output can source up to 20A (maximum 100A per PDM).

**Overcurrent protection:** Each PDM output is protected by an electronic circuit breaker that can be programmed to any of eight trip currents from 2A to 20A. Breakers are manually resettable by shutting the digital switch Off and On at the remote control.

**Power output terminals:** Standard 0.25" blade terminals on the PDM are angled to facilitate ease of wiring.

**Software:** Graphical user interface is intuitive and easy to use.

**Switches:** Conventional rocker switch appearance. Switches can be programmed to any function - maintained/momentary; independent/independent illumination; latched or toggled.

**Switch Pilot Lights:** LED pilot lights are true indicators that the entire system is functioning in real-time. Compare with standard DC switches that merely confirm a circuit is drawing current.

**True remote station control:** Each output can be controlled seamlessly from any number of auxiliary control stations.

CONTINUED **K1**



### System Technical Specifications

**Rated Input Voltage,  $V_{IN}$  for 12V or 24V**  
9.0V DC min to 32V DC max. Suitable for use with 12V or 24V electrical systems.

**Operating Quiescent Current  $I_Q$  with outputs Off ( $V_{IN} = 14.0V$  DC)**  
0.030 – 0.035A (30-35mA) typical for a basic system of one PDM and one SIM.  
 $I_Q$  PDM of 20 – 25mA typical per PDM.  
 $I_Q$  SIM of 8 – 10mA typical per SIM.

**Digital Data Communications Protocol**  
RS-485 serial databus, half duplex.  
Custom proprietary software.  
Compatible with Faria® Helmsman™ subnetwork serial databus.

**Compliance**  
The MiniBus™ Digital DataBus Systems is designed to comply with applicable sections of the following specific industry standards:

ABYC Standard E-11 (formerly E-9) for overcurrent protection and ignition protection. System has trip-free type circuit breaker with manual remote reset (non-contacting interrupt mechanism).

USCG Title 33 Code of Federal Regulations, Section 183.455(a) for overcurrent protection.

CE for RF/EMI compatibility.

UL certification for compliance with published specifications.

NFPA for materials flammability.

**SAE standards:**

SAE J1171 for ignition protection.

SAE J1455

- 4.1 for temperature storage and operating (-40° to +85°C)
- 4.2 for humidity (98% at 38°C)
- 4.3 for salt spray atmosphere (5% salt in aqueous solution atomized at 35°C for 24 hours.)
- 4.4 for immersion and splash (water, chemicals and oils).
- 4.9 for mechanical vibration (swept sine method 4.9.4.12, reference Figure 6).
- 4.10 for mechanical shock (operational shock 10G peak).
- 4.11 for electrical environment (see PDM specifications).

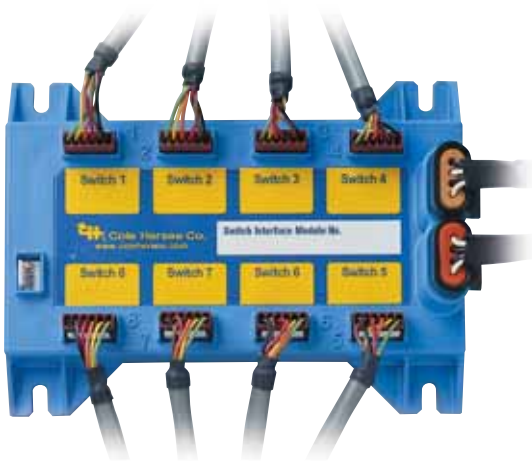

### Standard Cables and Connectors

Interconnect between PDM and SIM with dual shielded twisted pair cable with Delphi (Packard) 12162188 sealed connectors (with 12103881 terminals) at each end. One twisted pair carries data communications, the other provides power from PDMs to the SIMs.

Maximum cable length  
(total length of all interconnect cables = 100ft or less (30m).

Digital switch to SIM interconnect via 6-wire ribbon cable with Molex 22-01-2067 connectors (gold-plated contacts) at each end.

### Materials

**PDM and SIM housings:** Injection-molded Valox 357, flame retardant to UL94-V0 standards.

**Hardware:** Non-ferrous with galvanic series compatibility.

### Installation requirements

Complete reference manual is on the CD that is part of the programming kit. It includes installation instructions, software instructions, and system design guidelines.

### Troubleshooting, error codes & diagnostics

A system of flashing LEDs in the digital switches, and an audible alarm (if installed), readily characterize the nature of the different error states:

- Overcurrent or short-circuit condition at any output
- Communication failure
- Thermal shutdown
- **Internal self-diagnostics**  
The PDM imbedded software includes various self-diagnostic routines to monitor the system performance.
- **Redundant output protection**  
Multiple overcurrent, short circuit and thermal overload protection.

★ Rapid ship item. BP Available in retail clamshell pack. ★ Minimum order quantity may apply.

## 48408 Power Distribution Module (PDM)



### Input voltage (power source)

- 12V DC or 24V DC
- Steady state electrical characteristics are per SAE J1455 4.11.1.1 for nominal, minimum and maximum voltage.
- Start voltage (CCA) 7.5V DC minimum at PDM.

### Power input protection

- Transient protection: Load dump and inductive switching per SAE J1455 4.11.2 tables 4A and 4B.
- Each PDM must be protected by an external overcurrent device between the power source and the PDM. Overcurrent device rating must be equal to the sum of the eight internal PDM breaker settings (100A maximum). Power line from the power source to the PDM should include a master disconnect switch or battery switch. Such wiring is mandated for marine installations per ABYC Standard E-11 (formerly E-9), and associated USCG requirements.
- The power input studs on the PDM are sized differently in compliance with standard industry practice to obviate incorrect wiring at installation.

### Ratings

- Output voltage  $\geq V_{in}$ : 0.25V at  $I_{out} = 20A$  at 25°C. Input-output drop is  $\leq 150$  MV typical at 20A, 25°C.
- Output current: 20A maximum, continuous.
- Instantaneous surge current (inrush): 35A maximum, decreasing to  $\leq 20A$  within 300ms.
- Internal circuit-derived short-circuit protection (typical)  $\approx 95A$  at 12V, 70A at 18V, 46A at 24V. Trip within 2ms.
- Internal hardware-derived short-circuit protection (typical) 30A/1.0s, 70A/0.3s, 110A/0.1s at 25°C.
- Output protection: Protected against inductive load switch-off energy (load dump) up to 400mJ (0.4Ws). Additional output negative transient protection is provided up to -600V (3A continuous, 100A peak, one 8ms half-sine pulse).

## Electronic circuit breaker

- Action: Manually resettable after break, utilizing remote switches (complies with ABYC and USCG manually resettable overcurrent protection requirement).
- Rated breaker trip currents are programmable to 2.0, 3.0, 4.0, 5.0, 7.5, 10.0, 15.0, or 20A. Breakers carry rated current indefinitely. Trip action is controlled by slow blow timing and by software algorithm which simulates conventional thermal-mechanical breaker performance.
- Outputs are rated for resistive and reactive loads, and incandescent lighting current surges.
- Overcurrent protection redundancy: 5 levels. Two software-derived, two circuit-derived, one hardware-derived.

## 48450 Switch Interface Module (SIM)



Data: RS-485 circuit interface.

Power: 7.0V – 9.0 V DC nominal, 6.0V – 16.0V DC range.

Switch input requirements: input is grounding, with hard pull-up resistance (internal to the SIM, 39K $\Omega$  typical) to 5.0V DC nominal circuit B+. Typical switch current 100-150 $\mu$ A.

LED output: 5.0V DC for LED On. LED current not to exceed 20mA (external current limiting).

## 12800 Cable Assembly (Digital Rocker to SIM)

### 12801 Data Cable Assembly (SIM to PDM)

Connectors: Delphi (Packard) style molded-in 4-pin panel mounted header. Interfaces with Delphi (Packard) 12162188 connector.

Data: RS-485 circuit interface.

Power: 7.5V DC nominal. Sourcing current: 3.0A.

### 40225 Audible Alarm

Optional alarm to signal 'no load' or 'overcurrent'. Connector fits SIM 48450.

### 48800 Series of Timer Modules

See Section K2

## 48850 MiniBus Applications Programming Kit

★ Rapid ship item. BP Available in retail clamshell pack. ★ Minimum order quantity may apply.

Three general purpose timer/dimmer modules, plus Marine Foghorn Timer. These items have many applications for controlling motors or lighting. Cole Hersee can build a custom unit to your special order – call us.

Modules (except the Foghorn Timer) each have one-time preset options – the user selects an option by selectively cutting the jumper wires. Modules consist of a microprocessor-based timer driving a solid state solenoid type output. The actuator for the timer can either be a manual or an automatic switch.

Modules are particularly appropriate for certain marine and RV applications: operating lighting, horns, pumps, or blowers.

### Series 48800



**Wiring:** 2 power in, 2 power out, control wire to momentary switch. Instructions are included. Power wires 16AWG control wires 18AWG, loops 22AWG. System voltage 12V DC (9-16V).

**Solid state:** Handles up to 20A peak load – enough to power incandescent lights, motors, or other inductive or reactive loads.

**Reliable:** no moving parts. Cool-running. Use with either incandescent or LED lighting.

**Rugged, weatherproof, vaporproof:** Strong plastic molded case, potted for added durability and protection.

**Integral protection:** Incorporates an electronic circuit breaker which provides another level of protection from overload. Includes a thermal overload shutdown circuit. Breaker can be reset by activating the control switch. The module is also protected against reverse polarity.

Use with conventional switches, or digital signal switches. Can be used with any low current single pole normally open momentary switch (push button, rocker, toggle, rotary etc.)

**Simple installation:** Case is small and readily screwed or bolted in place.

**Case size:** 1.356"H (not including flange) x 1.97"W x 1.03"D (34.4mm x 49.9 x 26.2mm). Flange is 0.32"H x 1.97"W (7.94 x 49.9mm). 3 mounting holes: .28" diameter (7.2mm), 0.56" (14.3mm) on centers.

#### \*48810-01 Delay Timer BP

Suitable for controlling exhaust fans and blowers, or boat courtesy lights.

Selectable preset options:  
 Option 1: 2 minutes delay  
 Option 2: 4 minutes delay  
 Option 3: 6 minutes delay  
 Option 4: 8 minutes delay

#### 48811-01 Stepping Dimmer BP

Suitable for control of truck cab or marine cabin lights. Repeated actuation of the control switch cycles the dimming modes. Holding the momentary switch for 3 seconds turns the lights off, without having to pass through dimming stages.

Selectable preset options:

Option 1: On – Dim 1 – Dim 2 – Dim 3 – Dim 4 – Off  
 Option 2: On – Dim 1 – Dim 2 – Dim 3 – Off  
 Option 3: On – Dim 1 – Dim 2 – Off  
 Option 4: On – Dim – Off

#### 48812-01 Intermittent Timer BP

Suitable for boat bait well pumps and many other applications where intermittent switching is needed.

Selectable preset options:

Option 1: On 2 minutes – Off 1 minute  
 Option 2: On 2 minutes – Off 2 minutes  
 Option 3: On 2 minutes – Off 4 minutes  
 Option 4: On 2 minutes – Off 6 minutes

#### 48813-01 Marine Foghorn Timer BP

On – Both Off – Foghorn timer On  
 On 4 seconds – Off 100-120 seconds

No user-selectable preset options. (The Off period is designed to vary randomly in order to avoid synchronization with foghorn blasts from other vessels.) The timing pattern is recommended by USCG International Navigation Rules (COLREGS) Part D – Sound and Light Signals:

*Rule 35 - Sound Signals in Restricted Visibility (a) Power-driven vessel making way through the water shall sound at intervals of not more than 2 minutes one prolonged blast.*

*Rule 32 – Definitions (c) The term "prolonged blast" means a blast of from four to six seconds' duration.*

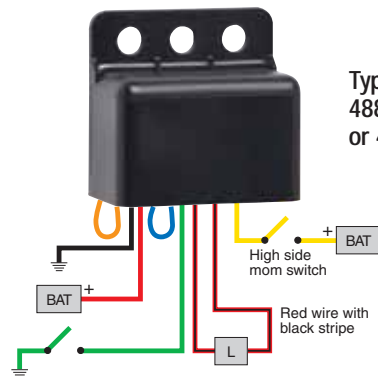

Typical wiring for 48810-01, 48811-01 or 48812-01.

## 48600 DRL Module



Automatically turns on low-beam headlights when the ignition is turned on (after a 10 second delay, thus reducing the initial starting load. Activated when the parking brake is released; deactivated when the parking brake is set (with ignition On). Deactivates when high beams are flashed for signaling. Completely solid-state construction. Supplied with 15A mini-fuse ATM98107-15.

Extends the life of the headlights, because (for daytime running) they are powered at 75% of the high-beam intensity. For two or four headlamp systems.

Complies with FMVSS 108 for headlamp intensity. CMVSS-108 and CAN/CSA D-603-88, type 2. Six 28" (711mm) long wire leads, six 30223 Quick Tap wire splicers (see Section P5), and two self-tapping mounting screws.

*Also available without splicers and screws: order part number 48600-01.*

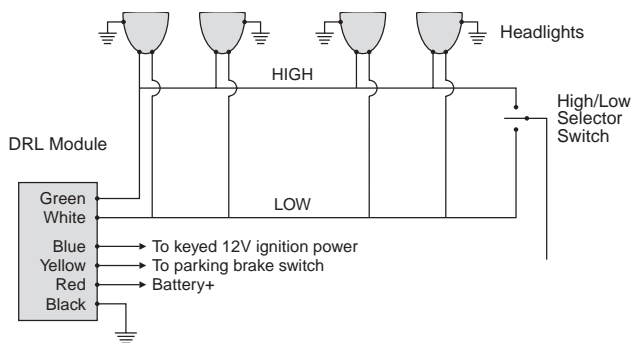

## electronic components

More and more of Cole Hersee components contain electronics – from rotary switches to windshield wiper switches. They possess advantages of being solid state, such as reliability, resistance to adverse weather and vibration. Devices of this type for the most part look like their electro-mechanical counterparts, and you can find them in the appropriate catalog sections: Section E for windshield wiper switches, Section J3 for battery isolators; Section H4 for electronic solenoid, Section N1 for alarm buzzers, and Section D5 for rotary dimmer switches.

Many of the components in this section are 'black boxes' with few external signs to suggest their function. As with all Cole Hersee products, they can be customized to meet other specifications. Call us.

*See Section E for windshield wiper switches, Section J3 for battery isolators; Section H4 for electronic solenoid, Section N1 for alarm buzzers, and Section D6 for rotary dimmer switches.*



## rotary dimmers

See Section D6 for rotary electronic dimmer switches.



## other electronics

Solid State Alarm: See Section N1

### 48000 Trailer Tail Light Converter



Permits a towing vehicle with two lighting circuits for each side to operate lights on a trailer with a single circuit each side. Eliminates the need to rewire the trailer, or to add additional lights. US laws require stoplights, turn signals and taillights on trailers.

For use with 12V DC negative ground systems only. Using the Converter, towing vehicles with four lighting circuits (left stop, left turn, right stop, right turn) can properly operate trailers with two lighting circuits (left stop and turn, right stop and turn). Solid state circuitry provides high reliability and is embedded, giving complete protection against moisture and vibration. Color-coded 18AWG wire leads are 24" (607.6mm) long for towing vehicle connections, 36" (914.4mm) long for attachment to trailer connector.

Operation of trailer lights is unaffected by a burned-out bulb in the towing vehicle.

Includes wiring and installation instructions, and self-splicing wire connectors for fast installation. Converter has self-adhesive pad for easy mounting inside a trunk, fender wall or other smooth surface.

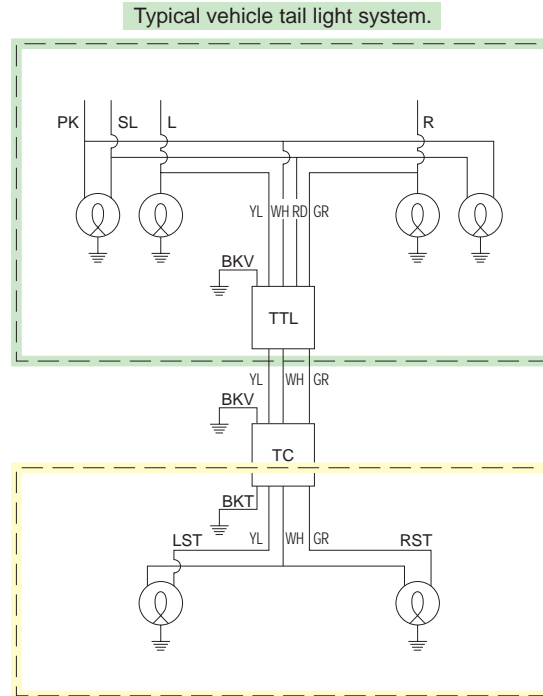

Typical trailer tail light system.  
Trailer ground is not provided.

#### Key to the diagrams

|     |   |                                 |
|-----|---|---------------------------------|
| PK  | = | Parking lights.                 |
| SL  | = | Stop lights.                    |
| L   | = | Left turn signal.               |
| R   | = | Right turn signal.              |
| YL  | = | Yellow.                         |
| WH  | = | White.                          |
| RD  | = | Red.                            |
| GR  | = | Green.                          |
| BKV | = | Black, vehicle ground.          |
| BKT | = | Black, trailer ground.          |
| TTL | = | Trailer tail light module.      |
| TC  | = | Trailer connector.              |
| LST | = | Left stop & turn signal light.  |
| RST | = | Right stop & turn signal light. |



### other electronics

Battery Isolator Switches: See Section J3



### other electronics

Solid State Solenoid: See Section H4

# battery-related products



J

|   |    |
|---|----|
| BATTERY SELECTOR & MASTER DISCONNECT SWITCHES | J1 |
| MASTER DISCONNECT SWITCHES                    | J2 |
| BATTERY ISOLATORS                             | J3 |
| ACCESSORIES                                   | J4 |
| INFORMATION                                   | J5 |

## battery-related products

### J1 BATTERY SELECTOR / MASTER DISCONNECT SWITCHES

For any vehicle that needs to use two batteries where one battery is used for starting the engine, while the other is used to power auxiliary loads. This is a common situation in trucks, boats, RVs, police and rescue vehicles, and in ambulances and fire equipment. See wiring diagrams, Section J5.

#### M-750 Basic Switch ★



#### Back of Switch



Model M-754 is shown. The three small terminals in the middle are for connection to the pilot light circuit. M-754-01, M-755 and M-755-01 are similar.

Models M-752 and M-753 have two small terminals in the middle marked F1 and F2 for connection to the Alternator Field Disconnect circuit.

M-750 and M-751 have no small terminals in the middle. Full wiring instructions are included.

#### M-751 With Keys



#### 563 Switch Position Label

Useful when the switch is mounted through a panel. Pressure-sensitive label.

See chart on next page for additional models.

CONTINUED J1

★ Rapid ship item. BP Available in retail clamshell pack. ★ Minimum order quantity may apply.

A selector switch allows use of the first battery, the second battery, or both batteries simultaneously. This provides back-up starting power in an emergency. Either or both batteries can be selected for energizing.

These switches combine the functions of Battery Selector and Master Disconnect Switches to give four battery power options:

- Power cut off at the source.
- Power On, Battery 1.
- Power On, Battery 2.
- Power On, both Batteries.

Battery selector switches provide a positive battery disconnect, which has many advantages:

- It gives a reliable shutdown of power during maintenance.
- The version with the key protects against theft of the vehicle, when unattended.
- It helps protect against electrical fires, when the vehicle is not in use, and minimizes battery drain.



#### Electrical Ratings

Labeled UL 707B. Rating: 500A intermittent, 310A continuous, 6-36V DC

Electrical ratings on UL labels are conservative. Use with either alternators or generators. Make before break design permits operation through the three On positions with the engines running. Engines should always be shut down before turning to Off. Wiring instructions are included.

#### Heavy-Duty Construction

Vaporproof, weather-, dust- and corrosion-resistant. Durable, fracture-resistant high temperature plastic case, knob and insulator. Switches conform to USCG section 183.410 for ignition protection. Resistant to impact, and temperature extremes.

Heavy duty copper stud terminals, with brass hexnuts. Can be surface mounted, or installed through a 3 5/16" diameter hole in the panel (use label No. 563. See Section F4.) Dimensions: Flange: 6" (152.4mm) diameter, overall height 2 5/8" (66.7mm). Terminals: 3 copper studs, 3/8" (9.5mm) diameter.

#### Eight Models For Every Application:

| MODEL    | Lock | AFD | Pilots | Pilot Circuit |
|----------|------|-----|--------|---------------|
| M-750 ★  |      |     |        |               |
| M-751    | ✓    |     |        |               |
| M-752    |      | ✓   |        |               |
| M-753    | ✓    | ✓   |        |               |
| M-754    |      |     |        | ✓             |
| M-754-01 |      |     | ✓      | ✓             |
| M-755    | ✓    |     |        | ✓             |
| M-755-01 | ✓    |     | ✓      | ✓             |

Lock: With key lock and two keys.

AFD: Alternator field disconnect circuit switch. Prevents possible alternator diode failure if the switch is accidentally turned to Off with the engines running.

Pilots: Supplied with two separate green pilot lights PL-T18-GC001.

Pilot Circuit: With pilot indicator light circuit.

## Largest amp capacity for the dollar of any competitive switch

500A intermittent, 310A continuous, 6-36V DC



★ Rapid ship item. BP Available in retail clamshell pack. ★ Minimum order quantity may apply.



## J2 MASTER DISCONNECT SWITCHES

Some models have indexing pins to align the switch and prevent rotation caused by loosening of the nut.  
See Section J4 for faceplates to match switches with or without an indexing pin. See wiring diagrams, Section J5.

### Single Pole

Two positions: Off-On. For 6-36V DC systems.  
Will disconnect the battery circuit only.

Electrical Ratings (unless noted):

1000A intermittent, 175A continuous.

UL Listed 707B: 800A intermittent, 175A continuous.

UL Listed 375M: 250A at 6V, 125A at 12V intermittent;  
40A at 6V, 20A at 12V continuous.

Electrical ratings on UL labels are conservative.

### With diecast lever

2484-16 ★



Mounting stem: Brass, 3/4" -16 thread, 23/32" (18.3mm) long.  
Fits panels up to 3/16" (4.8mm) thick. Terminals: Two 3/8"  
-24 studs. Case: Plated steel. Contacts: Silver.  
Labeled UL 707B.

2484-A ★

Same as 2484-16, but without UL label.

2484-09 ★

Same as 2484-16, but with copper contacts, and without  
UL label.

2484-06 ★

Same as 2484-16, but weather-resistant with O-ring seal in  
operating shaft, gasket-sealed terminal insulation and sealant  
in mounting stem and case.

2484 ★

Same dimensions as 2484-16, but with copper  
contacts and ratings: Labeled UL 375M.



## waterproof

Some manufacturers claim that their switches are 'waterproof'. We, on the other hand, maintain that 'waterproof' refers only to an article that is specifically intended to function underwater. You'll find that many of our switches are designated 'weather-resistant', meaning that they are designed to function reliably in an environment that may be damp, perhaps subject to being splashed with salt spray, etc. These weather-resistant switches are also a good choice for dusty environments, such as those encountered in agriculture and construction.

M-284-01 Long stem, brass case BP ★



Mounting stem: Brass 3/4" -16 thread (19.1mm), 1 13/32"  
(46.1mm) long. Fits panels up to 15/16" (23.8mm) thick.  
Terminals: Two 3/8" (9.5mm) diameter studs. Actuator: Chrome-  
plated lever. Silver-laminated contacts. Labeled UL 707B.

M-284 BP ★

Same as M-284-01, but without silver contacts, and UL label.

M-284-A ★

Same as M-284-01, but without UL label.

M-284-02 Weather-resistant ★

Same as M-284-01, but with O-ring seal in operating shaft,  
gasket-sealed terminal insulator and diecast lever with  
protective dichromate finish, and without UL label.

Also available with faceplate (M-284-09BP)

M-288 50 amps



Rated at 50A at 14V DC. Mounting stem: 5/8" (15.9mm)  
diameter, 3/4" (19.1mm) long. Fits panels up to 17/32"  
(13.5mm) thick. Terminals: Two 10-32 brass screw terminals.  
Actuator: Diecast lever. Contacts: Silver. Case: Plated steel.

75908 300 amps, weather-resistant ★



Disconnects battery circuit only. Electrical rating: 2000A  
intermittent. 30 seconds On, 3 minutes Off, 300A continuous.  
Mounting stem: 3/4" -16 thread. Fits panels up to 1/4" (6.4mm)  
thick. Terminals: Two 1/2" -20 copper studs. Case: Plated steel.  
Sealing: sealed between shaft and mounting stem; case and  
terminal insulator.

Also available as double pole (75907)

★ Rapid ship item. BP Available in retail clamshell pack. ★ Minimum order quantity may apply.

CONTINUED J2



**With Hencol lock**

2484-02



Mounting stem: Brass, 3/4" -16 thread 17/32" (13.5mm) long. Fits panels up to 1/4" (6.4mm) thick. Terminals: Two 3/8" -24 studs. Plated steel case, silver-laminated contacts. Hencol lock and 2 keys. Indexing pin.

2484-03

Same as 2484-02, but with O-ring seal in the operating shaft.

**2484-19 Weather-resistant**

Same as 2484-02, with gasket-sealed terminal insulator and with O-ring seal in operating shaft.

**Double Pole**

*Two positions: Off-On. For 6-36V DC systems. Will disconnect the battery and the alternator or generator field circuit.*

*Electrical ratings: Large studs: 1000A intermittent.*

*15 seconds On, 5 minutes Off. 125A continuous (unless noted). Small studs: 20A continuous.*

**With diecast lever**

75903 Steel case ★



Chrome-plated diecast lever. Plated steel case. Brass mounting stem 3/4" -16 thread 23/32" (18.3mm) long. Fits panels through 3/16" (4.8mm) thick. Two 3/8" -24 and two 10-32 studs.

75904 Steel case, silver contacts ★

Same as 75903, but with laminated silver contacts.

M-289 Brass case



Chrome-plated diecast lever. Brass mounting stem 3/4" -16 thread 1 13/32" (46.1mm) long. Fits panels through 15/16" (23.8mm) thick. Two 3/8" -24 and two 10-32 studs.

M-290 Brass case, silver contacts

Same as M-289, but with laminated silver contacts.

M-290-01

Same as M-290, but with O-ring seal in operating shaft.

M-290-05 UL-listed ★



Brass case. Silver laminated contacts. Chrome-plated diecast lever. Brass mounting stem 3/4" -16 thread 1 13/32" (46.1mm) long. Fits panels through 15/16" (23.8mm) thick. Two 3/8" -24 and two 10-32 studs. Labeled UL 707B.

75904-01 Weather-resistant, with indexing pin and O-ring ★



Diecast lever. Plated steel case. Silver-laminated contacts. Brass mounting stem 3/4" -16 thread 17/32" (13.5mm) long. Fits panels through 1/4" (6.4mm) thick. Two 3/8" -24 and two 10-32 studs. O-ring seal in the operating shaft, and gasket-sealed terminal insulator.

75907 300 amp, Weather-resistant ★



Electrical ratings: Large studs: 2000A intermittent, 30 seconds On, 3 minutes Off. 300A continuous. Small studs: 20A continuous. Plated steel case. Chrome-plated diecast lever. Mounting stem 3/4" -16 thread, fits panels through 1/4" (6.4mm) thick. Two 1/2" -20 copper and two 10-32 studs. Sealed between shaft and mounting stem, and case and terminal insulator. With indexing pin.

*Also available as single pole (75908).*

★ Rapid ship item. BP Available in retail clamshell pack. ★ Minimum order quantity may apply.

**J2** MASTER DISCONNECT SWITCHES

## With Hencol key

75904-02



Two Hencol keys.  
Plated steel case.  
Silver-laminated contacts.  
Brass mounting stem 3/4" -16 thread  
17/32" (13.5mm) long. Fits panels through 1/4" (6.4mm) thick.  
Two 3/8" -24 and two 10-32 studs. With indexing pin.

75904-03

Same as 75904-02, except with O-ring seal in the operating shaft.

## For two high current loads

75912



AVAILABLE  
FALL 2006

Electrical ratings: 125A continuous, 750A intermittent; 15secs On, 5min Off. Up to 36V DC max, carry only. Silver contact surfaces. Both poles are separately insulated. Four 3/8" -24 studs. Lockwasher and two brass hexnuts per stud are provided. 3/4" -16 brass mounting stem. Operating temperature range: -40° to 85°F (-40° to 29°C) O-ring seal in mounting stem; gasket seal at terminal insulator. Epoxy seal at case, mounting stem and locating pin. Heavy duty plated steel case. With indexing pin. Mounting torque 20ft lbs (27 Nm); stud torque 4.4 to 7.4 ft lbs (6-10Nm).

# battery-related products

**J3** BATTERY ISOLATORS

*For vehicles with two batteries, these devices electrically isolate the batteries to prevent the battery with the higher charge from draining into that with the lower charge. In addition, both batteries can be charged simultaneously from one source. For 12-36V DC negative ground systems (48051 is for 12V DC only). The electronic components are embedded to give excellent protection from adverse conditions, such as contamination and vibration. The integral heat sink provides efficient heat dissipation. The amp rating of each item is the maximum alternator rating. For wiring instructions, see Section J5.*

*Most alternators on new vehicles have an integral electronic voltage regulator that requires the use of the 4-stud battery isolator. The small 4th stud is for connection to a circuit switched by the ignition switch. The newer alternators were first introduced by Delco and are therefore sometimes called 'Delcotron-type alternators'. A 4-stud battery isolator can be used with older pattern alternators (in this case the 4th stud will remain unconnected), but a 3-stud battery isolator cannot be used with the Delcotron-type alternator.*

## 4-stud general purpose isolators

*For use with Delcotron-type alternators. Four studs.*

48092 90 amp



Terminations: three 1/4" (6.4mm) studs and one No. 10 stud.  
Two 9/32" (7.2mm) diameter mounting holes. Size: 6 1/2"L x 3 1/4"W x 2 13/16"H (165.0 x 82.6 x 71.0mm).

48122 140 amp



Terminations: three 5/16" (7.9mm) studs and one No.10 stud.  
Four 9/32" (7.2mm) diameter mounting holes. Size: 6"L x 4 13/16"W x 3 11/32"H (152.4 x122.2 x 84.9mm).

CONTINUED **J3**

★ Rapid ship item. BP Available in retail clamshell pack. ★ Minimum order quantity may apply.

## 48162 200 amp



Terminations: three 5/16" (7.9mm) studs and one No.10 stud. Four 9/32" (7.2mm) diameter mounting holes. Size: 8 1/2"L x 4 3/16"W x 3 13/32"H (215.0 x 122.2 x 86.5mm).

### 3-stud battery isolators

*For use with alternators that do not have an integral electronic voltage regulator.*

## 48080 42 amp



Terminations: one 10AWG 6" (152.4mm) wire lead, two 12AWG wire leads. Two 13/64" (5.2mm) diameter mounting holes. Size: 5"L x 3 1/4"W x 2 3/16"H (127.0 x 82.6 x 71.0mm).

## 48070 70 amp



Terminations: three 1/4" (6.4mm) studs. Two 9/32" (7.2mm) diameter mounting holes. Size: 5"L x 3 1/4"W x 2 3/16"H (127.0 x 82.6 x 71.0mm).

## 48090 90 amp



Terminations: three 1/4" (6.4mm) studs. Two 9/32" (7.2mm) diameter mounting holes. Size: 6 1/4"L x 3 1/4"W x 2 3/16"H (165.0 x 82.6 x 71.0mm).

## 48120 140 amp



Terminations: three 5/16" (7.9mm) studs. Four 9/32" (7.2mm) diameter mounting holes. Size: 6 1/4"L x 4 3/16"W x 3 11/32"H (152.4 x 122.2 x 84.9mm).

## 48160 200 amp



Terminations: three 5/16" (7.9mm) studs. Four 9/32" (7.2mm) diameter mounting holes. Size: 8 1/2"L x 4 3/16"W x 3 13/32"H (215.0 x 122.2 x 86.5mm).

### For ambulances

*Used to isolate medical equipment batteries from vehicle batteries. With Schottky diode, to comply with Federal Specification KKK-A-1822B for ambulances.*

## 48051 75 amp at 12V DC



## 48161 250 amp



Same as 48160, but with Schottky diodes. Terminations: three 5/16" (7.9mm) studs. Four 9/32" (7.2mm) diameter mounting holes. Size: 8 1/2"L x 4 3/16"W x 3 13/32"H (215.0 x 122.2 x 86.5mm).

## 24505 Lockout Lever Kit ★



Special lever and flange plate accept a padlock to securely lock a Disconnect Switch in the Off position, which is required by many lock-out/tag-out safety regulations. For use with Cole Hersee lever actuated master disconnect switches with a 3/4" diameter (19.1mm) mounting stem: 2484, 2484-A, 2484-06, 2484-09, 2484-16, 75903, 75904, 75904-01, M-284, M-284-A, M-284-01, M-284-02, M-289, M-290, M-290-01, M-290-05. (We recommend the use of a padlock with a 5/16" (7.9mm) diameter shackle.)

## 80101-B Replacement Lever



Chrome-plated diecast lever. Fits all Cole Hersee lever-actuated Master Disconnect Switches.

## 83353 Hencol Key



For Hencol trouble-free locks. Heavy gauge plated steel resists corrosion.

## lockouts/tagouts

Lockouts and tagouts prevent operators, technicians and maintenance personnel from unanticipated power-ups that might cause injury or death.

According to OSHA, "A lockout device utilizes a positive means such as a lock to hold an energy isolating device in a safe position and prevent the energization of a machine." A tagout is a tag or seal that states 'Do not operate or remove this tag' and is signed by the person who places the tagout. Procedures specify that nobody but that person may remove the tag.

A lockout on a battery switch not only keeps a vehicle safe, but also immobilizes it. A locked out vehicle is less vulnerable to battery drain or theft.

## Face Plates

### 82065 without indexing hole



For Master Disconnect Switches. Polished aluminum with enamel finish. Fits Cole Hersee Master Disconnect Switches without indexing pin. 2 1/2" (63.5mm) diameter.

### 82065-02 with indexing hole

Same as 82065, but with hole for indexing pin.

### 563 Switch Position Label for M-750 Series

Pressure-sensitive label for Dual Battery Selector & Master Disconnect Switches. Useful when the switch is mounted through a panel.

## Battery Jumper Terminals and Studs

*Use them to make easily-accessible battery connections, inside or outside the vehicle. Can be used individually or in pairs. Easy to install. Solid brass posts. Includes brass hexnut and lockwasher. Jumper terminals have contact post 13/16" (20.6mm) diameter, 1 1/8" (28.8mm) long, which is grooved to accept standard jumper cables 6 -48V DC.*

### 46210-02 Post with red cap for positive terminals ★



### 97846-A Replacement captive red cap

### 46210-03 Post with black cap for negative terminals ★



### 97846-B Replacement captive black cap

CONTINUED J4

★ Rapid ship item. BP Available in retail clamshell pack. ★ Minimum order quantity may apply.

**46211-R Red Battery Feeder Stud**

Brings 6-36V DC power through bulkheads or firewalls. Impact-resistant plastic insulator/mounting bushing, 1 17/64" (32.1mm) diameter, 5/8" (15.9mm) long. Two 3/8" -16 thread brass stud terminals, 5/8" (15.9mm) long.

**46211-01 Black Battery Feeder Stud** ★

Same as 46211-R, only black plastic.

**3188 Copper Cable Terminal**

0.46" (11.7mm) diameter for 0AWG or 00AWG cable. 150A. 13/32" (10.3mm) diameter hole for 3/8" (9.5mm) stud.



## dead batteries in inactive vehicles

If you leave a fully charged battery connected in an inactive vehicle, it could be dead within two months. Today's vehicles all have electronics, and although they require only a very small amount of current to maintain their memory, it's enough to kill an uncharged battery over time.

Any breakdown in insulation in the electrical system can result in the same problem. Breakdown of the insulation can be caused by abrasion, infiltration of contaminants such as road salt, or the use of electrical test prods.

Apart from inconvenience, there are two important reasons to avoid complete battery discharge. First, the battery plates can crystallize and the battery will no longer take a charge — an irreversible process. The second reason is cold temperatures. When a battery is fully charged, its electrolyte freezes at -83°F (-64°C), but when it's discharged, it freezes at a higher temperature — closer to 32°F (0°C). Resulting ice buildup can break the inter-cell connections and crack the case.

A good way to prevent a dead battery is to fully charge it, then disconnect the ground cable. In this state the battery can hold its charge for about a year.

The best way of all is to totally disconnect the battery using a Master Disconnect Switch.

## standards

Cole Hersee makes switches and connectors that meet industry standards, generally understood to be those of the SAE and the automotive industry. Many of our switches meet other standards as well, such as USCG, ABYC, US Mine Safety & Health Administration. For OEMs we can design a switch to meet or exceed any standard.

For over a century, Underwriters' Laboratories (UL) has been a third-party trusted source worldwide for product compliance.

Having the UL mark on our products means that UL has tested and evaluated representative samples of that product and determined that they meet the stringent UL requirements. Products are continually checked by UL to make sure they continue to meet those requirements — UL inspectors visit the Cole Hersee factory every quarter to check on certified products. UL marks may be only used on products certified by UL and under the terms of a written agreement between UL and Cole Hersee.

Visit the UL website, [www.ul.com](http://www.ul.com) where you can find us listed under 'Cole-Hersee'.

UL certified products are accepted in the US and Canada by OSHA, insurance companies, labor unions, fire officials and electrical inspectors.

**The UL Listing Mark**

One of the most common UL Marks, found on many Cole Hersee products. It means UL found that samples of this product met the UL safety requirements that are primarily based on UL's own published Standards for Safety.

**The UL Marine Mark**

These products have been tested specifically for marine use, and have been evaluated to UL's published Marine Safety Standards and other applicable standards and codes. These requirements specifically relate to hazards that can occur as a result of exposure to harsh marine environments - vibration, impact, ignition protection, water ingress and salt spray corrosion common on pleasure craft and boats.

Many of our marine switches also conform to applicable ABYC and USGC standards.

American Boat & Yacht Council: [www.abycinc.org](http://www.abycinc.org)  
United States Coast Guard: [www.uscg.mil](http://www.uscg.mil)

We provide UL certification because our customers may be mandated to install UL-marked products. There are costs associated with UL certification and ongoing testing and auditing, and therefore UL-labeled switches may be slightly more expensive than their unmarked counterparts.

**The CE Mark**

The CE mark is a European mark analogous to UL. It similarly denotes that a product has undergone assessment procedures complies with European standards that apply to the product. The designation "CE" is French for "Conformité Européen".

## Battery Selector & Master Disconnect Switches

Key to diagrams: L = starter & load, SW = Battery Selector & Master Disconnect Switch, BAT = battery, ISO = Battery Isolator, COM = common, ALT = alternator

### M-750 & M-751

Download instruction form IF-63 from our website.

#### One engine and two batteries

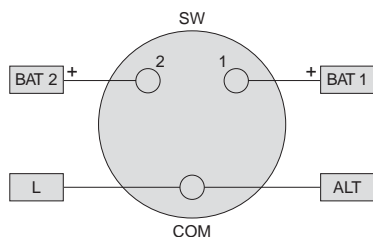

#### Two engines and two batteries

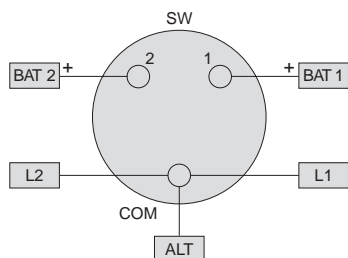

#### One engine, two batteries, with battery isolator

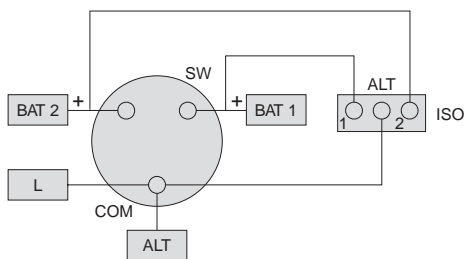

#### Two engines, two batteries, two switches

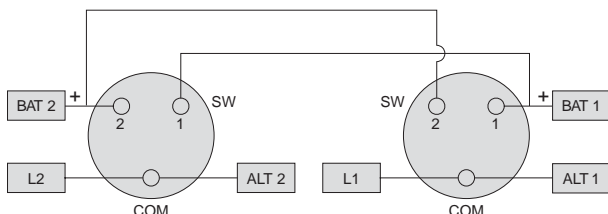

### M-752 & M-753

Download instruction form IF-130 from our website.

#### One engine and two batteries

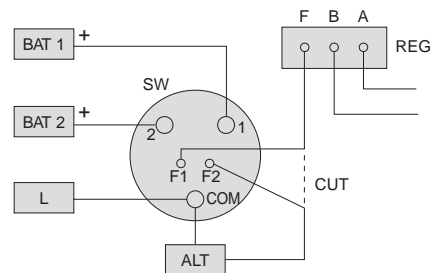

#### Two engines and two batteries, with battery isolator

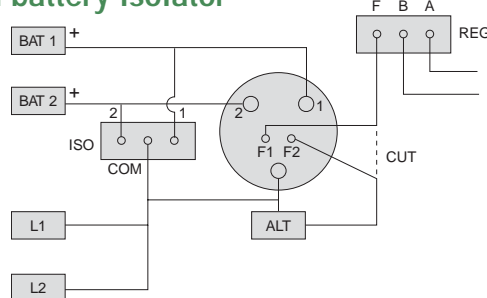

### M-754 & M-754-01, M-755 & M-755-01

Download instruction form IF-121-1 from our website.

#### One engine and two batteries

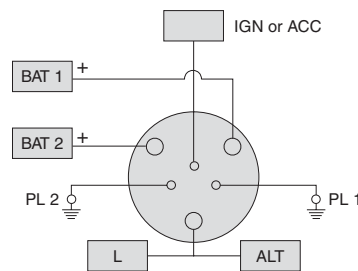

#### Two engines and two batteries

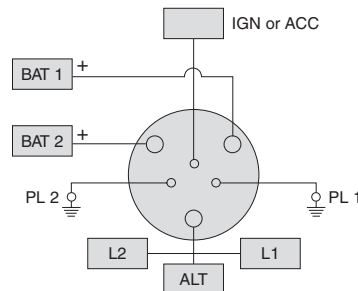

CONTINUED J5

## Two engines, two batteries, two switches

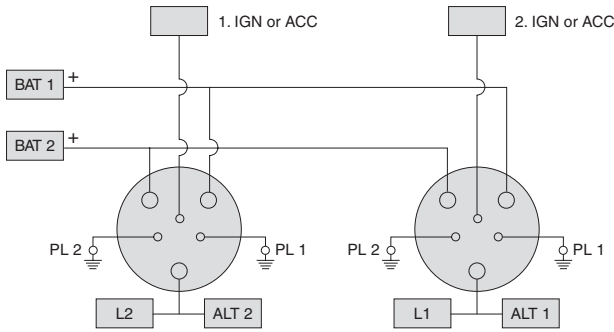

## One engine and two batteries, with battery isolator

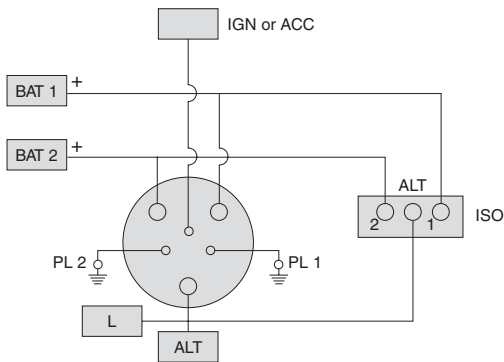

## Battery Isolators

### 4-stud type

48092, 48122 and 48162.

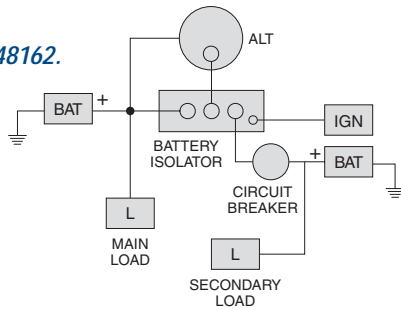

### 3-stud type

48070, 48080, 48090, 48120, 48160, and 48161.

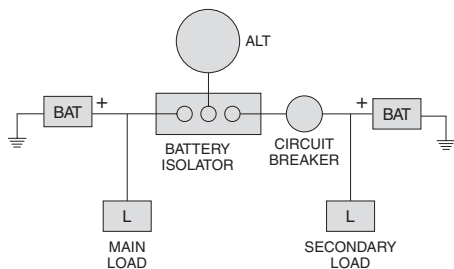

## Master Disconnect Switches

### SPST Switches

Download instruction form IF-126 from our website.

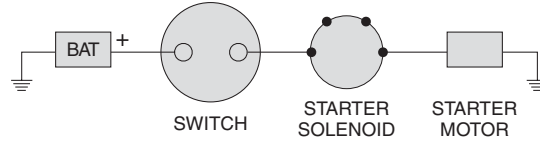

### DPST Switches

Download instruction form IF-109 from our website.

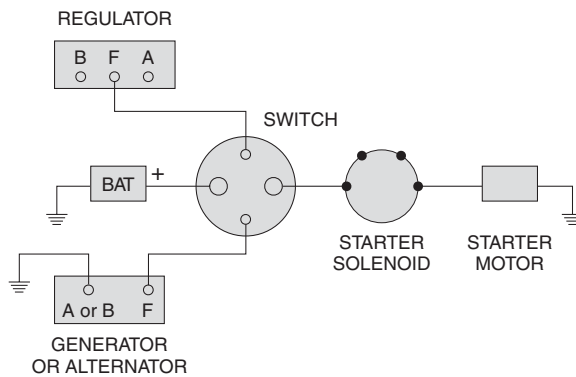

### 75912 Switch

For two high current loads.

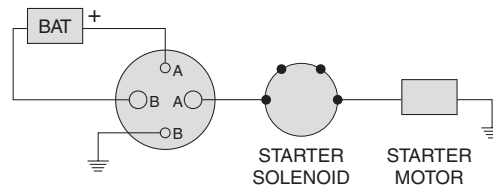

# solenoids & relays

H



|  |    |
|--|----|
| STEEL & PHENOLIC BODY SOLENOIDS          | H1 |
| PVC COATED SOLENOIDS WITH STEEL HOUSINGS | H2 |
| PLASTIC BODY SOLENOIDS                   | H3 |
| ELECTRONIC SOLENOIDS                     | H4 |
| RELAYS                                   | H5 |
| INFORMATION ON SOLENOIDS                 | H6 |

## solenoids & relays

### H1 STEEL & PHENOLIC BODY SOLENOIDS

#### Continuous Duty

85A except where noted. Normally Open Contacts, SPST, One circuit: Off - On Housings: Plated steel (Phenolic where noted). Contacts: Copper 5/16" -24 thread, hexnuts and lockwashers included. 200A solenoids have silver contacts. Coil, ignition and ground terminals: Steel 10-32 thread, hexnuts and lockwashers included. Bracket mounting holes 5/16" x 19/32" (7.9 x 15.1) on 2 13/64" centers (56.0mm).

#### 48V insulated

See Section H3: 24848 heavy duty.

#### 36V insulated

Available in Plastic Body (section H3): 24636, 24836 heavy duty.

24080

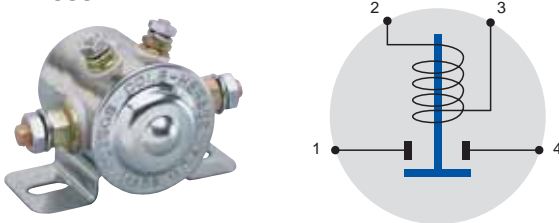

PVC coated model: see 24135

24080-01 UL-listed



Same as 24080, but UL and CE rated. Continuous Rating: 65A at 36V DC. Intermittent rating: 120A make, 65A break. 10 sec On, 30 min Off.

PVC coated model: see 24135-01

#### 24V insulated

Also available in Plastic Body (section H3): 24624-10.

24063 ★

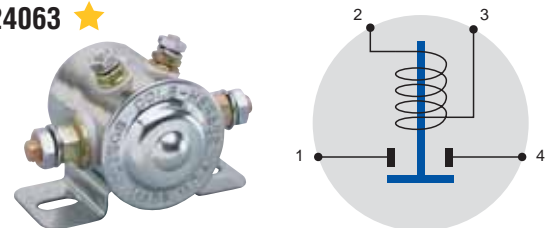

PVC coated and UL-rated model: see 24063-08

24107

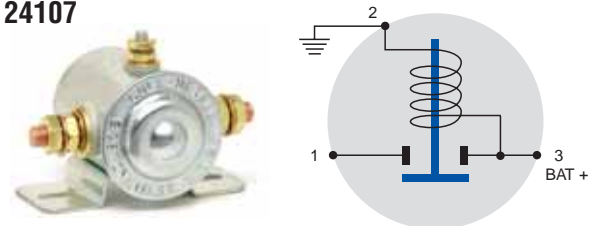

24144 200A ★

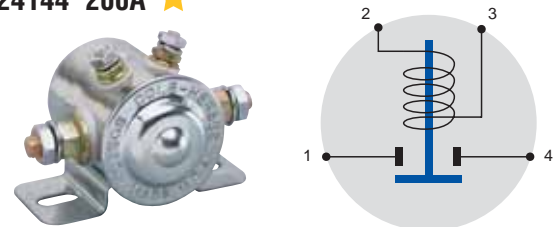

Electrical Rating: 200A carry only. Not to break 200A at 24V DC. Silver contacts.

CONTINUED **H1**

★ Rapid ship item. BP Available in retail clamshell pack. \*Minimum order quantity may apply.



# H solenoids & relays

H1 STEEL & PHENOLIC BODY SOLENOIDS

## 24V grounded

24124 ★

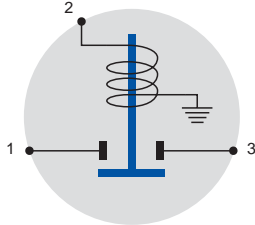

## 12V insulated

24115

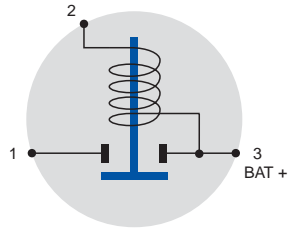

24059 BP ★

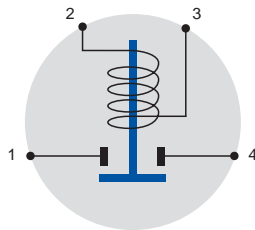

PVC coated model: see 24117

24059-08 UL listed BP ★



Same as 24059, but UL and CE rated.  
Continuous Rating: 65A at 12V DC. Intermittent rating:  
750A make, 100A break. 10 sec On, 30 min Off. Circuit G1.

PVC coated model: see 24117-01

24143 200A ★

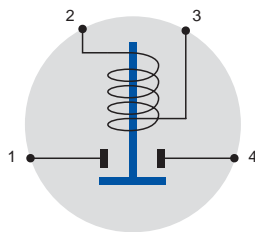

Electrical Rating: 200A. Silver contacts.

## 24420 Normally On

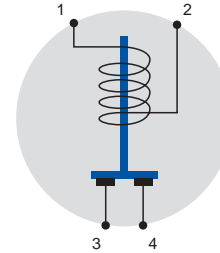

Continuous Duty 35A.

## 12V grounded

Also available in Plastic Body (section H3): 24612-G10.

24106 BP ★

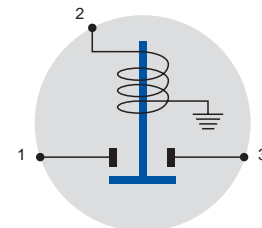

## 24082 curved bracket ★

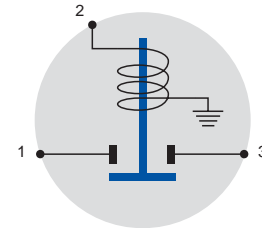

## 6V

### 24097 insulated

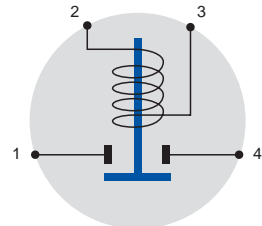

### \*24105 grounded

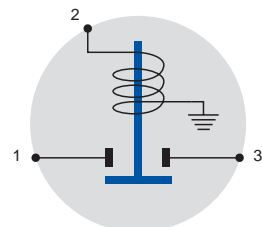

★ Rapid ship item. BP Available in retail clamshell pack. ★ Minimum order quantity may apply.

## Two circuits, DPST

*Normally Off and Normally On. Special application: for forward and reverse systems in electric golf carts, garden tractors, fork lift trucks, winches, etc. Housing: Steel. Continuous Duty, Normally Closed contacts 35A, Normally Open contacts 85A.*

### 24400 36V insulated

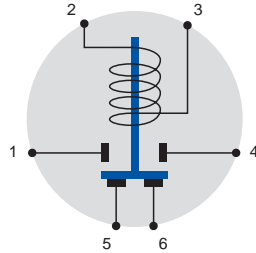

### 24402 24V insulated

Schematic and picture same as 24400.

### 24401 12V insulated ★

Schematic and picture same as 24400.

*PVC coated model: see 24401-04.*

### 24401-01 12V grounded ★

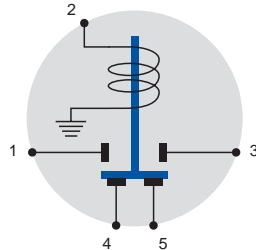

## motor reversing

Typical DC series wound permanent magnet circuit, using a pair of double-action solenoids. Use pairs of the following solenoids: 24401 (12V), 24402 (24V), or 24400 (36V).

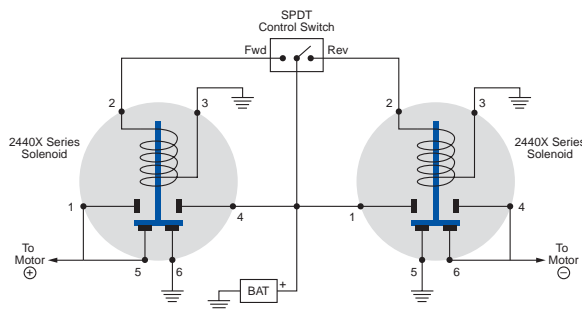

## Latching Solenoid

*12V Continuous Duty, 110A (carry only). Insulated. Plated steel housing. Requires only a momentary application of coil power to operate. Very little heat is generated, because the coil is de-energized when the solenoid is On.*

### 24200

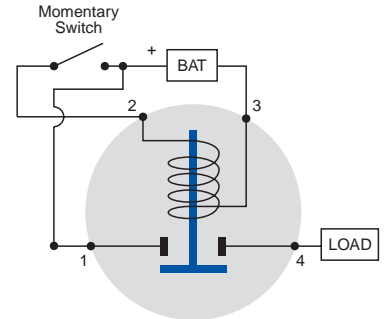

## the latching solenoid

This special solenoid toggles On and Off, and requires no current to maintain the continuity of the power circuit. Use it with a momentary switch (see Momentary Switches). Actuation of the momentary switch causes current to flow in the solenoid coil, locking the contact in place, maintaining the load circuit in an On position. A second actuation of the momentary switch releases the plunger, turning the load circuit Off.

Suggested momentary switches: 55037, 58027-02.

### Special Applications

#### Remote battery isolator

In a two-battery system, use the Latching Solenoid to isolate the batteries from each other, and prevent battery drain from the higher into the lower. It has an advantage over electronic Battery Isolators (see Battery-Related Products), in that it will not produce a voltage drop during operation.

#### Remote battery disconnect

Use it as a remote Battery Disconnect Switch. This eliminates the need for heavy gauge wiring between the control panel and the battery.

CONTINUED **H1**

★ Rapid ship item. BP Available in retail clamshell pack. ★ Minimum order quantity may apply.

# H solenoids & relays

**H1** STEEL & PHENOLIC BODY SOLENOIDS

## Intermittent Duty

**Normally Off, SPST, One circuit: Off - On**  
 750A make, 100A break, 10sec On, 20min Off, except where noted. Contacts: Copper. Terminals: Copper. Small ignition and ground terminals are 10-32 thread. Large contact terminals are 5/16" -24 thread. Hexnuts and lockwashers are included. Bracket mounting holes 5/16 x 19/32," 2 13/64" on centers (7.9 x 15.1, 56.0mm) and plated steel housing, except where noted.

### 24V insulated

120A make, 65A break. 10 sec On, 30 min Off.

24008 ★

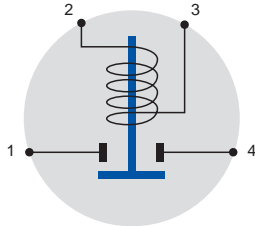

24044, angled bracket ★



24020 phenolic housing, curved bracket



24022 phenolic housing ★



Bracket mounting holes 9/32" x 25/64," 2 7/64" on centers (7.1 x 9.9, 53.6mm).

24104

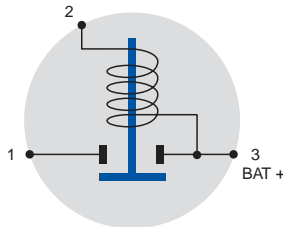

### 12V grounded

Also available in Plastic Body (section H3): 24712-GS7, 24612-G13.

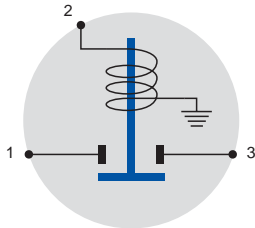

### 12V grounded, Resistor Shorting Circuit

In this application, 3 is Normally Open. It becomes common with 1 and 4 when the solenoid is energized. Commonly used in engine starting applications.

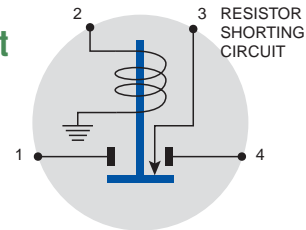

24037 ★



PVC coated model: see 24071.

24103



24021 phenolic housing ★



Bracket mounting holes 9/32 x 1/2," 2 13/64" on centers (7.2 x 12.7, 56.0mm). Contact terminal 5/16" -24 thread.

M-202 marine



Marine construction. Clear protective finish, brass hexnuts and lockwashers.

★ Rapid ship item. BP Available in retail clamshell pack. ★ Minimum order quantity may apply.

**H1** STEEL & PHENOLIC BODY SOLENOIDS

**24138 phenolic, with breather**

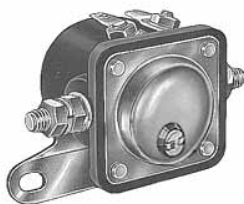

Bracket mounting holes 9/32 x 1/2," 2 13/64" on centers (7.2 x 12.7, 56.0mm). Contact terminal 5/16" -24 thread.

**12V insulated**

Also available in Plastic Body (section H3): 24512-03, 24512-13, 24612-13, 24712-S6, 24712-S7.

**24047 ★**

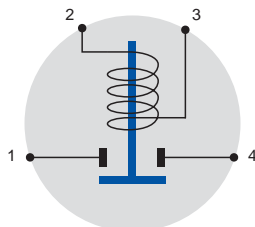

PVC coated model: 24076

**M-200 marine BP**

Same as 24047, but marine construction. Clear protective finish, brass hexnuts and lockwashers.

**M-200-01 marine, UL listed**



Same as M-200, but with UL & CE listing. Intermittent rating: 750A make, 100A break. 10 sec On, 30 min Off.

**24060**

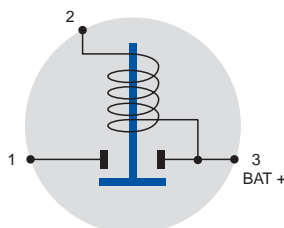

**24046**

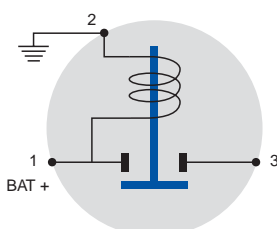

PVC coated model: 24077

**24023 phenolic housing**

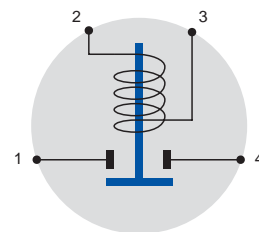

Bracket mounting holes 5/16" x 9/32," 2 9/16" on centers (8.1 x 7.2, 65.1mm).

**2430 phenolic housing**

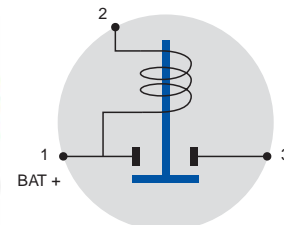

**6V grounded**

**24041**

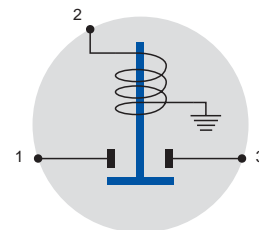

**24039 curved bracket**

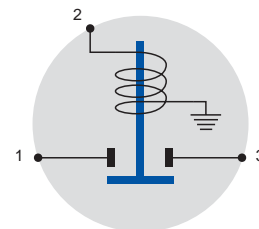

**6V insulated**

**24043**

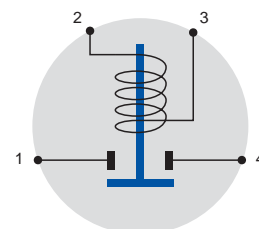

PVC COATED **H2**

★ Rapid ship item. BP Available in retail clamshell pack. ★ Minimum order quantity may apply.

# H solenoids & relays

## H2 PVC COATED SOLENOIDS WITH STEEL HOUSINGS

*Weatherproof: Housing is completely PVC coated.*

### Continuous Duty

**Insulated SPST, Normally Off (except 24401-04). One circuit: Off - On. Bracket mounting holes 5/16" x 19/32" (7.9 x 15.1) on 2 13/64" centers (56.0mm).**

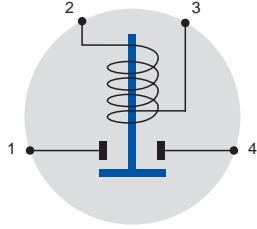

**36V**

**24135**

Continuous Duty: 85A.  
Without PVC coating: see 24080

**24135-01 UL listed**



Continuous Duty: 65A at 36V DC  
Intermittent Duty: 120A make, 65A break. 10 sec On, 30 min Off.  
Without PVC coating: see 24080-01

**24V**

**24063-08 UL listed** ★



Continuous Duty: 65A at 24V DC  
Intermittent Duty: 120A make, 65A break. 10 sec On, 30 min Off.  
Without PVC coating and UL rating: see 24063

**12V**

**24117** ★

Continuous Duty: 85A.  
Without PVC coating: see 24059

**24117-01 UL listed** BP ★



Continuous Duty: 65A at 12V DC  
Intermittent Duty: 750A make, 100A break. 10 sec On, 30 min Off.  
Without PVC coating: see 24059-08

**12V SPDT**

**24401-04**

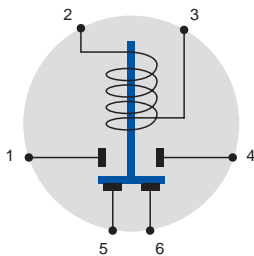

Normally Closed contacts 35A, Normally Open contacts 85A.  
Without PVC coating: see 24401

★ Rapid ship item. BP Available in retail clamshell pack. ★ Minimum order quantity may apply.

### Intermittent Duty

**SPSAT, normally Off, 750A make, 100A break 750A make, 100A break. 10 sec On, 20 min Off. Bracket mounting holes 5/16 x 11, 2 13/64" on centers (7.9 x 15.1, 56.2mm). Contact terminals 5/16" -24 thread.**

**24076, insulated** ★

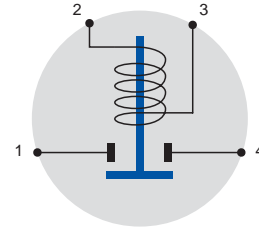

Without PVC coating: see 24047

**24077, insulated**

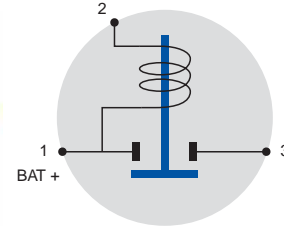

Without PVC coating: see 24076

**24071, grounded**

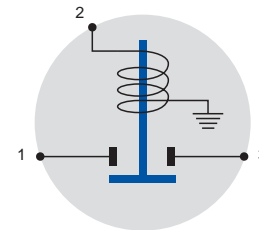

Without PVC coating: see 24037

## solenoid info

See Section H6, and visit our website for an interactive training session on Solenoids.

## H3 PLASTIC BODY SOLENOIDS

Glass-filled nylon construction - lightweight, durable and resistant to corrosion.

### Continuous Duty, 100A

For starting small engines, including lawn tractors, golf carts and sweepers. SPST normally open contacts. 100A make and break, 400A inrush. Silver contacts. Large studs: 5/16"-24. 12V type: maximum operating voltage 14V DC. 24V type: maximum operating voltage 27V DC. 36V type: maximum operating voltage 36V DC. Cycle life: 50,000 minimum. Bracket mounting holes 5/16" x 19/32" (7.9 x 15.1) on 2 13/64" centers (56.0mm).

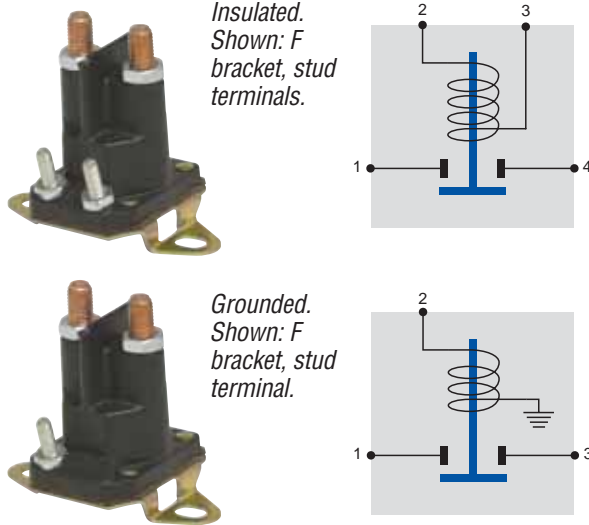

### Intermittent Duty, 200A

For starting small engines, including lawn tractors, golf carts and sweepers. 12V DC. SPST normally open contacts. 200A make and break, 5 secs On, 5 secs Off, 300A inrush. (Sealed solenoids 200A make and break, 5 secs On, 5 secs Off. 500A inrush, maximum On time 20 secs.) Allow at least 40 secs cooling after maximum On time. Copper contacts. Maximum operating voltage 14V DC. Cycle life: 10,000 minimum. Sealed solenoids are protected against ingress of contaminants such as oil or gasoline, dirt and moisture. Bracket mounting holes 5/16" x 19/32" (7.9 x 15.1) on 2 13/64" centers (56.0mm).

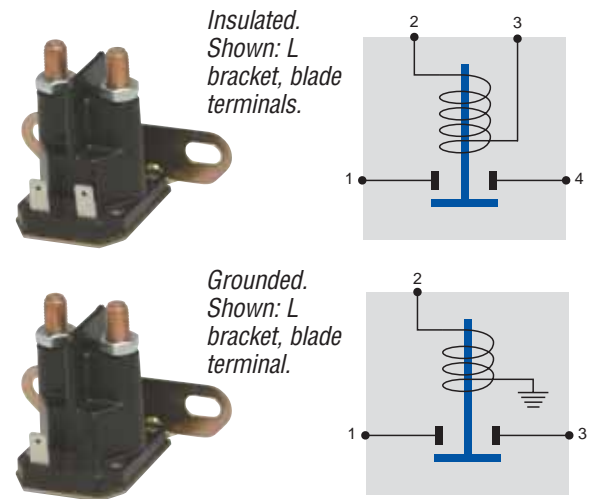

### 36V

**24636 insulated**  
L bracket, two 10-32 stud coil terminals.

### 24V

**24624-10 insulated**  
F bracket, two 10-32 stud coil terminals.

### 12V

**24512-10 insulated** BP  
F bracket, two blade coil terminals.

**24612 insulated**  
L bracket, two 10-32 stud coil terminals.

**24612-10 insulated**  
F bracket, two 10-32 stud coil terminals.

**24612-G10 grounded** BP  
F bracket, one 10-32 stud coil terminal.

### Insulated 12V

**24512-03 blade terminals, L bracket** BP  
5/16" -24 large studs, two blade coil terminals.

**24512-13 blade terminals F bracket**  
5/16" -24 large studs, two blade coil terminals.

**24612-03 stud terminals, L bracket** BP  
5/16" -24 large studs, two 10-32 stud coil terminals.

**24612-13 stud terminals, F bracket**  
5/16" -24 large studs, two 10-32 stud coil terminals.

**24712-S6 sealed, L bracket**  
1/4" -20 large studs, two 8-32 stud coil terminals.

**24712-S7 sealed, F bracket**  
1/4" -20 large studs, two 8-32 stud coil terminals.

### Grounded 12V

**24612-G13** BP  
5/16" -24 large studs, one 10-32 stud coil terminal.

**24712-GS7 sealed** BP  
1/4" -20 large studs, one 8-32 stud coil terminal.

CONTINUED **H3**

★ Rapid ship item. BP Available in retail clamshell pack. ★ Minimum order quantity may apply.

# H solenoids & relays

**H3** PLASTIC BODY SOLENOIDS

## Heavy Service, 225A

*For use with heavy vehicles, materials handling, hydraulic systems, large DC machinery, and electric vehicles. SPDT normally open contacts. Insulated. 12-48V DC.*

*L bracket. Large studs: 5/16" -24, two 10-32 stud coil terminals. 12V silver contact, 50k cycles. Copper contact. Maximum operating voltage 14V DC, cycle life 25,000 minimum. 36V type: maximum operating voltage 36V DC, cycle life 50,000 minimum. 48V type: maximum operating voltage 48V DC. Cycle life: 50,000 minimum. Bracket mounting holes 5/16" x 19/32" (7.9 x 15.1) on 2 13/64" centers (56.0mm). Other types available by special order.*

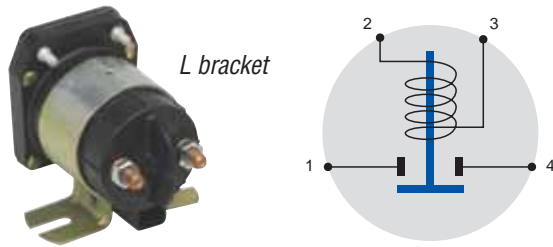

## Continuous Duty

*225A make and break, 600A inrush.*

**24848 48V**  
Silver contacts.

**24836 36V**  
Silver contacts.

**24824-01 24V**  
Silver contacts.

**24812 12V**  
Copper contacts.

**24812-01 12V**  
Silver contacts.

## Intermittent Duty

*600A inrush.*

**24824-04 24V**  
Copper contacts.

**24812-04 12V**  
Copper contacts.

## Motor Reversing Solenoid 12V

*DPDT intermittent duty. 12V DC. Common ground coil. Two blade coil terminals, 5/16" -24 large studs. Copper contacts. F bracket. 75A make and break, maximum On time 5 mins. 125A make and break, maximum On time 30 secs. 150A make and break, maximum On time 0.5 secs. Allow 5 mins Off after max On time. Maximum operating voltage 14.5V DC. Cycle life 10,000 cycles at 5 secs On, 25 secs Off. Shipped with mounting hardware.*

*Use in conjunction with one of many types of Cole Hersee SPDT momentary switches: rocker (such as 58027-04), rotary (such as 72154-01/02) or ignition-type keyed switch (such as 75705-01).*

*Also available as 24V: 24450-02 with same rating as 24450. Contact Cole Hersee.*

**24450 BP**

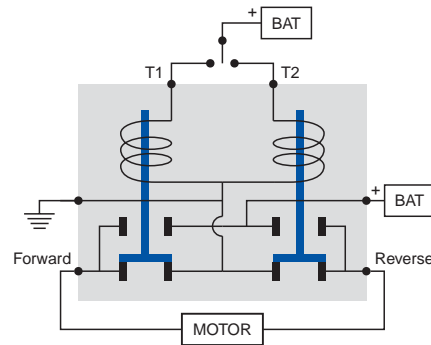

## reversing solenoid

For reversing motors such as hoists, winches, windlasses, ATVs and snowplow blades. Two solenoids in one for cost and space savings and simpler wiring. Two integral solenoids provide dynamic braking for permanent magnet motors when neither coil is energized.

★ Rapid ship item. BP Available in retail clamshell pack. ★ Minimum order quantity may apply.

## Electronic Solenoid

### 48785 Electronic Solenoid 85A 9-31V DC ★

Fully solid-state, with no moving parts to wear out. The Electronic Solenoid stands up to over 20 million On-Off cycles. It is completely sealed, ignition protected, and withstands vibration and adverse environments. Perfect for vehicles that are always on the move. Use the Electronic Solenoid in both 12V or 24V applications... or any voltage between 9 and 31V.

- Solenoid can be used in both High Side and Low Side switching applications.
- Needs only a very low control current.
- Suitable for high inrush demand circuits.



#### Specifications:

9 - 31V DC, 85A continuous or 175A intermittent.

Low On resistance of .005Ω

Low control current of .02A (max) means lighter wires, smaller harnesses.

On/Off control voltage must be identical to the system voltage.

Wide temperature operating range -40°C to + 85°C without derating.

Protected from transient voltage spikes or surges.

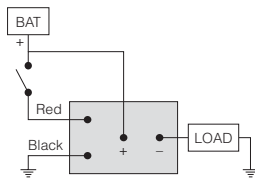

High side switching application

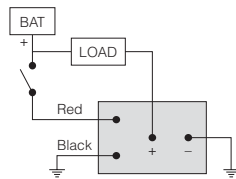

Low side switching application



## emergency cutoff

Emergency cutoff switches are commonly mounted on many types of vehicles such as buses, and those used in construction and agriculture. Fire departments routinely familiarize themselves with the location of cutoffs, so that vehicles can quickly be isolated in case of emergency. Additionally, OSHA requires cutoffs on certain vehicles, particularly those with ancillary motorized equipment, such as garbage trucks. See Section J2.



### Heavy Duty & High Power Relays

**General purpose relays fit many vehicles. Typical applications include: lighting, starting, horn, heating and cooling. Standard ISO terminal footprint for Form A (SPST), Form C changeover (SPDT) and Form 2A (SPST, 2 terminals). Relays are available sealed and unsealed (unsealed are supplied with snap-in brackets.)**

#### Specifications:

Pull-in voltage: 7.8V maximum at 12V DC, 15.6V at 24V DC.

Release voltage: 1.2V minimum at 12V DC, 2.4V at 24V DC.

Temperature range: -40°C to 85°C.

Operational life: Electrical to 100,000 cycles; Mechanical to 10 million cycles.

Contact Material: Silver alloy.

Dielectric strength: 500V rms between coil and contact.

Insulation resistance: 100M $\Omega$  minimum (500V DC).

Vibration resistance: 10-40Hz double amplitude 1.5mm.

Cole Hersee Relays are rated based on a steady state resistive load. De-rate according to the type of load: Motor load: Inrush can be 5 to 10 x steady state current. Solenoid load: Inrush can be 10 to 20 x steady state current. Incandescent lamp load: Inrush can be 10 to 15 x steady state current.

Relays are also available with PC terminals. Contact Cole Hersee.

### Heavy Duty Relays 40A at 12V DC



#### Specifications:

Contact rating (Resistive load) at 20°C:

12V DC: Normally Open 40A, Normally Closed 30A.

24V DC: Normally Open 20A, Normally Closed 15A.

Contact arrangement: Available as Form A (SPST), Form C (SPDT) and Form 2A (SPST, 2 terminals).

### High Power Relays 70A at 12V DC



#### Specifications:

Contact rating (Resistive load) at 20°C:

12V DC: Normally Open 70A, Normally Closed 60A.

24V DC: Normally Open 35A, Normally Closed 30A.

Contact arrangement: Available as Form A (SPST) and Form C (SPDT).

### Relay Schematics & Terminal Layouts

Other configurations are available by special order.

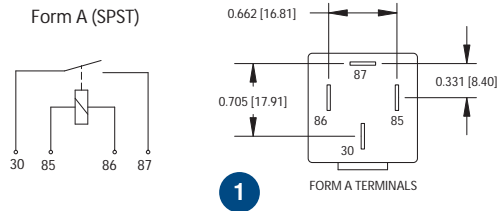

40A Type has .250" terminals. 70A Type has .375" terminals.

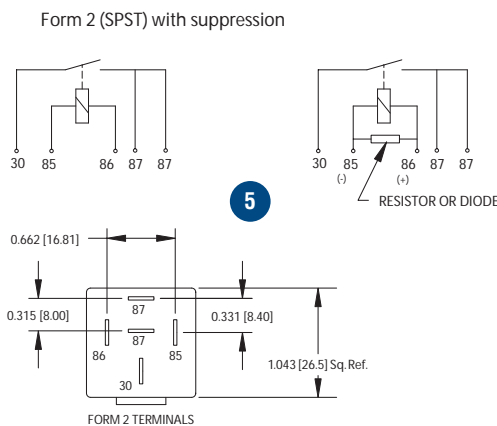
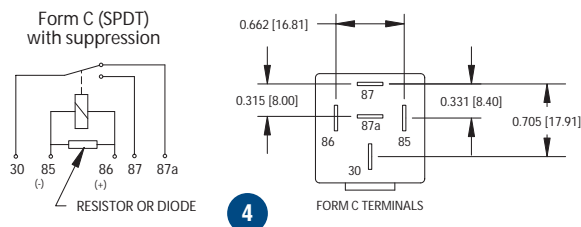
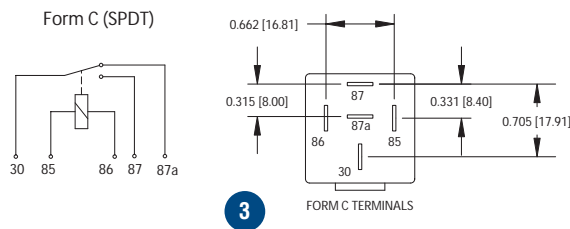
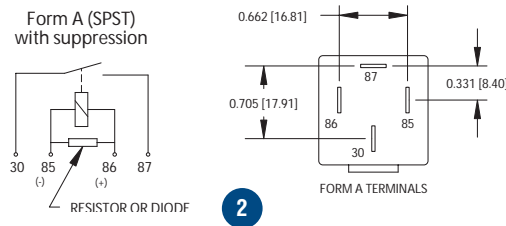

## Relay Part Number Structure

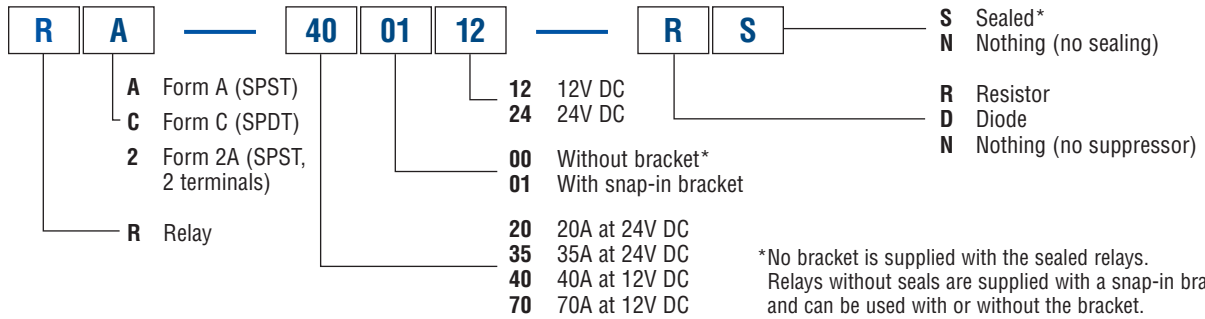

## Relay Stock Items

Other configurations, and PC terminals are available. Contact Cole Hersee.

| FORM    | AMPERAGE | BRACKET    | VOLTAGE | SUPPRESSOR  | SEAL       | PART NUMBER                  | DIAGRAM |
|---------|----------|------------|---------|-------------|------------|------------------------------|---------|
| A: SPST | 40       | 01 Snap-in | 12      | N: none     | N: no seal | RA-400112-NN <span>BP</span> | 1       |
| A: SPST | 40       | 01 Snap-in | 12      | R: resistor | N: no seal | RA-400112-RN <span>BP</span> | 2       |
| A: SPST | 40       | 01 Snap-in | 12      | D: diode    | N: no seal | RA-400112-DN <span>BP</span> | 2       |
| A: SPST | 20       | 01 Snap-in | 24      | N: none     | N: no seal | RA-200124-NN <span>BP</span> | 1       |
| A: SPST | 20       | 01 Snap-in | 24      | R: resistor | N: no seal | RA-200124-RN <span>BP</span> | 2       |
| A: SPST | 20       | 01 Snap-in | 24      | D: diode    | N: no seal | RA-200124-DN <span>BP</span> | 2       |
| A: SPST | 40       | 00 None    | 12      | D: diode    | S: sealed  | RA-400012-DS <span>BP</span> | 2       |
| A: SPST | 20       | 00 None    | 24      | D: diode    | S: sealed  | RA-200024-DS <span>BP</span> | 2       |
| C: SPDT | 40       | 01 Snap-in | 12      | N: none     | N: no seal | RC-400112-NN <span>BP</span> | 3       |
| C: SPDT | 40       | 01 Snap-in | 12      | R: resistor | N: no seal | RC-400112-RN <span>BP</span> | 4       |
| C: SPDT | 40       | 01 Snap-in | 12      | D: diode    | N: no seal | RC-400112-DN <span>BP</span> | 4       |
| C: SPDT | 20       | 01 Snap-in | 24      | N: none     | N: no seal | RC-200124-NN <span>BP</span> | 3       |
| C: SPDT | 20       | 01 Snap-in | 24      | R: resistor | N: no seal | RC-200124-RN <span>BP</span> | 4       |
| C: SPDT | 20       | 01 Snap-in | 24      | D: diode    | N: no seal | RC-200124-DN <span>BP</span> | 4       |
| C: SPDT | 40       | 00 None    | 12      | D: diode    | S: sealed  | RC-400012-DS <span>BP</span> | 4       |
| C: SPDT | 20       | 00 None    | 24      | D: diode    | S: sealed  | RC-200024-DS <span>BP</span> | 4       |
| 2: SPST | 20       | 01 Snap-in | 24      | R: resistor | N: no seal | R2-200124-RN                 | 5       |
| 2: SPST | 40       | 01 Snap-in | 12      | R: resistor | N: no seal | R2-400112-RN                 | 5       |
| A: SPST | 70       | 01 Snap-in | 12      | N: none     | N: no seal | RA-700112-NN <span>BP</span> | 1       |
| A: SPST | 70       | 01 Snap-in | 12      | R: resistor | N: no seal | RA-700112-RN <span>BP</span> | 2       |
| A: SPST | 70       | 01 Snap-in | 12      | D: diode    | N: no seal | RA-700112-DN <span>BP</span> | 2       |
| C: SPDT | 70       | 01 Snap-in | 12      | N: none     | N: no seal | RC-700112-NN <span>BP</span> | 3       |
| C: SPDT | 70       | 01 Snap-in | 12      | R: resistor | N: no seal | RC-700112-RN <span>BP</span> | 4       |
| C: SPDT | 70       | 01 Snap-in | 12      | D: diode    | N: no seal | RC-700112-DN <span>BP</span> | 4       |

CONTINUED **H5**

★ Rapid ship item. BP Available in retail clamshell pack. ★ Minimum order quantity may apply.

## MicroRelays 25A at 12V DC

*MicroRelays fit many vehicles and applications. They have a reduced size, but can accept a 25A load. Typical applications include: lamp control, horns, power windows, fuel pumps, fans and lifts gates. Standard terminal footprint for Form A (SPST), Form C changeover (SPDT) MicroRelays are available sealed and unsealed.*



### Specifications:

Contact rating (Resistive load) at 20°C:

12V DC: Normally Open 25A, Normally Closed 20A.

24V DC: Normally Open 15A, Normally Closed 10A.

Contact arrangement: Available as Form A (SPST), and Form C (SPDT).

Vibration resistance: 10-40Hz double amplitude 1.27mm.

Pull-in voltage: 7.8V maximum at 12V DC, 15.6V at 24V DC.

Release voltage: 1.2V minimum at 12V DC, 2.4V at 24V DC.

Temperature range: -40°C to 85°C.

Operational life: Electrical to 100,000 cycles. Mechanical to 10 million cycles.

Contact Material: Silver alloy.

Dielectric strength: 500V rms between coil and contact.

Insulation resistance: 100MΩ minimum (500V DC).

**Cole Hersee Relays are rated based on a steady state resistive load. De-rate according to the type of load:**

Motor load: Inrush can be 5 to 10 x steady state current.

Solenoid load: Inrush can be 10 to 20 x steady state current.

Incandescent lamp load: Inrush can be 10 to 15 x steady state current.

*MicroRelays are also available with PCB terminals: contact Cole Hersee.*

## MicroRelay Schematics & Terminal Layouts

Other configurations are available by special order.

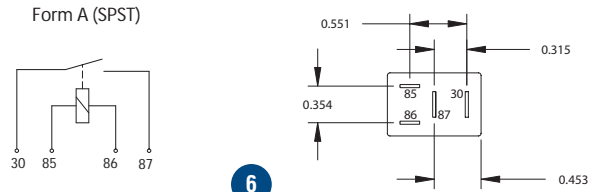

6

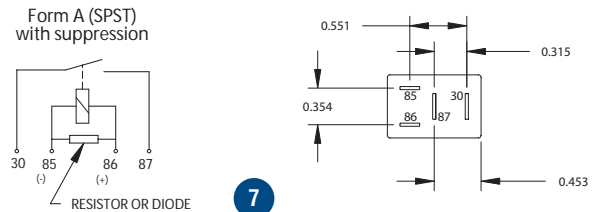

7

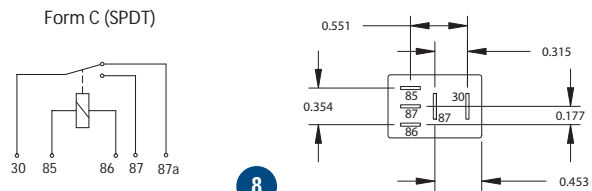

8

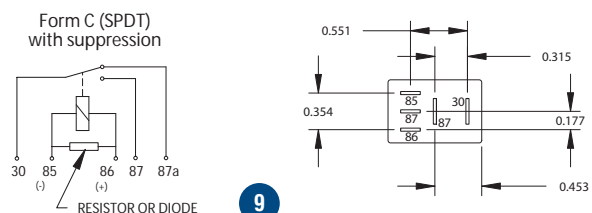

9

## MicroRelay Part Number Structure

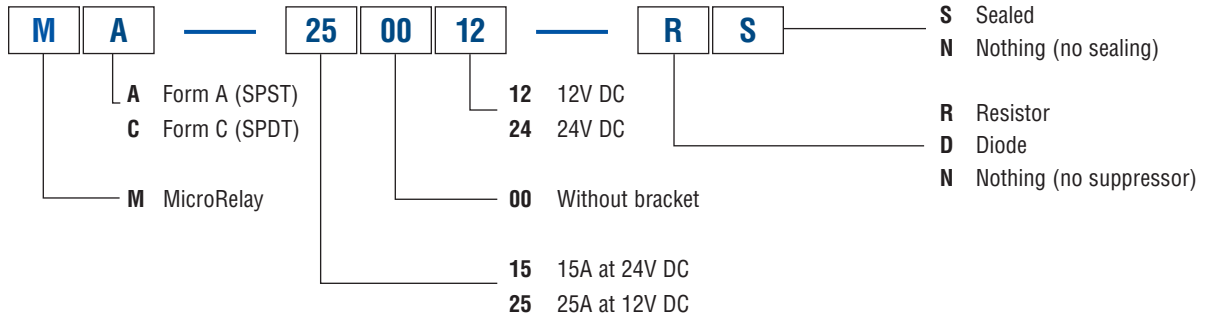

## MicroRelay Stock Items

Other configurations, and PC terminals are available. Contact Cole Hersee.

| FORM    | AMPERAGE | VOLTAGE | SUPPRESSOR  | SEAL       | PART NUMBER  | DIAGRAM |
|---------|----------|---------|-------------|------------|--------------|---------|
| A: SPST | 25       | 12      | R: resistor | N: no seal | MA-250012-RN | 7       |
| A: SPST | 25       | 12      | R: resistor | S: sealed  | MA-250012-RS | 7       |
| A: SPST | 25       | 12      | D: diode    | N: no seal | MA-250012-DN | 7       |
| A: SPST | 25       | 12      | N: none     | N: no seal | MA-250012-NN | 7       |
| A: SPST | 15       | 24      | R: resistor | N: no seal | MA-150024-RN | 7       |
| A: SPST | 15       | 24      | R: resistor | S: sealed  | MA-150024-RS | 7       |
| A: SPST | 15       | 24      | D: diode    | N: no seal | MA-150024-DN | 7       |
| A: SPST | 15       | 24      | N: none     | N: no seal | MA-150024-NN | 6       |
| C: SPDT | 25       | 12      | R: resistor | N: no seal | MC-250012-RN | 9       |
| C: SPDT | 25       | 12      | R: resistor | S: sealed  | MC-250012-RS | 9       |
| C: SPDT | 25       | 12      | D: diode    | N: no seal | MC-250012-DN | 9       |
| C: SPDT | 25       | 12      | N: none     | N: no seal | MC-250012-NN | 8       |
| C: SPDT | 15       | 24      | R: resistor | N: no seal | MC-150024-RN | 9       |
| C: SPDT | 15       | 24      | R: resistor | S: sealed  | MC-150024-RS | 9       |
| C: SPDT | 15       | 24      | D: diode    | N: no seal | MC-150024-DN | 9       |
| C: SPDT | 15       | 24      | N: none     | N: no seal | MC-150024-NN | 8       |

CONTINUED **H5**

# H solenoids & relays

## H5 RELAYS

### Relay Sockets

*Accepts Cole Hersee relays and standard ISO relays. Modular – sockets dovetail together. Accepts standard quick-connect terminals. Easy mount bracket. Constructed of rugged glass-filled polyamide. Temperature range -40F to 85C.*

#### 99025 High Power Socket



For use with Cole Hersee High Power Relays. Form A (SPST)  
Use with Tyco (AMP) terminals 280756 or 280755 (consult terminal manufacturers for full specs).

#### 99026 Heavy Duty Socket



For use with Cole Hersee Heavy Duty Relays. Form A (SPST) or Form C (SPDT).  
Use with Tyco (AMP) terminals 42281 or Ark-Les 3000H112A series (consult terminal manufacturers for full specs).

# solenoids & relays

## H6 INFORMATION ON SOLENOIDS

Solenoids are relays which are commonly used to remotely switch a heavier current. By using a solenoid, the amount of heavy wiring needed to power the load is reduced, since the control circuit mounted inside the cab typically utilizes a smaller wire gauge.

Solenoids are commonly used to control starter and winch motors, and they have many other uses on vehicles of all kinds.

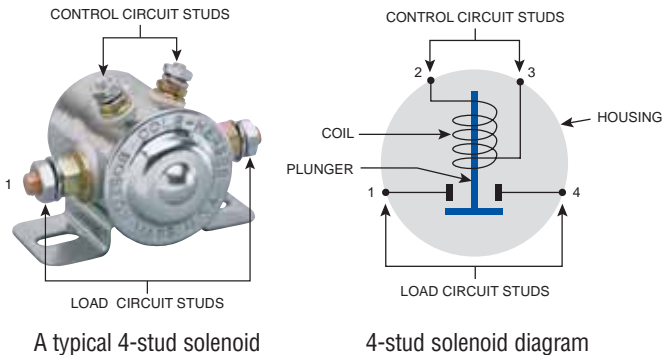

The diagram shows a magnetic coil surrounding a contact plunger. Before energization, the plunger is not electrically connected to the control circuit. When the control circuit is energized, the electromagnetic force induced in the coil attracts the plunger, which moves to close the load circuit. When the control circuit is de-energized, the spring-loaded plunger returns to its normal state and the load circuit is broken. In continuous duty applications, energization of the coil causes heating, therefore the solenoid housing will become warm even in normal operation.

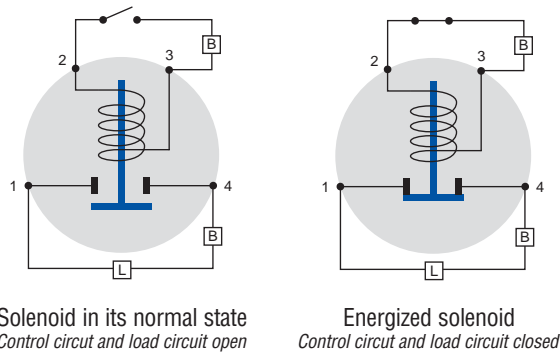

For more information on solenoids, visit the interactive training section of the Cole Hersee website:  
[www.colehersee.com](http://www.colehersee.com) > Resource Center > Training.

★ Rapid ship item. BP Available in retail clamshell pack. ★ Minimum order quantity may apply.

# momentary switches



G

|  |    |
|--|----|
| HEAVY DUTY PUSH-BUTTON SWITCHES          | G1 |
| MEDIUM DUTY PUSH-BUTTON SWITCHES         | G2 |
| TWO CIRCUIT PUSH-BUTTON SWITCHES         | G3 |
| MARINE CONSTRUCTION PUSH-BUTTON SWITCHES | G4 |
| SPECIAL MOMENTARY SWITCHES               | G5 |
| FLEXIBLE CAPS FOR PUSH-BUTTON SWITCHES   | G6 |
| DOOR MOMENTARY SWITCHES                  | G7 |

## momentary switches

### G1 HEAVY DUTY PUSH-BUTTON SWITCHES

For applications to 36V DC. Off - On, Normally Off. On with button depressed, spring return to Off. Silver contacts. Chrome plated button and face nut (except where noted).

#### Cylindrical housing 35A at 12V, 20A at 24V DC.

9095 **BP** ★



Two screw terminals. Mounting stem: 5/8"-32 thread, 21/32" (16.7mm) long.

#### 9216 with Seal

Same as 9095, except with O-ring seal in the mounting stem.

#### 9216-03 with Seal and Screw-on Cap



Same as 9095, except with O-ring seal in the mounting stem, and screw-on black rubber protective cap (83280-03).

#### 9245 with Seal and Snap-on Cap **BP** ★



Same as 9095, except with O-ring seal in the mounting stem, snap-on black rubber protective cap (407-03), and black plastic button.

#### 90036-02 with blade terminals



Same as 9095, except with 2 blade terminals to fit Delphi (Packard) 2973407 two-way connectors, or similar.

#### 9244-02\* with Seal, Screw-on Cap, Stud Terminals

Same as 9095, except with O-ring seal in the mounting stem and screw-on black rubber protective cap (83280-03), two 10-32 stud terminals with hexnuts and lockwashers, and black plastic button.

CONTINUED **G1**

# G momentary switches

G1 HEAVY DUTY PUSH-BUTTON SWITCHES

## 9155\* with large button



15/16" diameter button. 2 screw terminals with lockwashers. Mounting stem: 5/8"-32 thread, 21/32" (16.7mm) long.

## 9231 with protected button ★



With recessed facenut designed to prevent accidental actuation. 2 screw terminals. Mounting stem: 5/8"-32 thread, 21/32" (16.7mm) long.

## 90000-01\* with protected button, and seal

Same as 9231, except with O-ring seal in the mounting stem.

## 90030 with plastic button, and screw-on cap BP ★



Two screw terminals. Mounting stem: 5/8"-32 thread, 21/32" (16.7mm) long. With screw-on black rubber protective cap 83280-03.

## 90030-01 with plastic button, and oil-resistant cap

Same as 90030, except with brown oil-resistant cap 83280-05.

## 90030-04 with plastic button, and red screw-on cap

Same as 90030, except with Red screw-on protective cap 83280-02.

## 90011\* with plastic button, and button terminals



Two male button head terminals, accept Delphi (Packard) connector 2962679, or equivalent. Mounting stem: 5/8"-32 thread, 5/8" (15.9mm) long. Accepts screw-on protective cap 83280-03. Black plastic button.

## Rectangular housing

10A at 12V DC, except where noted.

9044



2 screw terminals. Mounting stem: 5/8"-32 thread, 1.06" (26.9mm) long. Gasket seal in the case.

## 9044-02\* with cap

Same as 9044, but with screw-on black rubber protective cap 83280-03.

## 9023 ★



15A resistive, 10A inductive at 12V DC, 8A resistive, 5A inductive at 24V DC. Two screw terminals. Mounting stem: 5/8"-32 thread, .87" (22.1mm) long.

## 9023-09 with cap

Same as 9023, but with screw-on black rubber protective cap 83280-03.

## 9238 with blade terminals ★

Same as 9023, but with blade terminals.

## 9238-01 with blade terminals, and cap

Same as 9023, but with blade terminals and black rubber screw-on cap 83280-03.

## 9023-A\* with silver contacts

Same as 9023, but with silver contacts, giving greater voltage range – 6-36V DC. 15A at 12V, 8A at 24V, 4A at 36V DC.

## more moms

You'll find more moms (or momentary switches) in the following catalog sections:

- Rocker Switches – Section A
- Toggle Switches – Section B
- Ignition Switches – Section C
- Rotary Switches – Section D

★ Rapid ship item. BP Available in retail clamshell pack. ★ Minimum order quantity may apply.



Cole Hersee Co. 20 Old Colony Ave, Boston, MA 02127-2467

64

T 617.268.2100 F 617.268.9490 www.colehersee.com

**G2 MEDIUM DUTY PUSH-BUTTON SWITCHES**

9115 ★



Two screw terminals with lockwashers. Mounting stem: 5/8"-32, 7/8" thread (22.2mm) long.

**90028\***

Same as 9115, but with blade terminals.

**90002 sealed**

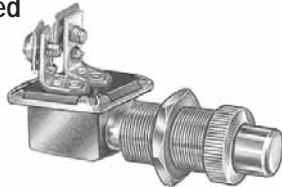

Weather-resistant and dust-resistant. Gasket-sealed case and O-ring in stem. Two screw terminals with lockwashers. Mounting stem: 5/8"-32 thread, 1 1/16" (26.9mm) long.

**90002-01 sealed, heavy-duty**

Same as 90002, except with silver contacts for heavy duty applications up to 36V DC.

**91126 PVC-coated**



PVC-coated body for moisture and dirt protection. Two 7" (177.8mm) wire leads. Mounting stem: 7/16"-20 thread, .44" (11.2mm) long. Steel button, .38" (9.7mm) diameter.

**90043 sealed, with rubber cap ★**



Two blade terminals accept 2-pole Delphi (Packard) connector 2977647 or equivalent. Mounting stem: 5/8"-32 thread, .625" (15.9mm) long. Gasket seal in the case. Steel plunger protrudes through the cap. Black rubber cap snaps into a special groove on the nut, which is deep-threaded and gives a positive seal.

**90043-07 PVC-coated, sealed, with rubber cap ★**



Same as 90043, except with PVC-coated body and two 7" (177.8mm) 18AWG wire leads.

**9212**

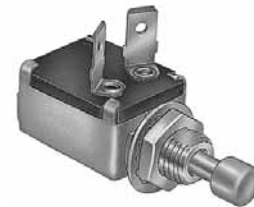

2 blade terminals. Mounting stem: 7/16"-20 thread, 1/2" (12.7mm) long. 1/2" (12.7mm) plunger with nylon cap.

# momentary switches

**G3 TWO CIRCUIT PUSH-BUTTON SWITCHES**

*Two circuits are simultaneously energized.*

**Normally Off**

*Off-On, normally Off. On with plunger depressed, spring return to Off.*

**9165 with screw terminals**

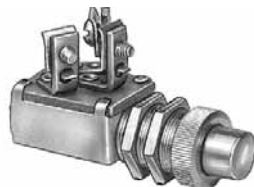

10A per circuit at 12V DC. Three screw terminals with lockwashers. Mounting stem: 5/8"-32 thread, 21/32" (16.7mm) long with two steel hexnuts and facenut.

**9276\* with blade terminals, silver contacts**



35A at 12V, 20A at 24V, 10A at 36V DC. Three blade terminals. Mounting stem: 5/8"-32 thread, 21/32" (16.7mm) long. Silver contacts for extra-heavy applications to 36V DC.

CONTINUED **G3**

★ Rapid ship item. BP Available in retail clamshell pack. ★ Minimum order quantity may apply.



# G momentary switches

## G3 TWO CIRCUIT PUSH-BUTTON SWITCHES

### 9276-09 with protective cap



Same as 9276, but with three screw terminals and screw-on protective black rubber cap 83280-03, and with black plastic button.

### Normally On

*On-Off, normally On. Off with plunger depressed, spring return to On.*

9211

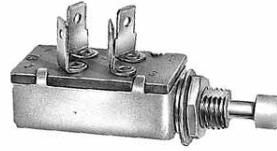

Commonly used in school bus stepwell and door control. Four blade terminals. Mounting stem: 7/16"-20 thread. .33" (8.4mm) diameter button. 10A per circuit at 12V DC.

# momentary switches

## G4 MARINE CONSTRUCTION PUSH-BUTTON SWITCHES

### Normally Off

*SPST. Off - Momentary On. On with button depressed, spring return to Off. Corrosion-resistant brass case, plunger button and mounting hardware. Moisture-repellent insulators. Chrome-plated buttons and facenuts, except where noted.*

### Extra Heavy Duty

*35A at 12V, 20 at 24V, 10A at 36V DC.*

M-490 BP ★



Two brass screw terminals. Mounting stem; brass 5/8"-32 thread, 1 3/8" (34.9mm) long, fits panels up to 1" (25.4mm) thick. Silver contacts.

### M-612 with recessed button BP



Same as M-490, but with recessed facenut, designed to prevent accidental actuation.

### M-491 with large button BP



Same as M-490, but with large anodized aluminum button, 15/16" (23.8mm) diameter.

### M-626 with snap-on cap BP ★



Same as M-490, but with snap-on black rubber cap 407-03.

### M-626-02 with screw-on cap ★



Same as M-490, but with screw-on black rubber cap 83280-03.

### Heavy Duty

*10A at 12V DC. For 6-36V DC applications.*

M-492 BP ★



Two brass screw terminals. Brass mounting stem 5/8"-32, 1 3/8" (34.9mm) long. Fits panels up to 1" (25.4mm) thick.

### M-492-01\*

Same as M-492 except with blade terminals.

★ Rapid ship item. BP Available in retail clamshell pack. ★ Minimum order quantity may apply.



Cole Hersee Co. 20 Old Colony Ave, Boston, MA 02127-2467

66

T 617.268.2100 F 617.268.9490 www.colehersee.com

### M-485 with 1" stem, and gasket BP ★



Two brass screw terminals. Brass mounting stem 5/8"-32, 1" (25.4mm) long. Fits panels up to 3/4" (19.1mm) thick. Gasket-sealed case.

### M-524 with snap-on cap

Same as M-485 except with snap-on black rubber cap 407-03.

### M-485-02

Same as M-485 except with screw-on black rubber cap 83280-03.

### M-608 PVC-coated BP ★



PVC-coated body sealed against moisture and dirt, with black rubber snap-on cap 407-03. Two 12" (304.8mm) 18AWG leads. Brass mounting stem 5/8"-32, 15/16" (23.8mm), fits panels up to 1/2" (12.7mm) thick.

## Normally On

*SPST. On - Momentary Off. Off with button depressed, spring return to On. Corrosion-resistant brass case and mounting hardware. Gasket-sealed case. 10A at 12V DC.*

### M-639 with chrome plunger



Chrome-plated brass plunger. Two brass screw terminals. Brass mounting stem 5/8"-32 thread, 1" (25.4mm) long. Fits panels up to 3/4" (19.1mm) thick.

### M-914-01 with nylon cap plunger



Two brass screw terminals. Brass mounting stem 3/8"-32 thread, 1" (25.4mm) long. Fits panels up to 3/4" (19.1mm) thick.



## marine construction

### 'Marine Construction' means 'for demanding applications'

Our marine construction switches are designed to stand up to conditions like ocean water spray that can destroy other switches. So these exceptional switches are also suitable for situations where dust infiltration and water spray can be a problem... like off-road equipment, agricultural vehicles, and other demanding applications.

Special features include rubber caps to protect the plunger, gasket-sealed cases (with rectangular housing switches), moisture-repellent insulators, brass construction, or chrome-plated brass, or the ultimate plasticized switch where the wire leads, body and part of the stem are dipped in a resilient PVC coating to completely seal the switch mechanism

## ignition



See Section C.

SPECIAL SWITCHES **G5**

★ Rapid ship item. BP Available in retail clamshell pack. ★ Minimum order quantity may apply.

# G momentary switches

## G5 SPECIAL MOMENTARY SWITCHES

For specific applications

### 9250 Momentary Windlass Switch



35A at 12V, 20A at 24V DC. Picture shows typical vertical mounting location. Mounting plate and diaphragm are not supplied. Off-Momentary On, spring return to Off. Brass case and mounting hardware. Silver contacts. Two brass screw terminals. Brass mounting stem 5/8"-32 thread, 7/16" (11.1mm) long, fits panels up to 3/16" (4.8mm) thick. Anodized aluminum button 15/16" (23.8mm) diameter. Plunger button is loose, and must be held in place with rubber diaphragm.

## Momentary Pull Switches

### M-486 normally Off



10A at 12V DC. Normally Off. Pull On, spring return to Off. Brass case and mounting hardware. Two brass screw terminals. Brass mounting stem 3/8"-32, 1 1/4" (31.8mm) long. Fits panels up to 7/8" (22.2mm) thick. Chrome-plated brass knob, debossed 'PULL', 7/8" (22.2mm) diameter. Moisture-repellent insulator.

### 9109 normally Off. Use with cable or lever



10A at 12V DC. Normally Off. Pull On, spring return to Off. Brass case and mounting hardware. Two screw terminals with lockwashers. Mounting stem 1/2"-20 thread, 5/8" (15.9mm) long. No knob: shaft has 3/32" (2.4mm) hole for the attachment of a cable or lever.

### 9071\* normally On. Use with cable or lever

Same as 9109, except Off with shaft pulled out. Pull Off, spring return to On.

## Horn Buttons

### 96101 surface mount BP ★



5A at 12V DC. Two screw terminals. Black plastic button, 13/16" (20.6mm) diameter.

### 96100 clamp mount



5A at 12V DC. Same as 96101, but with clamp that allows attachment on a steering column up to 1 1/2" (38.1mm) diameter.

### 96102 large button, clamp mount



5A at 12V DC. Two screw terminals. Ivory plastic button 1 3/4" (44.5mm) diameter. Clamp allows attachment on a steering column up to 1 1/2" (38.1mm) diameter.



give warning

Looking for a pilot light or audible warning to connect to your switch? See Section N1: Buzzers & Alarms, and Section N2: Pilot Lights.

★ Rapid ship item. BP Available in retail clamshell pack. ★ Minimum order quantity may apply.



Cole Hersee Co. 20 Old Colony Ave, Boston, MA 02127-2467

68

T 617.268.2100 F 617.268.9490 www.colehersee.com

## Engine Start/Engine Stop

35A at 12V, 20A at 24V DC. Two screw terminals with lockwashers. Mounting stem 7.8"-24 thread, keyed to prevent switch from turning, fits panels .04" - .10" thick (1.0 - 2.5mm). Silver contacts.

Impact-resistant molded plastic button with imprint, white on color, repels oil, water and other liquids. Diecast housing, with knurled aluminum facenut. 2 7/32"L x 1 1/8"D (50.8 x 28.6 x 3.18mm).

90047 with black 'Start' button ★

90047-01 with red 'Stop' button



90048 weatherproof with 'Start' imprint

Same as 90047, but with special facenut with built-in lip seal for added weather-resistance.

90048-01 weatherproof with 'Stop' imprint

Same as 90047-01, but with special facenut with built-in lip seal for added weather-resistance.

## Momentary Grounding Switches

Self-grounding in metal panels. Contacts normally open. Contacts close (terminal to ground) with plunger depressed, spring return to open.

9059 snap mount



5A at 12V DC. Chrome-plated brass button with chrome-plated faceplate. One bullet terminal. Snaps into 15/16" (23.8mm) diameter hole.

92118-06



5A at 24V DC. One blade terminal. Gasket-sealed case. 3/8" -24 UNF-2A thread, 1/4" long (3.18mm).

9035\*



10V at 12V DC. Chrome-plated button. One screw terminal with lockwasher. 5/8"-32 thread mounting stem, 7/8" long (22.2mm).

## Compact Design

5A at 12V DC, except where stated. Normally Off is Push to Mom On, spring return to Off. Normally On is Push to Mom Off, spring return to On. Toggled type is Push to On, Push to Off.

9075 Normally On ★



Snaps into .80 - .85" (20.3 - 21.6mm) diameter hole. Fits panels .03 - .07" thick (.76 - 1.8mm). Moisture-resistant molded plastic case. Two female bullet terminals, plastic plunger 9/16" (14.3mm) long.

Replaces: Delco 1972534, Ford B0A, B9a, B9MF, C3AZ, C5AZ, C607, FEW, OA-13713-A, Jeep 805699, Motorcraft SW-265, 395, Peterbilt 16-03030.

9100 Normally Off ★



6A at 125V, 3A at 250V. Push On, spring return to Off. For AC or DC. UL-approved. Plastic body, nickel-plated plunger. Two screw terminals. 15/32" -32 mounting stem, 9/16" (14.3mm) long.

CONTINUED G5

★ Rapid ship item. BP Available in retail clamshell pack. ★ Minimum order quantity may apply.

# G momentary switches

## G5 SPECIAL MOMENTARY SWITCHES

### 9011 Normally Off



Plated steel button, aluminum body. Two screw terminals, 7/8" -20 mounting stem, 3/8" (9.5mm) long.

### 9105 Toggled



10A at 12V, 5A at 24V. Two 6" (152.4mm) wire leads, 16AWG (1.00mm<sup>2</sup>). Phenolic body, 1.080"L x .530"W x 1.10"H (27.4 x 13.5 x 28.0mm). Push-button diameter .410" (10.4mm). Stem: .470" long (11.9mm). Can be used as a foot switch in dry environments.

### 9187 Normally Off, Black button **BP**



5A at 12V to 24V DC. Two blade terminals .250" wide (6.4mm). Nickel-plated brass hexnut and facenut. Nylon push-button, .410" diameter (10.4mm). Body size (to top of terminal): .890"L x .560"W x .773"H (22.6 x 14.2 x 19.6mm).

### 9187-01 Normally Off, White button **BP**

Same as 9187, except with white/natural nylon color button.

### 9187-02 Normally Off, Red button **BP**

Same as 9187, except with red button.

# momentary switches

## G6 CAPS FOR PUSH BUTTON SWITCHES

*Flexible caps give added resistance to weather and dust.*

### Threaded Caps

Rubber cap is permanently fastened to the integral mounting nut by a rolled brass bezel. The deep threaded 5/8"-32 aluminum mounting nut assures a positive seal. Durable, resilient rubber, embossed 'PUSH'. Fits Cole Hersee and all other push button switches with a 5/8"-32 thread mounting stem.

#### 83280-03 Black **BP**

#### 83280 Gray

#### 83280-02 Red



#### 83280-05 Oil-resistant

For use on fuel delivery trucks. Cap is molded from resilient Hydrin which provides excellent resistance to fuel oils. Brown color.

### Snap-on Caps

Ribs on the inside of the rubber cap engage with the switch facenut. Facenut – Section S2.

#### 407-03 Black **BP**

#### 407-01 Gray **BP**



★ Rapid ship item. **BP** Available in retail clamshell pack. ★ Minimum order quantity may apply.



Cole Hersee Co. 20 Old Colony Ave, Boston, MA 02127-2467

70

T 617.268.2100 F 617.268.9490 www.colehersee.com

## SPST Normally On

*Off with plunger depressed, spring return to On.*

### Without faceplate

9055 with 1/2" plunger



7/16" -20 thread mounting stem, 7/16" long (11.1mm), two flats on stem for mounting in double-D hole. Two screw terminals, plated steel case. 10A at 12V DC.

### 9055-02

Same as 9055 except with one hexnut and one pal nut.

9264 with 1/2" button end plunger



7/16" -20 thread mounting stem, 7/16" long (11.1mm), two flats on stem for mounting in double-D hole. Two screw terminals, plated steel case. 10A at 12V DC.

### 9264-02

Same as 9264 except with 7/8" (22.2mm) mounting stem. 10A at 12V DC.

### 9003



1/2" -20 thread mounting stem, 1/4" long (6.4mm), two screw terminals, 13/32" plunger (7.9mm). 5A at 12V DC

### With faceplate

9001 with screw terminals ★



Two screw terminals. Two 9/64" diameter (3.6mm) mounting holes, 1 3/8" (34.9mm) on centers. 45/64" diameter (17.9mm) plated steel case. Plunger: 7/16" long (11.1mm). 5A at 12V DC

### 9270 with blade terminals

Similar to 9001, but with two blade terminals.

### 9050-01 self-grounding

Same as 9001, but with one screw terminal.

### 9087 with screw terminals, four mounting holes BP



Four 3/16" diameter mounting holes, 1 3/8" and 2 1/16" on center (34.9, 51.0mm). 45/64" diameter (4.8mm) plated steel case. Plunger: 7/16" long (11.1mm). 5A at 12V DC.

### 9270-01 with sealed plunger, and wire leads



Two .144" (3.7mm) diameter mounting holes, 1 1/2" (38.1mm) on centers. 0.70" diameter (17.8mm) plated steel case. Plunger: 0.436" long (11.1mm). Black rubber cap on plunger, and PVC coating on 8" (203.0mm) wire leads protect against moisture and dirt. 5A at 12V DC.

### 9006 switch with boot BP ★



Black rubber boot covers and protects the face of the switch, making it dust-resistant. Plastic button. 4A at 12V DC lamp load. Two 2mm x 5mm blade terminals. 4A at 12V DC.

*International Trucks OEM replacement part 3579984C1 for trucks in these series: 2007, 4000, 7000, 8000, 9000.*

CONTINUED **G7**

# G momentary switches

## G7 DOOR MOMENTARY SWITCHES

### SPST Normally Off

*On with plunger depressed, spring return to Off*

#### 9002 with screw terminals



Two 9/64" (3.57mm) diameter mounting holes, 1 3/8" (34.9mm) on centers. 45/64" (17.9mm) diameter plated steel case. Two screw terminals. Plunger: 7/16" long (11.1mm). 5A at 12V DC.

#### 9269 with screw terminals

Same as 9002, but with two blade terminals, and mounting holes 1 1/2" (38.1mm) on centers.

#### 9004\* without faceplate

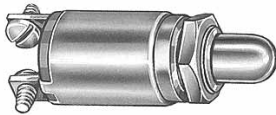

1/2" -20 thread mounting stem, 1/4" (6.4mm) long, two screw terminals, 13/32" (10.3mm) plunger. 5A at 12V DC.

### DPST Normally On

*Off with plunger depressed, spring return to On. For energizing two circuits simultaneously. Popular for use in school bus stepwell and door control. 10A at 12V DC*

#### 9118 with screw terminals ★



7/16" -20 thread mounting stem, 7/16" (11.1mm) long, two flats on stem for mounting in double-D hole. Four screw terminals. Plunger 19/64" (7.54mm) long. 10A at 12V DC.

#### 91801 with blade terminals ★

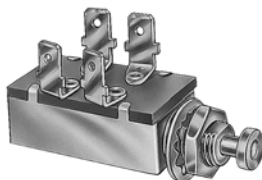

Same as 9118, except with four blade terminals. 10A at 12V DC.

#### 9118-04 with long mounting stem

Same as 9118, except with 7/8" (22.2mm) long mounting stem and two hexnuts and one lockwasher. 10A at 12V DC.

#### 91801-01

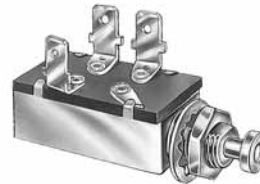

Same as 91801, except with one insulated, one grounded circuit and three blade terminals. 10A at 12V DC.

### DPST Normally Off

*On with plunger depressed, spring return to Off.*

#### 9180

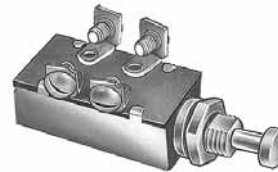

7/16" -20 thread mounting stem, 7/16" (11.1mm) long, two flats on stem for mounting in double-D hole. Four screw terminals, plunger 15/32" (11.9mm) long. 10A at 12V DC.

### School Bus Switches

*Designed for use in 8 light warning systems in school buses. 10A at 12V DC*

#### 91811 two-circuit

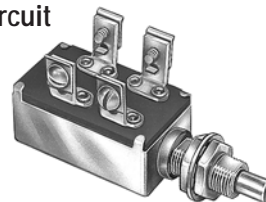

Normally On - Mom Off - Mom On. Two circuits. 7/16" -28 thread mounting stem, 3/4" (19.0mm) long, flat on stem for mounting in D hole. Four screw terminals, Plunger 23/64" (9.2mm) long. Extra-heavy duty. 10A at 12V DC.

#### 91804 four-circuit DPDT

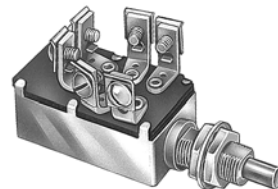

Normally On. Momentary Off. 7/16" -28 thread mounting stem, 3/4" (19.0mm) long, flat on stem for mounting in D hole. Six screw terminals, Plunger 23/64" (9.2mm) long. Extra-heavy duty. 10A at 12V DC.

★ Rapid ship item. BP Available in retail clamshell pack. ★ Minimum order quantity may apply.



**G7** DOOR MOMENTARY SWITCHES

91800 with stationary Off and momentary Off positions. 3 positions.

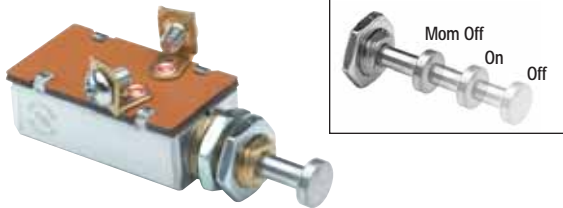

Normally On. Pull-out feature permits circuit to be shut off manually when the door must remain open and operation is not required. 7/16" -20 thread mounting stem, 7/16" (11.1mm) long. Two flats on stem for mounting in double-D hole. Two screw terminals. Plunger is 7/32" (5.6mm) long at On, 3/4" (19.0mm) at Off. 10A at 12V DC.

**91050 5-Circuit Door Switch**



For school bus door operation in conjunction with Cole Hersee relay 91052 (See Section M1). 7/16" -28 thread mounting stem, 7/8" (22.2mm) long. Eight blade terminals, plunger 5/16" (8.0mm) long. Silver-laminated contact surfaces. On position: door open, terminals 1&2, 5&7, 6&8 closed. Momentary On position: door closed, terminals 1&2, 7&9, 9&10 closed. Terminals 1&2 momentarily Open as plunger travels from On to momentary On, to reset the relay. Terminal 1 to relay, terminal 2 to ground, terminals 5&6 to red flashing lights, terminal 7&8 to flasher terminals, terminals 9 &10 to amber flashing lights. 10A at 12V DC.

power on, power off

Color-coded buttons make it easy to select On and Off functions. See Section G5.

**Normally grounded switches**

*Self-grounding in metal panels. Contacts Open with plunger depressed, spring return to Ground.*

**Single-circuit**

**91812**

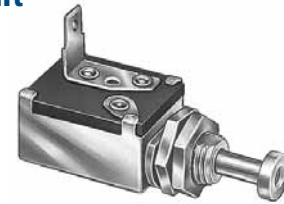

7/16" -20 thread mounting stem, 7/16" (11.1mm) long, two flats on stem for mounting in double-D hole. One blade terminal, plunger 33/64" (13.1mm) long. 5A at 12V DC.

**9266**



3/8" -24 self-tapping thread, mounting stem 5/16" (8.0mm) long. One female bullet terminal, plunger 5/8" (15.9mm) long, self-adjusting to 3/16" (4.8mm) long. Operates with 7lbs (3.2 kg) minimum pressure. 5A at 12V DC.

*Replaces: AMC 3662814, Chrysler 1971931, 1972329, 2770849, 2822592, 3843643, GMC 4891633, Motorcraft SW-518.*

**9251** ★



5/16" -18 self-tapping thread, mounting stem 1/2" (12.7mm) long. One female bullet terminal, plunger 7/16" (11.1mm) long, operates with 35oz (.99 kg) minimum pressure. 5A at 12V DC.

*Replaces: Chrysler 1571542, 1594751, 1688514, 1838957, GMC 4882978, 6276718, Motorcraft SW-690 (one terminal application).*

**91822**



3/8" -24 self-tapping thread, mounting stem 7/32" (5.6mm) long. One blade terminal, plunger 5/16" long, self-adjusting to 1/4" long. Operates with 6lbs (2.7 kg) minimum pressure. 3A at 12V DC.

*Replaces: GMC 9665205, 9839085, 20057138.*

CONTINUED **G7**

★ Rapid ship item. BP Available in retail clamshell pack. ★ Minimum order quantity may apply.



### Two-circuit

Two circuits grounded simultaneously. 5A at 12V DC

91823 ★



3/8" -24 thread, mounting stem 7/32" (5.6mm) long. Two blade terminals, plunger 3/16" (4.8mm) long, self-adjusting to 1/4" (6.4mm) long. Operates with 7lbs (3.2 kg) minimum pressure. 5A at 12V DC.

Replaces: AMC 3631896, 3662814, Chrysler 2497590, 2889084, GMC 9852254, 20603498, Motorcraft SWG-1115.

91840



1/2" -28 self-tapping thread, mounting stem 5/16" (8.0mm) long. Two blade terminals, plunger 3/4" (19.0mm) long, self-adjusting to 9/16" (14.3mm) long. 5A at 12V DC.

Replaces: Chrysler 4221254.

91843\*



3/8" -24 self-tapping thread, mounting stem .33" (8.38mm) long. Two blade terminals, plunger .85" (21.6mm) long, self-adjusting. 5A at 12V DC.

Replaces: GMC 20545277, 20591843.



## lockouts

Lockouts and tagouts prevent operators, technicians and maintenance personnel from unanticipated power-ups that might cause injury or death.

According to OSHA, "A lockout device utilizes a positive means such as a lock to hold an energy isolating device in a safe position and prevent the energization of a machine." A tagout is a tag or seal that states 'Do not operate or remove this tag' and is signed by the person who places the tagout. Procedures specify that nobody but that person may remove the tag.

A lockout on a battery switch not only keeps a vehicle safe, but also immobilizes it. A locked out vehicle is less vulnerable to battery drain or theft. See Section J4 for lockout kits.

# push-pull switches



F

|                      |    |
|----------------------|----|
| ONE CIRCUIT          | F1 |
| TWO CIRCUIT          | F2 |
| MARINE CONSTRUCTION  | F3 |
| SPECIAL APPLICATIONS | F4 |

## push-pull switches

### F1 ONE CIRCUIT

*SPST, Off-On. Universal application. Mounting hardware included.*

#### Normally Off, 10A Heavy duty, 10A at 12V DC, 6-36V.

##### 5007 screw terminals BP ★

Aluminum mounting stem  
3/8"-32 thread, 5/8" (15.9mm)  
long. Tan plastic knob with  
10-32 threaded metal insert.  
Two screw terminals, plated steel case.



##### 50031\* blade terminals

Same as 5007, except with two blade terminals and ivory plastic knob.

##### 5011 screw terminals BP ★

Steel mounting stem  
1/2"-20 thread, 5/8" (15.9mm)  
long. Chrome-plated knob.  
Two screw terminals, plated  
steel case.



##### 50070 silver contacts, blade terminals

Same as 5011, except with two blade terminals.

##### 5053 glass fuse, chrome knob

Steel mounting stem 1/2"-20  
thread, 5/8" (15.9mm) long.  
Chrome-plated knob. Two  
screw terminals, plated steel  
case. 20A SFE fuse.

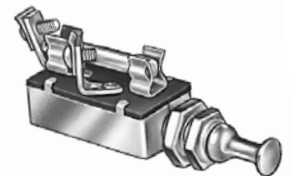

##### 5067 glass fuse, plastic knob

Same as 5053, except with ivory plastic knob.

##### 50077 sealed case

O-ring in stem, and gasket-  
sealed terminal insulator.  
Brass mounting stem 7/16"-28  
thread, 5/16" (7.9mm) long. Black  
plastic knob with 10-32 threaded metal insert.  
Two screw terminals, zinc case.

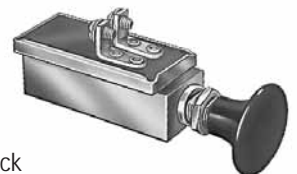

CONTINUED **F1**

★ Rapid ship item. BP Available in retail clamshell pack. ★ Minimum order quantity may apply.

**F3 MARINE CONSTRUCTION**

10A at 12V DC, 6-36V DC. Brass mounting hardware included.

## One Circuit

Brass housing, brass mounting stem 3/8" -32 thread, 1 1/4" (31.8mm) long. Fits panels up to 3/4" (19.1mm) thick.

### SPST Off-On, Normally Off

#### M-480 plastic knob BP

Two brass screw terminals. Ivory plastic knob, 10-32 thread.



#### M-482 sealed, screw terminals BP ★

Two brass screw terminals. Chrome-plated brass knob. Gasket-sealed case.

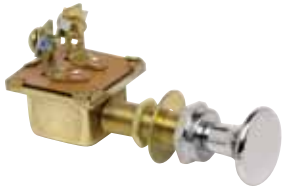

#### M-482-01 sealed, blade terminals BP

Two brass blade terminals. Chrome-plated brass knob. Gasket-sealed case.



#### M-482-02 sealed, plastic knob

Two brass screw terminals. Black plastic knob, 10-32 thread, and set screw. Gasket-sealed case.



#### M-606 PVC-coated BP ★

Brass housing, plasticized. Two insulated copper wire leads, 12" (304.8mm) long. Chrome-plated brass knob, 10-32 thread.



#### M-628 chromed knob BP ★

Two brass screw terminals. Chrome-plated brass knob, 10-32 thread.

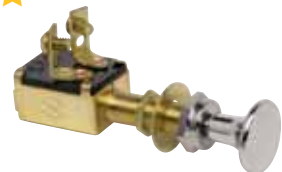

## SPST Off-On, Normally On

#### M-530

Gasket-sealed brass housing. Two brass screw terminals. Chrome-plated brass knob. Brass mounting stem, 3/8" -32 thread, 1 1/4" (31.8mm) long.



## Two Circuits

#### M-527 SPST Off-On BP

Normally Off. Brass housing. Three brass screw terminals. Chrome-plated brass knob 10-32 thread. Brass mounting stem, 3/8" -32 thread, 1 1/4" (31.8mm) long, fits panels up to 1" (25.4mm) thick. With brass facenut, washer and hexnut.



#### M-531 SPST Off-On-On BP

Off - On A&B - On B&H. Brass housing. Three brass screw terminals. Chrome-plated brass knob 10-32 thread. Brass mounting stem, 3/8" -32 thread, 1 1/4" (31.8mm) long, fits panels up to 1" (25.4mm) thick. With brass facenut, washer and hexnut.

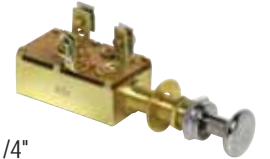

#### M-630 SPDT On-On BP

Brass housing. Three screw terminals. Chrome-plated brass knob. Brass mounting stem, 3/8" -32 thread, 1 1/4" (31.8mm) long, fits panels up to 1" (25.4mm) thick. With brass facenut, washer and hexnut.



## Three Circuits

#### M-532 SPDT BP

Off - On 1&2 -On 1&3. Brass housing. Four brass screw terminals. Chrome-plated brass knob 10-32 thread. Brass mounting stem, 3/8" -32 thread, 1 1/4" (31.8mm) long, fits panels up to 1" (25.4mm) thick. With brass facenut, washer and hexnut.

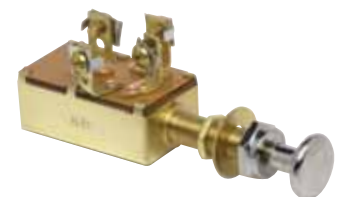

SPECIAL **F4**

★ Rapid ship item. BP Available in retail clamshell pack. ★ Minimum order quantity may apply.

# wiper switches



E

ELECTRONIC SWITCHES

E1

ELECTRIC TWO-SPEED SWITCHES

E2

## wiper switches

### E1 ELECTRONIC SWITCHES

With intermittent delay feature for permanent magnet electric wiper motors. Ensures dependable control of windshield wipers on heavy-duty vehicles. For 12V DC or 24V DC vehicles as noted, with or without dynamic parking, negative ground only. 4 positions: Off/Park - Intermittent Range - Low - High. Push-to-wash (one to three wipes after the knob is released). Black plastic knob with metal insert and set screw, white imprint. Diecast case 2 7/32" (56.4mm) square, 1 13/16" (46.0mm) long. 7/16 -28 thread mounting stem, .45" (11.3mm) long. Hexnut and lockwasher included. Switches conform to SAE J1455, SAE J112a and J234. Switches control most two-speed wiper motors.

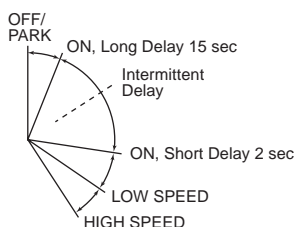

### With Dynamic Parking

Controls one or two motors.

#### 75600-04 One motor, leads, 12V DC

Microprocessor design. Six color-coded wire leads, 5" (127.0mm) long. With round knob imprinted with SAE washer-wiper symbol.

#### 75602-04 One motor, leads, 24V DC

Microprocessor design. Same as 75600-04, except 24V.

#### 75600\* One motor, Delphi (Packard), 12V DC

Microprocessor design. Same as 75600-04, but with Delphi (Packard) 8-way female connector 2965977 (mates with 2965972.) With round knob imprinted with SAE washer-wiper symbol.

#### 75600-02 One motor, Delphi (Packard), 24V DC

Controls one motor. One Delphi (Packard) 6-way male connector 2977042 (mates with 2977044). Lead and connector assembly: 5.625" (142.9mm) long. With round knob imprinted with SAE washer-wiper symbol.

#### 75600-05 One motor, Delphi (Packard), 12V DC

Controls one motor. One Delphi (Packard) 4-way male connector 6294544 (mates with 2977048) and one Delphi (Packard) 4-way female connector 2977048 (mates with 6294544). With round knob imprinted with SAE washer-wiper symbol. Lead and connector assembly: 5.625" (142.9mm) long.

#### 75600-07\*

One motor, 12V DC



Controls one motor. One 7-pole connector. Supplied with hexnut and lockwasher for mounting, no knob. Lead and connector assembly: 5.625" (142.9mm) long.

#### 75600-01

Two motors, 12V DC



Controls two motors. One Delphi (Packard) 4-way male connector 6294544 (mates with 2977048) and one Delphi (Packard) 6-way male connector 2977042 (mates with 2977044). With round knob imprinted with SAE washer-wiper symbol. Lead and connector assembly: 5.625" (142.9mm) long.

CONTINUED E1

\*Minimum order quantity may apply. Please consult factory or current price list.



Cole Hersee Co. 20 Old Colony Ave, Boston, MA 02127-2467

57

T 617.268.2100 F 617.268.9490 www.colehersee.com

# E wiper switches

## E1 ELECTRONIC SWITCHES

### Without Dynamic Parking

Controls one or two motors. 12V DC. Includes motors by Johnson Electric (formerly United Technologies) and Sprague Devices. Lead and connector assembly: 5.625" (142.9mm) long. Delphi (Packard) 8-way male connector 2965972 (mates with 2965977).

#### 75601-02 with knob

Same as 75601-08, except with round knob imprinted with SAE washer-wiper symbol.

#### 75601-08 without knob

Includes hexnut and lockwasher for mounting.



# wiper switches

## E2 ELECTRIC TWO-SPEED SWITCHES

### For Permanent Magnet Electric Wiper Motors

For 12V and 24V DC, except where noted. For use with heavy-duty permanent magnet electric wiper motors. 3 positions: Off/Park - Low - High.

#### Without Dynamic Parking

For use with Johnson Electric (formerly United Technologies) motors. Black plastic knob with metal insert and set screw, white imprint. Plated steel case 1 3/8" (34.9mm) diameter, 3/8" (9.5mm) long. Mounting stem 7/16" -28 thread, .38" (9.6mm) long.



#### 75212-04 single motor, without push-to-wash

4 blade terminals.

#### 75221-06 single motor, without push-to-wash

4 blade terminals. Internal 6A circuit breaker at 12V DC.

#### 75221-09 single motor, with push-to-wash

5 blade terminals. Internal 6A circuit breaker at 12V DC.

#### 75217-04 dual motor, without push-to-wash

6 blade terminals.

#### 75226 dual motor, with push-to-wash

7 blade terminals.

### With Dynamic Parking

For use with motors with dynamic parking, including Robert Bosch and Sprague Devices motors. Sealed construction, including O-ring on the shaft. Black plastic knob with metal insert and set screw, white imprint. Mounting stem 7/16" -28 thread, .45" (11.4mm) long. Diecast case 1 5/8" (41.3mm) diameter.

#### 75228-03 single motor, push-to-wash

6 blade terminals.



#### 75228-07 single motor, with push-to-wash

Same as 75228-03, but with Delphi (Packard) connector 6288538.

#### 75228-04 single motor, without push-to-wash

5 blade terminals.

#### 75236 dual motor, with push-to-wash

8 blade terminals.

## For Field-Wound Electric Wiper Motors

#### 75109\*

Single motor control. For use with field-wound electric wiper motors. 3 positions: Off/Park - Low - High. Plated steel case 1 3/8" (34.9mm) diameter, 13/16" (20.6mm) long. 7/16" -28 thread mounting stem, .265" (6.7mm) long. Four female bullet terminals. Ivory plastic knob with metal insert and set screw, imprint, "Wiper".

## knobs

See catalog Section S.

\*Minimum order quantity may apply. Please consult factory or current price list.

# rotary & headlamp switches



D

|  |    |
|--|----|
| UNIVERSAL ROTARY SWITCHES              | D1 |
| UNIVERSAL REVERSING ROTARY SWITCHES    | D2 |
| ROTARY HEADLAMP & LIGHT SWITCHES       | D3 |
| ROTARY TEMPERATURE & RHEOSTAT SWITCHES | D4 |
| PUSH-PULL HEADLAMP SWITCHES            | D5 |
| ELECTRONIC DIMMER SWITCHES             | D6 |
| FOOT-OPERATED SWITCHES                 | D7 |

## rotary & headlamp switches

### D1 UNIVERSAL ROTARY SWITCHES

In a full range of styles and circuitries for lighting, ignition and similar applications.

#### 2-Position

Lever actuator. Two screw terminals. Plated steel case.

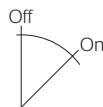

9500 10A with compact case



10A at 12V DC.  
Mounting stem 1/2"-20 thread.

24053\* 10A

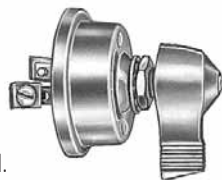

10A at 12V DC.  
Mounting stem 1/2"-20 thread.

#### 3-Position

On1 - Off - On2. Three screw terminals. Plated steel case.

24054 10A, lever

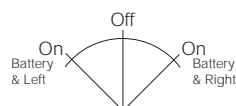

10A at 12V DC. Lever actuator.  
Mounting stem 1/2"-20 thread.

75705-01 10A momentary, lock

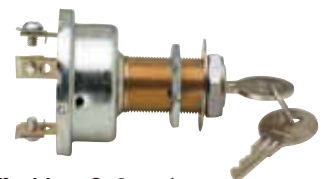
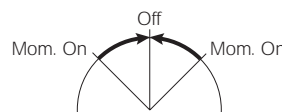

10A at 12V DC. Mom On1 - Off - Mom On2, spring return to Off from both positions. Key actuator with coded tumblers lock. Mounting stem 13/16"-24 thread. Internal O-ring seal.

9802 20A, lever

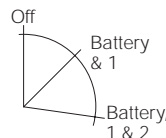

20A at 12V DC. Lever actuator and indexing pin. Mounting stem 5/8"-32 thread. Silver contacts.

75701 20A momentary, lever

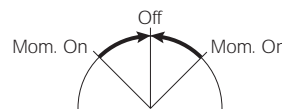

20A at 12V DC. Lever actuator, spring return to Off from both On positions. Silver contacts. Mounting stem 7/16"-28 thread.

CONTINUED D1

★ Rapid ship item. BP Available in retail clamshell pack. ★ Minimum order quantity may apply.

## 72150 Series



Compact plastic switches, with durable nylon 6/6 body, knob and stem, aluminum hardware, and plated brass terminals. Knobs snap on, and have a very positive detent action. Sealed to IP-53 for protection against dust and contaminants. Terminals accept connectors 99022 or 99021 with standard .250 quick-connect or Faston terminals.

Rotation diagrams: an arrow indicates a momentary switch. "On A-B" for example, indicates that terminals A & B are connected in the indicated position.

Part numbers refer to the switch complete with knob.

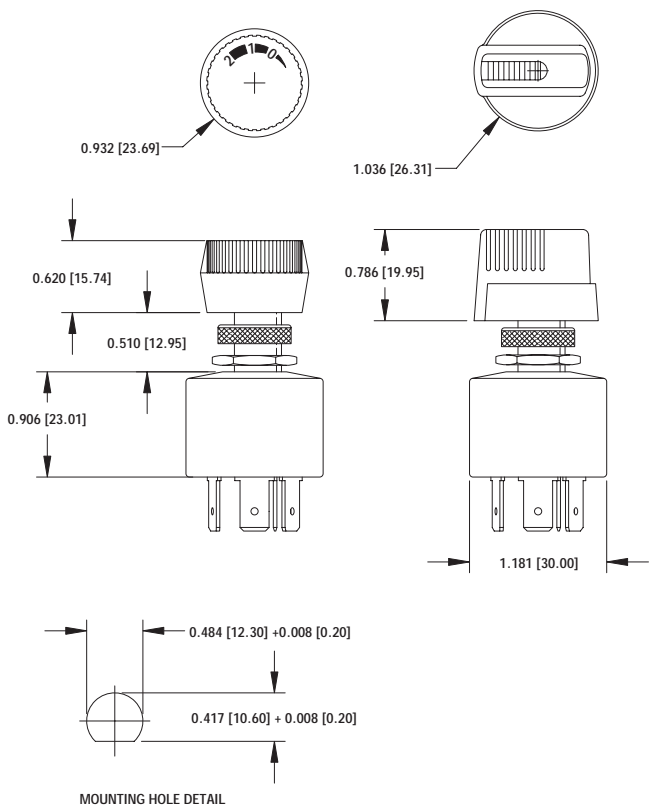

## SPST, SPDT, DPST...

Need to refresh your memory?  
Check out the last page of Section A, where it's all explained.

### Without illumination 10A 12V

Part numbers refer to the switch complete with knob.

#### SPST Off-On



72150-01 imprinted knob A

72150-02 knob B

#### SPST Off-Mom On



72151-01 imprinted knob A

72151-02 knob B

#### SPDT Off-On1-On2



72152-01 imprinted knob A

72152-02 knob B

#### SPDT On1-Off-On2

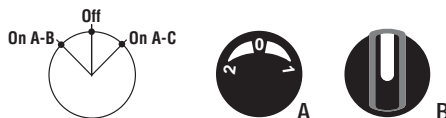

72153-01 imprinted knob A

72153-02 knob B

#### SPDT Mom On1-Off-Mom On2



72154-01 imprinted knob A

72154-02 knob B

**D1** UNIVERSAL ROTARY SWITCHES

## Illuminated 10A 12V

Part numbers refer to the switch complete with knob.  
In the diagrams a  $\otimes$  indicates a lamp connected between terminals E and F.



Style C, red or green

Style D, red or green

### SPST Off-On



- 72160-01 red lens, knob style C
- 72160-03 green lens, knob style C
- 72160-04 red lens, knob style D
- 72160-06 green lens, knob style D

### SPDT Off-On1-On2

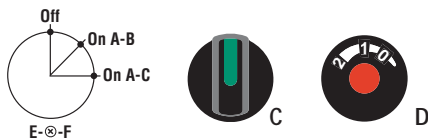

- 72161-01 red lens, knob style C
- 72161-03 green lens, knob style C
- 72161-04 red lens, knob style D
- 72161-06 green lens, knob style D

### SPDT On1-Off-On2



- 72162-01 red lens, knob style C
- 72162-03 green lens, knob style C
- 72162-04 red lens, knob style D
- 72162-06 green lens, knob style D

## Heavy Duty 20A 12V

Part numbers refer to the switch complete with knob.  
Without illumination. In the diagrams 'On  $\oplus$ -1,  $\oplus$ -2' indicates a + terminal connected to terminals 1 and 2.  
These switches are make before break.

### SP3T



- 72171-01 knob 01
- 72171-02 knob 02
- 72171-03 knob 03
- 72171-04 knob 04

### SP4T



- 72170-01 knob 01
- 72170-02 knob 02
- 72170-03 knob 03
- 72170-04 knob 04

## Connectors

99022

Fits all switches except 72170 and 72171.



99021

Fits switches 72170 and 72171.



REVERSING **D2**



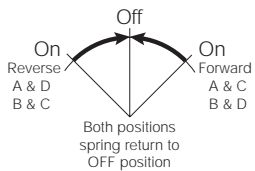

For forward-reverse operation of a motor, to give a motion such as Up/Down, Left/Right, In/Out, Rotate/Counter-rotate. Suitable for control of tailgates, winches, windlasses, snowplows and other applications. DPDT. Spring return to Off from both On positions. Four screw terminals. Plated steel case.

90005-01 15A, lever ★



15A at 12V DC. Lever actuator. Silver contacts. Mounting stem 1/2"-20 thread, 1 1/4" (31.8mm) long.

90005-04\* 15A, lever

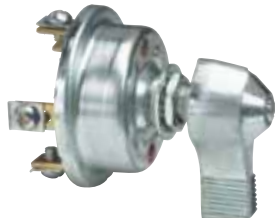

15A at 12V DC. Lever actuator. Silver contacts. Mounting stem 1/2"-20 thread, 13/32" (10.4mm) long.

90005-03 15A, lock ★



15A at 12V DC. Key actuator with coded tumbler lock. Spring return to Off from both On positions. O-ring seal in stem. Mounting stem 13/16"-24 thread.

75712-04 50A, lever BP ★

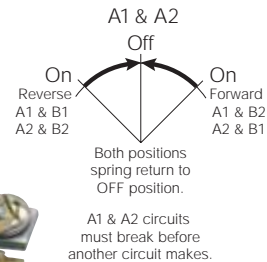

Heavy duty 50A switch allows forward and reverse motion of a motor without the need for a relay, especially for operation of tarps on trucks. Heavy duty component parts: 3/32" thick terminals, silver-laminated contacts to resist arcing over a long working life. 2.09" diameter (53.1mm) steel case. 10-32 x .375" (9.5mm) terminal screws with lockwashers. Mounting stem 1/2" -20 thread.



## forward-reverse switches

Cole Hersee manufactures several rotary switches that can be used in Forward-Reverse applications. These switches are DPDT Momentary On - Off - Momentary On, such as the 90005 series switches (15A at 12V DC). For demanding applications, there's the 75712-04, rated at 50A at 12V DC.

But we make other types of controls that can switch a motor to forward or reverse mode:



55046  
Toggle Switch  
25A at 12V DC



58027-18  
Rocker Switch  
25A at 12V DC

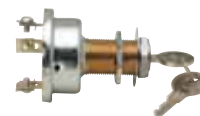

90005-03  
Keyed Switch  
15A at 12V DC

Cole Hersee switches: always lots of choices.

★ Rapid ship item. BP Available in retail clamshell pack. ✪ Minimum order quantity may apply.

**D3 ROTARY HEADLAMP & LIGHT SWITCHES**

**72079-01 with knob**



With black knob imprinted with SAE headlamp symbol. Silver contacts. Five screw terminals. Plated steel case. Mounting stem 5/8"-32 thread. With O-ring seal in the mounting stem. 20A per circuit at 12V DC.

**72023-01 with short lever**

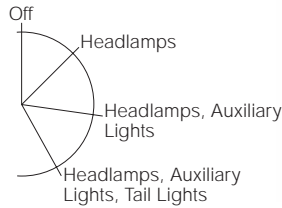

With short diecast lever. Four screw terminals. Plated steel case. Mounting stem 5/8"-32 thread. With O-ring seal in the mounting stem. 20A per circuit at 12V DC.

**72051-03 with black lever**

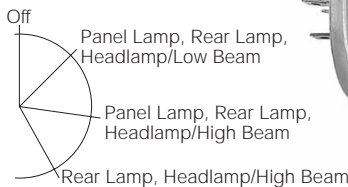

With black nickel-plated lever actuator. Five blade terminals, accepts Delphi (Packard) connector 2962912. Plated steel case. Mounting stem 5/8"-32 thread. With O-ring seal in the mounting stem. 20A per circuit at 12V DC.

**72058-01\* with lever**

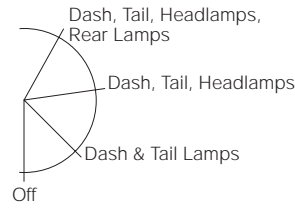

Lever actuator and indexing pin. Four screw terminals. Plated steel case. Mounting stem 1/2"-20 thread. With O-ring seal in the mounting stem. Silver contacts. 30A total at 12V DC.

**24052\* illuminated with 'Fog Light' imprint**

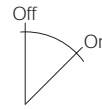

Illuminated tan knob with 'Fog Light' imprint. Three screw terminals. Plated steel case. Mounting stem 5/8"-32 thread. 20A fuse and No. 53 bulb supplied.

**fog light rocker switch**

As an alternate, fog light rocker switch 58027-17 matches other rocker switches that might be installed on the dashboard. For other switches of this type see Section A1.

## Air Conditioning Switches

For 12V DC systems. Four positions.

### 68159-05 with clutch circuit

Off - Low - Medium - High. Clutch circuit is energized in L, M and H. No electrical break between positions. Silver contacts. 7/16" -28 thread mounting stem, .34" (8.6mm) long. Five blade terminals. Plated steel case, 1.39" (35.3mm) diameter, .50" (12.2mm) long. Black plastic knob with SAE arrow symbol and with metal insert and set screw.



### 68154-A\* with rheostat

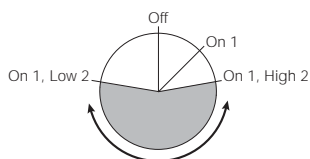

2 Ohm rheostat with 22W rating. Off - On 1 - On 1, 2 High - On 1, 2 Low. 7/16" -28 thread mounting stem, .25" (6.4mm) long. Three blade terminals. Plated steel case, 1.78" (44.6mm) diameter, .875" (22.2mm) long. Without knob.

## Heavy Duty Rheostat Switches

For 12V DC systems. Ceramic insulator with embedded coil for effective heat dissipation. 7/16" -28 thread mounting stem, 15/32" (11.9mm) long. Plated steel case, 1.32" (33.5mm) diameter, .88" (22.4mm) long. Black plastic knob with metal insert and set screw.

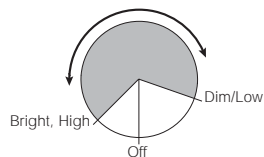

7493 with round/bar knob

## 2 Screw Terminals

### 7493 8 Ohm

With round/bar black knob

### 7493-01 3 Ohm

With round/bar black knob

### 7493-07 8 Ohm, imprinted

With round/bar black knob imprinted "Panel Lamps"

## 2 Blade Terminals

### 7496 8 Ohm

With round/bar black knob

### 7496-04 8 Ohm, imprinted

With round/bar black knob imprinted "Panel Lamps"

### 7496-11 18 Ohm, imprinted



With round black knob imprinted with SAE variable symbol

## Heavy Duty Heater-Defroster Switches

Four positions: Off-High-Medium-Low. 12V DC 3 Ohms or 24V DC 6 Ohms. Two screw terminals. Coil embedded in ceramic insulator for effective heat dissipation. Connections are welded to the resistance coil. Plastic round/bar knob with metal insert and set screw. Mount through a 5/8" hole (15.9mm) or with an optional bracket.

### 68362 12V, black knob



### 68363 24V, black knob

### 68365 12V, tan knob

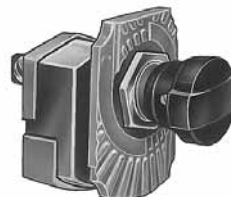

With faceplate

### 68366 24V, tan knob

With faceplate

## 3-Position

Three knob pull positions: In – Mid – Out.  
 In = Headlamps Off; Mid = Parking Lights and Tail Lights On;  
 Out = Headlights and Tail Lights On



### 7124 with black knob 'Lights'

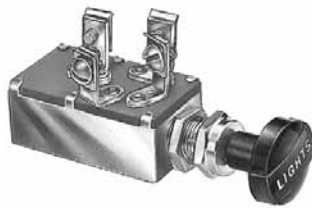

Four screw terminals, plated steel case, mounting stem with 7/16"-28 thread. 15A per circuit at 12V DC.

### 7124-06 with SAE headlamp symbol



Same as 7124, but with black knob imprinted with SAE headlamp symbol.

### 72100 with black knob 'Lights' ★

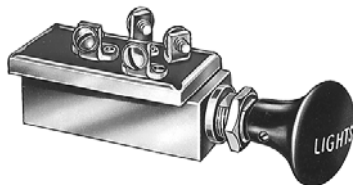

O-ring seal in mounting stem, gasket seal at terminal insulator. Four screw terminals, diecast case, silver contacts, mounting stem with 7/16"-28 thread. 20A per circuit at 12V DC.

### 72099\*

Same as 72100, but without sealing.

### 7152 with ivory knob 'Lights'

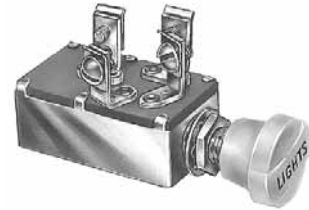

Four screw terminals, plated steel case, silver contacts, mounting stem with 3/8"-24 thread. 15A per circuit at 12V DC.

### 7157 with breaker



With 30A at 12V circuit breaker, ivory knob imprinted 'Lights'. Three screw terminals, plated steel case, silver contacts, mounting stem with 7/16"-28 thread.

### 72101 with breaker

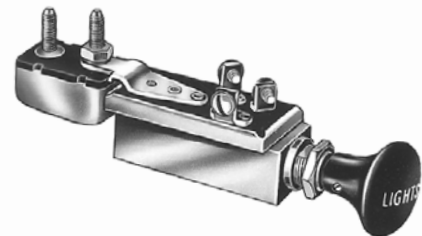

With 30A at 12V circuit breaker, black knob imprinted 'Lights'. O-ring seal in mounting stem and gasket seal at terminal insulator. Three screw terminals, diecast case, silver contacts, mounting stem with 7/16"-28 thread.

### 72102 with breaker

Same as 72101, but without sealing.

### 7127 with fuse



With 20A at 12V glass fuse, black knob imprinted 'Lights'. Four screw terminals, plated steel case, mounting stem with 7/16"-28 thread.

CONTINUED **D5**

★ Rapid ship item. BP Available in retail clamshell pack. \*Minimum order quantity may apply.

**With Dimmer**

*These switches have Headlamp/Parking Lights/Tail Lights functions as noted above, plus rotary dimmer functions for panel/dome lamps.*

**71092-02 4.5 Ohm, with internal 15A breaker ★**

In = All lights Off, except dome light on rotary dimmer.  
Mid = Parking lights & rear lights On; panel lights & dome light on rotary dimmer.

Out = Headlights & rear lights On; panel lights & dome light on rotary dimmer.

4.5 Ohm Dimmer, 15A at 12V internal Circuit Breaker. With black knob imprinted with SAE headlamp symbol. Eight blade terminals accept Delphi (Packard) connector 2977645 or 2984169. Plated steel case. Mounting stem 7/16"-28 thread. Terminal connections: 1 to battery +; 2 to panel lights; 3 to rear lights; 4 to rear lights; 5 to battery +; 6 to headlights; 7 to parking lights; A to dome light. Connect frame ground terminal to ground.

**71092**

Same as 71092-02, but without knob.

**7178 3.75 Ohm, with 30A breaker**

Rotation of knob dims panel lights in Mid and Out knob positions. 3.75 Ohm Dimmer, 30A at 12V Circuit Breaker. With black knob imprinted 'Lights'. Four screw terminals. Plated steel case. Mounting stem 3/8"-24 thread.

**71016 11 Ohm, with 20A breaker**

Rotation of knob dims panel lights in Mid and Out knob positions. 11 Ohm Dimmer, 20A at 12V Circuit Breaker. With tan knob imprinted 'Lights'. Four screw terminals. Plated steel case. Mounting stem 3/8"-24 thread.

**71016-01 11 Ohm, with 30A breaker**

Same as 71016, but with 30A at 12V Circuit Breaker.

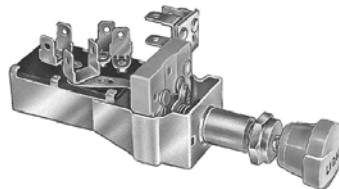
**71042 7 Ohm**

Rotation of knob dims panel lights in Mid and Out knob positions. 7.0 Ohm Dimmer. With ivory knob imprinted 'Lights'. Three single and three double blade terminals. Plated steel case. Mounting stem 3/8"-24 thread.

**4-position Headlamp and Worklight Switches**

*Four knob pull positions: In – Mid1 – Mid2 – Out.*

**7112 headlamp switch**

Five screw terminals. Plated steel case. Mounting stem 3/8"-24 thread. With tan knob imprinted 'Lights'. 10A at 12V DC.

**71033-02\* work light switch**

Three blade terminals. Plated steel case. Mounting stem 7/16"-28 thread. With O-ring seal at the mounting stem. With black knob imprinted with SAE work light symbol.

universal

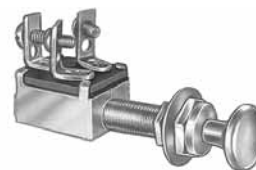

We have a wide selection of general purpose Push-Pull Switches: SPST, SPDT, DPST in steel case, brass case, and plasticized. See Section F.

**D6 ELECTRONIC DIMMER SWITCHES**

For variable intensity control of panel and interior vehicle lighting only. For 12V DC negative ground systems, 14.7V maximum. Black plastic knob with metal insert and set screw. Knob imprinted in white with the SAE variable symbol. Diecast case, 1 9/16" (39.7mm) diameter, .883" (22.4mm) long. 7/16" -28 thread mounting stem, .45" (22.4mm) long. O-ring seal.

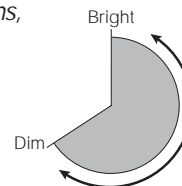
**74600-02 4 Amps, Delphi (Packard) connector** BP

Three wires (load, battery, ground) with Delphi (Packard) connector 2984378 on 3" (76.2mm) leads. Duty cycle: 0 - 100%.

**74600-09 4 Amps, leads**

Same as 74600-02, except with two wires, no connector. Two wires (load, battery) 1 25/32" (45.3mm) long. Duty cycle: 1 - 99%.

**74603 6 Amps, AMP connectors**

Two wires (load, battery) 2" (50.8mm) long, with two AMP connectors (load 480054-3, battery 480053-3). Duty cycle: 1 - 99%.

**74601-01 7 Amps** BP ★

Two wires (load and battery) 1 25/32" (45.2mm) long. Duty cycle: 1 - 99%.

## advantages

**Electronic dimmers have several advantages:**

- Intensity settings are not load-sensitive.
- Cool operation due to low heat generation.
- Resistant to contamination: sealed case with O-ring seal in shaft.
- Electronic circuit is protected from damage or malfunction due to: Power supply noise; Reverse polarity; Field decay; RF radiation; Load dump (per SAE J1113a).

## digital dimmer

See Section K2.

**FOOT-OPERATED D7**

★ Rapid ship item. BP Available in retail clamshell pack. ★ Minimum order quantity may apply.



## D7 FOOT-OPERATED SWITCHES

**Headlamp Dimmer Switches**

*SPDT On - On. Depress-release for low beam, depress-release for high beam. Corrosion-resistant diecast metal housings, moisture-repellent insulators.*

Also available: 7794\* Column-mounted Dimmer Switch. SPDT On-On. Three blade terminals. Replaces: Delco 1997045, 7838234, D-812.

**Through-floorboard mounting****7700 with three wire terminals**

PVC-coated case and leads gives added protection. Three 16AWG leads 5.75" (146.1mm) long. 27/32" (21.4mm) diameter stem. Three 1/4" -20 tapped mounting holes, 1 3/4" and 1 3/4" on centers (19.1 and 44.5mm).

**7786 with three screw terminals** ★

1 1/16" (27.0mm) diameter stem. Three 1/4" -20 tapped mounting holes, 3/4" and 1 3/4" (19.0 and 44.4mm) on centers.

Replaces: Delco 1997014, D-805.

**7787 with three screw terminals**

7/8" (22.2mm) diameter stem. Two 1/4" -20 tapped mounting holes, 1 3/4" (44.4mm) on centers.

Replaces: AMC 803870, 811681, Chrysler 1689512, Delco A-800, Ford A8AZ-13A024A, 7RA, 8A-13532, Motorcraft SW-256, 260.

**7769 with three screw terminals** ★

27/32" (21.4mm) diameter stem. Three 1/4" -20 tapped mounting holes, 3/4" and 1 3/4" (19.0 and 44.4mm) on centers.

Replaces: Delco 465A-Z, 471P-Z, 1997002, 1997008, 1997009, 199870014, D-805, U-802, Ford 81A, 11A13532, Mack 1MR-234.

**7784 with three screw terminals, and weather-resistant seal** ★

7/8" (22.2mm) diameter stem. Three 1/4" -20 tapped mounting holes, 3/4" and 1 3/4" (19.0 and 44.4mm) on centers. Weather-resistant seal in the case.

**7789-02 with three blade terminals, and drain hole**

55/64" (21.8mm) diameter stem. Two 1/4" -20 tapped mounting holes, 1 3/4" (44.4mm) on centers. Drain hole in the case.

**On-floorboard mounting****7702** ★

Two 7/32" (5.6mm) diameter mounting holes, 1 5/8" (41.3mm) on centers. Three blade terminals.

Replaces: Delco U803, Ford C0TF, C0TZ-13A024A, Motorcraft SW-263.

**7776**

Two 7/32" (5.6mm) diameter mounting holes, 1 5/8" (41.3mm) on centers. Three blade terminals.

Replaces: AMC 3156124, 3160926, Chrysler 1841895, 1881938, 2097628, 2291202, 3488882, CH-247, Delco U-801, Ford B9A-13532-A.

**foot-operated starters**

See Section C4.

**D7** FOOT-OPERATED SWITCHES

**7762** ★

Two 9/32" (7.1mm) diameter mounting holes, 1 3/4" (44.4mm) on centers. Three blade terminals.

Replaces: AMC 5457282, Delco 1997028, 1997031, 1997035, 1997037, 1997040, 1997043, D-803, D-804, D-808, D-809, D-810, GMC 5834446, 578005, 1539288.



**30156 connector**

Fits Cole Hersee switches 7702 and 7776.

Ford trucks 60-87, Dodge trucks 59-86.



**30155 connector**

Fits Cole Hersee switch 7762.

Trucks: Autocar 68-80, Chevrolet 61-86, GMC 69-86, International 61-80, Freightliner 63-67, 72-80, Kenworth 65-67, 72-74, 77-80.



## Turn Switches

*Through-floorboard mounting. Depress to On, spring return to Off. Two switches are needed for left and right turn signals.*

**7785 sealed, with wire leads**

7/8" (22.2mm) diameter stem. Three 1/4" -20 tapped mounting holes, 3/4" and 1 3/4" (19.0 and 44.4mm) on centers. Plastic-coated, providing protection against moisture, dust and roadsplash.



when a floor switch is impracticable



Panel-mount Dimmer and Headlamp Switch 7112 is frequently spec'd in delivery vans requiring stand-up operation, and in vehicles for the physically-impaired. See Section D5.

**7792-01 with screw terminals**

7/8" diameter stem. Three 1/4" -20 tapped mounting holes, 3/4" and 1 3/4" (19.0 and 44.4mm) on centers.



**7792 sealed, with screw terminals**

7/8" diameter stem. Three 1/4" -20 tapped mounting holes, 3/4" and 1 3/4" (19.0 and 44.4mm) on centers. Plastic-coated, providing protection against moisture, dust and roadsplash.



## Starter Switches

*Off-On, normally Off. Depress to On, spring return to Off.*

**9060 through-floorboard mounting** ★

Two stud terminals, 5/16" -24 thread with hexnuts and lockwashers.

Plunger is 1.83" (46.5mm) long. Two 9/32" (7.2mm) diameter mounting holes, 1 3/4" (44.5mm) on centers.

Replaces: Autolite SW-40001 (15-47), 15-50, 401A, 4002, 4005, 4010, 4015 (15-51), Delco D900 (405C).



**9183 through-floorboard mounting, short stem** ★

Two stud terminals, 5/16" -24 thread with hexnuts and lockwashers.

Plunger is 1" (25.4mm) long. Two 9/32" (7.2mm) diameter mounting holes, 1 3/4" (44.5mm) on centers.

Replaces: Autolite SW-4012 (15-49), Delco 1996478.

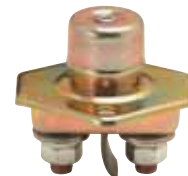

**91001 on-floorboard mounting**

One stud terminal, 3/8" -16 thread for attaching external ground wire. Plunger is 21/32" (16.7mm) long. Two .218" x .265" (5.5 x 6.7mm) mounting holes, 1.40" (35.6mm) on centers.

Replaces: Autolite 15-201, Delco 1930496 (D906).



NOTES

★ Rapid ship item. BP Available in retail clamshell pack. \*Minimum order quantity may apply.



## quick-tap wire splicer

### No need to strip the wire!

#### 30223 Quick-Tap, Section P5

##### To make a Tap Splice

With the splicer open:  
Press the existing circuit wire (red wire in the picture) into the outer channel.  
Press the tap wire (yellow) into the inner channel.  
Snap the splicer cover into place.  
Squeeze with pliers.



##### To make an Inline Splice

With the splicer open:  
Press one wire (yellow) into the outer channel.  
Press the other wire (red) into the inner channel.  
Snap the splicer cover into place.  
Squeeze with pliers.



##### To make a Pigtail Splice

With the splicer open:  
Press one wire (red) into the outer channel.  
Press the other wire (yellow) into the inner channel.  
Snap the splicer cover into place.  
Squeeze with pliers.



# ignition switches



C

|                                  |    |
|----------------------------------|----|
| 956 SERIES SWITCHES              | C1 |
| UNIVERSAL START SWITCHES         | C2 |
| MARINE SWITCHES                  | C3 |
| SPECIALIZED IGNITION SWITCHES    | C4 |
| ACCESSORIES                      | C5 |
| INFORMATION ON IGNITION SWITCHES | C6 |

## ignition switches

### C1 956 SERIES BATTERY IGNITION AND STARTER SWITCHES

All ignition switches in this series with blade terminals accept Delphi (Packard) connector 2962912. In the tables: Actuation/Lock column: Hencol S = short handle Hencol keys 83357, Lever S = short handle lever knob 81254. Seal column: S = Shutter lock seal, G = Gasket seal, O = O-ring seal in stem.

#### Heavy Duty

Dependable switches with an array of options for every application.

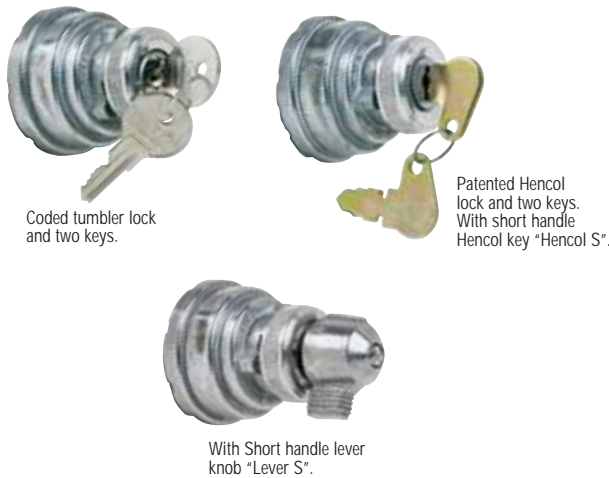

**Terminals:** Brass blade, 1/4" (6.4mm) wide, which accept Delphi (Packard) connector No. 2962912 or equivalent, or screw terminals with lock washers. Sealed terminal insulator.

**Housing:** Corrosion-resistant diecast construction.

**Mounting:** 1" -24 bushings fit panels from .030" (.76mm) through .090" (2.3mm) thick. All other bushing sizes fit panels .060" (1.5mm) up to .110" (2.7mm) thick.

#### 4-Position

| Part No.                              | Terminals | Actuation/<br>Lock | Seal  | Ground<br>Terminal | Bushing |
|---------------------------------------|-----------|--------------------|-------|--------------------|---------|
| 956-4100                              | 4 blade   | Coded              | S     | -                  | 1"-24   |
| 956-4104                              | 4 screw   | Coded              | S     | -                  | 1"-24   |
| 956-4107                              | 4 screw   | Hencol S           | G O   | -                  | 1"-24   |
| 956-4111                              | 4 blade   | Lever S            | -     | -                  | 1"-24   |
| 956-4124                              | 4 screw   | Lever S            | G O   | -                  | 1"-24   |
| 956-4154                              | 5 screw   | Coded              | S     | ✓                  | 1"-24   |
| 956-4304                              | 4 screw   | Coded              | -     | -                  | 3/4"-24 |
| 956-4305*                             | 4 screw   | Coded              | S G O | -                  | 3/4"-24 |
| 956-4306*                             | 4 screw   | Hencol S           | -     | -                  | 3/4"-24 |
| 956-4307                              | 4 screw   | Hencol S           | G O   | -                  | 3/4"-24 |
| 956-4311                              | 4 blade   | Coded              | O     | -                  | 3/4"-24 |
| 956-4354*                             | 5 screw   | Coded              | S     | ✓                  | 3/4"-24 |
| 956-4704                              | 4 screw   | Coded              | S     | -                  | 7/8"-24 |
| <b>With identical key code CH-528</b> |           |                    |       |                    |         |
| 956-4148                              | 4 blade   | Coded              | S     | ✓                  | 1"-24   |

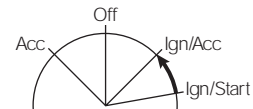

Spring return to IGN/ACC. Key is removable only in the Off position.

Electrical ratings at 12V DC: 10A Accessory, 10A Ignition, 5A Start, 1A Ground

CONTINUED C1

★ Rapid ship item. BB Available in retail clamshell pack. ✪ Minimum order quantity may apply.

# C ignition switches

## C1 956 SERIES BATTERY IGNITION AND STARTER SWITCHES

All ignition switches in this series with blade terminals accept Delphi (Packard) connector 2962912.

### 3-Position

#### Off – Ignition – Ignition/Start

| Part No.  | Terminals | Actuation/<br>Lock | Seal | Ground<br>Terminal | Bushing |
|-----------|-----------|--------------------|------|--------------------|---------|
| 956-5144* | 4 screw   | Coded              | S    | ✓                  | 1"-24   |
| 956-5304* | 3 screw   | Coded              | S    | -                  | 3/4"-24 |
| 956-5306* | 3 screw   | Hencol S           | -    | -                  | 3/4"-24 |
| 956-5307  | 3 screw   | Hencol S           | G O  | -                  | 3/4"-24 |

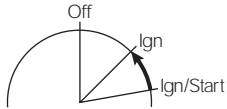

Spring return to IGN. Key is removable only in the Off position. Electrical ratings at 12V DC: 10A Ignition, 5A Start, 1A Ground

#### Off – Ignition/Accessories – Ignition/Start

| Part No.  | Terminals | Actuation/<br>Lock | Seal  | Ground<br>Terminal | Bushing |
|-----------|-----------|--------------------|-------|--------------------|---------|
| 956-5109† | 4 screw   | Lever▲             | G     | -                  | 1"-24   |
| 956-5122  | 5 screw   | Coded              | G S O | ✓                  | 1"-24   |
| 956-5124* | 4 screw   | Hencol S           | G O   | -                  | 1"-24   |
| 956-5348* | 5 screw   | Hencol S           | G O   | ✓                  | 3/4"-24 |

▲ Military lever. † Silver contacts.

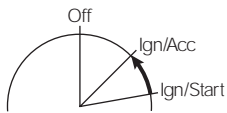

Spring return to IGN/ACC. Key is removable only in the Off position. Electrical ratings at 12V DC:  
 956-5109: 20A Accessory, 10A Ignition, 10A Start  
 956-5122: 20A Accessory, 20A Ignition, 10A Start, 1A Ground  
 956-5124: 10A Accessory, 10A Ignition, 5A Start  
 956-5348: 10A Accessory, 10A Ignition, 5A Start, 1A Ground

#### Accessory – Off – Ignition/Accessories

| Part No.  | Terminals | Actuation/<br>Lock | Seal | Ground<br>Terminal | Bushing |
|-----------|-----------|--------------------|------|--------------------|---------|
| 956-6104  | 3 screw   | Coded              | S    | -                  | 1"-24   |
| 956-6107* | 3 screw   | Hencol S           | G O  | -                  | 1"-24   |
| 956-6304* | 3 screw   | Coded              | S    | -                  | 3/4"-24 |
| 956-6307  | 3 screw   | Hencol S           | G O  | -                  | 3/4"-24 |

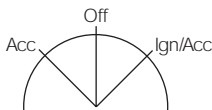

Key is removable only in the Off position. Electrical ratings at 12V DC: 10A Accessory, 10A Ignition

### 2-Position

| Part No.  | Terminals | Actuation/<br>Lock | Seal | Ground<br>Terminal | Bushing |
|-----------|-----------|--------------------|------|--------------------|---------|
| 956-7104* | 2 screw   | Coded              | S    | -                  | 1"-24   |
| 956-7106* | 2 screw   | Hencol S           | -    | -                  | 1"-24   |
| 956-7107* | 2 screw   | Hencol S           | G O  | -                  | 1"-24   |
| 956-7304* | 2 screw   | Coded              | S    | -                  | 3/4"-24 |

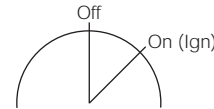

Key is removable only in the Off position. Electrical ratings at 12V DC: 10A Ignition

### Anti-Restart Ignition Switches

*When the engine is running, the starter circuit cannot be energized. This prevents accidental damage to the starter motor, and is highly recommended in situations such as package delivery vehicles or in noisy locations where it might not be evident that the motor is running. The switch must be turned to the Off position before the start circuit can be re-energized.*

| Part No.   | Terminals | Actuation/<br>Lock | Seal  | Ground<br>Terminal | Bushing |
|------------|-----------|--------------------|-------|--------------------|---------|
| 956-3122   | 5 screw   | Coded              | G S O | ✓                  | 1"-24   |
| 956-3124 ★ | 5 screw   | Lever S            | O     | ✓                  | 1"-24   |
| 956-3125   | 4 screw   | Coded              | G S   | -                  | 1"-24   |
| 956-3126 ★ | 4 screw   | Hencol S           | G     | -                  | 1"-24   |
| 956-3127   | 3 screw   | Lever S            | G O   | -                  | 1"-24   |
| 956-3131*  | 5 blade   | Coded              | G S   | ✓                  | 1"-24   |
| 956-3134♦  | 4 screw   | Coded              | G S   | -                  | 1"-24   |
| 956-3137*  | 4 screw   | Hencol S           | G O   | -                  | 1"-24   |

With identical key code CH-535

|           |         |       |     |   |       |
|-----------|---------|-------|-----|---|-------|
| 956-3130* | 4 screw | Coded | G S | - | 1"-24 |
|-----------|---------|-------|-----|---|-------|

♦ Same as No. 3125 except with accessory terminal rotated 180°

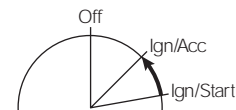

Spring return to IGN/ACC. Key is removable only in the Off position.

Electrical ratings at 12V DC:

10A Accessory, 10A Ignition, 5A Start, 1A Ground: switches 956-3122, 956-3124, 956-3136.

30A Accessory, 10A Ignition, 10A Start: switches 956-3125, 956-3134.

30A Accessory, 10A Ignition, 10A Start, 1A Ground: switch 956-3131.

30A Accessory, 10A Ignition, 5A Start: switch 956-3136.

10A Ignition, 5A Start, 1A Ground: switch 956-3127.

10A Accessory, 10A Ignition, 5A Start: 956-3137.

★ Rapid ship item. BP Available in retail clamshell pack. ★ Minimum order quantity may apply.



# ignition switches

C

## C1 956 SERIES BATTERY IGNITION AND STARTER SWITCHES

All ignition switches in this series with blade terminals accept Delphi (Packard) connector 2962912.

### Extra Heavy Duty Ignition and Starter Switches

Specially designed for demanding applications with higher energy circuits, typically 30A or 20A at 12V DC.

#### 4-Position

#### Accessory – Off – Ignition/Acc – Ignition/Start

| Part No.   | Terminals | Actuation/Lock | Seal | Ground Terminal | Bushing |
|------------|-----------|----------------|------|-----------------|---------|
| 956-4113   | 4 blade   | Hencol S       | S O  | -               | 1"-24   |
| 956-4116*  | 4 blade   | Coded          | S G  | -               | 1"-24   |
| 956-4138 ★ | 4 blade   | Coded          | -    | -               | 1"-24   |
| 956-4141†  | 4 screw   | Hencol S       | S O  | -               | 1"-24   |

† Silver contacts.

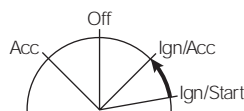

Key is removable only in the Off position. Spring return to IGN/ACC.

Electrical ratings at 12V DC:

30A Accessory, 10A Ignition, 5A Start: switches 956-4113, 956-4125.

30A Accessory, 10A Ignition, 10A Start: switch 956-4116.

20A Accessory, 20A Ignition, 10A Start: switches 956-4138, 956-4141.



### anti-restart

No more burned out starter motors! Use Anti-Restart Ignition Switches in situations where equipment is frequently left idling, and there is chance that the operator might 'restart' the engine. This occurs in industrial locations where noise levels are high, in delivery trucks, and many other situations.

See Section C1.

#### 3-Position

#### Off – Ignition/Accessory – Ignition/Start

| Part No.  | Terminals | Actuation/Lock | Seal | Ground Terminal | Bushing |
|-----------|-----------|----------------|------|-----------------|---------|
| 956-5108* | 4 screw   | Coded          | S G  | -               | 1"-24   |

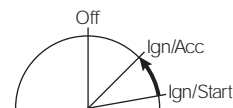

Key is removable only in the Off position. Spring return to IGN/ACC. Silver contacts.

Electrical ratings at 12V DC: 30A Accessory, 10A Ignition, 10A Start.

#### Accessory – Off – Ignition/Accessory

| Part No.  | Terminals | Actuation/Lock | Seal | Ground Terminal | Bushing |
|-----------|-----------|----------------|------|-----------------|---------|
| 956-6310* | 3 screw   | Hencol S       | S O  | -               | 3/4"-24 |

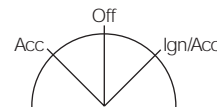

Key is removable only in the Off position. Electrical ratings at 12V DC: 30A Accessory, 10A Ignition.



### custom ignition switches

A customer recently asked us to design a totally new ignition switch, sealed to IP67 and with an integrated connector. Our engineers work closely with OE engineers to design switching solutions. How can we help you?

UNIVERSAL SWITCHES C2

★ Rapid ship item. BB Available in retail clamshell pack. ★ Minimum order quantity may apply.



Cole Hersee Co. 20 Old Colony Ave, Boston, MA 02127-2467

33

T 617.268.2100 F 617.268.9490 www.colehersee.com

# C ignition switches

## C2 UNIVERSAL BATTERY IGNITION AND START SWITCHES

In the tables: Actuation/Lock column: Hencol S = short handle Hencol key 83357, Hencol L = long handle Hencol key 83353; Lever S = short lever knob 81254, Lever L = long lever knob 80101 -B. Seal column: S = Shutter lock seal, G = Gasket seal, O = O-ring seal in stem.



### Case A

Zinc diecast, coded tumbler lock. Fits panels up to 3/8" (9.5mm).



### Case B

Plated steel, coded tumbler lock. Fits panels up to 1/2" (12.7mm).



### Case C

Plated steel. Non-tumbler Hencol lock: either short handle key (Hencol S), or long handle key (Hencol L). Fits panels up to 1/8" (3.2mm).



### Case D

Zinc diecast, military lever. Fits panels up to 11/64" (4.4mm).



### Case F

Plated steel. Lever knob: either short (Lever S), or long (Lever L). See Section C6. Fits panels up to 1/8" (3.2mm).



### Case G

Plated steel. Non-tumbler Hencol lock: either short handle key (Hencol S), or long handle key (Hencol L). Fits panels up to 1/4" (6.4mm).

## 4-Position

### Accessory – Off – Ignition/Acc – Ignition/Start

| Part No.                       | Terminals | Actuation/<br>Lock | Seal | Case | Bushing   |
|--------------------------------|-----------|--------------------|------|------|-----------|
| 9579 <sup>BP</sup> ★           | 4 screw   | Coded              | -    | A    | 3/4"-20   |
| 95535                          | 4 screw   | Coded              | -    | B    | 13/16"-24 |
| 95515-A                        | 4 screw   | Hencol S           | -    | C    | 5/8"-32   |
| 95525-A                        | 4 screw   | Hencol S           | O    | C    | 5/8"-32   |
| With identical key code CH-505 |           |                    |      |      |           |
| 9579-02                        | 4 screw   | Coded              | -    | A    | 3/4"-20   |

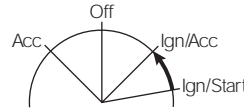

Key is removable only in the Off position. Spring return to IGN/ACC. Electrical ratings at 12V DC: 10A Accessory, 10A Ignition, 5A Start.

## 3-Position

### Off – Ignition – Ignition/Start

| Part No.  | Terminals | Actuation/<br>Lock | Seal | Case | Bushing   |
|-----------|-----------|--------------------|------|------|-----------|
| 9513      | 3 screw   | Coded              | -    | A    | 3/4"-20   |
| 95534     | 3 screw   | Coded              | -    | B    | 13/16"-24 |
| 95514-A   | 3 screw   | Hencol S           | -    | C    | 5/8"-32   |
| 95524-A ★ | 3 screw   | Hencol S           | O    | C    | 5/8"-32   |
| 95582     | 3 screw   | Coded              | O    | A    | 3/4"-20   |
| 95634*    | 3 screw   | Lever S            | -    | D    | 3/4"-20   |
| 95634-01  | 3 screw   | Lever S            | O    | D    | 3/4"-20   |

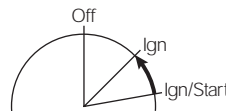

Key is removable only in the Off position. Spring return to IGN/ACC. Electrical ratings at 12V DC: 10A Ignition, 5A Start.

### Off – Ignition/Accessory – Ignition/Start

| Part No. | Terminals | Actuation/<br>Lock | Seal | Bushing |
|----------|-----------|--------------------|------|---------|
| 95591    | 4 screw   | Lever L            | O    | 5/8"-32 |

Case F, but with long lever knob.

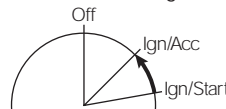

Spring return to IGN/ACC. Electrical ratings at 12V DC: 10A Accessory, 10A Ignition, 5A Start.

### Accessory – Off – Ignition/Accessory

| Part No. | Terminals | Actuation/<br>Lock | Seal | Case | Bushing |
|----------|-----------|--------------------|------|------|---------|
| 9578     | 3 screw   | Coded              | -    | A    | 3/4"-20 |
| 95523-A* | 3 screw   | Hencol S           | O    | C    | 5/8"-32 |

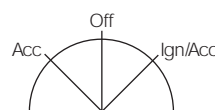

Key is removable only in the Off position. Electrical ratings at 12V DC: 10A Accessory, 10A Ignition.

★ Rapid ship item. <sup>BP</sup> Available in retail clamshell pack. ★ Minimum order quantity may apply.



## 2-Position

### Off – Start

| Part No. | Terminals | Actuation/<br>Lock | Seal | Case | Bushing |
|----------|-----------|--------------------|------|------|---------|
| 95564-01 | 2 blade   | Hencol S           | O    | G    | 5/8"-32 |

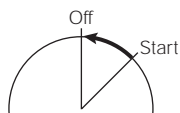

Key is removable only in the Off position. Spring return to Off.

Accepts Delphi (Packard) connector 2965454

Electrical ratings at 12V DC: 20A

### Off – Ignition/Accessory

| Part No.  | Terminals | Actuation/<br>Lock | Seal | Case | Bushing |
|-----------|-----------|--------------------|------|------|---------|
| 95608     | 3 screw   | Coded              | -    | A    | 3/4"-20 |
| 95633*    | 3 screw   | Lever S            | -    | D    | 3/4"-20 |
| 95633-A ★ | 3 screw   | Lever S            | -    | D    | 3/4"-20 |

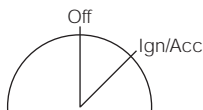

Key is removable only in the Off position.

95633 is moisture- and fungus-resistant per MIL-JAN-T-152

Electrical ratings at 12V DC: 10A Accessory, 10A Ignition

### Off – On (Ignition)

| Part No. | Terminals | Actuation/<br>Lock | Seal | Case | Bushing   |
|----------|-----------|--------------------|------|------|-----------|
| 9577 ★   | 2 screw   | Coded              | -    | A    | 3/4"-20   |
| 95532    | 2 screw   | Coded              | -    | B    | 13/16"-24 |
| 95512-A  | 2 screw   | Hencol S           | -    | C    | 5/8"-32   |
| 95522-A  | 2 screw   | Hencol S           | O    | C    | 5/8"-32   |
| 9518     | 2 screw   | Coded              | -    | A    | 3/4"-20   |

Key is removable only in the Off position, except 9518 where the key is removable in both positions. 9518 is suitable for security alarm applications.

See also Section C4 for compact keyed switch 9622-01.

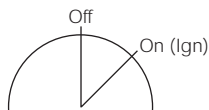

Electrical ratings at 12V DC: 10A Ignition

## Extra Heavy Duty

### 3-Position

### Off – Ignition – Ignition/Start

| Part No. | Terminals | Actuation/<br>Lock | Seal | Case | Bushing |
|----------|-----------|--------------------|------|------|---------|
| 95610    | 3 screw   | Lever S            | -    | F    | 5/8"-32 |
| 95612 ★  | 3 screw   | Lever S            | O    | F    | 5/8"-32 |
| 95613    | 3 blade   | Lever S            | O    | F    | 5/8"-32 |
| 95561-01 | 3 blade   | Hencol S           | O    | G    | 5/8"-32 |
| 95521-01 | 3 screw   | Lever S ▲          | O    | G    | 5/8"-32 |
| 95511-B  | 3 screw   | Hencol S           | -    | G    | 5/8"-32 |
| 95521-B  | 3 screw   | Hencol L           | O    | G    | 5/8"-32 |

▲ Lever is dichromate finish.

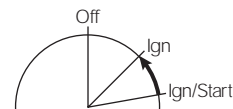

Key is removable only in the Off position, spring return to IGN.

95561-01 accepts Delphi (Packard) connector 2973386

Electrical ratings at 12V DC:

10A Ignition, 5A Start: 95561-01

20A Ignition, 20A Start: 95613

25A Ignition, 20A Start: 95610, 95612,

25A Ignition, 70A Start: 95521-01, 95511-B, 95521-B

## 2-Position

### Off – Start

| Part No. | Terminals | Actuation/<br>Lock | Seal | Case | Bushing |
|----------|-----------|--------------------|------|------|---------|
| 95617*   | 2 screw   | Hencol S           | -    | F-1  | 5/8"-32 |

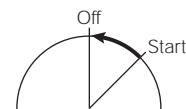

Key is removable only in the Off position, spring return to Off.

Electrical ratings at 12V DC: 40A Inrush, 15A Break

### Off - On (Ignition)

| Part No. | Terminals | Actuation/<br>Lock | Seal | Case | Bushing |
|----------|-----------|--------------------|------|------|---------|
| 95597    | 2 screw   | Hencol L           | O    | G    | 5/8"-32 |
| M-288    | 2 screw   | Lever L            | O    | G    | 5/8"-32 |

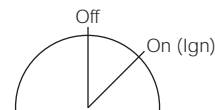

Key is removable only in the Off position.

Electrical ratings at 14V DC: 50A, silver contacts.

# C ignition switches

## C3 MARINE BATTERY IGNITION AND START SWITCHES

Marine switches are highly suitable for harsh environments whether on land or at sea. They are corrosion-resistant, often with brass cases and extra seals. Moisture-repellent insulators, coded locks with 2 brass keys. For 6-36V DC applications.

### 4-Position

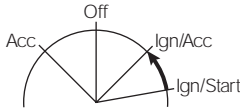

Key is removable only in the Off position, spring return to IGN/ACC.

Electrical ratings at 12V DC:

10A Accessory, 5A Ignition, 5A Start.

### M-712 BP ★



Four brass screw terminals. Brass case and mounting hardware, chrome-plated brass facenut. Brass mounting stem 13/16" -24, 1 7/32" (31.0mm) long, fits panels up to 1" (25.4mm).

### M-712-02 weather-resistant

Same as M-712, except with O-ring seal in the mounting stem, and with spring-actuated shutter in the lock face to protect the cylinder when not in use.

### M-712-09 with rubber boot assembly BP



Same as M-712, except with weather-resistant rubber boot and mounting nut assembly to protect against moisture and dirt with or without the key inserted.

### M-700 with diecast case



Four brass screw terminals. Diecast case with protective finish. Mounting stem 3/4" -20, 13/16" (20.6mm) long, fits panels up to 1/4" (6.4mm). Knurled aluminum adapter facenut permits mounting in 3/4" (19.1mm) to 7/8" (22.2mm) diameter holes.

### 3-Position

#### Off – Ignition – Ignition/Start

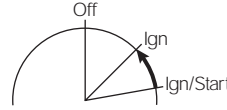

Key is removable only in the Off position, spring return to IGN. Electrical ratings at 12V DC: 10A Ignition, 5A Start.

### M-550 with screw terminals BP ★



Three brass screw terminals. Brass case and mounting hardware, chrome-plated brass facenut. Brass mounting stem 13/16" -24, 1 7/32" (31.0mm) long, fits panels up to 1" (25.4mm).

### M-550-04 with blade terminals

Same as M-550, but with blade terminals.

### M-6110-01 weather-resistant

Same as M-550, except with O-ring seal in the mounting stem, and with spring-actuated shutter in the lock face to protect the cylinder when not in use.

### M-550-14 with rubber boot assembly BP



Same as M-550, except with weather-resistant rubber boot and mounting nut assembly to protect against moisture and dirt with or without the key inserted.

### M-550-25 with protective cap



Same as M-550, except with a captive plastic cap that snaps over a special facenut to protect the lock when not in use. Fits panels up to 5/8" (15.9mm).

★ Rapid ship item. BP Available in retail clamshell pack. ★ Minimum order quantity may apply.



Cole Hersee Co. 20 Old Colony Ave, Boston, MA 02127-2467

## M-711 with diecast case

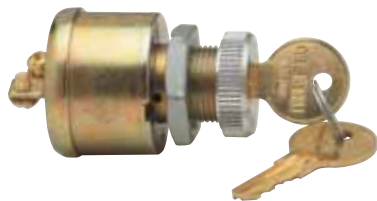

Three brass screw terminals. Diecast case with protective finish. Mounting stem 3/4" -20, 13/16" (20.6mm) long, fits panels up to 1/4" (6.4mm). Knurled aluminum adapter facenut permits mounting in 3/4" (19.1mm) to 7/8" (22.2mm) diameter holes.

## M-850 plastic body BP ★



Key is removable only in the Off position, spring return to IGN.

Electrical ratings at 6-36V DC: 15A Ignition, 5A Start. Three nickel-silver screw terminals. Durable plastic case and stem with PVC boot for added weather protection. Mounting stem fits panels up to 7/8" (22.2mm) thick, with 7/8" diameter hole.

Fits many boats, including Baja, Celebrity, Chapparral, ChrisCraft, Crestliner, Crownline, Four Winns, Larson, Luhrs, Mariah, Powerquest, Rinker, S2 Yachts, Silverton Yacht, Thompson, Thunderbird (Formula), Wellcraft.

## With Push-to-Choke

### M-932

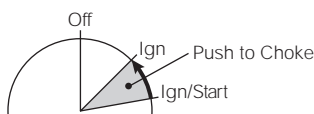

Key is removable only in the Off position, spring return to IGN.

Electrical ratings at 12V DC:

5A Ignition, 5A Start, 2A Choke.

One brass screw and three brass blade terminals. Brass case and mounting hardware, chrome-plated brass facenut. Brass mounting stem 13/16" -24, 15/16" (23.8mm) long, fits panels up to 1/2" (12.7mm). O-ring seal in the mounting stem.

## M-832 plastic body BP ★



Key is removable only in the Off position, spring return to IGN. Electrical ratings at 6-36V DC:

15A Ignition, 5A Start. Six nickel-silver screw terminals. Durable plastic case and stem with PVC boot for added weather protection. Long mounting stem 2.00" (50.8mm) long, fits panels up to 1 3/8" (34.9mm) thick, and with 7/8" diameter hole (22.2mm). Fits many boats, including Bayliner, ChrisCraft, Sea Ray.

## 2-Position

Key is removable only in the Off position.

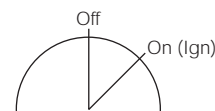

## M-489 BP ★

Electrical ratings at 12V DC: 10A Ignition. Two brass screw terminals. Brass case and mounting hardware, chrome-plated brass facenut. Brass mounting stem 13/16" -24, 1 7/32" (31.0mm) long, fits panels up to 1" (25.4mm).



## M-489-03 weather-resistant

Electrical ratings at 12V DC: 10A Ignition. Same as M-489, except with O-ring seal in the mounting stem, and with spring-actuated shutter in the lock face to protect the cylinder when not in use.

## M-497 with lever BP ★

Electrical ratings at 12V DC: 10A Ignition. Two brass screw terminals. Brass case, brass mounting stem 1/2" -20, 1 1/4" (31.8mm) long, fits panels up to 7/8" (22.2mm). chrome-plated diecast long lever.



## M-702 with diecast case



Electrical ratings at 12V DC: 10A Ignition. Two brass screw terminals. Diecast case with protective finish. Mounting stem 3/4" -20, 13/16" (20.6mm) long, fits panels up to 1/4" (6.4mm). Knurled aluminum adapter facenut permits mounting in 3/4" (19.1mm) to 7/8" (22.2mm) diameter holes.

## M-676 BP ★



Electrical ratings at 12V DC: 5A Ignition. Two brass screw terminals. Brass case with chrome-plated integral bezel. Brass mounting stem 3/4" -27, 3/4" (19.1mm) long, fits panels up to 5/8" (15.9mm). Double bit keys.

CONTINUED C3

★ Rapid ship item. BP Available in retail clamshell pack. ★ Minimum order quantity may apply.



# C ignition switches

## C3 MARINE BATTERY IGNITION AND START SWITCHES

### Marine 2-Circuit Switch

M-703

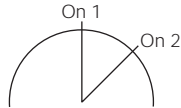

Key removable in both positions.  
Electrical ratings at 12V DC: 10A both positions.  
Three brass screw terminals. Diecast case. Mounting stem 3/4" -20, 13/16" (20.6mm) long, fits panels up to 1/4" (6.4mm). Knurled aluminum adapter facenut permits mounting in 3/4" (19.1mm) to 7/8" (22.2mm) diameter holes.

### Marine 3-Position Magneto Ignition and Battery Start Switch with Push-to-Choke

M-924

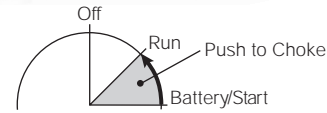

Key removable in Off position, spring return to RUN.  
Electrical ratings at 12V DC: 2A Magneto, 10A Battery/Ignition, 3A Choke, 5A Start.  
Six brass screw terminals. Brass case and mounting hardware, chrome-plated brass facenut. Brass mounting stem 13/16" -24, fits panels up to 15/16" (23.8mm).  
O-ring seal in the mounting stem.

# ignition switches

## C4 SPECIALIZED IGNITION SWITCHES

### Magneto Ignition and Battery Start Switches

*Dependable switches suitable for golf and utility carts, lawn and garden tractors and similar applications.*

#### 3-Position

#### Off – Run – Start (start terminal to Battery)

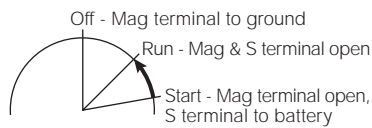

Key removable in Off position, spring return to RUN.  
Self-grounding in the Off position in metal panels.

95520-B 70A start



Electrical ratings at 12V DC: 70A Start, 1A Magneto.  
Three screw terminals. Plated steel case. 5/8" -32 mounting stem with O-ring seal, fits panels up to 1/4" (6.4mm). Long Hencol key.

95663-04 5A start



Electrical ratings at 12V DC: 5A Start, 1A Magneto.  
Three blade terminals. Diecast zinc case. 5/8" -32 mounting stem with O-ring seal, fits panels up to 7/32" (5.5mm).  
Mates with Delphi (Packard) connector 2973422.

#### Off – Run – Start (start terminal to Ground)

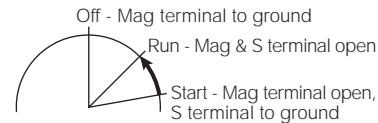

Key removable in Off position, spring return to RUN.  
Self-grounding in the Off position in metal panels.  
Electrical ratings at 12V DC: 5A Start, 1A Magneto

★ Rapid ship item. BP Available in retail clamshell pack. ★ Minimum order quantity may apply.

95526-A\*



Three screw terminals. Plated steel case. 5/8" -32 mounting stem, fits panels up to 9/16" (14.3mm). With O-ring seal.

### Off – Run/Accessories – Start

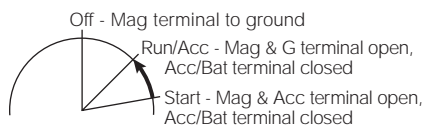

Key removable in Off position, spring return to RUN/ACC. Self-grounding in the Off position in metal panels. Electrical ratings at 12V DC: 10A Accessory, 5A Start, 1A Magneto.

### 2-Position

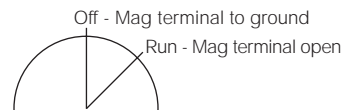

Key removable in Off position. Electrical ratings at 12V DC: 1A Run.

95539



Four screw terminals. Diecast case. 3/4" -20 mounting stem, fits panels up to 1/2" (12.7mm).

95616



Four screw terminals. Diecast case. 5/8" -32 mounting stem with O-ring seal, fits panels up to 9/16" (14.3mm).

95616-01

Same as 95616, except with blade terminals.

95517-A\*



Two screw terminals. Plated steel case. 5/8" -32 mounting stem, fits panels up to 9/16" (14.3mm).

95566\*



Two screw terminals. Plated steel case. 7/8" -27 mounting stem 1 7/32" (31.0mm) with O-ring seal, fits panels up to 15/64" (5.9mm).

95537\*



Two screw terminals. Plated steel case. 13/16" -24 mounting stem, fits panels up to 1/2" (12.7mm).

CONTINUED C4



# C ignition switches

## C4 SPECIALIZED IGNITION SWITCHES

### Reversing Switches

*These handy 3-Position switches can replace toggle or rockers. Keyed switches ensure that motors are locked in the Off position in cherrypickers, hoists, tailgate lifts, snowplows, walking-floor trailers, backhoes and many other applications. Typically one On is wired as Forward, the other On as Reverse.*

### On – Off – On (Reverse – Off – Forward) Spring Return

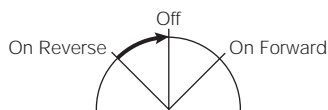

Key removable in Off position, spring return to Off from REVERSE.  
Electrical ratings at 12V DC: 10A Reverse or Forward

#### 95528-A\*



Three screw terminals. Plated steel case. 5/8" -32 mounting stem. O-ring seal in mounting stem. Fits panels up to 9/16" (14.3mm) thick.

### No Spring Return

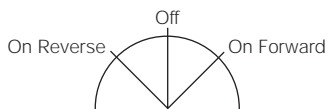

Key removable in Off position.  
Electrical ratings at 12V DC: 10A Reverse or Forward

#### 95593\* with tumbler lock



Three screw terminals. Zinc diecast case. 3/4" -20 mounting stem, fits panels up to 11/64" (4.4mm).

#### 95030-A\*

Same as 95528-A, except without O-ring seal (and without spring return).

### Mom On – Off – Mom On (Mom Forward – Off – Mom Reverse)

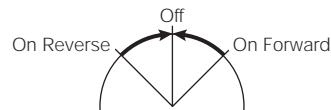

Key removable in Off position, spring return to Off.

#### 75705-01 10A with tumbler lock

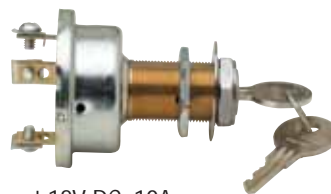

Electrical Ratings at 12V DC: 10A.  
Three screw terminals. Plated steel case. 13/16" -24 mounting stem with O-ring seal.

#### 75701 20A with lever



Electrical Ratings at 12V DC: 20A.  
Silver contacts. Three screw terminals. Plated steel case. 7/16" -28 mounting stem.



## reversing switches

### Reversing Switches

This type of switch has multiple applications: on cranes, hoists, winches, snowplows etc. — anything that calls for a motor to operate in forward-reverse, translating to motorized motion of up-down, left-right, open-close, in-out etc.

An alternate mechanism is to use Reversing Solenoids 24400, 24401, 24401-01, 24402, 24450 in conjunction with rocker, toggle, push-pull or rotary switches. These solenoids are also used for forward-reverse in simple automotive vehicles, such as golf carts and garden tractors.

★ Rapid ship item. BP Available in retail clamshell pack. ★ Minimum order quantity may apply.



Cole Hersee Co. 20 Old Colony Ave, Boston, MA 02127-2467

40

T 617.268.2100 F 617.268.9490 www.colehersee.com

## Compact Ignition and Start Switches

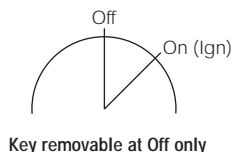

Key removable at Off only

### 9500 10A with lever

Electrical Ratings at 12V DC: 10A  
Two screw terminals. Plated steel case. 1/2" -20 mounting stem fits panels to 13/64" (5.2mm).



### 9622-01 5A with tumbler lock ★

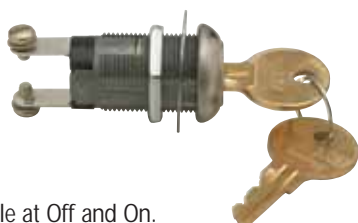

Key removable at Off and On.  
Electrical Ratings at 12V DC: 5A.  
Two screw terminals. Plated steel case. 3/4" -24 mounting stem fits panels to 3/4" (19.1mm). See also 9518 in Section C2.

## Delco Replacement Ignition and Start Switches

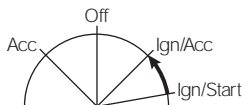

Key removable at Off, spring return to IGN/ACC

### 95400



Four screw terminals.  
**Replaces:** Delco D-1460, GMC 116508, Motorcraft SW-276.

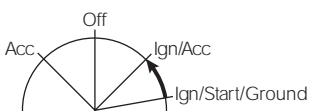

Key removable at Off, spring return to IGN/ACC

### 95408 5-blade terminals, for Delphi (Packard) 2984170



Without lock cylinder (order 95874, cylinder, 2 keys).  
Five blade terminals. 1" -24 UNS-2A thread.  
**Replaces:** Delco D-1469, D-1482, D-1482-A, GMC 1116672, 74, 85, 87, 1116704, 10. GMC Trucks '70.

### 95410 7-blade terminals, for Delphi (Packard) 6288702 ★



Without lock cylinder (order 95874, cylinder, 2 keys).  
Seven blade terminals, includes two ground terminals for checking indicator bulbs. One additional battery terminal provides continuous hot feed for optional equipment. O-ring seal in the mounting stem. 1" -24 UNS-2A thread.  
**Replaces:** Delco D-1403-A, D-1406-A, D-1480, D-1498-A, GMC 1116712, 1116683, 95, 1116704, 09, 11, 2234285, Chevrolet Trucks 67-83, 85-89, GMC Trucks 67-83, 85-89.

## Diesel Ignition and Start Switches

*These heavy-duty switches provide a superior pre-heat circuit to energize the glow plugs.*

### 4-Position

#### 956-9100

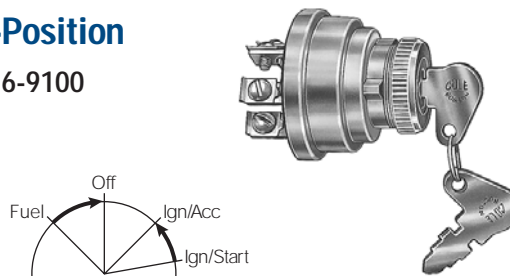

Key removable at Off, spring return to IGN/ACC, spring return from FUEL.  
Electrical Ratings at 12V DC: 10A Fuel, 10A Accessory, 5A Ignition, 5A start. Five screw terminals. Diecast case. 1" -24 mounting stem, with O-ring seal, fits panels up to 3/32" (2.4mm). Gasket-sealed terminal insulator.

# C ignition switches

## C4 SPECIALIZED IGNITION SWITCHES

### 3-Position

95033



Spring return to Off.  
Electrical Ratings at 12V DC: 50A Glow Plug, 10A Start.  
Three screw terminals. Plated steel case. 5/8" -32 mounting stem, with O-ring seal, fits panels up to 1/4" (6.7mm). Silver contacts.

### Battery Ignition and Light Switch

9621-01



Provides a light circuit in addition to the ignition function.  
Electrical Ratings at 12V DC: 5A Ignition, 5A Lights.  
Three screw terminals. Plated steel case. 5/8" -32 mounting stem, fits panels up to 9/64" (3.6mm).

### Push-Pull Battery Ignition and Starter Switch

9576



Spring return to IGN/ACC.  
Electrical Ratings at 12V DC: 10A Accessory, 5A Ignition, 5A Start.  
Four screw terminals. Plated steel case. 3/8" -24 mounting stem fit panels up to 3/16" (4.8mm). Includes hexnut and washer for mounting. Black plastic screw-on knob.

### Ignition Switch with Wire Lead Assembly

95614

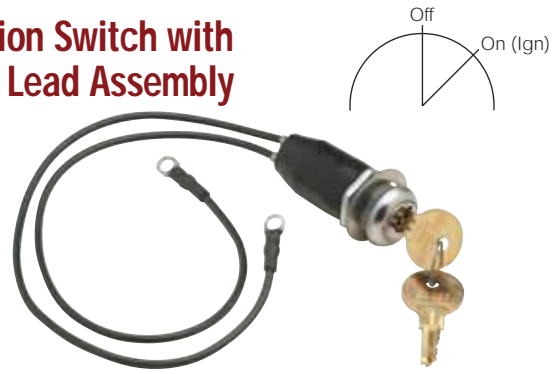

Key removable in Off.  
Electrical Ratings at 12V DC: 5A.  
Two 12" 14AWG wire leads with attached ring terminals. Heavy duty steel case, plated to resist corrosion. Coded lock cylinder with two keys. Rubber boot seal for added moisture and dust protection. 13/16" (20.6mm) diameter mounting stem, 25/64" (9.9mm) long fits panels up to 7/32" (5.5mm).

### Foot-Operated Starter Switches

*Off – On, normally Off. On with plunger depressed, spring return to Off.*  
**Copper contacts and terminal studs.**

#### 9060 long plunger ★

1.83" (46.5mm) long plunger. Two stud terminals, 5/16" -24 thread with hexnuts and lockwashers. Mounting: two 9/32" (7.2mm) diameter holes, 1 3/4" (44.5mm) on centers.

**Replaces:** Autolite SW-40001 (15-47), 15-50, 4001A, 4002, 4005, 4010, 4015 (15-51), Delco D900 (405C).



#### 9183 short plunger ★

Same as 9060, but with 1" (25.4) long plunger.

**Replaces:** Autolite SW-4012 (15-49), Delco 1996478.

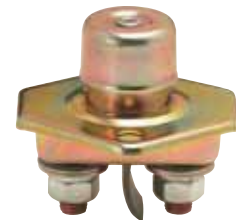

#### 91001 angled mount

.66" (16.8mm) long plunger. One stud terminal, 3/8" -16 thread with 8-32 stud for attaching external ground. Mounting: two 7/32 x 9/32" (5.6 x 7.1mm) holes, 1.40" (35.4mm) on centers.

**Replaces:** Autolite 15-201, Delco 1930496 (D906).



★ Rapid ship item. BP Available in retail clamshell pack. ★ Minimum order quantity may apply.

**C5 ACCESSORIES**

## Protective Boots

*Mounting nut containing a durable rubber with a self-closing key slot.*

**83285-01 aluminum** ★  
3/4" -20 thread, 7/16" (11.1mm) thickness.



**83288 chrome-plated brass** **BP** ★  
13/16" -24 thread, 17/32" (13.5mm) thickness.



## Plastic Cap

**97298** ★  
Captive black protective cap, used with facenut 83295-A



## Facenuts

| Part No. | Thread    | Hole to Clear | Type                   | Thickness |
|----------|-----------|---------------|------------------------|-----------|
| 83296    | 1"-24     | 21/32"        | Aluminum Round Knurl   | 13/32"    |
| 83346*   | 7/8"-24   | 5/8"          | Aluminum Round Knurl   | 3/8"      |
| 83348    | 3/4"-24   | 5/8"          | Aluminum Round Knurl   | 3/8"      |
| 8367     | 3/4"-20   | 5/8"          | Aluminum Round Knurl   | 19/64"    |
| 83337    | 13/16"-24 | 5/8"          | Brass-Chrome Plate-Hex | 15/64"    |
| 83295-A  | 13/16"-24 | 5/8"          | Brass-Chrome Plate-Hex | 15/32"    |
| 8391-A   | 5/8"-32   | 1/2"          | Brass-Zinc Plate-Hex   | 1/4"      |
| 83321-A* | 1"-32     | 15/16"        | Zinc Die Cast Round    | 5/16"     |
| 8391-C   | 5/8"-32   | 3/4"          | Brass-Chrome Plate     | 1/4"      |



More facenuts – Section S2.

## Color-coded Key Covers

*Covers slip over Cole Hersee tumbler lock keys 83406, 83373 and 83379, and make key identification easy.*

- 98635-01 Black**
- 98635-03 Red**
- 98635-04 Yellow**
- 98635-05 Blue**
- 98635-06 Green**



## Keys for Cole Hersee Ignition Switches

### Hencol keys

*Patented Hencol lock and key system gives trouble-free performance. Heavy gauge steel, plated to resist corrosion.*

#### 83357 short

Used on all 956 Series ignition switches with Hencol locks and these Ignition switches:

|         |         |          |          |
|---------|---------|----------|----------|
| 95030-A | 95522-A | 95527-A  | 95616-01 |
| 95512-A | 95523-A | 95528-A  | 95617    |
| 95514-A | 95524-A | 95561-01 | 95663-01 |
| 95515-A | 95525-A | 95564-01 | 95663-04 |
| 95516-A | 95526-A | 95616    | 956-9100 |
| 95517-A |         |          |          |



#### 83353 long

In tables in Section C2, this key is denoted 'Hencol L'. Long key is on these switches:

|         |         |
|---------|---------|
| 95511-B | 95521-B |
| 95520-B | 95597   |



## Tumbler lock key blanks

### 83406

For these Ignition Switches:

|          |       |      |
|----------|-------|------|
| 956-4119 | 9577  | 9518 |
| 956-4125 | M-702 |      |



### 83373

For these Ignition Switches:

|          |          |          |          |
|----------|----------|----------|----------|
| 956-3122 | 956-4116 | 956-4704 | 956-6104 |
| 956-3125 | 956-4154 | 956-5108 | 956-6304 |
| 956-3131 | 956-4304 | 956-5122 | 956-7104 |
| 956-3134 | 956-4305 | 956-5144 | 956-7304 |
| 956-4100 | 956-4311 | 956-5304 | 95582    |
| 956-4104 | 956-4354 | 956-5344 | 95583    |
| 956-4148 |          |          |          |



### 83379

For these Ignition Switches:

|          |          |          |         |
|----------|----------|----------|---------|
| 9513     | 95535    | M-550-04 | M-701   |
| 9578     | 95537    | M-550-14 | M-703   |
| 9579     | 95539    | M-550-25 | M-711   |
| 9622-01  | 95593    | M-712    | M-932   |
| 75705-01 | 95608    | M-712-09 | M-95502 |
| 95532    | 90005-03 | M-712-10 | M-95602 |
| 95534    | 95614    | M-700    | M-924   |
| 9579-02  | M-489    | M-550    |         |



★ Rapid ship item. **BP** Available in retail clamshell pack. ★ Minimum order quantity may apply.

# C ignition switches

## C6 INFORMATION ON IGNITION SWITCHES

### Actuators



Coded tumbler lock.



Hencol L. Long handle keys 83353.



Hencol S. Short handle keys 83353.



Lever L. Long handle lever knob 80101-B.



Lever S. Short handle lever knob 81254.



Military lever.

### Contacts

Silver contacts are highly-conductive and give a long life to the switch, by minimizing arcing. They are available on many of our switches.

### Grounding

Switches are offered with a grounded case design or with a separate ground terminal. A grounded case switch must be installed in a metal panel which is part of the vehicle ground system. For installation in non-grounded panels, select a switch with ground terminal.

Battery ignition switches with a ground circuit permit the operator to check panel indicator lights when the switch is turned to the start position.

### Replacement Switches

We have Delco replacement switches, as well as other items that are not listed. Check with Cole Hersee.

### Special Requirements

We design and manufacture switches for OEMs of all kinds of equipment. Our engineers can work with your staff to evolve the best design. We can work from the ground up to solve a switching problem...or we might be able to save you money by adapting an existing switch. Contact us.

### Other applications for Ignition Switches

Our switches are designed to meet the rigors of use in land and marine vehicles, but they can also be used in any low voltage DC application.

### Delphi (Packard) Connectors

All 956 Series Ignition Switches with blade terminals mate with Delphi (Packard) connector 2962912.

95663-01 accepts Delphi (Packard) 2973422.

95663-04 accepts Delphi (Packard) 2973422.

95561-01 accepts Delphi (Packard) 2973386.

95564-01 accepts Delphi (Packard) 2965454.

### Weather-Resistant Options

For inclement conditions, we can add an O-ring seal in the bushing and a gasket seal to protect the terminal insulator, or we can plastic coat the switch by special order. You can also use Rubber Boot/Mounting Nuts and Plastic Caps (see 'Accessories' in this section). Marine construction switches generally have brass cases and added protection against the wave and weather. You can also find different types of starter switches in Section A Rocker Switches, Section B Toggle Switches, Section G Push Button Momentary Switches and Section F Push-Pull Switches.

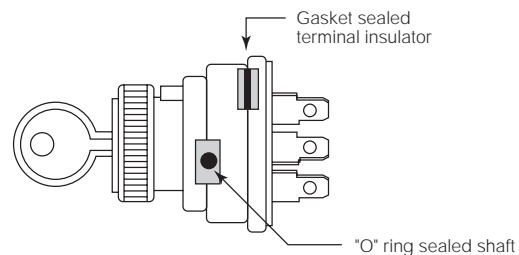

### Circuitry

We have many options in 2- 3- and 4-Positions, for Battery Ignition and Magneto Switches. Anti-Restart switches prevent an engine from being accidentally re-energized when running, and protects the circuitry from an inadvertent overload.

### Terminals

Screw terminals have lockwashers to ensure continued connection of wires. Blade terminals are made of brass, 1/4" (6.4mm) wide. Any switch can be fitted with wire leads by special order.



### custom keys

We made this elegant key to grace the keyrings of Cobalt boat owners. The keys will start their beautiful boats using reliable Cole Hersee ignition switches. But we also make different styles of custom keys for workhorse vehicles.

Whether you want a glossy or embossed logo key, we can do that. Ask us!

# toggle switches



B

|  |     |
|--|-----|
| WEATHER-RESISTANT SWITCHES                         | B1  |
| 1" PADDLE HANDLE SWITCHES 25A                      | B2  |
| FREIGHTLINER REPLACEMENT SWITCHES 25A              | B3  |
| LIGHTED TIP SWITCHES 25A                           | B4  |
| HEAVY DUTY SWITCHES 25A                            | B5  |
| MEDIUM DUTY OFF-ON SWITCHES 10A                    | B6  |
| HEAVY DUTY & EXTRA HEAVY DUTY SWITCHES 20A AND 30A | B7  |
| SPECIALIZED APPLICATION SWITCHES                   | B8  |
| ACCESSORIES  | B9  |
| INFORMATION  | B10 |

## toggle switches

### B1 WEATHER-RESISTANT SWITCHES

#### 54100 Series, Weather-Resistant, 25A

Standard or lighted handle – black nylon or clear plastic, 11/16" (17.5mm) long. Silver contacts. Mounting stem 15/32" -32 thread, 15/32" (11.9mm) long, fits panels up to 1/8" (31.8mm) thick. Includes mounting hardware: black metal facenut and nickel-plated hexnut. 25A at 12V DC. Terminals: .250" blade or 6-32 screw.



Standard Switch



Illuminated Switch

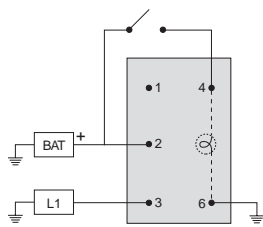

54109 & 54109-01 independent wiring

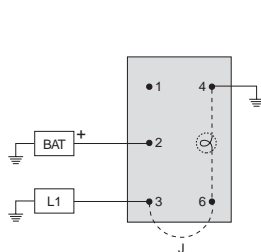

54109 & 54109-01 dependent wiring

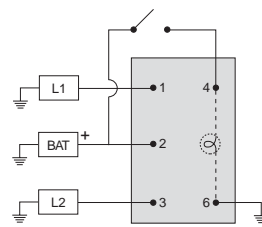

54110 & 54110-01 independent wiring

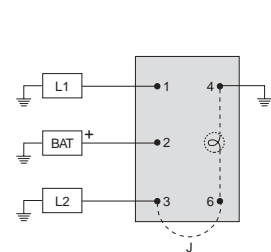

54110 & 54110-01 dependent wiring

#### SPST

##### 54100 On-Off BP ★

Up: On, Down: Off. Two screw terminals.

##### 54100-01 On-Off BP

Up: On, Down: Off. Two blade terminals.

##### 54101 Mom On-Off

Up: Mom On, Down: Off. Two screw terminals.

##### 54101-01 Mom On-Off BP

Up: Mom On, Down: Off. Two blade terminals.

CONTINUED **B1**





# B toggle switches

## B1 WEATHER-RESISTANT SWITCHES



### sealed

Neoprene O-ring seal within the mounting stem protects against moisture and dirt entering around the base of the actuator handle. Some switches are coated in polyvinyl chloride (PVC), providing additional sealing. PVC-coated switches normally have wire leads, which provide complete covering and insulation of the terminals.

### 54109 On-Off, illuminated BP ★

Up: On/Red, Down: Off/White. Four screw terminals.  
O-ring seal in bushing.

### 54109-01 On-Off, illuminated ★

Up: On/Red, Down: Off/White. Four blade terminals.  
O-ring seal in bushing.

## SPDT

### 54103 On-Off-On BP

Up: On, Center: Off, Down: On. Three screw terminals.

### 54103-01 On-Off-On BP

Up: On, Center: Off, Down: On. Three blade terminals.

### 54104 Mom On-Off-Mom On BP

Up: Mom On, Center: Off, Down: Mom On.  
Three screw terminals.

### 54104-01 Mom On-Off-Mom On

Up: Mom On, Center: Off, Down: Mom On.  
Three blade terminals.

### 54110 On-Off-On, illuminated BP

Up: On/red, Center: Off/White, Down: On/White.  
Five screw terminals. O-ring seal in bushing.  
Independent illumination.

### 54110-01 On-Off-On, illuminated BP

Up: On/red, Center: Off/White, Down: On/White.  
Five blade terminals. O-ring seal in bushing.  
Independent illumination.

## DPST

### 54105 On-Off

Up: On, Down: Off. Four screw terminals.

### 54105-01 On-Off

Up: On, Down: Off. Four blade terminals.

## DPDT

### 54107 On-Off-On

Up: On, Center: Off, Down: On. Six screw terminals.

### 54107-01 On-Off-On BP ★

Up: On, Center: Off, Down: On. Six blade terminals.

## dependent or independent?

### Dependent Illumination

When the switch is On, the handle is illuminated.

### Independent Illumination

Actuation of the switch does not affect the illumination of the handle. The switch can be On or Off, and illumination is usually controlled by another switch. This mode can be used to light a whole bank of switches, and is especially useful for locating switches in the dark.

A switch with independent illumination can be converted to a dependent switch by adding a jumper wire as shown on the previous page.

## 59024-000 Series 1" Paddle Handle Switches 25A

Silver contacts, 15/32" -32 thread mounting stem. Fits panels up to 1/4" (6.4mm) thick. Includes mounting hardware: black knurled facenut, hexnut. Keyway is in the down position. 1" (25.4mm) handle, black plastic, matte finish. 25A at 12V DC. Terminals: Brass 8-32 screw or .250 quick connect blade.



### SPST

#### 59024-100 On-Off

Up: On, Down: Off. Two blade terminals.

#### 59024-101 On-Off

Up: On, Down: Off. O-ring seal in the stem. Two blade terminals.

#### 59024-102 Mom On-Off

Up: Mom On, Down: Off. Two blade terminals.

#### 59024-144 Mom On-Off

Up: Off, Down: Mom On. Two blade terminals.

#### 59024-200 On-Off BP

Up: On, Down: Off. Two screw terminals.

#### 59024-201 On-Off

Up: On, Down: Off. O-ring seal in the stem. Two screw terminals.

#### 59024-202 Mom On-Off

Up: Mom On, Down: Off. Two screw terminals.

#### 59024-244 Mom On-Off

Up: Off, Down: Mom On. Two screw terminals.

### SPDT

#### 59024-104 On-On

Up: On, Down: On. Three blade terminals.

#### 59024-106 On-Off-On

Up: On, Center: Off, Down: On. Three blade terminals.

#### 59024-108 Mom On-Off-Mom On

Up: Mom On, Center: Off, Down: Mom On. Three blade terminals.

#### 59024-204 On-On

Up: On, Down: On. Three screw terminals.

#### 59024-206 On-Off-On

Up: On, Center: Off, Down: On. Three screw terminals.

#### 59024-208 Mom On-Off-Mom On

Up: Mom On, Center: Off, Down: Mom On. Three screw terminals.

### DPST

#### 59024-110 Mom On-Off

Up: Off, Down: Mom Off. Four blade terminals.

#### 59024-210 On-Off

Up: On, Down: Off. Four screw terminals.

### DPDT

#### 59024-116 On-On

Up: On, Down: On. Six blade terminals.

#### 59024-118 On-Off-On

Up: On, Center: Off, Down: On. Six blade terminals.

#### 59024-126 Reversing switch for electrical motors

Reversing (polarity) switch for changing direction of permanent magnet electrical motors. Up: Mom On, Center: Off, Down, Mom On. Four blade terminals.

#### 59024-150 Off-On-On, headlight switch

Up: On terminals 2, 3 & 6, Center: 2 & 3, Down, Off. Three blade terminals. For headlight, parking or tail light applications.

#### 59024-216 On-On

Up: On, Down: On. Six screw terminals.

#### 59024-218 On-Off-On

Up: On, Center: Off, Down: On. Six screw terminals.

REPLACEMENT **B3**

★ Rapid ship item. BP Available in retail clamshell pack. ★ Minimum order quantity may apply.



# B toggle switches

## B3 FREIGHTLINER REPLACEMENT SWITCHES 25A

### 59024-00 Freightliner Replacement Switches 25A

Terminals are arranged to match OEM wiring connectors. With or without brackets. Silver contacts. Black phenolic switch housing with metal cap. 15/32" -32 thread mounting stem. Fits panels to .093" (2.4mm) with spacer provided, or to .25" (6.4mm) without spacer. Includes mounting hardware: black metal facenut. Keyway is in the down position. Black plastic 1" (25.4mm) handle, matte finish. Tin-plated blade terminals. 25A at 12V DC.

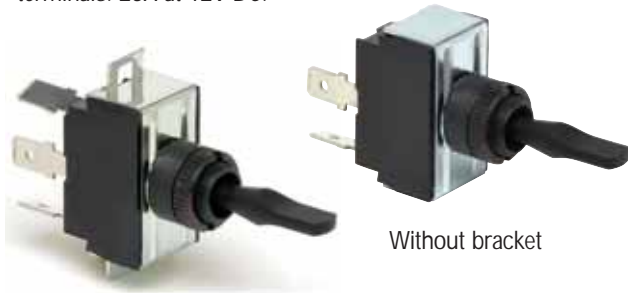

With bracket

Without bracket

### With bracket

#### 59024-33 SPST On-Off ★

Up: On, Center: Off. Two blade terminals. Dual contacts for extra durability.

#### 59024-34 SPDT On-Off-On

Up: On, Center: Off, Down: On. Three blade terminals. Dual contacts for extra durability.

#### 59024-35 DPST On-Off

Up: On, Center: Off. Four blade terminals.

#### 59024-36 DPDT On-Off-On

Up: On, Center: Off, Down: On. Six blade terminals.

#### 59024-37 DPST On-Mom Off

Center: On, Down: Mom Off. Four blade terminals.

#### 59024-38 DPDT Mom On-On-Mom On

Up: Mom On, center: On, Down: On. Six blade terminals.

### Without bracket

#### 59024-12 SPST On-Off ★

Up: On, Down: Off. Two blade terminals. Dual contacts for extra durability.

#### 59024-13 SPDT On-Off-On

Up: On, Center: Off, Down: On. Three blade terminals. Dual contacts for extra durability.

#### 59024-14 DPST On-Off

Up: On, Center: Off. Four blade terminals.

#### 59024-15 DPDT On-Off-On ★

Up: On, Center: Off, Down: On. Six blade terminals.

#### 59024-16 DPST On-Mom Off

Center: On, Down: Mom Off. Four blade terminals.

# toggle switches

## B4 LIGHTED TIP SWITCHES 25A

### M-54111 Lighted Tip Switches 25A

Tip of handle is illuminated Red in the On position, illuminated Clear in the Off position. Silver contacts. 15/32" -32 thread mounting stem. Nickel-plated brass hexnut. Black plastic handle, housing and facenut. Keyway in the down position. Blade terminals. Independent illumination. 25A at 12V DC. Plastic facenut can be replaced with black metal facenut 83252 (Section B9).

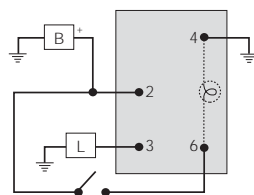

M-54111-01, SPST

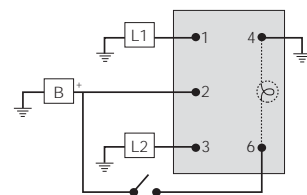

M-54111-02, SPDT

#### M-54111-01 SPST On-Off BP ★

Up: On, Down: Off. Four blade terminals.

#### M-54111-02 SPDT On-Off-On BP

Up: On, Center: Off, Down: On. Five blade terminals.

★ Rapid ship item. BP Available in retail clamshell pack. ✪ Minimum order quantity may apply.

**B5 HEAVY DUTY SWITCHES 25A**

Standard or long handle. Universal application. Silver contacts. Mounting stem is nickel-plated brass 15/32" -32 thread, 15/32" (11.9mm) long, and fits panels up to 9/32" (7.1mm) except where stated otherwise. phenolic housing, with plated steel cap. Nickel-plated brass mounting hardware. Blade terminals: .250 quick connect. Screw terminals: 6-32 screws. 25A at 12V DC, 15A at 24V DC.



Standard handle,  
11/16" (17.5mm) long.



Long handle,  
1 1/2" (38.1mm) long.



PVC coated housing  
with wire leads.

## SPST

**5520 On-Off** BP ★  
Up: On, Down: Off. Two screw terminals. O-ring seal.

**5582 On-Off** BP ★  
Up: On, Down: Off. Two screw terminals.

**5582-10 On-Off, PVC coated** ★  
Up: On, Down: Off. Two 8" (203.2mm) leads. O-ring seal. Mounting stem is 11/32" (8.7mm) long, and fits panels up to 3/16" (4.8mm) thick.

**55014 On-Off** BP ★  
Up: On, Down: Off. Two blade terminals.

**55014-05 On-Off**  
Up: On, Down: Off. Two blade terminals. O-ring seal in the stem.

**55023 On-Off**  
Up: On, Down: Off. Two screw terminals with 2 blades attached.

**55055 On-Off, long handle** BP  
Up: On, Down: Off. Two blade terminals.

**55055-01 On-Off, long handle**  
Up: On, Down: Off. Two screw terminals.

## SPST Momentary

**55020 Off-Mom On** BP ★  
Up: Off, Center: Mom On. Two screw terminals.

**55020-02 Off-Mom On**  
Up: Off, Down: Mom On. Two screw terminals. O-ring seal.

**55020-04 Off-Mom On, PVC coated** ★



Moisture- and dirt-resistant. PVC coated and sealed with an O-ring seal in the stem. Up: Off, Down: Mom On. Two 8" (203.2mm) leads.

**55037 Off-Mom On**  
Up: Off, Center: Mom On. Two blade terminals.

**55049-01 On-Mom Off**  
Up: On, Down: Mom Off. Two blade terminals.

**55052-01 On-Mom Off, long handle**  
Up: On, Center: Mom Off. Two blade terminals.

**SPST, DPDT?**

---

See Section B10.

**CONTINUED B5**

★ Rapid ship item. BP Available in retail clamshell pack. ★ Minimum order quantity may apply.

## SPDT

### 5584 On-On ★

Up: On, Down: On. Three screw terminals.

### 5586 On-Off-On BP ★

Up: On, Center: Off, Down: On. Three screw terminals.

### 55015 On-On

Up: On, Down: On. Three blade terminals.

### 55016 On-Off-On

Up: On, Center: Off, Down: On. Three blade terminals.

### 55016-06 On-Off-On

Up: On, Center: Off, Down: On. O-ring seal in the stem. Three blade terminals.

### 55036 On-Off-On, PVC coated BP ★

Up: On, Center: Off, Down: On. PVC coated housing, with three 9.5" (241.3mm) leads. Leads have tinned brass terminals. O-ring seal in the stem.

## SPDT Momentary

### 55021 Mom On-Off-Mom On BP ★

Up: Mom On, Center: Off, Down: Mom On. Three screw terminals.

### 55021-04 Mom On-Off-Mom On

Up: Mom On, Center: Off, Down: Mom On. O-ring seal in the stem. Three screw terminals.

### 55021-07 Mom On-Off-Mom On, PVC coated BP ★

Up: Mom On, Center: Off, Down: Mom On. PVC coated housing with three 8" (203.2mm) leads. O-ring seal in the stem. Mounting stem is 11/32" (8.7mm) long, and fits panels up to 3/16" (4.8mm) thick.

### 55021-08 Mom On-Off-Mom On, long handle

Up: Mom On, Center: Off, Down: Mom On. Three screw terminals.

### 55033-01 Mom On-Off-Mom On ★

Up: Mom On, Center: Off, Down: Mom On. Three blade terminals.

### 55033-02 Mom On-Off-Mom On, long handle

Up: Mom On, Center: Off, Down: Mom On. Three blade terminals.

### 55088 On-Off-Mom On ★

Up: On, Center: Off, Down: Mom On. Three screw terminals.

## DPST

### 5588 On-Off BP ★

Up: On, Down: Off. Four screw terminals.

### 55017 On-Off BP ★

Up: On, Down: Off. Four blade terminals.

### 55017-02 On-Off

Up: On, Down: Off. O-ring seal in the stem. Four blade terminals.

## DPDT

### 5590 On-On ★

Up: On, Down: On. Six screw terminals.

### 5592 On-Off-On BP ★

Up: On, Center: Off, Down: Off. Six screw terminals.

### 55018 On-On BP ★

Up: On, Down: On. Six blade terminals.

### 55019 On-Off-On BP ★

Up: On, Center: Off, Down: Off. Six blade terminals.

### 55057 On-Off-On, long handle ★

Up: On, Center: Off, Down: Off. Six blade terminals.

## DPDT momentary

### 55054 Mom On-Off-Mom On BP ★

Up: Mom On, Center: Off, Down: Mom On. Six screw terminals.

### 55054-04 Mom On-Off-Mom On, long handle

Up: Mom On, Center: Off, Down: Mom On. Six screw terminals.

### 55065-02 Mom On-Off-Mom On, long handle ★

Up: Mom On, Center: Off, Down: Mom On. Six blade terminals.

**55065-03 Mom On-Off-Mom On** BP ★

Up: Mom On, Center: Off, Down: Mom On. Six blade terminals.

**55081 On-Off-Mom On**

Up: On, Center: Off, Down: Mom On. Six blade terminals.

**55094 Mom On-On-Off, ignition-start**

Up: Mom On terminals 2&3, 5&6, Center: On terminals 2&3, Down: Off. Four screw terminals. For starting and running coil type ignition engines.

**DPDT Reversing Polarity**

*Forward/reverse switches for use with permanent magnet motors.*

**5590-06\* On-On**

Up: On terminals 1&5, 2&4, Down: On terminals 1&2, 4&5. Four screw terminals. O-ring seal.

**55018-01 On-On**

Up: On, Down: On. Four blade terminals.

**55046 Mom On-Off-Mom On** ★

Up: Mom On, Center: Off, Down: Mom On. Four blade terminals.

**55046-06 Mom On-Off-Mom On, long handle**

Up: Mom On terminals 1&5, 2&4, Center: Off, Down: Mom On terminals 1&2, 4&5. Four blade terminals. O-ring seal.



## reversing polarity switches

For changing the direction of permanent magnet motors.

**Toggle Switches (Section B)**

- 55018-01 On-On
- 55046 Mom On - Off - Mom On
- 55046-04 Mom On - Off - Mom On
- 55046-06 Mom On - Off - Mom On
- 55046-11 Mom On - Off - Mom On
- 5590-06 On - On

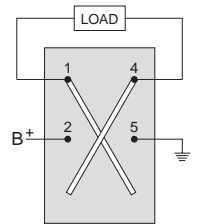

**Rotary Switches (Section D)**

- 90005-03 Mom On - Off - Mom On
- 90005-01 Mom On - Off - Mom On. Keyed

**Rocker Switches (Section A)**

- 57014-03 Mom On - Off - Mom On
- 58027-18 Mom On - Off - Mom On



## custom switches

If it's not in the catalog, we can probably make it for you.

One of our customers had a need for a switch that could be fixed to the exterior of a garbage truck. Their current switches had to be replaced several times a year, due to failures caused by harsh environmental conditions. They also wanted a switch that could be surface mounted, for easy access, and yet tough enough to withstand side impact and the worst possible weather.

The solution: a bushing-sealed switch, potted entirely in high-strength epoxy resin to seal out all entry points for moisture and dirt, and contained within an impact-resistant flanged casing for easy mounting. Sealed to IP-67, 25A at 12V, 15A at 24V.

Such a switch is ideal for tough applications like cement mixers, construction vehicles, outdoor equipment and lift platforms.

Special switches? Consult Cole Hersee.

# B toggle switches

## B6 MEDIUM DUTY SPST OFF-ON SWITCHES

Down: Off, Up: On. Standard or ball handle. In chrome plated brass or nickel-plated brass handle, facenut and mounting stem. Silver contacts. Mounting stem has 15/32" -32 thread, 15/32" (11.9mm) long, and fits panels up to 9/32" (7.2mm) thick. Screw or blade terminals, or wire leads. Phenolic housing with plated steel frame. Keyway is in the down position. 10A at 12V DC.



Ball handle: 3/8" (9.52mm) long.

Standard handle: 11/16" (17.46mm) long.

### Nickel-plated brass handle

5507 ball handle, two screw terminals

5558 standard handle, two screw terminals **BP** ★

5568 ball handle, two 6" leads

5570 standard handle, two 6" leads

55012 ball handle, two blade terminals

55013 standard handle, two blade terminals

### Chrome-plated brass handle

M-484 standard handle, two screw terminals **BP** ★  
Also available by special order as a panel assembly.  
(M-515-01, M-516-01, M-517.)

M-493 ball handle, two screw terminals **BP**

M-584 standard handle, two 6" leads **BP** ★

M-586 standard handle, two blade terminals

# toggle switches

## B7 HEAVY DUTY & EXTRA HEAVY DUTY SWITCHES 20A AND 30A

### 551800 Series Heavy Duty & Extra Heavy Duty Switches 20A and 30A

Universal application. Diecast housing. For stem- or bracket-mounting. 15/32" -32 thread mounting stem, with keyway.

Brackets: .170" (4.3mm) diameter holes, 1.72" (43.7mm) on centers. Fits panels up to 3/16" (4.8mm) thick. Chrome plated brass handle, 1 1/16" long (27.0mm). Steel screw or blade terminals. Plated steel hexnut.



### Heavy Duty 20A at 6-12V DC.

551000\* SPST On-Off  
Up: On, Center: Off. Two blade terminals.

551001 SPST Mom On-Off  
Up: Mom On, Center: Off. Two blade terminals.

551014\* SPST On-Off Grounding Switch  
Up: On, Center: Off. One blade terminal.  
On: contacts closed, terminal grounded to the housing.

551015\* SPST Mom On-Off Grounding Switch  
Up: Mom On, Center: Off. One blade terminal.  
On: contacts closed, terminal grounded to the housing.

★ Rapid ship item. **BP** Available in retail clamshell pack. ★ Minimum order quantity may apply.



Cole Hersee Co. 20 Old Colony Ave, Boston, MA 02127-2467

24

T 617.268.2100 F 617.268.9490 www.colehersee.com

**551800 SPST On-Off** BP ★

Up: On, Center: Off. Two screw terminals.

**551801 SPST Mom On-Off**

Up: Mom On, Center: Off. Two screw terminals.

**551802 SPDT On-Off-On**

Up: On, Center: Off, Down: On. Three screw terminals.

**551805 SPDT On-Off**

Up: On, Center: Off. Four screw terminals.

**551806 DPDT On-Off-On**

Up: On, Center: Off, Down On. Six screw terminals.

**M-594 SPST On-Off** BP

Up: On, Center: Off. Two screw terminals.  
Golden dichromate dip housing, brass terminals.

**M-595 SPDT On-Off-On**

Up: On, Center: Off, Down: On. Three screw terminals.  
Golden dichromate dip housing, brass terminals.

## Extra Heavy Duty

*30A at 6-12V DC, 15A at 24-36V DC. Silver-plated contacts.*

**551840 SPST On-Off** BP ★

Up: On, Center: Off. Two screw terminals.

**551841 SPST Mom On-Off**

Up: Mom On, Center: Off. Two screw terminals.  
This universal switch can also be used to control day signaling lamps.

**551842 SPDT On-Off-On** BP ★

Up: On, Center: Off, Down: On. Three screw terminals.

**551843 SPDT On-Off-Mom On**

Up: On, Center: Off, Down: Mom On. Three screw terminals.

**551844 SPDT Mom On-Off-Mom On** ★

Up: Mom On, Center: Off, Down: Mom On.  
Three screw terminals.

**551845 DPST On-Off**

Up: B-2, Center: Off. Four screw terminals.

**551846 DPDT On-Off-On** ★

Up: On, Center: Off, Down: On. Six screw terminals.

## 12V, 24V, 36V rating

Generally, Cole Hersee heavy duty 12V non-illuminated\* toggle and rocker switches can be used at higher voltage but lower current.

Example: By calculation, 25A 12V switch will derate to 8.3A at 36V, or 12.5A at 24V.

This calculated de-rating gives a conservative result. 25A at 12V toggle switches\* can actually be used at 15A at 24V, and 10A at 36V.

*\*Exception: This does not apply to illuminated switches. The pilot light must only be supplied with the stated voltage. Do not derate any illuminated switches.*

**551849 SP3C On-On-Off**

Up: B-T-H, Center: B-P-T, Down: Off. Four screw terminals.  
This universal switch can also be used to control headlamps and Park & Tail lamps.

**551850 SPDT On-On**

Up: On, Center: On. Three screw terminals.

**551851 SPST On-Mom Off**

Up: Mom Off, Center: On. Two screw terminals.  
This universal switch can also be used to control night signaling lamps.

**551852 SP2C On-On-Off**

Up: B-H, Center: B-L, Down: Off. Three screw terminals.  
This universal switch can also be used to control heaters/defrosters. Supplied without resistors.

**551855 SP1C Mom Off-On-Off**

Up: Mom Off, Center: On, Down: Mom Off.  
Two screw terminals. This universal switch can also be used to control signaling and marker lamps.

**551861\* SP2C On-Off**

Up: On B-1&2, Center: Off. Three screw terminals.

**551862 DP2C Mom On-Run-Off**

Up: Mom S-S, Center: Open, Down: Off M-M. Four screw terminals. This universal switch is primarily used to control magneto ignition. For battery ignition see 59071 and 55094.

SPECIALIZED **B8**

★ Rapid ship item. BP Available in retail clamshell pack. ★ Minimum order quantity may apply.





# B toggle switches

## B8 SPECIALIZED APPLICATION SWITCHES

Silver contacts. 15/32" -32 thread mounting stem, .46" (11.9mm) long, mounts in panels up to 9/32" (7.1mm) thick. Nickel-plated brass handle: standard .687" (17.5mm) or long 1.5" (38.1mm). Brass blade terminals. Black phenolic housing with metal frame. Nickel-plated brass hardware. Keyway is in the down position. 25A at 12V DC, except as noted.

### 55058-01 4-pole, 4-circuit headlamp switch

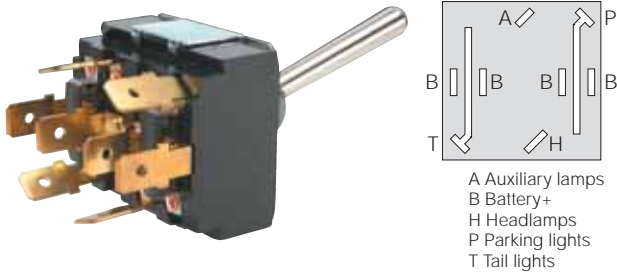

Allows splitting of a heavy load into four separate circuits. Eight blade terminals. Long handle. Up: Park, Tail & Headlamps - Center: Off - Down: Park, Tail & Auxiliary Lamps.

### 55064 DPDT 4-circuit headlamp switch



Up: Park, Tail & Headlamps - Center: Off - Down: Park, Tail & Auxiliary Lamps. Six blade terminals. Long handle.

### 55071 DP 2-circuit marker lamp switch

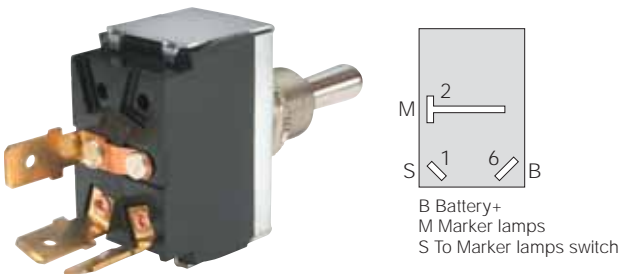

Up: Mom On B, 1&2 (day signaling) - Center: On 1&2 - Down: Mom Off (night signaling). Three blade terminals. Standard handle.

### 55093 DPDT two-speed heater fan switch ★



Double pole, two-circuit. Three blade terminals. Up: Battery & High - Center: Battery & Low - Down: Off. Standard handle. Terminal connections: 3 low speed, 5 Battery +, 6 high speed.

### 55015-03\* 3-way lighting switch

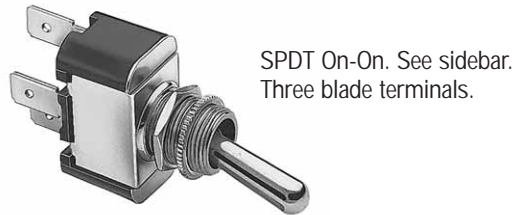

## 3- and 4-way lighting

3-way lighting permits a light (or set of lights) to be controlled from two switches usually mounted in different locations. Similarly, 4-way lighting enables control from three switch locations.

#### 3-WAY LIGHTING

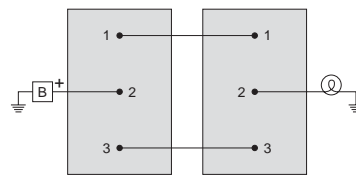

Use two SPDT On-On switches such as 55015-03 or 55015

#### 4-WAY LIGHTING

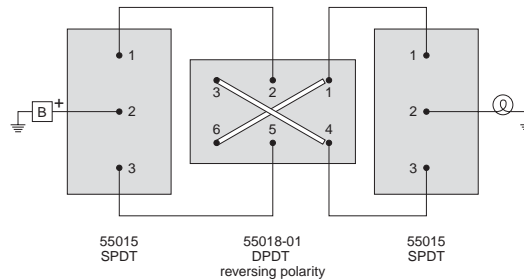

★ Rapid ship item. BP Available in retail clamshell pack. \*Minimum order quantity may apply.

## DP Ignition/Start & Headlight Switches 25A at 12V DC.

### 59071 Off-On-Mom On

Down: Off, Center: On 4&5,  
Up: Mom On 1, 4&5.  
White plastic handle.  
Three blade terminals.



### 55094\* Mom On-On-Off

Up: Mom On 2&3, 5&6, Center: On 2&3, Down: Off.  
Standard handle. Four screw terminals.

## Other Specialized Application Switches

*Silver contacts. 15/32" -32 thread mounting stem, .46" (11.9mm) long, mounts in panels up to 9.32" (7.1mm) thick. Brass blade terminals. Black phenolic housing with metal frame. Keyway is in the down position.*

### 5543 SPST Off-On Switch in recessed plate ★

5558 switch mounted in 5543-15 recessed plate to prevent damage or accidental actuation inside a trailer or other location. Plate fits into a 2" dia (50.8mm) panel hole. Depth is 1.75" minimum (44.5mm). Two screw terminals. Also available: 5543-09 recessed plate with 55015-03 SPDT On-On switch (suitable for 3-way lighting applications). Recessed plate is available in different colors, by special order – contact Cole Hersee.



### 55089 SPST Light Duty Grounding Switch

Up: Off, Down: On. Terminal is grounded to switch frame. Mounts with two hexnuts into panels up to .189" (4.8mm) thick. One blade terminal. Standard handle. 5A at 12V DC.

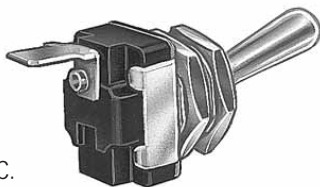

## M-597 Marine Emergency Cutoff <sup>BP</sup>

*Weather-resistant switch provides added safety for boat operators. The lanyard connects the boater to a switch which kills the ignition circuit if the boater falls overboard, or is at an unsafe distance from the controls, thus preventing a dangerous runaway situation. Unlike other devices, the M-597 can be turned on again if need be by a boater other than the operator.*

*Switch can be installed either in boat systems that require a grounded emergency stop, or in systems that have an open circuit emergency stop. The switch works on virtually any powerboat with an inboard or outboard motor. Full wiring instructions are included. For safety, this switch should only be installed by a technically competent person.*

*Switch housing dimensions 2 3/4" x 2" (69.9 x 50.8mm) requires a space of 1/2" (12.7mm) behind the panel, and mounts in a 1 1/2" (38.1mm) diameter hole. Rubber coated toggle switch is sealed to IP-66 to protect against salt spray and water ingress. Strong cloth-covered self-retracting coiled lanyard has a stainless steel clip for attachment to the operator. 10A at 12-24V DC.*



With the lanyard out of the housing.

*For safety or lifesaving applications, the switch should be installed by a qualified individual. User assumes all responsibility for determining the suitability of this product for his application.*

## M-598 Replacement Lanyard <sup>BP</sup>

We recommend that the lanyard be replaced annually or in cases of extreme wear, as necessary.

## Switch Guards

Switch guards help prevent accidental actuation of a toggle switch and protect it from damage.

Typical uses:

*Switch is in a vulnerable position – like a light switch in a truck cargo section.*

*Switch controls a vital function that must not be accidentally operated – like the hose return switch on an oil truck.*

*Switch is important, but infrequently used – like an emergency switch.*

Cole Hersee switch guards give you a choice of protection from the simple flanged faceplate to the recessed faceplate, or the complete protection of the 82468 flip cover. For complete lockout protection of electrical circuits, we recommend rotary Master Disconnect Switches with lockout/tagout protection, such as 2484 with 24505.

### 82465 walled faceplate switch guard



Guard is easily added to an already installed switch, providing lateral mechanical protection. For switches with 15/32" diameter mounting stems with a keyway. Stamped On, Off. 1" x 2.125" (25.4 x 54.0mm). Two .140" (3.6mm) mounting holes 1.87" (47.6mm) on centers.

### 5543-15 recessed faceplate switch guard



Faceplate only: does not include switch. Needs to be counter-sunk in a 2" (50.8mm) hole. 3 3/16" (81.0mm) diameter with three 7/32" (5.6mm) holes on a 2 3/4" (69.9mm) diameter circle. Requires a clearance depth of .890" (22.6mm), not including clearance for a switch. Other colors, metals and finishes are available on special order. Contact Cole Hersee.

### 82468 flip cover switch guard BP ★



With cover up.

With cover closed.

Provides the maximum protection, and can be easily added to an already installed switch by unscrewing and replacing the facenut. Spring-loaded snap action cover returns the switch to the 'safe' position when closed, and secures it there. Rugged red melamine cover is colorfast at temperature extremes and is resistant to most contaminants, like fuel oil. Other colors are available by special order. Recommended for use with standard 11/16" toggle handle Off-On or On-On switches with a keyway in the bushing. Steel faceplate with black glossy finish. Height closed 1.08" (27.4mm); height open 1.71" (43.5mm). 1.80" (45.8mm) long x .67" (17.0mm) wide. Mounting hole diameter .47" (11.9mm). Accepts switches with standard 15/32" diameter mounting stems.

## Handle Extensions

*Rigid plastic extension snaps over standard or ball handled toggle switches, extending a standard handle to 1 7/8" (47.6mm) long. Enables switches to be easily color-coded. Packed 10 of each color per package.*



81271 red

81272 yellow

81273 black

81261\* fluorescent green

81262 fluorescent blue

81263 fluorescent white

★ Rapid ship item. BP Available in retail clamshell pack. ★ Minimum order quantity may apply.

## Faceplates

Fit all toggle switches with standard 15/32" diameter mounting stem and keyway.

8250 nickel-plated ★



Nickel-plated steel. 1" x 5/8" (25.40 x 15.87mm). Stamped On, Off.

M-518\* chrome-plated

Same as 8250, except chrome-plated brass.

M-506\* 4-gang faceplate

Nickel-plated brass, stamped On, Off. Accepts four 10-32 mounting screws. 2.187" x 3.380" (55.5 x 85.9mm).



M-505\* 3-gang faceplate

2.187" x 2.562" (55.5 x 65.1mm).

M-507\* 5-gang faceplate

2.187" x 4.187" (55.5 x 106.3mm).

M-508\* 6-gang faceplate

2.187" x 5.000" (55.5 x 127.0mm).

## 83252 Black Facenut

Brass facenut, black finish. For 54100 series switches, to replace plastic facenut.



## Terminal Blade Adapter

55023-10



Attaches to a No. 6 screw terminal, converting to a standard 1/4" wide blade terminal. Brass.

100 pieces per package.

## Toggle Boot Seals

Durable silicone rubber bonded to a standard 15/32" -32 thread nickel plated brass hexnut. When the nut is tightened to the stem of a toggle switch, the rubber forms an O-ring seal with the panel. Full boots completely cover a standard 11/16" (17.5mm) handle. Boot seals protect switches from moisture and dirt; colored boots provide color-coding for ready identification of switches.



81264 gray BP ★

81264-05 red BP

81264-01 black BP

81264-06 brown

81264-02 blue BP

81264-07 yellow

81264-03 clear BP

81264-08 orange

81264-04 green BP

## Half-Boot Seal

81255 BP ★



Allows any length of handle to protrude, yet seals tightly to handle. Suitable for all toggle switches in this catalog excepting squared handle switches as in Section B1.

INFORMATION B10

★ Rapid ship item. BP Available in retail clamshell pack. ★ Minimum order quantity may apply.

# B toggle switches

B10 INFORMATION

## SPST SPDT DPST DPDT

*SP and DP refer to single pole and double pole, ST and DT refer to single throw and double throw.*

*Pole refers to the number of circuits controlled by the switch: SP switches control only one electrical circuit.*

*DP switches control two independent circuits (and act like two identical switches that are mechanically linked).*

*Do not confuse 'pole' with 'terminal'. The DPST switch, for example, has four terminals, but it is a DP, not a 4P switch.*

*Throw refers to the extreme position of the actuator: ST switches close a circuit at only one position.*

*The other position of the handle is Off.*

*DT switches close a circuit in the Up position, as well as the Down position (On-On). A DT switch can also have a center position (frequently On-Off-On).*

*The following switch diagrams illustrate the most common types of toggle and rocker switch.*



SPST On-Off



SPDT On-On

Only one of the loads can be energized at a time.

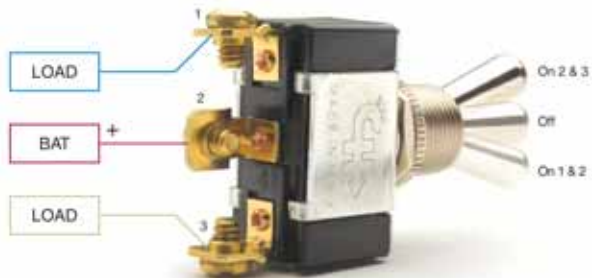

SPDT On-Off-On

Only one of the loads can be energized at a time.



DPST On-Off

Both load terminals can be energized at the same time. They are independent of each other and could be of different voltages.



DPDT On-On

Functions like two separate SPDT switches operated by the same actuator. Only two loads can be On at a time.



DPDT On-Off-On

Functions like two separate SPDT switches operated by the same actuator. Only two loads can be On at a time.

*Single pole/throw and double pole/throw switches are by far the most common switches, but triple and quadruple configurations are also available. They are commonly denoted 3PST, 3PDT, 4PDT, etc. For our switches of this type, see Rotary Switches, section D1.*

# rocker switches



A

|                                |    |
|--------------------------------|----|
| WEATHER-RESISTANT SWITCHES     | A1 |
| STANDARD SERIES, PLASTIC BEZEL | A2 |
| STANDARD SERIES, METAL BEZEL   | A3 |
| NARROW BODY SWITCHES           | A4 |
| BRACKET-MOUNTING SWITCHES      | A5 |
| DUAL SWITCHES                  | A6 |
| ACCESSORIES                    | A7 |
| WIRING DIAGRAMS                | A8 |

## rocker switches

### A1 WEATHER-RESISTANT ROCKER SWITCHES

Switches for universal applications. Contact area sealed against dirt and moisture entry to IP66. Snap-in mounting fits standard hole .830" x 1.45" (21.1 x 36.8mm). Fits panels from .093" to .187" thick (2.4 x 4.7mm). For bezels to hold these switches together side by side, see Section A7. Circuit diagrams: see Section A8.

#### 58328 Series with Pilot Lights, 25A

Single or dual pilot lights, dependent or independent illumination. Faceted lenses are on the actuator. Matte finish black plastic housing, bezel and actuator. Silver contacts, brass blade terminals. 25A at 12V DC.

Each of the five electrical configurations of switch is also available as a BP (bubble pack) retail unit, containing separate lenses of all colors. Lenses snap easily into place.

#### One Pilot Light

##### Off-On SPST, dependent

Three blade terminals.  
Diagram F, Section A8.

58328-04 Red lens ★

58328-11 Green lens ★

58328-12 Clear lens

58328-13 Amber lens ★

58328-100BP Kit **BP** ★

With one lens of each color. BP only.

58328-64 Fog light symbol

Amber lens. Fog light symbol imprinted on the actuator.



#### Off-On SPST, independent

Four blade terminals. Diagram G, Section A8.

58328-01 Red lens

58328-02 Green lens

58328-09 Clear lens

58328-10 Amber lens

58328-101BP Kit **BP**

With one lens of each color. BP only.



## diagrams

See Section A8 for circuit diagrams.

CONTINUED **A1**



**Two Pilot Lights***Lens colors are listed top lens/bottom lens.***On-On SPDT, two dependent**

Four blade terminals. Diagram J, Section A8.

58328-08 Green/Green

58328-14 Amber/Amber

58328-15 Clear/Clear

58328-16 Red/Red

58328-17 Amber/Clear

58328-18 Amber/Green

58328-19 Amber/Red

58328-20 Clear/Green

58328-21 Clear/Red

58328-22 Green/Red

58328-102BP Kit **BP**

With two lenses of each color. BP only.

**Off-On SPST, dependent and independent**

Four blade terminals. Diagram H, Section A8.

58328-05 Red/Clear

58328-39 Green/Green

58328-40 Red/Red

58328-47 Green/Amber

58328-48 Green/Clear

58328-49 Green/Red

58328-50 Red/Amber

58328-51 Red/Green

58328-104BP Kit **BP**

With one lens of each color and size. BP only.

**On-Off SPDT, two dependent**

Four blade terminals. Diagram J, Section A8.

58328-06 Red/Clear

58328-07 Green/Clear

58328-25 Green/Green

58328-26 Red/Red

58328-33 Green/Amber

58328-34 Green/Red

58328-35 Red/Amber

58328-36 Red/Green

58328-103BP Kit **BP**

With one lens of each color and size. BP only.

**build any of  
the 58328 switches**

Five handy kits cover all the electrical types and pilot light combinations. Each kit comes with a set of snap-in pilot light lenses, so it's easy to make up a switch with the lens color you need.

The five kits are individually retail-packed in clamshell BP units.

**58328-100BP On-Off SPST, dependent**

With one each Amber, Clear, Green, and Red lens.

**58328-101BP On-Off SPST, independent**

With one each Amber, Clear, Green, and Red lens.

**58328-102BP On-On SPDT, dependent**

With two each Amber, Clear, Green, and Red lenses.

**58328-103BP Off-On-On, dependent**

With one each large Amber, Clear, Green, Red, and one each small lenses.

**58328-104BP On-Off SPST, one dependent, one independent**

With one each large Amber, Clear, Green, Red, and one each small lenses.

**SPST, DPDT...?**

See Section B10 for an explanation of terms.

★ Rapid ship item. **BP** Available in retail clamshell pack. ★ Minimum order quantity may apply.

**A1** WEATHER-RESISTANT ROCKER SWITCHES

## With and Without Pilot Lights, 25A

Unlit, single or dual dependent pilot lights. Matte black plastic housing, bezel and actuator. Silver contacts. 56 Series has brass screw terminals. 58 Series has brass blade terminals. 25A at 12V DC. Other screw terminal switches in this series are available – contact Cole Hersee.



### With Pilot Light(s)



#### SPST

Diagram F.

**56327-01 Off-On** BP ★

One red pilot light. Three screw terminals.

**58327-01 Off-On** BP ★

One red pilot light. Three blade terminals.

#### SPDT

Diagram J.

**58327-06 On-Off-On** BP ★



Two red pilots. Four blade terminals.

## wiring diagrams

See Section A8.

### Without Pilot Lights

#### SPST

**56027-01 On-Off** BP ★

Two screw terminals. Diagram A.

**58027-01 On-Off** ★

Two blade terminals. Diagram A.

**58027-02 Off-Mom On** BP ★

Two blade terminals. Diagram A.

**58027-05 On-On**

Three blade terminals. Diagram B.



**58027-17 Fog Light Symbol**

On-Off. Two blade terminals.

Diagram A.



#### SPDT

Diagram B.

**58027-03 On-Off-On** BP ★

Three blade terminals.

**58027-04 Mom On-Off-Mom On** BP ★

Three blade terminals.

#### DPST

Diagram C.

**58027-06 Off-On**

Four blade terminals.

#### DPDT

**58022-03 Mom On-On-Off; Ignition/Start**

Four blade terminals. Glossy finish plastic.

**58027-07 On-Off-On** BP ★

Six blade terminals. Diagram E.

**58027-08 On-On**

Six blade terminals. Diagram D.

**58027-11 Mom On-Off-Mom On** BP ★

Six blade terminals. Diagram E.

**56027-11 Mom On-Off-Mom On**

Six screw terminals. Diagram E.

**58027-18 Mom On-Off- Mom On; Forward-Reverse**

Four blade terminals.

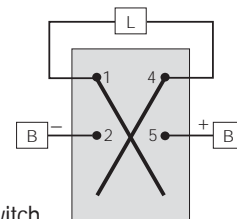

Forward-Reverse switch

CONTINUED **A1**

★ Rapid ship item. BP Available in retail clamshell pack. ★ Minimum order quantity may apply.



**M-58031 Series, 20A**

*Certified to IP66 for protection against dust and prolonged spray. Recognized at UL 1500: Ignition Protection for Marine Products. With neoprene gasket/panel seal. 20A at 12V DC. Blade terminals, silver contacts, black nylon bezel, black plastic housing.*

**M-58031-01 SPST Off-On** BP

Two blade terminals. Diagram Q.

**M-58031-02 SPDT On-Off-On** BP

Three blade terminals. Diagram R.

**M-58031-04 DPST Off-On** BP

Four blade terminals. Diagram T.

**M-58031-05\* DPDT On-Off-On**

Six blade terminals. Diagram P.

**M-58031-06 DPDT On-On**

Six blade terminals. Diagram P.

**M-58031-07 SPST Off- Mom On** BP

Two blade terminals. Diagram Q.

**M-58031-08 SPST Mom On-Off – Mom On**

Three blade terminals. Diagram R.

**M-58031-09\* DPDT Mom On - Off- Mom On**

Six blade terminals. Diagram P.

**locking switch**

SPST On-Off. Bright orange lock automatically locks the actuator when in the Off position, and must be slid to allow the actuator to be moved to the On position. Matte black finish housing, bezel and actuator. Two blade terminals. 20A at 12V DC.

**58326 Series with Pilot Lights, 20A**

*Single or dual pilot lights. Faceted lenses inset into the actuator. Matte black plastic housing, bezel and actuator. Silver contacts, up to eight brass blade terminals, of which terminals 7 & 8 connect the pilot light(s). Internal seal. Many other imprinted switches are available in this series. 20A at 12V DC. All are specified for Thomas Built® school buses except 58326-01.*

**58326-01 SPST Off-On red lens**

Off-On 5&6. Not imprinted. Independent illumination. Consult Cole Hersee for other styles. Diagram L.

**58326-11 Warning lights switch, Off-On-Mom On**

DP Off - On 2&3 - Mom On 2&3 and 5&6. Imprinted 'Amber. Warning (On). Off' with SAE warning lamp symbol imprinted on the white lens. Independent illumination. Diagram M.

**58326-12 Left heater fan switch, On-Off-On**

DPDT On 1&2, 4&5 – Off - On 2&3, 5&6. Imprinted 'High. Left Heater. Low' with SAE fan symbol imprinted on the white lens. Independent illumination. Diagram O.

**58326-21 Windshield washer switch, Off-Mom On**

SPST Off- Mom On 2&3. Imprinted 'On. W/S Washer' with SAE washer symbol imprinted on the white lens. Independent illumination. Diagram N.

**58326-24 Windshield defrost switch, On-On-On**

DPDT On 1&2, 4&5 – On 2&3, 5&4 – On 2&3, 5&6. Imprinted 'Lo/Hi. Def. Off' with SAE defroster symbol imprinted on the white lens. Independent illumination. Diagram O.

**58326-25 Left heater switch, On-On-On**

DPDT On 1&2, 4&5 – On 2&3, 5&4 – On 2&3, 5&6. Imprinted 'Lo/Hi. Left Heater. Off' with SAE fan symbol imprinted on the white lens. Independent illumination. Diagram O.

**58326-27 Passenger heater fan switch, On-On-On**

DPDT On 1&2, 4&5 – On 2&3, 5&4 – On 2&3, 5&6. Imprinted 'Lo/Hi. Pass Heater. Off' with SAE fan symbol imprinted on the white lens. Independent illumination. Diagram O.

**58326-29 Fan switch, On-On-On**

DPDT On 1&2, 4&5 – On 2&3, 5&4 – On 2&3, 5&6. Imprinted 'Lo/Hi. Fan. Off' with SAE fan symbol imprinted on the white lens. Independent illumination. Diagram O.

★ Rapid ship item. BP Available in retail clamshell pack. ★ Minimum order quantity may apply.

**A2 STANDARD SERIES, PLASTIC BEZEL**

25A at 12V DC. Moisture-resistant plastic housings, bezels and actuators. Glossy finish actuators and bezels except where noted. Snap-in mounting to fit panels .060" through .250" (1.5mm to 6.4mm). Silver contacts, brass blade or screw terminals. White actuators except where otherwise indicated. Fits standard panel hole .83" x 1.45" (21.1 x 36.8mm).

## SPST

**56000-08\* On-Off** BP

Two screw terminals.



**57000-23 On-Off**

Two blade terminals.

**56001-04\* Mom On-Off**

Two screw terminals.

**56300-14\* On-Off, with pilot**

Three screw terminals. Red pilot light inside the actuator. Pilot is rated for 12V DC.

**57300-22\* On-Off, with pilot**

Three blade terminals. Red pilot light inside the actuator. Pilot is rated for 12V DC. Diagram F.



**57000-33 On-Off, red actuator**

Typically used for a safety switch. Two blade terminals.

**57001-14 Mom On - Off, red actuator**

Two blade terminals. Marine requirement for horn button.

**57001-15 Mom On-Off**

Two blade terminals.



**58034-07 On-Off, yellow actuator**

State of Florida requirement for school buses. Two blade terminals. Matte Finish.

## SPDT

**56003-03\* On-Off-On** BP

Three screw terminals.



**57003-16 On-Off-On**

Three blade terminals.

**56012-04 Mom On-Off- Mom On**

Three screw terminals.

**57004-10 Mom On-Off- Mom On**

Three blade terminals.

## DPST

**56009-03\* On-Off**

Four screw terminals.

## DPDT

**56006-04\* On-Off-On**

Six screw terminals.

**56013-03\* Mom On-Off-Mom On**

Six screw terminals.

**57005-11 On-On**

Six blade terminals.

**57006-07 On-Off-On**

Six blade terminals.

**57008-08 Off-On-On**

Headlamp switch. Five blade terminals.

**57008-10 Off-On-On**

Navigation, stern & bow light switch. Black actuator. Three blade terminals.

**57013-08 Mom On-Off-Mom On**

Six blade terminals.

**57014-03 Mom On-Off-Mom On**

Four blade terminals. Sealed. Reversing switch.



## reversing polarity switches



For changing the direction of permanent magnet motors.

### Sealed Rocker Switches (Section A)

- 57014-03 Mom On - Off - Mom On
- 58027-18 Mom On - Off - Mom On

### Toggle Switches (Section B)

- 55018-01 On-On
- 55046 Mom On - Off - Mom On
- 55046-04 Mom On - Off - Mom On
- 55046-06 Mom On - Off - Mom On
- 55046-11 Mom On - Off - Mom On
- 5590-06 On - On

### Rotary Switches (Section D)

- 90005-03 Mom On - Off - Mom On
- 90005-01 Mom On - Off - Mom On. Keyed

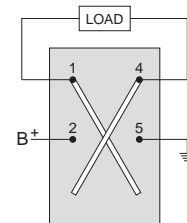

METAL BEZEL **A4**

★ Rapid ship item. BP Available in retail clamshell pack. ★ Minimum order quantity may apply.

## A3 STANDARD SERIES, METAL BEZEL

Single and Double Pole. Universal application. Bright nickel plate or black bezel, narrow or wide. Plastic housing and actuator. Snap-in to fit panels .040" through .100: (1.0 to 2.5mm). Screw or blade terminals. 25A at 12V DC. Circuit diagrams, see Section A8.



Pilot light, bright bezel



Black actuator, black bezel

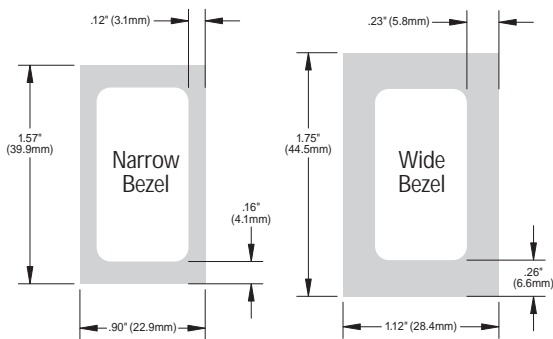

## SPST

## Narrow Bezel

**56000-01 On-Off**

White actuator, bright bezel. Up: On, Down: Off, two screw terminals.

**56000-04 On-Off**

Black actuator, bright bezel. Up: On, Down: Off, two screw terminals.

**56001-01 Mom On -Off**

White actuator, bright bezel. Up: Mom On, Down: Off, two screw terminals.

**57000-01 On-Off**

White actuator, bright bezel. Up: On, Down: Off, two blade terminals.

**57000-04 On-Off**

Black actuator, black bezel, Up: On, Down: Off, two blade terminals.

**57000-10 On-Off, imprinted**

Black actuator, black bezel, Up: On, Down: Off, two blade terminals. imprinted "On, Off"

**57001-01 Mom On -Off**

White actuator, bright bezel. Up: Mom On, Down: Off, two blade terminals.

**57001-04 Mom On -Off**

Black actuator, black bezel, Up: Mom On, Down: Off, two blade terminals.

**57001-09 Mom On - Off, imprinted**

White actuator, black bezel. Up: Mom On, Down: Off, two blade terminals. Imprinted "On, Off"

★ Rapid ship item. BP Available in retail clamshell pack. ★ Minimum order quantity may apply.

## Wide Bezel

**56000-02 On-Off**

White actuator, bright bezel. Up: On, Down: Off, two screw terminals.

**57000-02 On-Off**

White actuator, bright bezel. Up: On, Down: Off, two blade terminals.

## SPST with Pilot Light



Narrow Bezel



Wide Bezel

## Narrow Bezel

**56300-01 On-Off**

White actuator, bright bezel. Red dependent pilot light. Up: On, Down: Off, three screw terminals. Diagram F.

**56300-11 On-Off**

White actuator, bright bezel. Amber dependent pilot light. Up: On, Down: Off, three screw terminals. Diagram F.

**57300-01 On-Off BP**

White actuator, bright bezel. Red dependent pilot light. Up: On, Down: Off, three blade terminals. Diagram F.

**57300-03 On-Off**

Black actuator, bright bezel. Red dependent pilot light. Up: On, Down: Off, three blade terminals. Diagram F.

**57300-11 On-Off, imprinted**

White actuator, black bezel. Red dependent pilot light. Up: On, Down: Off, three blade terminals. Imprinted "On, Off". Diagram G1.

## Wide Bezel

**56300-02 On-Off**

White actuator, bright bezel. Red independent pilot light. Up: On, Down: Off, three screw terminals. Diagram F.

**56300-08 On-Off**

White actuator, bright bezel. Green dependent pilot light. Up: On, Down: Off, three screw terminals. Diagram F.

**56300-09 On-Off**

White actuator, bright bezel. Amber dependent pilot light. Up: On, Down: Off, three screw terminals. Diagram F.

**56300-12\* On-Off**

Red actuator, bright bezel. Red dependent pilot light. Up: On, Down: Off, three screw terminals. Diagram F.



## 57300-02 On-Off

White actuator, bright bezel. Red dependent pilot light.  
Up: On, Down: Off, three blade terminals. Diagram F.

## 57300-10 On-Off

Black actuator, bright bezel. Red dependent pilot light.  
Up: On, Down: Off, three blade terminals. Diagram F.

## SPDT

### Narrow Bezel

#### 56002-01 On-On

White actuator, bright bezel. Up: On, Down: On, three screw terminals.

#### 56003-01 On-Off-On

White actuator, bright bezel. Up: On, Center: Off, Down: On, three screw terminals.

#### 57002-01\* On-On

White actuator, bright bezel. Up: On, Down: On, three blade terminals.

#### 57003-01 On-Off-On

White actuator, bright bezel. Up: On, Center: Off, Down: On, three blade terminals.

#### 57003-08 On-Off-On, imprinted

Black actuator, black bezel. Up: On, Center: Off, Down: On, three blade terminals. Imprinted "Hi, Off, Lo."

#### 57007-01 On-On-Off

White actuator, bright bezel. Up: On, Center: On, Down: Off, three blade terminals.

#### 57007-08 On-On-Off

Black actuator, black bezel. Up: On, Center: On, Down: Off, three blade terminals.

#### 57007-11 On-On-Off, imprinted

Black actuator, black bezel. Up: On, Center: On, Down: Off, three blade terminals. Imprinted "Off, Lo, High"

### Wide Bezel

#### 57003-02 On-Off-On

White actuator, bright bezel. Up: On, Center: Off, Down: On, three blade terminals.

## SPDT with Pilot Light

#### 57007-07 On-On-Off

Black actuator, bright nickel narrow bezel. Red dependent pilot light. Up: On, Center: On, Down: Off, four screw terminals.

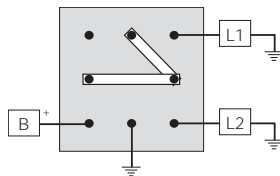

## DPDT

### Narrow Bezel

#### 56006-01 On-Off-On

White actuator, bright bezel. Up: On, Center: Off, Down: On, six screw terminals.

#### 56006-08 On- Off - On, imprinted

White actuator, black bezel. Up: On 2&3, 5&6, Center: Off, Down: On 1&2, 4&5, six screw terminals. Imprinted "Lights, Park" and with SAE headlight symbol.

#### 57006-01 On-Off-On

White actuator, bright bezel. Up: On, Center: Off, Down: On, six blade terminals.

#### 58007-04 On-On-On

Black actuator, black bezel. Up: B-F, Center: B-F, Down: B-A, four blade terminals.

#### 58007-07 On-On-Off, imprinted

White actuator, black bezel. Four blade terminals. Imprinted "Hi-Lo-Off". Up: B-H, Center: B-L, Down: B-P.

### Wide Bezel

#### 56006-02 On-Off-On

White actuator, bright bezel. Up: On, Center: Off, Down: On, six screw terminals.

#### 57006-02 On-Off-On

White actuator, bright bezel. Up: On, Center: Off, Down: On, six blade terminals.

## special use

Rocker switches in this group have special applications. All fit into a standard mounting hole.

#### Day signaling switches

56000-01, 56000-02, 57001-01, 57001-02, 57001-04

#### Two-speed field wound motor

56006-08

#### Two-speed heater

57001-07, 57007-02

#### Two-speed heater/defroster

57001-01, 57001-02

#### Two-speed windshield wiper

57007-04, 57007-07

Use with permanent magnet motor, without dynamic parking.

#### Headlight

57008-10

#### Ignition/Start

58022-03

## A4 NARROW BODY SWITCHES, 10A

Single Pole. Universal application, 10A at 12V DC single pole switches. Black plastic, snap-in mounting. Silver contacts, copper blade terminals. To fit panel hole .550" x 1.125" (14.0 x 28.6mm). Circuit diagrams, see Section A8.

**Angled actuators**

To fit panels .020" through .250" (.5mm to 6.4mm).

**54000-03\* SPST On-Off, Horizontal mount**  
Black actuator, Left: On, Right: Off, imprinted "On, Off". Two blade terminals.



**54001-02\* SPDT On-Off-On**  
White actuator, Up: On, Center: Off, Down: On. Three blade terminals.

**54003 SPST On-Off, lighted red** BP

Red lighted actuator, Up: On, Down: Off. Three blade terminals.



**54003-01 SPST On-Off, lighted amber**

Amber lighted actuator, Up: On, Down: Off, Three blade terminals.

**54003-02\* SPST On-Off, lighted green**  
Green lighted actuator, Up: On, Down: Off. Three blade terminals.

**54004\* SPST Off- Mom On**  
White actuator, Up: On, Down: Off. Two blade terminals.

**Curved Actuators**

Curved matte finish actuator. Fits panels .025" through .200" (.64 to 5.2mm). Three blade terminals.

**54007\* On-On Two color actuator**  
Rocker with black face, red edge that shows in the On position. Can also be used as an On-Off by isolating terminal 3.



**54008\* Off-On Orange lighted**  
Orange rocker, lighted in On position. Similar to 54012, but with Orange actuator

**54010 On-On** BP  
Black rocker. Can also be used as an On-Off by ignoring and isolating terminal 1 or 3.



**54012 Off-On Red lighted**  
Red rocker, lighted in On position.



## rocker switches

## A5 BRACKET-MOUNTING SWITCHES, 25A

Designed for use with customized faceplates. Heavy duty, 25A at 12V DC. Plated steel brackets fit panels .040" through .100" (1.0 to 2.5mm) thick. Bracket mounting holes are bossed and tapped to take 6-32 UNC-2A mounting screws or to clear .16" (4.1mm) diameter screws. Silver contacts, screw or blade terminals. White actuator except 58005. Switches with pilot lights have white actuators with red dependent pilot light.

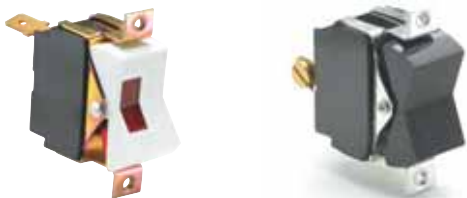
**SPST On-Off with Red Pilot Light**

**56300 Three screw terminals**  
Diagram F.

**57300 Three blade terminals**  
Diagram F.

**Without Pilot Light**

**57002\* SPDT On-On**  
Three blade terminals

**57008\* DPDT On-On-Off**  
Five blade terminals. Can be used as a Headlamp Switch: Off - On (battery, tail lights, park lamps) - On (battery, tail lights, headlamps).

**58005\* SPDT Off-On- Mom Off**  
Two screw terminals. Black actuator. Can be used as a signaling switch.

★ Rapid ship item. BP Available in retail clamshell pack. ★ Minimum order quantity may apply.

**A6 DUAL SWITCHES**

Two SP switches in one body. Universal application switches. Snap-in mounting. Phenolic housing and plastic actuator. Circuit diagrams, see Section A8.

## Narrow body, 25A

25A at 12V DC. Switch snaps into panel hole 1.45" x .83" (36.8 x 21.1mm), and fits panels .040" through .100" thick (1.0mm to 2.5mm).

Silver contacts, brass blade terminals. Black or white actuators, imprinted in contrasting black or white. Black narrow steel bezel 1.57" x .90" (39.0mm x 22.9mm) except where noted.



## SPST

### 58506-08 On-Off/Mom On-Off

Left switch, black: On-Off, imprinted "On, Off"  
Right switch, white : Mom On – Off, imprinted "On, Off"  
Four terminals.

### 58506-09\* Hi-Lo/On-Off

Left switch: white actuator imprinted "Hi, Lo". Right switch: black actuator imprinted "On, Off". Three terminals. The On-Off switch controls power to the Hi-Lo switch.

### 58506-11 On-Off/On-Off

Left switch: On-Off, imprinted "On, Off"  
Right switch: On-Off, imprinted "On, Off"  
Black actuators with white imprints. Four terminals.

## SPDT

### 58506-07 Hi-Off-Lo/Hi-Off-Lo

Left switch: On-Off-On, imprinted "Hi, Off, Lo"  
Right switch: On-Off-On, imprinted "Hi, Off, Lo"  
Black actuators with white imprints. Six terminals.

### 58506-15 Hi-Lo-Off/Hi-Lo-Off

Left switch: On-On-Off, imprinted "Hi, Lo, Off"  
Right switch: On-On-Off, imprinted "Hi, Lo, Off"  
Black actuators with white imprints. Six terminals. Plastic bezel.

## Wide-body, 10A

10A at 12V DC. Pair of switches snaps into panel hole 1.0"W (25.4mm) 1.125"H (28.6mm), and fits panels .030" through .250" thick (.76 to 6.35mm). Actuators are black, white, red or ivory rockers or paddles, with imprint in contrasting black or white. Black plastic bezel. Copper blade terminals.



### 54200-01\* Universal plug

Wide body, snap-in mount.

### 54201-01 Two black rockers, On-Off/On-Off

Left switch: On-Off, imprinted "On, Off"  
Right switch: On-Off, imprinted "On, Off"  
Four blade terminals.

### 54202-01 On-Mom Off/Off-Mom On

Left red paddle switch: On-Mom Off, imprinted "Off"  
Right ivory paddle switch: Off-Mom On, imprinted "On"  
Four blade terminals.

### 54203-01 On-Off/Mom On-Off

Left black paddle switch: On-Off, imprinted "On, Off"  
Right ivory paddle switch: Mom On-Off, imprinted "On"  
Four blade terminals.

### 54204-01 Hi-Off-Lo/Hi-Off-Lo

Left black rocker switch: On1-Off-On2, imprinted "Hi, Lo"  
Right black rocker switch: On1-Off-On2, imprinted "Hi, Lo"  
Six blade terminals.

### 54300-01 Red pilot & paddle, Mom On – Off

Left: Red independent pilot light  
Right ivory paddle switch: Mom On – Off, imprinted "On, Off"  
Four blade terminals.

### 54300-02\* Amber Pilot & paddle, On-Off

Left: Amber independent pilot light  
Right white paddle switch: On-Off  
Four blade terminals.

### 54300-03 Green Pilot & paddle, On-Off

Left: Green independent pilot light  
Right white paddle switch: On-Off  
Four blade terminals.

### 54400-01\* One rocker, On-Off

Left: Black panel  
Right black rocker switch: On-Off, imprinted "On, Off"  
Two blade terminals.

### 54401-01 One rocker, Mom On-Off

Left: Black panel  
Right black rocker switch: Mom On-Off, imprinted "On"  
Two blade terminals.

### 54401-02\* One paddle, Mom On-Off

Left: Black panel  
Right ivory paddle switch: Mom On-Off, imprinted "On"  
Two blade terminals.

### 54403-01 One rocker, On-Off-On

Left: Black panel  
Right black rocker switch: On1-Off-On2, imprinted "Hi, Lo"  
Three blade terminals.

### PL-300-AAC01\* Twin Pilot Lights only

Amber pilot lights with long-dimension imprint "Washer, Wiper" suitable for horizontal mounting. Four blade terminals.

ACCESSORIES **A8**

★ Rapid ship item. BB Available in retail clamshell pack. ✱ Minimum order quantity may apply.



**Bezels for mounting switches side by side**

For snap-in mounting of any regular size switch such as 56027 or 58328 series. Bezels can be arranged in a parallel array of any length. Bezels themselves can snap into a panel, or be mounted with the Bracket Mounting Kit. Height 1.90" (48.3mm). Two units are 2.37"W x 2.30"H (60.2 x 58.4mm). Mounting hole in panel should be 2.02"W x 1.90"H (51.3 x 48.3mm) for two bezels. Add 1.03"W (26.2mm) for each additional unit.

**82159-1 end bezel** BP**82159-2 center bezel**

Can be ganged, and used with end bezels.

**82159-3 independent bezel**

Fits panel opening  
1.900" x 0.984" (48.3 x 25.0mm)

**BP retail kits****82159-02BP** BP

Contains 2 end bezels, one center bezel, one plug.

**82159-03BP** BP

Contains 2 center bezels.

**Bracket Mounting Kit 87167-01BP** BP**87167-01BP**

For installing an array of switches onto a panel, when through-mounting isn't possible. Use in conjunction with 82159 bezels. Holds from 2 to 6 bezels (not included). Snap-together assembly; no special tools needed. Available only as a retail BP unit, which contains two bracket sections and brass stabilizing rods.

*Kit brackets engage with bezels. Brass rods snap into brackets to stabilize the unit.*

*Assembled kit mounts on top of or under the panel. Mounting holes .710" x .265" (18.0 x 6.7mm).*

**Panel Plugs**

**Black snap-in panel plug fits standard panel hole .83" x 1.45" (21.1 x 36.8mm).**

**87133-01 plug**

Face dimensions: 1.70" x 0.96"  
(24.4 x 43.2mm)

**98628 plug**

Face dimensions: 1.91" x 0.96"  
(24.4 x 48.8mm), designed for use with 82159 series.



★ Rapid ship item. BP Available in retail clamshell pack. ★ Minimum order quantity may apply.

## SP & DP Switches with 6 Terminal Locations

Diagrams represent both momentary contact or maintained contact switches.

### Switches without Pilot Lights

#### SPST Off-On

Two terminals.

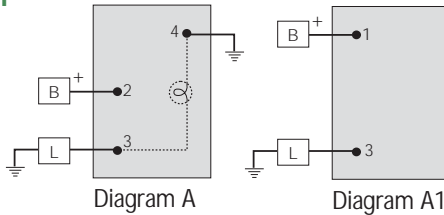

#### SPDT On-Off-On

Three terminals.

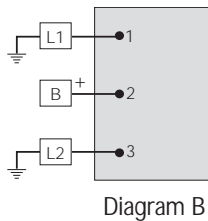

#### DPST Off-On

Four terminals.

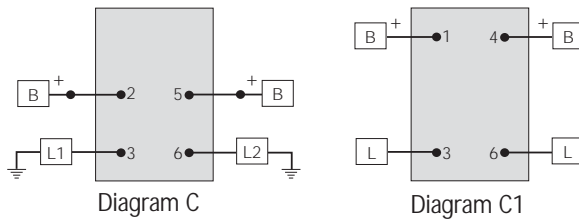

#### DPDT On-On

Six terminals.

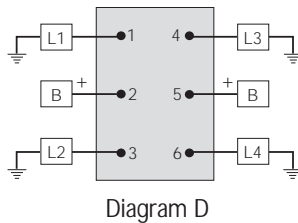

#### DPDT On-Off-On

Six terminals.

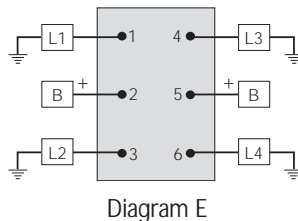

## Switches with One Pilot Light

#### SPST Off-On, dependent

Dependent illumination. Three terminals.

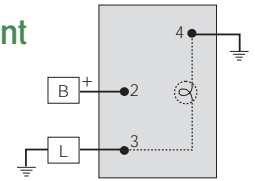

Diagram F

#### SPST Off-On, independent

Independent illumination. Four terminals. To convert an independent switch into dependent, connect a jumper wire from terminal 3 to terminal 6, and connect terminal 4 to ground.

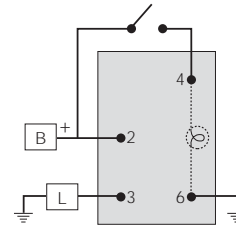

Diagram G1  
Independent illumination

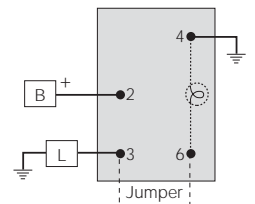

Diagram G2  
Independent illumination switch converted to dependent

## Switches with Two Pilot Lights

#### SPST Off-On, dependent & independent

Four terminals.

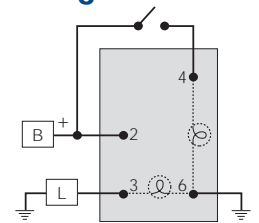

Diagram H

#### SPDT On-Off-On, or On-On, dependent

Four terminals.

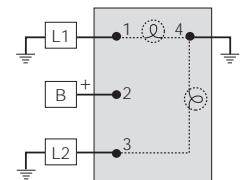

Diagram J

#### SPDT On-Off-On, or On-On, independent

Four terminals.

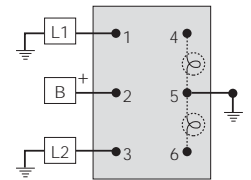

Diagram K



## SP&DP Switches with 8 Terminal Locations

Some switches have a maximum of eight possible locations for terminals. Switches of this type include M-58031 Series and 58326 Series in Section A1. Diagrams represent both momentary contact or maintained contact switches.

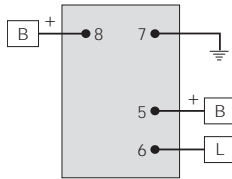

Diagram L

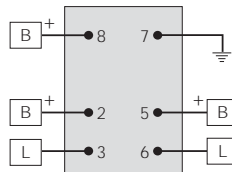

Diagram M

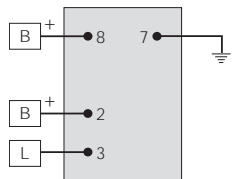

Diagram N

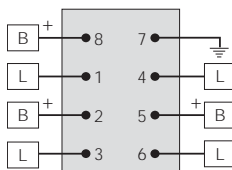

Diagram O

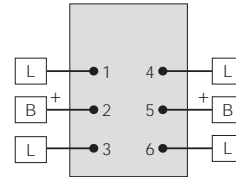

Diagram P

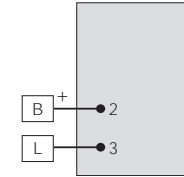

Diagram Q

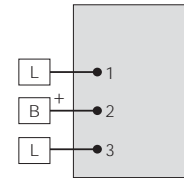

Diagram R

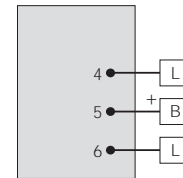

Diagram S

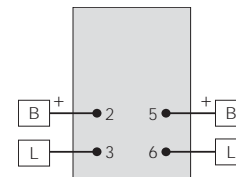

Diagram T

## How to Identify a 6-terminal switch

You can find out the type of rocker or toggle switch by a quick visual inspection.

Look at the back of the switch, where the terminals are. Notice that there are six possible terminal positions.

Toggle and rocker switches are designed so that each vertical set of terminals makes up one pole.

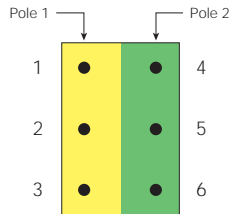

You can see immediately that a switch with three vertically-organized terminals must be a SPDT. Now check the actuator (rocker or toggle handle) to see if the switch is 2-position or 3-position.

If it only has two terminals, it must be a SPST, the simplest of all switch configurations. Notice that the two terminals are organized vertically (never side-by-side). Terminals can be located at 1 and 2, 1 and 3, or 2 and 3.

If it has terminals at 1, 3, 4 and 6, it must be a DPST. You can see that it utilizes the left side (pole 1) and right side (pole 2) of the switch — two poles (DP).

If it has six terminals, it's a DPDT. Check the actuator to see if the switch is 2-position or 3-position.

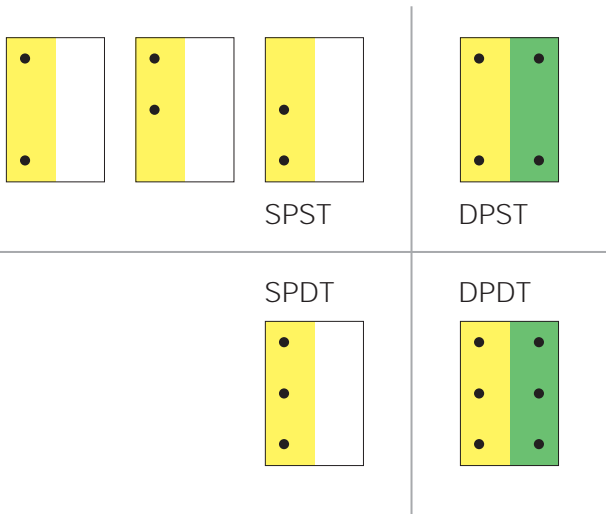

For explanation of SPST, DPST, SPDT, DPDT, see Section B10.

## rotary



Our new 72150 Series Rotary Switches have many of the electrical configurations that are available in rocker switches: SP/DP; single-, double-, triple-, and quadruple-throw; illuminated or not; momentary/maintained; imprinted or not; and with a choice of knob styles. Compact, with a durable Nylon 6/6 body. IP-53. 10A and 20A. Check them out in section N1.

## 3- and 4-way lighting

3-way lighting permits a light (or set of lights) to be controlled from either one of two switches usually mounted in different locations. Similarly, 4-way lighting enables control from three switch locations.

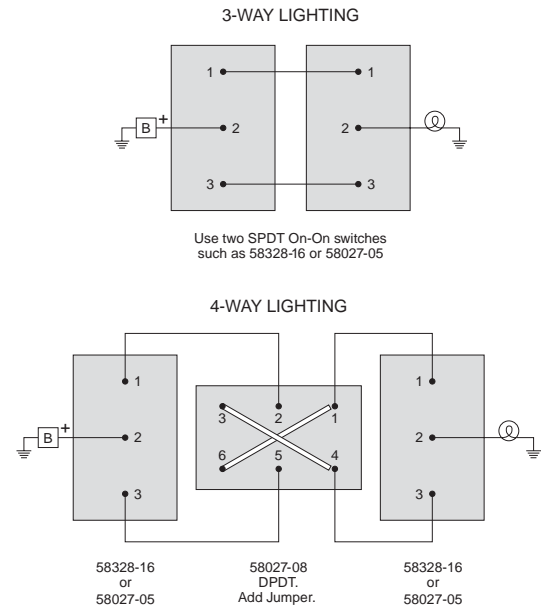



## SPST or SPDT?

Check out Section B10 for a graphic explanation of SPST SPDT DPST and DPDT.



## timers

New electronic timers for incandescent lights, motors and hundreds of other uses in controlling resistive or inductive loads. Rugged, weatherproof, vaporproof. Each timer has several timing patterns that can be set during installation. 48810 series also includes a stepping dimmer. Section K.

## TABLE OF CONTENTS

### F PUSH-PULL SWITCHES

|  |    |    |
|--|----|----|
| One circuit                                | F1 | 59 |
| Two circuit                                | F2 | 60 |
| Marine construction                        | F3 | 61 |
| Specialized switches                       | F4 | 62 |
| <i>Push-pull headlamp switches: see D5</i> |    |    |

### G MOMENTARY SWITCHES

|  |    |    |
|--|----|----|
| Heavy-duty push-button switches          | G1 | 63 |
| Medium-duty push-button switches         | G2 | 65 |
| Two circuit push-button switches         | G3 | 65 |
| Marine construction push-button switches | G4 | 66 |
| Specialized switches                     | G5 | 68 |
| Flexible caps for push-button switches   | G6 | 70 |
| Door switches                            | G7 | 71 |

### H SOLENOIDS & RELAYS

|                                      |    |    |
|--------------------------------------|----|----|
| Steel body & phenolic body solenoids | H1 | 75 |
| PVC-coated solenoids                 | H2 | 80 |
| Plastic body solenoids               | H3 | 81 |
| Electronic solenoids                 | H4 | 83 |
| Relays                               | H5 | 84 |
| Information                          | H6 | 88 |

### J BATTERY-RELATED PRODUCTS

|   |    |    |
|---|----|----|
| Battery selector & master disconnect switches | J1 | 89 |
| Master disconnect switches                    | J2 | 91 |
| Battery isolators                             | J3 | 93 |
| Accessories                                   | J4 | 95 |
| Information                                   | J5 | 97 |

### K ELECTRONIC DEVICES

|                                 |    |     |
|---------------------------------|----|-----|
| MiniBus™ digital databus system | K1 | 99  |
| Timer/dimmer modules            | K2 | 102 |
| Daytime running module          | K3 | 103 |
| Taillite converter module       | K4 | 104 |

### L STOPLAMP SWITCHES

|                     |    |     |
|---------------------|----|-----|
| Hydraulic switches  | L1 | 105 |
| Mechanical switches | L2 | 106 |

### M MONITORING DEVICES

|  |    |     |
|--|----|-----|
| Temperature switches                   | M1 | 107 |
| Temperature senders                    | M2 | 109 |
| Oil pressure switches                  | M3 | 109 |
| Oil pressure & electric choke switches | M4 | 111 |
| Vacuum switches                        | M5 | 112 |
| Air pressure switches                  | M6 | 113 |
| Fuel pump switches                     | M7 | 114 |

### N WARNING DEVICES, PILOT LIGHTS, PANEL LAMPS & SOCKETS

|                            |    |     |
|----------------------------|----|-----|
| Warning devices            | N1 | 115 |
| Heavy-duty pilot lights    | N2 | 117 |
| Marine pilot lights        | N3 | 120 |
| Hooded panel lamps         | N4 | 121 |
| Lamp sockets & accessories | N5 | 122 |

### P CIRCUIT PROTECTION & WIRING ACCESSORIES

|                              |    |     |
|------------------------------|----|-----|
| Circuit breakers             | P1 | 129 |
| Blocks & busbars             | P2 | 134 |
| Terminal blocks              | P3 | 136 |
| Fuses                        | P4 | 138 |
| Connectors & terminals       | P5 | 138 |
| Clamps, cleats, clips & ties | P6 | 143 |
| Accessories                  | P7 | 145 |

### Q ELECTRICAL CONNECTORS

|                               |    |     |
|-------------------------------|----|-----|
| Tractor-trailer connectors    | Q1 | 147 |
| 1- to 6-pole connectors       | Q2 | 151 |
| Socket & plug interiors       | Q3 | 153 |
| Automotive trailer connectors | Q4 | 154 |
| Farm equipment connectors     | Q5 | 156 |
| Accessories                   | Q6 | 157 |
| Information                   | Q7 | 159 |

### R SPECIAL PURPOSE SWITCHES

|   |    |     |
|---|----|-----|
| Mechanical neutral safety switches          | R1 | 161 |
| Neutral safety & back-up switches           | R2 | 163 |
| Back-up switches                            | R3 | 163 |
| Overdrive kickdown switches                 | R4 | 164 |
| Extra heavy-duty weather-resistant switches | R5 | 165 |
| Voltage reducers                            | R6 | 165 |
| Foot-operated turn switches                 | R7 | 166 |

### S KNOBS & NUTS

|                    |    |     |
|--------------------|----|-----|
| Standard knobs     | S1 | 167 |
| Facenuts & hexnuts | S2 | 169 |

### T DISPLAYS & LITERATURE

|                        |    |     |
|------------------------|----|-----|
| Clamshell packaging    | T1 | 171 |
| Merchandising displays | T2 | 172 |
| Display cards          | T3 | 173 |
| Merchandising aids     | T4 | 173 |
| Demonstration kits     | T5 | 174 |
| Literature             | T6 | 174 |

